

**Candidate Conditional Method ZZ:
Determination of Metal Concentration in CES' Xact
CEMS Stilling Chamber Using Filters and Solid
Sorbents with X-Ray Fluorescence Analysis**

Draft

June 23, 2005

**Prepared for
U. S. Environmental Protection Agency
Research Triangle Park, NC**

Prepared by:

Cooper Environmental Services, LLC
10180 SW Nimbus Blvd Suite J6
Portland, Oregon 97223

**Candidate Conditional Method ZZ:
Determination of Metal Concentration in CES' Xact
CEMS Stilling Chamber Using Filters and Solid
Sorbents with X-Ray Fluorescence Analysis**

Draft

June 23, 2005

**Prepared for
U. S. Environmental Protection Agency
Research Triangle Park, NC**

Prepared by:

**J.A. Cooper, B.E. Johnsen, K. Petterson,
C. A. Yanca, M. Nakanishi, D. Barth, S. Fry**

**Cooper Environmental Services, LLC
10180 SW Nimbus Blvd Suite J6
Portland, Oregon 97223**

**Candidate Conditional Method ZZ:
Determination of Metal Using Filters and Solid
Sorbents with X-Ray Fluorescence Analysis**

Prepared by: _____ Date: _____
Douglas C. Barth, Environmental Scientist

Prepared by: _____ Date: _____
Cay A. Yanca, Environmental Scientist

Prepared by: _____ Date: _____
Krag Petterson, Environmental Scientist

Reviewed by: _____ Date: _____
Bruce E. Johnsen, QA Manager

Approved by: _____ Date: _____
John A. Cooper, Director

Executive Summary

Eli Lilly and Company (Lilly) operates a waste incineration system located at the Tippecanoe Laboratories in Lafayette, Indiana. This incinerator system includes an Xact multi-metals continuous emissions monitoring system (Xact-CEMS, manufactured by Cooper Environmental Services, LLC) for demonstrating attainment with the Hazardous Waste Combustor MACT for semi-volatile metals, low-volatile metals, and mercury emissions. Lilly must conduct an initial performance evaluation test as well as quarterly and annual audits to assure the accuracy of the reported results from the CEMS. Lilly has proposed the use of a NIST-traceable reference aerosol generator for relative accuracy and linearity determinations. In addition, Lilly is also proposing the use of a new sampling and analysis reference method for metals to assure the accuracy of the spiked reference aerosol.

This appendix describes this new sampling and analysis method used in Method 301 tests described in the body of this report and proposed for the above noted initial performance evaluation test and annual audits of Lilly's Xact-CEMS. This new method is an X-ray Based Filter Method (XFM) that draws a representative sample of incinerator emissions from the Xact-CEMS stilling chamber through a series of reactive and non-reactive filters. The filter deposits are non-destructively analyzed by X-Ray Fluorescence (XRF) to determine metal concentrations in the filter deposits. Metal concentrations in the emissions are calculated by dividing the volume of sampled flue gas into the metal mass measured by XRF.

This method is applicable to the measurement of chromium (Cr), arsenic (As), cadmium (Cd), mercury (Hg), and lead (Pb)) in emissions from Lilly's hazardous waste incinerator. Although the XFM is optimized for these elements, it is applicable to other elements including: vanadium (V), manganese (Mn), iron (Fe), nickel (Ni), copper (Cu), zinc (Zn), silver (Ag), antimony (Sb), barium (Ba), thallium (Tl), tin (Sn), bismuth (Bi), cobalt (Co) and selenium (Se). The XFM can quantify flue gas concentrations ranging from less than 0.2 to over 2000 $\mu\text{g}/\text{dscm}$.

Table of Contents

Executive Summary	i
List of Symbols	iv
List of Figures	v
1.0 Method Summary.....	1
1.1 Principle	1
1.2 Applicability	1
1.3 Cautions	1
2.0 Definitions and Abbreviations	2
3.0 Safety	2
4.0 Apparatus	2
4.1 Overview.....	2
4.2 Extraction assembly	3
4.3 Extraction flow control module	3
4.4 Dilution flow control module.....	3
4.5 Sample filter holder assembly.....	3
4.6 Sample flow control module.....	3
5.0 Reagents and Standards	4
5.1 Filter cassette	4
5.2 Desiccant.....	5
5.3 XRF standards.....	5
6.0 Pre-sample Preparation	5
6.1 Test preparation	5
6.2 Pre-test laboratory preparation.....	5
6.3 Sample train preparation	5
7.0 Sample Collection.....	6
7.1 Filter holder leak check.....	6
7.2 Setting total flow needle valve.....	6
7.3 Filter temperature range.....	6
7.4 Evaluation of sample meter accuracy	6
7.5 Filter cassette installation.....	7
7.6 Sampling	7

7.7	Sample recovery.....	7
7.8	Post-test Checks.....	7
8.0	Sample Recovery, Handling and Preservation.....	7
9.0	Elemental Analysis.....	8
9.1	Analysis.....	8
9.2	Calibration.....	8
10.0	Calculations.....	8
10.1	Flow Correction Factor.....	8
10.2	XFM Measured Aerosol Concentration.....	9
11.0	Quality Control.....	9
11.1	Sampling.....	9
11.2	Analysis.....	9
12.0	Method Performance.....	9
12.1	Range.....	10
12.2	Detection Limits.....	10
13.0	Pollution Prevention.....	10
14.0	Waste Management.....	10
15.0	Tables and Figures.....	10
16.0	References.....	17

List of Symbols

- C_i^{e-XFM} = Concentration of the i^{th} analyte in the emission measured by the XFM
- M_i^{PTFE} = XRF-determined mass of the i^{th} analyte on the PTFE filter
- M_i^{REO-7} = XRF-determined mass of the i^{th} analyte on the reactive filter (REO-7)
- V_t^{XFM} = Total volume (emission plus dilution) sampled by the XFM
- V_d^{XFM} = Volume of dilution air drawn through filters of the XFM

List of Figures

Figure 1 Flow diagram of the sampling train used in Phase I and II XFM validation tests. ..	12
Figure 2: Sample train components used in Phase I and II XFM validation tests.	13
Figure 3: Exploded view of the extraction assembly.	14
Figure 4: Schematic diagram of the extraction flow control module.	14
Figure 5: Schematic diagram of the dilution flow control module.	15
Figure 6: Exploded and assembled view of the sample filter holder.	15
Figure 7: Schematic diagram of the sampling flow control module.	16

1.0 Method Summary

1.1 Principle

A representative sample of flue gas is drawn from an Xact CEMS¹ stilling chamber through a cassette containing PTFE and reactive filters. The elements in particulate matter (PM) are deposited on the PTFE filter while the vapor phase elements are trapped on the reactive filter. The elemental mass in each filter deposit is determined by X-Ray Fluorescence (XRF) using EPA IO Compendium Method 3.3². Metal concentrations in stilling chamber flue gas are calculated by dividing the volume of the flue gas sampled into the elemental mass measured by XRF.

1.2 Applicability

This method is applicable to the measurement of metal aerosol concentrations in the Xact-CEMS stilling chamber.

1.2.1 Analytes

This method is applicable to Antimony (Sb), Arsenic (As), Cadmium (Cd), Chromium (Cr), Cobalt (Co), Lead (Pb), Manganese (Mn), Mercury (Hg), Nickel (Ni), and Selenium (Se) and is generally appropriate for elements with atomic number from about 13 (Al) through 92 (U) as noted in IO Compendium Method 3.3². This sampling method is also applicable to Beryllium (Be), if measured with IO Compendium Method 3.4³ after non-destructive XRF analysis.

1.2.2 Interferences

There are no known flue gas components in their typical concentrations that interfere with sample collection. Elemental interferences are addressed in IO Compendium Method 3.3².

1.2.3 Concentration Range

The applicable concentration range of this method is from less than 0.2 µg/dscm (Table 1) to over 2000 µg/dscm.

1.3 Cautions

This method does not include all of the specifications essential to its performance. Some material is incorporated by reference. Therefore, to obtain reliable results, persons using this method should have a thorough knowledge of at least EPA Methods 1⁴ and 2⁵ and EPA IO Compendium Method 3.3².

2.0 Definitions and Abbreviations

Accuracy: The agreement between an experimentally determined value and the true value.

Aerosol: A suspension of solids and/or liquids in a gas.

Analyte: A species (element, metal, etc.) of interest in an analytical method.

Detection Limit: The lowest concentration of an element that can reliably be distinguished from a zero concentration.

Interferant: A substance other than the analyte that causes an undesired positive or negative output.

NIST: U. S. Department of Commerce, National Institute of Standards and Technology⁶, Gaithersburg, MD 20899

Uncertainty: An indication of the degree of reliability of a value usually expressed statistically (probability) as a multiple of the standard deviation of a set of measurements. Unless otherwise stated, the uncertainty in a mean value of a series of measurements will be the standard deviation. In the case of values based on calculations, the uncertainty in the value is equal to the propagated uncertainty based on the uncertainties in the parameters used in the calculations.

3.0 Safety

This method involves the measurement of hazardous materials and the operation of equipment with the potential to cause bodily harm. This test method does not address appropriate safety and health practices associated with its use. It is the responsibility of the user of this test method to establish appropriate safety and health plans prior to performing this method.

4.0 Apparatus

4.1 Overview

The sample collection apparatus used for this method is described in the following subsection. The equipment required for the XRF analysis of the filters is specified in IO Compendium Method 3.3².

The sample collection equipment consists of the following five major components (Figure 1 and Figure 2):

- Extraction assembly
- Extraction flow control module
- Dilution flow control module

- Sample filter holder assembly
- Sample flow control module

4.2 Extraction assembly

The extraction assembly (Figure 3) is used to draw flue gas from the Xact stilling chamber through the extraction plate via the extraction flow control module (Subsection 4.3). A sub-sample of this flow is drawn from the extraction assembly through the probe plate by the sample flow control module (Subsection 4.6). A dilution plate is directly downstream of the probe plate and the stack gas sample is diluted and mixed with CDA prior to passing through the filter holder (Subsection 4.5).

4.3 Extraction flow control module

This module (Figure 4) uses an eductor to draw flue gas through the extraction assembly. The flow rate is controlled by a standard industrial pressure regulator with gauge and powered by compressed CDA. The flue gas is then filtered, dried, and denuded of corrosive material before it is exhausted back into the stilling chamber.

4.4 Dilution flow control module

The dilution flow control module (Figure 5) dries, cleans, controls, measures and totalizes the flow of dilution gas. Clean, dry, compressed air is further dried in this module before it is used to dilute the sample flue gas. The dilution gas flow and pressure are controlled with a regulator, pressure gauge and a needle valve. The flow rate is measured by a mass flow meter (D-MFM). A dilution flow integrator (DFI) totalizes the output from the D-MFM and reports the total volume of dilution air that has been added to the gas stream.

4.5 Sample filter holder assembly

The sample filter holder assembly (Figure 6) is used to trap particulate and vapor phase metals in the emission sample. Two filters are contained within a 37 mm polypropylene filter cassette inside the filter holder. The first filter is non-reactive PTFE filter and is used to trap particulate phase metals. The second filter is a reactive filter that collects vapor phase metals⁶. Downstream of the filters, a thermocouple provides temperature information to ensure that the filters remain within their optimal temperature range of 100° to 180°F. This assembly includes a quick disconnect for use with leak checks.

4.6 Sample flow control module

This module (Figure 7) controls the flow rate of diluted flue gas through the filters and measures the total sample flow. After passing through the filters, the gas is dried and corrosive species removed prior to determining the dry gas flow rate with a mass flow meter.

4.6.1 Desiccant Dryer

Downstream of the filter holder, a desiccant dryer is used to remove moisture prior to flow measurement. The XFM reports concentrations as mass per dry standard volume.

4.6.2 Corrosive Trap

Following the desiccant dryer, the diluted flue gas is drawn through a corrosive trap designed to remove corrosive flue gas species.

4.6.3 Total Flow MFM

The total mass flow meter (T-MFM) measures the total flow (1-2 dslpm) passing through the filters. This flow meter produces a 4-20 mA signal which is read and totalized by the total flow integrator (TFI). The total sample volume is calculated by subtracting the dilution volume from the total volume.

4.6.4 Vacuum Gauge

A vacuum gauge capable of reporting a vacuum between 0 and 29 in. Hg is used to ensure that a vacuum can be maintained in the XFM during leak checks. Monitoring of this gauge during sample collection provides continuing quality assurance of vacuum and filter integrity.

4.6.5 Needle Valve

A needle valve is used for fine control of the total flow rate during sampling. Generally, little adjustment of the needle valve is necessary after the initial adjustment to achieve the desired flow.

4.6.6 Two-way Valve

A manual two-way valve located just upstream of the vacuum pump is used to perform pre-sample leak checks. This valve can also be used as a course flow adjustment to regulate the total flow passing through the filter.

4.6.7 Vacuum Pump

A diaphragm vacuum pump is used to pull the emission and dilution gas sample through the filters. The filtered, cleaned and dried gas sample that passes through the pump is then returned to the stack.

5.0 Materials, Reagents and Standards

5.1 Filter cassette

One 37 mm diameter PTFE (Teflo⁷ or equivalent) and one 37 mm diameter REO-7⁸ filter for trapping particulate and vapor phase metals are required by this method for each run. The two filters should be pre-loaded into a labeled 37 mm diameter filter cassette in a clean, dry environment prior to the test run. Filter cassettes should be stored in a labeled Petri dish before and after sampling.

5.2 *Desiccant*

The XFM sample dryer requires an indicating desiccant (Agilent Silica Gel Grade 40⁹ or equivalent). A single dryer cartridge may be used for multiple runs as long as the desiccant remains below the removal capacity specified by the manufacturer.

5.3 *XRF standards*

XRF thin-film standards for metals of interest should be used to calibrate the XRF prior to operation according to IO Method 3.3². Standards should have a known mass per area ($\mu\text{g}/\text{cm}^2$) to within five percent.

6.0 **Pre-sample Preparation**

6.1 *Test preparation*

The complexity of this method is such that, in order to obtain reliable results, both testers and analysts must be trained and experienced with the test procedures, including source sampling; sample handling; safety equipment and procedures; analytical calculations; reporting; and the specific procedural descriptions throughout this method.

6.2 *Pre-test laboratory preparation*

Check filters visually against light for irregularities, flaws, or pinhole leaks. Prior to shipping, load one upstream PTFE filter and one downstream REO-7 filter for each run into a labeled filter cassette and place into a labeled Petri dish for transport. Provide one loaded filter cassette for a QA field blank.

Before each series of tests, the flow rates for both the total flow and the dilution flow integrators should be checked against a certified NIST-traceable meter. The flow reading on the integrator should be within five percent of the reading on the certified NIST traceable meter.

6.3 *Sample train preparation*

6.3.1 *Sample flow rates and sample time*

Sample and dilution flow rates may range from 0.5 to 1.0 slpm, but should not vary by more than ten percent during a test run. Sample time should be between 10 and 50 minutes.

6.3.2 *Extraction assembly and dilution flow module leak checks and sampling rate*

The extraction and dilution assembly must be leak checked prior to mounting on the Xact-CEMS sampling port. To perform this leak check, cap the port adaptor with a rubber stopper and insert the extraction assembly plug (Figure 3). Connect the dilution line for compressed air to the dilution plate port and cap the 3/8" extraction plate port. Pressurize the assembly to 5 psi and close the dilution flow shut-off valve. The gauge reading should be stable ($\pm 5\%$) for 30 seconds. Following a successful leak check, remove the stopper and 3/8" cap nut. The

extraction assembly and dilution line can now be mounted on the Xact-CEMS stilling chamber sampling port.

The flow from the Xact-CEMS stilling chamber through the extraction assembly should be maintained in the range of 15-30 slpm. The XFM extraction assembly temperature should be above 220°F.

7.0 Sample Collection

7.1 Filter holder leak check

A filter holder leak check must be performed after the filter cassette has been loaded in the filter holder. To perform this check, seal the filter holder assembly with the filter holder cap nut (Figure 6), turn on the pump and allow the vacuum to reach 15 in Hg. Close the sample flow shut-off valve (Figure 4), turn off the pump, and record the initial pressure and the pressure after 30 seconds. To pass this check, the change in pressure must be less than five percent of the initial pressure. Disengage the sampling train quick disconnect to release the vacuum (Figure 6).

7.2 Setting total flow needle valve

The total flow rate (sample and dilution) that passes through the filter is controlled by a needle valve (Figure 7). To determine the needle valve's initial set point, place a loaded blank filter cassette into the filter holder and leak check as stated above. Install the filter holder onto the extraction assembly, which is at operating conditions. Open the sample shut-off valve fully and turn on the sample pump. Set the needle valve so that the T-MFM reads the desired sampling rate. Then close the shut-off valve and turn off the pump. For each sample run, the shut-off valve will be used to start the sampling flow while the needle valve should be used to make minor flow adjustments as needed after the sampling has started.

7.3 Filter temperature range

Since filter holder temperature can increase at the start of the run, it is recommended that the filter temperature be maintained at about 140°F before sampling begins and should not exceed 180°F at any time during sampling.

7.4 Evaluation of sample meter accuracy

Prior to the first run, the accuracy of the T-MFM should be checked using a NIST-traceable flow meter and stack gas. Mount the filter holder containing a filter cassette, attach the NIST-traceable flow meter to the sample flow outlet, turn on the sample pump, open the ball valve and allow stack gas to pass through the filter, T-MFM and NIST-traceable meter. Compare the T-MFM value to the NIST flow meter. The values should be within five percent. If they differ by more than five percent, a correction should be made using the formula in Section 10.1. Disconnect the NIST flowmeter and place a new filter cassette in the filter holder before starting the first sample run.

7.5 Filter cassette installation

For each run, fill out the XFM Field Data Sheet (Table 2), identifying the date, run, operator, XFM module I.D. no., and filter I.D. numbers, and date, time, and other data for the test run. Insert filter cassette into the filter holder and conduct a filter holder leak check.

7.6 Sampling

Prior to sampling, zero the total flow integrator. At a time concurrent with the start of an Xact sample run, start the XFM sample pump, open the ball valve, and record the initial dilution volume and start time. Sample for 10 to 50 minutes, recording temperatures, pressures, and volumes every five minutes. Use the dilution and total flow needle valves to ensure that the flow rates are constant and monitor the filter temperature to ensure that it remains below 180°F. When sampling is complete, close the shut-off valve, turn off the vacuum pump and immediately record the dilution volume, total volume and sample run end time on the worksheet.

Note: It is recommended that a post-test sample flow leak check not be conducted since the test may compromise the sample collected on the filter.

7.7 Sample recovery

After removing the filter holder from the extraction assembly, disassemble the filter holder and remove the filter cassette. Return the filter cassette with filters to the original Petri dish, and seal the dish with tape. Do not separate the PTFE and reactive filters from the filter cassette. Document any abnormalities on the filter and ship to the appropriate laboratory for analysis.

7.8 Post-test Checks

The following checks need to be made after the last test run is complete and before packing the equipment for return shipment.

7.8.1 Flow Agreement Check

Calibration of the dilution and total mass flow meters should be checked following the same procedure as in subsection 7.3.

7.8.2 Extraction assembly and dilution flow module assembly leak checks

The extraction assembly and dilution flow module leak check should be performed according to the same procedures found in subsection 6.3.

8.0 Sample Recovery, Handling and Preservation

Open the filter cassettes in a clean work area and note the condition of the filters. Carefully remove the filters from the filter cassettes and place each filter sampling side up in a separately labeled Petri slide. Filters should be stored in archives at temperatures less than

5°C. The filters remain in archives until they are scheduled for analysis. Following XRF analysis the filters may be returned to storage and analyzed again at a later date or they may be submitted for analysis for beryllium (Be) according to the procedures outlined in Compendium Method IO 3.4³.

9.0 Elemental Analysis

9.1 Analysis

The analytical procedures are similar to those in Compendium Method IO-3.3² “Standard Operating Procedure for the X-Ray Fluorescence Analysis of PM_{2.5} Deposits on Teflon Filters”. These methods address the application of energy dispersive X-ray fluorescence spectrometry (EDXRF) to the determination of elemental composition of particulate matter deposits on filters.

9.2 Calibration

The X-ray fluorescence analyzer is calibrated using thin film standards of a known concentration (usually in µg/cm²). Potential manufacturers of thin film standards are listed in Compendium Method IO-3.3² For each element, a calibration sensitivity factor is obtained by dividing the x-ray intensity (counts/sec./mA) by the concentration of the standard (µg/cm²).

Generally these standards are larger than the area of the exciting X-ray beam while the XFM deposition spot is smaller than the beam. For this reason, a thin film to spot ratio must be established during calibration. This thin film to spot ratio is determined empirically by using a single standard of a known concentration with the same area as the XFM deposition spot. This ratio is determined for each analysis condition and is applied to each element in that analysis condition.

10.0 Calculations

10.1 Flow Correction Factor

Before each series of tests, the flow rates for both the total integration and the dilution integrator should be checked against a certified NIST-traceable meter. The flow reading on the integrator (F_{FI}) should be within five percent of the reading on the certified NIST traceable meter (F_{NIST}) and recorded in the field notes. If they are not within five percent, the noted difference must be used to calculate a correction factor (CF_F) as defined below:

$$CF_F = \frac{F_{NIST}}{F_{FI}} \quad \text{Equation 1}$$

10.2 XFM Measured Aerosol Concentration

The XFM-determined concentration of the five MACT metals in the sampled flue gas is based on a measurement of the metal mass deposited on the XFM filters and the sample volume that passed through the filters. The XRF analysis results yield the metal masses in µg of each reported metal per filter. The total sample volume is determined by subtracting the dilution volume from the total volume. These parameters are used in Equation 2 to calculate the concentration of each analyte as shown below:

$$C_i^{e-XFM} = \frac{M_i^{PTFE} + M_i^{REO-7}}{V_t^{XFM} - V_d^{XFM}} \quad \text{Equation 2}$$

Where:

C_i^{e-XFM} = Concentration of the i^{th} analyte in the emission measured by the XFM (µg/dscm)

M_i^{PTFE} = XRF-determined mass of the i^{th} analyte on the PTFE filter (µg)

M_i^{REO-7} = XRF-determined mass of the i^{th} analyte on the reactive filter (REO-7; µg)

V_t^{XFM} = Total volume (emission plus dilution) sampled by the XFM (dscm)

V_d^{XFM} = Volume of dilution air drawn through filters of the XFM (dscm)

11.0 Quality Control

11.1 Sampling

The sampling quality control requirements include performing all necessary leak checks and checking the flow readings against a NIST traceable standard. The following is a list of all necessary sampling quality control procedures.

1. Extraction assembly leak check (See subsection 6.3)
2. Dilution assembly leak check (See subsection 6.3)
3. Sample filter holder assembly leak check (See subsection 7.1)
4. Flow calibration check (See subsection 7.3)

11.2 Analysis

Quality control and assurance procedures are performed in accordance with Compendium IO-3.3².

12.0 Method Performance

12.1 Range

The applicable concentration range is from less than 0.2 µg/dscm to over 2000 µg/dscm.

12.2 Detection Limits

The interference free detection limits at the 95% confidence level^{Error! Bookmark not defined.} are given in Table 1 assuming a sampling rate of 0.7 slpm and a sampling time of 30 minutes.

Actual method detection limits are based on actual source sampling and analytical results. If required, the method in-stack detection limits can be improved over those shown in Table 1 by either increasing the stack gas volume sampled, the sample time, or XRF analytical time. Increasing the volume sampled by a factor of two results in a corresponding two fold increase in the detection limits. XRF detection limits improve with the square root of the analysis time.

13.0 Pollution Prevention

The exhaust from the sample flow module is vented to the atmosphere after passing through the sampling filters, dryer and corrosive gas denuder. There are no reagent solutions generated in this method.

14.0 Waste Management

Sample filters are archived for one year and then disposed as non-hazardous waste.

15.0 Tables and Figures

Table 1: XFM Detection Limits^{Error! Bookmark not defined.}

Element	Symbol	Analytical (ng/spot)	In-stack (µg/dscm)
Antimony	Sb	23.0	2.20
Arsenic	As	1.3	0.12
Cadmium	Cd	13.0	1.2
Chromium	Cr	1.3	0.12
Cobalt	Co	1.3	0.12
Lead	Pb	1.7	0.16
Manganese	Mn	1.3	0.12
Mercury	Hg	2.1	0.20
Nickel	Ni	0.8	0.08
Selenium	Se	1.3	0.12
Silver	Ag	8.4	0.80

Table 2. XFM Field Data Sheet
XFM FIELD DATA SHEET

Date	
Run No.	
Operator(s):	
XFM Module No.	
PTFE Filter No.	
REO-7 Filter No.	
Pre-test Filter Eval.	
Leak Check	
Post-test Filter Ev.	

Start Time	
Stop Time	
A) Init. Tot. Vol. (Dil. Air)	
B) Final Tot. Vol. (Dil. Air)	
C) Dil. Air for Test (B-A)	
D) Initial Total Vol.	
E) Final Total Vol.	
F) Total Test Vol. (E-D)	
G) Net Sample Vol. (F-C)	

Time	Ext Temp.	Filter Temp.	Samp. Flow	Dil. Flow	Flow Vac.	Dil. Flow Pres.	Ext. Flow Vac.	Ext. Flow Pres.	Drier Pres.
	°F	°F	liters	liters	in. Hg	in. Hg	in. Hg	in. Hg	in. Hg

NOTES:

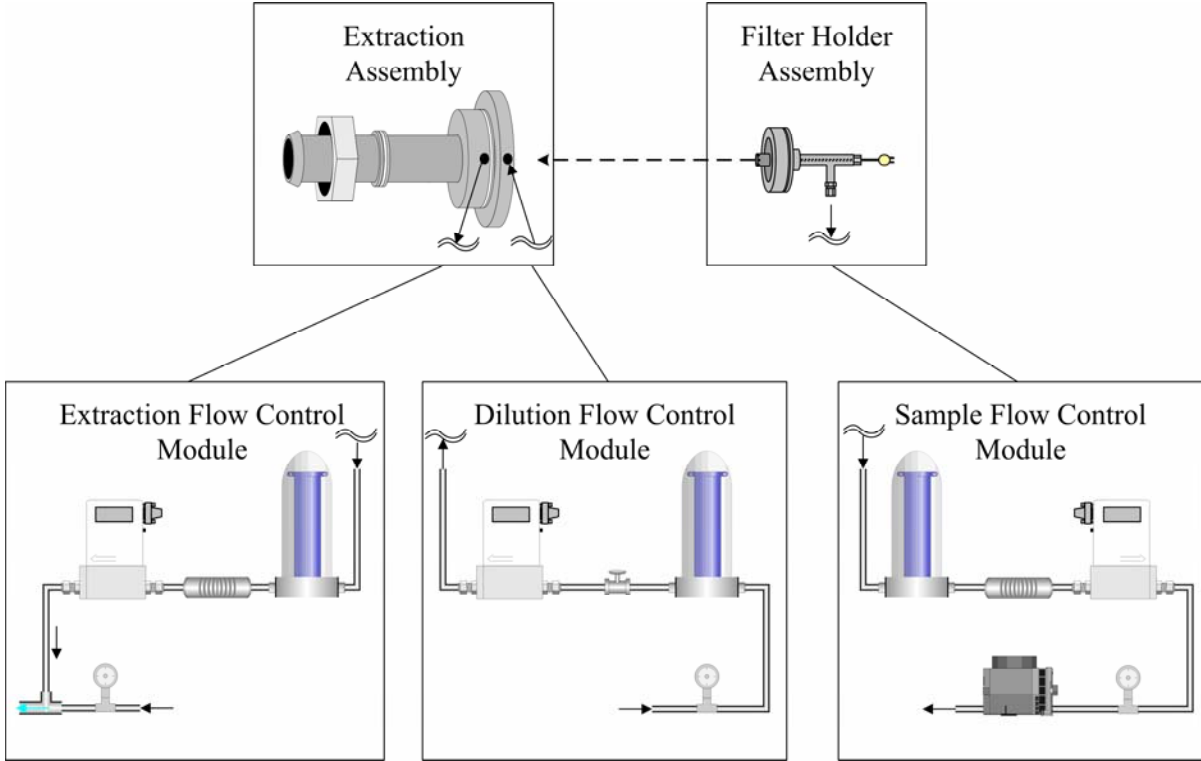

Figure 1 Flow diagram of the sampling train used in Phase I and II XFM validation tests.

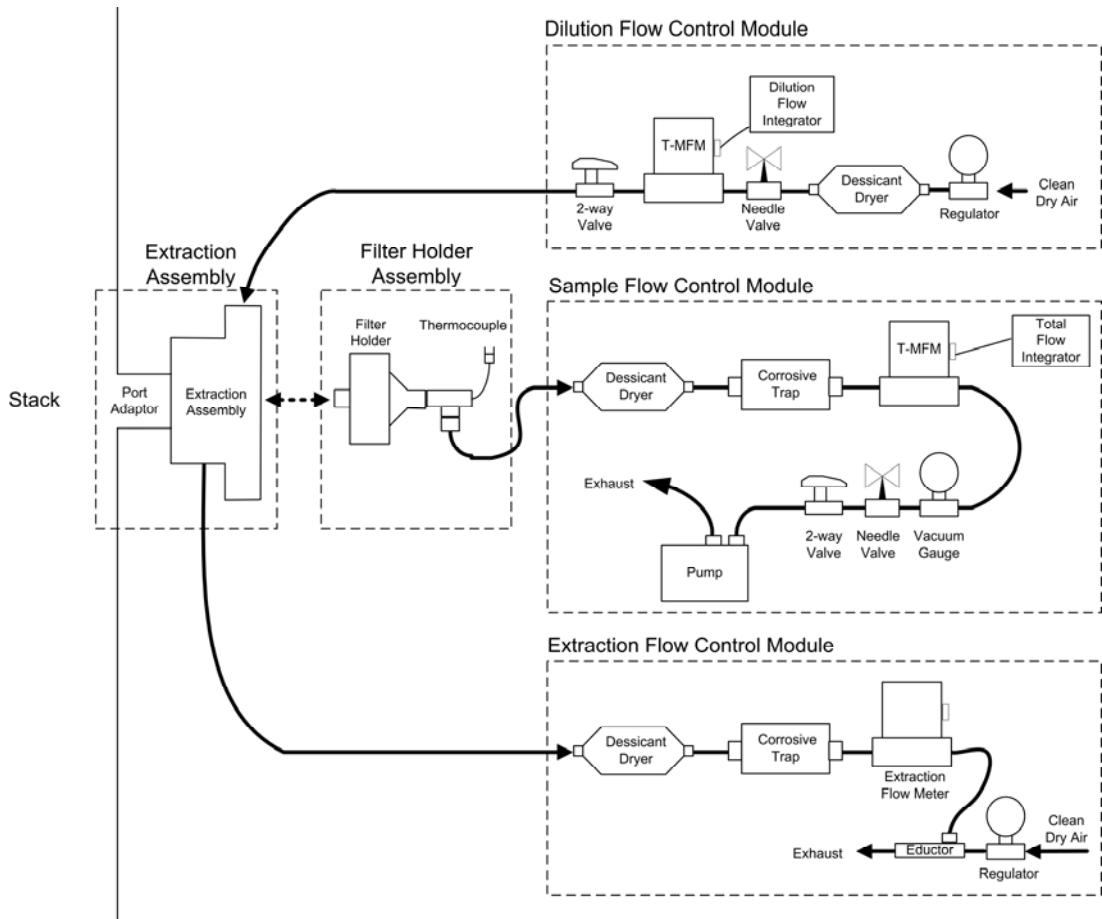

Figure 2: Sample train components used in Phase I and II XFM validation tests.

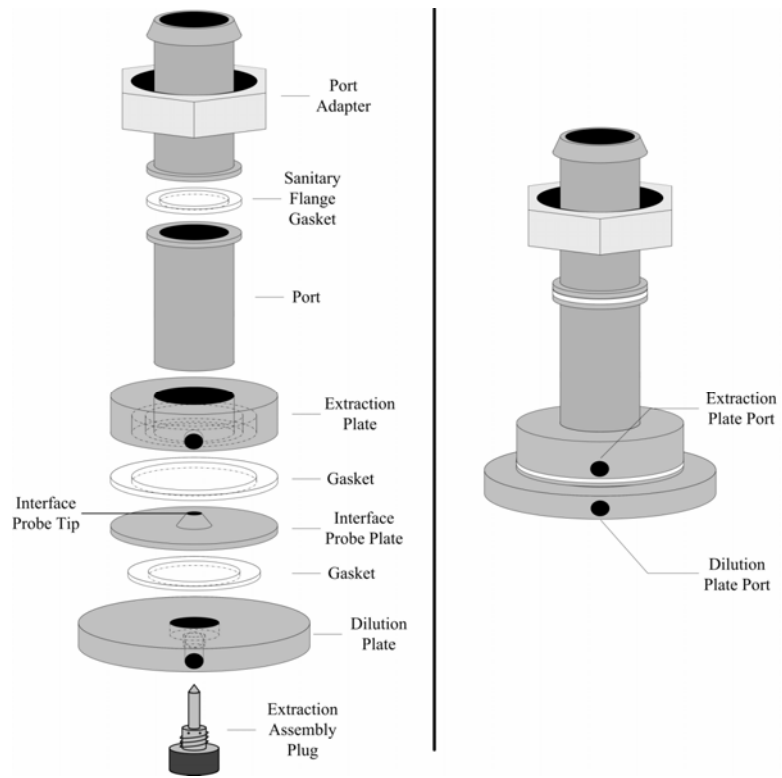

Figure 3: Exploded view of the extraction assembly.

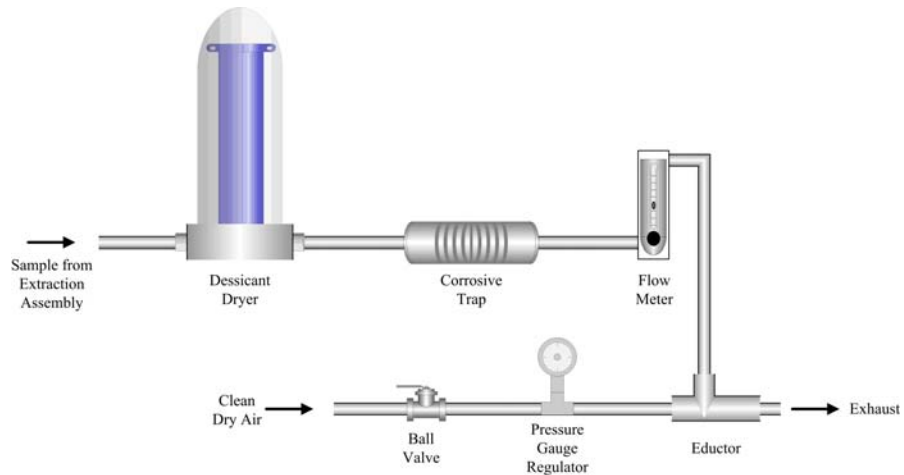

Figure 4: Schematic diagram of the extraction flow control module.

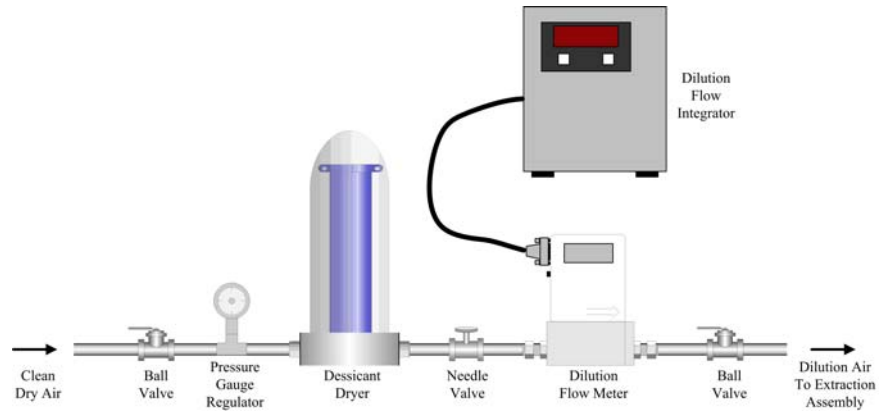

Figure 5: Schematic diagram of the dilution flow control module.

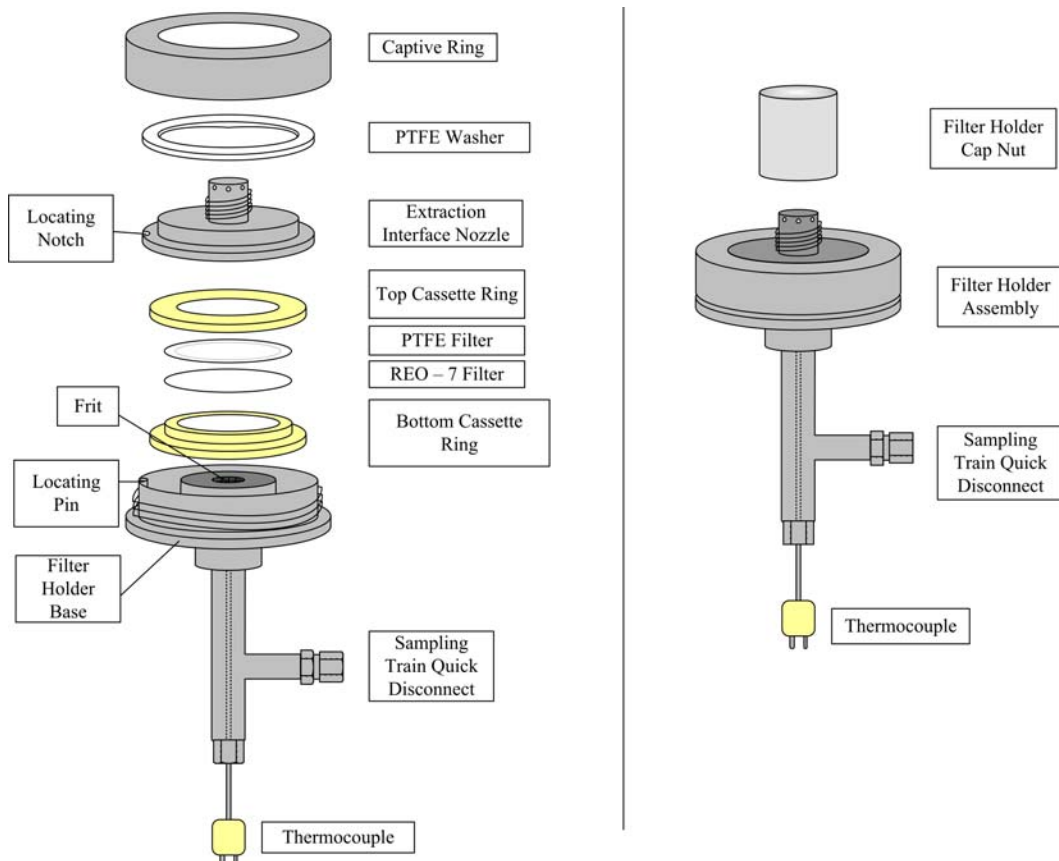

Figure 6: Exploded and assembled view of the sample filter holder.

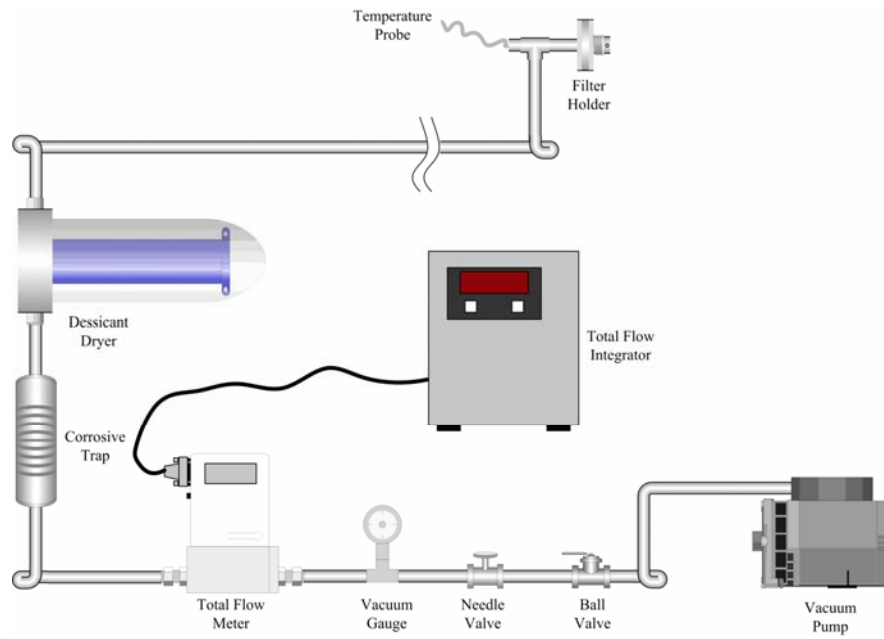

Figure 7: Schematic diagram of the sampling flow control module.

16.0 References

- 1 Xact-CEMS. X-ray Based Continuous Emissions Monitoring System for Multi-Metals. Manufactured by Cooper Environmental Services, LLC. Portland, OR.
www.cooperenvironmental.com.
- 2 EPA Compendium of Methods for the Determination of Inorganic Compounds in Ambient Air. June, 1999. Compendium Method IO-3.3 Determination of Metals in Ambient Particulate Matter Using X-Ray Fluorescence (XRF) Spectroscopy. EPA/625/R-96/010a.
- 3 EPA Compendium of Methods for the Determination of Inorganic Compounds in Ambient Air. June, 1999. Compendium Method IO-3.4 Determination of Metals in Ambient Particulate Matter Using Inductively Coupled Plasma (ICP) Spectroscopy. EPA/625/R-96/010a.
- 4 EPA Method 1. Sample and Velocity Traverses for Stationary Sources.
- 5 EPA Method 2. Determination of Stack Velocity and Volumetric Flow Rate (Type S Pitot Tube).
- 6 NIST. National Institute of Standards and Technology. Gaithersburg, Md.
www.NIST.gov.
- 7 Teflo Filter. 2003. Manufactured by Pall Life Sciences Laboratory Filtration and Separation Catalog. pp.30-31.
- 8 REO-7. Manufactured by Cooper Environmental Services, LLC. Portland, OR.
www.cooperenvironmental.com.
- 9 Agilent Dryer. Manufactured by Agilent technologie. Found on the web at:
<http://www.chem.agilent.com>