



Economic Impact and Small Business Analysis for Petroleum Refinery NESHAP — Heat Exchange Systems

**Economic Impact and Small Business Analysis for Petroleum Refinery NESHAP –
Heat Exchange Systems**

U.S. Environmental Protection Agency
Office of Air Quality Planning and Standards
Health and Environmental Impacts Division
Air Benefits and Costs Group
Research Triangle Park, NC

Economic Impact and Small Business Analysis for Petroleum Refinery NESHAP – Heat Exchanger Systems

Background

This final action amends the national emission standards for petroleum refineries to add maximum achievable control technology standards for heat exchange systems. This action also amends the general provisions cross reference table, clarifies dates, and corrects section references.

In developing this rule, we first issued an advanced notice of proposed rulemaking (ANPR) on March 29, 2007. The purpose of the ANPR, which covered the sources subject to the Refinery MACT 1 rule and other source categories, was to solicit additional emissions data and any corrections to the data we already had. We issued an initial proposed rule for the petroleum refineries subject to the Refinery MACT 1 on September 4, 2007, and held a public hearing in Houston, Texas on November 27, 2007. In response to public comments on the initial proposal, we collected additional information and revised our impact analyses. Based on the results of these additional analyses, we issued a supplemental proposal on November 10, 2008, that established a new MACT floor for heat exchange systems and proposed an additional option under the residual risk and technology review (RTR) for storage vessels. A public hearing for the supplemental proposal was held in Research Triangle Park, North Carolina on November 25, 2008. We are now taking final action to perform the RTR of the Refinery MACT 1 standard.

As explained later in this report, this final rule includes a MACT standard for heat exchanger systems at petroleum refineries.

This report presents the economic and small business impacts associated with this final rule. The report contains a profile of the affected industry, background information on the requirements included in the final rule, information on the costs of the final rule, and the economic and small business impacts associated with this final rule.

1.0 Industry Profile

1.1 Introduction

At its core, the petroleum refining industry comprises establishments primarily engaged in refining crude petroleum into finished petroleum products. Examples of these petroleum products include gasoline, kerosene, asphalt, lubricants, and solvents, among others.

Firms engaged in petroleum refining are categorized under the North American Industry Classification System (NAICS) code 324110. In 2006, 149 establishments owned by 58 parent companies were refining petroleum. That same year, the petroleum refining industry shipped products valued at over \$489 billion (U.S. Department of Commerce, Bureau of the Census, 2007).

This industry profile report is organized as follows. Section 1.2 provides a detailed description of the inputs, outputs, and processes involved in petroleum refining. Section 1.3 describes the applications and users of finished petroleum products. Section 1.4 discusses the organization of the industry and provides facility- and company-level data. In addition, small businesses are reported separately for use in evaluating the impact on small business to meet the requirements of the Small Business Regulatory Enforcement and Fairness Act (SBREFA). Section 1.5 contains market-level data on prices and quantities and discusses trends and projections for the industry.

1.2 The Supply Side

Estimating the economic impacts of any regulation on the petroleum refining industry requires a good understanding of how finished petroleum products are produced (the “supply side” of finished petroleum product markets). This section describes the production process used to manufacture these products as well as the inputs, outputs, and by-products involved. The section concludes with a description of costs involved with the production process.

1.2.1 Production Process, Inputs, and Outputs

Petroleum pumped directly out of the ground, known as crude oil, is a complex mixture of hydrocarbons (chemical compounds that consist solely of hydrogen and carbon) and various impurities such as salt. To manufacture the variety of petroleum products recognized in every day life, this tar-like mixture must be refined and processed

over several stages. This section describes the typical stages involved in this process as well as the inputs and outputs.

1.2.1.1 The Production Process

The process of refining crude oil into useful petroleum products can be separated into two phases and a number of supporting operations. These phases are described in detail in the following section. In the first phase, crude oil is desalted and then separated into its various hydrocarbon components (known as “fractions”). These fractions include gasoline, kerosene, naphtha, and other products (EPA, 1995).

In the second phase, the distilled fractions are converted into petroleum products (such as gasoline and kerosene) using three different types of downstream processes: combining, breaking, and reshaping (EPA, 1995). An outline of the refining process is presented in Figure 1-1.

Desalting. Before separation into fractions, crude oil is treated to remove salts, suspended solids, and other impurities that could clog or corrode the downstream equipment. This process, known as “desalting,” is typically done by first heating the crude oil, mixing it with process water, and depositing it into a gravity settler tank. Gradually, the salts present in the oil will be dissolved into the process water (EPA, 1995). After this takes place, the process water is separated from the oil by adding demulsifier chemicals (a process known as chemical separation) and/or by applying an electric field to concentrate the suspended water globules at the bottom of the settler tank (a process known as electrostatic separation). The effluent water is then removed from the tank and sent to the refinery wastewater treatment facilities (EPA, 1995). This process is illustrated in Figure 1-2.

Atmospheric Distillation. The desalted crude oil is then heated in a furnace to 750°F and fed into a vertical distillation column at atmospheric pressure. After entering the tower, the lighter fractions flash into vapor and travels up the tower. This leaves only the heaviest fractions (which have a much higher boiling point) at the bottom of the tower. These fractions include heavy fuel oil and asphalt residue (EPA, 1995).

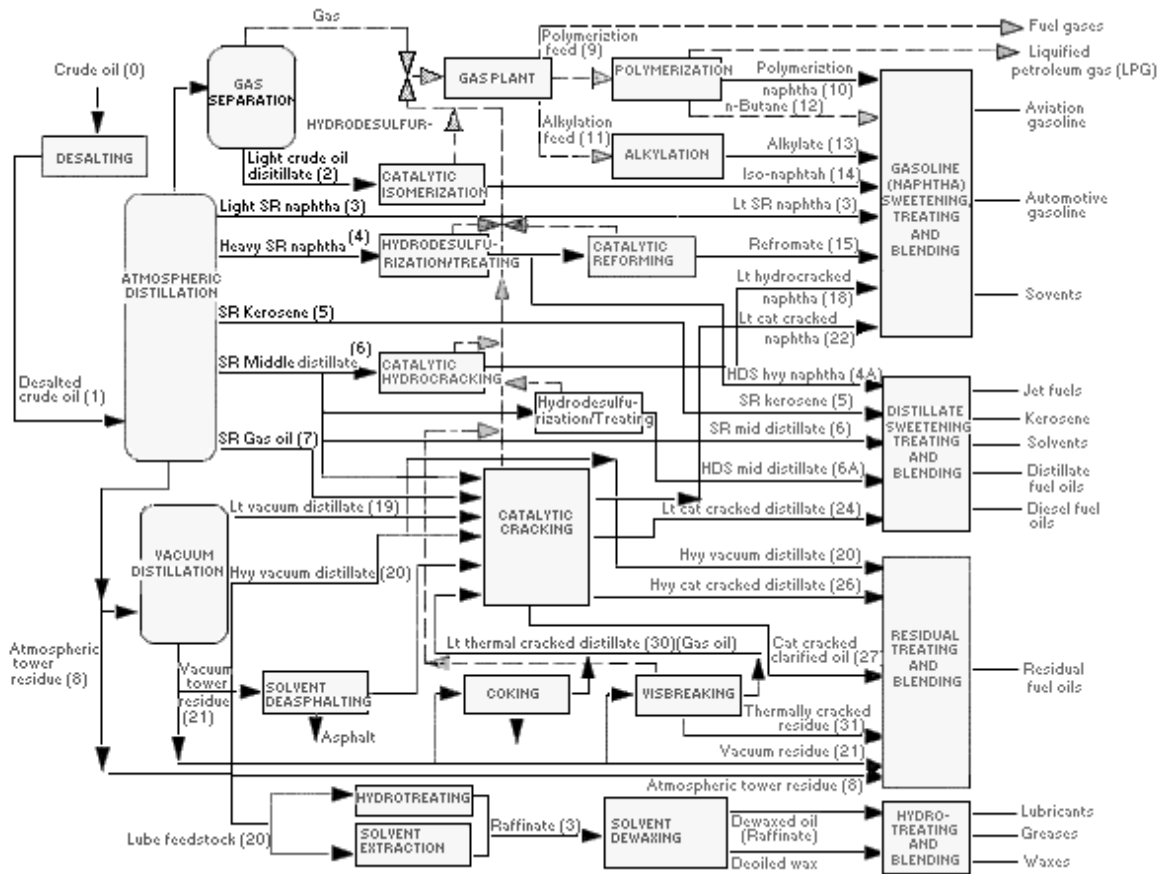

Figure 1-1. Outline of the Refining Process

Source: U.S. Department of Labor, Occupational Safety and Health Administration (OSHA). 2003. OSHA Technical Manual, Section IV: Chapter 2, Petroleum Refining Processes. TED 01-00-015. Washington, DC: U.S. DOL. Available at <http://www.osha.gov/dts/osta/otm/otm_iv/otm_iv_2.html>. As obtained on October 23, 2006.

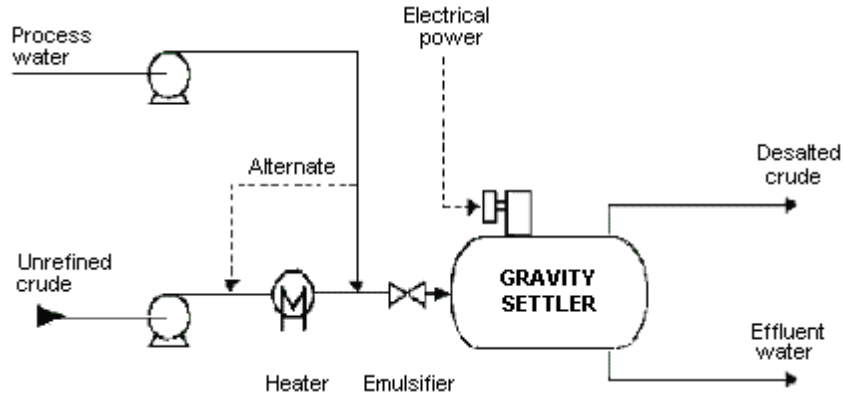

Figure 1-2. Desalting Process

Source: U.S. Department of Labor, Occupational Safety and Health Administration (OSHA). 2003. OSHA Technical Manual, Section IV: Chapter 2, Petroleum Refining Processes. TED 01-00-015. Washington, DC: U.S. DOL. Available at <http://www.osha.gov/dts/osta/otm/otm_iv/otm_iv_2.html>. As obtained on October 23, 2006.

As the hot vapor rises, its temperature is gradually reduced. Lighter fractions condense onto trays located at successively higher portions of the tower. For example, motor gasoline will condense at higher portion of the tower than kerosene because it condenses at lower temperatures. This process is illustrated in Figure 1-3. As these fractions condense, they will be drawn off their respective trays and potentially sent downstream for further processing (OSHA, 2003; EPA, 1995).

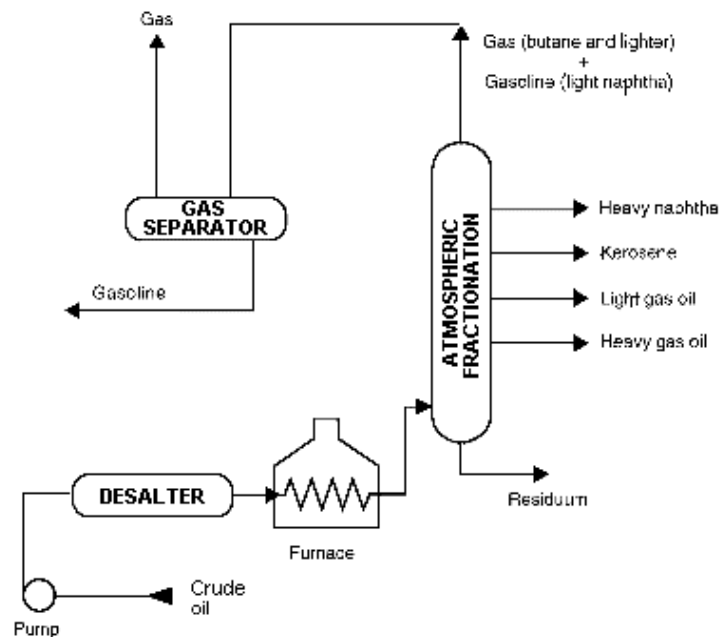

Figure 1-3. Atmospheric Distillation Process

Source: U.S. Department of Labor, Occupational Safety and Health Administration (OSHA). 2003. OSHA Technical Manual, Section IV: Chapter 2, Petroleum Refining Processes. TED 01-00-015. Washington, DC: U.S. DOL. Available at <http://www.osha.gov/dts/osta/otm/otm_iv/otm_iv_2.html>. As obtained on October 23, 2006.

Vacuum Distillation. The atmospheric distillation tower cannot distil the heaviest fractions (those at the bottom of the tower) without cracking under requisite heat and pressure. So these fractions are separated using a process called vacuum distillation. This process takes place in one or more vacuum distillation towers and is similar to the atmospheric distillation process, except very low pressures are used to increase volatilization and separation. A typical first-phase vacuum tower may produce gas oils or lubricating-oil base stocks (EPA, 1995). This process is illustrated in Figure 1-4.

Downstream Processing. To produce the petroleum products desired by the market place, most fractions must be further refined after distillation or “downstream.” These downstream processes change the molecular structure of the hydrocarbon molecules by breaking them into smaller molecules, joining them to form larger molecules, or shaping them into higher quality molecules (EPA, 1995).

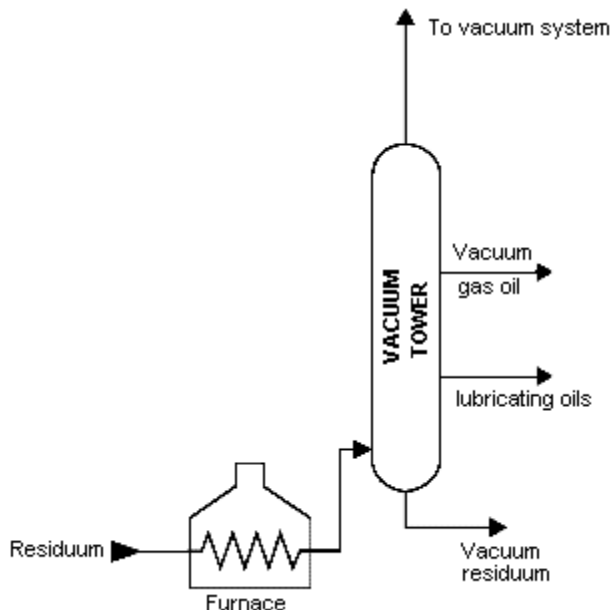

Figure 1-4. Vacuum Distillation Process

Source: U.S. Department of Labor, Occupational Safety and Health Administration (OSHA). 2003. OSHA Technical Manual, Section IV: Chapter 2, Petroleum Refining Processes. TED 01-00-015. Washington, DC: U.S. DOL. Available at <http://www.osha.gov/dts/osta/otm/otm_iv/otm_iv_2.html>. As obtained on October 23, 2006.

Downstream processes include thermal cracking, coking, catalytic cracking, catalytic hydrocracking, hydrotreating, alkylation, isomerization, polymerization, catalytic reforming, solvent extraction, mercox, dewaxing, propane deasphalting and other operations (EPA, 1995).

1.2.1.2 Supporting Operations

In addition to the processes described above, there are other refinery operations that do not directly involve the production of hydrocarbon fuels, but serve in a supporting role. Some of the major supporting operations are described in this section.

Wastewater Treatment. Petroleum refining operations produce a variety of wastewaters including process water (water used in process operations like desalting), cooling water (water used for cooling that does not come into direct contact with the oil), and surface water runoff (resulting from spills to the surface or leaks in the equipment that have collected in drains).

Wastewater typically contains a variety of contaminants (such as hydrocarbons, suspended solids, phenols, ammonia, sulfides, and other compounds) and must be treated

before it is recycled back into refining operations or discharged. Petroleum refineries typically utilize two stages of wastewater treatment. In primary wastewater treatments, oil and solids present in the wastewater are removed. After this is completed, wastewater can be discharged to a publicly owned treatment facility or undergo secondary treatment before being discharged directly to surface water. In secondary treatment, microorganisms are used to dissolve oil and other organic pollutants that are present in the wastewater (EPA, 1995; OSHA, 2003).

Gas Treatment and Sulfur Recovery. Petroleum refinery operations such as coking and catalytic cracking emit gases with a high concentration of hydrogen sulfide mixed with light refinery fuel gases (such as methane and ethane). Sulfur must be removed from these gases in order to comply with Clean Air Act's SO_x emission limits and to recover saleable elemental sulfur.

Sulfur is recovered by first separating the fuel gases from the hydrogen sulfide gas. Once this is done, elemental sulfur is removed from the hydrogen sulfide gas using a recovery system known as the Claus Process. In this process, hydrogen sulfide is burned under controlled conditions producing sulfur dioxide. A bauxite catalyst is then used to react with the sulfur dioxide and the unburned hydrogen sulfide to produce elemental sulfur. However, the Claus process only removed 90% of the hydrogen sulfide present in the gas stream, so other processes must be used to recover the remaining sulfur (EPA, 1995).

Additive Production. A variety of chemicals are added to petroleum products to improve their quality or add special characteristics. For example, ethers have been added to gasoline to increase octane levels and reduce CO emissions since the 1970s.

The most common ether additives being used today are methyl tertiary butyl ether (MTBE), and tertiary amyl methyl ether (TAME). Larger refineries tend to manufacture these additives themselves by reacting isobutylene (a by-product of several refinery processes) with methanol (OSHA, 2003).

Heat Exchangers, Coolers, and Process Heaters. Petroleum refineries require very high temperatures to perform many of their refining processes. To achieve these temperatures, refineries use fired heaters fueled by refinery or natural gas, distillate, and residual oils. This heat is managed through heat exchanges, where are composed of bundles of pipes, tubes, plate coils, and other equipment that surround heating or cooling

water, steam, or oil. Heat exchanges facilitate the indirect transfer of heat as needed (OSHA, 2003).

Pressure Release and Flare Systems. As liquids and gases expand and contract through the refining process, pressure must be actively managed to avoid accident. Pressure-relief systems enable the safe handling of liquids and gases that are released by pressure-relieving devices and blow-downs. According to the OSHA Technical Manual, “pressure relief is an automatic, planned release when operating pressure reaches a predetermined level. A blow-down normally refers to the intentional release of material, such as blow-downs from process unit startups, furnace blow-downs, shutdowns, and emergencies” (OSHA, 2003).

Blending. Blending is the final operation in petroleum refining. It is the physical mixture of a number of different liquid hydrocarbons to produce final petroleum products that have desired characteristics. For example, additives such as ethers can be blended with motor gasoline to boost performance and reduce emissions. Products can be blended in-line through a manifold system, or batch blended in tanks and vessels (OSHA, 2003).

1.2.1.3 Inputs

The inputs in the production process of petroleum products include general inputs such as labor, capital, and water. The inputs specific to this industry are crude oil and the variety of chemicals used in producing petroleum products. These two specific inputs are discussed below.

Crude Oil. Contrary to popular conception, crude oils are complex, heterogeneous mixtures. Crude oils contain many different hydrocarbon compounds that vary in appearance and composition from one oil field to another. An “average” crude oil contains about 84% carbon; 14% hydrogen; and less than 2% sulfur, nitrogen, oxygen, metals, and salts (OSHA, 2003).

In 2004, the petroleum refining industry used 5.6 billion barrels of crude oil in the production of finished petroleum products (EIA, 2005).¹

Common Refinery Chemicals. In addition to crude oil, a variety of chemicals are used in the production of petroleum products. The specific chemicals used will depend on specific characteristics of the product in question. Table 1-1 lists the most

¹ A barrel is a unit of volume that is equal to 42 U.S. gallons.

common chemicals used by petroleum refineries, their characteristics, and their applications.

In 2004, the petroleum refining industry used 581 million barrels of natural gas liquids and other liquids in the production of finished petroleum products (EIA, 2005).

1.2.1.4 Types of Product Outputs

The petroleum refining industry produces a number of products that tend to fall into one of three categories: fuels, finished nonfuel products, and feedstock for the petrochemical industry. Table 1-2 briefly describes these product categories. A more detailed discussion of petroleum fuel products can be found in Section 1.3.

Table 1-1. Types and Characteristics of Raw Materials used in Petroleum Refineries

Type	Description
Crude Oil	Heterogeneous mixture of different hydrocarbon compounds.
Oxygenates	Substances which, when added to gasoline, increase the amount of oxygen in that gasoline blend. Ethanol, methyl tertiary butyl ether (MTBE), ethyl tertiary butyl ether (ETBE), and methanol are common oxygenates.
Caustics	Caustics are added to desalting water to neutralize acids and reduce corrosion. They are also added to desalted crude in order to reduce the amount of corrosive chlorides in the tower overheads. They are used in some refinery treating processes to remove contaminants from hydrocarbon streams.
Leaded Gasoline Additives	Tetraethyl lead (TEL) and tetramethyl lead (TML) are additives formerly used to improve gasoline octane ratings but are no longer in common use except in aviation gasoline
Sulfuric Acid and Hydrofluoric Acid	Sulfuric acid and hydrofluoric acid are used primarily as catalysts in alkylation processes. Sulfuric acid is also used in some treatment processes.

Source: U.S. Department of Labor, Occupational Safety and Health Administration (OSHA). 2003. OSHA Technical Manual, Section IV: Chapter 2, Petroleum Refining Processes. TED 01-00-015. Washington, DC: U.S. DOL. Available at <http://www.osha.gov/dts/osta/otm/otm_iv/otm_iv_2.html>. As obtained on October 23, 2006.

Table 1-2. Major Refinery Product Categories

Product Category	Description
Fuels	Finished Petroleum products that are capable of releasing energy. These products power equipment such as automobiles, jets, and ships. Typical petroleum fuel products include gasoline, jet fuel, and residual fuel oil.
Finished nonfuel products	Petroleum products that are not used for powering machines or equipment. These products typically include asphalt, lubricants (such as motor oil and industrial greases), and solvents (such as benzene, toluene, and xylene).
Feedstock	Many products derived from crude oil refining, such as ethylene, propylene, butylene, and isobutylene, are primarily intended for use as petrochemical feedstock in the production of plastics, synthetic fibers, synthetic rubbers, and other products.

Source: U.S. Department of Labor, Occupational Safety and Health Administration (OSHA). 2003. OSHA Technical Manual, Section IV: Chapter 2, Petroleum Refining Processes. TED 01-00-015. Washington, DC: U.S. DOL. Available at <http://www.osha.gov/dts/osta/otm/otm_iv/otm_iv_2.html>. As obtained on October 23, 2006.

1.2.2 Emissions and Controls in Petroleum Refining

Petroleum refining leads to emissions of metals; spent acids; numerous toxic organic compounds; and gaseous pollutants, including carbon monoxide (CO), sulfur oxides, (SO_x), nitrogen oxides (NO_x), particulates, ammonia (NH₃), hydrogen sulfide (H₂S), and volatile organic compounds (VOCs).

1.2.2.1 Gaseous and VOC Emissions

As previously mentioned, CO, SO_x, NO_x, NH₃, and H₂S emissions are produced along with petroleum products. Sources of these emissions from refineries include fugitive emissions of the volatile constituents in crude oil and its fractions, emissions from the burning of fuels in process heaters, and emissions from the various refinery processes themselves.

Fugitive emissions occur as a result of leaks throughout the refinery. Although individual leaks may be small, the sum of all leaks can result in a lot of hazardous emissions. These emissions can be reduced by purchasing leak-resistant equipment and maintaining an ongoing leak detection and repair program (EPA, 1995).

The numerous process heaters used in refineries to heat process streams or to generate steam (boilers) for heating or other uses can be potential sources of SO_x, NO_x, CO, and hydrocarbons emissions. Emissions are low when process heaters are operating properly and using clean fuels such as refinery fuel gas, fuel oil, or natural gas. However, if combustion is not complete, or the heaters are fueled using fuel pitch or residuals, emissions can be significant (EPA, 1995).

The majority of gas streams exiting each refinery process contain varying amounts of refinery fuel gas, H₂S, and NH₃. These streams are directed to the gas treatment and sulfur recovery units described in the previous section. Here, refinery fuel gas and sulfur are recovered using a variety of processes. These processes create emissions of their own, which normally contain H₂S, SO_x, and NO_x gases (EPA, 1995).

Emissions can also be created by the periodic regeneration of catalysts that are used in downstream processes. These processes generate streams that may contain relatively high levels of CO, particulates, and VOCs. However, these emissions are treated before being discharged to the atmosphere. First, the emissions are processed through a CO boiler to burn CO and any VOCs, and then through an electrostatic precipitator or cyclone separator to remove particulates (EPA, 1995).

1.2.2.2 Wastewater and Other Wastes

Petroleum refining operations produce a variety of wastewaters including process water (water used in process operations like desalting), cooling water (water used for cooling that does not come into direct contact with the oil), and surface water runoff (resulting from spills to the surface or leaks in the equipment that have collected in drains). This wastewater typically contains a variety of contaminants (such as hydrocarbons, suspended solids, phenols, NH₃, sulfides, and other compounds) and is treated in on-site facilities before being recycled back into the production process or discharged.

Other wastes include forms of sludges, spent process catalysts, filter clay, and incinerator ash. These wastes are controlled through a variety of methods including incineration, land filling, and neutralization, among other treatment methods (EPA, 1995).

1.2.3 Costs of Production

Between 1995 and 2006, expenditures on input materials accounted for the largest cost to petroleum refineries—amounting to 94% of total expenses (Figure 1-5). These material costs included the cost of all raw materials, containers, scrap, and supplies used in production or repair during the year, as well as the cost of all electricity and fuel consumed.

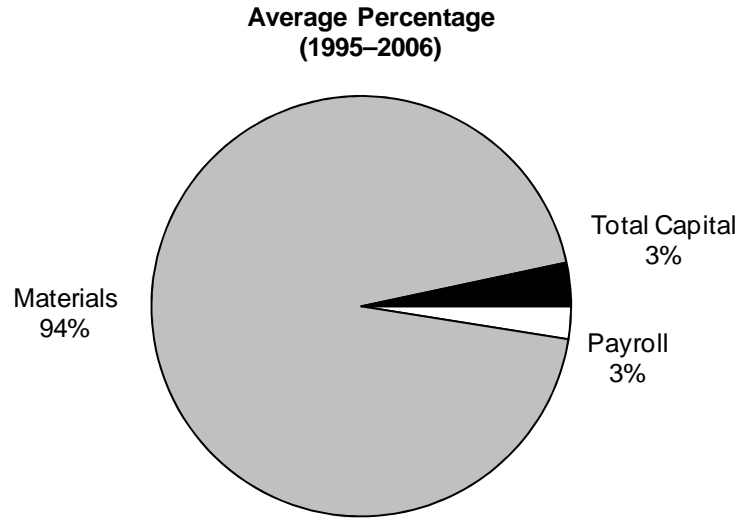

Figure 1-5. Petroleum Refinery Expenditures

Labor and capital accounted for the remaining expenses faced by petroleum refiners. Capital expenditures include permanent additions and alterations to facilities and machinery and equipment used for expanding plant capacity or replacing existing machinery. A detailed breakdown of how much petroleum refiners spent on each of these factors of production over this 11-year period is provided in Table 1-3. A more exhaustive assessment of the costs of materials used in petroleum refining is provided in Table 1-4.

1.3 The Demand Side

Estimating the economic impact the regulation will have on the petroleum refining industry also requires characterizing various aspects of the demand for finished petroleum products. This section describes the characteristics of finished petroleum products, their uses and consumers, and possible substitutes.

Table 1-3. Labor, Material, and Capital Expenditures for Petroleum Refineries (NAICS 324110)

Year	Payroll (\$millions)		Materials (\$millions)		Total Capital (\$millions)	
	Reported	2005	Reported	2005	Reported	2005
1995	3,791	4,603	112,532	136,633	5,937	7,209
1996	3,738	4,435	132,880	157,658	5,265	6,247
1997	3,885	4,595	127,555	150,865	4,244	5,020
1998	3,695	4,415	92,212	110,187	4,169	4,982
1999	3,983	4,682	114,131	134,146	3,943	4,635
2000	3,992	4,509	180,568	203,967	4,685	5,292
2001	4,233	4,743	158,733	177,838	6,817	7,638
2002	4,386	4,947	166,368	187,646	5,152	5,811
2003	4,752	5,227	185,369	203,893	6,828	7,510
2004	5,340	5,635	251,467	265,369	6,601	6,966
2005	5,796	5,796	345,207	345,207	10,525	10,525
2006	5,984	5,751	396,980	381,546	11,175	10,741

Note: Adjusted for inflation using the producer price index industry for total manufacturing industries (Table 5-6).

Sources: U.S. Department of Commerce, Bureau of the Census. 2007. 2006 Annual Survey of Manufactures. Obtained through American Fact Finder Database <http://factfinder.census.gov/home/saff/main.html?_lang=en>.

U.S. Department of Commerce, Bureau of the Census. 2006. *2005 Annual Survey of Manufactures*. M05(AS)-1. Washington, DC: Government Printing Office. Available at <<http://www.census.gov/prod/2006pubs/am0531gs1.pdf>>. As obtained on October 23, 2007.

U.S. Department of Commerce, Bureau of the Census. 2003a. *2001 Annual Survey of Manufactures*. M01(AS)-1. Washington, DC: Government Printing Office. Available at <<http://www.census.gov/prod/2003pubs/m01as-1.pdf>>. As obtained on October 23, 2006.

U.S. Department of Commerce, Bureau of the Census. 2001. *1999 Annual Survey of Manufactures*. M99(AS)-1 (RV). Washington, DC: Government Printing Office. Available at <<http://www.census.gov/prod/2001pubs/m99-as1.pdf>>. As obtained on October 23, 2006.

U.S. Department of Commerce, Bureau of the Census. 1998. *1996 Annual Survey of Manufactures*. M96(AS)-1 (RV). Washington, DC: Government Printing Office. Available at <<http://www.census.gov/prod/3/98pubs/m96-as1.pdf>>. As obtained on October 23, 2006.

U.S. Department of Commerce, Bureau of the Census. 1997. *1995 Annual Survey of Manufactures*. M95(AS)-1. Washington, DC: Government Printing Office. Available at <<http://www.census.gov/prod/2/manmin/asm/m95as1.pdf>>. As obtained on October 23, 2006.

1.3.1 Product Characteristics

Petroleum refining firms produce a variety of different products. The characteristics these products possess largely depend on their intended use. For example, the gasoline fueling our automobiles has different characteristics than the oil lubricating the car's engine. However, as discussed in Section 1.1.4, finished petroleum products can be categorized into three broad groups based on their intended uses (EIA, 1999a):

Table 1-4. Costs of Materials Used in Petroleum Refining Industry

Material	2002		1997	
	Delivered Cost (\$10 ⁶)	Percentage of Material Costs	Delivered Cost (\$10 ⁶)	Percentage of Material Costs
Petroleum Refineries NAICS 324110				
Total materials	157,415,200	100.0%	118,682,535	100.0%
Domestic crude petroleum, including lease condensate	63,157,497	40.1%	47,220,759	39.8%
Foreign crude petroleum, including lease condensate	69,102,574	43.9%	48,172,988	40.6%
Foreign unfinished oils (received from foreign countries for further processing)	2,297,967	1.5%	2,373,376	2.0%
Ethane (C2) (80% purity or more)	D		D	
Propane (C3) (80% purity or more)	118,257	0.1%	269,928	0.2%
Butane (C4) (80% purity or more)	1,925,738	1.2%	1,567,875	1.3%
Gas mixtures (C2, C3, C4)	1,843,708	1.2%	952,009	0.8%
Isopentane and natural gasoline	810,530	0.5%	1,381,100	1.2%
Other natural gas liquids, including plant condensate	455,442	0.3%	1,427,123	1.2%
Toluene and xylene (100% basis)	159,563	0.1%	N	
Additives (including antioxidants, antiknock compounds, and inhibitors)	40,842	0.0%	262,228	0.2%
Other additives (including soaps and detergents)	709	0.0%	200,005	0.2%
Animal and vegetable oils	D		D	
Chemical catalytic preparations	D		647,040	0.5%
Sodium hydroxide (caustic soda) (100% NaOH)	129,324	0.1%	41,741	0.0%
Sulfuric acid, excluding spent (100% H ₂ SO ₄)	189,912	0.1%	56,514	0.0%
Metal containers	9,450	0.0%	60,531	0.1%
Plastics containers	D		N	
Paper and paperboard containers	D		18,404	0.0%
Cost of materials received from petroleum refineries and lube manufacturers	8,980,758	5.7%	4,981,370	4.2%
All other materials and components, parts, containers, and supplies	5,722,580	3.6%	4,233,383	3.6%
Materials, ingredients, containers, and supplies, nsk	576,175	0.4%	4,779,890	4.0%

Source: U.S. Department of Commerce, Bureau of the Census. 2004. *2002 Economic Census, Industry Series—Shipbuilding and Repair*. Washington, DC: Government Printing Office. Available at <<http://www.census.gov/prod/ec02/ec0231i324110.pdf>>. As obtained on October 23, 2006.

- **fuels**—petroleum products that are capable of releasing energy such as motor gasoline
- **nonfuel products**—petroleum products that are not used for powering machines or equipment such as solvents and lubricating oils
- **petrochemical feedstocks**—petroleum products that are used as a raw material in the production of plastics, synthetic rubber, and other goods

A list of selected products from each of these groups is presented in Table 1-5 along with a description of each product's characteristics and primary uses.

Table 1-5. Major Refinery Products

Product	Description
Fuels	
Gasoline	A blend of refined hydrocarbons, motor gasoline ranks first in usage among petroleum products. It is primarily used to fuel automobiles and lightweight trucks as well as boats, recreational vehicles, lawn mowers, and other equipment. Other forms of gasoline include Aviation gasoline, which is used to power small planes.
Kerosene	Kerosene is a refined middle-distillate petroleum product that finds considerable use as a jet fuel. Kerosene is also used in water heaters, as a cooking fuel, and in lamps.
Liquefied petroleum gas (LPG)	LPG consists principally of propane (C ₃ H ₈) and butane (C ₄ H ₁₀). It is primarily used as a fuel in domestic heating, cooking, and farming operations.
Distillate fuel oil	Distillate fuel oil includes diesel oil, heating oils, and industrial oils. It is used to power diesel engines in buses, trucks, trains, automobiles, as well as other machinery.
Residual fuels	Residual fuels are the fuels distilled from the heavier oils that remain after atmospheric distillation, they find their primary use generating electricity in electric utilities. However, residual fuels can also be used as fuel for ships, industrial boiler fuel, and commercial heating fuel.
Petroleum coke	Coke is a high carbon residue that is the final product of thermal decomposition in the condensation process in cracking. Coke can be used as a low-ash solid fuel for power plants.
Finished Nonfuel Products	
Coke	In addition to use as a fuel, petroleum coke can be used a raw material for many carbon and graphite products such as furnace electrodes and liners.
Asphalt	Asphalt, used for roads and roofing materials, must be inert to most chemicals and weather conditions.
Lubricants	Lubricants are the result of a special refining process that produce lubricating oil base stocks, which are mixed with various additives. Petroleum lubricating products include spindle oil, cylinder oil, motor oil, and industrial greases.
Solvents	A solvent is a fluid that dissolves a solid, liquid, or gas into a solution. Petroleum based solvents, such as Benzene, are used to manufacture detergent and synthetic fibers. Other solvents include toluene and xylene.
Feedstock	
Ethylene	Ethylene is the simplest alkene and has the chemical formula C ₂ H ₄ . It is the most produced organic compound in the world and it is used in the production of many products. For example, one of ethylene's derivatives is ethylene oxide, which is a primary raw material in the production of detergents.
Propylene	Propylene is an organic compound with the chemical formula C ₃ H ₆ . It is primarily used the production of polypropylene, which is used in the production of food packaging, ropes, and textiles.

Sources: U.S. Department of Labor, Occupational Safety and Health Administration (OSHA). 2003. OSHA Technical Manual, Section IV: Chapter 2, Petroleum Refining Processes. TED 01-00-015. Washington, DC: U.S. DOL. Available at <http://www.osha.gov/dts/osta/otm/otm_iv/otm_iv_2.html>. As obtained on October 23, 2006.

U.S. Department of Energy, Energy Information Administration (EIA). 1999.

1.3.2 Uses and Consumers

Finished petroleum products are rarely consumed as final goods in themselves. Instead, they are used as primary inputs in the creation of a vast number of other goods and services. For example, goods created from petroleum products include fertilizers,

pesticides, paints, thinners, cleaning fluids, refrigerants, and synthetic fibers (EPA, 1995). Similarly, fuels made from petroleum are used to run vehicles and industrial machinery and generate heat and electrical power. As a result, the demand for many finished petroleum products is derived from the demand for the goods and services they are used to create.

The principal end users of petroleum products can be separated into five sectors:

- Residential sector—private homes and residences
- Industrial sector—manufacturing, construction, mining, agricultural, and forestry establishments
- Transportation sector—private and public vehicles that move people and commodities such as automobiles, ships, and aircraft
- Commercial sector—nonmanufacturing or nontransportation business establishments such as hotels, restaurants, retail stores, religious and nonprofit organizations, as well federal, state, and local government institutions
- Electric utility sector—privately and publicly owned establishments that generate, transmit, distribute, or sell electricity (primarily) to the public; nonutility power producers are not included in this sector

Of these end users, the transportation sector consumes the largest share of petroleum products, accounting for 67% of total consumption in 2005 (EIA, 2006a). In fact, petroleum products like motor gasoline, distillate fuel, and jet fuel provide virtually all of the energy consumed in the transportation sector (EIA, 1999a).

Of the three petroleum product categories, end-users primarily consume fuel. Fuel products account for 9 out of 10 barrels of petroleum used in the United States (EIA, 1999a). In 2005, motor gasoline alone accounted for 49% of demand for finished petroleum products (EIA, 2006a).

1.3.3 Substitution Possibilities in Consumption

A major influence on the demand for finished petroleum products is the availability of substitutes. In some sectors, like the transportation sector, it is currently difficult to switch quickly from one fuel to another without costly and irreversible equipment changes, but other sectors can switch relatively quickly and easily (EIA, 1999a).

For example, equipment at large manufacturing plants often can use either residual fuel oil or natural gas. Often coal and natural gas can be easily substituted for residual fuel oil at electricity utilities. As a result, we would expect demand in these industries to be more sensitive to price (in the short run) than in others (EIA, 1999a).

However, over time, demand for petroleum products could become more elastic. For example, automobile users could purchase more fuel-efficient vehicles or relocate to areas that would allow them to make fewer trips. Technological advances could also create new products that compete with petroleum products that currently have no substitutes. An example of such a technological advance would be the invention of ethanol (an alcohol produced from biomass), which can substitute for gasoline in spark-ignition motor vehicles (EIA, 1999a).

1.3.4 Model Parameters

Essential components of an economic impact analysis are supply and demand price elasticities. These elasticities measure the responsiveness of producers and consumers to price changes and determine how the social costs of a regulatory program are distributed between the two groups of stakeholders. Economic theory suggests consumers will bear a higher share of the economic welfare losses if the supply of a petroleum product is more responsive to price changes than is the demand for that product. A summary of the estimates of demand and supply elasticities for commonly produced petroleum products is provided in Table 1-6.

Table 1-6. Estimates of Price Elasticity of Demand and Supply

Market	Motor Gasoline	Jet Fuel	Distillate Fuel Oil	Residual Fuel Oil	Liquefied Petroleum Gases
Demand elasticity	-0.29	-0.15	-0.75	-0.68	-0.8
Supply elasticity	1.24	1.24	1.24	1.24	1.24

Sources: U.S. Environmental Protection Agency. 1995. *Economic Impact Analysis for Petroleum Refineries NESHAP*. EPA-452/R-95-003, Final Report. Washington DC: Government Printing Office.

1.4 Industry Organization

This section examines the organization of the U.S. petroleum refining industry, including market structure, firm characteristics, plant location, and capacity utilization. Understanding the industry's organization helps determine how it will be affected by new emissions standards.

1.4.1 Market Structure

Market structure characterizes the level and type of competition among petroleum refining companies and determines their power to influence market prices for their products. For example, if an industry is perfectly competitive, then individual producers cannot raise their prices above the marginal cost of production without losing market share to their competitors. Understanding pricing behavior in the petroleum refining industry is crucial for performing subsequent EIAs.

According to basic microeconomic theory, perfectly competitive industries are characterized by unrestricted entry and exit of firms, large numbers of firms, and undifferentiated (homogenous) products being sold. Conversely, imperfectly competitive industries or markets are characterized by barriers to entry and exit, a smaller number of firms, and differentiated products (resulting from either differences in product attributes or brand name recognition of products). This section considers whether the petroleum refining industry is competitive based on these three factors.

1.4.1.1 Barriers to Entry

Firms wanting to enter the petroleum refining industry may face at least two major barriers to entry. First, according to a 2004 Federal Trade Commission staff study, there are significant economies of scale in petroleum refinery operations. This means that costs per unit fall as a refinery produces more finished petroleum products. As a result, new firms that must produce at relatively low levels will face higher average costs than firms that are established and produce at higher levels, which will make it more difficult for these new firms to compete (Nicholson, 2005). This is known as a technical barrier to entry.

Second, legal barriers could also make it difficult for new firms to enter the petroleum refining industry. The most common example of a legal barrier to entry is patents—intellectual property rights, granted by the government, that give exclusive monopoly to an inventor over his invention for a limited time period. In the petroleum refining industry, firms rely heavily on process patents to appropriate returns from their

innovations. As a result, firms seeking to enter the petroleum refining industry must develop processes that respect the novelty requirements of these patents, which could potentially make entry more difficult for new firms (Langinier, 2004). A second example of a legal barrier would be environmental regulations that apply only to new entrants or new pollution sources. Such regulations would raise the operating costs of new firms without affecting the operating costs of existing ones. As a result, new firms may be less competitive.

Although neither of these barriers are impossible for new entrants to overcome, they can make it more difficult for new firms to enter the market for manufactured petroleum products. As a result, existing petroleum refiners could potentially raise their prices above competitive levels with less worry about new firms entering the market to compete away their customers with lower prices. It was not possible during this analysis to quantify how significant these barriers would be for new entrants or what effect they would have on market prices. However, existing firms would still face competition from each other. In an unconcentrated industry, competition among existing firms would work to keep prices at competitive levels.

1.4.1.2 Measures of Industry Concentration

Economists often use a variety of measures to assess the concentration of a given industry. Common measures include four-firm concentration ratios (CR4), eight-firm concentration ratios (CR8), and Herfindahl-Hirschmann indexes (HHI). The CR4s and CR8s measure the percentage of sales accounted for by the top four and eight firms in the industry. The HHIs are the sums of the squared market shares of firms in the industry. These measures of industry concentration are reported for the petroleum refining industry (NAICS 324110) in Table 1-7 for selected years between 1985 and 2003.

Table 1-7. Market Concentration Measures of the Petroleum Refining Industry: 1985 to 2003

Measure	1985	1990	1996	2000	2001	2002	2003
Herfindahl-Hirschmann Index (HHI)	493	437	412	611	686	743	728
Four-firm concentration ratio (CR4)	34.4	31.4	27.3	40.2	42.5	45.4	44.4
Eight-firm concentration ratio (CR8)	54.6	52.2	48.4	61.6	67.2	70.0	69.4

Source: Federal Trade Commission (FTC). 2004. "The Petroleum Industry: Mergers, Structural Change, and Antitrust Enforcement." Available at <<http://www.ftc.gov/opa/2004/08/oilmergersrpt.shtm>>. As obtained on February 6, 2007.

Between 1990 and 2000, the HHI rose from 437 to 611, which indicates an increase in market concentration over time. This increase is partially due to merger activity during this time period. Between 1990 and 2000, over 2,600 mergers occurred across the petroleum industry; 13% of these mergers occurred in the industry's refining and marketing segments (GAO, 2007).

Unfortunately, there is no objective criterion for determining market structure based on the values of these concentration ratios. However, accepted criteria have been established for determining market structure based on the HHIs for use in horizontal merger analyses (U.S. Department of Justice and the Federal Trade Commission, 1992). According to these criteria, industries with HHIs below 1,000 are considered unconcentrated (i.e., more competitive); industries with HHIs between 1,000 and 1,800 are considered moderately concentrated (i.e., moderately competitive); and industries with higher HHIs are considered heavily concentrated. Based on this criterion, the petroleum refining industry continues to be unconcentrated even after an increase in merger activity.

A more rigorous examination of market concentration was conducted in a 2004 Federal Trade Commission (FTC) staff study. This study explicitly accounted for the fact that a refinery in one geographic region may not exert competitive pressure on a refinery in another region if transportation costs are high. This was done by comparing HHIs across Petroleum Administration for Defense Districts (PADDs). PADDs separate the United States into five geographic regions or districts. They were initially created during World War II to help manage the allocation of fuels during wartime. However, they have remained in use as a convenient way of organizing petroleum market information (FTC, 2004).

This study concluded that these geographic markets were not highly concentrated. PADDs I, II, and III (East Coast, Midwest, and Gulf Coast) were sufficiently connected that they exerted a competitive influence on each other. The HHI for these combined regions was 789 in 2003, indicating a low concentration level. Concentration in PADD IV (Rocky Mountains) was also low in 2003, with an HHI of 944. PADD V gradually grew more concentrated in the 1990s after a series of significant refinery mergers. By 2003, the region's HHI was 1,246, indicating growth to a moderate level of concentration (FTC, 2004).

1.4.1.3 Product Differentiation

Another way firms can influence market prices for their product is through product differentiation. By differentiating one's product and using marketing to establish brand loyalty, manufacturers can raise their prices above marginal cost without losing market share to their competitors.

While we saw in Section 1.3 that there are a wide variety of petroleum products with many different uses, individual petroleum products are by nature quite homogenous. For example, there is little difference between premium motor gasoline produced at different refineries (Mathtech, 1997). As a result, the role of product differentiation is probably quite small for many finished petroleum products. However, there are examples of relatively small refining businesses producing specialty products for small niche markets. As a result, there may be some instances where product differentiation is important for price determination.

1.4.1.4 Competition among Firms in the Petroleum Refining Industry

Overall, the petroleum industry is characterized as producing largely generic products for sale in relatively unconcentrated markets. Although it is not possible to quantify how much barriers to entry and other factors will affect competition among firms, it seems unlikely that individual petroleum refiners would be able to significantly influence market prices given the current structure of the market.

1.4.2 Characteristics of U.S. Petroleum Refineries and Petroleum Refining Companies

A petroleum refinery is a facility where labor and capital are used to convert material inputs (such as crude oil and other materials) into finished petroleum products. Companies that own these facilities are legal business entities that conduct transactions and make decisions that affect the facility. The terms "facility," "establishment," and "refinery" are synonymous in this study and refer to the physical location where products are manufactured. Likewise, the terms "company" and "firm" are used interchangeably to refer to the legal business entity that owns one or more facilities. This section presents information on refineries, such as their location and capacity utilization, as well as financial data for the companies that own these refineries.

1.4.2.1 Geographic Distribution of U.S. Petroleum Refineries

There are approximately 149 petroleum refineries operating in the United States, spread across 33 states. The number of petroleum refineries located in each of these states

is listed in Table 1-8. This table illustrates that a significant portion of petroleum refineries are located along the Gulf of Mexico region. The leading petroleum refining states are Texas, California, and Louisiana.

Table 1-8. Number of Petroleum Refineries, by State

State	Number of Petroleum Refineries
Alabama	4
Alaska	6
Arkansas	2
California	21
Colorado	2
Delaware	1
Georgia	1
Hawaii	2
Illinois	4
Indiana	2
Kansas	3
Kentucky	2
Louisiana	18
Michigan	1
Minnesota	2
Mississippi	4
Montana	4
Nevada	1
New Jersey	6
New Mexico	3
North Dakota	1
Ohio	4
Oklahoma	5
Oregon	1
Pennsylvania	5
Tennessee	1
Texas	25
Utah	5
Virginia	1
Washington	5
West Virginia	1
Wisconsin	1
Wyoming	5
Total	149

Source: U.S. Department of Energy, Energy Information Administration (EIA). 2006b. "Refinery Capacity Report 2006." Available at http://www.eia.doe.gov/oil_gas/petroleum/data_publications/refinery_capacity_data/refcapacity.html>. As obtained on October 23, 2006.

1.4.2.2 Capacity Utilization

Capacity utilization indicates how well current refineries meet demand. One measure of capacity utilization is capacity utilization rates. A capacity utilization rate is the ratio of actual production volumes to full-capacity production volumes. For example,

if an industry is producing as much output as possible without adding new floor space for equipment, the capacity utilization rate would be 100 percent. On the other hand, if under the same constraints the industry were only producing 75 percent of its maximum possible output, the capacity utilization rate would be 75 percent. On an industry-basis, capacity utilization is highly variable from year to year depending on economic conditions. It is also variable on a company-by-company basis depending not only on economic conditions, but also on company's strategic position in its particular industry. While some plants may have idle production lines or empty floor space, others need additional space or capacity.

Table 1-9 lists the capacity utilization rates for petroleum refineries from 2000 to 2006. It is interesting to note the significant drop in capacity utilization in 2005. This would seem counter intuitive since there does not appear to be evidence that demand for petroleum products is not dropping. To understand why this might be the case, one must first realize that the capacity utilization ratio in petroleum industry represents the utilization of the atmospheric crude oil distillation units.

Table 1-9. Full Production Capacity Utilization Rates for Petroleum Refineries

Year	Petroleum Refineries Capacity Utilization Rates (NAICS 324110)	Gross Input to Atmospheric Crude Oil Distillation Units (1,000s of barrels per day)	Operational Capacity (1,000s of barrels per day)
2000	92.6	15,299	16,525
2001	92.6	15,352	16,582
2002	90.7	15,180	16,744
2003	92.6	15,508	16,748
2004	93.0	15,783	16,974
2005	90.6	15,578	17,196
2006	89.7	15,602	17,385

Source: U.S. Department of Energy, Energy Information Administration (EIA). 2007a. "Refinery Utilization and Capacity." Available at <http://tonto.eia.doe.gov/dnav/pet/pet_pnp_unc_dcu_nus_m.htm>. As obtained on January, 2007.

This is calculated for the petroleum industry by dividing the gross input to atmospheric crude oil distillation units (all inputs involved in atmospheric crude oil distillation, such as crude oil) by the industry's operational capacity.

In 2004, operational capacity increased from 16,974,000 barrels per calendar day to 17,196,000 barrels per calendar day. However, gross inputs fell from 15,783,000 barrels per calendar day in 2004 to 15,578,000 in 2005. This indicates that capacity utilization sagged due to a drop in production inputs. In 2006, gross inputs grew 0.15% to

15,602,000 barrels per day. However, since operational capacity grew much faster (from 17,196,000 to 17,385,000 or 1.00%), capacity utilization rates for the industry continued to fall.

1.4.2.3 Characteristics of Small Businesses Owning U.S. Petroleum Refineries

According to the Small Business Administration (SBA), a small business in the petroleum refining industry is defined for government procurement purposes as having 1,500 or fewer employees (SBA, 2008).

As of January 2006, there were 149 petroleum refineries operating in the continental United States with a cumulative capacity of processing over 17 million barrels of crude per calendar day (EIA, 2006c). RTI identified 58 parent companies owning refineries in the United States and was able to collect employment and sales data for 47 (84%) of them.

The distribution of employment across companies is illustrated in Figure 1-6. As this figure shows, 25 companies (53%) of these 47 employ fewer than 1,500 workers and would be considered small businesses. These firms earned an average of \$1.04 billion of revenue per year, while firms employing more than 1,500 employees earned an average of \$84.2 billion of revenue per year (Figure 1-7). A distribution of the number of firms earning different levels of revenue is presented in Figure 1-8.

Employment, crude capacity, and location information are provided in Table 1-9 for each of companies employing 1,500 employees or less. Similar information can be found for all 56 companies owning petroleum refineries in Appendix A.

In Section 1.4.2.1, we discussed how petroleum refining operations are characterized by economies of scale—that the cost per unit falls as a refinery produces more finished petroleum products. This means that smaller petroleum refiners face higher per unit costs than larger refining operations because they produce fewer petroleum products. As a result, some smaller firms have sought to overcome their competitive disadvantage by locating close to product-consuming areas to lower transportation costs and serving niche product markets (FTC, 2004).

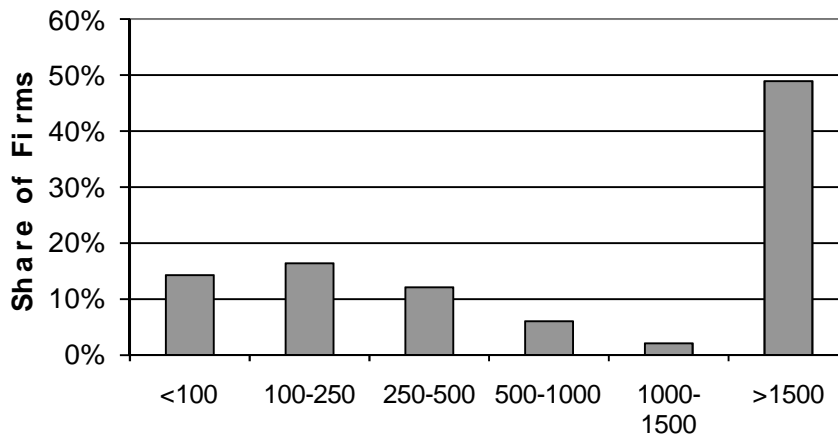

Figure 1-6. Employment Distribution of Companies Owning Petroleum Refineries (N=47)

Sources: Dun & Bradstreet. 2007a. 2007 D&B Million Dollar Directory. Pennsylvania: Dun & Bradstreet Inc.

Dun & Bradstreet Small Business Solutions. Small Business Database. Available at <<http://smallbusiness.dnb.com/default.asp?bhcd2=1107465546>>.

Gale Research Inc. 2007. Ward's Business Directory of U.S. Private and Public Companies. Detroit: Gale Research.

Hoovers. 2007. Free Content, Company Information. Available at <<http://www.hoovers.com/free/>>.

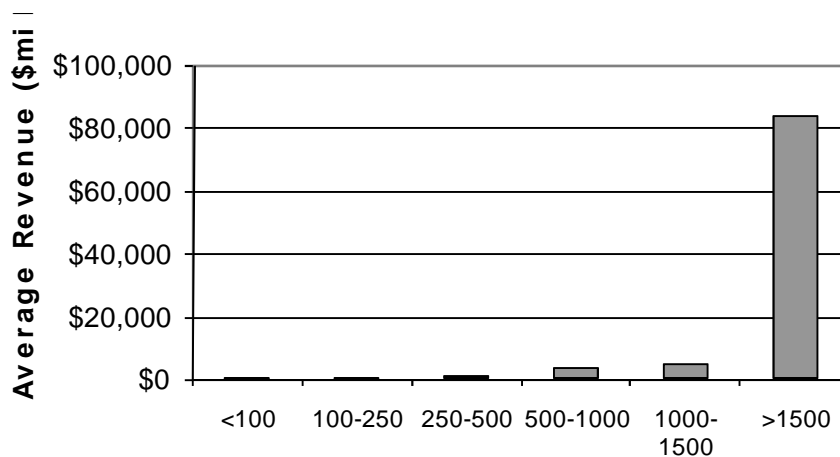

Figure 1-7. Average Revenue of Companies Owning Petroleum Refineries by Employment (N=47)

Sources: Dun & Bradstreet. 2007. 2007 D&B Million Dollar Directory. Pennsylvania: Dun & Bradstreet Inc.

Dun & Bradstreet Small Business Solutions. Small Business Database. Available at <<http://smallbusiness.dnb.com/default.asp?bhcd2=1107465546>>.

Gale Research Inc. 2007. Ward's Business Directory of U S Private and Public Companies. Detroit: Gale Research.

Hoovers. 2007. Free Content, Company Information. Available at <<http://www.hoovers.com/free/>>.

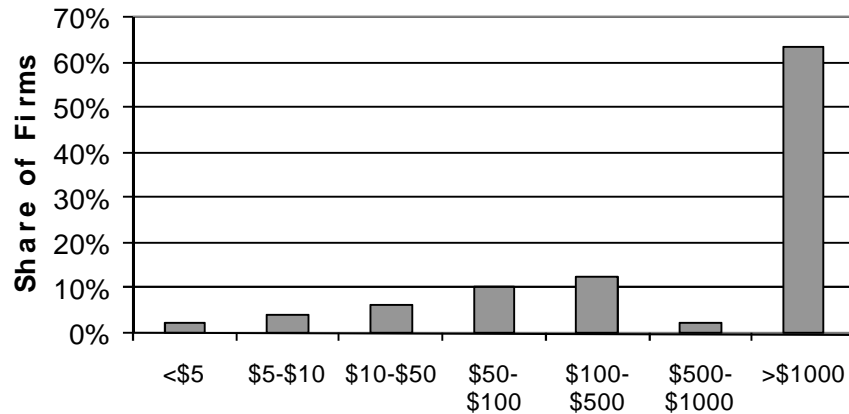

Figure 1-8. Revenue Distribution of Companies Owning Petroleum Refineries (N=47)

Sources: Dun & Bradstreet. 2007. 2007 D&B Million Dollar Directory. Pennsylvania: Dun & Bradstreet Inc.

Dun & Bradstreet Small Business Solutions. Small Business Database. Available at <<http://smallbusiness.dnb.com/default.asp?bhcd2=1107465546>>.

Gale Research Inc. 2007. Ward's Business Directory of U S Private and Public Companies. Detroit: Gale Research.

Hoovers. 2007. Free Content, Company Information. Available at <<http://www.hoovers.com/free/>>.

A good example of a firm locating close to prospective customers is Countrymark Cooperative, Inc., which was started in the 1930s for the express purpose of providing farmers in Indiana with a consistent supply of fuels, lubricants, and other products. A good example of a firm producing niche products is Calumet Lubricants, which focuses on developing and manufacturing naphthenic specialty oils.

However, recent developments are making these factors less important for success in the industry. For example, the entry of new product pipelines is eroding the locational advantage of smaller refineries (FTC, 2004). This trend can possibly be illustrated by the fact that most refineries owned by small businesses tend to be located in relatively rural areas (see Table 1-10). The median population density of counties occupied by small refineries is 94 people per square mile. This could suggest that refineries do not rely on the population surrounding them to support their refining operations.

Table 1-10. Characteristics of Small Businesses in the Petroleum Refining Industry

Parent Company	Parent Company Type	Cummulative Crude Capacity (bbl/cd)	Parent Company Sales (\$Millions)	Parent Company Employment (#)	Facility Name	Facility City	Facility State	Facility County	County ID	Facility County Population Density (2000)
AGE Refining & Manufacturing	Private	12,200	287	52	AGE Refining & Manufacturing	San Antonio	TX	Bexar County	TXBexar County	1,117
American Refining Group	Private	10,000	350	310	American Refining Group	Bradford	PA	McKean County	PAMcKean County	47
Arabian American Development Co	Public	0	80	118	South Hampton Resources Inc.	Silsbee	TX	Hardin County	TXHardin County	54
Calcasieu Refining Co.	Private	30,000	638	51	Calcasieu Refining Co.	Lake Charles	LA	Calcasieu Parish	LACalcasieu Parish	171
Calumet Specialty Products	Public	63,320	1,641	350	Calumet Specialty Products	Shreveport	LA	Caddo Parish	LACaddo Parish	286
					Calumet Specialty Products	Cotton Valley	LA	Caddo Parish	LACaddo Parish	286
					Calumet Specialty Products	Princeton	LA	Caddo Parish	LACaddo Parish	286
Countrymark Cooperative, Inc.	Private	23,000	87	300	Countrymark Cooperative, Inc.	Mt. Vernon	IN	Posey County	INPosey County	66
Cross Oil & Refining Co. Inc.	Private	7,200	49	110	Cross Oil & Refining Co. Inc.	Smackover	AR	Union County	ARUnion County	44
CVR Energy Inc.	Public	112,000	3,038	577	Coffeyville Resources LLC	Coffeyville	KS	Montgomery County	KSMontgomery County	56
Foreland Refining Co.	Private	2,000	56	100	Foreland Refining Co.	Tonopah/Eagle Springs	NV	Nye County	NVNye County	2
Frontier Oil Corp	Private	153,000	4,000	727	Frontier Oil & Refining Co.	Cheyenne	WY	Laramie County	WYLaramie County	30
					Frontier Oil Corp	El Dorado	KS	Butler County	KSButler County	42
Gary-Williams Co	Private	54,000	97	200	Wynnewood Refining Co.	Wynnewood	OK	Garvin County	OKGarvin County	34

(Continued)

Table 1-10. Characteristics of Small Businesses in the Petroleum Refining Industry (continued)

Parent Company	Parent Company Type	Cumulative Crude Capacity (bbl/cd)	Parent Company Sales (\$Millions)	Parent Company Employment (#)	Facility Name	Facility City	Facility State	Facility County	Facility County Population Density (2000)
Goodway Refining LLC	Private	4,100	3	18	Goodway Refining LLC	Atmore	AL	Escambia County	41
Greka Integrated Inc	Private	9,500	22	145	Greka Integrated Inc	Santa Maria	CA	Santa Barbara County	146
Gulf Atlantic Operations LLC	Private	16,700	9	32	Gulf Atlantic Operations LLC	Mobile Bay	AL	Mobile County	324
Holly Corp.	Public	99,700	4,023	859	Holly Corp. Navajo Refining Co.	Woods Cross Artesia	UT NM	Davis County Eddy County	785 12
Hunt Refining Co.	Private	45,500	4,871	1,100	Hunt Refining Co. Hunt Southland Refining Hunt Southland Refining	Tuscaloosa Lumberton Sandersville	AL MS MS	Tuscaloosa County Lamar County Lamar County	125 79 79
Lion Oil Co.	Private	70,000	247	425	Lion Oil Co.	El Dorado	AR	Union County	44
Pelican Refining Co. LLC	Private	0	29	62	Pelican Refining Co. LLC	Lake Charles	LA	Calcasieu Parish	171
Placid Refining Inc.	Private	56,000	1,400	200	Placid Refining Inc.	Port Allen	LA	West Baton Rouge Parish	113
San Joaquin Refining Co., Inc.	Private	15,000	288	20	San Joaquin Refining Co., Inc.	Bakersfield	CA	Kern County	81
Somerset Oil Inc	Private	5,500	55	150	Somerset Refinery Inc.	Somerset	KY	Pulaski County	85
Trigeant Ltd.	Private	0	5	50	Trigeant Ltd.	Corpus Christi	TX	Nueces County	375

(Continued)

Table 1-10. Characteristics of Small Businesses in the Petroleum Refining Industry (continued)

Parent Company	Parent Company Type	Cumulative Crude Capacity (bbl/cd)	Parent Company Sales (\$Millions)	Parent Company Employment (#)	Facility Name	Facility City	Facility State	Facility County	Facility County Population Density (2000)
Western Refining, Inc.	Public	212,200	4,200	416	Western Refining, Inc.	El Paso	TX	El Paso County	671
					Giant Refining Co.	Yorktown	VA	York County	533
					Giant Refining Co.	Bloomfield	NM	San Juan County	21
					Giant Refining Co.	Gallup	NM	McKinley County	14
World Oil Corp	Private	8,500	277	475	Lunday-Thagard Co.	South Gate	CA	Los Angeles County	2,344
Wyoming Refining Co.	Private	12,500	340	107	Wyoming Refining Co.	Newcastle	WY	Weston County	3
Total		2,128,860	59,738	12,688					

Sources: Dun & Bradstreet. 2007. *2007 D&B Million Dollar Directory*. Pennsylvania: Dun & Bradstreet Inc.

Dun & Bradstreet Small Business Solutions. Small Business Database. Available at <<http://smallbusiness.dnb.com/default.asp?bhcd2=1107465546>>.

Gale Research Inc. 2007. *Ward's Business Directory of U S Private and Public Companies*. Detroit: Gale Research.

Hoovers. 2007. Free Content, Company Information. Available at <<http://www.hoovers.com/free/>>. As obtained on April 11, 2007.

U.S. Department of Commerce, Bureau of the Census. 2000. "Population Density by County: Census 2000 Summary File 1 (SF 1) 100-Percent Data". Available through American Fact Finder <http://factfinder.census.gov/home/saff/main.html?_lang=en>. As obtained on February 21, 2008.

Capacity information for the 29 refineries owned by small businesses also suggests that fewer small businesses are focusing on developing specialty products or serving local customers as major parts of their business plan. For example, in 2006 these 29 refineries had a collective crude refining capacity of 778,920 barrels per calendar day or 857,155 barrels per stream day (EIA, 2006c). Approximately 21% of this total capacity was devoted to producing specialty products or more locally focused products such as aromatics, asphalt, lubricants, and petroleum coke. The remaining 79% was used to produce gasoline, kerosene, diesel fuel, and liquefied petroleum gases. As discussed in Section 1.4.1.3, fuel products tend to be quite homogenous (gasoline from one refinery is not very different from gasoline from another refinery), and they are also normally transported by pipeline.

1.5 Markets

This section provides data on the volume of petroleum products produced and consumed in the United States, the quantity of products imported and exported, and the average prices of major petroleum products. The section concludes with a discussion of future trends for the petroleum refining industry.

1.5.1 U.S. Petroleum Consumption

Figure 1-9 illustrates the amount of petroleum products supplied between 2000 and 2006 (measured in millions of barrels of oil). These data represent the approximate consumption of petroleum products because it measures the disappearance of these products from primary sources (i.e., refineries, natural gas processing plants, blending plants, pipelines, and bulk terminals).

Between 2000 and 2004, U.S. consumption of petroleum products increased by 5%. Consumption grew steadily from 2001 and 2004 before leveling off and slightly declining in 2006 (Figure 1-9). This reduced growth was primarily the result of less jet fuel and residual fuel being consumed in recent years (Table 1-11).

1.5.2 U.S. Petroleum Production

Table 1-12 reports the number of barrels of major petroleum products produced in the United States between 2000 and 2006. U.S. production of petroleum products at refineries and blenders grew steadily between 1995 and 2003. However, production declined by 0.35% in 2005. This drop was possibly the result of damage inflicted by two hurricanes (Hurricane Katrina and Hurricane Rita) on the U.S. Gulf Coast—the location of many U.S. petroleum refineries (Section 1.4.2). According to the American Petroleum Institute, approximately 30% of the U.S. refining industry was shut down as a result of the damage (API, 2006). In 2006, production of

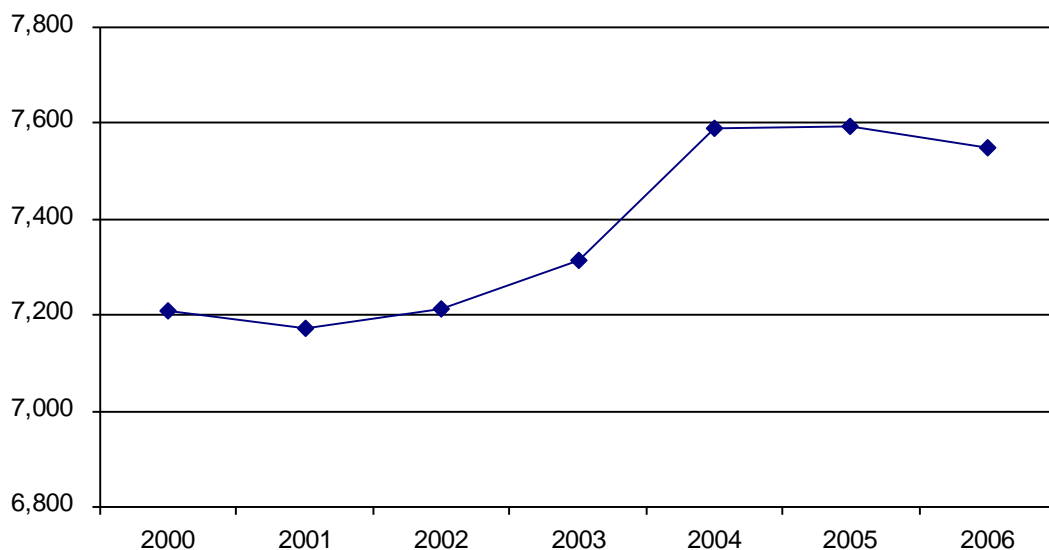

Figure 1-9. Total Petroleum Products Supplied (millions of barrels per year)

Table 1-11. Total Petroleum Products Supplied (millions of barrels per year)

Year	Motor Gasoline	Jet Fuel	Distillate Fuel Oil	Residual Fuel Oil	Liquefied Petroleum Gases	Other Products	Total
2000	3,101	631	1,362	333	816	967	7,211
2001	3,143	604	1,404	296	746	978	7,172
2002	3,229	591	1,378	255	789	969	7,213
2003	3,261	576	1,433	282	757	1,003	7,312
2004	3,333	597	1,485	316	780	1,076	7,588
2005	3,343	613	1,503	336	741	1,057	7,593
2006	3,377	596	1,522	251	749	1,055	7,551

Source: U.S. Department of Energy, Energy Information Administration (EIA). "Petroleum Supply Annuals 1996–2007, Volume 1." Available at <http://www.eia.doe.gov/oil_gas/petroleum/data_publications/petroleum_supply_annual/psa_volume1/psa_volume1.html>. As obtained on October 31, 2007.

petroleum products rebounded, increasing 1% over 2004 levels. Additional production data are presented in Table 1-13, which reports the value of shipments of products produced by the petroleum refining industry between 1997 and 2006.

1.5.3 International Trade

International trade is a growing component of the U.S. petroleum refining industry. This trend is demonstrated in Tables 1-14 and 1-15. Between 1995 and 2006, imports and exports of petroleum products increased by more than 50%. While imports of most major petroleum

Table 1-12. U.S. Refinery and Blender Net Production (millions of barrels per year)

Year	Motor Gasoline	Jet Fuel	Distillate Fuel Oil	Residual Fuel Oil	Liquefied Petroleum Gases	Other Products	Total
2000	2,910	588	1,310	255	258	990	6,311
2001	2,928	558	1,349	263	243	968	6,309
2002	2,987	553	1,311	219	245	990	6,305
2003	2,991	543	1,353	241	240	1,014	6,383
2004	3,025	566	1,396	240	236	1,057	6,520
2005	3,036	564	1,443	229	209	1,015	6,497
2006	3,053	541	1,475	232	229	1,032	6,561

Source: U.S. Department of Energy, Energy Information Administration (EIA). "Petroleum Supply Annuals 1996–2007, Volume 1." Available at <http://www.eia.doe.gov/oil_gas/petroleum/data_publications/petroleum_supply_annual/psa_volume1/psa_volume1.html>. As obtained on October 31, 2007.

Table 1-13. Value of Product Shipments of the Petroleum Refining Industry

Year	Millions of \$Reported	Millions of \$2005
1997	152,756	180,671
1998	114,439	136,746
1999	140,084	164,651
2000	210,187	237,425
2001	195,898	219,476
2002	186,761	210,647
2003	216,764	238,425
2004	290,280	306,328
2005	419,063	419,063
2006	489,051	470,037

Note: Numbers were adjusted for inflation using producer price index industry data for Total Manufacturing Industries (Table 5-6).

Sources: U.S. Department of Commerce, Bureau of the Census. 2007. 2006 Annual Survey of Manufactures. Obtained through American Fact Finder Database <http://factfinder.census.gov/home/saff/main.html?_lang=en>. U.S. Department of Commerce, Bureau of the Census. 2003b. 2001 Annual Survey of Manufactures. M01(AS)-2. Washington, DC: Government Printing Office. Available at <<http://www.census.gov/prod/2003pubs/m01as-2.pdf>>. As obtained on March 4, 2008.

products grew at approximately the same rate, the growth of petroleum product exports was driven largely by residual fuel oil and other petroleum products.

However, the United States remains a net importer of petroleum products. In 2006, the United States imported nearly three times more petroleum products than it exported. These imported petroleum products accounted for 17% of total petroleum products consumed that year (1,310 millions of barrels per year/7,551 millions of barrels per year).

Table 1-14. Imports of Major Petroleum Products (millions of barrels per year)

Year	Motor Gasoline	Jet Fuel	Distillate Fuel Oil	Residual Fuel Oil	Liquefied Petroleum Gases	Other Products	Total
1995	97	35	71	68	53	262	586
1996	123	40	84	91	61	322	721
1997	113	33	83	71	62	345	707
1998	114	45	77	101	71	324	731
1999	139	47	91	86	66	344	774
2000	156	59	108	129	79	343	874
2001	166	54	126	108	75	400	928
2002	182	39	98	91	67	396	872
2003	189	40	122	119	82	397	949
2004	182	47	119	156	96	520	1,119
2005	220	69	120	193	120	587	1,310
2006	173	68	133	128	121	687	1,310

Source: U.S. Department of Energy, Energy Information Administration (EIA). "Petroleum Supply Annuals 1996–2007, Volume 1." Available at <http://www.eia.doe.gov/oil_gas/petroleum/data_publications/petroleum_supply_annual/psa_volume1/psa_volume1.html>. As obtained on October 31, 2007.

Table 1-15. Exports of Major Petroleum Products (millions of barrels per year)

Year	Motor Gasoline	Jet Fuel	Distillate Fuel Oil	Residual Fuel Oil	Liquefied Petroleum Gases	Other Products	Total
1995	38	8	67	49	21	128	312
1996	38	17	70	37	19	138	319
1997	50	13	56	44	18	147	327
1998	46	9	45	50	15	139	305
1999	40	11	59	47	18	124	300
2000	53	12	63	51	27	157	362
2001	48	10	44	70	16	159	347
2002	45	3	41	65	24	177	356
2003	46	7	39	72	20	186	370
2004	45	15	40	75	16	183	374
2005	49	19	51	92	19	183	414
2006	52	15	79	103	21	203	472

Source: U.S. Department of Energy, Energy Information Administration (EIA). "Petroleum Supply Annuals 1996–2007, Volume 1." Available at <http://www.eia.doe.gov/oil_gas/petroleum/data_publications/petroleum_supply_annual/psa_volume1/psa_volume1.html>. As obtained on October 31, 2007.

1.5.4 Market Prices

The average nominal prices of major petroleum products sold to end users are provided for selected years in Table 1-16.² As these data illustrate, nominal prices rose substantially between 2004 and 2006. In particular, the price of motor gasoline rose 48% over this 2-year period.

² Sales to end users are those made directly to the consumer of the product. This includes bulk consumers, such as agriculture, industry, and utilities, as well as residential and commercial consumers.

Table 1-16. Average Price of Major Petroleum Products Sold to End Users (cents per gallon)

Product	1995	2000	2002	2004	2005	2006
Motor gasoline	76.5	110.6	94.7	143.5	182.9	212.8
No. 1 distillate fuel	62	98.8	82.8	126.2	183.2	213.7
No. 2 distillate fuel	56	93.4	75.9	123.5	177.7	209.1
Jet fuel	54	89.9	72.1	120.7	173.5	199.8
Residual fuel oil	39.2	60.2	56.9	73.9	104.8	121.8

Source: U.S. Department of Energy, Energy Information Administration (EIA). 2007b. "Refiner Petroleum Product Prices by Sales Type." Available at <http://tonto.eia.doe.gov/dnav/pet/pet_pri_refoth_dcu_nus_m.htm>. As obtained on January 11, 2008.

Note: Prices do not include taxes.

The nominal prices domestic petroleum refiners receive for their products have also been rising much faster than prices received by other U.S. manufacturers. This trend is demonstrated in Table 1-17 by comparing the producer price index (PPI) for the petroleum refining industry against the index for all manufacturing industries. Between 1995 and 2006, prices received by petroleum refineries for their products rose by 223%, while prices received by all manufacturing firms rose by 26%. The vast majority of this growth in prices has been experienced in the years after 2002.

Table 1-17. Producer Price Index Industry Data: 1995 to 2006

Year	Petroleum Refining (NAICS 32411)		Total Manufacturing Industries	
	PPI	Annual Percentage Change in PPI	PPI	Annual Percentage Change in PPI
1995	74.5	3%	124.2	3%
1996	85.3	14%	127.1	2%
1997	83.1	-3%	127.5	0%
1998	62.3	-25%	126.2	-1%
1999	73.6	18%	128.3	2%
2000	111.6	52%	133.5	4%
2001	103.1	-8%	134.6	1%
2002	96.3	-7%	133.7	-1%
2003	121.2	26%	137.1	3%
2004	151.5	25%	142.9	4%
2005	205.3	36%	150.8	6%
2006	241.0	17%	156.9	4%

Source: U.S. Bureau of Labor Statistics (BLS). 2007. "Producer Price Index Industry Data: Customizable Industry Data Tables." Available at <<http://www.bls.gov/ppi/>>. As obtained on October 11, 2007.

1.5.5 Profitability of Petroleum Refineries

Estimates of the mean profit (before taxes) to net sales ratios for petroleum refiners are reported in Table 1-18 for the 2006–2007 fiscal year. These ratios were calculated by Risk

Table 1-18. Mean Ratios of Profit before Taxes as a Percentage of Net Sales for Petroleum Refiners, Sorted by Value of Assets

Fiscal Year	Total Number of Statements	0 to 500,000	500,000 to 2 Million	2 Million to 10 Million	10 Million to 50 Million	50 Million to 100 Million	100 Million to 250 Million	All Firms
4/1/2006– 3/31/2007	44	—	—	4.6	6.5	—	—	6.7

Source: Risk Management Association (RMA). 2008. *Annual Statement Studies 2007-2008*. Pennsylvania: RMA, Inc.

Management Associates by dividing net income into revenues for 44 firms in the petroleum refining industry. They are broken down based on the value of assets owned by the reporting firms.

As these ratios demonstrate, firms that reported a greater value of assets also received a greater return on sales. For example, firms with assets valued between \$10 and \$50 million received a 6.5% average return on net sales, while firms with assets valued between \$2 and \$10 million only received a 4.6% average return. The average return on sales for the entire industry was 6.7%.

Obtaining profitability information specifically for small petroleum refining companies can be difficult as most of these firms are privately owned. However, five of the small, domestic petroleum refining firms identified in Section 1.4.2.3 are publicly owned companies—the Arabian American Development Co., CVR Energy Inc., Calumet Specialty Products Partners, L.P., Holly Corporation, Western Refining, Inc. Profit ratios were calculated for these companies using data obtained from their publicly available 2006 income statements. These ratios are presented in Table 1-19.

1.5.6 Industry Trends

The Energy Information Administration’s (EIA’s) 2007 Annual Energy Outlook provides forecasts of average petroleum prices, petroleum product consumption, and petroleum refining capacity utilization to the year 2030. Trends in these variables are affected by many factors that are difficult to predict, such as energy prices, U.S. economic growth, advances in technologies, changes in weather patterns, and future public policy decisions. As a result, the EIA evaluated a wide variety of cases based on different assumptions of how these factors will behave in the future. This section focuses on the EIA’s “reference case” forecasts, which assume that current policies affecting the energy sector will remain unchanged throughout the projection period (EIA, 2007c).

According to the 2007 Annual Energy Outlook's reference forecast, world oil prices (defined as the average price of low-sulfur, light crude oil) are expected to fall significantly over

Table 1-19. Net Profit Margins for Publicly Owned, Small Petroleum Refiners: 2006

Company	Net Income (\$millions)	Total Revenue (\$millions)	Net Profit Margin (%)
Arabian American Development Co.	7.9	98.5	8.0%
Calumet Specialty Products Partners	93.9	1,641.0	5.7%
CVR Energy Inc.	191.6	3,037.6	6.3%
Holly Corporation	266.6	4,023.2	6.6%
Western Refining, Inc.	204.8	4,199.5	4.9%

Sources: Arabian American Development Co. April 6, 2007. 10K for year ended December 31, 2006. EDGAR Database. Available at <<http://www.sec.gov/Archives/edgar/data/7039/000095013407007709/0000950134-07-007709-index.htm>>.

Calumet Specialty Products Partners. February 23, 2007. 10K for year ended December 31, 2006. EDGAR Database. Available at <<http://www.sec.gov/Archives/edgar/data/1340122/000095013407003992/h43776e10vk.htm>>.

CVR Energy Inc. 2006. Google Finance. Available at <<http://finance.google.com/finance?q=NYSE:CVI>> As obtained on February 28, 2008.

Holly Corporation. March 1, 2007. 10K for year ended December 31, 2006. EDGAR Database. Available at <<http://www.sec.gov/Archives/edgar/data/48039/000095013407004555/d44106e10vk.htm>>.

Western Refining, Inc. March 8, 2007. 10K for year ended December 31, 2006. EDGAR Database. Available at <<http://www.sec.gov/Archives/edgar/data/1339048/000095013407005096/h44360e10vk.htm>>.

the next 10 years as the amount of oil supplied by non-OPEC and OPEC countries increases. Since crude oil is the primary input in petroleum refining, a decline in its price would likewise represent a decline in production costs of petroleum refiners. As a result, the prices of petroleum products sold to end users are expected to decline over the same period (Table 1-20). These lower prices will, in turn, encourage more petroleum products to be consumed (Table 1-21). Between 2007 and 2015, the prices of major petroleum products are expected to fall approximately 20% to 25%, while consumption of those products is expected to rise by 9%.

Operational capacity of U.S. petroleum refineries is also expected to grow for the foreseeable future. The expansion of dozens of petroleum refineries has already been announced (Reuters, 2007). The *Oil & Gas Journal's* 2007 Worldwide Construction Update survey alone catalogued nearly 40 refining construction projects being pursued in the United States.

Table 1-20. Forecasted Average Price of Major Petroleum Products Sold to End Users in 2005 Currency (cents per gallon)

Product	2007	2008	2009	2010	2011	2012	2013	2014	2015
Motor gasoline	257.4	241.3	227.3	217.3	209.2	204.7	201.1	195.2	194.9
Jet fuel	175.4	158.3	152.0	147.2	140.0	135.8	135.5	132.9	133.5
Distillate fuel	253.8	236.6	224.1	215.9	205.0	197.2	194.7	190.3	191.0
Residual fuel oil	123.5	125.8	120.6	113.9	107.7	102.8	96.6	95.9	98.0
LPGs	257.4	241.3	227.3	217.3	209.2	204.7	201.1	195.2	194.9

Source: U.S. Department of Energy, Energy Information Administration (EIA). 2007c. "Annual Energy Outlook." Available at <[http://www.eia.doe.gov/oiaf/archive/aeo07/pdf/0383\(2007\).pdf](http://www.eia.doe.gov/oiaf/archive/aeo07/pdf/0383(2007).pdf)>. As obtained on January 21, 2007.

Table 1-21. Total Petroleum Products Supplied (millions of barrels per year)

Year	Motor Gasoline	Jet Fuel	Distillate Fuel Oil	Residual Fuel Oil	Liquefied Petroleum Gases	Other Products	Total
2007	3,388	622	1,600	275	819	940	7,643
2008	3,407	646	1,613	278	824	953	7,721
2009	3,446	675	1,631	281	815	955	7,804
2010	3,479	713	1,654	287	809	937	7,879
2011	3,520	728	1,682	289	811	961	7,990
2012	3,563	739	1,710	294	812	958	8,076
2013	3,610	749	1,735	303	812	967	8,177
2014	3,663	758	1,755	306	814	953	8,249
2015	3,716	766	1,774	300	815	970	8,341

Source: U.S. Department of Energy, Energy Information Administration (EIA). 2007c. "Annual Energy Outlook." Available at <[http://www.eia.doe.gov/oiaf/archive/aeo07/pdf/0383\(2007\).pdf](http://www.eia.doe.gov/oiaf/archive/aeo07/pdf/0383(2007).pdf)>. As obtained on January 21, 2007.

Table 1-22. Selected Refinery Construction Projects: 2008–2011

Company and Location	Project	Projected Added Capacity (barrels per day)	Expected Completion
Cenex Harvest States, Laurel, MT	New delayed coker unit	N/A	2008
Frontier Oil Corp, El Dorado, KS	New crude distillation unit	N/A	2008
	New vacuum distillation unit	N/A	2008
Marathon Petroleum Co. LLC, Garyville, LA	New crude distillation unit	180,000	2009
	New delayed coker unit	N/A	2009
Motiva Enterprises LLC, Port Arthur, TX	Refinery expansion	325,000	2010
Sinclair Oil Corp, Tulsa, OK	Refinery expansion	45,000	2011

Source: *Oil and Gas Journal*. November 19, 2007. Worldwide Construction Update.

In particular, several U.S. refineries are planning projects to expand their ability to handle cheaper and lower-quality varieties of crude oil (known as “heavy crudes”). For example, ConocoPhillips will be expanding its capacity to handle heavy crude oils at its refinery in Billings, Montana, to 46,000 barrels per day (Reuters, 2007).

In addition to these expansions, two entirely new refineries could potentially be constructed within the next 5 years. The first is the Arizona Clean Fuels Refinery in Phoenix. This facility will cost \$3 billion to construct and will be capable of producing 6 million gallons of gasoline, diesel, and jet fuel per day (Arizona Clean Fuels, 2007). Second, a proposal to construct the MHA Nation Clean Fuels Refinery in North Dakota is being reviewed. If constructed, this facility will be capable of producing 15,000 barrels of fuel per day (EPA, 2006).

Overall, the EIA forecasts that U.S. operational capacity will increase by a total of 2% between 2007 and 2015 (Table 1-23). However, since consumption of petroleum products is projected to grow much more quickly, the rate of capacity utilization is projected to average 90% during this period.

Table 1-23. Full Production Capacity Utilization Rates for Petroleum Refineries

Year	Petroleum Refineries Capacity Utilization Rates (NAICS 324110)	Gross Input to Atmospheric Crude Oil Distillation Units (1,000s of barrels per day)	Operational Capacity (1,000s of barrels per day)
2007	88.8%	15,630	17,597
2008	88.1%	15,587	17,684
2009	88.6%	15,712	17,737
2010	89.1%	15,879	17,822
2011	89.9%	16,055	17,852
2012	90.9%	16,267	17,897
2013	91.4%	16,378	17,914
2014	91.6%	16,433	17,940
2015	92.2%	16,628	18,031

Source: U.S. Department of Energy, Energy Information Administration (EIA). 2007c. “Annual Energy Outlook.” Available at <[http://www.eia.doe.gov/oiaf/archive/aeo07/pdf/0383\(2007\).pdf](http://www.eia.doe.gov/oiaf/archive/aeo07/pdf/0383(2007).pdf)>. As obtained on January 21, 2007.

1.6 References

- American Petroleum Institute (API). 2006. “FYI on Refineries: Operating at Record Levels.” Available at <http://new.api.org/aboutoilgas/sectors/refining/upload/FYI_Refineries.pdf>. As obtained on October 31, 2006.
- Arizona Clean Fuels. 2007. Company Home Page. Available at <<http://www.arizonacleanfuels.com/>>. As obtained on February 5, 2007.

- Arabian American Development Co. April 6, 2007. 10K for year ended December 31, 2006. EDGAR Database. Available at <<http://www.sec.gov/Archives/edgar/data/7039/000095013407007709/0000950134-07-007709-index.htm>>.
- Calumet Specialty Products Partners. February 23, 2007. 10K for year ended December 31, 2006. EDGAR Database. Available at <<http://www.sec.gov/Archives/edgar/data/1340122/000095013407003992/h43776e10vk.htm>>.
- CVR Energy Inc. 2006. Google Finance. Available at <<http://finance.google.com/finance?q=NYSE:CVI>> As obtained on February 28, 2008.
- Dun & Bradstreet Small Business Solutions. Small Business Database. Available at <<http://smallbusiness.dnb.com/default.asp?bhcd2=1107465546>>.
- Dun & Bradstreet. 2007. *2007 D&B Million Dollar Directory*. Pennsylvania: Dun & Bradstreet Inc.
- Federal Trade Commission (FTC). 2004. “The Petroleum Industry: Mergers, Structural Change, and Antitrust Enforcement.” Available at <<http://www.ftc.gov/opa/2004/08/oilmergersrpt.shtm>>. As obtained on February 6, 2007.
- Gale Research Inc. 2007. Ward’s Business Directory of U S Private and Public Companies. Detroit: Gale Research.
- General Accounting Office (FTC). 2007. “Energy Markets: Factors That Influence Gasoline Prices.” Available at <<http://www.gao.gov/new.items/d07902t.pdf>>. As obtained on February 6, 2007.
- Holly Corporation. March 1, 2007. 10K for year ended December 31, 2006. EDGAR Database. Available at <<http://www.sec.gov/Archives/edgar/data/48039/000095013407004555/d44106e10vk.htm>>.
- Hoovers. 2007. Free Content, Company Information. Available at <<http://www.hoovers.com/free/>>. As obtained on April 11, 2007.
- Langinier, Corrine. 2004. “Are Patents Strategic Barriers to Entry?” *Journal of Economics and Business* 56:349-361.
- MathTech, Inc. 1997. “Industry Profile for the Petroleum Refinery NESHAP.” Available at <[http://www.epa.gov/ttnecas1/regdata/IPs/Petroleum%20Refinery%20\(Sulfur%20Recovery%20Units,%20Catalytic%20Crackin.pdf](http://www.epa.gov/ttnecas1/regdata/IPs/Petroleum%20Refinery%20(Sulfur%20Recovery%20Units,%20Catalytic%20Crackin.pdf)>. As obtained on October 31, 2006.
- Nicholson, Walter. 2005. *Microeconomic Theory: Basic Principles and Extensions*. Mason, OH: South-Western Publishing.

- Oil and Gas Journal. 2007. Worldwide Construction Update. November 19, 2007.
- Risk Management Association (RMA). 2008. Annual Statement Studies 2007-2008. Pennsylvania: RMA, Inc.
- Reuters. July 19, 2007. “U.S. Refinery Expansion Plans.” Available at <<http://uk.reuters.com/article/oilRpt/idUKN199746120070719>>. As obtained on February 5, 2007.
- Small Business Administration. 2006. Table of Small Business Size Standards. Available at <http://www.sba.gov/idc/groups/public/documents/sba_homepage/serv_table_pdf>. As obtained on November 30, 2006.
- U.S. Bureau of Labor Statistics (BLS). 2007. “Producer Price Index Industry Data: Customizable Industry Data Tables.” Available at <<http://www.bls.gov/ppi/>>. As obtained on October 11, 2007.
- U.S. Department of Commerce, Bureau of the Census. 1997. *1995 Annual Survey of Manufactures*. M95(AS)-1. Washington, DC: Government Printing Office. Available at <<http://www.census.gov/prod/2/manmin/asm/m95as1.pdf>>. As obtained on October 23, 2006.
- U.S. Department of Commerce, Bureau of the Census. 1998. *1996 Annual Survey of Manufactures*. M96(AS)-1 (RV). Washington, DC: Government Printing Office. Available at <<http://www.census.gov/prod/3/98pubs/m96-as1.pdf>>. As obtained on October 23, 2006.
- U.S. Department of Commerce, Bureau of the Census. 2000. “Population Density by County: Census 2000 Summary File 1 (SF 1) 100-Percent Data”. Available through American Fact Finder <http://factfinder.census.gov/home/saff/main.html?_lang=en>. As obtained on February 21, 2008.
- U.S. Department of Commerce, Bureau of the Census. 2001. *1999 Annual Survey of Manufactures*. M99(AS)-1 (RV). Washington, DC: Government Printing Office. Available at <<http://www.census.gov/prod/2001pubs/m99-as1.pdf>>. As obtained on October 23, 2006.
- U.S. Department of Commerce, Bureau of the Census. 2003a. *2001 Annual Survey of Manufactures*. M01(AS)-1. Washington, DC: Government Printing Office. Available at <<http://www.census.gov/prod/2003pubs/m01as-1.pdf>>. As obtained on October 23, 2006.
- U.S. Department of Commerce, Bureau of the Census. 2003b. *2001 Annual Survey of Manufactures*. M01(AS)-2. Washington, DC: Government Printing Office. Available at <<http://www.census.gov/prod/2003pubs/m01as-2.pdf>>. As obtained on March 4, 2008.

- U.S. Department of Commerce, Bureau of the Census. 2004. *2002 Economic Census, Industry Series—Petroleum Refineries*. Washington, DC: Government Printing Office. Available at <<http://www.census.gov/prod/ec02/ec0231i324110.pdf>>. As obtained on October 23, 2006.
- U.S. Department of Commerce, Bureau of the Census. 2006. *2005 Annual Survey of Manufactures*. M05(AS)-1. Washington, DC: Government Printing Office. Available at <<http://www.census.gov/prod/2005pubs/am0431gs1.pdf>>. As obtained on October 23, 2006.
- U.S. Department of Commerce, Bureau of the Census. 2007. 2006 Annual Survey of Manufactures. Obtained through American Fact Finder Database <http://factfinder.census.gov/home/saff/main.html?_lang=en>.
- U.S. Department of Energy, Energy Information Administration (EIA). “Petroleum Supply Annuals 1996–2007, Volume 1.” Available at <http://www.eia.doe.gov/oil_gas/petroleum/data_publications/petroleum_supply_annual/psa_volume1/psa_volume1.html>. As obtained on October 31, 2007.
- U.S. Department of Energy, Energy Information Administration (EIA). 2006a. “A Primer on Gasoline Prices.” Available at <<http://www.eia.doe.gov/bookshelf/brochures/gasolinepricesprimer/printerversion.pdf>>. As obtained on October 31, 2007.
- U.S. Department of Energy, Energy Information Administration (EIA). 1999a. “Petroleum: An Energy Profile 1999.” DOE/EIA-0545(99). Available at <<http://tonto.eia.doe.gov/FTPROOT/petroleum/054599.pdf>>. As obtained on October 23, 2006.
- U.S. Department of Energy, Energy Information Administration (EIA). 2006b. “Refinery Capacity Report 2006.” Available at <http://www.eia.doe.gov/oil_gas/petroleum/data_publications/refinery_capacity_data/refcapacity.html>. As obtained on October 23, 2006.
- U.S. Department of Energy, Energy Information Administration (EIA). 2006c. “Petroleum Supply Annual 2005, Volume 1.” Available at <http://www.eia.doe.gov/pub/oil_gas/petroleum/data_publications/petroleum_supply_annual/psa_volume1/historical/2005/psa_volume1_2005.html>. As obtained on October 31, 2007.
- U.S. Department of Energy, Energy Information Administration (EIA). 2007a. “Refinery Utilization and Capacity.” Available at <http://tonto.eia.doe.gov/dnav/pet/pet_pnp_unc_dcu_nus_m.htm>. As obtained on January 7, 2008.
- U.S. Department of Energy, Energy Information Administration (EIA). 2007b. “Refiner Petroleum Product Prices by Sales Type.” Available at <http://tonto.eia.doe.gov/dnav/pet/pet_pri_refoth_dcu_nus_m.htm>. As obtained on January 11, 2008.

- U.S. Department of Energy, Energy Information Administration (EIA). 2007c. “Annual Energy Outlook.” Available at <[http://www.eia.doe.gov/oiaf/archive/aeo07/pdf/0383\(2007\).pdf](http://www.eia.doe.gov/oiaf/archive/aeo07/pdf/0383(2007).pdf)>. As obtained on January 21, 2007.
- U.S. Department of Justice and the Federal Trade Commission. 1992. Horizontal Merger Guidelines. Available at <<http://www.ftc.gov/bc/docs/horizmer.htm>>. As obtained on October 28, 2006.
- U.S. Department of Labor, Occupational Safety and Health Administration (OSHA). 2003. OSHA Technical Manual, Section IV: Chapter 2, Petroleum Refining Processes. TED 01-00-015. Washington, DC: U.S. DOL. Available at <http://www.osha.gov/dts/osta/otm/otm_iv/otm_iv_2.html>. As obtained on October 23, 2006.
- U.S. Environmental Protection Agency. 1995. “EPA Office of Compliance Sector Notebook Project: Profile of the Petroleum Refining Industry.” EPA/310-R-95-013. Washington, DC: U.S. EPA. Available at <<http://www.epa.gov/compliance/resources/publications/assistance/sectors/notebooks/petrefsn.pdf>>. As obtained on October 23, 2006.
- U.S. Environmental Protection Agency. 2006. “Proposed MHA Nation Clean Fuels Refinery.” Available at <<http://www.epa.gov/Region8/compliance/nepa/refinerydeis.html>>. As obtained on February 6, 2007.
- Western Refining, Inc. March 8, 2007. 10K for year ended December 31, 2006. EDGAR Database. Available at <<http://www.sec.gov/Archives/edgar/data/1339048/000095013407005096/h44360e10vk.htm>>.

Appendix A. Parent Company Information for Petroleum Refineries^a

Facility Name	City	State	Capacity (bbl/cd)	Foreign or Domestic	Sales (\$million)	Employment	Company Type (Private or Public or Subsidiary)	Owning Company	Owning Company Type	Sales (\$million)	Employment (#)	Source	Year of Data
AGE Refining & Manufacturing	San Antonio	TX	12,200	D	287	52	Private					D&B	Unknown
Alon USA Energy Inc.	Big Spring	TX	67,000	F			Subsidiary	Alon Israel Oil Company LTD	Private	NA	NA		
American Refining Group	Bradford	PA	10,000	D	350	310	Private					D&B	Unknown
Big West of CA	Bakersfield	CA	66,000	D			Subsidiary	Flying J Inc	Private	11,350	16,300	Hoovers	2007
Big West Oil Co.	Salt Lake City	UT	29,400	D			Subsidiary	Flying J Inc	Private	11,350	16,300	Hoovers	2007
BP	Whiting	IN	410,000	F			Subsidiary	BP PLC	Public	274,316	97,000	Hoovers	2007
BP	Texas City	TX	437,000	F			Subsidiary	BP PLC	Public	274,316	97,000	Hoovers	2007
BP	Prudhoe Bay	AK	12,500	F			Subsidiary	BP PLC	Public	274,316	97,000	Hoovers	2007
BP	Carson	CA	260,000	F			Subsidiary	BP PLC	Public	274,316	97,000	Hoovers	2007
BP	Ferndale	WA	225,000	F			Subsidiary	BP PLC	Public	274,316	97,000	Hoovers	2007
BP	Toledo	OH	131,000	F			Subsidiary	BP PLC	Public	274,316	97,000	Hoovers	2007
Calcasieu Refining Co.	Lake Charles	LA	30,000	D	638	51	Private					D&B	Unknown
Calumet Specialty Products	Shreveport	LA	42,000	D	1,641	350	Public					Hoovers	2006
Calumet Specialty Products	Cotton Valley	LA	13,020	D	1,641	350	Public					Hoovers	2006
Calumet Specialty Products	Princeton	LA	8,300	D	1,641	350	Public					Hoovers	2006
Cenex Harvest States	Laurel	MT	55,000	D	11,900	6,370	Public						
Chevron USA Inc.	Perth Amboy	NJ	80,000	D			Subsidiary	Chevron Corporation	Public	210,118	62,500	Hoovers	2006
Chevron USA Inc.	Salt Lake City	UT	45,000	D			Subsidiary	Chevron Corporation	Public	210,118	62,500	Hoovers	2006
Chevron USA Inc.	Portland	OR		D			Subsidiary	Chevron Corporation	Public	210,118	62,500	Hoovers	2006
Chevron USA Inc.	Pascagoula	MS	330,000	D			Subsidiary	Chevron Corporation	Public	210,118	62,500	Hoovers	2006

(continued)

Appendix A. Parent Company Information for Petroleum Refineries (continued)

Facility Name	City	State	Capacity (bbl/cd)	Foreign or Domestic	Sales (\$million)	Employment	Company Type (Private or Public or Subsidiary)	Owning Company	Owning Company Type	Sales (\$million)	Employment (#)	Source	Year of Data
Chevron USA Inc.	El Segundo	CA	260,000	D			Subsidiary	Chevron Corporation	Public	210,118	62,500	Hoovers	2006
Chevron USA Inc.	Richmond	CA	242,901	D			Subsidiary	Chevron Corporation	Public	210,118	62,500	Hoovers	2006
Chevron USA Inc.	Honolulu (Barber's Point)	HI	54,000	D			Subsidiary	Chevron Corporation	Public	210,118	62,500	Hoovers	2006
Citgo	Corpus Christi	TX	156,000	F			Subsidiary	Petróleos de Venezuela S.A. (PDVSA)	Government Owned	NA	49,180	Hoovers	2004
Citgo Asphalt Refining Co.	Paulsboro	NJ	32,000	F			Subsidiary	Petróleos de Venezuela S.A. (PDVSA)	Government Owned	NA	49,180	Hoovers	2004
Citgo Petroleum	Savannah	GA	28,000	F			Subsidiary	Petróleos de Venezuela S.A. (PDVSA)	Government Owned	NA	49,180	Hoovers	2004
Citgo Petroleum Corp.	Lake Charles	LA	429,500	F			Subsidiary	Petróleos de Venezuela S.A. (PDVSA)	Government Owned	NA	49,180	Hoovers	2004
Coffeyville Resources LLC	Coffeyville	KS	112,000	D	3,038	577	Public	CVR Energy Inc.				Hoovers	2006
ConocoPhillips	Westlake	LA	239,400	D	188,523	38,400	Public					Hoovers	2006
ConocoPhillips	Ponca City	OK	194,000	D	188,523	38,400	Public					Hoovers	2006
ConocoPhillips	Billings	MT	58,000	D	188,523	38,400	Public					Hoovers	2006
ConocoPhillips	Borger	TX	146,000	D	188,523	38,400	Public					Hoovers	2006
ConocoPhillips	Sweeny	TX	247,000	D	188,523	38,400	Public					Hoovers	2006
ConocoPhillips	Ferndale	WA	96,000	D	188,523	38,400	Public					Hoovers	2006
ConocoPhillips	Linden	NJ	238,000	D	188,523	38,400	Public					Hoovers	2006
ConocoPhillips	Wood River	IL	306,000	D	188,523	38,400	Public					Hoovers	2006
ConocoPhillips	LA - Carson/Wilmington	CA	139,000	D	188,523	38,400	Public					Hoovers	2006

(continued)

Appendix A. Parent Company Information for Petroleum Refineries (continued)

Facility Name	City	State	Capacity (bbl/cd)	Foreign or Domestic	Sales (\$million)	Employment	Company Type (Private or Public or Subsidiary)	Owning Company	Owning Company Type	Sales (\$million)	Employment (#)	Source	Year of Data
ConocoPhillips	SF - Rodeo	CA	76,000	D	188,523	38,400	Public					Hoovers	2006
ConocoPhillips	Arroyo Grande (Santa Maria)	CA	44,200	D	188,523	38,400	Public					Hoovers	2006
ConocoPhillips	Belle Chasse	LA	247,000	D	188,523	38,400	Public					Hoovers	2006
ConocoPhillips	Trainer (Marcus Hook)	PA	185,000	D	188,523	38,400	Public					Hoovers	2006
ConocoPhillips	Kuparuk	AK	14,000	D	188,523	38,400	Public					Hoovers	2006
Countrymark Cooperative, Inc.	Mt. Vernon	IN	23,000	D	87	300	Private						
Cross Oil & Refining Co. Inc.	Smackover	AR	7,200	D	49	110	Private						
Delek Refining Ltd	Tyler	TX	58,000	F			Subsidiary	Delek Group LTD	Public	6,237	2,803	Hoovers	2006
Edgington Oil Co.	Long Beach	CA	26,000	F			Subsidiary	Alon Israel Oil Company LTD	Private	NA	NA		
Ergon Refining Inc.	Vicksburg	MS	23,000	D			Subsidiary	Ergon, Inc.	Private	1,300	2,300		
Ergon-West Virginia Inc.	Newell (Congo)	WV	20,000	D			Subsidiary	Ergon, Inc.	Private	1,300	2,300		
ExxonMobil Corp.	Baton Rouge	LA	501,000	D	377,635	82,100	Public					Hoovers	2006
ExxonMobil Corp.	Billings	MT	60,000	D	377,635	82,100	Public					Hoovers	2006
ExxonMobil Corp.	Joliet	IL	238,500	D	377,635	82,100	Public					Hoovers	2006
ExxonMobil Corp.	Beaumont	TX	348,500	D	377,635	82,100	Public					Hoovers	2006
ExxonMobil Corp.	Torrance	CA	149,500	D	377,635	82,100	Public					Hoovers	2006
ExxonMobil Corp.	Chalmette	LA	188,160	D	377,635	82,100	Public					Hoovers	2006
ExxonMobil Oil Corp	Baytown	TX	562,500	D			Subsidiary	ExxonMobil Corp.	Public	377,635	82,100	Hoovers	2006
Flint Hills Resources	Corpus Christi	TX	288,126	D			Subsidiary	Koch Industries Inc	Private	51,500	85,000		
Flint Hills Resources	North Pole	AK	210,000	D			Subsidiary	Koch Industries Inc	Private	51,500	85,000		

(continued)

Appendix A. Parent Company Information for Petroleum Refineries (continued)

Facility Name	City	State	Capacity (bbl/cd)	Foreign or Domestic	Sales (\$million)	Employment	Company Type (Private or Public or Subsidiary)	Owning Company	Owning Company Type	Sales (\$million)	Employment (#)	Source	Year of Data
Flint Hills Resources	Rosemount	MN	279,300	D			Subsidiary	Koch Industries Inc	Private	51,500	85,000		
Foreland Refining Co.	Tonopah/Eagle Springs	NV	2,000	D	56	100	Private					D&B	Unknown
Frontier Oil & Refining Co.	Cheyenne	WY	47,000	D			Subsidiary	Frontier Oil Corp	Private	4,000	727		
Frontier Oil Corp	El Dorado	KS	106,000	D	4,000	727	Private						
Giant Refining Co.	Yorktown	VA	58,600	D			Subsidiary	Western Refining, Inc.	Private	4,200	416	Hoovers	2006
Giant Refining Co.	Bloomfield	NM	16,800	D			Subsidiary	Western Refining, Inc.	Private	4,200	416	Hoovers	2006
Giant Refining Co.	Gallup	NM	20,800	D			Subsidiary	Western Refining, Inc.	Private	4,200	416	Hoovers	2006
Goodway Refining LLC	Atmore	AL	4,100	D	3	18	Private					D&B	Unknown
Greka Integrated Inc	Santa Maria	CA	9,500	D	22	145	Private						
Gulf Atlantic Operations LLC	Mobile Bay	AL	16,700	D	9	32	Private					D&B	Unknown
Hess Corporation	Port Reading	NJ		D	23,200	11,610	Public						
Holly Corp.	Woods Cross	UT	24,700	D	4,023	859	Public					Hoovers	2006
Hunt Refining Co.	Tuscaloosa	AL	34,500	D	4,871	1,100	Private					Ward's	2007
Hunt Southland Refining	Lumberton	MS		D			Subsidiary	Hunt Refining Co.	Private	4,871	1,100	Ward's	2007
Hunt Southland Refining	Sandersville	MS	11,000	D			Subsidiary	Hunt Refining Co.	Private	4,871	1,100	Ward's	2007
Kern Oil & Refining Co.	Bakersfield	CA	26,000	D	NA	NA	Private						
Lion Oil Co.	El Dorado	AR	70,000	D	247	425	Private						
Little America Refining Co.	Evansville (Casper)	WY	24,500	D			Subsidiary	Sinclair Companies	Private	5,500	7,000		
Lunday-Thagard Co.	South Gate	CA	8,500	D			Subsidiary	World Oil Corp	Private	277	475	Hoovers	2007

(continued)

Appendix A. Parent Company Information for Petroleum Refineries (continued)

Facility Name	City	State	Capacity (bbl/cd)	Foreign or Domestic	Sales (\$million)	Employment	Company Type (Private or Public or Subsidiary)	Owning Company	Owning Company Type	Sales (\$million)	Employment (#)	Source	Year of Data
Lyondell-Citgo Refining Co.	Houston	TX	270,200	D			Subsidiary	Lyondell Chemical Co	Public	18,600	10,880		
Marathon Petroleum Co. LLC	Robinson	IL	192,000	D			Subsidiary	Marathon Oil Corp	Public	65,449	28,195	Hoovers	2006
Marathon Petroleum Co. LLC	Catlettsburg	KY	222,000	D			Subsidiary	Marathon Oil Corp	Public	65,449	28,195	Hoovers	2006
Marathon Petroleum Co. LLC	Detroit	MI	100,000	D			Subsidiary	Marathon Oil Corp	Public	65,449	28,195	Hoovers	2006
Marathon Petroleum Co. LLC	Canton	OH	73,000	D			Subsidiary	Marathon Oil Corp	Public	65,449	28,195	Hoovers	2006
Marathon Petroleum Co. LLC	St. Paul Park	MN	70,000	D			Subsidiary	Marathon Oil Corp	Public	65,449	28,195	Hoovers	2006
Marathon Petroleum Co. LLC	Texas City	TX	72,000	D			Subsidiary	Marathon Oil Corp	Public	65,449	28,195	Hoovers	2006
Marathon Petroleum Co. LLC	Garyville	LA	245,000	D			Subsidiary	Marathon Oil Corp	Public	65,449	28,195	Hoovers	2006
Montana Refining Co.	Great Falls	MT	8,200	F			Subsidiary	Connacher Oil and Gas Limited	Public	NA	NA		
Motiva Enterprises	Norco	LA	226,500	D	32,100	2,700	Private						
Motiva Enterprises	Port Arthur	TX	285,000	D	32,100	2,700	Private						
Motiva Enterprises	Convent	LA	235,000	D	32,100	2,700	Private						
Murphy Oil USA Inc.	Superior	WI	34,300	D			Subsidiary	Murphy Oil Corp	Public	14,307	7,296	Hoovers	2006
Murphy Oil USA Inc.	Meraux	LA	120,000	D			Subsidiary	Murphy Oil Corp	Public	14,307	7,296	Hoovers	2006
National Cooperative Refinery Association	McPherson	KS	81,200	D			Subsidiary	Cenex Harvest States	Public	11,900	6,370		
Navajo Refining Co.	Artesia	NM	75,000	D			Subsidiary	Holly Corp.	Public	4,023	859	Hoovers	2006
Paramount Petroleum Corp.	Paramount	CA	50,000	F			Subsidiary	Alon Israel Oil Company LTD	Private	NA	NA		
Pasadena Refining Systems Inc.	Pasadena	TX	100,000	F			Subsidiary	Petroleo Brasileiro, S.A.	Government Owned	72,347	62,266	Hoovers	2006

(continued)

Appendix A. Parent Company Information for Petroleum Refineries (continued)

Facility Name	City	State	Capacity (bbl/cd)	Foreign or Domestic	Sales (\$million)	Employment	Company Type (Private or Public or Subsidiary)	Owning Company	Owning Company Type	Sales (\$million)	Employment (#)	Source	Year of Data
PDV Midwest Refining	Lemont	IL	167,000	F			Subsidiary	Petróleos de Venezuela S.A. (PDVSA)	Government Owned	NA	NA		
Pelican Refining Co. LLC	Lake Charles	LA		D	29	62	Private						
Petro Star Inc.	North Pole	AK	17,000	D			Subsidiary	Arctic Slope Regional Corp	Private	1,500	5,743		
Petro Star Inc.	Valdez	AK	48,000	D			Subsidiary	Arctic Slope Regional Corp	Private	1,500	5,743		
Placid Refining Inc.	Port Allen	LA	56,000	D	1,400	200	Private						
San Joaquin Refining Co., Inc.	Bakersfield	CA	15,000	D	288	20	Private						
Shell Chemical LP	St. Rose	LA	55,000	F			Subsidiary	Royal Dutch Shell, PLC	Public	312,323	108,000	Hoovers	2006
Shell Chemical LP	Saraland	AL	80,000	F			Subsidiary	Royal Dutch Shell, PLC	Public	312,323	108,000	Hoovers	2006
Shell Oil Products US	Anacortes	WA	145,000	F			Subsidiary	Royal Dutch Shell, PLC	Public	312,323	108,000	Hoovers	2006
Shell Oil Products US	Martinez	CA	155,600	F			Subsidiary	Royal Dutch Shell, PLC	Public	312,323	108,000	Hoovers	2006
Shell Oil Products US	Wilmington	CA	98,500	F			Subsidiary	Royal Dutch Shell, PLC	Public	312,323	108,000	Hoovers	2006
Shell Oil Products US - Deer Park Refining Limited Partnership	Deer Park	TX	333,700	F			Subsidiary	Royal Dutch Shell, PLC	Public	312,323	108,000	Hoovers	2006
Silver Eagle Refining Inc.	Evanston	WY	3,000	D	NA	NA	Private						
Silver Eagle Refining Inc.	Woods Cross	UT	10,250	D	NA	NA	Private						
Sinclair Oil Corp.	Tulsa	OK	70,300	D			Subsidiary	Sinclair Companies	Private	5,500	7,000		

(continued)

Appendix A. Parent Company Information for Petroleum Refineries (continued)

Facility Name	City	State	Capacity (bbl/cd)	Foreign or Domestic	Sales (\$million)	Employment	Company Type (Private or Public or Subsidiary)	Owning Company	Owning Company Type	Sales (\$million)	Employment (#)	Source	Year of Data
Sinclair Oil Corp.	Sinclair	WY	66,000	D			Subsidiary	Sinclair Companies	Private	5,500	7,000		
Somerset Refinery Inc.	Somerset	KY	5,500	D			Subsidiary	Somerset Oil Inc	Private	55	150		
South Hampton Resources Inc.	Silsbee	TX		D			Subsidiary	Arabian American Development Co	Public	80	118		
Suncor Energy	Commerce City	CO	62,000	F			Subsidiary	Suncor Energy Inc	Public	13,583	5,152	Hoovers	2006
Suncor Energy	Denver	CO	32,000	F			Subsidiary	Suncor Energy Inc	Public	13,583	5,152	Hoovers	2006
Sunoco, Inc.	Westville	NJ	145,000	D	38,715	14,000	Public					Hoovers	2006
Sunoco, Inc.	Marcus Hook	PA	175,000	D	38,715	14,000	Public					Hoovers	2006
Sunoco, Inc.	Toledo	OH	160,000	D	38,715	14,000	Public					Hoovers	2006
Sunoco, Inc.	Tulsa	OK	85,000	D	38,715	14,000	Public					Hoovers	2006
Sunoco, Inc.	Phil. (Girard Pt & Pt Breeze)	PA	335,000	D	38,715	14,000	Public					Hoovers	2006
Ten By Inc.	Oxnard	CA	2,800		NA	NA							
Tesoro	Mandan	ND	58,000	D			Subsidiary	Tesoro Corp	Public	18,104	3,950	Hoovers	2006
Tesoro	Salt Lake City	UT	58,000	D			Subsidiary	Tesoro Corp	Public	18,104	3,950	Hoovers	2006
Tesoro	Anacortes	WA	120,000	D			Subsidiary	Tesoro Corp	Public	18,104	3,950	Hoovers	2006
Tesoro	Golden Eagle	CA	166,000	D			Subsidiary	Tesoro Corp	Public	18,104	3,950	Hoovers	2006
Tesoro	Kapolei	HI	93,500	D			Subsidiary	Tesoro Corp	Public	18,104	3,950	Hoovers	2006
Tesoro	Kenai	AK	72,000	D			Subsidiary	Tesoro Corp	Public	18,104	3,950	Hoovers	2006
Total SA	Port Arthur	TX	232,000	F	175,189	95,070	Public					Hoovers	2005
Trigeant Ltd.	Corpus Christi	TX		D	5	50	Private					D&B	Unknown
United Refining Co.	Warren	PA	65,000	D			Subsidiary	Red Apple Group Inc	Private	4,200	7,000		
US Oil & Refining Co.	Tacoma	WA	37,850		NA	NA							
Valero Energy	Corpus Christi	TX	142,000	D	91,833	21,836	Public					Hoovers	2006

(continued)

Appendix A. Parent Company Information for Petroleum Refineries (continued)

Facility Name	City	State	Capacity (bbl/cd)	Foreign or Domestic	Sales (\$million)	Employment	Company Type (Private or Public or Subsidiary)	Owning Company	Owning Company Type	Sales (\$million)	Employment (#)	Source	Year of Data
Valero Energy	Houston	TX	83,000	D	91,833	21,836	Public					Hoovers	2006
Valero Energy	Texas City	TX	213,750	D	91,833	21,836	Public					Hoovers	2006
Valero Energy	Krotz Springs	LA	80,000	D	91,833	21,836	Public					Hoovers	2006
Valero Energy	Benicia	CA	144,000	D	91,833	21,836	Public					Hoovers	2006
Valero Energy	Wilmington	CA	6,200	D	91,833	21,836	Public					Hoovers	2006
Valero Energy	Norco	LA	185,003	D	91,833	21,836	Public					Hoovers	2006
Valero Energy	Delaware City	DE	181,500	D	91,833	21,836	Public					Hoovers	2006
Valero Energy	Lima	OH	146,900	D	91,833	21,836	Public					Hoovers	2006
Valero Energy	Memphis	TN	180,000	D	91,833	21,836	Public					Hoovers	2006
Valero Energy	Three Rivers	TX	90,000	D	91,833	21,836	Public					Hoovers	2006
Valero Energy	Sunray	TX	158,327	D	91,833	21,836	Public					Hoovers	2006
Valero Energy	Ardmore	OK	83,640	D	91,833	21,836	Public					Hoovers	2006
Valero Energy	Wilmington	CA	80,887	D	91,833	21,836	Public					Hoovers	2006
Valero Energy	Paulsboro	NJ	160,000	D	91,833	21,836	Public					Hoovers	2006
Valero Energy	Port Arthur	TX	260,000	D	91,833	21,836	Public					Hoovers	2006
Western Refining, Inc.	El Paso	TX	116,000	D	4,200	416	Public					Hoovers	2006
Wynnewood Refining Co.	Wynnewood	OK	54,000	D	97	200	Subsidiary	Gary-Williams Co	Private				

Note: All data were collected from the 2007 D&B Million Dollar Direction unless noted other wise. Data collected from the 2006 D&B Small Business Database are indicated using "D&B" in the source column. Data collected from Ward's Business Directory are identified using "Ward's" in the source column.

^aThese data are shown with the permission of D&B.

Sources: Dun & Bradstreet. 2007. *2007 D&B Million Dollar Directory*. Pennsylvania: Dun & Bradstreet Inc.

Dun & Bradstreet Small Business Solutions. Small Business Database. Available at <<http://smallbusiness.dnb.com/default.asp?bhcd2=1107465546>>.

Gale Research Inc. 2007. *Ward's Business Directory of U S Private and Public Companies*. Detroit: Gale Research.

Hoovers. 2007. Free Content, Company Information. Available at <<http://www.hoovers.com/free/>>. As obtained on April 11, 2007.

2.0 Requirements for the Final Rule

2.1 Introduction

The current National Emissions Standard for Hazardous Air Pollutant (NESHAP) from Petroleum Refineries (40 CFR Part 63 Subpart CC) applies to miscellaneous process vents, storage vessels, wastewater streams, equipment leaks, gasoline loading racks, and marine vessel loading operations, and is commonly referred to as Refinery MACT 1. Based on this review, the final amendments add requirements for monitoring for leaks in heat exchange systems to reduce HAP emissions from these sources.

2.2 Heat Exchange System Monitoring Requirements

The final amendments add provisions for the control of HAP emissions from heat exchange systems, which includes closed-loop recirculation systems with cooling towers and once-through cooling water systems. Under these requirements, owners and operators of heat exchange systems that are in organic HAP service at new and existing sources are required to conduct monthly sampling and analyses using the Texas Commission on Environmental Quality's (TCEQ) Modified El Paso method, Revision Number One, dated January 2003.³ For existing sources, a leak is defined as 6.2 parts per million by volume (ppmv) total strippable VOC in the stripping gas collected via the Modified El Paso method. For new sources, a leak is defined as 3.1 ppmv total strippable VOC collected via the Modified El Paso method. The amendments require the repair of leaks in heat exchangers in organic HAP service within 45 days of the sampling event in which the leak is detected, unless a delay in repair is allowed. Delay in repair of the leak is allowed until the next shutdown if the repair of the leak requires the process unit served by the leaking heat exchanger to be shut down and the total strippable VOC concentration is less than 62 ppmv. Delay in repair of the leak is also allowed for up to 120 days if the total strippable VOC concentration is less than 62 ppmv and if critical parts or personnel are not available. During the delay, the owner or operator is required to continue monthly monitoring and to repair the heat exchanger within 30 days if sampling results

³ "Air Stripping Method (Modified El Paso Method) for Determination of Volatile Organic Compound Emissions from Water Sources," Revision Number One, dated January 2003, Sampling Procedures Manual, Appendix P: Cooling Tower Monitoring, prepared by Texas Commission on Environmental Quality, January 31, 2003 (incorporated by reference—see §63.14).

show that the leak exceeds 62 ppmv total strippable VOC.

All new or existing refineries with a heat exchange system “in organic HAP service” are required to maintain records of all heat exchangers and which of those heat exchangers are in organic HAP service, the cooling towers and once-through systems associated with heat exchangers in organic HAP service, monthly monitoring results, and information for any delays in repair of a leak.

The final requirements for heat exchange systems will reduce HAP emissions from cooling towers by 630 ton/yr, and will also reduce VOC emissions by 4,100 ton/yr. Reducing VOC emissions provides the added benefit of reducing ambient concentrations of ozone and may reduce fine particulate matter. The annualized nationwide cost impacts of these final standards for heat exchange systems are estimated to be \$3.0 million.

2.4 Other Amendments and Clarifications

The final amendments also clarify certain aspects of the existing NESHAP. For example, 40 CFR 63.650(a) of subpart CC is amended to replace “gasoline loading racks” with “Group 1 gasoline loading racks” to clarify the applicability of the requirements, and cross-references to subparts R and Y of 40 CFR part 63 in the rule text and in Tables 4 and 5 of subpart CC are amended because subparts R and Y were amended and the revised cross-references clarify the requirements of subpart CC.

The final amendments include revisions to Table 6 to 40 CFR part 63, subpart CC (General Provisions Applicability to Subpart CC) to bring the table up to date with requirements of the General Provisions that have been amended since this table was created, to correct cross references, and to incorporate additional sections of the General Provisions that are necessary to implement other subparts that are cross referenced by this rule.

These amendments effectively clarify the requirements of the existing NESHAP and are not expected to result in additional costs to the refinery.

2.5 Cost Summary

The total capital investment cost of the final amendments is estimated at \$16 million. The controls required by the final amendments are expected to yield a net savings of \$3.0 million (2007 dollars) in the total annualized cost, which includes \$2.2

million credit for recovery of lost product and the annualized cost of capital. The final amendments will achieve a nationwide HAP emission reduction of about 630 ton/yr with a concurrent reduction in VOC emissions of about 4,700 ton/yr. Table 2-1 summarizes the cost and emission reduction impacts of the final standards and amendments.

Table 2-1. Nationwide Impacts to Heat Exchange Systems

Affected source	Total capital investment (\$ million)	Total annualized cost without recovery (\$ million)	Product recovery credit (\$ million)	Total annualized costs (\$ million/ yr)	HAP emission reductions (ton/yr)	Cost-effectiveness (\$/ton HAP)
Heat Exchangers	16	5.2	(2.2)	3.0	630	4,700

3.0 Details on Costs and Emission Reductions for Regulatory Options Considered in the Final Rule

3.1 Heat Exchange System Impacts

Nationwide impacts were developed based on the nationwide number of heat exchange systems and the proportion of heat exchange systems represented by each model plant. Detailed information on the number of heat exchange systems and the proportion represented by model plant can be found in the memorandum containing the impacts of heat exchange system control options that is in the rulemaking docket.⁴ Based on facility-specific crude capacities (EIA, 2006), we estimated that there would be 540 heat exchange systems that receive cooling water from at least one heat exchanger in HAP service, that approximately 10 percent are already conducting heat exchange system monitoring sufficient to comply with the rule, and that 486 heat exchange systems would need to implement the heat exchange system monitoring requirements. The model plant baseline emissions were multiplied by the number of heat exchange systems represented by each model plant to develop the nationwide baseline emissions. Table 3-1 summarizes the nationwide baseline emission estimate.

⁴ U.S. Environmental Protection Agency. "Cooling Towers: Control Alternatives and Impact Estimates." Memorandum from Bob Lucas, U.S. EPA/OAQPS to Docket No. EPA-HQ-OAR-2003-0146. October, 2008.

Table 3-1. Nationwide Baseline Emissions for Refinery Heat Exchange Systems

Model Plant Flow rate, gpm	Percent of total, %	Nationwide No. of heat exchange systems in the leak size range	No. that would need to implement requirements	Baseline Emissions, TO HAP, ton/yr
Model Plant 1: 5,000	38.9	210	190	46
Model Plant 2: 15,500	28.9	160	140	100
Model Plant 3: 42,000	28.9	160	140	280
Model Plant 4: 105,000	3.4	18	16	82
Totals*	100%	540	486	520

*Totals may not match reported value column totals due to rounding.

Nationwide emissions associated with monitoring of heat exchange system leaks (i.e., controlled basis following implementation of monitoring) were likewise estimated based on assumptions regarding the length of time of the leak and the number of heat exchange system leaks that are repaired as soon as possible (50 percent) and the number that delay repair (50 percent). The nationwide emissions reductions were estimated as the difference between the baseline and controlled emissions levels.

Nationwide cost impacts for conducting heat exchange system monitoring for the three alternatives evaluated were estimated based on the control alternative unit costs and the number of heat exchange systems nationwide that must implement heat exchange system monitoring requirements to comply with the rule.

Table 3-2 provides a summary of the nationwide impacts. The nationwide emissions reductions and costs presented in Table 3-2 are expected to span the ranges of cost-effectiveness for the different control alternatives.

Total annual costs and nationwide impacts were also considered using VOC emission reduction credits. Heat exchange system monitoring reduces loss of products from heat exchangers and cooling towers. Therefore, the product not lost as a result can be sold, and the monitoring costs are offset, to some extent, by the increased product sales. The VOC credit was calculated assuming the value of VOC to be \$1.75/gallon, based on

average crude and gasoline spot prices in 2007⁵. Assuming an average refinery process stream specific gravity of 0.75, the VOC credit is \$560 per ton VOC reduced. Table 3-3 provides a summary of the nationwide impacts considering VOC emission reduction credits.

Table 3-2. Summary of Nationwide Impacts of Refinery Heat Exchange System Regulatory Alternatives (without VOC emission reduction credits)

Alternative	Total capital investment, million \$/yr ^a	Total Annualized Costs, million \$/yr	Emission Reduction, TO HAP tpy	Cost effectiveness, \$/ton TO HAP	Incremental cost effectiveness, \$/ton
MACT Floor	\$11	\$4.6	430	\$10,700	NA
Alternative 1	\$11	\$4.9	450	\$10,900	\$14,600
Alternative 2	\$55	\$12	460	\$25,400	\$1,030,000

Table 3-3. Summary of Nationwide Impacts of Refinery Heat Exchange System Regulatory Alternatives, with VOC Emission Reduction Credits

Alternative	Total capital investment, million \$/yr ^a	Total Annualized Costs, with VOC credits, million \$/yr	Emission Reduction, TO HAP tpy	Cost effectiveness, with VOC credits \$/ton TO HAP	Incremental cost effectiveness, with VOC credits, \$/ton
MACT Floor	\$11	\$2.3	430	\$5,300	NA
Alternative 1	\$11	\$2.5	450	\$5,500	\$8,750
Alternative 2	\$55	\$9.1	460	\$20,000	\$1,020,000

4.0 Economic and Small Business Impact Analysis – Background Information

The costs presented in this section are calculated based on the control cost methodology presented in the EPA (2002) Air Pollution Control Cost Manual prepared by the U.S. Environmental Protection Agency.⁶ This methodology sets out a procedure by which capital and annualized costs are defined and estimated, and this procedure is often used to estimate the costs of rulemakings such as this one. The capital costs presented in this section are annualized using a 7% interest rate, a rate that is consistent with the

⁵ Based on September 7, 2007 crude oil crack spread spot prices of \$74.96/bbl (\$1.78/gal) for Brent crude and \$87.04/bbl (\$2.08/gal) for product value per barrel; as reported in *Oil and Gas Journal*, September 17, 2007, p. 90.

⁶ U.S. Environmental Protection Agency (EPA) Air Pollution Control Cost Manual. Section 1, Chapter 2. EPA-452/B-02-001. July 2002. Available on the Internet at <http://epa.gov/ttn/catc/products.html#cccinfo>

guidance provided in the Office of Management and Budget's (OMB's) Circular A-4 issued in 2003.⁷ The annualized compliance costs of the final rule are \$3.0 million (2007 dollars). A reduction in product losses of \$2.2 million (2007 dollars) is included in the annualized compliance cost total. The HAP emission reductions for this final rule are estimate at 630 tons per year and VOC emission reductions are estimated at 4,700 tons per year

There are two likely reasons why the savings in costs from reduced product losses are reasonable and credible.

1) The rates of return for capital investments in the refinery industry have been relatively low for a long period of time.

Rates of return on investment in the refinery industry have averaged about 5.5% from 1993-2002.⁸ The refinery industry has, until recently, experienced relatively low profits as part of their operations as shown by the profit margin data provided earlier in Section 1.5.5 of this report. This is due to the capital intensive nature of their operations and a high barrier to entry. Hence, there has been little incentive for refineries to invest in greater capacity until recently. With the recent increase in profits per barrel of oil refined, this has begun to change. However, refineries may be slow to invest further in new capacity or to upgrade existing equipment given that high profitability for refined product is a recent phenomenon that could change in the future. Also, the DOE/EIA assumes a 9% after-tax rate of return on investments for capacity expansion as part of their modeling of energy production in preparing their Annual Energy Outlook forecasts (<http://www.eia.doe.gov/oiaf/aeo/assumption/introduction.html> , at p. 5). Thus, historically low returns on capital investments may lead refineries to be cautious with investing further in their facilities even if the expected return is positive.

2) There has been limited ability until recently to measure emissions from particular source categories such as heat exchange systems; hence, there has

⁷ U.S. Office of Management and Budget. Circular A-4. Issued on September 17, 2003. Available on the Internet at <http://www.whitehouse.gov/omb/circulars/a004/a-4.html>.

⁸ National Petroleum Refiners Association. Written Statement for the U.S. House of Representatives, Committee on Government Reform, Subcommittee on Energy and Resources. October 19, 2005. Available on the Internet at <http://www.npra.org/news/testimony/NPRATestimony&Attachments10-19-05.pdf>

been little understanding of the possible returns to refinery owners from reducing leaks from this category.

5.0 Small Business and Economic Impacts

5.1 Small Business Impacts

The Regulatory Flexibility Act generally requires an agency to prepare a regulatory flexibility analysis of any rule subject to notice and comment rulemaking requirements under the Administrative Procedure Act or any other statute unless the agency certifies that the rule will not have a significant economic impact on a substantial number of small entities. Small entities include small businesses, small organizations, and small governmental jurisdictions.

For the purposes of assessing the impacts of this rule on small entities, small entity is defined as: (1) a small business that meets the Small Business Administration (SBA) size standards for small businesses at 13 CFR 121.201 (a firm having no more than 1,500 employees; (2) a small governmental jurisdiction that is a government of a city, county, town, school district, or special district with a population of less than 50,000; and (3) a small organization that is any not-for-profit enterprise which is independently owned and operated and is not dominant in its field.

After considering the economic impacts of this rule on small entities, I certify that this action will not have a significant economic impact on a substantial number of small entities. Based on our economic impact analysis, the final amendments will result in a nationwide annualized costs of about \$3.0 million that includes \$2.2 million per year from reductions in product losses previously mentioned in this report. Of the 24 small refinery-owned entities affected by this final rule, no affected small entity will incur an impact of an annualized compliance cost of greater than 0.02 percent of its revenue; therefore, no “significant” adverse economic impacts are expected for any small entity. Thus, the costs associated with the final amendments will not result in any “significant” adverse economic impact for any small entity. For more information, please refer to the economic impact analysis that is in the docket for this rulemaking.

Although the final rule will not have a significant economic impact on a substantial number of small entities, we nonetheless tried to reduce the impact of the rule

on small entities. We held meetings with industry trade associations and company representatives to discuss the rule and received comments from them, and have responded by making revisions that would reduce impacts to small entities.

5.2 Economic Impacts

For economic impacts on all firms and consumers, all of the 58 firms that own an affected refinery (or more) are estimated to have positive compliance costs associated with the rule. However, no affected refinery-owned firm will incur an annualized compliance cost from this rule of no more than 0.02 percent in 2012 (the year of full implementation for the final rule).

The screening analysis employed here is a “sales test” that computes the annualized compliance costs as a share of sales for each affected company. The “sales test” is the impact methodology EPA employs in analyzing small entity impacts. The use of a “sales test” for estimating small business impacts for a rulemaking such as this one is consistent with guidance offered by EPA on compliance with SBREFA,⁹ and is consistent with guidance published by the US SBA’s Office of Advocacy that suggests that cost as a percentage of total revenues is a metric for evaluating cost increases on small entities in relation to increases on large entities.¹⁰ All other firms are estimated to experience annualized costs ranging from \$17,950 to \$291,507. Given that these cost estimates are quite low relative to firm revenues, and that as mentioned earlier in section 1.0 of this report that petroleum products such as gasoline have very low price elasticities of demand associated with them, then the economic impacts on consumer and producers, both small and large refineries as defined by the SBA, associated with this final rule should be minimal. More information on the costs per refinery can be found in the options and impacts memoranda for each source type that are available in the public docket for this rule.

⁹ The SBREFA compliance guidance to EPA rulewriters regarding the types of small business analysis that should be considered can be found at <http://www.epa.gov/sbrefa/documents/rfafinalguidance06.pdf> , pp. 24-25.

¹⁰ U.S. SBA, Office of Advocacy. A Guide for Government Agencies, How to Comply with the Regulatory Flexibility Act, Implementing the President’s Small Business Agenda and Executive Order 13272, May 2003.

United States Environmental Protection Agency	Office of Air Quality Planning and Standards Health and Environmental Impacts Division Research Triangle Park, NC	EPA-452/R-09-005 May, 2009
--	---	-------------------------------
