



**EVALUATION OF EMISSIONS
FROM THE
OPEN BURNING OF HOUSEHOLD WASTE IN BARRELS**

Volume 1. Technical Report

control *technology center*



FOREWORD

The U.S. Environmental Protection Agency is charged by Congress with protecting the Nation's land, air, and water resources. Under a mandate of national environmental laws, the Agency strives to formulate and implement actions leading to a compatible balance between human activities and the ability of natural systems to support and nurture life. To meet this mandate, EPA's research program is providing data and technical support for solving environmental problems today and building a science knowledge base necessary to manage our ecological resources wisely, understand how pollutants affect our health, and prevent or reduce environmental risks in the future.

The National Risk Management Research Laboratory is the Agency's center for investigation of technological and management approaches for reducing risks from threats to human health and the environment. The focus of the Laboratory's research program is on methods for the prevention and control of pollution to air, land, water, and subsurface resources; protection of water quality in public water systems; remediation of contaminated sites and groundwater; and prevention and control of indoor air pollution. The goal of this research effort is to catalyze development and implementation of innovative, cost-effective environmental technologies; develop scientific and engineering information needed by EPA to support regulatory and policy decisions; and provide technical support and information transfer to ensure effective implementation of environmental regulations and strategies.

This publication has been produced as part of the Laboratory's strategic long-term research plan. It is published and made available by EPA's Office of Research and Development to assist the user community and to link researchers with their clients.

E. Timothy Oppelt, Director
National Risk Management Research Laboratory

EPA REVIEW NOTICE

This report has been peer and administratively reviewed by the U.S. Environmental Protection Agency, and approved for publication. Mention of trade names or commercial products does not constitute endorsement or recommendation for use.

This document is available to the public through the National Technical Information Service, Springfield, Virginia 22161.

**EVALUATION OF EMISSIONS FROM THE
OPEN BURNING OF HOUSEHOLD WASTE IN BARRELS**

Volume 1. Technical Report

Prepared by:

Paul M. Lemieux
U.S. Environmental Protection Agency
National Risk Management Research Laboratory
Air Pollution Prevention and Control Division
Research Triangle Park, NC 27711

Prepared in Cooperation with:

New York State Department of Health
Bureau of Toxic Substances Assessment
and
New York State Department of Health
Wadsworth Center for Laboratories and Research
Albany, NY 12202

Prepared for:

U.S. Environmental Protection Agency
Office of Research and Development
Washington, D.C. 20460

ABSTRACT

A detailed emissions characterization study was undertaken to examine, characterize, and quantify emissions from the simulated burning of household waste materials in barrels. This study evaluated two separate waste streams: that of an avid recycler, who removes most of the recyclable content from the waste stream prior to combustion; and that of a non-recycler, who combusts the entire stream of household waste. Estimated emissions were developed in units of mass emitted per mass of waste burned. Continuous gas samples were analyzed for oxygen, carbon dioxide, carbon monoxide, nitric oxide, and total hydrocarbons. Gas-phase samples were collected using SUMMA® canisters and analyzed by gas chromatography/mass spectrometry (GC/MS) for volatile organic compounds (VOCs). Extractive samples from the combined particulate- and gas-phase were analyzed for semivolatile organic compounds (SVOCs), polycyclic aromatic hydrocarbons (PAHs), polychlorinated biphenyls (PCBs), chlorobenzenes (CBs), polychlorinated dibenzo-*p*-dioxins and polychlorinated dibenzofurans (PCDDs/PCDFs), aldehydes and ketones, hydrogen chloride (HCl), hydrogen cyanide (HCN), and metals. Emissions of PM₁₀ and PM_{2.5} were also measured. Ash residue samples were analyzed for SVOCs, PCBs, PCDDs/PCDFs, and metals.

It was found that for most of the non-chlorinated compounds, including VOCs, SVOCs, PAHs, and aldehydes and ketones, emissions from the non-recycler were higher, both on a per mass burned basis and on a per day basis (using waste generation estimates from New York State). However, emissions of many of the chlorinated organics, particularly CBs and PCDDs/PCDFs, were higher from the avid recycler, on a per mass burned basis. From estimates of waste generated each day by New York households for the avid recycler and non-recycler scenarios, emissions per day of PCDDs/PCDFs are significantly higher for the avid recycler. Emissions of PCBs were higher from the non-recycler, although the cause of this phenomenon is not known. This phenomenon is likely due to several factors, including the higher mass fraction of PVC in the avid recycler's waste. It is also possible that some component of the non-recycler's waste may potentially serve to poison the metallic catalysts believed to be responsible for enhancing formation rates of PCDDs/PCDFs. Results from HCl sampling indicated much higher HCl emissions from the avid recycler, which is consistent with the higher emissions of chlorinated organics, and ash residue analysis indicated that the avid recycler's residue had more copper, which could contribute to higher emissions of PCDDs/PCDFs. It was noted that the temperature at the base of the burning bed was significantly lower in the case of the avid recycler than it was for the non-recycler. Gas-phase emissions of metals were not a strong function of the test conditions. PM emissions were much higher from the non-recycler. Almost all of the PM emissions from both test conditions were < 2.5 μm in diameter.

TABLE OF CONTENTS

ABSTRACT.....	ii
LIST OF TABLES.....	iv
LIST OF FIGURES.....	v
PREFACE.....	vi
ACKNOWLEDGMENTS.....	vi
TABLE OF METRIC EQUIVALENTS.....	vii
1.0 Introduction.....	1
2.0 Experimental Approach.....	5
2.1 Summary of Objectives and Experimental Approach.....	5
2.2 Open Burning Simulation Facility.....	8
2.2.1 Burn Hut.....	9
2.2.2 Sample Shed	11
2.2.3 Hazardous Air Pollutants Mobile Laboratory (HAPML).....	12
2.3 Test Procedures.....	12
2.4 Sampling and Analysis Methods.....	12
2.4.1 CEMs and Thermocouples.....	12
2.4.2 Volatile Organic Sampling and Analysis.....	13
2.4.3 Dichotomous Sampling for Total PM ₁₀ and PM _{2.5} Particulate.....	13
2.4.4 Particulate/Semivolatile Organic Sampling and Analysis.....	14
2.4.5 Particulate- and Vapor-Phase Metals Sampling and Analysis	15
2.4.6 Particulate- and Vapor-Phase PCDDs/PCDFs Sampling and Analysis.....	15
2.4.7 Ash Analysis.....	16
2.4.8 Acid Gas Sampling and Analysis.....	16
2.4.9 Aldehyde and Ketone Sampling and Analysis.....	17
2.5 Data Processing.....	17
3.0 Data, Results, and Discussion.....	18
3.1 Continuous Measurement Results.....	18
3.2 Volatile Organic Compound Analytical Results.....	33
3.3 Semivolatile Organic Compound Analytical Results.....	37
3.4 Chlorobenzene Analytical Results.....	44
3.5 Polycyclic Aromatic Hydrocarbon Analytical Results.....	46
3.6 Aldehyde and Ketone Analytical Results.....	47
3.7 Particulate- and Vapor-Phase PCDDs/PCDFs Analytical Results.....	49
3.8 Polychlorinated Biphenyl Analytical Results.....	50
3.9 PM ₁₀ and PM _{2.5} Particulate Results.....	52
3.10 Particulate- and Vapor-Phase Metals Analytical Results.....	53
3.11 Acid Gas Analytical Results.....	54
3.12 Ash Residue Analytical Results.....	55
3.13 Uncertainties and Limitations.....	55
4.0 Summary and Conclusions.....	61
5.0 References.....	67
APPENDICES A-G.....	Vol. 2

LIST OF TABLES

Table 1-1. Measurements of Gerstle and Kemnitz.....	3
Table 2-1. Composition of household waste prepared by EPA (based on a characterization of household waste prepared by the NYSDEC).....	6
Table 2-2. Composition of material used on each test day.....	7
Table 3-1. Mass of waste burned during testing.....	18
Table 3-2. Estimated emissions of targeted volatile organic compounds, mg/kg.....	34
Table 3-3. Estimated emissions of tentatively identified VOC compounds, mg/kg.....	36
Table 3-4. Estimated emissions of semivolatile organics as analyzed by Acurex, g/kg.....	37
Table 3-5. Estimated emissions of semivolatile organics as analyzed by NYSDOH , g/kg.....	40
Table 3-6. Estimated emissions of chlorobenzenes, g/kg.....	45
Table 3-7. Estimated emissions of PAHs, mg/kg.....	46
Table 3-8. Estimated emissions of aldehydes and ketones, g/kg.....	48
Table 3-9. Estimated emissions of PCDDs/PCDFs, mg/kg.....	49
Table 3-10. Estimated emissions of PCBs, mg/kg.....	51
Table 3-11. Estimated emissions of particulate matter, g/kg.....	52
Table 3-12. Estimated emissions of gaseous mercury, g/kg.....	53
Table 3-13. Estimated emissions of particulate-phase metals, g/kg.....	54
Table 3-14. Estimated emissions of acid gases, g/kg.....	55
Table 3-15. SVOC concentration in composite ash sample, µg/kg ash.....	57
Table 3-16. PCDD/PCDF concentration in composite ash sample, pg/g of ash.....	58
Table 3-17. PCB concentration in composite ash sample, ng/g of ash.....	59
Table 3-18. Metal concentration in composite ash sample, mg/kg.....	60
Table 4.1. Comparison between open burning of household waste and controlled combustion of municipal waste in a municipal waste combustor.....	62
Table 4-2. Number of open-burning households to equal the pollution from a full-scale MWC facility.....	64
Table 4-3. Which test condition resulted in higher emissions?.....	65
Table 4-4. Summary of all test data.....	66

LIST OF FIGURES

Figure 2-1. Plan view of open burning simulation facility.....	8
Figure 2-2. Diagram of burn hut.....	10
Figure 2-3. Plan view of burn hut showing sampling locations.....	11
Figure 3-1. Fraction of initial mass combusted.....	19
Figure 3-2. O ₂ Results from Test 1.....	19
Figure 3-3. CO ₂ Results from Test 1.....	20
Figure 3-4. CO Results from Test 1.....	20
Figure 3-5. THC Results from Test 1.....	21
Figure 3-6. NO Results from Test 1.....	21
Figure 3-7. Burn Mass Results from Test 1.....	22
Figure 3-8. Temperature Results from Test 1.....	22
Figure 3-9. O ₂ Results from Test 2.....	23
Figure 3-10. CO ₂ Results from Test 2.....	23
Figure 3-11. CO Results from Test 2.....	24
Figure 3-12. THC Results from Test 2.....	24
Figure 3-13. NO Results from Test 2.....	25
Figure 3-14. Burn Mass Results from Test 2.....	25
Figure 3-15. Temperature Results from Test 2.....	26
Figure 3-16. O ₂ Results from Test 4.....	26
Figure 3-17. CO ₂ Results from Test 4.....	27
Figure 3-18. CO Results from Test 4.....	27
Figure 3-19. THC Results from Test 4.....	28
Figure 3-20. NO Results from Test 4.....	28
Figure 3-21. Burn Mass Results from Test 4.....	29
Figure 3-22. Temperature Results from Test 4.....	29
Figure 3-23. O ₂ Results from Test 5.....	30
Figure 3-24. CO ₂ Results from Test 5.....	30
Figure 3-25. CO Results from Test 5.....	31
Figure 3-26. THC Results from Test 5.....	31
Figure 3-27. NO Results from Test 5.....	32
Figure 3-28. Burn Mass Results from Test 5.....	32
Figure 3-29. Temperature Results from Test 5.....	33
Figure 3-30. Average emissions of selected target VOCs.....	35
Figure 3-31. Average emissions of selected target SVOCs.....	44
Figure 3-32. Chlorobenzene summary.....	45
Figure 3-33. PAH Summary.....	47
Figure 3-34. Aldehyde and ketone summary.....	48
Figure 3-35. PCDDs/PCDFs data summary.....	50
Figure 3-36. Particulate matter data.....	52
Figure 4-1. Comparison between open burning and controlled combustion.....	63

PREFACE

The CTC was established by EPA's Office of Research and Development (ORD) and Office of Air Quality Planning and Standards (OAQPS) to provide technical assistance to state and local air pollution control agencies. Three levels of assistance can be accessed through the CTC. First, a CTC HOTLINE (919-541-0800) has been established to provide telephone assistance on matters relating to air pollution control technology. Second, more in-depth engineering assistance can be provided when appropriate. Third, the CTC can provide technical guidance through publication of technical guidance documents, development of personal computer software, and presentation of workshops on control technology matters. The technical guidance projects, such as this one, focus on topics of national or regional interest that are identified through contact with state and local agencies.

ACKNOWLEDGEMENTS

The author would like to acknowledge the contributions of the following people, who contributed significantly to the authorship of this report: Christopher Lutes and Matthew Pavlik of Acurex Environmental, who performed the testing and wrote most of the introductory and experimental sections; Judith Johnson from NYSDOH, who helped plan and execute the tests, and helped write a significant portion of the report; and Kenneth Aldous and Haider Khwaja of WCL&R, who oversaw much of the analytical work and wrote the analytical reports and QA case narrative for their portion of the study.

The author would like to acknowledge the contributions of Peter Kariher, Chris Pressley, Jeff Quinto, Ann Drago, Jarek Karwowski, Mike Bowling, and Mitch Howell of Acurex Environmental. Jeff Ryan also contributed to this project both with Acurex Environmental and later with the U.S. EPA. We would also like to acknowledge the contributions of Ben Pierson, of the New York State Department of Environmental Conservation, Division of Solid and Hazardous Waste, Bureau of Waste Reduction and Recycling, who provided information about the components of waste for the avid recycler and the non-recycler.

TABLE OF METRIC EQUIVALENTS

$$1 \text{ gal} = 0.1337 \text{ ft}^3 = 0.0038 \text{ m}^3$$

$$1 \text{ ton} = 2000 \text{ lb} = 907.1 \text{ kg}$$

$$1 \text{ lb} = 0.4536 \text{ kg}$$

$$1 \text{ bushel} = 1.2445 \text{ ft}^3 = 0.0352 \text{ m}^3$$

$$1 \text{ in} = 2.54 \text{ cm} = 0.0254 \text{ m}$$

SECTION 1.0 INTRODUCTION

In many areas of the country, residential solid waste disposal practices consist of open-burning using barrels or other similar devices instead of, or in addition to, disposal to municipal landfills or municipal solid waste combustors. The motivations for households that open-burn their garbage may include convenience, habit, or landfill and cost avoidance.¹ Some communities have regulations which ban the open burning of garbage.

Emissions from backyard burning of residential solid waste are released at ground level resulting in decreased dilution by dispersion. Additionally, the low combustion temperature and oxygen-starved conditions associated with backyard burning may result in incomplete combustion and increased pollutant emissions. In contrast, modern refuse combustors have tall stacks, specially designed combustion chambers, and high efficiency flue gas cleaning systems, which serve to minimize the risk of waste combustion.

Limited data are available for evaluating pollutant emissions from the backyard burning of residential solid waste. A survey of the literature identified few published studies on the testing of emissions from burn barrels. The available information on emissions from the combustion of solid waste is predominantly based on the testing of municipal waste combustors. Literature exists which describes the nature and toxicity of thermal decomposition products and/or smoke due to the combustion of various types of plastics and other materials under varying conditions that do not include burn barrels.

Only two of the available studies characterized emissions associated with open burning of residential refuse in a backyard burner (e.g., a 55-gal drum). These studies were performed by the Western Lake Superior Sanitary District of Minnesota² and the Two Rivers Regional Council of Public Officials and Patrick Engineering, Incorporated of Illinois¹. Both study designs included a hood and stack constructed above the 55-gal drum to capture the plume and facilitate pollutant emissions tests. Both studies reported that a substantial amount of dilution air was entrained in the burn barrel stack. Rough estimates of dilution air ratios were calculated by comparison to incinerator volumetric flow rates. The presence of large volumes of dilution air in these studies may have substantially reduced stack gas concentrations, thereby increasing the uncertainties in the measurements from these two studies. The Minnesota study estimated that the emissions of 2,3,7,8-tetrachlorodibenzo-*p*-dioxin (2,3,7,8-TCDD) from a burn barrel are 20 times greater on a per unit garbage basis than the emissions from a controlled incinerator.² No other pollutants were evaluated in the Minnesota study.

The Illinois study quantified the extent and impact of backyard burning in Illinois.¹ This study included a survey of 187 residents in rural counties of Illinois to determine the quantity and type of wastes burned, the management of the ash, and motivation for burning. Thirteen households volunteered to set aside the waste they typically burned for 1 week. Samples of waste were sorted and weighed. The overall composition of the waste was found to be similar to the composition of residential waste that is typically landfilled by residents in other counties of Illinois, containing mixtures of paper products, wood, food waste, plastic resins, glass or ceramics, and metals. Prior to burning, waste

was bagged, weighed, and a bulk density was determined. Refuse was burned over an 8-hour period in a 55-gal drum. Emission sampling was done for three 2-hour test periods. Pollutants measured in the stack hood included particulate matter (PM), sulfur dioxide (SO₂), nitrogen oxides (NO_x), carbon monoxide (CO), hydrogen chloride (HCl), total volatile organic compounds (VOCs), polychlorinated dibenzo-*p*-dioxins and dibenzofurans (PCDDs/PCDFs), and metals. Test results showed that PM emissions from the burn barrel may be 40 times higher than from an uncontrolled incinerator. Test results showed that burn barrels could emit up to 17 times more total PCDDs/PCDFs on a per unit mass refuse burned basis than a controlled municipal waste incinerator. This result is consistent with the Minnesota study measurement of 2,3,7,8-TCDD. Metal emissions were many times higher than those of a controlled incinerator. SO₂ emissions on a per unit mass of refuse burned basis were found to be similar to the emission rates for a 1,200 ton/day municipal solid waste incinerator. After burning, the volume of residual ash was measured and weighed. Results of this study showed that the weight reductions of burned refuse varied from 34 to 53 percent, indicating that a substantial amount of waste was left unburned. Volume reductions of waste varied between 70 and 80 percent, suggesting that less dense materials combusted more easily. Ash leachate, from the Toxicity Characteristic Leachability Procedure (TCLP), was analyzed for semivolatile organic compounds (SVOCs) and metals. The SVOCs in the ash leachate were below method detection limits (MDLs). Also, the metals (except for barium and lead) in the ash leachate, were found to be below MDLs. Barium and lead levels were below those that are considered hazardous according to the Resource Conservation and Recovery Act (RCRA) definition of hazardous waste.

The above studies characterized emissions associated with the open-burning of residential solid waste in 55-gal drums. Other studies have measured combustion products from the open burning of refuse in other burning devices. Gerstle and Kemnitz quantified emissions from the burning of municipal refuse.³ The apparatus used to burn the material was a burn table equipped with a cone to capture and funnel the pollutants to a sampling port. Material weighing 45.5 to 56.8 kg (100 to 125 lb) actively burned for 60-90 minutes followed by a smoldering period which lasted up to 12 h. Weights were recorded using a platform scale and continuous monitors were used for stack gas temperature, gas flow, and weight of material. Samples were analyzed for carbon dioxide (CO₂), CO, vapor-phase total hydrocarbons (THCs), NO_x, formaldehyde, organic acids, and polynuclear aromatic hydrocarbons (PAHs). Concentrations were converted to emission rates on a per unit of initial weight basis by assuming that the concentrations that were measured during the first hour remained constant for the duration of the smoldering period. The design of the study did not simulate the oxygen-starved conditions commonly found in backyard burn barrels. PAH emissions included fluoranthene, pyrene, chrysene, benzo(a)anthracene, benzo(a)pyrene, benzo(e)pyrene, and benzo(g,h,i)perylene in quantities ranging from 0.13 to 0.78 g emitted per ton of material initially present. Average PM emissions were 16 lb per ton of material initially present. This result is comparable to the Illinois study. Other results of this study are shown in Table 1-1.

Burckle et al. reported results of an emissions study associated with burning municipal refuse in a pilot-scale trench incinerator.⁴ This unit was constructed using a refractory lined trench incinerator unit with a supplied air blower and smokestack. Emissions from this unit were compared to the emissions from an open burn and a full-scale trench incinerator. The pollutants measured were CO₂, CO, NO_x, and PM. The study results indicated that particulate

emissions ranged from 20.6 to 59.0 lb of PM per ton of material burned. Other emission factors include carboxyls as acetic acid and carbonyls as formaldehyde. Carboxyl emissions were 3.13 to 13.00 lb emitted per ton of material burned, and carbonyl emissions were 1.24 to 6.06 lb emitted per ton of material burned. Oxygen-starved conditions were not simulated.

Table 1-1. Measurements of Gerstle and Kemnitz^{(3)a}

CO ₂	CO	THC ^b	Formaldehyde	Organic Acids ^c	NO _x
1230	85	30	0.095	15	4 to 27

a - All units expressed in pounds emitted per ton of material initially present.

b - THC expressed as methane.

c - Organic acids expressed as acetic acid.

Other household waste combustion devices for home use have been designed that supposedly have aesthetic advantages over the traditional barrel burner. For instance a text for homeowners written in the 1950's stated, "The average outdoor incinerator seldom amounts to more than a cylinder of fence wire or an old oil drum with the end knocked out. To beautify the garden or yard, here is an attractive incinerator made of stone...designed to look like a miniature lighthouse.⁵" This same text provides detailed drawings of an "attractive barbecue fireplace (which) includes an incinerator which uses the same chimney as the grill. A smoke deflector prevents smoke from circulating from one firebox to the other." Even today a mail order catalog received by one of the authors advertised what appears to be a fairly simple aluminum "Trash Burner," 3 bushel capacity, as an "exceptional unit for home, estate or business. It provides the efficiency of far larger, more costly custom-built installations. All burnable refuse is reduced to fine ash in any weather. Simply load, ignite and forget it." Although there are no actual test data to evaluate the manufacturer's claims for this unit, it is unlikely that the combustion efficiency of a well operated, well designed municipal waste combustor can be matched by such a simple backyard device operated in the manner described.⁶

Each of the aforementioned sources provides useful information; however, there are limitations associated with their results. As previously noted, due to the sampling design used in these tests the entrainment of an unknown volume of dilution air may have substantially reduced the contaminant concentrations measured in the stack. Other limitations include: 1) unrefined characterization of the waste stream, 2) only emissions of a limited number of target compounds were measured, 3) reproducibility of measurements was not evaluated, and 4) oxygen-starved conditions were not simulated. The Illinois study offers the most complete emission factor data; however, it did not adequately account for the dilution air entrained in the stack during sampling. Additionally, several products of incomplete combustion were not measured (e.g., benzo-(a)-pyrene and other PAHs).

The New York State Departments of Health (NYSDOH) and Environmental Conservation (NYSDEC), as well as

regulatory agencies in other states, requested that the EPA's Control Technology Center (CTC) perform a study to characterize the emissions due to open burning of residential waste in burn barrels using techniques that would minimize the limitations of previous studies. The CTC, NYSDOH, and NYSDEC performed a cooperative study to: 1) characterize and fabricate the waste to be burned (in duplicate), 2) measure the emission rates of many pollutants of concern, 3) measure these pollutant concentrations in the residual ash (except for the VOCs), 4) measure the volume of ambient air entering the burn facility, and 5) be representative of the combustion conditions typically found in a backyard burner. The study was conducted under the direction of the EPA's National Risk Management Research Laboratory, Air Pollution Prevention and Control Division (APPCD). The combustion tests were conducted by APPCD's on-site contractor, Acurex Environmental Corporation (Acurex) with the oversight of representatives from APPCD and NYSDOH. Analytical chemistry work was divided between Acurex and NYSDOH staffs.

SECTION 2.0 EXPERIMENTAL APPROACH

2.1 Summary of Objectives and Experimental Approach

This project was a study to qualitatively identify and quantitatively measure the emissions of hazardous air pollutants from the open burning of household residential refuse in barrels. A secondary objective was to evaluate the concentrations of hazardous compounds in the residual ash. The target audience for this work is the environmental research community at large as well as state and local regulatory agencies. The major intended end use of the data is to place the emissions from these processes in proper perspective with respect to other point and area sources and to provide estimated emissions values that can serve as inputs to a risk assessment for the barrel burning process. This work is intended to provide a sufficiently broad survey of the emissions from this process to allow evaluation of the need for further study of this practice. It should be noted that most risk assessment studies currently include sources of uncertainty so great that the true risk can only be stated to be within a range of one or more orders of magnitude. Thus the formal data quality objective for this study was stated as follows.

"The objective of this study is to measure the emissions of hazardous air pollutants from the open burning of household residential refuse in barrels such that emission factors derived are accurate within a factor of three. We seek to estimate the emissions from these processes with sufficient accuracy so that the true emission factor is between 33 and 300 percent of the estimated emission value reported. Further we seek to survey as broad a range of potential emissions as resources and available sampling methodologies allow."

Due to the highly variable nature of household waste generation, a reasonable representation of a waste stream for disposal in a burn barrel was prepared according to the typical percentages of various materials characterized and quantified for New York State residents. The characterization was performed by the New York State Department of Environmental Conservation's Division of Solid Waste and is based upon waste stream characterizations for New York State. The preparation of simulated waste was performed by Acurex staff primarily from raw materials diverted from the household waste streams of staff members.

Emissions from two categories of waste were analyzed in this study (Table 2-1). These categories include waste from an avid recycling and a non-recycling family of four. To reduce the amount of different types of material to be collected for the tests, percentages for like materials were combined (e.g., percentages for newspaper, books, and office paper have all been combined) and percentages for "miscellaneous" items for each category were added to the items that make up the largest percent for that category (see Table 2-1). Household hazardous waste (e.g., household chemicals, paint, grease, oils, tires, and other vehicle parts) were not included in the waste to be burned. For the recycling and non-recycling scenarios, 6.4 - 13.5 kg (14 - 30 lb) of waste were combusted (in duplicate) in a specially designed vessel (described below) in the EPA's Open Burning Simulation Test Facility (the facility). The facility has been used for other similar studies.^{7,8,9,10,11,12} The composition of the material burned during the tests is shown in Table 2-2.

Table 2-1. Composition of household waste prepared by EPA (based on a characterization of household waste prepared by the NYSDEC).

	Non-Recycler (%)	Avid Recycler (%)
PAPER		
Newspaper, books, and office paper	32.8	3.3
Magazines and junk mail	11.1	--
Corrugated cardboard and kraft paper	7.6	--
Paperboard, milk cartons, and drink boxes	10.3	61.9
PLASTIC RESIN (all types may contain trace plasticizers; e.g., cadmium)^a		
PET #1 (bottle bill)	0.6	--
HDPE: #2, LDPE #4, and PP #5	6.6	10.4
PVC: #3	0.2	4.5
PS: #6	0.1	0.3
Mixed #7	0.1	0.3
FOOD WASTE	5.7	--
TEXTILE/LEATHER	3.7	--
WOOD (treated/untreated)	1.1	3.7
GLASS/CERAMICS		
Bottles/jars (bottle bill)	9.7	--
Ceramics (broken plates and cups)	0.4	6.9
METAL - FERROUS		
Iron - cans	7.3	4.0
NON-FERROUS		
Aluminum - cans (bottle bill), foil, other	1.7	1.0
Other non-iron (wire, copper pipe, batteries)	<u>1.1</u>	<u>3.7</u>
PERCENT TOTAL	100.0	100.0
TOTAL WEIGHT GENERATED PER HOUSEHOLD FOR DISPOSAL IN BURN BARRELS		
	4.9 kg/day	1.5 kg/day

a - PET = polyethylene terephthalate; HDPE = high-density polyethylene; LDPE = low-density polyethylene; PP = polypropylene; PVC = polyvinyl chloride; and PS = polystyrene.

Table 2-2. Composition of material used on each test day, grams; numbers in parentheses represent mass percent of those components^a.

Test No.	1 Avid Recycler	2 Avid Recycler	4 Non- Recycler	5 Non- Recycler
PAPER				
Newspaper, books, and office paper	374.6 (3.3)	374.6 (3.3)	2231.7 (32.8)	2231.6 (32.8)
Magazines and junk mail	--	--	755.2 (11.1)	755.2 (11.1)
Corrugated cardboard and kraft paper	--	--	517.1 (7.6)	517.1 (7.6)
Paperboard, milk cartons, and drink boxes	7019.4 (61.9)	7019.5 (61.9)	700.8 (10.3)	700.8 (10.3)
PLASTIC RESIN^b				
PET #1 (bottle bill)	--	--	40.8 (0.6)	40.7 (0.6)
HDPE: #2, LDPE #4, and PP #5	1180.0 (10.4)	1179.6(10.4)	449.1 (6.6)	449.1 (6.6)
PVC: #3	510.9 (4.5)	511.0 (4.5)	13.6 (0.2)	13.6 (0.2)
PS: #6	34.2(0.3)	34.0 (0.3)	6.8 (0.1)	6.8 (0.1)
Mixed #7	34.2 (0.3)	34.1 (0.3)	6.8 (0.1)	6.8 (0.1)
FOOD WASTE	--	--	387.9 (5.7)	387.7 (5.7)
TEXTILE/LEATHER	--	--	251.8 (3.7)	251.7 (3.7)
WOOD (treated/untreated)	419.6 (3.7)	419.3 (3.7)	74.8 (1.1)	74.7 (1.1)
GLASS/CERAMICS				
Bottles/jars (bottle bill)	--	--	660.1 (9.7)	660.5 (9.7)
Ceramics (broken plates and cups)	782.7 (6.9)	782.6 (6.9)	27.4 (0.4)	27.3 (0.4)
METAL - FERROUS				
Iron - cans	453.6 (4.0)	453.9 (4.0)	496.6 (7.3)	496.4 (7.3)
NON-FERROUS				
Aluminum - cans	113.6 (1.0)	113.8 (1.0)	115.7 (1.7)	115.4 (1.7)
Other non-iron	419.5 (1.0)	419.8 (1.0)	74.8 (1.1)	74.6 (1.1)
TOTAL	11.342 kg = 25.0 lb	11.342 kg = 25.0 lb	6.811 kg = 15.0 lb	6.810 kg = 15.0 lb

a - Test 3 was a blank with no household waste present.

b - PET = polyethylene terephthalate; HDPE = high-density polyethylene; LDPE = low-density polyethylene; PP = polypropylene; PVC = polyvinyl chloride; and PS = polystyrene.

The pollutants targeted in this study were total PM with an aerodynamic diameter of 10 μm or less (PM_{10}), total PM with an aerodynamic diameter of 2.5 μm or less ($\text{PM}_{2.5}$), HCl, hydrogen cyanide (HCN), VOCs, aldehydes, combined particulate-phase and vapor-phase SVOCs (including PAHs, polychlorinated biphenyls (PCBs), and PCDDs/PCDFs), particulate-phase metals, and vapor-phase mercury. Additionally, SVOCs (including PAHs, PCBs, and PCDDs/PCDFs), and metals were measured in the residual ash. Continuous emission monitors (CEMs) for oxygen (O_2), CO_2 , CO, THC, and nitric oxide (NO) were also operated. Measured concentrations were related to dilution air volumes and measured net mass of debris combusted to derive emission rates. Emission rate data and ash sampling results are intended to be useful in evaluating the potential exposure due to pollutant emissions associated with the backyard burning of household refuse in barrels.

2.2 Open Burning Simulation Facility

The facility used in this study consists of three primary components; the burn hut, sample shed, and Hazardous Air Pollutants Mobile Laboratory (HAPML). A plan view of the Open Burning Simulation Facility is shown in Figure 2-1.

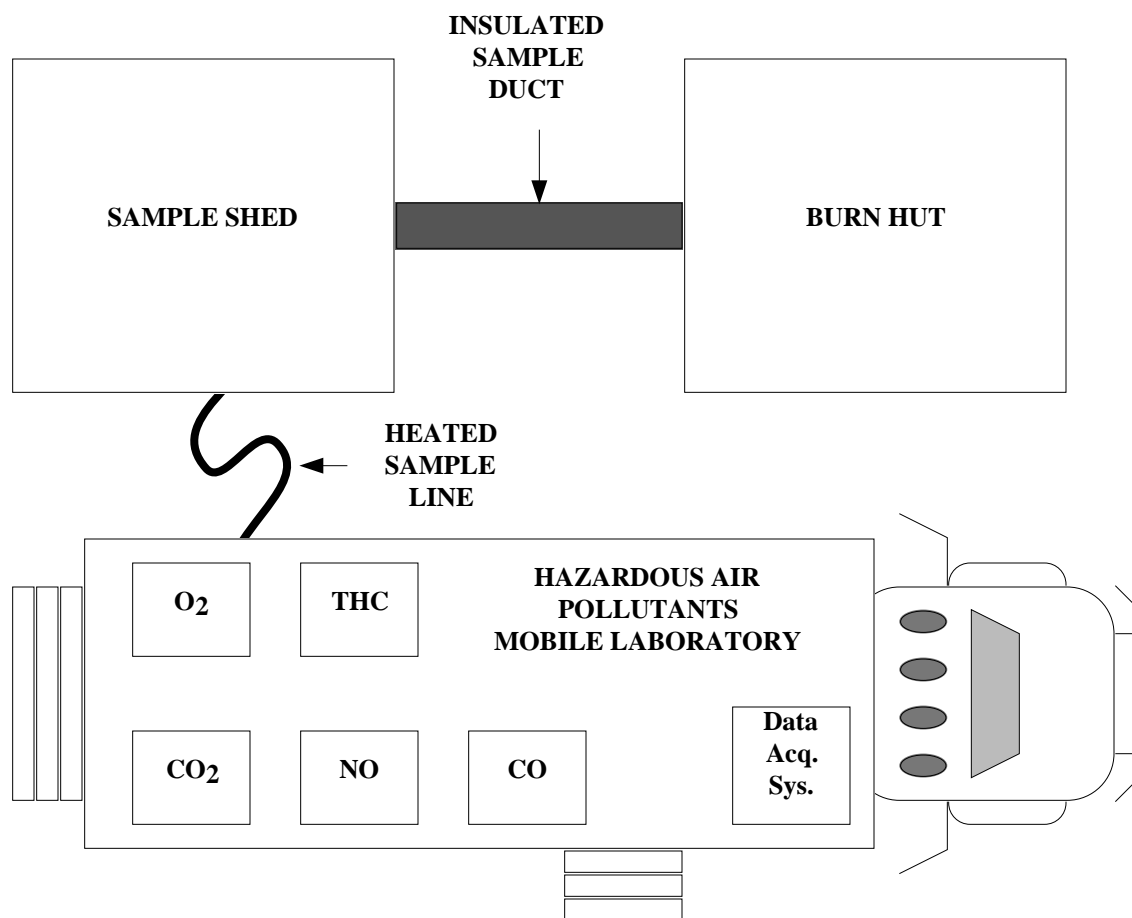

Figure 2-1. Plan view of open burning simulation facility.

2.2.1 Burn Hut

The burn hut (Figure 2-2) is an outbuilding with a 2.7 x 3.4 m (8.9 x 11.1 ft) floor area and a sloping roof with a minimum height of 1.9 m (6.3 ft) and a maximum height of 2.2 m (7.3 ft), modified for small-scale, open-combustion simulation experiments. The building has been fitted with an air handling system which during this study delivered 45.4-46.5 m³/min (1603-1642 ft³/min). The air handling unit supplies air at ground level to both sides of the burn hut. This flow rate was sufficient to maintain a positive pressure within the facility. Thus it could be assumed that the outflow rate from the facility was equal to this inflow rate. At this flow rate, the effective air exchange rate of the burn hut is 2.4 air exchanges/min. Mixing of the burn hut air was provided by the currents from these two air inlets and a pyramidal deflector shield located over the barrel. Residential type electric fans were placed in the hut in a further attempt to ensure thorough mixing. These fans were oriented to circulate air within the facility and thus should not significantly alter air exchange rates. Thermocouples were placed at the numbered locations shown in Figure 2-2. Note that thermocouple No. 3 failed and is not shown.

The sample transport duct, 17-cm (6.6-in) OD stove pipe, was located over and behind the deflector shield. This duct transported a representative sample from the burn hut atmosphere to the sampling shed located adjacent to the burn hut. To minimize heat loss and condensation of organics, the duct was insulated outside the burn hut. The inner walls and ceiling of the burn hut were covered with 1.6-mm (1/16 in) aluminum sheeting to provide an inert surface within the test facility. To provide a highly clean, inert surface within the test facility, all surfaces within the burn hut were completely lined with Tedlar sheet material (approximately 0.06 mm thick and sealed with heating, ventilation, and air-conditioning (HVAC) grade aluminum faced tape (part No. 6A062, W. W. Grainger). However, it should be noted that in some tests heat from the combustion process caused tape peeling and thus breaches in this inner Tedlar surface. This should not significantly bias test results however since the pressure within the Teflon envelope would have been positive and thus the direction of flow out through these breaches.

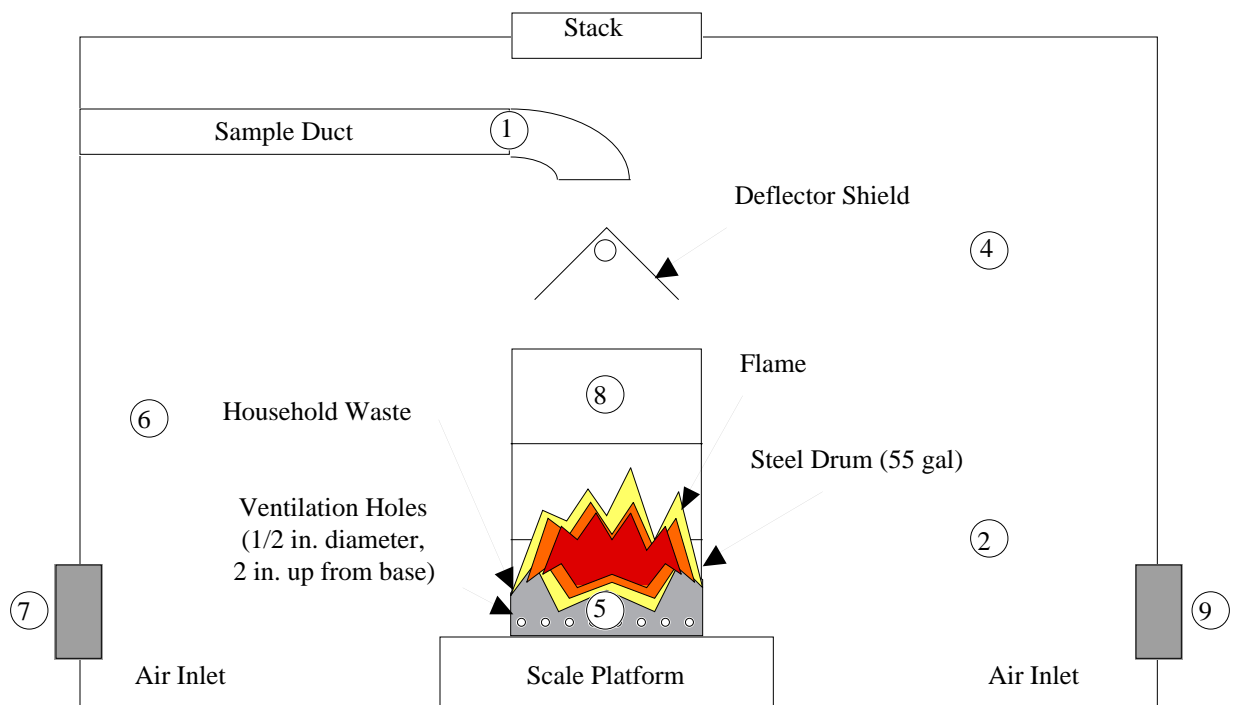

Figure 2-2. Diagram of burn hut (numbers represent thermocouple locations).

A 55-gal steel drum, modified for ventilation, was used as the burn device.^{1,5} The drum was sandblasted prior to use to remove paint, thus simulating the use of a weathered, used barrel that would be the most common residential situation. This combustion device was operated on an electronic scale platform to allow the mass consumed by combustion to be monitored. The material to be combusted was prepared according to the masses listed in Table 2-2. As much as possible, duplicate fuel mixes were prepared by manually sorting individual objects into the two duplicate mixtures. The mixes were manually mixed in a plastic bag. The material was used and stored at "as received/as collected" moisture content. Moisture content based on drying a bulk sample at 105 °C was estimated.

Also located in the burn hut were inlets for various sampling devices. Figure 2-3 illustrates the locations of the sampling devices. The inlet for the volatiles sampling train was located within the burn hut, but the SUMMA® canister and balance of the sampling train were located exterior to the burn hut. Volatiles were sampled using a 0.64 cm (1/4 in) Teflon line inserted through a hole in the back of the burn hut. This line was filtered to 0.2 µm particle size and regulated using a 0-50 mL/min mass flow controller. The inlet for the dichotomous PM₁₀ and PM_{2.5} sampling device, PCDDs/PCDFs, metals, HCN, HCl, aldehyde/ketone, and SVOC sample trains were located within the burn hut. Sampling media for the dichotomous, PCDDs/PCDFs, aldehyde/ketone, and SVOC trains were also located within the burn hut. The sampling media for the HCN, HCl, and metals trains were exterior to the hut except for the filter and cyclones (if any) which were located within the hut.

The air inputs into the hut from the air handling system were measured in triplicate before and after each set of tests using an Airdata backpressure/temperature-compensated flowgrid airflow system. In order to make these measurements, a flowgrid (Airdata Flow Meter CFM-88, Shortridge Instruments Inc., Scottsdale, Arizona) was

placed in front of the air conditioner openings in a pattern to traverse the entire opening. During these tests, the door was closed with both air conditioners running to maintain as nearly as possible the conditions during a test.

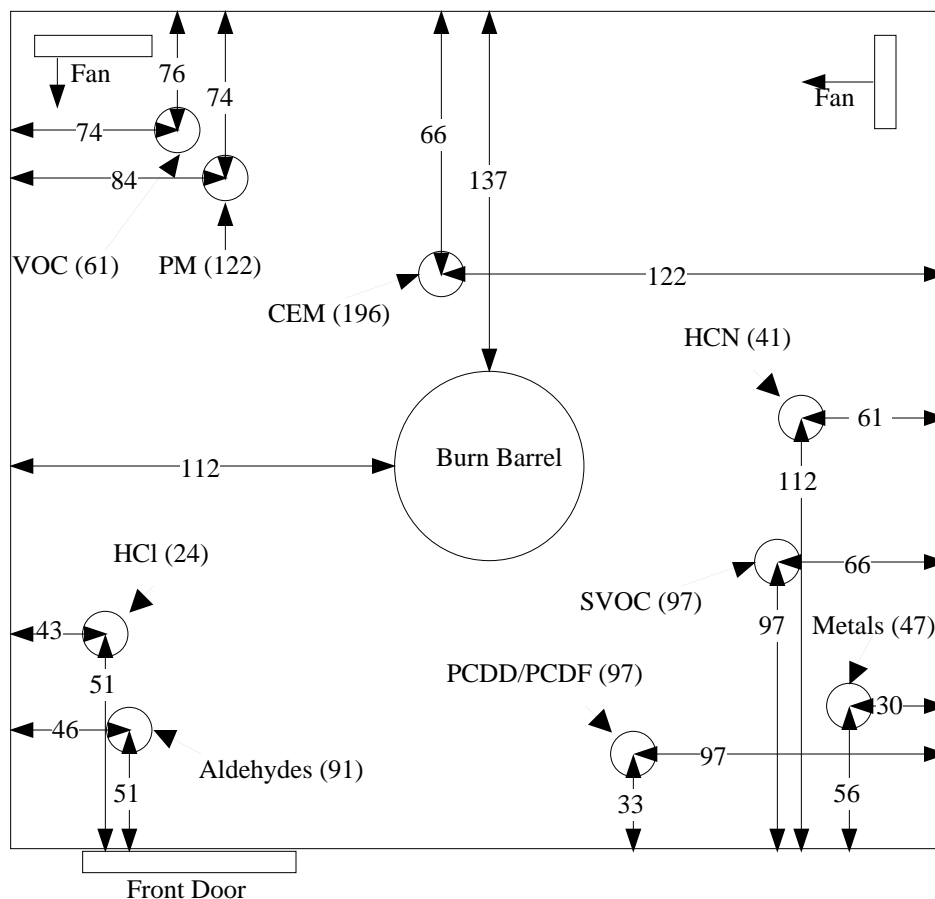

Figure 2-3. Plan view of burn hut showing sampling locations (all measurements are in cm; measurements in parentheses represent height from floor).

2.2.2 Sample Shed

The sample shed contained the additional required sampling equipment such as the particulate removal device for the CEMs and the meter box and pumps for the various sampling trains. All dry gas meters were calibrated against a Bell Prover or wet test meter. A digital readout/control for the platform scale was remotely operated from the sample shed.

CEM samples were extracted from a sampling manifold within the sample duct. The manifold consists of 9.5-mm (3/8 in) OD stainless steel probes positioned in the sample transport duct so that the probe orifice faced the direction of sample flow. The sample stream was pulled from the burn hut into the sample shed under vacuum by an induced draft (ID) fan located downstream of the sample manifold. A heated filter box and heated sample line carried the sample gas to the Hazardous Air Pollutants Mobile Laboratory (HAPML).

2.2.3 Hazardous Air Pollutants Mobile Laboratory (HAPML)

The HAPML was used for the continuous monitoring of the fixed combustion gases. A heated (121 °C [250 °F]), particulate-free gaseous sample was extracted from the sample manifold and routed to individual analyzers for continuous measurement. A portion of the heated sample was routed to the THC analyzer. The remaining portion of the sample stream was further conditioned for moisture removal by a refrigeration condenser and silica gel before being routed to the O₂, CO₂, and CO analyzers. The gas stream for NO was obtained from a location between the refrigeration condenser and desiccant. An Ecom multigas combustion analyzer was also attached to this system at this point during Test Nos. 2-5. The Ecom analyzer has onboard additional particulate and moisture removal systems. The Ecom analyzer was primarily installed since scoping and initial tests indicated that the individual O₂ analyzer was not performing adequately. A substitute individual O₂ analyzer was not available, and repairs were not feasible. The analog output of the individual analyzers was recorded by computerized data acquisition system which recorded all readings at 30-s intervals. This data acquisition system was also used to record weights from the platform scale and temperatures from a series of eight thermocouples located in the burn hut, air conditioner input ducts, and sample transport duct. The Ecom analyzer has an onboard data acquisition system that was set to record readings at 2 minute intervals.

2.3 Test Procedures

At the beginning of each test day all sample trains were assembled and leak-checked, and all CEMs calibrated as per the Quality Assurance Project Plan. Before the initiation of the test, the material to be combusted was placed in the barrel, air flow through the facility was initiated, and 15 minutes of background data on the continuous emission monitors and thermocouples were obtained. The material to be combusted was then lit for a short period (<3 min) using a propane torch. At least 2 minutes after the removal of the propane torch, sampling on all trains was initiated. Propane torches generally produce only CO₂ and small quantities of low molecular weight products of incomplete combustion and these products were expected to have largely dissipated before sampling is initiated; therefore, this procedure should not bias the results. This was verified by a hut blank experiment during which the propane torches were lit, but household waste was not burned. Additionally, the hut blank experiment provides information for the assessment of background contaminant concentrations in the ambient air that is pumped through the facility. Various field and laboratory blank samples were collected for each sampling train.

2.4 Sampling and Analysis Methods

2.4.1 CEMs and Thermocouples

Fixed combustion gases CO₂, CO, NO, O₂, and THC were monitored continuously throughout the test period through the sampling manifold. Each CEM was calibrated prior to each test. The calibration consisted of at least three points (zero, span, mid-point). After introducing the zero and adjusting, span gases were used to adjust the

gain, and a mid-point calibration gas was introduced to verify analyzer linearity. At the conclusion of testing for the day, the response of the instrument was again checked by introducing a zero and span gases. All span gases used were certified by the manufacturer. All span and zero gases were delivered at a constant pressure and flow identical to those used during sampling. This was done to avoid biasing the sample gas measurements with respect to the calibration gas measurements. A calibration gas was allowed to flow through the entire system from the heated filter box to the analyzer to test for system sample bias on one occasion. The Ecom multigas combustion analyzer has a different standard calibration procedure. It was three-point calibrated at the beginning of the project. Before each test the analyzer performed an automatic one-point calibration check. On at least one occasion the oxygen analyzer functions of this analyzer were independently verified with a calibration gas. Thermocouple calibration checks were conducted once during the project using an ice bath slurry and a boiling water bath.

2.4.2 Volatile Organic Sampling and Analysis

Volatile organics were sampled into SUMMA[®] canisters and analyzed according to Method TO-14¹³ by Acurex. The canisters were cleaned before each experiment by five sequential evacuations and refillings with purified gas. Ten percent of each batch of canisters were tested before use to ensure adequate cleaning. The SUMMA[®] canisters were located exterior to the burn hut with a Teflon sample probe drawing directly from the burn hut. The sample was collected through a train consisting of the Teflon tubing probe followed by a particulate filter and mass flow controller. The dead volume of this system was minimal compared to the sample volume. A diagram of a similar sampling system is provided in the cited method. The filter and delivery system was not heated since the area to be sampled from (the burn hut) was very close to ambient temperature. Method TO-14's instructions for capillary column gas chromatography/mass spectrometry (GC/MS) analysis in the full scan mode were used (although Method TO-14 contains provisions for other analytical methods that were not used in this study). Compound identification was based on retention time and the agreement of the mass spectra of the unknown to mass spectra of known standards. A multipoint calibration was performed before analysis for a targeted group of analytes to establish response factors (RFs). Quantification was then based on an external standard method using these RFs and the integrated responses for each identified compound. Beyond those targeted compounds, up to the 20 highest abundance peaks were tentatively identified based on spectral identification. The program used for this tentative identification attempts to identify all nontargeted peaks with areas greater than 10 percent of that of the nearest eluting standard.

2.4.3 Dichotomous Sampling for Total PM₁₀ and PM_{2.5} Particulate

This sampler was operated in accordance with the operating manual¹⁴ and the provisions of the EPA's "Reference Method for the Determination of PM₁₀ in the Atmosphere."¹⁵ The method of operation of this sampling train for this project differed from the operating manual in several respects: 1) due to constraints of facility size, the sampler location criteria in Section 5.1 were modified (i.e., the sampler was placed inside the burn hut); 2) the flow through the sampler was measured by a separate dry gas meter in addition to the rotameter as discussed in the manual; and 3) the filter holders were modified to accept a 142 mm Teflon filter. All filters were desiccated before taring and stored

in a desiccator after sampling, until weighing. All aspects of this determination were performed by Acurex.

2.4.4 Particulate/Semivolatile Organic Sampling and Analysis

Total particulate-phase organics were sampled using a Graseby PS-1 sampler operated within the burn hut. This train which is designed to comply with EPA's ambient sampling method TO-13,¹⁶ consisted of an open-faced filter holder followed by a polyurethane foam (PUF)-sandwiched XAD-2 bed vapor trap. The target flow rate for this sampler as stated in TO-13 is 200 to 280 L/min (7 to 9.8 ft³/min). This flow rate is designed to achieve low detection limits for the quantification of generally dilute ambient concentrations. Since this sampler does not have a particulate size separation device, considerably lower flow rates can be used. Due to the expected high concentrations of analytes in these tests, we operated this sampler at approximately 28.3 L/min (1 ft³/min). The temperature of air entering the train and within the PUF cartridge was assessed during preliminary tests in order to decide if further precautions were necessary to cool the system. Due to high temperatures in the burn hut, additional cooling was required and a copper cooling coil was fabricated to enclose the exterior of the PUF module. The method of operation of this sampling train was different from method TO-13 in the listed respects: 1) due to constraints of facility size, the sampler location criteria in Section 11.3.2 of TO-13 were modified (i.e., the sampler was placed inside the burn hut); 2) the flow through the sampler was measured by a separate dry gas meter rather than a venturi and Magnehelic gauge as discussed in TO-13; and 3) analysis was performed as described below. The PUF pieces were cleaned using methylene chloride in a Soxhlet extractor and stored in sealed Tedlar bags before preparation of the PUF/XAD-2 cartridge. The XAD-2 resin was cleaned and QC'd as outlined in Lentzen et al.¹⁷ XAD-2 was maintained under refrigeration (4 °C) in an amber bottle when not in use.

The semivolatile and particulate-phase organic sample was collected with a 110-mm diameter filter (Pallflex 2500 QAT-UP), and a glass and stainless steel cartridge containing PUF/XAD-2[®] resin sorbent. All semivolatile organic samples were stored in sealed Tedlar[®] bags and maintained under refrigeration (4 °C) before extraction. The filter and cartridge were then extracted together in methylene chloride. A glass Soxhlet extractor was constructed to house the PUF/XAD-2 cartridge and keep the solvent rinse level above the rim of the cartridge. The samples were concentrated using a rotary evaporator until the volume was approximately 5 mL, then the sample was transferred to a nitrogen blowdown vial. The samples were then concentrated using a nitrogen blowdown and hot water bath until the final volume of 1 mL was obtained. The samples were then transferred to a 2 mL crimp-cap vial with septum until injection on the gas chromatograph/mass selective detector (GC/MSD). The organic particulate and XAD-2 samples were analyzed together by Acurex after extraction. Analysis followed EPA Method 8270¹⁸ for semivolatile/particulate bound organics. Compound identification was based on retention time and the agreement of the mass spectra of the unknown to mass spectra of known standards. A multipoint calibration was performed before analysis for a targeted group of analytes to establish relative response factors (RRFs). Quantification was then based on an internal standard method utilizing these RRFs and the integrated responses of ions specific to each identified compound. Beyond those compounds targeted, the 20 highest abundance peaks were tentatively identified based on spectral identification.

A fraction of the semivolatile organic extracts were sent to WCL&R for analysis for PAHs and (tri through hexa) chlorobenzenes. This was done in a manner as to allow quantitative recording of the volume split off for this purpose and the total volume of the extract. A modification of EPA Method 8280 was used for the analysis of PAHs and chlorobenzenes using GC/MS with selected ion monitoring and isotope dilution quantitation.

2.4.5 Particulate- and Vapor-Phase Metals Sampling and Analysis

Metal species were sampled in accordance with Method 101A modified to be nonisokinetic, since sampling was not done from a duct.¹⁹ The preserved quartz fiber filters and associated rinses were sent to WCL&R for analysis except for the vapor-phase mercury samples which were analyzed by Triangle Laboratories due to the high cost and regulatory difficulty of shipping these fractions to WCL&R.

At WCL&R, the metals were extracted from the particulates and the extracts were analyzed using Inductively Coupled Plasma Mass Spectrometry (ICP-MS), Atomic Absorption Spectrophotometry, Electrothermal Atomic Absorption Spectrophotometry (graphite furnace), and Cold Vapor Atomic Absorption. The filters were divided into quarters to accomplish these analyses. Acid digestions for trace metals arsenic, barium, beryllium, cadmium, magnesium, copper, nickel, lead, selenium, silver, and zinc and were performed using nitric acid. Digestates were analyzed for trace metals arsenic, barium, beryllium, cadmium, magnesium, copper, nickel, lead, silver, and zinc by ICP-MS using EPA Method 2008. A portion of each digestate was analyzed for selenium by Electrothermal Atomic Absorption Spectrophotometry (graphite furnace) using EPA Method 270.2. Acid digestion for trace metals chromium and aluminum was performed using nitric and hydrofluoric acids. These digestates were analyzed by Atomic Absorption Spectrophotometry using EPA Method 202.1 for aluminum and EPA Method 218.1 for chromium. Nitric acid rinses of the front half of the sampling trains were concentrated, digested, and analyzed for all metals except mercury as described above. For these rinses, hydrofluoric acid was not used in the digestion procedure for chromium and aluminum. Mercury in the vapor phase was collected in permanganate solution in an impinger. This solution was analyzed by Cold Vapor Atomic Absorption as specified in Method 101A by Triangle Laboratories. The aqueous extract of the filter was analyzed by Cold Vapor Atomic Absorption as specified in Method 101A by WCL&R. Hydrochloric acid rinses of the mercury impingers were also analyzed for mercury by Cold Vapor Atomic Absorption by WCL&R.

2.4.6 Particulate- and Vapor-Phase PCDDs/PCDFs Sampling and Analysis

Total particulate-phase PCDDs/PCDFs were sampled using a Graseby PS-1 sampler operated within the burn hut. This train, designed to comply with EPA's ambient sampling method TO-9,²⁰ consists of an open-faced filter holder followed by a PUF-sandwiched XAD-2 bed vapor trap. Because this sampler does not have a particulate size separation device, fairly low flow rates can be used. Given the expected high concentrations of analytes in these tests, we operated this sampler at approximately 28.3 L/min (1 ft³/min) for approximately 1.5 hours. The temperature of air entering the train and within the PUF cartridge was assessed during preliminary tests in order to decide if further precautions were necessary to cool the system. Since further precautions were required, a copper

cooling coil was fabricated to enclose the exterior of the PUF module. The method of operation of this sampling train differs from method TO-9 in other respects:

- Due to constraints of facility size, the sampler location criteria in TO-9 were modified (i.e., the sampler was located inside the burn hut)
- The flow through the sampler was measured by a separate dry gas meter rather than a venturi and Magnehelic gauge as discussed in TO-9
- Analysis was performed using HRGC/LRMS based on EPA Methods 23 and 8280
- The filter and vapor-phase module were analyzed together

These samples were spiked, extracted, and concentrated by Acurex. The extracts were then shipped on ice to WCL&R for analysis by Method 8280.

Additionally, a fraction of the PCDD/PCDF extract was removed before the addition of surrogate standards and sent to NYSDOH's Wadsworth Center for Laboratories and Research (WCL&R) for analysis of PCBs by GC/electron capture detector as per the NYSDEC Analytical Services Protocol Method 91-11. The PCDD/PCDF sample cartridge was spiked prior to extraction with a PCB standard mix supplied by WCL&R. The initial analysis of these fractions was not performed by WCL&R because of a laboratory accident. A second set of fractions of the PCDD/PCDF extracts were obtained by WCL&R and analyzed for congener-specific PCBs using surrogate congeners spiked prior to analysis.

2.4.7 Ash Analysis

A single subsample of the ash collected during each type of combustion tests ("avid recyclers" and "non-recyclers") was collected by Acurex and either soxhlet extracted (for organic components) or acid digested (for inorganic components) and analyzed for the following parameters:

- PCDDs/PCDFs by EPA Method 8280 by WCL&R
- SVOCs by EPA Method 8270 by WCL&R
- Metals by EPA Method 200.7 ICP Emission by WCL&R
- PCBs by NYSDEC Analytical Services Protocol Method 91-11 by WCL&R

2.4.8 Acid Gas Sampling and Analysis

HCl was sampled and analyzed in general accordance with EPA Method 26, except that the stack sampling specific isokinetic sampling procedures were not utilized. This sample was withdrawn directly from the burn hut as discussed above. This analysis was performed by Acurex using High Pressure Liquid Chromatography (HPLC), based on Method 26. HCN was sampled in accordance with NIOSH Method 7904 directly from the burn hut. Analysis was performed using an ion sensitive electrode as discussed in Method 7904. This analysis was performed

by Acurex.

2.4.9 Aldehyde and Ketone Sampling and Analysis

Sampling for these species used DNPH-coated cartridges located within the burn hut as outlined in Method IP-6A. Analysis was performed by Acurex using HPLC.

2.5 Data Processing

Estimated emissions per unit mass burned were calculated using measured concentrations of analytes, the volume of air entering the burn hut facility, the volume of air drawn through the sampling device standardized to ambient temperature and barometric pressure, and the mass of waste consumed by combustion. These estimated emissions expressed a mass of analyte produced per mass of debris material consumed in the combustion process.

During all runs, the air flow rate into the burn hut was 46 m³/min (1622.5 ft³/min) on a dry, standard basis.

The sample trains yielded results in average concentration over the duration of the run. In order to convert to estimated emissions per unit mass burned, the following formula was used:

$$\text{Estimated emissions} = \frac{\text{Avg concentration} * \text{Flow rate into hut} * \text{Run time}}{\text{Mass of waste burned}}$$

The information necessary to calculate the estimated emissions can be found in the Appendices F and G. Note that the mass of waste burned depends on the mass at the start and stop times of the sampling methods and not on the total mass burned through the entire experiment.

SECTION 3.0
DATA, RESULTS, AND DISCUSSION

All emissions data are reported in mass emitted per kg of household waste combusted. Each analytical sample also included a hut blank, but the hut blank data are not included in the body of the report since there was no material burned in the hut blank and, as such, the estimated emissions per unit mass burned for those tests are undefined. All data from various blanks are included in the Appendices F and G. In addition, data presented in this manner do not take into account that the avid recycler produces only 30 percent of the mass of refuse produced by the non-recycler. Table 2-1 states that the avid recycler family of four produces approximately 1.5 kg/day of refuse, and the non-recycler family of four produces approximately 4.9 kg/day. Section 4.0 discusses the differences between the estimated emissions on a mass basis and the estimated emissions on a household basis.

In addition, it must be noted that many analytes were present at values below the lowest calibration point for the analytical methods. These data were flagged with a “J” in the data tables. Compound concentrations flagged in this manner cannot be held to the same degree of quantitative certainty of compounds whose concentrations fell within the calibration range. However, these data are very different from non-detects. Compounds flagged in this manner were definitely present, but not quantified to the same degree that they would have been had they been within the calibration range of the analytical instruments.

3.1 Continuous Measurement Results

Table 3-1 lists the test conditions for the experiments. If the fraction of the initial material that was combusted is plotted, it is noted that a greater fraction of the mass of the avid recycler’s trash is combusted. This observation is shown in Figure 3-1. Figures 3-2 through 3-25 show the traces from the CEMs for O₂, CO₂, CO, THC, and NO, as well as the signal from the weigh scale for Tests 1, 2, 4, and 5. Test 3 was the hut blank and had uninteresting CEM results that were generally consistent with expected ambient air concentrations of those species. O₂ and CO₂ levels were approaching ambient concentrations for all tests, although CO₂ did rise slightly during the burns. Other CEM traces showed high values during initial combustion of the waste, but tapered off towards zero as time progressed. Temperature measurements listed as “base of barrel” and “above barrel” represent measurements taken at points 5 and 8 in Figure 2-2.

Table 3-1. Mass of waste burned during testing

Test No.	Test Conditions	Start Mass (kg)	Final Mass (kg)	Mass Burned (kg)	Amt. Burned (%)	Duration (min)
1	Avid Recycler	12.4	4.4	8.1	65.3	77
2	Avid Recycler	13.6	4.4	9.2	68.1	83
3	Hut Blank	0.0	0.0	0.0	--	92
4	Non-Recycler	6.4	3.1	3.3	51.6	62
5	Non-Recycler	8.8	4.7	4.1	46.6	91

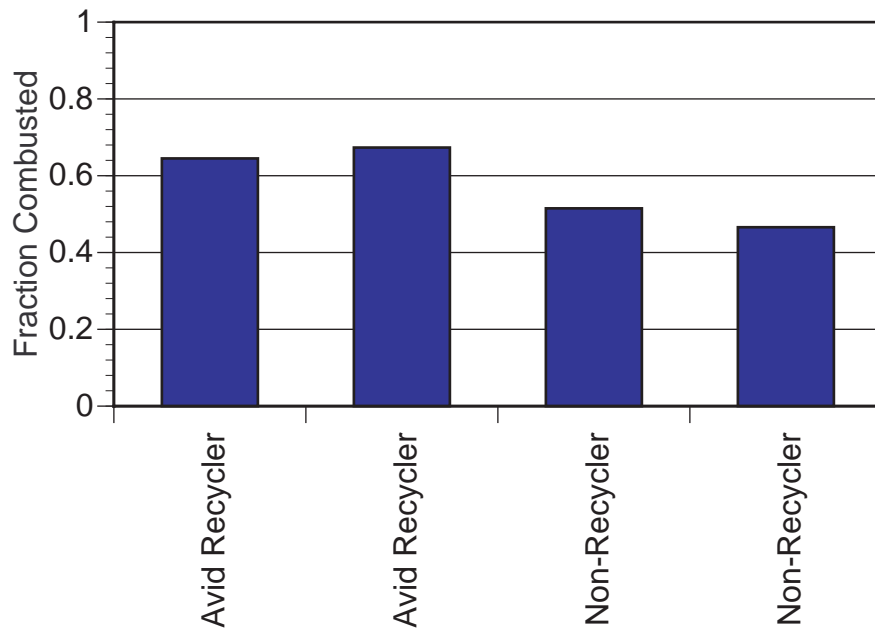

Figure 3-1. Fraction of initial mass combusted.

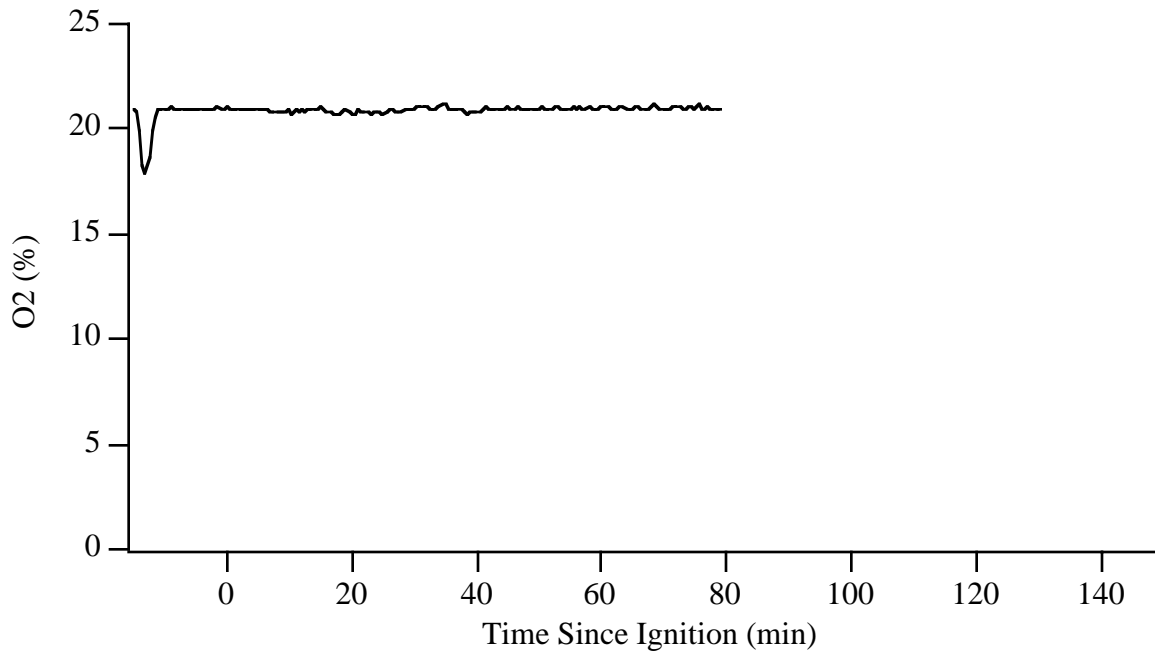

Figure 3-2. O₂ Results from Test 1

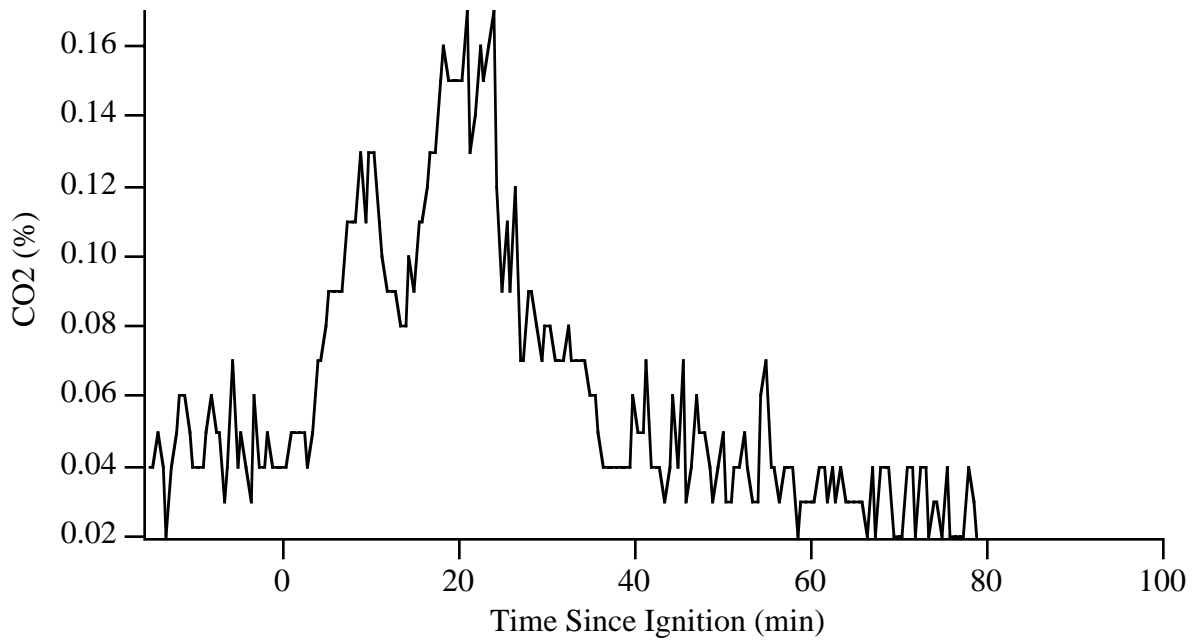

Figure 3-3. CO₂ Results from Test 1

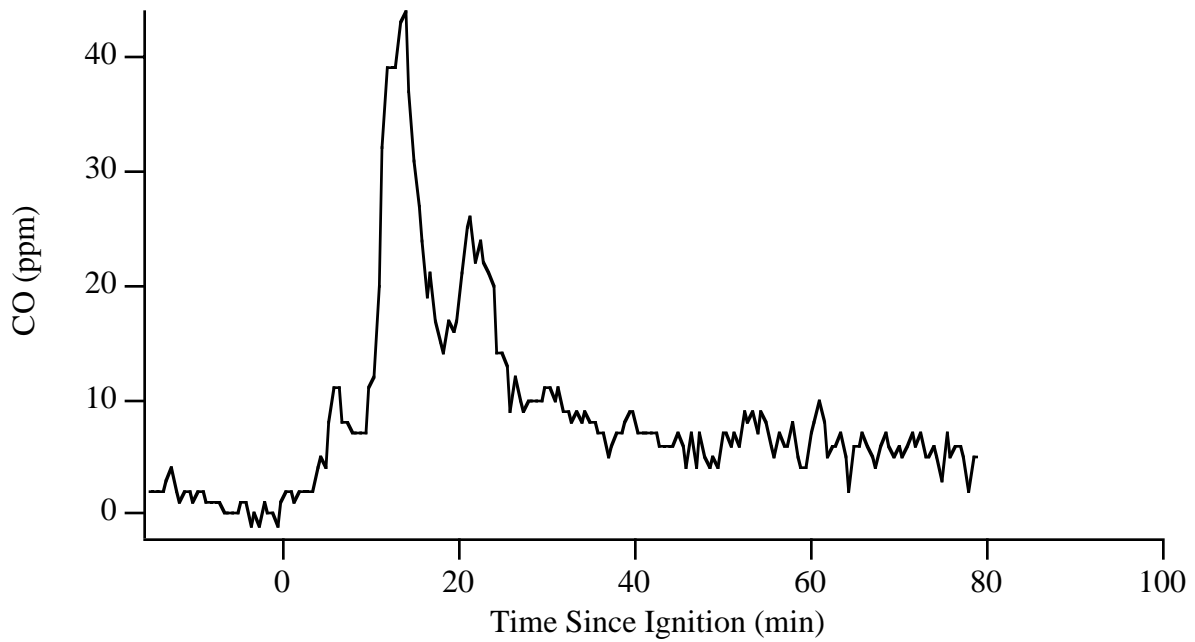

Figure 3-4. CO Results from Test 1

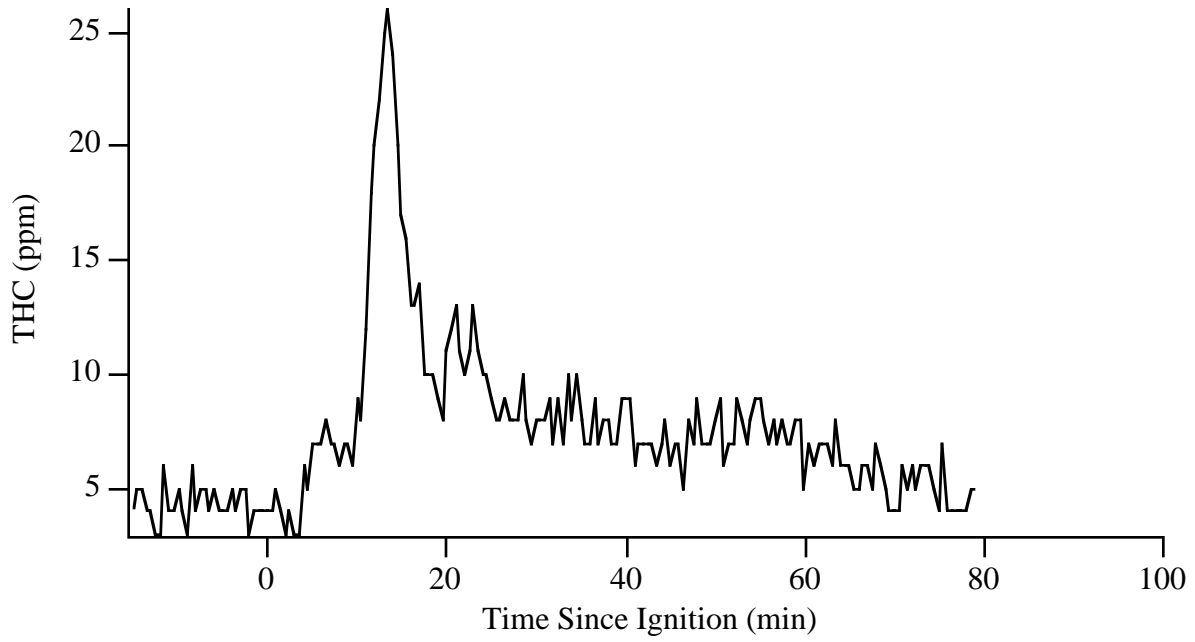

Figure 3-5. THC Results from Test 1

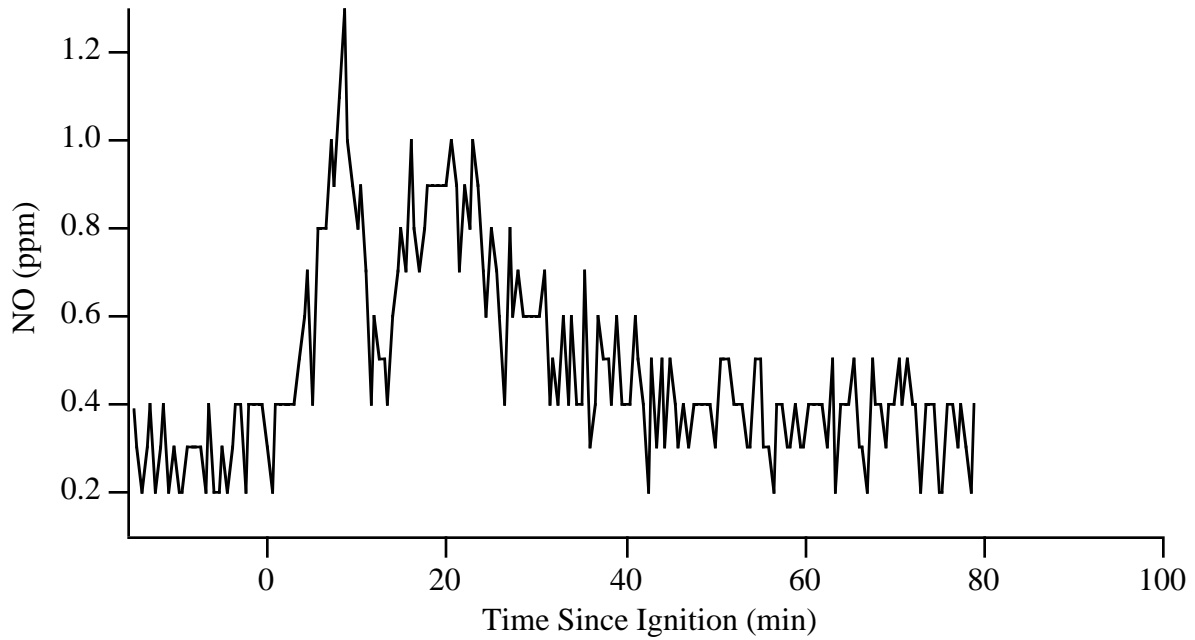

Figure 3-6. NO Results from Test 1

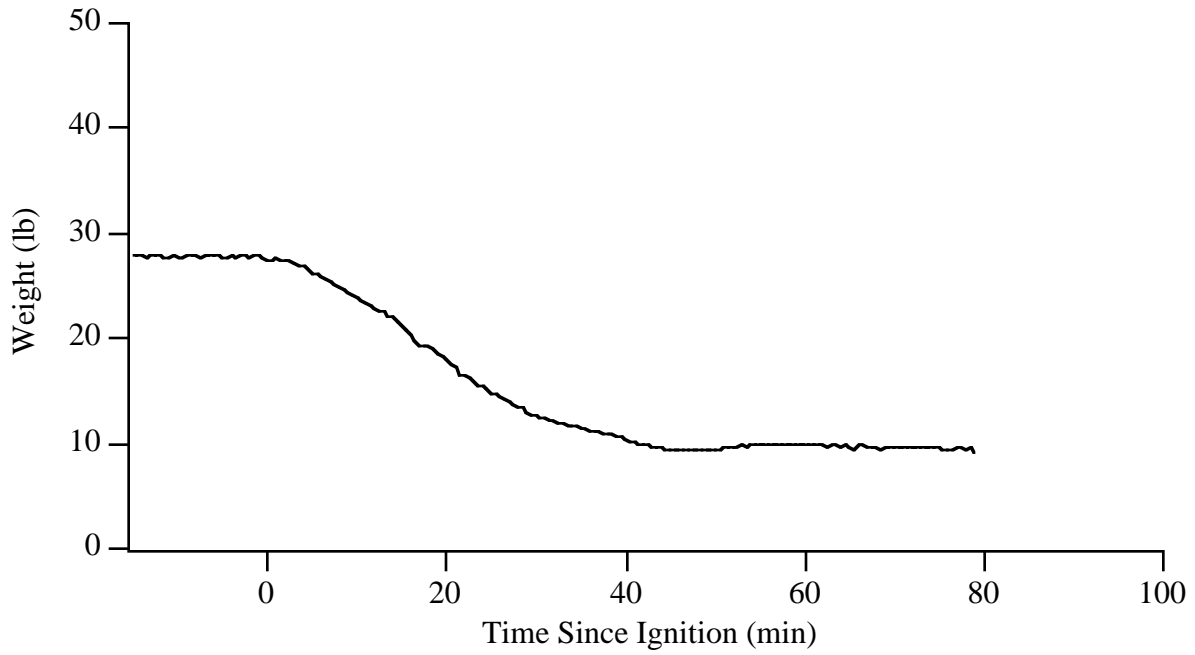

Figure 3-7. Burn Mass Results from Test 1

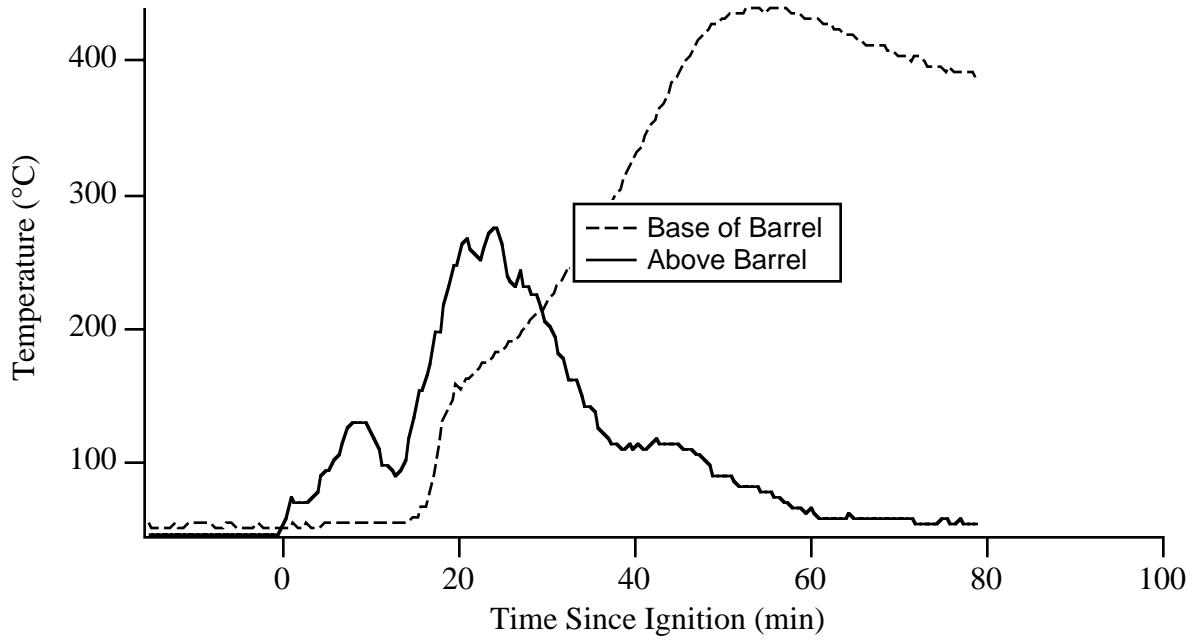

Figure 3-8. Temperature Results from Test 1

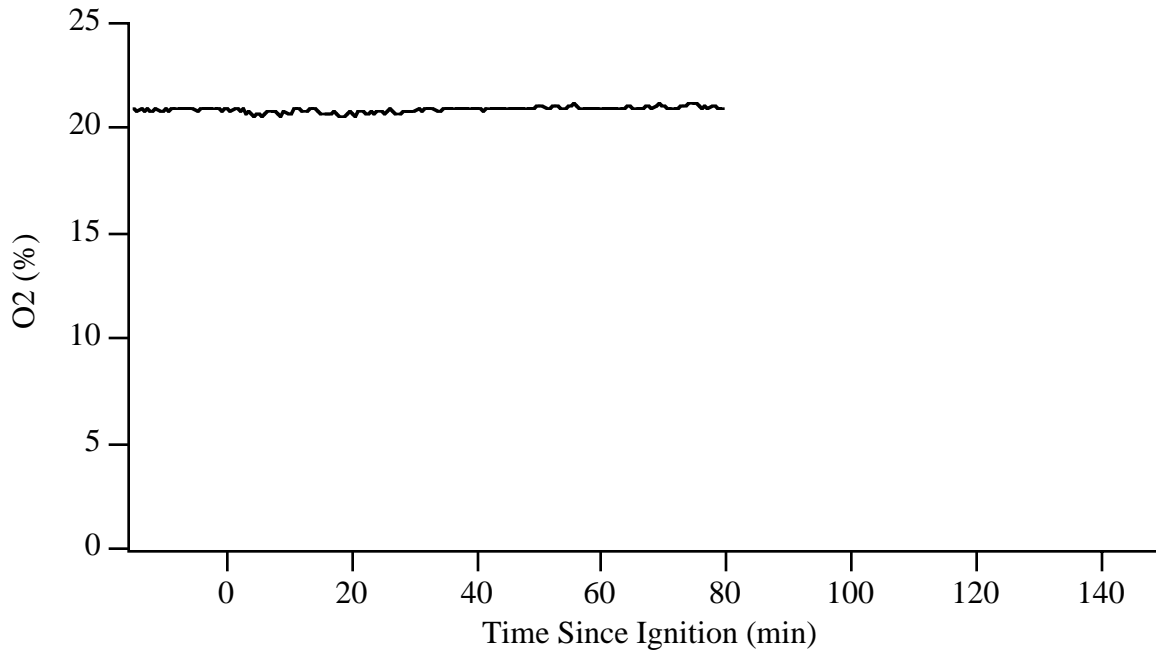

Figure 3-9. O₂ Results from Test 2

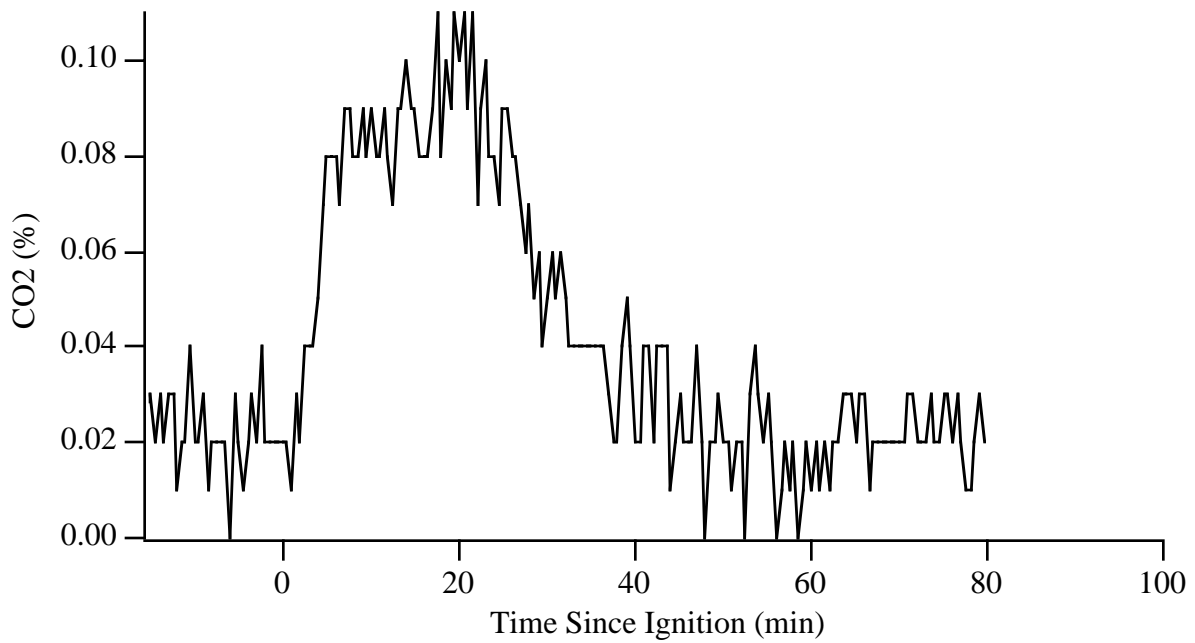

Figure 3-10. CO₂ Results from Test 2

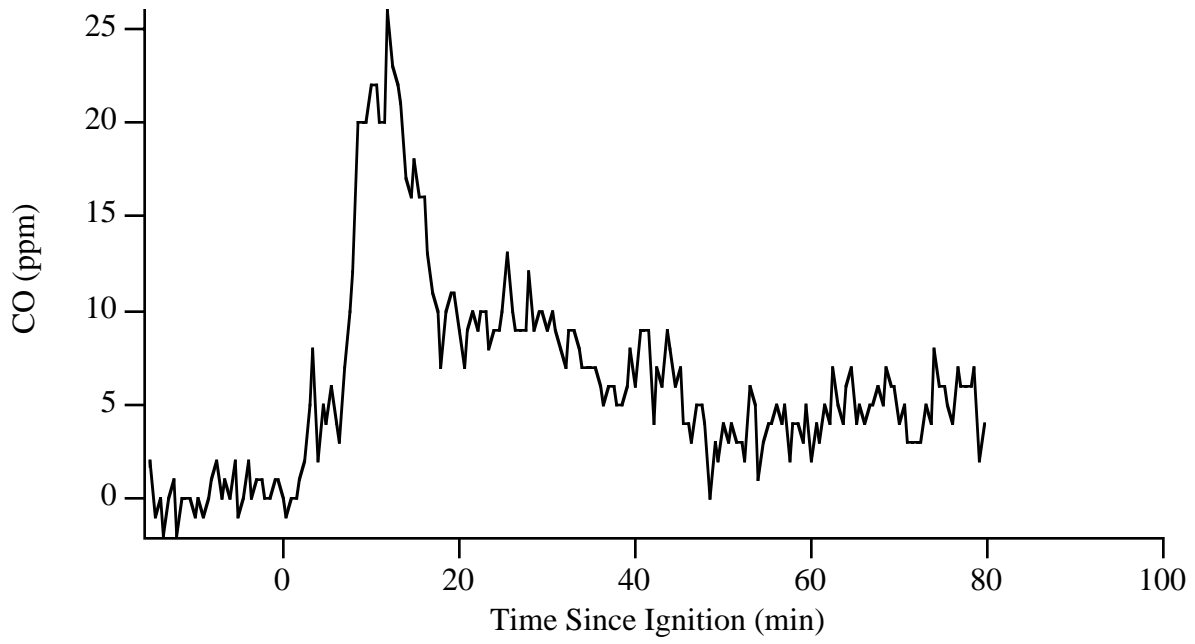

Figure 3-11. CO Results from Test 2

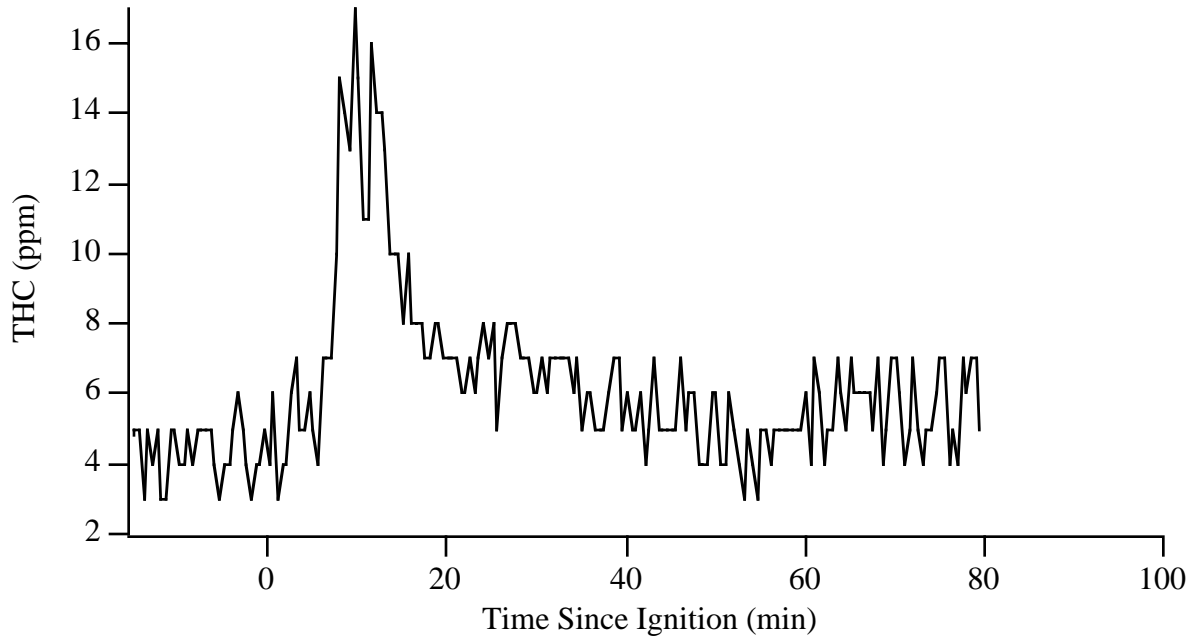

Figure 3-12. THC Results from Test 2

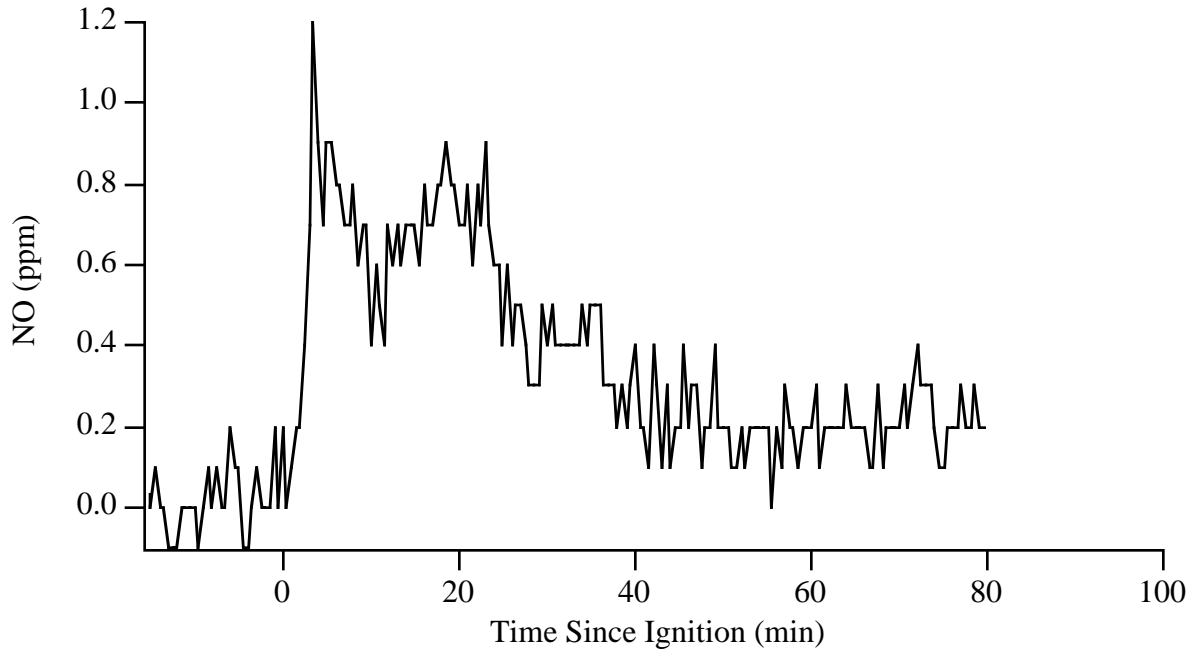

Figure 3-13. NO Results from Test 2

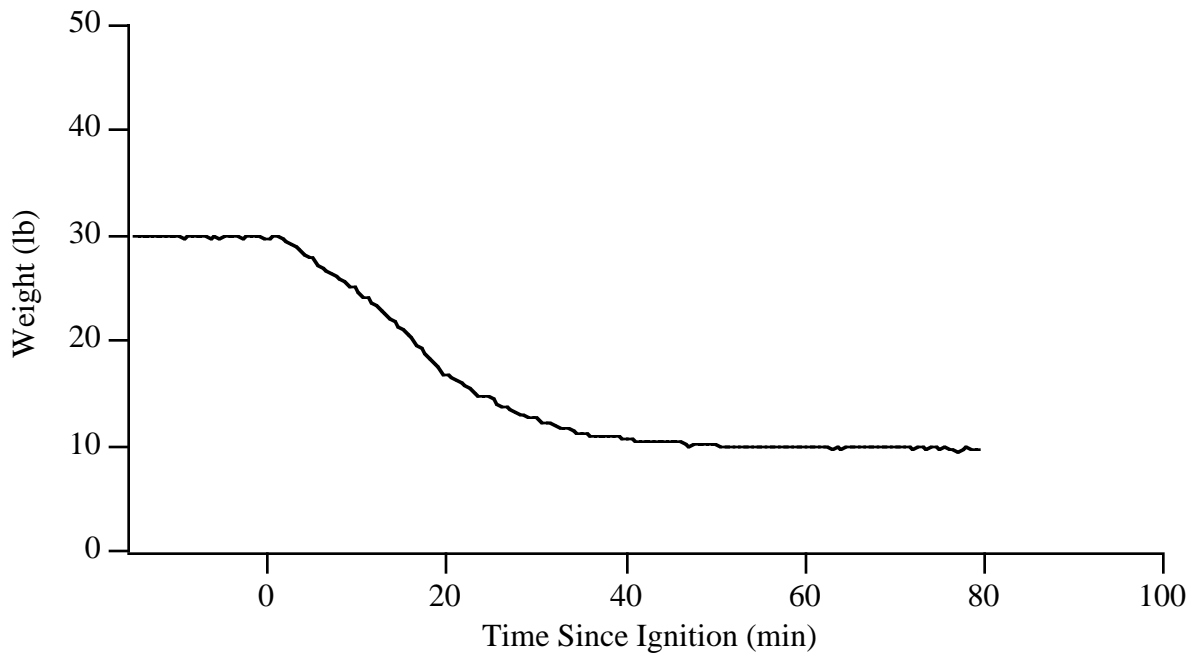

Figure 3-14. Burn Mass Results from Test 2

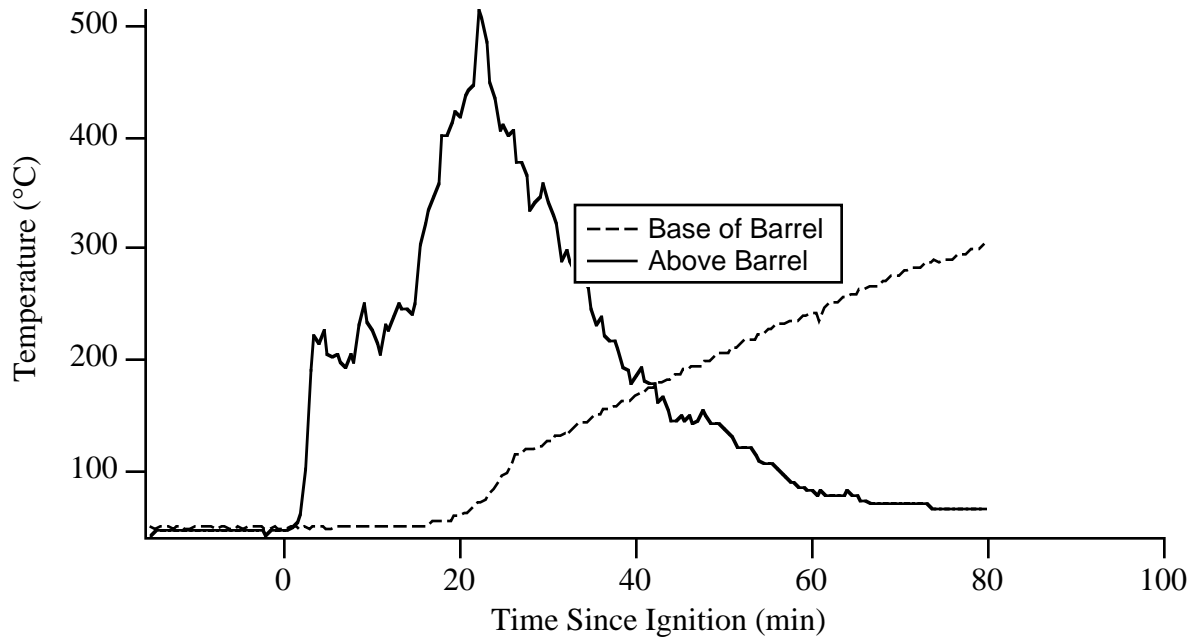

Figure 3-15. Temperature Results from Test 2

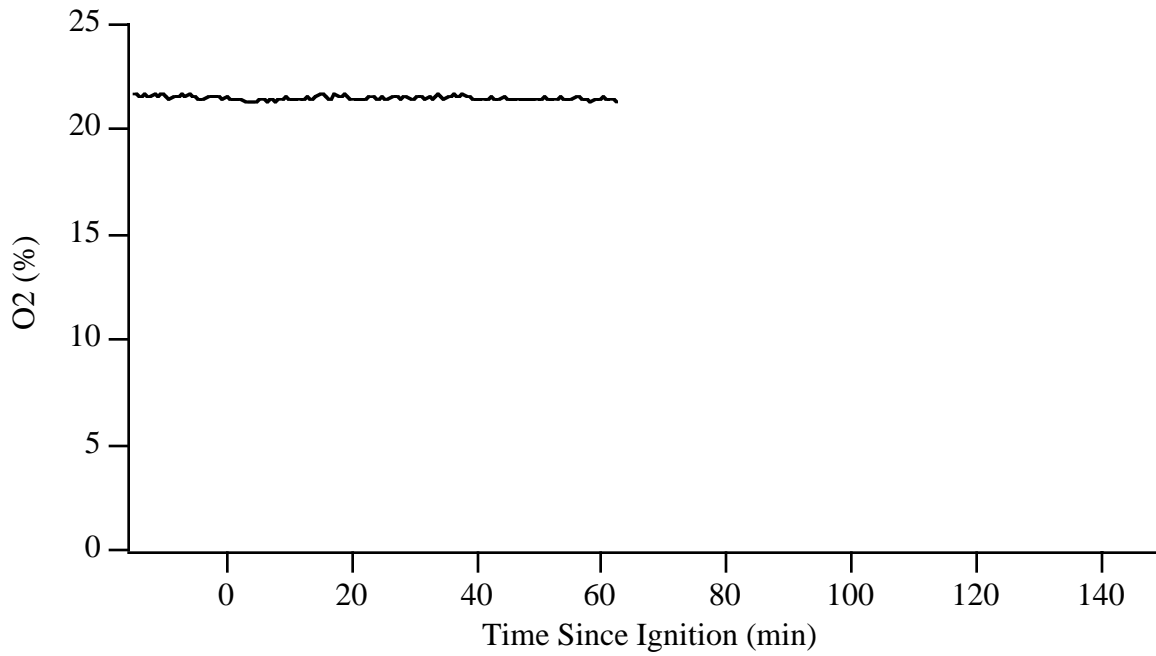

Figure 3-16. O₂ Results from Test 4

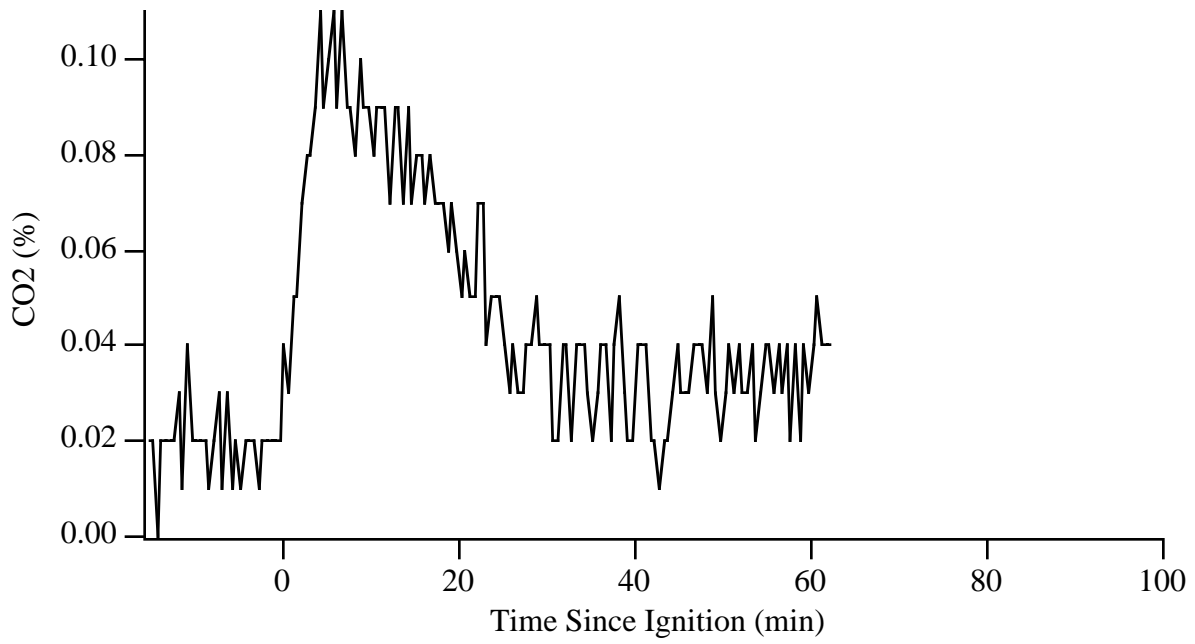

Figure 3-17. CO₂ Results from Test 4

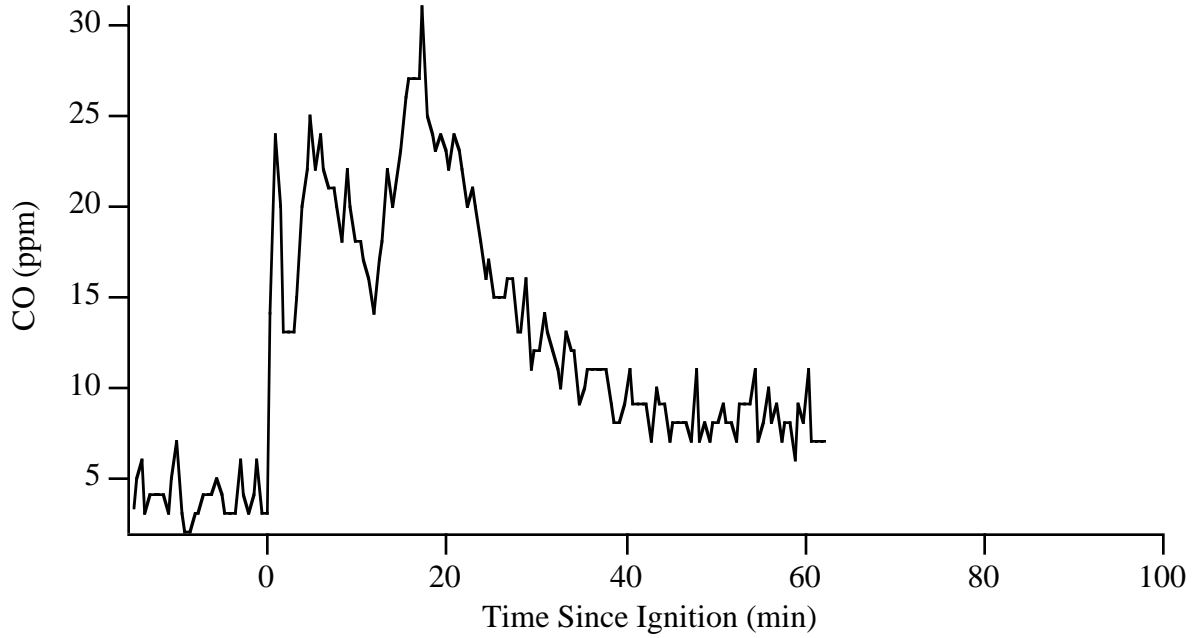

Figure 3-18. CO Results from Test 4

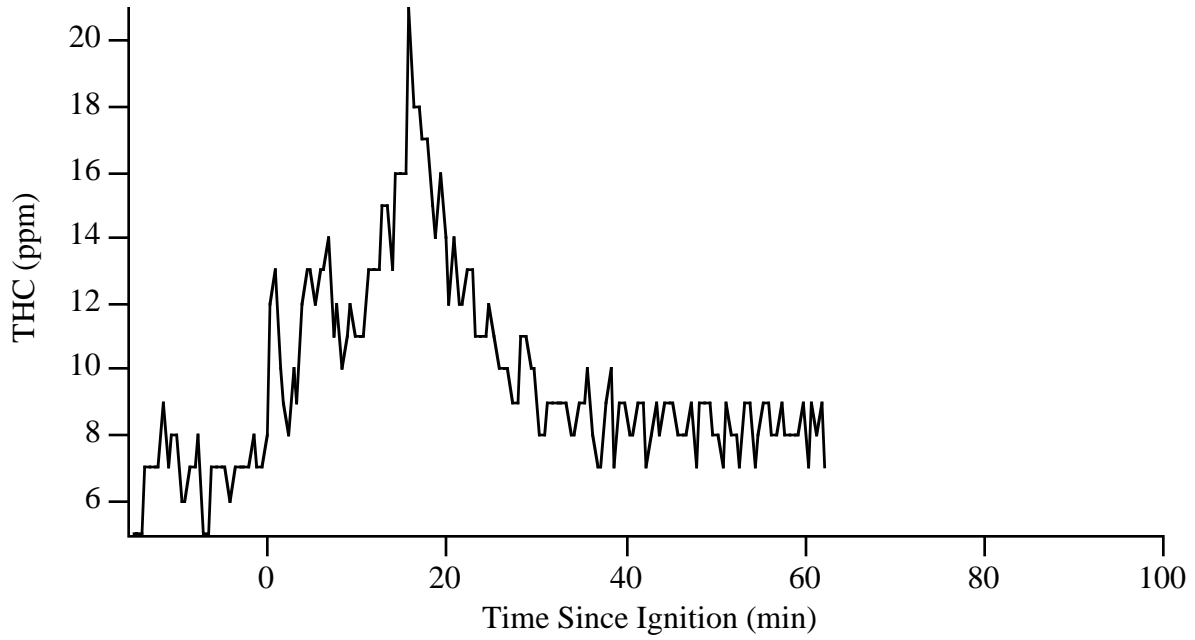

Figure 3-19. THC Results from Test 4

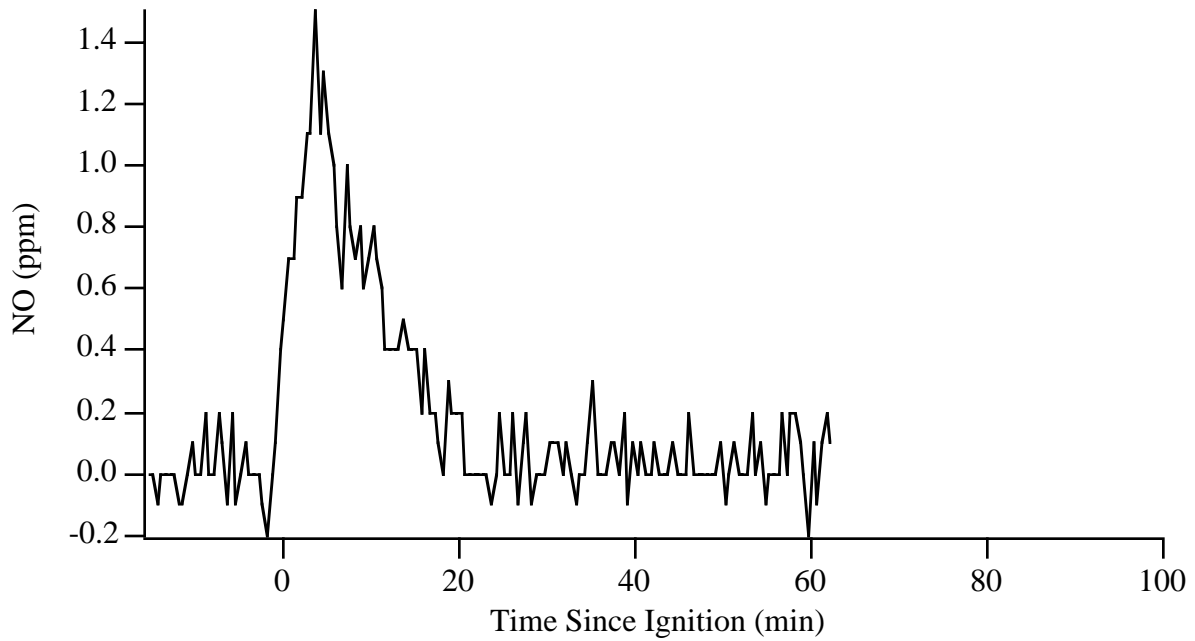

Figure 3-20. NO Results from Test 4

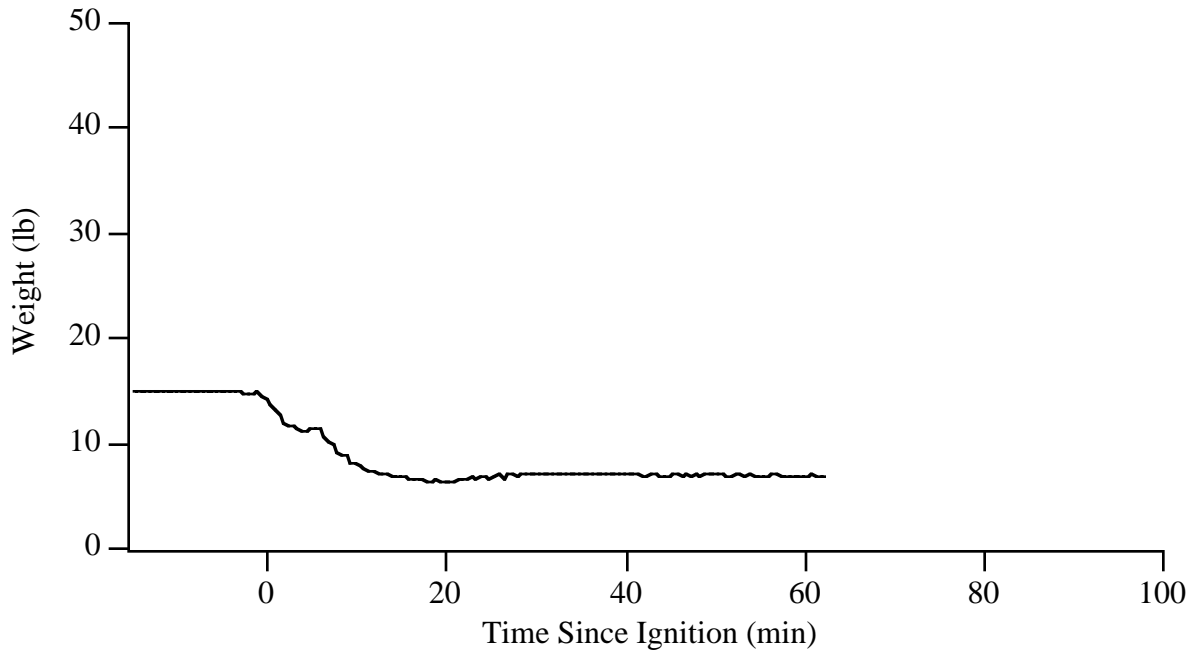

Figure 3-21. Burn Mass Results from Test 4

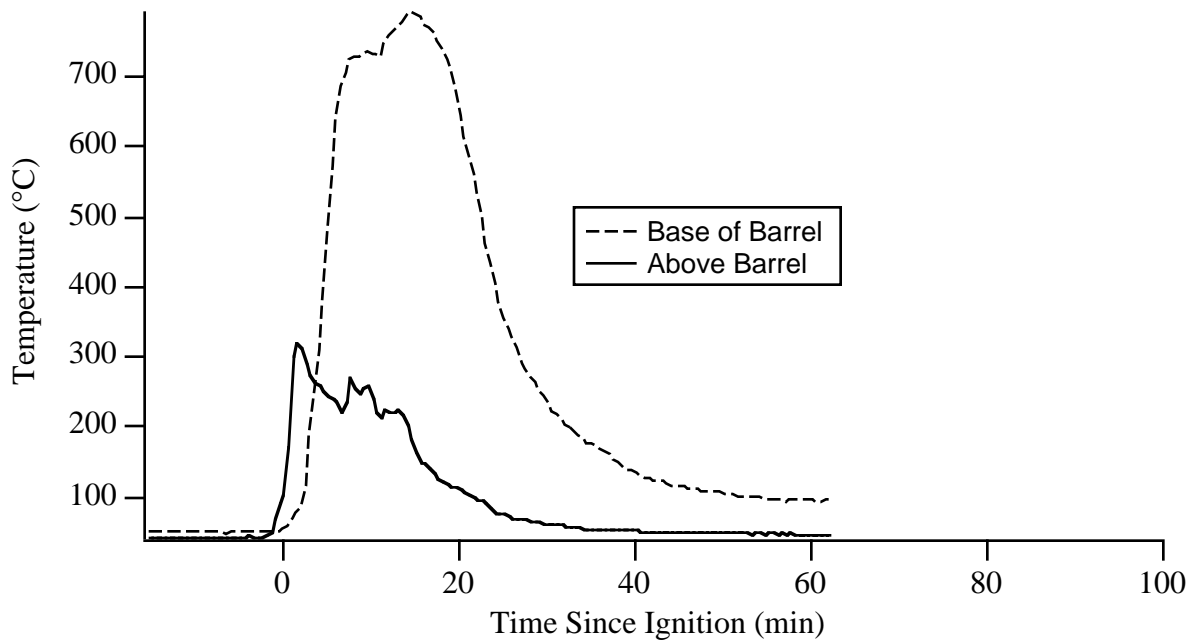

Figure 3-22. Temperature Results from Test 4

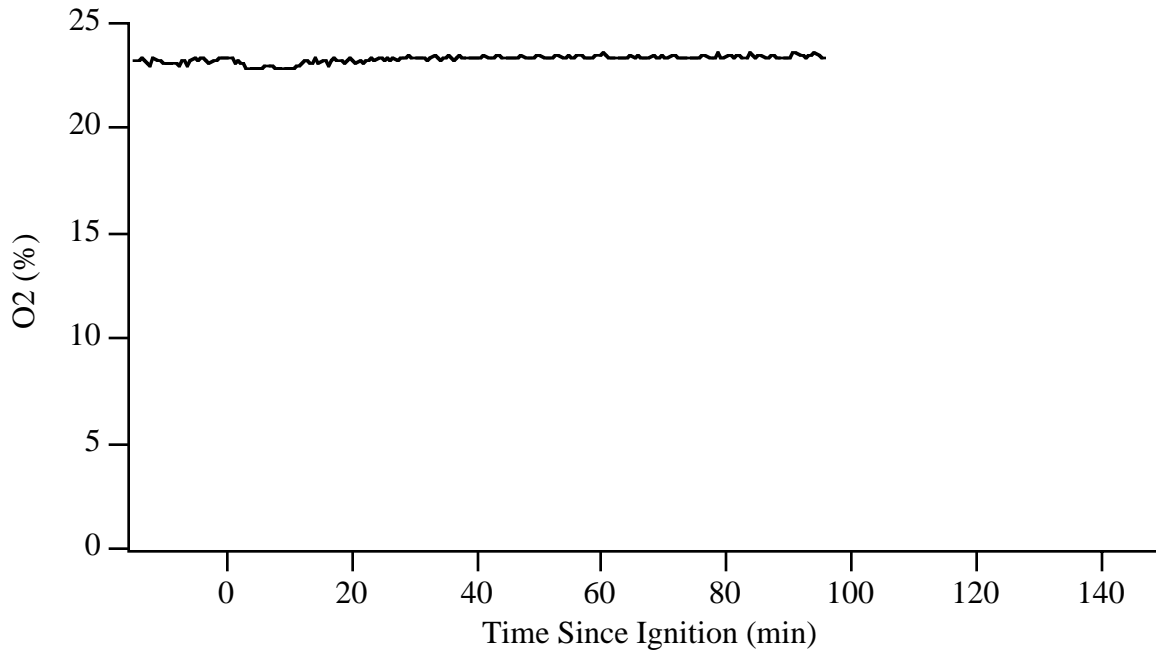

Figure 3-23. O₂ Results from Test 5

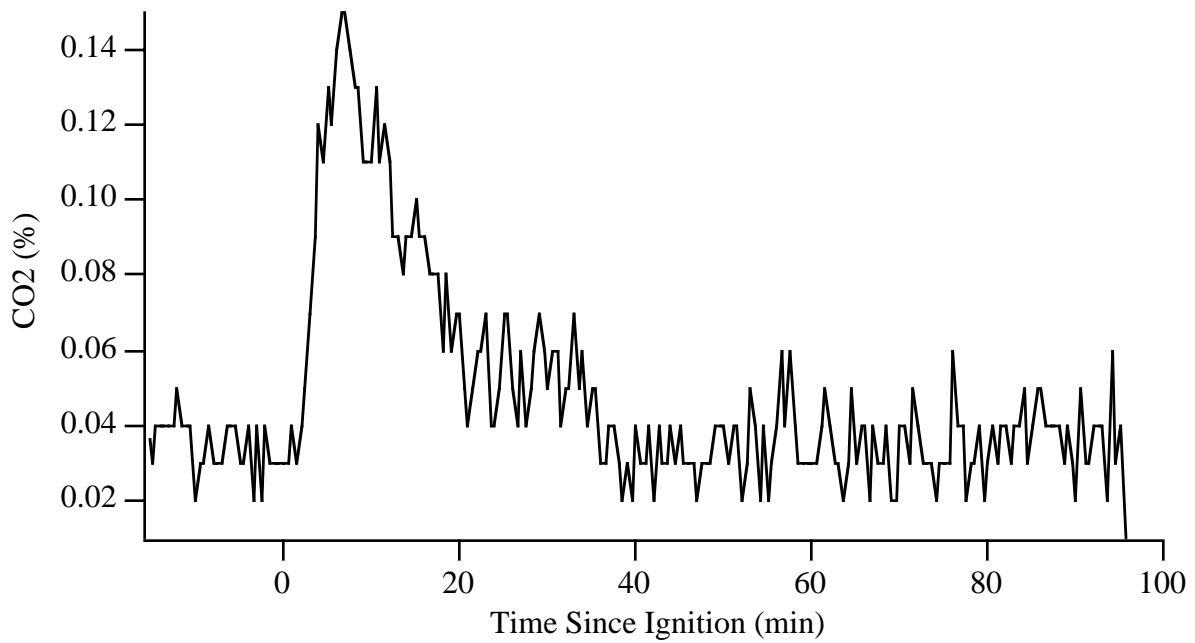

Figure 3-24. CO₂ Results from Test 5

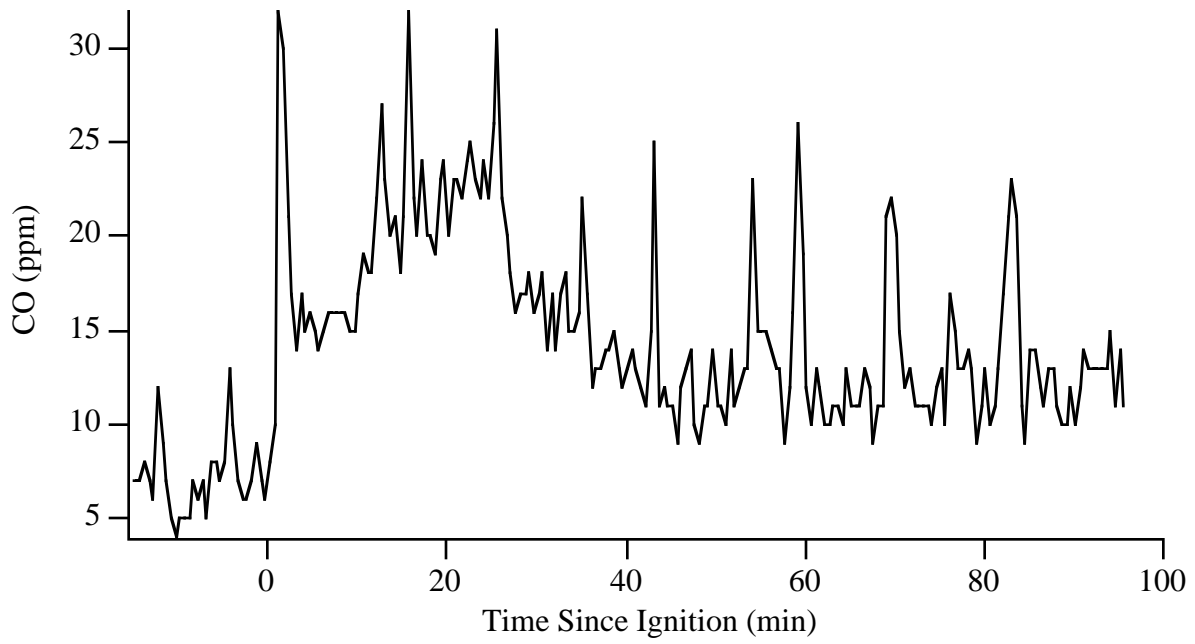

Figure 3-25. CO Results from Test 5

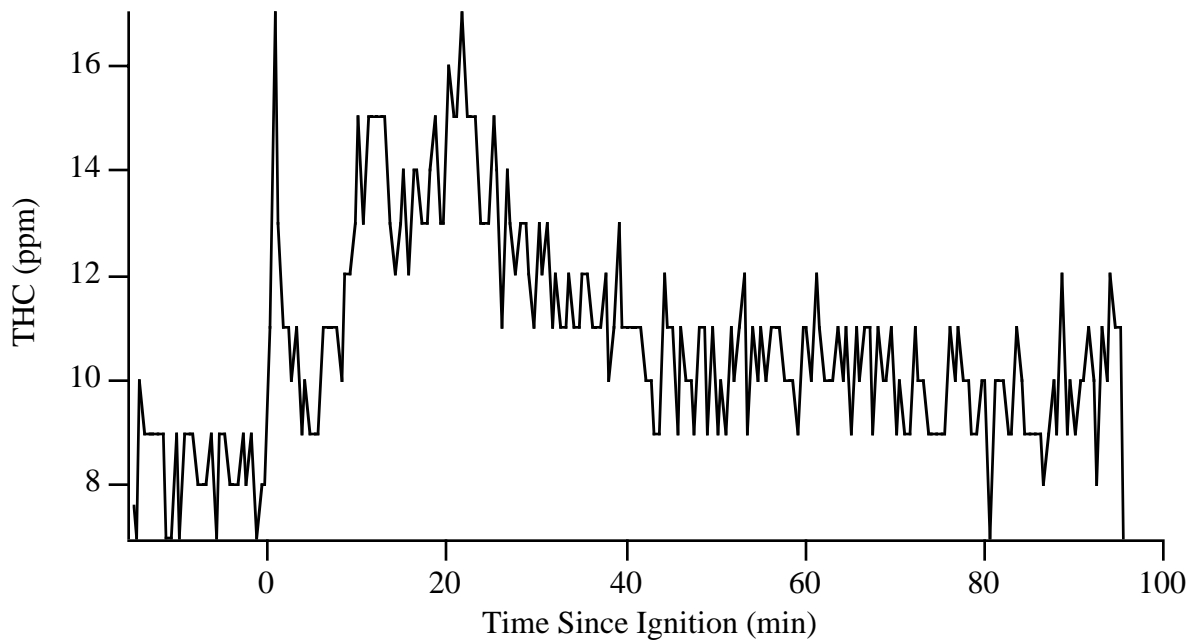

Figure 3-26. THC Results from Test 5

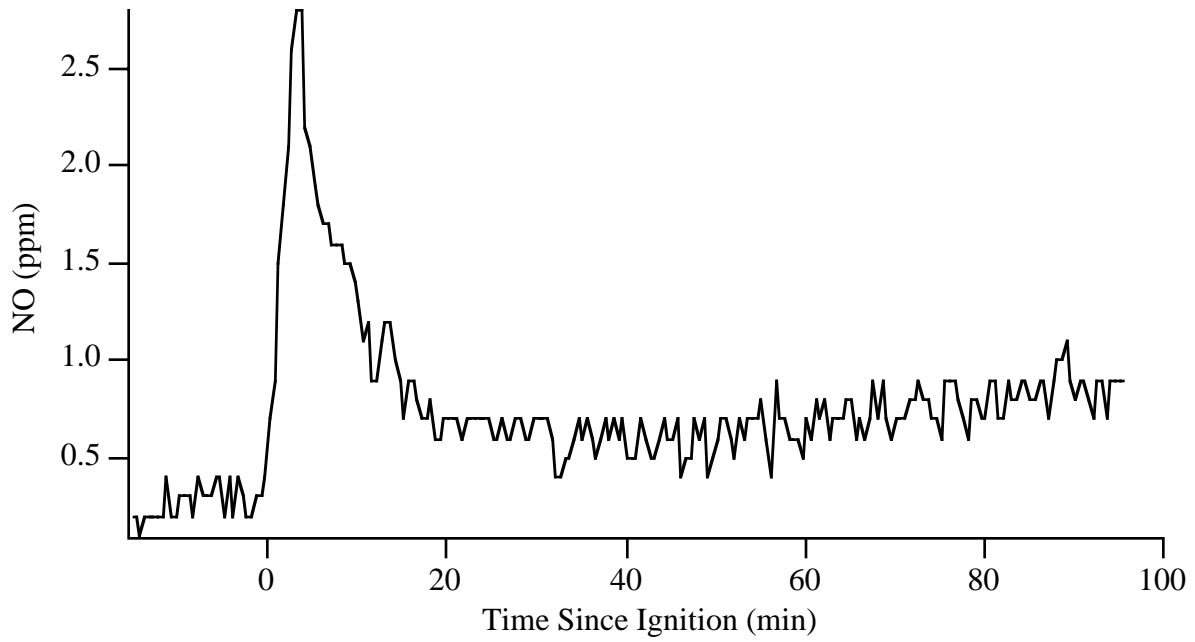

Figure 3-27. NO Results from Test 5

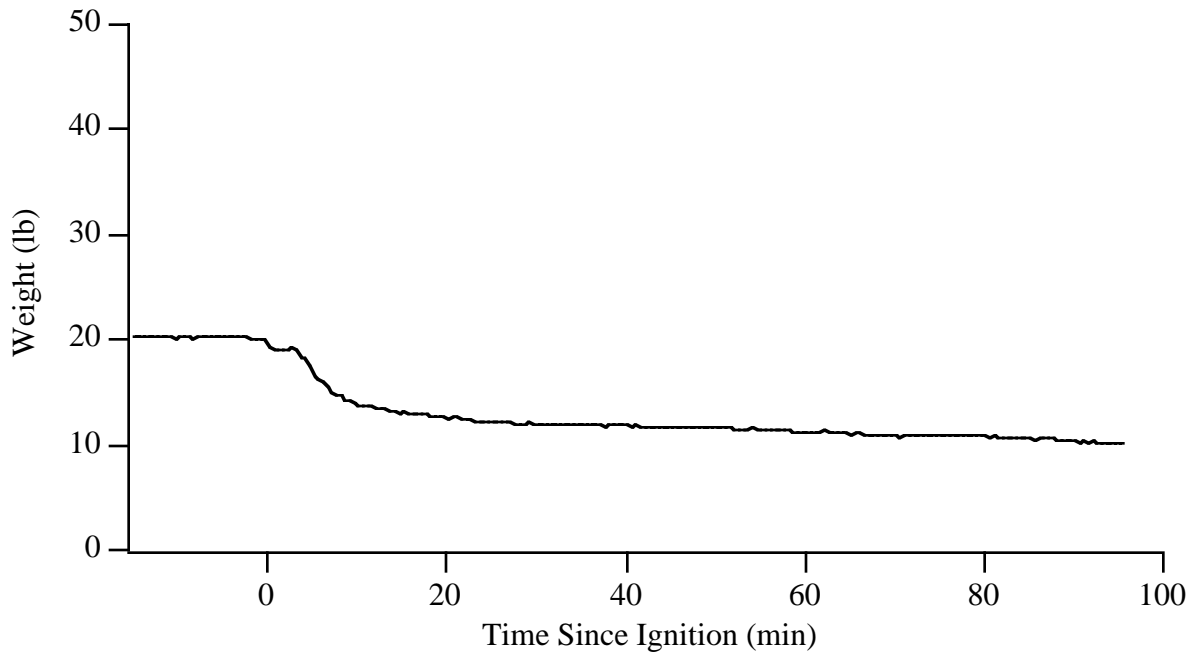

Figure 3-28. Burn Mass Results from Test 5

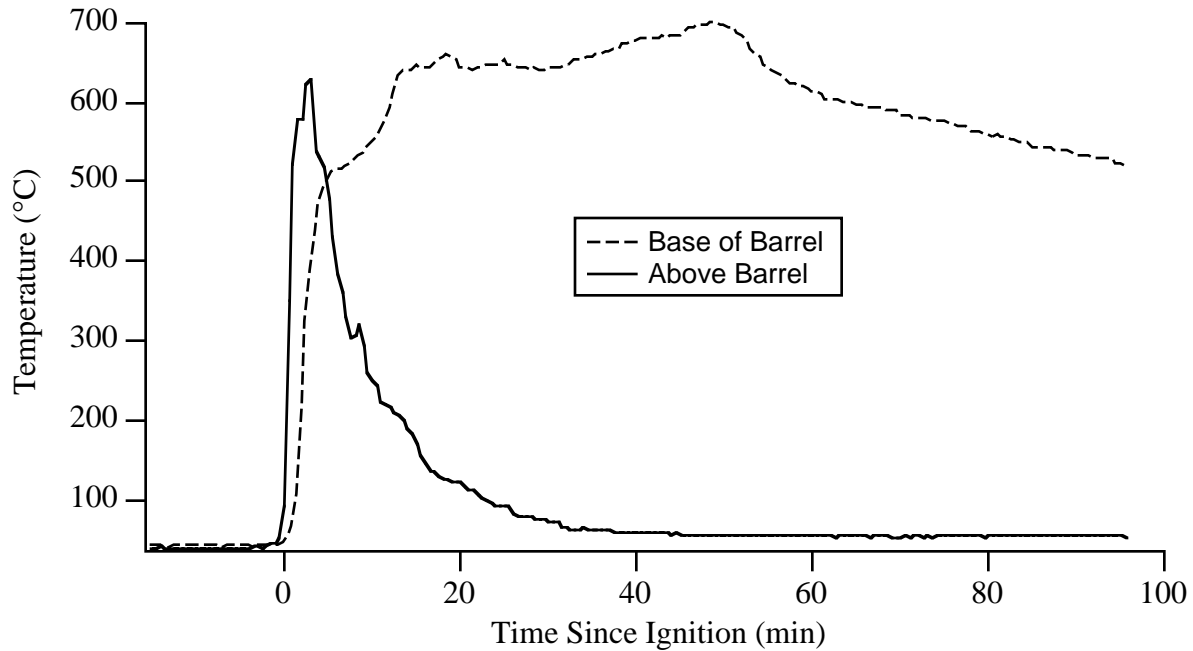

Figure 3-29. Temperature Results from Test 5

3.2 Volatile Organic Compound Analytical Results

Table 3-2 lists the results from the analysis of the targeted VOC compounds. A considerable portion of those compounds were found to be below the method detection limit (MDL). However, a number of them were detected at elevated levels, and it is apparent that, on a mass emitted per mass of material burned basis, emissions from the non-recycler are higher than the emissions from the avid recycler. Figure 3-30 illustrates the difference between emissions of VOCs from the two different waste streams by plotting the average of the estimated emissions per unit mass burned of those VOCs that were detected at levels above the detection limits for both the avid recycler and the non-recycler. If converted into mass emissions per day or per person, emissions of VOCs from non-recyclers would be even higher relative to avid recyclers. Of particular note is the observation that benzene emissions are approximately 1 g/kg of waste burned, which could potentially be significant, given that benzene has been implicated as a carcinogen.

In addition to the target VOC compounds, a spectral library search was also performed to identify the unknown peaks. Table 3-3 lists the tentatively identified compounds (TICs) in the volatile range. Again, those compounds that were present in both the avid recycler and non-recycler samples were consistently higher for the non-recycler.

Table 3-2. Estimated emissions of targeted volatile organic compounds, mg/kg

Test No.	1 Avid Recycler	2 Avid Recycler	4 Non- Recycler	5 Non- Recycler
1,1,1-Trichloroethane	<0.4	<0.4	<1	<1
1,1,2,2-Tetrachloroethane	<0.4	<0.4	<1	<1
1,1,2-Trichloroethane	<0.4	<0.4	<1	<1
1,1-Dichloroethane	<0.4	<0.4	<1	<1
1,1-Dichloroethene	<0.4	<0.4	<1	<1
1,2,4-Trichlorobenzene	<0.4	<0.4	<1	<1
1,2,4-Trimethylbenzene	<0.4	<0.4	<1	<1
1,2-Dibromoethane	<0.4	<0.4	<1	<1
1,2-Dichlorobenzene	<0.4	<0.4	<1	<1
1,2-Dichloroethane	<0.4	<0.4	<1	<1
1,2-Dichloropropane	<0.4	<0.4	<1	<1
1,3,5-Trimethylbenzene	<0.4	<0.4	<1	<1
1,3-Butadiene	162	60	195	148
1,3-Dichlorobenzene	<0.4	<0.4	<1	<1
1,4-Dichlorobenzene	<0.4	<0.4	<1	<1
2-Butanone	<0.4	<0.4	59	96
3-Methylpentane	<0.4	<0.4	<1	<1
4-Ethyltoluene	<0.4	<0.4	<1	<1
4-Methyl-2-Pentanone	<0.4	<0.4	<1	<1
Acetone	234	139	1346	529
Benzene	1068	378	1765	708
Benzyl Chloride	<0.4	<0.4	<1	<1
Bromomethane	<0.4	<0.4	<1	<1
Butyl Acetate	<0.4	<0.4	<1	<1
Butyl Methyl Ether	<0.4	<0.4	<1	<1
Carbon Disulfide	<0.4	<0.4	<1	<1
Carbon Tetrachloride	<0.5	<0.5	<1.2	<1.2
Chlorobenzene	<0.4	<0.4	<1	<1
Chloroethane	<0.6	<0.5	<1.3	<1.3
Chloroform	<0.5	<0.4	<1.1	<1.1
Chloromethane	138	136	263	116
cis-1,2-Dichloroethene	<0.4	<0.4	<1	<1
cis-1,3-Dichloropropene	<0.4	<0.4	<1	<1
Decane	<0.4	<0.4	<1	<1
Dichlorodifluoromethane	<0.5	<0.4	<1.1	<1.1
Dichlorotetrafluoroethane	<0.9	<0.8	<2.1	<2.1
Dichlorotrifluoroethane	<0.4	<0.4	<1	<1
Dimethyl Disulfide	<0.4	<0.4	<1	<1
Dodecane	<0.4	<0.4	<1	<1
Ethyl Acetate	<0.4	<0.4	<1	<1
Ethyl Benzene	138	51	422	116
Hexachlorobutadiene	<0.4	<0.4	<1	<1
Limonene	<0.4	<0.4	<1	<1

(continued)

Table 3-2 (continued). Estimated emissions of targeted volatile organic compounds, mg/kg

Test No.	1 Avid Recycler	2 Avid Recycler	4 Non- Recycler	5 Non- Recycler
m,p-Xylene	87	<0.4	<1	<1
Methylene Chloride	<0.7	68	<1.7	<1.7
Naphthalene	150	53	262	110
Nonane	<0.4	<0.4	<1	<1
o-Xylene	65	<0.4	<1	<1
Octane	<0.4	<0.4	<1	<1
Pinene	<0.4	<0.4	<1	<1
Styrene	465	176	1210	259
Tetrachloroethene	<0.4	<0.4	<1	<1
Toluene	409	128	625	326
trans-1,3-Dichloropropene	<0.4	<0.4	<1	<1
Trichloroethene	<0.4	<0.4	<1	<1
Trichlorofluoromethane	<0.4	<0.4	<1	<1
Trichlorotrifluoroethane	<0.4	<0.4	<1	<1
Undecane	<0.4	<0.4	<1	<1
Vinyl Chloride	<0.4	<0.4	<1	<1
Total (excluding non-detects)	2916	1189	6147	2408

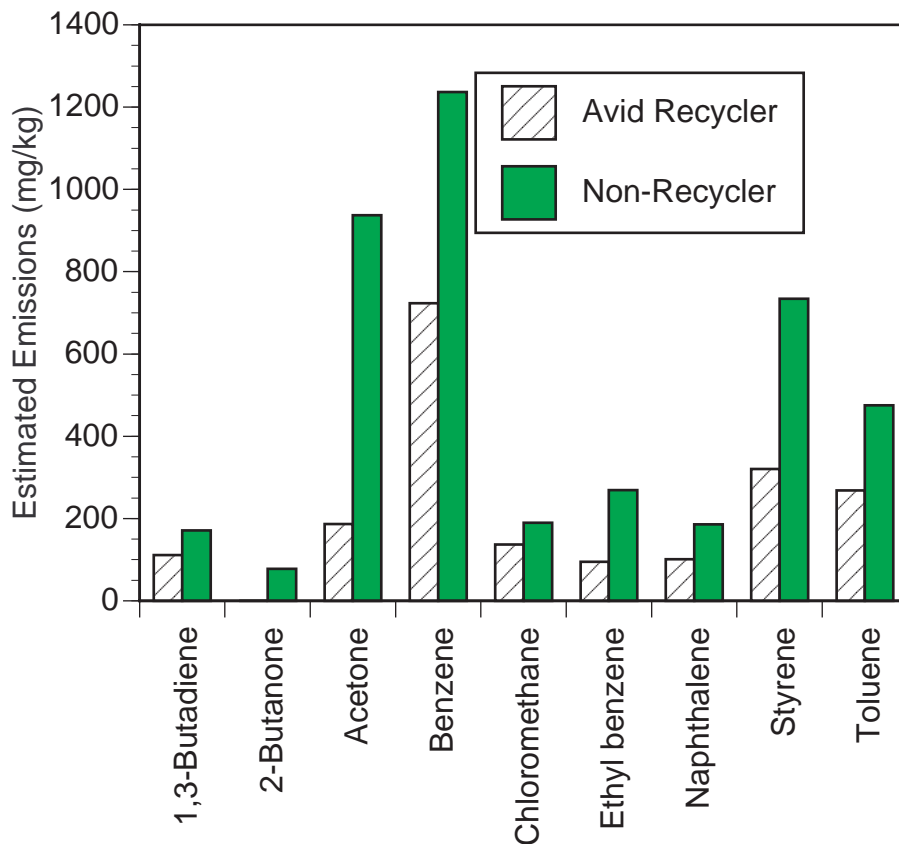

Figure 3-30. Average emissions of selected target VOCs.

Table 3-3. Estimated emissions of tentatively identified VOC compounds, mg/kg

Compound	Avid Recycler	Avid Recycler	Non-Recycler	Non-Recycler
Propene	1878	1444	5514	3499
Butene	699	252	1272	1060
Pentene	140	-	-	223
Pentane	236	-	-	-
Substituted Pentadiene	157	-	-	-
Substituted Dihydromethylenefurandione	236	276	3499	1803
1,3-Cyclopentadiene	135	87	424	223
2-Methyl-1-pentene	306	124	-	318
Substituted Methylfuran	218	243	3605	2015
Substituted Methylbutenone	-	-	467	276
2,5-Dimethylfuran	-	-	424	276
2-Furancarboxaldehyde	245	107	933	848
2-Cyclopenten-1-one	-	-	233	170
Substituted Methylcyclopentanone	-	-	159	127
Substituted Methylethylbenzene	131	-	594	-
Benzaldehyde	240	49	-	127
5-Methyl-3-furancarboxaldehyde	-	-	-	170
Benzofuran	92	-	159	-
Phenol	402	-	-	-
Substituted Ethynylmethylbenzene	258	54	233	127
Total (excluding non-detects)	5373	2636	17516	11262

3.3 Semivolatile Organic Compound Analytical Results

Table 3-4 lists the results from the analysis of the targeted SVOCs as performed by Acurex, and Table 3-5 lists the results from the NYSDOH's WCL&R laboratory. Like the VOCs, a major portion of the SVOC target compounds were found to be below the MDL. However, a number of them were detected at elevated levels, and it is apparent that, with the exception of 2-Methylnaphthalene, emissions from the non-recycler are higher than the emissions from the avid-recycler. Figure 3-31 illustrates the difference between emissions of SVOCs from the two different waste streams by plotting the average of the estimated emissions per unit mass burned of those SVOCs that were detected at levels above the detection limits for both the avid recycler and the non-recycler. The data in Figure 3-31 were derived by examining compounds that were quantified from both tests in both laboratory analyses, and averaging the results. Another observation is that there appears to be reasonable agreement between the two laboratories on those compounds present in relatively high concentrations.

Table 3-4. Estimated emissions of semivolatile organics as analyzed by Acurex, g/kg

Test No.	1 Avid Recycler	2 Avid Recycler	4 Non- Recycler	5 Non- Recycler
1,2,4,5 Tetrachlorobenzene	<0.0004	<0.0018	<0.0025	<0.0018
1,2,4-Trichlorobenzene	<0.0004	<0.0018	<0.0025	<0.0018
1,2-Dichlorobenzene	<0.0004	0.0005 J	<0.0025	<0.0018
1,3 Dinitrobenzene	<0.0004	<0.0018	<0.0025	<0.0018
1,3,5-Trinitrobenzene	<0.0004	<0.0018	<0.0025	<0.0018
1,3-Dichlorobenzene	<0.0004	<0.0018	<0.0025	<0.0018
1,4-Dichlorobenzene	<0.0004	<0.0018	<0.0025	<0.0018
1,4-Naphthoquinone	<0.0004	<0.0018	<0.0025	<0.0018
1-Naphthylamine	<0.0004	<0.0018	<0.0025	<0.0018
1-Nitrosopiperidine	<0.0004	<0.0018	<0.0025	<0.0018
2,3,4,6-Tetrachlorophenol	<0.0004	<0.0018	<0.0025	<0.0018
2,4,5-Trichlorophenol	<0.0004	<0.0018	<0.0025	<0.0018
2,4,6-Trichlorophenol	<0.0004	<0.0018	<0.0025	<0.0018
2,4-Dimethylphenol	0.0042	0.0066 J ^a	0.0172	<0.0018
2,4-Dinitrophenol	<0.0004	<0.0018	<0.0025	<0.0018
2,4-Dinitrophenol	<0.0004	<0.0018	<0.0025	<0.0018
2,4_Dichlorophenol	<0.0004	<0.0018	<0.0025	<0.0018
2,6-Dichlorophenol	<0.0004	<0.0018	<0.0025	<0.0018
2,6-Dinitrotoluene	<0.0004	<0.0018	<0.0025	<0.0018
2-Acetylaminofluorene	<0.0004	<0.0018	<0.0025	<0.0018
2-Chlorophenol	0.0004 J	0.0015 J	<0.0025	0.0015 J
2-Chloronaphthalene	<0.0004	<0.0018	<0.0025	<0.0018
2-Methyl-4,6-dinitrophenol	<0.0004	<0.0018	<0.0025	<0.0018
2-Methylnaphthalene	0.0026 J	0.018	0.0068 J	0.0094 J
2-Methylphenol	0.0057	0.0252	0.0343	0.0212
2-Naphthylamine	<0.0004	<0.0018	<0.0025	<0.0018

(continued)

Table 3-4 (continued). Estimated emissions of semivolatile organics as analyzed by Acurex, g/kg

Test No.	1 Avid Recycler	2 Avid Recycler	4 Non- Recycler	5 Non- Recycler
2-Nitroaniline	<0.0004	<0.0018	<0.0025	<0.0018
2-Nitrophenol	<0.0004	<0.0018	<0.0025	<0.0018
3,3'-Dichlorobenzidine	<0.0004	<0.0018	<0.0025	<0.0018
3,3'-Dimethylbenzidine	<0.0004	<0.0018	<0.0025	<0.0018
3-Methylcholanthrene	<0.0004	<0.0018	<0.0025	<0.0018
4-Aminobiphenyl	<0.0004	<0.0018	<0.0025	<0.0018
4-Bromophenyl phenyl ether	<0.0004	<0.0018	<0.0025	<0.0018
4-Chloro-3-methyl-phenol	<0.0004	<0.0018	<0.0025	<0.0018
4-Chloroaniline	<0.0004	<0.0018	<0.0025	<0.0018
4-Chlorophenyl phenyl ether	<0.0004	<0.0018	<0.0025	<0.0018
4-Methylphenol	0.0101	0.0435	0.0586	0.0692
4-Nitroaniline	<0.0004	<0.0018	<0.0025	<0.0018
4-Nitrophenol	<0.0004	<0.0018	<0.0025	<0.0018
5-Nitro-o-toluidine	<0.0004	<0.0018	<0.0025	<0.0018
Acenaphthene	<0.0004	0.0013 J	0.0015 J	0.001 J
Acenaphthylene	0.0062	0.0184	0.028	0.0184
Acetophenone	0.0019 J	0.0064 J	0.0035 J	0.0079 J
Aniline	<0.0004	<0.0018	<0.0025	<0.0018
Anthracene	0.0015 J	0.0039 J	0.0054 J	0.0031 J
Benzo (a) anthracene	0.0026 J	0.0006 J	0.0025 J	0.0014 J
Benzo (a) pyrene	0.0016 J	<0.0018	0.0027 J	0.0012 J
Benzo (b) fluoranthene	<0.0004	<0.0018	<0.0025	<0.0018
Benzo (ghi) perylene	0.0011 J	<0.0018	0.002 J	<0.0018
Benzo (k) fluoranthene	0.0005 J	<0.0018	<0.0025	<0.0018
Benzyl Alcohol	<0.0004	0.0023 J	0.0043 J	0.0075 J
Benzyl butyl phthalate	0.0013 J	0.0012 J	0.0037 J	0.0038
bis (2-Chloroethoxy) methane	<0.0004	<0.0018	<0.0025	<0.0018
bis (2-Chloroisopropyl) ether	<0.0004	<0.0018	<0.0025	<0.0018
bis-(2-Chloroethyl) ether	<0.0004	<0.0018	<0.0025	<0.0018
Chlorobenzilate	<0.0004	<0.0018	<0.0025	<0.0018
Chrysene	0.0032 J	0.0006 J	0.0031 J	0.0016 J
Di-n-butyl phthalate	0.0015 J	0.0032 J	0.0035 J	0.0153 J
Di-n-octyl phthalate	<0.0004	<0.0018	<0.0025	<0.0018
Diallate	<0.0004	<0.0018	<0.0025	<0.0018
Dibenz (a,h) anthracene	0.0004 J	<0.0018	<0.0025	<0.0018
Dibenzofuran	0.0014 J	0.0045 J	0.0053 J	0.0034 J
Diethyl phthalate	0.0005 J	0.0007 J	0.0036 J	0.0018 J
Dinoseb	<0.0004	<0.0018	<0.0025	<0.0018
Diphenylamine	<0.0004	<0.0018	<0.0025	<0.0018
Ethyl Methanesulfonate	<0.0004	<0.0018	<0.0025	<0.0018
Fluoranthene	0.0031 J	0.0034 J	0.0083 J	0.0044 J
Fluorene	0.0016 J	0.007 J	0.0072 J	0.0046 J
Hexachlorobenzene	<0.0004	<0.0018	<0.0025	<0.0018

(continued)

Table 3-4 (continued). Estimated emissions of semivolatile organics as analyzed by Acurex, g/kg

Test No.	1 Avid Recycler	2 Avid Recycler	4 Non- Recycler	5 Non- Recycler
Hexachlorobutadiene	<0.0004	<0.0018	<0.0025	<0.0018
Hexachlorocyclopentadiene	<0.0004	<0.0018	<0.0025	<0.0018
Hexachloroethane	<0.0004	<0.0018	<0.0025	<0.0018
Hexachloropropene	<0.0004	<0.0018	<0.0025	<0.0018
Isodrin	<0.0004	<0.0018	<0.0025	<0.0018
Isophorone	<0.0004	<0.0018	<0.0025	0.037
Isosafrole	<0.0004	<0.0018	<0.0025	<0.0018
Methyl Methanesulfonate	<0.0004	<0.0018	<0.0025	<0.0018
n-Nitrosodi-n-butylamine	<0.0004	<0.0018	<0.0025	<0.0018
n-Nitrosodi-n-propylamine	<0.0004	<0.0018	<0.0025	<0.0018
n-Nitrosodiethylamine	<0.0004	<0.0018	<0.0025	<0.0018
n-Nitrosomethylethylamine	<0.0004	<0.0018	<0.0025	<0.0018
n-Nitrosopyrrolidine	<0.0004	<0.0018	<0.0025	<0.0018
Naphthalene	0.0148	0.0813	0.037	0.0697
Nitrobenzene	<0.0004	<0.0018	<0.0025	<0.0018
p-Dimethylaminoazobenzene	<0.0004	<0.0018	<0.0025	<0.0018
Pentachlorobenzene	<0.0004	<0.0018	<0.0025	<0.0018
Pentachloronitrobenzene	<0.0004	<0.0018	<0.0025	<0.0018
Pentachlorophenol	<0.0004	<0.0018	<0.0025	<0.0018
Phenacetin	<0.0004	<0.0018	<0.0025	<0.0018
Phenanthrene	0.0075	0.0182	0.026	0.0151 J
Phenol	0.0357	0.1227	0.148	0.1024
Pyrene	0.0041	0.003 J	0.0086 J	0.0049
Safrole	<0.0004	<0.0018	<0.0025	<0.0018
Total (excluding non-detects)	0.0883	0.3273	0.3491	0.3266

a - J = (PQL), Quantified outside of instrument calibration range

Table 3-5. Estimated emissions of semivolatile organics as analyzed by NYSDOH WCL&R, g/kg

Test No. Compound	1 Avid Recycler	2 Avid Recycler	4 Non- Recycler	5 Non- Recycler
1,2,4,5-Tetrachlorobenzene	0.000035 J ^a	0.000177 J	0.000064 J	<0.0026
1,2,4-Trichlorobenzene	<0.0008	0.000325 J	0.000042 J	<0.0019
1,2-Dichlorobenzene	0.000062 J	0.000483 J	0.000067 J	0.000159 J
1,3,5-Trinitrobenzene	<0.0022	<0.002	<0.0069	<0.0051
1,3-Dichlorobenzene	0.000019 J	0.000271 J	<0.0036	0.000058 J
1,3-Dinitrobenzene	<0.0025	<0.0022	<0.0077	<0.0057
1,4-Dichlorobenzene	0.000014 J	0.000154 J	<0.0039	0.000038 J
1,4-Naphthoquinone	<0.0039	<0.0035	<0.0122	<0.0089
1,4-Phenylenediamine	0 ^b	0	0	0
1-Naphthylamine	<0.0013	<0.0012	<0.004	<0.0029
2,2'-oxybis(1-Chloropropane)	<0.0025	<0.0023	<0.0079	<0.0058
2,3,4,6-Tetrachlorophenol	<0.0026	<0.0023	<0.0081	<0.0059
2,4,5-Trichlorophenol	<0.0029	<0.0026	<0.0091	<0.0066
2,4,6-Trichlorophenol	0.00028 J	0.00048 J	<0.0081	<0.0059
2,4-Dichlorophenol	<0.0027	0.000551 J	0.00041 J	<0.0061
2,4-Dimethylphenol	0.0039	0.0107	0.0506	0.0474
2,4-Dinitrophenol	<0.0025	<0.0022	<0.0078	<0.0057
2,4-Dinitrotoluene	<0.0024	<0.0022	<0.0077	<0.0056
2,6-Dichlorophenol	<0.0028	0.000177 J	<0.0087	<0.0063
2,6-Dinitrotoluene	<0.0026	<0.0023	<0.0081	<0.0059
2-Acetylaminofluorene	<0.0028	<0.0025	<0.0088	<0.0064
2-Chloronaphthalene	<0.0013	<0.0012	<0.0042	<0.0031
2-Chlorophenol	0.000472 J	0.001424 J	0.000826 J	0.0015 J
2-Methylnaphthalene	0.002	0.0164	0.0068	0.0062
2-Methylphenol	0.0049	0.0225	0.041	0.0419
2-Naphthylamine	<0.0013	<0.0011	<0.0039	<0.0029
2-Nitroaniline	<0.0026	<0.0023	<0.0081	<0.0059
2-Nitrophenol	<0.0026	<0.0024	<0.0083	<0.0061
2-Picoline	0	0	0	0
3,3'-Dichlorobenzidine	<0.0011	<0.001	<0.0036	<0.0026
3,3'-Dimethylbenzidine	0	0	0	0
3- or 4-Methylphenol	0.0095	0.0393	0.0661	0.0571
3-Methylcholanthrene	<0.0012	<0.0011	<0.0039	<0.0029
3-Nitroaniline	<0.0023	<0.0021	<0.0072	<0.0053
4,4'-DDD	<0.0021	<0.0019	<0.0067	<0.0049
4,4'-DDE	<0.0021	<0.0019	<0.0065	<0.0048
4,4'-DDT	<0.0021	<0.0019	<0.0066	<0.0048
4,6-Dinitro-2-methylphenol	<0.0025	<0.0023	<0.0079	<0.0058
4-Aminobiphenyl	<0.0012	<0.0011	<0.0037	<0.0027
4-Bromophenyl-phenylether	<0.0017	<0.0015	<0.0053	<0.0038
4-Chloro-3-methylphenol	<0.0028	<0.0025	<0.0088	<0.0064
4-Chloroaniline	<0.002	<0.0019	<0.0064	<0.0047

(continued)

Table 3-5 (continued). Estimated emissions of semivolatile organics as analyzed by NYSDOH WCL&R, g/kg

Test No.	1	2	4	5
Compound	Avid Recycler	Avid Recycler	Non- Recycler	Non- Recycler
4-Chlorophenyl-phenylether	<0.0014	<0.0013	<0.0046	<0.0033
4-Nitroaniline	<0.0024	<0.0021	<0.0075	<0.0054
4-Nitrophenol	<0.003	<0.0027	<0.0094	<0.0068
4-Nitroquinoline-1-oxide	<0.001	<0.0009	<0.0032	<0.0023
5-Nitro-o-toluidine	<0.0025	<0.0023	<0.0079	<0.0057
7,12-Dimethylbenz(a)anthracene	<0.0006	<0.0005	<0.0018	<0.0013
Acenaphthene	0.000251 J	0.000845 J	0.001334 J	0.000676 J
Acenaphthylene	0.0045	0.0123	0.0262	0.0112
Acetophenone	0.001418 J	0.0063	0.003949 J	0.006134 J
Aldrin	<0.0018	<0.0016	<0.0056	<0.0041
alpha-BHC	<0.0021	<0.0019	<0.0067	<0.0049
Aniline	<0.0026	<0.0023	<0.0081	<0.0059
Anthracene	0.000968 J	0.0019	0.003119 J	0.001343 J
Benzidine	0	0	0	0
Benzo(a)anthracene	0.001527 J	0.000266 J	0.002018 J	0.000663 J
Benzo(a)pyrene	0.000987 J	0.000149 J	0.001963 J	0.000601 J
Benzo(b)fluoranthene	0.000677 J	0.000188 J	0.001584 J	0.000665 J
Benzo(g,h,i)perylene	0.00081 J	0.00026 J	0.002061 J	0.000739 J
Benzo(k)fluoranthene	0.0007 J	0.000178 J	0.001347 J	0.000597 J
Benzyl alcohol	0.000723 J	0.002071 J	0.008419 J	0.0104
beta-BHC	<0.0023	<0.0021	<0.0073	<0.0053
bis(2-Chloroethoxy)methane	<0.0025	<0.0023	<0.008	<0.0059
bis(2-Chloroethyl)ether	<0.0029	<0.0026	<0.0092	<0.0067
bis(2-Ethylhexyl)phthalate	0.0134	0.0068	0.1394	0.0207
Butylbenzylphthalate	0.002224 J	0.001448 J	0.008533 J	0.004716 J
Chlorobenzilate	<0.0025	<0.0023	<0.008	<0.0059
Chrysene	0.003	0.00049 J	0.003358 J	0.001211 J
cis-Isosafrole	<0.0017	<0.0016	<0.0055	<0.004
Decane	0	0.000309 J	0.000033 J	0.000341 J
delta-BHC	<0.0021	<0.0019	<0.0067	<0.0049
Di-n-butyl phthalate	0.00096 J	0.001574 J	0.002566 J	0.0087
Di-n-octyl phthalate	0.0028	0.0046	0.0277	0.0658
Diallate-A	<0.0018	<0.0016	<0.0056	<0.0041
Diallate-B	<0.0018	<0.0017	<0.0058	<0.0043
Dibenzo(a,h)anthracene	0.000065 J	0.000032 J	0.00031 J	0.000074 J
Dibenzofuran	0.001298 J	0.0039	0.0066	0.002746 J
Dieldrin	<0.0021	<0.0019	<0.0066	<0.0048
Diethyl phthalate	<0.0027	0.000343 J	0.00362 J	0.001432 J
Dimethoate	<0.0034	<0.0031	<0.0108	<0.0079
Dimethylphenethylamine	<0.0003	<0.0003	<0.001	<0.0008
Dimethyl phthalate	<0.0026	<0.0023	<0.0081	<0.0059
Dinoseb	<0.0022	<0.002	<0.007	<0.0051

(continued)

Table 3-5 (continued). Estimated emissions of semivolatile organics as analyzed by NYSDOH WCL&R, g/kg

Test No.	1	2	4	5
Compound	Avid Recycler	Avid Recycler	Non- Recycler	Non- Recycler
Diphenylamine	<0.0023	<0.0021	<0.0072	<0.0053
Disulfoton	<0.0014	<0.0013	<0.0044	<0.0032
Dodecane	0.0001	0.000283 J	0 J	0.000537 J
Dotriacontane	0.0025	0.000838 J	0.001721 J	0.000312 J
Eicosane	0.0005	0.000386 J	0.000645 J	0 J
Endosulfan I	<0.0023	<0.0021	<0.0072	<0.0052
Endosulfan II	<0.0022	<0.002	<0.007	<0.0051
Endosulfan sulfate	<0.0025	<0.0023	<0.008	<0.0059
Endrin	<0.0026	<0.0024	<0.0083	<0.0061
Endrin aldehyde	0	0	0	0
Endrin ketone	<0.0023	<0.0021	<0.0072	<0.0052
Ethyl methanesulfonate	<0.0026	<0.0023	<0.0081	<0.0059
Famphur	<0.011	<0.01	<0.0348	<0.0254
Fluoranthene	0.0026	0.0019	0.0065	0.002572 J
Fluorene	0.001183 J	0.0044	0.0072	0.003109 J
gamma-BHC	<0.0022	<0.002	<0.0069	<0.0051
Heptachlor	<0.0019	<0.0018	<0.0061	<0.0045
Heptachlor epoxide	<0.0019	<0.0017	<0.0058	<0.0043
Hexachlorobenzene	0.000041 J	<0.0016	<0.0056	<0.0041
Hexachlorobutadiene	<0.0006	<0.0006	<0.002	<0.0015
Hexachlorocyclopentadiene	<0.0009	<0.0008	<0.0028	<0.002
Hexachloroethane	<0.0009	<0.0008	<0.0028	<0.002
Hexachloropropene	<0.0006	<0.0005	<0.0018	<0.0013
Hexadecane	0.0002	0.000313 J	0.000574 J	0.000841 J
Hexatriacontane	0	0 J	0 J	0 J
Indeno(1,2,3-cd)pyrene	0.000501 J	0.000161 J	0.001108 J	0.000407 J
Isodrin	<0.0017	<0.0016	<0.0055	<0.004
Isophorone	<0.0026	<0.0023	<0.0081	<0.0059
Kepone	<0.0043	<0.0039	<0.0136	<0.0099
Methapyrilene	<0.0006	<0.0005	<0.0018	<0.0013
Methoxychlor	<0.0022	<0.002	<0.0069	<0.005
Methyl methanesulfonate	<0.0026	<0.0024	<0.0082	<0.006
Methyl parathion	<0.0026	<0.0023	<0.0081	<0.0059
Methyl yellow	<0.0023	<0.002	<0.0071	<0.0052
Mirex	<0.002	<0.0018	<0.0063	<0.0046
N-Nitroso-di-n-butylamine	<0.0025	<0.0023	<0.0078	<0.0057
N-Nitrosodi-n-propylamine	<0.0031	<0.0028	<0.0097	<0.0071
N-Nitrosodiethylamine	<0.0028	<0.0026	<0.009	<0.0066
N-Nitrosodimethylamine	<0.0028	<0.0025	<0.0088	<0.0065
N-Nitrosodiphenylamine	<0.0023	<0.0021	<0.0072	<0.0053
N-Nitrosomethylethylamine	<0.0028	<0.0026	<0.0089	<0.0065
N-Nitrosomorpholine	<0.0029	<0.0027	<0.0092	<0.0068

(continued)

Table 3-5 (continued). Estimated emissions of semivolatile organics as analyzed by NYSDOH WCL&R, g/kg

Test No.	1	2	4	5
Compound	Avid Recycler	Avid Recycler	Non- Recycler	Non- Recycler
N-Nitrosopiperidine	<0.0025	<0.0023	<0.008	<0.0059
N-Nitrosopyrrolidine	<0.0031	<0.0029	<0.0099	<0.0072
Naphthalene	0.0128	0.0538	0.0367	0.0469
Nitrobenzene	<0.0026	<0.0024	<0.0083	<0.0061
Nonane	0	0.000265 J	0 J	0.000157 J
o,o,o-Triethylphosphorothioate	<0.0021	<0.0019	<0.0065	<0.0047
o-Toluidine	<0.002	<0.0018	<0.0063	<0.0046
Octacosane	0.0043	0 J	0 J	0.017963 J
Octadecane	0.0001	0.000216 J	0.000357 J	0.000356 J
Octane	0	0.000158 J	0 J	0.000494 J
Parathion	<0.0022	<0.002	<0.0068	<0.005
Pentachlorobenzene	0.000064 J	0.000295 J	0.000127 J	<0.0031
Pentachloronitrobenzene	<0.0019	0.000042 J	<0.0059	<0.0043
Pentachlorophenol	<0.0022	<0.002	<0.0068	<0.005
Phenacetin	<0.0026	<0.0024	<0.0083	<0.0061
Phenanthrene	0.0065	0.0135	0.027	0.0106
Phenol	0.046	0.1372	0.204	0.1053
Phorate	<0.002	<0.0018	<0.0062	<0.0046
Pronamide	<0.0021	<0.0019	<0.0066	<0.0048
Pyrene	0.0039	0.0026	0.0106	0.003949 J
Pyridine	0	0	0	0
Safrole	<0.0014	<0.0013	<0.0045	<0.0033
Sulfotep	<0.0021	<0.0019	<0.0066	<0.0048
Tetracontane	0	0 J	0 J	0 J
Tetracosane	0.0012	0.004269 J	0 J	0.002523 J
Tetradecane	0.0001	0.000363 J	0.000359 J	0.000579 J
Thionazin	<0.0024	<0.0021	<0.0075	<0.0055
trans-Isosafrole	<0.0015	<0.0014	<0.0048	<0.0035
Undecane	0	0.000327 J	0 J	0.000357 J
Total (excluding non-detects)	0.1401	0.3582	0.7069	0.4900

a - J = (PQL), Quantified outside of instrument calibration range

b - 0 = no recovery of this compound under conditions of extraction

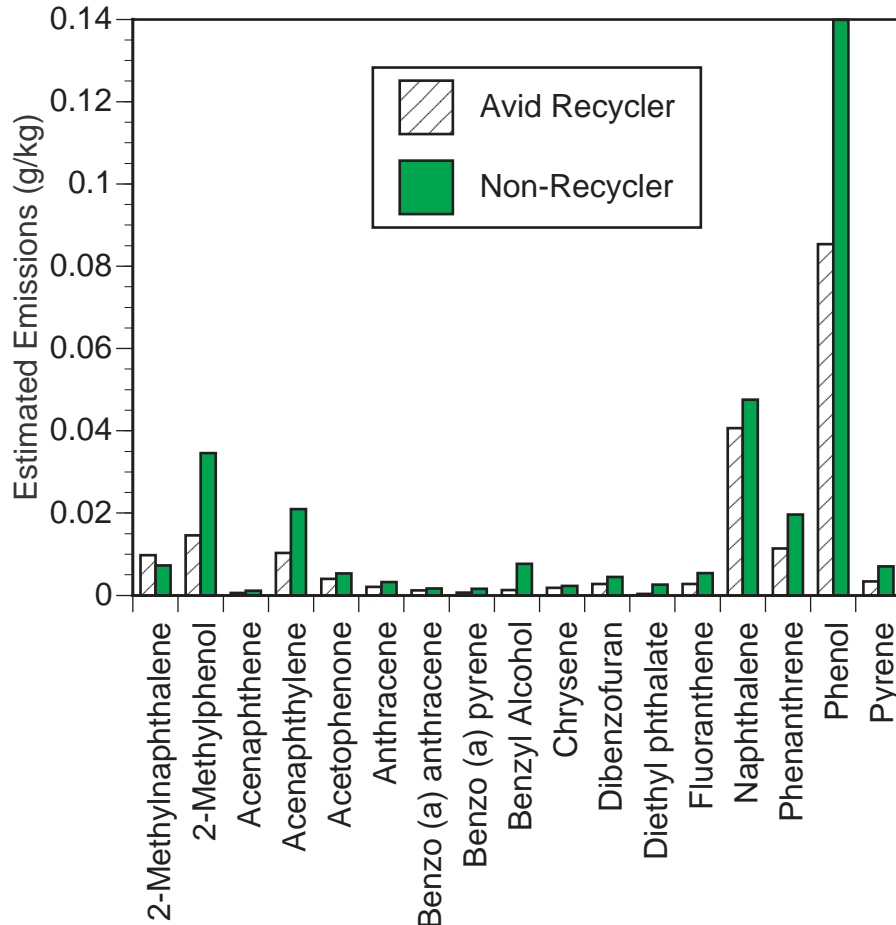

Figure 3-31. Average emissions of selected target SVOCs.

3.4 Chlorobenzene Analytical Results

Chlorobenzenes are of concern both for their toxicological properties and as potential precursors to the formation of PCDDs/PCDFs. Table 3-6 shows the estimated emissions per unit mass burned of all of the chlorobenzene isomers as well as the total of each isomer group. Figure 3-28 was derived by averaging the results from the two cases for each material. Interestingly enough, unlike the general VOC and SVOC data, the chlorobenzene emissions for the avid recycler are higher than for the non-recycler, by roughly a factor of 2. This is likely due to the fact that the composition of the household waste for the avid recycler contains a much higher proportion of PVC plastic, which is highly chlorinated. However, when emissions of chlorobenzenes are calculated based on a per person or per day basis, the emissions from the non-recycler are approximately 40% higher.

Table 3-6. Estimated emissions of chlorobenzenes, mg/kg

Test No.		1	2	4	5
Isomer		Avid Recycler	Avid Recycler	Non- Recycler	Non- Recycler
13	Dichlorobenzene	0.016	0.2448	0.0076	0.0596
14	Dichlorobenzene	0.0067	0.0919	0.0032	0.0313
12	Dichlorobenzene	0.051	0.3365	0.1074	0.1616
135	Trichlorobenzene	0.002	0.0298	<0.0077	0.0042
124	Trichlorobenzene	0.0339	0.2575	0.0468	0.0519
123	Trichlorobenzene	0.0477	0.3057	0.0457	0.0452
1235	Tetrachlorobenzene	0.0107	0.0788	0.0197	0.0117
1245	Tetrachlorobenzene	0.0109	0.0411	0.0277	0.0121
1234	Tetrachlorobenzene	0.0393	0.163	0.0686	0.0342
12345	Pentachlorobenzene	0.0371	0.1622	0.0727	0.0331
123456	Hexachlorobenzene	0.0345	0.0625	0.0309	0.0131
TOT	Dichlorobenzene	0.0643	0.5666	0.1065	0.2196
TOT	Trichlorobenzene	0.1001	0.7048	0.1074	0.1178
TOT	Tetrachlorobenzene	0.051	0.2318	0.0985	0.0487
TOT	Pentachlorobenzene	0.0371	0.1622	0.0727	0.0331
TOT	Hexachlorobenzene	0.0345	0.0625	0.0309	0.0131

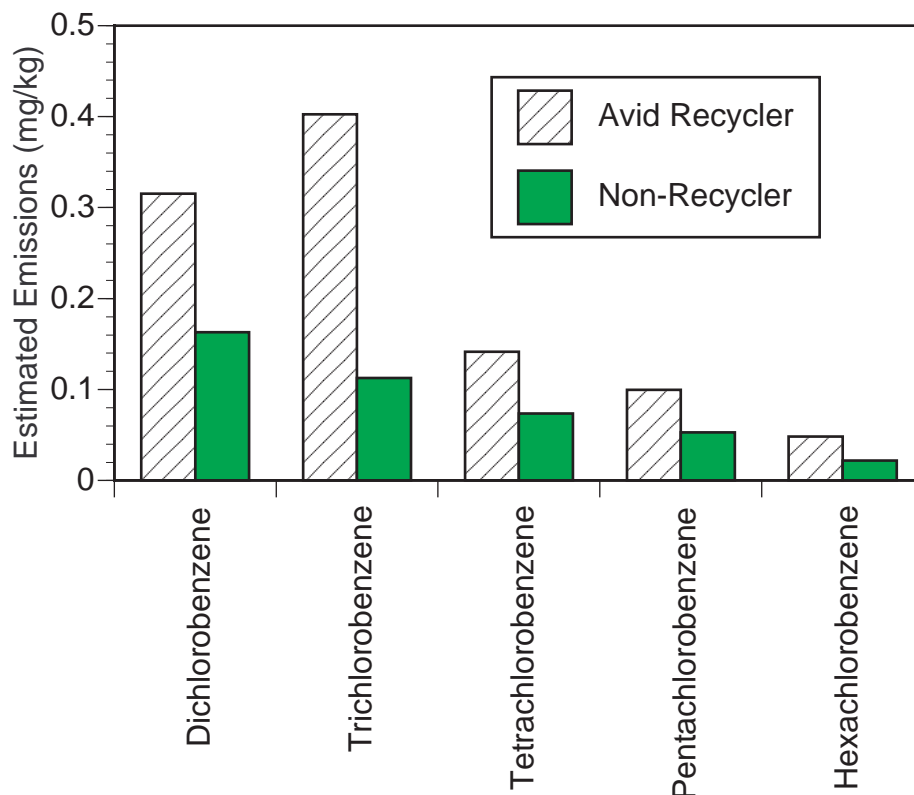

Figure 3-32. Chlorobenzene summary

3.5 Polycyclic Aromatic Hydrocarbon Analytical Results

Table 3-7 shows the estimated emissions per unit mass burned from the PAH analysis, in units of mg/kg. As was found in the VOC and SVOC data, the emissions of PAH from the non-recycler are higher than from the avid recycler. Figure 3-29 also illustrates this observation. Figure 3-33 was created based on data averaged between the two tests at each fuel condition. Emissions from the non-recycler are on the order of twice the level of the emissions from the average recycler per kg of material burned. Thus on a per household basis, PAH emissions for the non-recycler would be dramatically higher than for the avid recycler. Note that in many cases, the greater sensitivity of SIM analytical methods makes this data set more useful than the quantitation of these compounds in the general SVOC dataset.

Table 3-7. Estimated emissions of PAHs, mg/kg

Test No.	1 Avid Recycler	2 Avid Recycler	4 Non- Recycler	5 Non- Recycler
Acenaphthene	0.2394	0.7793	0.9578	0.578
Acenaphthylene	2.7065	4.044	13.6424	8.9577
Anthracene	0.6066	0.9337	2.3724	1.291
Benzo(a)anthracene	1.1356	0.4294	3.1364	1.3425
Benzo(a)pyrene	1.1234	0.2385	3.1275	1.1167
Benzo(b)fluoranthene	1.62	0.5407	3.7585	1.5016
Benzo(ghi)perylene	0.9877	0.2811	2.8148	1.134
Benzo(k)fluoranthene	0.5209	0.1238	1.6424	0.4085
Chrysene	1.6461	0.4644	3.5588	1.5136
Dibenzo(ah)anthracene	0.3795	0.0675	0.4861	0.1595
Fluoranthene	1.4921	1.4626	5.1917	2.9436
Fluorene	1.4757	3.1838	4.7756	2.536
Indeno(123cd)pyrene	1.0391	0.2981	2.7997	0.9547
Naphthalene	4.0279	6.3651	18.9598	16.1032
Phenanthrene	2.8379	3.8527	8.9946	5.6546
Pyrene	1.6695	1.3768	6.1419	3.5157
Total	23.51	24.44	82.36	49.71

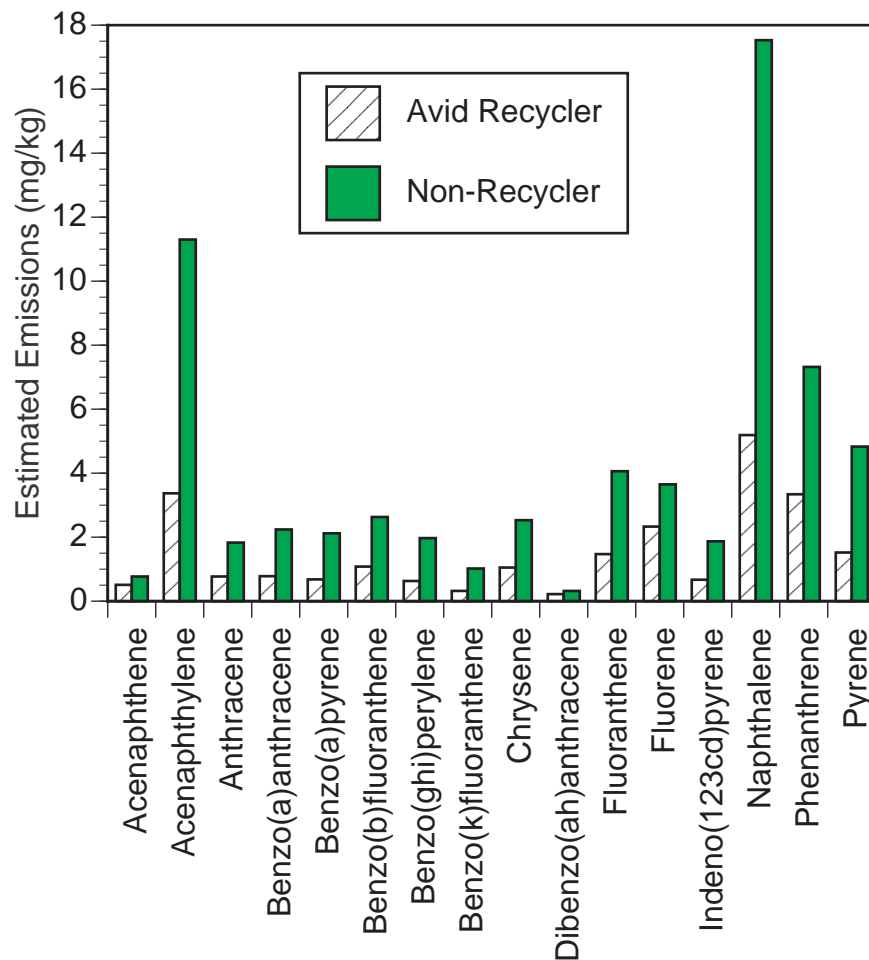

Figure 3-33. PAH Summary.

3.6 Aldehyde and Ketone Analytical Results

Table 3-8 lists the data from the aldehyde and ketone analytical samples. Again, as was the case with the VOCs and SVOCs, emissions from the non-recycler are higher than for the avid recycler. In the case of the aldehydes and ketones, this effect is even more pronounced, with the emissions from the non-recycler being an order of magnitude higher than from the avid recycler. Figure 3-30 illustrates this observation. The data in Figure 3-30 were calculated by averaging the results from the the two similar experiments. Only those compounds that were present above the detection limit in all samples are shown in Figure 3-30.

Table 3-8. Estimated emissions of aldehydes and ketones, g/kg

Test No.	1 Avid Recycler	2 Avid Recycle	4 Non- Recycler	5 Non- Recycler
2,4-Dimethylbenzaldehyde	<0.0042	<0.0037	<0.0104	<0.0093
Acetaldehyde	0.0305	0.0079	1.1581	0.5171
Acetone	0.0686	0.0441	0.6207	0.2816
Acrolein	<0.0042	<0.0037	0.1066	<0.0093
Benzaldehyde	0.0344	0.0057	0.3504	0.2176
Butyraldehyde	0.0072	<0.0037	<0.0104	<0.0093
Crotonaldehyde	<0.0042	<0.0037	0.1341	<0.0093
Formaldehyde	0.0434	0.0112	1.229	0.491
Hexaldehyde	<0.0042	<0.0037	<0.0104	<0.0093
Isovaleraldehyde	<0.0042	<0.0037	0.0408	<0.0093
m-Tolualdehyde	<0.0042	<0.0037	<0.0104	<0.0093
o-Tolualdehyde	<0.0042	<0.0037	<0.0104	<0.0093
p-Tolualdehyde	0.0234	<0.0037	<0.0104	<0.0093
Propionaldehyde	0.0105	<0.0037	0.3179	0.122
Valeraldehyde	<0.0042	<0.0037	<0.0104	<0.0093
Total (Excluding non-det)	0.218	0.0689	3.958	1.629

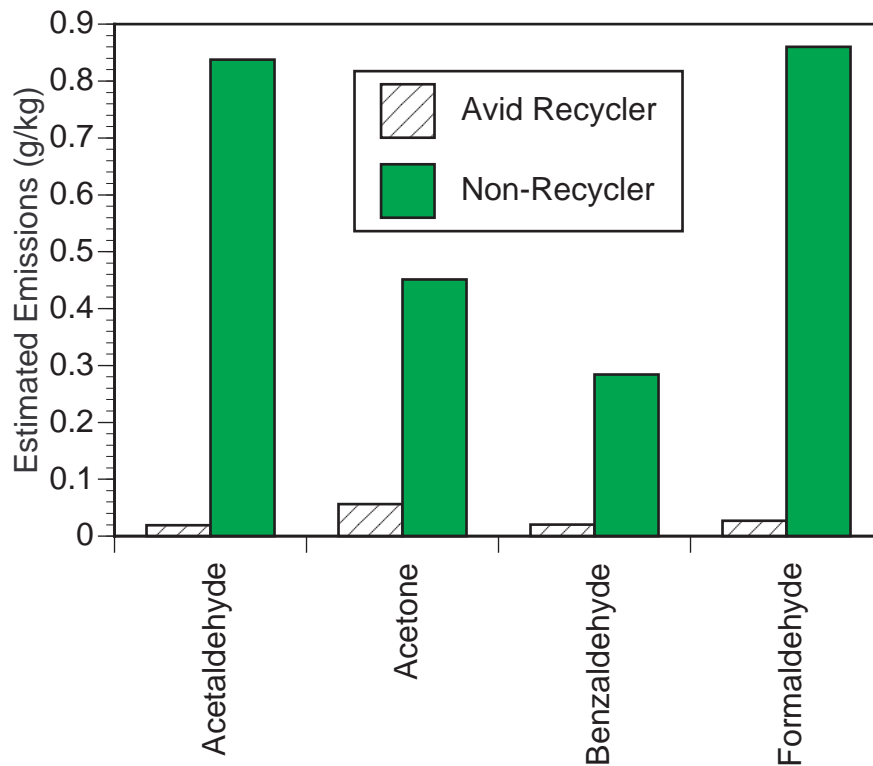

Figure 3-34. Aldehyde and ketone summary

3.7 Particulate- and Vapor-Phase PCDDs/PCDFs Analytical Results

Table 3-9 lists the results from the analysis for PCDDs/PCDFs for the avid recycler and the non-recycler. For the most part, emissions of PCDDs were non-existent for the non-recycler, except for OCDD, which was higher than that of the avid recycler. The blank sample showed high levels of OCDD, and the non-recycler runs also exhibited high levels of OCDD while other PCDDs/PCDFs were low. For this reason, OCDD data should be treated as suspect. Figure 3-35 illustrates this observation. PCDFs were higher than PCDDs, which is consistent with results seen from municipal waste combustors, hazardous waste incinerators, and other combustion devices²¹. It must be noted that some internal standard recoveries were not good, with some being as low as 10 %, particularly on the avid recycler data, so quantitation for some congeners may be questionable, although qualitatively, the data are sound. PCDDs/PCDFs generally exhibited the same trend that was seen in the chlorobenzenes (Figure 3-32), where emissions from the avid recycler were higher than emissions from the non-recycler. One would expect this to happen, since chlorobenzenes are believed to be the primary organic precursors leading to formation of PCDDs/PCDFs.

Table 3-9. Estimated emissions of PCDDs and PCDFs, mg/kg

Test No. Isomer	Compound	1 Avid Recycler	2 Avid Recycler	4 Non-Recycler	5 Non-Recycler
2378	TCDD	<0.0009	<0.0005	<0.0003	<0.0003
12378	PECDD	0.0013	<0.0005	<0.0003	<0.0003
123478	HXCDD	0.0002	<0.0001	<0.0004	<0.0003
123678	HXCDD	0.0014	<0.0006	<0.0006	<0.0005
123789	HXCDD	0.0008	<0.0006	<0.0005	<0.0004
1234678	HPCDD	0.0153	0.0008	<0.0006	<0.0005
12346789	OCDD	0.0115	0.0005	0.0448	0.0317
2378	TCDF	0.0022	0.0002	0.0001	<0.0003
12378	PECDF	0.0035	<0.0004	0.0001	<0.0002
23478	PECDF	0.0013	0.0002	0.0002	<0.0003
123478	HXCDF	0.0012	0.0001	0.0001	0.0001
123678	HXCDF	0.0067	0.0006	0.0002	<0.0003
234678	HXCDF	0.0094	0.0009	0.0001	<0.0003
123789	HXCDF	0.0024	0.0003	<0.0004	<0.0003
1234678	HPCDF	0.0439	0.0015	0.0002	0.0034
1234789	HPCDF	0.0004	0	<0.0005	<0.0003
12346789	OCDF	0.0114	0.0005	<0.0007	<0.0006
Total	TCDD	0.0141	0.0018	<0.0003	<0.0003
Total	PECDD	0.0191	0.0008	<0.0003	<0.0003
Total	HXCDD	0.0099	0.0004	<0.0006	<0.0005
Total	HPCDD	0.0338	0.0015	<0.0006	<0.0005
Total	OCDD	0.0115	0.0005	0.0448	0.0317
Total	TCDF	0.158	0.0224	0.0038	0.0007
Total	PECDF	0.0995	0.0106	0.0024	<0.0002
Total	HXCDF	0.0781	0.0056	0.0011	0.0005
Total	HPCDF	0.0576	0.0021	0.0002	0.0034
Total	OCDF	0.0114	0.0005	<0.0007	<0.0006
Total	PCDD	0.0884	0.005	0.0448	0.0317
Total	PCDF	0.4046	0.0412	0.0075	0.0046
Total	PCDD/PCDF	0.493	0.0462	0.0523	0.0363

There are several possible explanations for this phenomenon. Much of the difference between the two test conditions is highly influenced by Run 1. If Run 1 were excluded, then there would not be a significant difference between Runs 2, 4, and 5. This indicates that Run 1 behaved differently than the other runs. This will be discussed in greater detail later. The higher proportion of PVC plastic found in the waste stream of the avid recycler could potentially increase formation of chlorinated organic compounds. Combustion conditions such as temperature profiles and oxygen availability, as well as the particular mixture of carbon molecules and chlorine in the presence of a metal catalyst, are all likely to be important factors in the formation of PCDDs/PCDFs. All of these variables changed between the avid recycler and the non-recycler test cases. However, there is not sufficient information to build a strong argument explaining why the emissions from the avid recycler were so much higher than from the non-recycler. The emissions on a mass basis from the avid recycler are so much higher than those of the non-recycler, that PCDDs/PCDFs from avid recyclers are higher on a per person basis as well.

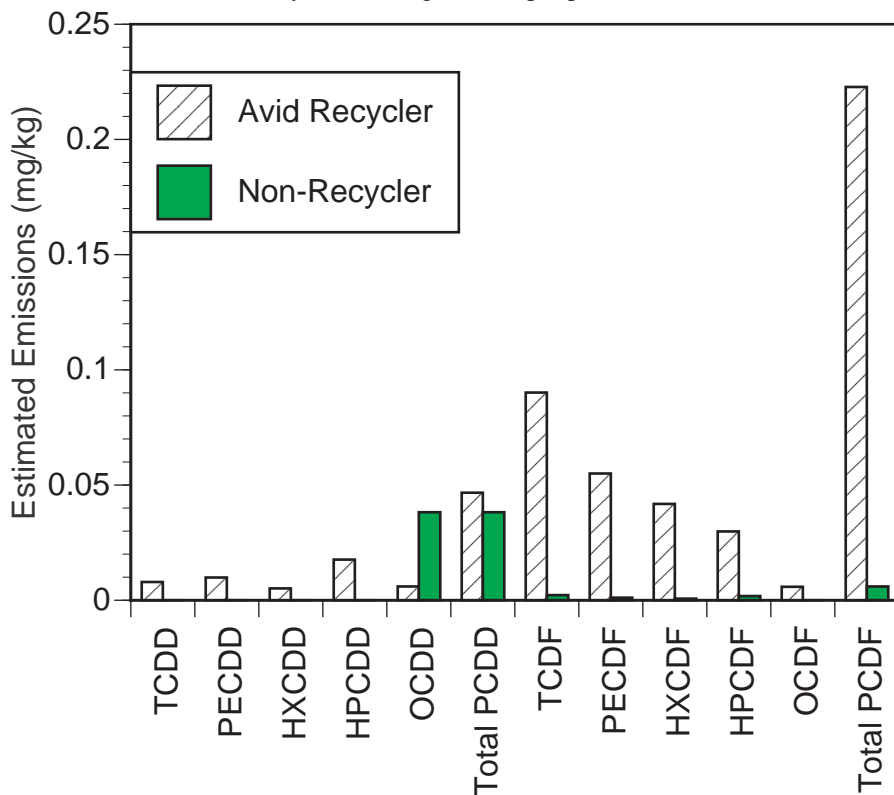

Figure 3-35. PCDDs/PCDFs data summary.

3.8 Polychlorinated Biphenyl Analytical Results

Table 3-10 lists the polychlorinated biphenyl results. Only those compounds that were quantified in both of the duplicate samples from both of the test conditions are listed below. The complete PCB data set can be found in the appendix. Interestingly, the total identified PCB emissions from the non-recycler are approximately 3 times those of the avid recycler. It is unknown why this phenomenon may occur. Examining estimated emissions per unit mass burned of individual compounds shows the same trend. Published PCB emissions data from combustion sources is very sparse. This observation is especially interesting in light of the fact that emissions of other chlorinated organics are higher for the avid recycler.

Table 3-10. Estimated emissions of PCBs, mg/kg

Test No.	1 Avid Recycler	2 Avid Recycler	4 Non- Recycler	5 Non- Recycler
BZ-1 (2-Chlorobiphenyl)	0.0185	0.0077	0.0408	0.1344
BZ-7, BZ-9	0.0122	0.0121	0.0643	0.0986
BZ-15, BZ-17	0.0071	0.0096	0.0396	0.0385
BZ-16, BZ-32	0.0043	0.0096	0.0346	0.0448
BZ-26 (2,3',5'-Trichlorobiphenyl)	0.0067	0.0044	0.0186	0.0323
BZ-31 (2,4',5'-Trichlorobiphenyl)	0.013	0.0152	0.0767	0.0645
BZ-20, BZ-33, BZ-53	0.0138	0.0121	0.0371	0.0592
BZ-22 (2,3,4'-Trichlorobiphenyl)	0.0075	0.0055	0.0297	0.0538
BZ-52 (2,2',5,5'-Tetrachlorobiphenyl)	0.0197	0.0114	0.0346	0.078
BZ-44 (2,2',3,5'-Tetrachlorobiphenyl)	0.0063	0.0052	0.0111	0.0206
BZ-40 (2,2',3,3'Tetrachlorobiphenyl)	0.0009	0.0005	0.003	0.0035
BZ-74 (2,4,4',5'-Tetrachlorobiphenyl)	0.0037	0.0018	0.0031	0.0088
BZ-70 (2,3',4',5'-Tetrachlorobiphenyl)	0.0039	0.0034	0.0067	0.0099
BZ-66, BZ-95	0.0047	0.0037	0.0136	0.0206
BZ-91 (2,2',3,4',6-Pentachlorobiphenyl)	0.0032	0.0015	0.0106	0.0041
BZ-56, BZ-60	0.0043	0.0027	0.0063	0.0073
BZ-92 (2,2',3,5,5'-Pentachlorobiphenyl)	0.0016	0.0009	0.0021	0.0031
BZ-84 (2,2',3,3',6-Pentachlorobiphenyl)	0.0013	0.0009	0.0048	0.0083
BZ-90, BZ-101	0.0024	0.0018	0.0052	0.0108
BZ-99 (2,2',4,4',5-Pentachlorobiphenyl)	0.0083	0.0063	0.0198	0.0188
BZ-83 (2,2',3,3',5-Pentachlorobiphenyl)	0.0039	0.0029	0.0054	0.0019
BZ-97 (2,2',3',4,5-Pentachlorobiphenyl)	0.0028	0.0013	0.0026	0.0056
BZ-85, 4,4'-DDE	0.0043	0.0018	0.0067	0.0099
BZ-77, BZ-110	0.0055	0.0037	0.0093	0.0152
BZ-151 (2,2',3,5,5',6-Hexachlorobiphenyl)	0.0063	0.0044	0.0101	0.0179
BZ-135	0.0071	0.0008	0.0049	0.0045
BZ-123, BZ-149	0.0154	0.0081	0.0186	0.0287
BZ-118	0.0083	0.004	0.0083	0.0143
BZ-146	0.0025	0.0013	0.003	0.0036
BZ-132, BZ-105	0.006	0.0013	0.0059	0.0049
BZ-141 (2,2',3,4,5,5'-Hexachlorobiphenyl)	0.0029	0.0015	0.0032	0.0039
BZ-138	0.0047	0.0021	0.0074	0.008
BZ-183	0.0002	0.0036	0.0089	0.0059
BZ-174	0.0026	0.0017	0.0026	0.007
BZ-177	0.0023	0.0007	0.0015	0.0069
IUPAC-199	0.0023	0.0007	0.0009	0.0013
BZ-65 (2,3,5,6-Tetrachlorobiphenyl)	0.3571	0.3495	1.2367	0.7439
BZ-166, BZ-175	0.4301	0.4231	1.2862	1.0217
Total PCBs	1.0077	0.9287	3.0845	2.625

3.9 PM₁₀ and PM_{2.5} Particulate Results

Table 3-11 lists the results from the particulate matter sampling, in terms of PM₁₀ and PM_{2.5} for all tests. Note that the PM₁₀ data include the contribution from PM_{2.5}. PM emissions for the non-recycler are significantly higher than those of the avid recycler. In addition, as Figure 3-36 illustrates, almost all of the measured PM is < 2.5 μm, which is of concern from a respirability standpoint. Note that total particulate was not measured, so it is possible that PM > 10 μm was emitted as well.

Table 3-11. Estimated emissions of particulate matter, g/kg; numbers in parentheses indicate the percentage of PM₁₀ that was less than 2.5 μm in diameter.

Test No.	1 Avid Recycler	2 Avid Recycler	4 Non- Recycler	5 Non- Recycler
PM _{2.5}	6.93	3.58	20.07	14.8
PM ₁₀	7.46 (93%)	4.18 (86%)	21.28 (94%)	16.23 (92%)

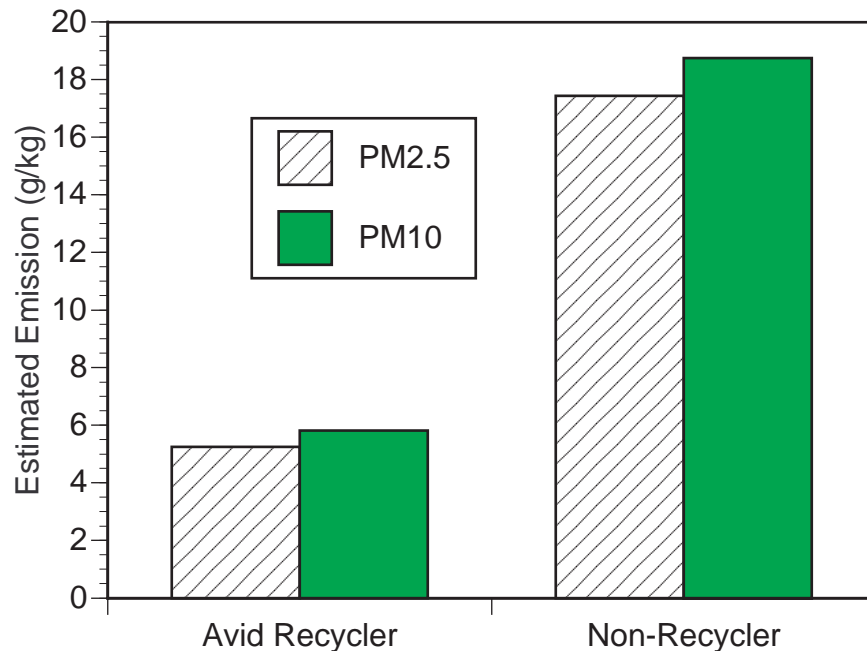

Figure 3-36. Particulate matter data.

3.10 Particulate- and Vapor-Phase Metals Analytical Results

Table 3-12 shows the estimated emissions per unit mass burned of gaseous mercury for the tests. These values were all less than the detection limit.

Table 3-13 shows the data for the other particulate-phase metals. There don't appear to be any obvious conclusions to draw from these data. Some metal emissions are higher for the avid recycler, and some are higher for the non-recycler. The very high Al data in Test 1 for the avid recycler appear to be some sort of anomaly, possibly due to suspended material in the sample. Metal emissions are largely caused by combustion of waste components which contain metal-containing additives. It is unknown what caused that high value for aluminum on that test. Note also that Run 1 exhibited higher Cu emissions than the other runs. This may be a possible explanation as to why the PCDD/PCDF data from Run 1 were so much higher.

Table 3-12. Estimated emissions of gaseous mercury, g/kg

Test No.	1 Avid Recycler	2 Avid Recycler	4 Non-Recycler	5 Non-Recycler
	<0.001467	<0.001365	<0.004504	<0.002905

Table 3-13. Estimated emissions of particulate-phase metals, g/kg

Test No.	1 Avid Recycler	2 Avid Recycler	4 Non-Recycler	5 Non-Recycler
Ag	0.000029	<0.000017	0.000068	<0.000037
Al	0.215	0.002491	0.002506	0.004776
As	0.000745	0.001993	0.004329	0.000154
Ba	0.000102	0.000082	0.001242	0.00058
Be	<0.000018	<0.000017	<0.000057	<0.000037
Cd	0.000135	0.000075	0.000239	0.000037
Cr	0.000237	0.000208	<0.000228	0.000176
Cu	0.015015	0.006176	0.002164	0.000573
Hg	<0.000015	<0.000014	<0.000046	0.000081
Mg	0.00327	<0.000853	0.003189	<0.001837
Ni	0.000804	0.000188	<0.000228	0.00025
Pb	0.000409	0.002566	0.000752	0.00022
Se	<0.000457	<0.000426	<0.001424	<0.000918
Zn	0.018888	0.003071	<0.000911	0.000073

3.11 Acid Gas Analytical Results

Table 3-14 shows the results from the HCl and HCN samples. Emissions of HCl are much higher from the avid recycler. This observation partially supports the hypothesis that the higher mass fraction of PVC present in the avid recycler's waste stream contributes to HCl and chlorinated organic emissions in excess of that of the non-recycler. However, Run 1's HCl was only a factor of two higher than Run 2, yet the PCDDs/PCDFs were an order of magnitude higher, so obviously chlorine is not the primary variable affecting emissions of PCDDs/PCDFs. HCN emissions are marginally higher for the non-recycler. It may be that some of the plastics that are present in the non-recycler's waste stream decompose to produce HCN gas. The plastics that the avid recycler removes from the waste stream do not obviously contribute to production of HCN gas, such as might be expected from combustion of plastics such as nylon; however, it may be that nitrogen from some other source in the waste stream, coupled with the highly localized regions of fuel-richness associated with combustion of polyethylene and polypropylene, leads to production of HCN gas.

Table 3-14. Estimated emissions of acid gases, g/kg

Test No.	1 Avid Recycler	2 Avid Recycler	4 Non- Recycler	5 Non- Recycler
HCl	3.281	1.508	0.4814	0.08636
HCN	0.2382	0.1615	0.7277	0.2083

3.12 Ash Residue Analytical Results

For the purposes of analysis of the ash residue, ash samples from the duplicate experimental conditions were combined resulting in two composite samples, one for the avid recycler and one for the non-recycler. The composite ash samples were analyzed for SVOCs, PCDDs/PCDFs, PCBs, and metals. Table 3-15 lists the SVOC concentrations for those compounds that were present at above the detection levels in at least one of the two waste streams. As was the case for the gas phase compounds, SVOCs in the ash residue are higher for the non-recycler. Table 3-16 lists the PCDDs/PCDFs for the two composite ash samples. PCDDs/PCDFs in the avid recycler's residue were much higher than the non-recycler's. This observation is consistent with what was seen in the gas-phase samples. Table 3-16 shows the PCB results from the composited ash samples. Unlike what was seen in the gas-phase samples, PCBs were higher for the avid recycler. Examining the traces for the temperature at the base of the burn barrel (Figures 3-8, 3-15, 3-22, and 3-29), it is apparent that the temperature of the bed of burning material in the barrel is much higher in the case of the non-recycler; probably due to the higher mass fraction of high Btu content plastic present in the non-recycler's waste stream. This lower bed burning temperature may help explain the higher PCBs found in the avid recycler's residue. PCBs are a very non-volatile group of compounds, and lower temperatures would result in more PCBs in the solid residues than in the gas phase. Table 3-17 shows the metals in the residue for the composited ash sample. Of particular note is the high copper concentration in the residue of the avid recycler. Copper has been implicated as a catalyst in the mechanism of PCDD/PCDF formation. The higher copper concentration could promote formation of PCDDs/PCDFs in the avid recycler tests.

3.13. Uncertainties and Limitations

It must be stressed that these tests were performed on a simulated waste stream, and only two repeats of each test condition were performed. This limits the statistical validity of treating the estimated emissions per unit mass burned from these tests as actual emission factors. There are several potential variations between these tests and what is performed in reality that may contribute to differences between the data presented and real-life emissions from burn barrels. Some of these differences include:

- Ignition method: A propane torch was used for these tests. Actual practices will vary, but variations in ignition method could potentially alter the emissions, perhaps significantly.
- Waste composition: These tests used a simulated waste, based on surveys of households in New York State. From the observed variations in the emissions of the avid recyclers and the non-recyclers, there may be wide and unpredictable variations in the emissions for many different combinations of waste burned in backyard burn barrels. In addition, household hazardous waste was not included in these tests, which could significantly affect emissions.
- Procedural limitations: We collected samples during the active portion of the burn (i.e., until the weight on the platform scale was stable). The burn continued to smolder beyond this point (as shown by Figures 3-4, 3-8, 3-11, 3-15, 3-18, 3-22, 3-25, and 3-29) and further emission sampling was not performed.
- Data limitations: Some of the analytes that were observed were present at concentrations below the lowest calibration point for the analytical methods. These analytes were flagged with a “J” in the data tables. The quantitation of data flagged with a “J” should be treated as questionable. However, it must be stressed that data flagged with a “J” are completely different from non-detects. These compounds were definitely detected by the analytical methods; however, their concentrations were below the range where there is good confidence in their quantitation.
- Analytical anomalies: For most of the tests, the various blanks came out clean. However, the PCDD/PCDF blank sample showed high levels of OCDD present. The non-recycler runs also exhibited high levels of OCDD while other PCDDs/PCDFs were low. For this reason, OCDD data should be treated as suspect. In addition, recoveries for many of the PCDD/PCDF internal standards were not very good. For confidence in the quantitation of PCDD/PCDF data, recoveries must be within a certain range. Since some of the recoveries were outside of this range, the PCDD/PCDF data cannot be assumed to be within the ± 30 percent that is generally accepted from Method 23.

Table 3-15. SVOC concentration in composite ash sample, µg/kg ash

Compound	Avid Recycler	Non-Recycler
1,2,4,5-Tetrachlorobenzene	140 J ^a	<5000
1,2,4-Trichlorobenzene	120 J	<5000
1,2-Dichlorobenzene	190 J	<5000
1,3-Dichlorobenzene	88 J	<5000
1,4-Dichlorobenzene	54 J	<5000
2,4,5-Trichlorophenol	54 J	38 J
2,4,6-Trichlorophenol	170 J	<5000
2,4-Dichlorophenol	92 J	<5000
2,6-Dinitrotoluene	<5000	1100 J
2-Methyl phenol	120 J	670 J
2-Methylnaphthalene	160 J	400 J
Acenaphthylene	<5000	61 J
Acetophenone	480 J	1400 J
Alpha-picoline	190 J	160 J
Anthracene	<5000	80 J
Benzo(a)anthracene	62 J	94 J
Benzo(a)pyrene	78 J	<5000
Benzo(b)fluoranthene	78 J	<5000
Benzo(k)fluoranthene	110 J	<5000
Butyl benzyl phthalate	110 J	<5000
Chrysene	76 J	220 J
Di-n-octyl phthalate	55 J	<5000
Dibenzofuran	170 J	350 J
Diethyl phthalate	110 J	<5000
Fluoranthene	68 J	170 J
Fluorene	78 J	120 J
Hexachlorobenzene	170 J	<5000
Naphthalene	650 J	2400 J
Pentachlorobenzene	290 J	<5000
Phenanthrene	290 J	810 J
Pyrene	76 J	180 J
Pyridine	870 J	600 J
Total (excluding non-detects)	5121	8853

a - J = (PQL), Quantified outside of instrument calibration range

Table 3-16. PCDD/PCDF concentration in composite ash sample, ng/kg of ash

Isomer	Compound	Avid Recycler	Non-Recycler
2378	TCDD	31	9
12378	PECDD	230	53
123478	HXCDD	270	44
123678	HXCDD	420	74
123789	HXCDD	300	56
1234678	HPCDD	4000	630
12346789	OCDD	9600	690
2378	TCDF	830	220
12378	PECDF	1000	270
23478	PECDF	2500	690
123478	HXCDF	2300	480
123678	HXCDF	2100	490
234678	HXCDF	2900	670
123789	HXCDF	810	150
1234678	HPCDF	12000	2100
1234789	HPCDF	1400	170
12346789	OCDF	8200	560
Total	TCDD	2500	490
Total	PECDD	4100	740
Total	HXCDD	5600	1300
Total	HPCDD	7600	1300
Total	OCDD	9600	690
Total	TCDF	25000	8200
Total	PECDF	21000	6600
Total	HXCDF	19000	4600
Total	HPCDF	17000	2900
Total	OCDF	8200	560
Total	PCDD	14851	1556
Total	PCDF	34040	5800
Total	PCDD/PCDF	48891	7356

Table 3-17. PCB concentration in composite ash sample, µg/kg of ash

Compound	Avid Recycler	Non-Recycler
BZ-1 (2-Chlorobiphenyl)	<2.5	4.9
BZ-7, BZ-9	2.1	2.1
BZ-6 (2,3'-Dichlorobiphenyl)	3.7	4.7
BZ-8, BZ-5	5.4	3.8
BZ-19 (2,2',6-Trichlorobiphenyl)	<0.5	5.6
BZ-18 (2,2',5-Trichlorobiphenyl)	32	6.3
BZ-24, BZ-27	12	<0.5
BZ-26 (2,3',5-Trichlorobiphenyl)	0.8	0.8
BZ-25 (2,3',4-Trichlorobiphenyl)	<0.5	0.7
BZ-31 (2,4',5-Trichlorobiphenyl)	1.5	0.9
BZ-28 (2,4,4'-Trichlorobiphenyl)	<0.5	0.5
BZ-20, BZ-33, BZ-53	2.2	0.9
BZ-51 (2,2',4,6'-Tetrachlorobiphenyl)	<0.5	1.5
BZ-45 (2,2',3,6-Tetrachlorobiphenyl)	5.3	1.3
BZ-52 (2,2',5,5'-Tetrachlorobiphenyl)	3.1	1.8
BZ-44 (2,2',3,5'-Tetrachlorobiphenyl)	2.6	1.2
BZ-37, BZ-42, BZ-59	1.8	1.7
BZ-41, BZ-64	1.8	<0.5
BZ-63, OCS	1.8	<0.5
BZ-66, BZ-95	1	0.8
BZ-56, BZ-60	1.6	2.1
BZ-99 (2,2',4,4',5-Pentachlorobiphenyl)	3.4	1.3
BZ-83 (2,2',3,3',5-Pentachlorobiphenyl)	0.4	<0.5
BZ-87, BZ-115	1.5	1.9
BZ-77, BZ-110	1.2	1
BZ-132, BZ-105	3.4	3.5
BZ-141 (2,2',3,4,5,5'-Hexachlorobiphenyl)	1.2	<0.5
BZ-138	<0.5	0.5
BZ-178	1.7	0.7
BZ-175	41	47
BZ-183	1.8	1.8
BZ-156	0.7	<0.5
BZ-180	<0.5	1.1
BZ-203, BZ-196	1.6	<0.5
BZ-189	0.6	<0.5
BZ-195	1.1	0.6
BZ-194	1.4	0.6
BZ-206	2.8	3.4
Total	142.5	105

Table 3-18. Metal concentration in composite ash sample, mg/kg

Compound	Avid Recycler	Non-Recycler
Ag	<9	8
Al	101000	<82400
As	320	<69
Ba	185	119
Be	0.9	<0.8
Ca	94600	139000
Cd	<3	<2
Co	11	5
Cr	300	92
Cu	4910	343
Fe	4390	3560
Hg	<0.1	0.1
K	5000	3110
Mb	<17	16
Mg	2870	2530
Mn	541	152
Na	5410	3450
Ni	22	<13
Pb	164	32
Se	<1	1
Sn	228	104
Sr	102	117
Ti	820	1740
V	37	32
Zn	11500	721

SECTION 4.0 SUMMARY AND CONCLUSIONS

A detailed emissions characterization study was undertaken to examine, characterize, and quantify emissions from the simulated burning of household waste materials in barrels. This study evaluated two separate experimental waste streams; that of an avid recycler, who removes most of the recyclable content from the waste stream prior to combustion, and that of a non-recycler, who combusts the entire stream of household waste. Estimated emissions were developed in units of mass emitted per mass of waste burned. Continuous gas samples were analyzed for O₂, CO₂, CO, NO, and THCs. Extractive samples from the gas phase were analyzed for VOCs, SVOCs, PAHs, PCBs, chlorobenzenes, PCDDs/PCDFs, aldehydes and ketones, HCl, HCN, and metals. Emissions of PM were also measured, including PM₁₀ and PM_{2.5}. Ash residue samples were analyzed for SVOCs, PCBs, PCDDs/PCDFs, and metals.

Substantial emissions of numerous pollutants were found, and significant differences were found between emissions from open burning of an avid recycler's and non-recycler's waste. In particular, however, there was a significant difference in emissions of many compounds between Run 1 and Run 2, both of which were nominally the same test conditions. These differences highlight the difficulties in generating statistically valid emissions data when evaluating emissions from complex combustion systems.

It was found that for most of the non-chlorinated compounds, including VOCs, SVOCs, PAHs, and aldehydes and ketones, emissions from the non-recycler were higher, both on a per mass burned and on a per day basis (based on waste generation statistics provided by NYSDEC). However, emissions of many of the chlorinated organics (on a per mass burned basis), particularly chlorobenzenes and PCDDs/PCDFs, were higher from the avid recycler. Emissions of PCBs were higher from the non-recycler, although the cause of this phenomenon is not known. On a per day basis, emissions of PCDDs/PCDFs are significantly higher for the avid recycler. This phenomenon is likely due to several factors, including the higher mass fraction of PVC in the avid recycler's waste, a different temperature profile, and possibly a different mix of metallic catalysts. It is also possible that some component of the non-recycler's waste may potentially serve to poison the metallic catalysts believed to be responsible for enhancing formation rates of PCDDs/PCDFs. Results from HCl sampling indicated much higher HCl emissions from the avid recycler, which is consistent with the higher emissions of chlorinated organics, and ash residue analysis indicated that the avid recycler's residue had more copper, which could contribute to higher emissions of PCDD/PCDF. However, differences in emissions of HCl alone could not explain the differences between the PCDDs/PCDFs of the various runs. It was noted that the temperature at the base of the burning bed was significantly lower in the case of the avid recycler than it was for the non-recycler. Gas-phase emissions of metals were not a strong function of the waste streams. PM emissions were much higher from the non-recycler. Almost all of the PM emissions from both test conditions were < 2.5 μm in diameter.

It may be useful to compare emissions from open burning of household waste to emissions from a full-scale municipal waste combustor (MWC) unit operating with good combustion and flue gas cleaning technology. Based

on data from a field test at an MWC²², and averaging the “Normal Good” PT-08, PT-09, and PT-11 test conditions from reference 22, using the samples taken at the pollution control device outlet, the data in Table 4-1 were generated. For the results from this study, concentrations of all target VOCs were summed to give total VOC emissions (concentrations below detection limit were set at zero). A similar treatment was taken for PAHs, chlorobenzenes (CBs), PCDDs/PCDFs and PCBs.

When plotted as a bar graph as shown in Figure 4-1, it is readily apparent that even the significant differences between the avid recycler and non-recycler’s emissions are minor in comparison to the difference between open burning of household waste and the controlled combustion of municipal waste at a dedicated MWC facility. Note that the value axis of Figure 4-1 is a logarithmic scale, showing that emissions from open burning can be several orders of magnitude higher than controlled combustion.

Table 4-1. Comparison between open burning of household waste and controlled combustion of municipal waste in a municipal waste combustor (MWC data from reference 22); all emissions are in µg/kg waste burned.

	Avid Recycler	Non-Recycler	MWC
PCDD	46.7	38.25	0.0016
PCDF	222.9	6.05	0.0019
CBs	1007.5	424.2	1.16
PAHs	23974.7	66035.65	16.58
VOCs	2052500	4277500	1.17

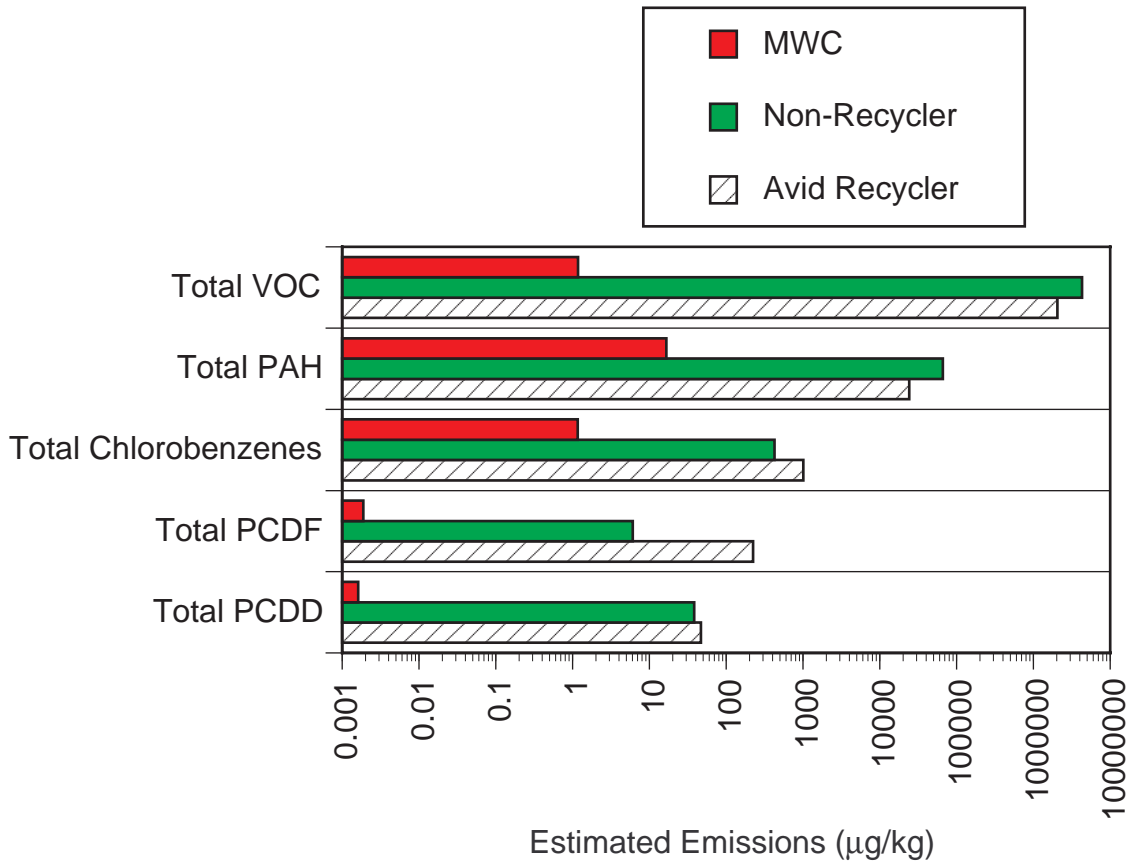

Figure 4-1. Comparison between open burning and controlled combustion.

As an additional comparison of open burning versus controlled combustion in a properly designed combustion device, Table 4-2 was created by calculating the total air pollutants produced per day using the estimated emissions per unit mass burned from Table 4-1, the waste generation rates described in Table 2-1, and comparing those values to a hypothetical 182,000 kg/day (200 ton/day) MWC facility emitting air pollutants at the rate described in Table 4-1. It should be noted that this size MWC facility processes the equivalent waste from 37,000 non-recycling and 121,000 avid recycling households. By dividing the daily estimated emissions from the MWC by the daily estimated emissions from open burning, it is possible to estimate how many open-burning households it would take to equal the air pollution produced by a moderately sized MWC facility. The number is surprisingly low, in fact for certain pollutants such as VOCs and chlorobenzenes, a single household that burns their trash in barrels produces more pollutants than a well-operated full-scale MWC facility. Comparing these results to other data in the literature finds that we are higher than the literature values, but not outrageously higher. The Western Lake Superior Sanitary District burn barrel test² reported 3.9E-12 lb 2,3,7,8-TCDD per lb garbage burned. Our data were non-detect on 2,3,7,8 TCDD at roughly < 5 E-10 kg/kg trash consumed by combustion. This is consistent but not very definitive. They report this as a 20x increase in the emission rate of 2,3,7,8 TCDD using burn barrels vs incinerators. The Illinois report¹ reports 0.6E-9 lb/lb refuse of total dioxins and furans. Note also that these numbers aren't a 1 to 1 comparison because of the total burned vs mass consumed by combustion factor. This conversion would tend to improve the agreement. These results are approximately a factor of 10 lower than our results. It is probable that the

fraction of PVC in the refuse contributes significantly to the total amount of PCDDs/PCDFs produced. For the refuse mixture described in Table 2-1, open burning in barrels produced very high levels of PCDDs/PCDFs.

Emissions from backyard burning of residential solid waste are released at ground level resulting in decreased dilution by dispersion. This could potentially exacerbate the potential impacts beyond what is apparent from the magnitude of the emissions alone. The large magnitude of the emissions, coupled with the concentration of these emissions in the local neighborhoods due to poor dispersions, will lead to increased direct inhalation exposure.

Table 4-2. Number of open-burning households to equal the air pollution from a full-scale MWC facility^a.

	Avid Recycler	Non-Recycler
PCDD	4.15	1.55
PCDF	1.03	11.65
CBs	140	100
PAHs	83.8	9.31
VOCs	0.07	0.01

a - using refuse generation rate supplied by NYSDEC, shown in Table 2-1; MWC burns 182,000 kg/day (200 ton/day)

Another issue related to this particular source is that it could potentially be a significant overall source of PCDDs/PCDFs. The EPA 1994 Draft Dioxin Reassessment document²³ attempted to conduct a mass balance for dioxin emissions in the United States and identified a significant gap between current deposition estimates and emission estimates. The deposition estimates were considerably higher than the emissions estimates. The EPA speculated that this indicated that there were unknown dioxin emission sources. The dioxin emissions from burn barrels may be a missing link to help account for the gap between measured deposition rates and the emissions inventories.

Table 4-3 illustrates the general trends as to which waste stream resulted in higher emissions. The first two columns are based on the mass/mass emissions, and the second two columns are based on mass/day emissions, using the waste generation rates reported by NYSDEC in Table 2-1. For the ash residue, estimates per person were based on both the waste generation rates reported by NYSDEC and the mass of material remaining after combustion shown in Table 3-1. Table 4-4 summarizes all of the test data into a single table, showing the average results for the various pollutants that were measured, along with the ratio between the avid recycler and non-recycler.

Table 4-3. Which test condition resulted in higher emissions?

Pollutant	mass emitted/mass burned		mass emitted/person ^a	
	Avid Recycler	Non-Recycler	Avid Recycler	Non-Recycler
Gas-Phase				
VOCs		X		X
SVOCs		X		X
PAHs		X		X
PCBs		X		X
chlorobenzenes	X			X
PCDDs/PCDFs	X		X	
aldehydes and ketones		X		X
HCl	X		X	
HCN		X		X
PM		X		X
metals	-	-	-	-
Ash Residue				
SVOCs		X		X
PCBs	X			X
PCDDs/PCDFs	X		X	
metals	-	-	-	-

a - using refuse generation rate supplied by NYSDEC, shown in Table 2-1.

Table 4-4. Summary of all test data

Parameter	Average, per mass lost			Average, per household		
	Recycler	Non-Recycler	Ratio	Recycler	Non-Recycler	Ratio
WASTE COMPOSITION						
total daily waste (kg)	1.5	4.9	0.31			
PVC in waste (kg)	0.07	0.01	7.00			
paper waste (kg)	0.98	3.02	0.32			
all plastics (kg)	0.23	0.36	0.64			
food (kg)	0	0.28	0.00	(same as per mass basis)		
textile, leather (kg)	0	0.18	0.00			
wood (kg)	0.06	0.05	1.20			
glass/ceramics (kg)	0.1	0.5	0.20			
metals (kg)	0.14	0.49	0.29			
COMBUSTION RESULTS						
max.bed temp. (°C)	370	740	0.50			
fraction burned (%)	66.7	49.1	1.36			
unburned residue (kg)	0.50	2.49	0.20			
AIR CONTAMINANT EMISSIONS						
		(mg/kg burned)			(mg/household•day)	
benzene (Fig. 3-30)	725	1240	0.58	725	2983	0.24
acetone (Fig. 3-30)	190	940	0.20	190	2262	0.08
styrene (Fig. 3-30)	310	740	0.42	310	1780	0.17
total TICs ^a (Tab. 3-3)	4000	14400	0.28	4002	34645	0.12
naphthalene (Fig. 3-31)	40	48	0.83	40	115	0.35
phenol (Fig. 3-31)	85	140	0.61	85	337	0.25
dichlorobenzenes (Tab. 3-6)	0.320	0.160	2.00	0.320	0.385	0.83
trichlorobenzenes (Tab. 3-6)	0.400	0.110	3.64	0.400	0.265	1.51
tetrachlorobenzenes (Tab. 3-6)	0.140	0.074	1.89	0.140	0.178	0.79
pentachlorobenzene (Tab. 3-6)	0.100	0.053	1.89	0.100	0.128	0.78
hexachlorobenzene (Tab. 3-6)	0.048	0.022	2.18	0.048	0.053	0.91
acenaphthylene (Tab. 3-7)	3.4	11	0.31	3.4	26	0.13
naphthalene (Tab. 3-7)	5.2	18	0.29	5.2	43	0.12
phenanthrene (Tab. 3-7)	3.3	7.3	0.45	3.3	18	0.19
aldehydes & ketones (Tab. 3-8)	140	2800	0.05	140	6737	0.02
total PCDD (Tab. 3-9)	0.047	0.038	1.24	0.047	0.091	0.51
total PCDF (Tab. 3-9)	0.22	0.0061	36	0.220	0.015	15
total PCB (Tab.3-10)	0.97	2.86	0.34	0.97	6.87	0.14
PM10 (Tab. 3-11)	5800	19000	0.31	5803	45712	0.13
PM2.5 (Tab. 3-11)	5.3	17.4	0.30	5.3	42	0.13
HCl (Table 3-14)	2400	284	8.47	2401	682	3.52
HCN (Table 3-14)	200	468	0.43	200	1126	0.18
RESIDUALS IN ASH						
	µg (or ng) per kg ash					
PCDD, ng/kg; (Tab.3-16)	14851	1556	9.54			
PCDF, ng/kg; (Tab.3-16)	34040	5800	5.87			
PCB, µg/kg (Tab. 3-17)	220	122	1.80			
Cr (Tab. 3-18)	300	92	3.26			
Cu (Tab. 3-18)	4910	343	14			
Pb (Tab. 3-18)	164	32	5.13			
Zn (Tab. 3-18)	11500	721	16			

a - Tentatively Identified (VOC) Compounds.

SECTION 5.0
REFERENCES

- 1 Two Rivers Regional Council of Public Officials, report prepared for U.S. EPA Region 5, Emission Characteristics of Burn Barrels, June 1994.

- 2 Western Lake Superior Sanitary District, "Burn Barrel Dioxin Test," August 1992, cited in Two Rivers Regional Council of Public Officials, report prepared for U.S. EPA Region 5, Emission Characteristics of Burn Barrels, June 1994.

- 3 Gerstle, R.W., and D.A. Kemnitz, "Atmospheric Emissions From Open Burning," Journal of Air Pollution Control Association, 17 (5), 324-327, May 1967.

- 4 Burckle, J. O., J.A. Dorsey, and B.T. Riley, "The Effects of the Operating Variables and Refuse Types on the Emission from a Pilot Scale Trench Incinerator," in Proceedings of 1968 National Incinerator Conference, 1968.

- 5 *Popular Mechanics Concrete Handbook: A Complete Guide to Mixing and Using Concrete Around the Home and Farm*, Popular Mechanics Company, Chicago, IL, 1956.

- 6 "Alsto's Handy Helpers, Practical Products for Your Home, Yard and Garden," Alsto's Handy Helpers, a Dick Blick Company, Galesburg, IL, Winter 1996.

- 7 Ryan, J.V., Characterization of Emissions from the Simulated Open Burning of Scrap Tires," EPA-600/2-89-054 (NTIS PB90-126004), October 1989.

- 8 Kariher, P., M. Tufts, and L. Hamel, Evaluation of VOC Emissions from Heated Roofing Asphalt, EPA-600/2-91-061 (NTIS PB92-115286), November 1991.

- 9 Ryan, J.V., and C.C. Lutes, Characterization of Emissions from the Simulated Open- Burning of Non-Metallic Automobile Shredder Residue, EPA-600/R-93-044 (NTIS PB93-172914), March 1993.

- 10 Lutes, C. C., R.J. Thomas, and R. Burnette, Evaluation of Emissions From Paving Asphalts, EPA-600/R-94-135 (NTIS PB95-129110), August 1994.

- 11 Lutes, C.C., and J.V. Ryan, Characterization of Air Emissions from the Simulated Open Burning of Fiberglass Materials, EPA-600/R-93-239 (NTIS PB94-136231), December 1993.
- 12 Lutes, C.C., and P.H. Kariher, Evaluation of Emissions from the Open Burning of Land-Clearing Debris, EPA-600/R-96-128 (NTIS PB97-115356), October 1996.
- 13 Winberry, W.T., N.T. Murphy, and R.M. Riggan, Compendium Method TO-14: "The Determination of Volatile Organic Compounds in Ambient Air using SUMMA[®] Passivated Canister Sampling and Gas Chromatographic Analysis," in Compendium of Methods for the Determination of Toxic Organic Compounds in Ambient Air, EPA-600/4-89-017 (NTIS PB90-127374), Quality Assurance Division, Environmental Monitoring Systems Laboratory, U.S. EPA, 1988.
- 14 "Operator's and Instruction Manual, Manual Dichotomous Sampler Model 241," Graseby/Anderson, General Metal Works, Village of Cleves, OH, May 1990.
- 15 40 - Code of Federal Regulations, Parts 1-51, Part 50, Appendix J. Revised as of July 1, 1993, Office of the Federal Register, National Archives and Records Administration, Washington, D.C.
- 16 Winberry, W.T., N.T. Murphy, and R.M. Riggan, Compendium Method TO-13: "The Determination of Benzo(a)Pyrene and Other Polynuclear Aromatic Hydrocarbons in Ambient Air using Gas Chromatographic and High Performance Liquid Chromatographic Analysis," in Compendium of Methods for the Determination of Toxic Organic Compounds in Ambient Air, EPA 600/4-89-017 (NTIS PB90-127374), Atmospheric Research and Exposure Assessment Laboratory, U.S. EPA, 1988.
- 17 Lentzen, D.E., D.E. Wagoner, E.D. Estes, and W.F. Gutnecht, IERL-RTP Procedures Manual: Level 1 Environmental Assessment (Second Edition), EPA-600/7-78-201 (NTIS PB293795), U.S. Environmental Protection Agency, Research Triangle Park, NC, October 1978.
- 18 Method 8270 in Test Methods for Evaluating Solid Waste, Vol. 1B, Field Manual Physical/Chemical Methods (Third Edition), U.S. EPA, SW-846 (NTIS PB88-239223), November 1986.
- 19 40 - Code of Federal Regulations, Part 61, Appendix B, Method 101A "Determination of Particulate and Gaseous Mercury Emissions from Sewage Sludge Incinerators," Revised as of July 1, 1991, U.S. Government Printing Office, Washington, D.C., 1991.

- 20 Winberry, W.T., N.T. Murphy, and R.M. Riggan, Compendium Method TO-9: "Method for the Determination of Polychlorinated Dibenzo-p-Dioxins (PCDDs in Ambient Air Using High-Resolution Gas Chromatography/High Resolution Mass Spectrometry (HRGC/HRMS)," in Compendium of Methods for the Determination of Toxic Organic Compounds in Ambient Air, EPA 600/4-89-017 (NTIS PB90-127374), Atmospheric Research and Exposure Assessment Laboratory, U.S. EPA, 1988.
- 21 Rigo, G.H., A.J. Chandler, and W.S. Lanier, The Relationship Between Chlorine in Waste Streams and Dioxin Emissions from Waste Combustor Stacks, ASME Research Report CRTD-Vol 36, 1996.
- 22 Finkelstein, A., and R.D. Klicius, National Incinerator Testing and Evaluation Program: The Environmental Characterization of Refuse-derived Fuel (RDF) Combustion Technology, Mid-Connecticut Facility, Hartford, Connecticut, EPA-600/R-94-140 (NTIS PB96-153432), December 1994.
- 23 U.S. Environmental Protection Agency, Public Draft Report: Estimating Exposure to Dioxin-Like Compounds, NTIS PB94-205499, Office of Health and Environmental Assessment, Washington D.C., June 1994.

TECHNICAL REPORT DATA		
Please read Instructions on the reverse before completing)		
1. REPORT NO. EPA/600/R-97-134a	2.	3. RECIPIENT'S ACCESSION NO.
4. TITLE AND SUBTITLE Evaluation of Emissions from the Open Burning of Household Waste in Barrels, Volume 1. Technical Report	5. REPORT DATE November 1997	
	6. PERFORMING ORGANIZATION CODE	
7. AUTHOR(S) Paul M. Lemieux	8. PERFORMING ORGANIZATION REPORT NO.	
9. PERFORMING ORGANIZATION NAME AND ADDRESS See Block 12	10. PROGRAM ELEMENT NO.	
	11. CONTRACT/GRANT NO. 68-D4-0005, Acurex Environmental Corporation	
12. SPONSORING AGENCY NAME AND ADDRESS EPA, Office of Research and Development Air Pollution Prevention and Control Division Research Triangle Park, NC 27711	13. TYPE OF REPORT AND PERIOD COVERED Final; 9/95 - 4/97	
	14. SPONSORING AGENCY CODE EPA/600/13	
15. SUPPLEMENTARY NOTES APPCD project officer is Paul M. Lemieux, Mail Drop 65, 919/541-0962. Volume 2 contains Appendices A-G.		
16. ABSTRACT <p>The report gives results of a detailed emissions characterization study, undertaken to examine, characterize, and quantify emissions from the simulated burning of household waste material in barrels. The study evaluated two waste streams: that of an avid recycler, who removed most of the recyclable content from the waste stream prior to combustion; and that of a non-recycler, who combusts the entire stream of household waste. Estimated emissions were developed in units of mass emitted per mass of waste burned. Continuous gas samples were analyzed for oxygen, carbon dioxide, carbon monoxide, nitric oxide, and total hydrocarbons. Gas-phase samples were collected using SUMMA canisters and analyzed by gas chromatography/mass spectroscopy (GC/MS) for volatile organic compounds (VOCs). Extractive samples from the combined particulate- and gas-phase were analyzed for semivolatile organic compounds (SVOCs), polycyclic aromatic hydrocarbons (PAHs), polychlorinated biphenyls (PCBs), chlorobenzenes (CBs), polychlorinated dibenzo-p-dioxins and polychlorinated dibenzofurans (PCDDs/PCDFs), aldehydes and ketones, hydrogen chloride (HCl), hydrogen cyanide (HCN), and metals. Emissions of particulate matter (PM) with aerodynamic diameters of 10 micrometers or less (PM10) and of 2.5 micrometers or less (PM2.5) were also measured.</p>		
17. KEY WORDS AND DOCUMENT ANALYSIS		
a. DESCRIPTORS	b. IDENTIFIERS/OPEN ENDED TERMS	c. COSATI Field/Group
Pollution Combustion Garbage Wastes Sewage Refuse	Emission Circulation Pollution Prevention Stationary Sources Household Wastes Recycling	13B 21B 14G
18. DISTRIBUTION STATEMENT Release to Public	19. SECURITY CLASS (This Report) Unclassified	21. NO. OF PAGES 77
	20. SECURITY CLASS (This Page) Unclassified	22. PRICE