



# Regulatory Impact Analysis for the Proposed Standards of Performance for Greenhouse Gas Emissions for New Stationary Sources: Electric Utility Generating Units

Regulatory Impact Analysis for the Proposed Standards of Performance for Greenhouse Gas  
Emissions for New Stationary Sources: Electric Utility Generating Units

U.S. Environmental Protection Agency  
Office of Air Quality Planning and Standards  
Health and Environmental Impacts Division  
Research Triangle Park, NC

## **CONTACT INFORMATION**

This document has been prepared by staff from the Office of Air Quality Planning and Standards, U.S. Environmental Protection Agency. Questions related to this document should be addressed to Amanda Curry Brown, U.S. Environmental Protection Agency, Office of Air Quality Planning and Standards, C439-02, Research Triangle Park, North Carolina 27711 (email: CurryBrown.Amanda@epa.gov).

## **ACKNOWLEDGEMENTS**

In addition to EPA staff from the Office of Air Quality Planning and Standards, personnel from the U.S. EPA Office of Atmospheric Programs and Office of Policy contributed data and analysis to this document.

## ACRONYMS

AEO	Annual Energy Outlook
BACT	Best Available Control Technology
BPT	Benefit-per-Ton
BSER	Best System of Emissions Reduction
Btu	British Thermal Units
CAA	Clean Air Act
CAIR	Clean Air Interstate Rule
CCR	Coal Combustion Residuals
CCS	Carbon Capture and Sequestration or Carbon Capture and Storage
CFR	Code of Federal Regulations
CH <sub>4</sub>	Methane
CO <sub>2</sub>	Carbon Dioxide
CRF	Capital Recovery Factor
CSAPR	Cross State Air Pollution Rule
CT	Combustion Turbines
CUA	Climate Uncertainty Adder
DICE	Dynamic Integrated Climate and Economy Model
DOE	U.S. Department of Energy
EAB	Environmental Appeals Board
EGR	Enhanced Gas Recovery
EGU	Electric Generating Unit
EIA	U.S. Energy Information Administration
EMM	Electricity Market Module
EO	Executive Order
EOR	Enhanced Oil Recovery
EPA	U.S. Environmental Protection Agency
ER	Enhanced Recovery
FERC	Federal Energy Regulatory Commission
FGD	Flue Gas Desulfurization
FOAK	First of a Kind
FOM	Fixed Operating and Maintenance
FR	Federal Register
FRCC	Florida Reliability Coordinating Council
FUND	Framework for Uncertainty, Negotiation, and Distribution Model

GDP	Gross Domestic Product
GHG	Greenhouse Gas
GS	Geologic Sequestration
Gt	Gigaton
H <sub>2</sub> S	Hydrogen Sulfide
HFC	Hydrofluorocarbons
IAM	Integrated Assessment Model
ICR	Information Collection Request
IGCC	Integrated Gasification Combined Cycle
IOU	Investor Owned Utility
IPCC	Intergovernmental Panel on Climate Change
IPM	Integrated Planning Model
IRP	Integrated Resource Plan
kWh	Kilowatt-hour
lbs	Pounds
LCOE	Levelized Cost of Electricity
LNB	Low NO <sub>x</sub> Burners
MATS	Mercury and Air Toxics Standards
MEA	Monoethanolamine
MGD	Millions of Gallons per Day
mg/L	Milligrams per Liter
mmBtu	Million British Thermal Units
MW	Megawatt
MWh	Megawatt-hour
N <sub>2</sub> O	Nitrous Oxide
NaOH	Sodium Hydroxide
NATCARB	National Carbon Sequestration Database and Geographic Information System
NEEDS	National Electric Energy Data System
NEMS	National Energy Modeling System
NERC	North American Electric Reliability Corporation
NETL	National Energy Technology Laboratory
NGCC	Natural Gas Combined Cycle
NOAK	Next of a Kind or Nth of a Kind
NO <sub>x</sub>	Nitrogen Oxide
NRC	National Research Council

NSPS	New Source Performance Standard
NSR	New Source Review
NTTAA	National Technology Transfer and Advancement Act
OFA	Overfire Air
OMB	Office of Management and Budget
PAGE	Policy Analysis of the Greenhouse Gas Effect Model
PFC	Perfluorocarbons
PM <sub>2.5</sub>	Fine Particulate Matter
ppm	Parts per Million
PRA	Paperwork Reduction Act
PSD	Prevention of Significant Deterioration
RCSP	Regional Carbon Sequestration Partnerships
RES	Renewable Electricity Standards
RFA	Regulatory Flexibility Act
RGGI	Regional Greenhouse Gas Initiative
RIA	Regulatory Impact Analysis
RPS	Renewable Portfolio Standards
SBREFA	Small Business Regulatory Enforcement Fairness Act
SCC	Social Cost of Carbon
SCPC	Super Critical Pulverized Coal
SCR	Selective Catalytic Reduction
SF <sub>6</sub>	Sulfur Hexafluoride
SIP	State Implementation Plan
SO <sub>2</sub>	Sulfur Dioxide
Tcf	Trillion Cubic Feet
TDS	Total Dissolved Solids
TSD	Technical Support Document
TSM	Transportation Storage and Monitoring
UMRA	Unfunded Mandates Reform Act
U.S.C.	U.S. Code
USGCRP	U.S. Global Change Research Program
USGS	U.S. Geological Survey
U.S. NRC	U.S. Nuclear Regulatory Commission
VCS	Voluntary Consensus Standards
VOM	Variable Operating and Maintenance

## TABLE OF CONTENTS

Executive Summary.....	1-1
1.1 Background and Context of Proposed Rule.....	1-1
1.2 Summary of the Proposed Rule.....	1-2
1.3 Key Findings of Economic Analysis.....	1-3
Chapter 2 Introduction and Background.....	2-1
2.1 Introduction.....	2-1
2.2 Background for the Proposed EGU New Source GHG Standards.....	2-3
2.3 Organization of the Regulatory Impact Analysis.....	2-7
Chapter 3 Defining the Climate Change Problem and Rationale for Rulemaking.....	3-1
3.1 Overview of Climate Change Impacts from GHG Emissions.....	3-1
3.2 References.....	3-8
Chapter 4 Electric Power Sector Profile.....	4-1
4.1 Introduction.....	4-1
4.2 Power Sector Overview.....	4-1
4.3 Deregulation and Restructuring.....	4-6
4.4 Emissions of Greenhouse Gases from Electric Utilities.....	4-7
4.5 Carbon Dioxide Control Technologies.....	4-11
4.6 Geologic Sequestration.....	4-14
4.7 GHG and Clean Energy Regulation in the Power Sector.....	4-22
4.8 Revenues, Expenses, and Prices.....	4-27
4.9 Natural Gas Market.....	4-31

4.10 Electricity Demand and Demand Response.....	4-33
4.11 References .....	4-35
 Chapter 5 Costs, Benefits, Economic, and Energy Impacts .....	 5-1
5.1 Synopsis.....	5-1
5.2 Requirements of the Proposed GHG EGU NSPS.....	5-2
5.3 Power Sector Modeling Framework.....	5-3
5.4 Analyses of Future Generating Capacity.....	5-6
5.5 Levelized Cost of Electricity Analysis .....	5-17
5.6 Comparison of Emissions from Generation Technologies.....	5-34
5.7 Benefits of Reducing GHGs and Other Pollutants .....	5-35
5.8 Comparison of Health and Welfare Impacts from Generation Technologies .....	5-42
5.9 Illustrative Analysis – Benefits and Costs across a Range of Gas Prices.....	5-46
5.10 Illustrative Analysis – Benefits and Costs of CCS Compared with Conventional Coal.....	5-50
5.11 Impact of the Proposed Rule on Option Costs .....	5-52
5.12 Summary of Costs, Benefits, and Energy Impacts .....	5-54
5.13 Macroeconomic and Employment Impacts.....	5-54
5.14 References .....	5-54
 Chapter 6 Statutory and Executive Order Analyses.....	 6-1
6.1 Synopsis.....	6-1
6.2 Executive Order 12866, Regulatory Planning and Review, and Executive Order 13563, Improving Regulation and Regulatory Review .....	6-1
6.3 Paperwork Reduction Act .....	6-2
6.4 Regulatory Flexibility Act .....	6-4



6.5	Unfunded Mandates Reform Act (UMRA) .....	6-7
6.6	Executive Order 13132, Federalism.....	6-8
6.8	Executive Order 13045, Protection of Children from Environmental Health Risks and Safety Risks .....	6-10
6.9	Executive Order 13211, Actions Concerning Regulations That Significantly Affect Energy Supply, Distribution, or Use .....	6-10
6.10	National Technology Transfer and Advancement Act .....	6-10
6.11	Executive Order 12898: Federal Actions to Address Environmental Justice in Minority Populations and Low-Income Populations .....	6-11

## LIST OF TABLES

Table 1-1. Proposed Emission Limits .....	1-3
Table 2-1. Proposed Emission Limits .....	2-6
Table 4-1. Existing Electricity Generating Capacity by Energy Source, 2011.....	4-3
Table 4-2. Total U.S. Electric Power Industry Retail Sales in 2011 (Billion kWh).....	4-3
Table 4-3. Electricity Net Generation in 2011 (Billion kWh).....	4-4
Table 4-4. Coal Steam Electricity Generating Units, by Size, Age, Capacity, and Thermal Efficiency (Heat Rate) .....	4-5
Table 4-5. Domestic Emissions of Greenhouse Gases, by Economic Sector (million metric tonnes of CO <sub>2</sub> equivalent).....	4-9
Table 4-6. Greenhouse Gas Emissions from the Electricity Sector (Generation, Transmission and Distribution), 2011 (million metric tonnes of CO <sub>2</sub> equivalent) .....	4-10
Table 4-7. Fossil Fuel Emission Factors in EPA Modeling Applications .....	4-12
Table 4-8. Total CO <sub>2</sub> Storage Resource.....	4-17
Table 4-9. Revenue and Expense Statistics for Major U.S. Investor-Owned Electric Utilities for 2010 (\$millions) .....	4-30
Table 4-10. Projected Revenues by Service Category in 2015 for Public Power and Investor- Owned Utilities (billions) .....	4-31
Table 5-1. Reference Case Unplanned Cumulative Capacity Additions (GW).....	5-9
Table 5-2. 2011 U.S. Electricity Net Generation and Projections for 2020, 2025, and 2030 (Billion kWh).....	5-11
Table 5-3. AEO 2013 Unplanned Cumulative Capacity Additions, GW (2020).....	5-13
Table 5-4. National Delivered 2020 Fuel Prices by AEO 2013 Scenario (2011\$/MMBtu).....	5-16
Table 5-5. Technology Cost and Performance (2011\$) .....	5-21
Table 5-6. Levelized Natural Gas Prices by Select AEO 2013 Scenario (2011\$/MMBtu).....	5-26
Table 5-7. AEO 2013 Regional Capital Cost Scalars by Capacity Type .....	5-27
Table 5-8. LCOE Estimates with Minimum and Maximum AEO 2013 Regional Capital Cost Scalars (2011\$/MWh) .....	5-28
Table 5-9. LCOE Estimates For Minimum and Maximum AEO 2013 Regional Capital Cost Scalars (2011\$/MWh) .....	5-29
Table 5-10. Illustrative Emissions Profiles, New Coal and Natural Gas-Fired Generating Units.....	5-36
Table 5-11. Social Cost of CO <sub>2</sub> , 2015-2050 <sup>a</sup> (in 2011\$) .....	5-40
Table 5-12. Monetized Health Co-Benefits Per Ton of PM <sub>2.5</sub> Precursor Reductions in 2020 (in 2011\$).....	5-43

Table 5-13. 2020 Incremental Benefits (\$/MWh, 2011\$) of Emission Reductions from Illustrative New Natural Gas Combined Cycle Generation <i>Relative to</i> New SCPC or IGCC Coal Generation without CCS .....	5-45
Table 5-14. 2020 Incremental Benefits (\$/MWh, 2011\$) of Emission Reductions from Coal- Fired Generation with CCS meeting 1,100 lbs/MWh Relative to New Coal-Fired Generation Without CCS.....	5-47
Table 5-15. Illustrative Costs and 2020 Social Benefits for SCPC with Partial Capture and Full Capture CCS Relative to SCPC without CCS (per MWh 2011\$) .....	5-52
Table 5-16. Illustrative Costs and 2020 Social Benefits for IGCC with Partial Capture and Full Capture CCS Relative to IGCC without CCS (per MWh 2011\$) .....	5-52
Table 6-1. Potentially Regulated Categories and Entities.....	6-5

## LIST OF FIGURES

Figure 4-1. Fossil Fuel-Fired Electricity Generating Facilities, by Size .....	4-6
Figure 4-2. Status of State Electricity Industry Restructuring Activities .....	4-8
Figure 4-3. Domestic Emissions of Greenhouse Gases, 2011 (million metric tonnes of CO <sub>2</sub> equivalent).....	4-9
Figure 4-4. GHG Emissions from the Power Sector Relative to Total Domestic GHG Emissions (2011) .....	4-11
Figure 4-5. Post-Combustion CO <sub>2</sub> Capture for a Pulverized Coal Power Plant .....	4-14
Figure 4-6. Pre-Combustion CO <sub>2</sub> Capture for an IGCC Power Plant.....	4-15
Figure 4-7. Growth of U.S. Oil Production from CO <sub>2</sub> -based EOR .....	4-21
Figure 4-8. U.S. CO <sub>2</sub> Storage Capacity and CO <sub>2</sub> -EOR operations .....	4-22
Figure 4-9. National Average Retail Electricity Price (1960 – 2011).....	4-29
Figure 4-10. Average Retail Electricity Price by State (cents/kWh), 2011.....	4-31
Figure 4-11. Natural Gas Spot Price, Annual Average (Henry Hub).....	4-34
Figure 4-12. Electricity Growth Rate (3-Year Rolling Average) and Projections from the Annual Energy Outlook 2013.....	4-35
Figure 5-1. Historical U.S. Power Plant Capacity Additions, by Technology, 1940-2011 ....	5-10
Figure 5-2. National Delivered Natural Gas Prices by Select AEO 2013 Scenario (2011\$/MMBtu).....	5-17
Figure 5-3. Illustrative Wholesale Levelized Cost of Electricity of Alternative New Generation Technologies by Cost Component, EPA.....	5-24
Figure 5-4. Illustrative Wholesale Levelized Cost of Electricity of Alternative New Generation Technologies Across Select Natural Gas Prices, EPA .....	5-25
Figure 5-5. Projected Real National Delivered Natural Gas Price for Select AEO 2013 Scenarios and Illustrative Path for > \$10/MMBtu Levelized Cost .....	5-27
Figure 5-6. Levelized Regional Fuel Price from AEO 2013 Reference Case, 2020-2039 (2011\$/MMBtu).....	5-29
Figure 5-7. Levelized Cost of Electricity, Uncontrolled Coal and Coal with Full and Partial CCS (1,100 lbs/MWh gross) .....	5-32
Figure 5-8. Levelized Cost of Electricity, Nuclear and Coal with Partial CCS (1,100 lbs/MWh gross).....	5-33
Figure 5-9. Levelized Cost of Electricity Across a Range of Capacity Factors, CT and NGCC (\$2011/MWh at \$3.84/MMBtu Levelized Natural Gas Price) .....	5-35
Table 5-10. Illustrative Emissions Profiles, New Coal and Natural Gas-Fired Generating Units .....	5-36

## EXECUTIVE SUMMARY

This Regulatory Impact Analysis (RIA) discusses potential benefits, costs, and economic impacts of the proposed Standards of Performance for Greenhouse Gas Emissions for New Stationary Sources: Electric Utility Generating Units (herein referred to as the EGU New Source GHG Standards).

### 1.1 Background and Context of Proposed Rule

The proposed EGU New Source GHG Standards will set emission limits for greenhouse gas emissions (GHG) from new fossil fuel fired electric generating units (EGU) constructed in the United States in the future. This rulemaking will apply to carbon dioxide (CO<sub>2</sub>) emissions from any affected fossil fuel-fired EGU that sells more than one-third of its potential electric output and more than 219,000 megawatt-hours (MWh) net-electrical output to the grid on a three year rolling average basis. The United States Environmental Protection Agency (EPA) is proposing requirements for these sources because CO<sub>2</sub> is a GHG and fossil fuel-fired power plants are the country's largest stationary source emitters of GHGs. As stated in the EPA's Endangerment and Cause or Contribute Findings for Greenhouse Gases Under Section 202(a) of the Clean Air Act (74 FR 66518) and summarized in Chapter 3 of this RIA, the anthropogenic buildup of GHGs in the atmosphere is very likely the cause of most of the observed global warming over the last 50 years.

On April 13, 2012, the EPA proposed new source performance standards for emissions of carbon dioxide for new affected fossil fuel-fired EGUs (77 FR 22392). After consideration of public comments received – totaling approximately 2.5 million – the EPA determined that significant revisions in its proposed approach are warranted to tailor the required emission limits to the different types of sources in the electricity sector. As such, the EPA is, in a separate action, rescinding the original proposal and is re-proposing standards of performance for new affected fossil fuel-fired EGUs.

The statutory authority for this action is Clean Air Act (CAA) section 111(b), which addresses standards of performance for new, modified, and reconstructed sources. Today's proposal applies to new sources, which are sources that “commence construction” after publication of the proposal. Based on current information, the Wolverine project in Rogers City, Michigan appears to be the only fossil fuel-fired boiler or integrated gasification combined cycle (IGCC) EGU project presently under development without carbon capture and storage (CCS) with an air permit that has not already commenced construction. We anticipate proposing

standards for this project when we finalize today's action if the project has not yet commenced construction and has not been canceled.

This rulemaking affects CAA section 111(b) new sources of GHG emissions from fossil fuel-fired EGUs but does not address GHG emissions from existing sources. This rulemaking also does not propose standards for modified or reconstructed sources. CAA Section 111(b) requires that the new source performance standards (NSPS) be reviewed every eight years. As a result, this rulemaking's analysis is primarily focused on projected impacts within the current eight-year NSPS timeframe.<sup>1</sup> EPA's finding of no new, unplanned conventional coal-fired capacity (and therefore, no projected costs or quantified benefits) is robust beyond the analysis period (past 2030 in both U.S. Energy Information Administration – EIA – and EPA baseline modeling projections) and across a wide range of alternative potential market, technical, and regulatory scenarios that influence power sector investment decisions. Sections 5.8 to 5.11 of this RIA discuss the social costs and benefits of the proposed standards in any limited cases where new coal plant builds are affected by the standard.

This rule is consistent with the Climate Action Plan announced by the President in June 2013 to cut the carbon pollution that causes climate change and affects public health. The President directed EPA to work expeditiously to complete carbon pollution standards for new power plants.<sup>2</sup> It is also consistent with the President's goal to ensure that "by 2035 we will generate 80 percent of our electricity from a diverse set of clean energy sources - including renewable energy sources like wind, solar, biomass and hydropower, nuclear power, efficient natural gas, and clean coal."<sup>3</sup> Additionally, this rule demonstrates to other countries that the United States is taking action to limit GHGs from its largest emissions sources, in line with our intention to demonstrate global leadership. The impact of GHGs is global, and U.S. action to reduce GHG emissions complements ongoing programs and efforts in other countries.

## **1.2 Summary of the Proposed Rule**

This rule proposes emission standards for affected fossil fuel-fired units within existing subparts – natural gas-fired stationary combustion turbines and fossil fuel-fired electric utility steam generating units (boilers and IGCC). All affected new fossil fuel-fired EGUs would be required to meet an output-based emission rate of a specific mass of CO<sub>2</sub> per MWh of

---

<sup>1</sup> Conditions in the analysis year of 2022 are represented by a model year of 2020.

<sup>2</sup> "The President's Climate Action Plan." June 2013. Available online at:

<http://www.whitehouse.gov/sites/default/files/image/president27sclimateactionplan.pdf>

<sup>3</sup> "Blueprint for a Secure Energy Future." March 30, 2011. Available online at:

[http://www.whitehouse.gov/sites/default/files/blueprint\\_secure\\_energy\\_future.pdf](http://www.whitehouse.gov/sites/default/files/blueprint_secure_energy_future.pdf)

electricity generated energy output on a gross basis. These standards would be met on a 12-operating month rolling average basis. The EPA is proposing standards of performance for affected sources within the following subcategories: (1) natural gas-fired stationary combustion turbines with a heat input rating to the turbine engine that is greater than 850 million British Thermal units per hour (MMBtu/hr); (2) natural gas-fired stationary combustion turbines with a heat input rating to the turbine engine that is less than or equal to 850 MMBtu/hr; and (3) all fossil fuel-fired boilers and IGCC units. The respective emission limits are shown in table 1-1.

**Table 1-1. Proposed Emission Limits**

Source	Emission Limit (lb CO <sub>2</sub> /MWh Gross Basis)
Stationary natural gas-fired combustion turbine EGUs with a heat input rating greater than 850 MMBtu/hr	1,000
Stationary natural gas-fired combustion turbine EGUs with a heat input rating less than or equal to 850 MMBtu/hr	1,100
Fossil fuel-fired boilers and IGCCs	1,100

This action also proposes an alternative emission limit, available only to new fossil-fuel fired boilers and IGCCs, which can be met over an 84-operating month rolling average basis. The alternative emission limit will be between 1,000 and 1,050 lb CO<sub>2</sub>/MWh of gross energy output.

### **1.3 Key Findings of Economic Analysis**

As explained in detail in this document, energy market data and projections support the conclusion that, even in the absence of this rule, existing and anticipated economic conditions will lead electricity generators to choose new generation technologies that meet the proposed standard without the need for additional controls. The base case modeling the EPA performed for this rule (as well as modeling that the EPA has performed for other recent air rules) projects that, even in the absence of this action, new fossil-fuel fired capacity constructed through 2022 and the years following will most likely be natural gas combined cycle capacity. Alternatively, coal-fired capacity with partial CCS could also be built at costs similar to the costs power companies are paying for other, lower CO<sub>2</sub>-emitting, non-natural gas, baseload generation technologies. Analyses performed both by the EPA and the EIA<sup>4</sup> project that generation technologies other than those utilizing coal (including natural gas-fired and renewable sources)

<sup>4</sup> Annual Energy Outlook (AEO) 2009- 2013.

are likely to be the technology of choice for new generating capacity due to current and projected economic market conditions.

Therefore, based on the analysis presented in Chapter 5, the EPA anticipates that the proposed EGU New Source GHG Standards will result in negligible CO<sub>2</sub> emission changes, energy impacts, quantified benefits, costs, and economic impacts by 2022. Accordingly, the EPA also does not anticipate this rule will have any impacts on the price of electricity, employment or labor markets, or the US economy. Nonetheless, this rule may have several important beneficial effects described below.

This NSPS would provide regulatory certainty that any new coal-fired power plant must limit CO<sub>2</sub> emissions by implementing some form of partial capture and storage. Therefore, the proposed regulation would provide an incentive for supporting research, development, and investment into technology to capture and store CO<sub>2</sub>. Rather than relying solely on dynamic energy market conditions to limit emissions from new power plants, this rule provides additional certainty to help incentivize innovation that would lead to lower CO<sub>2</sub> emissions in the future. The proposed rule is also a prerequisite for the regulation of existing sources within this source category under CAA section 111(d).

While sector-wide modeling does not project any new coal-fired EGUs without CCS to be built in the absence of this proposal, we recognize that a few companies may choose to construct coal or other solid fossil fuel-fired units. In Chapter 5 of this RIA we present an analysis of the project-level costs of a new coal-fired unit with and without CCS, and estimate the social benefits of requiring CCS on a new uncontrolled unit. We also present a sensitivity analysis indicating that even in the unlikely event that market conditions change sufficiently to make the widespread construction of new conventional coal-fired units economical from the perspective of private investors, this rule would result in net benefits from avoided negative health and environmental effects.

The rule will reduce regulatory uncertainty by defining requirements for emission limits for GHG from new fossil fuel-fired EGU sources. In addition, the EPA intends this rule to send a clear signal about the current and future status of CCS technology. Identifying partial implementation of CCS technology as the best system of emission reductions (BSER) for coal-fired power plants promotes further development of CCS, which is important for long-term CO<sub>2</sub> emission reductions. Particularly because the CCS technologies have had limited application to date, additional CCS applications are expected to lead to improvements in these technologies' performance and consequent reductions in their cost. Moreover, partial implementation of CCS



is a viable CO<sub>2</sub> control for new coal-fired power plants as identified in the BSER determination. Acknowledging that CCS is a viable control will encourage continued research, including, for example, continued research collaboration between the U.S. and China.<sup>5,6</sup>

---

<sup>5</sup> Statement by Department of Energy Secretary Steven Chu. Statement by Secretary Chu. <http://energy.gov/articles/building-clean-energy-partnerships-china-and-japan>.

<sup>6</sup> Friedman, Dr. Julio S. "A U.S. – China CCS Roadmap." Lawrence Livermore National Laboratory Carbon Management Program. <http://www.nrcce.wvu.edu/cleanenergy/docs/Friedmann.pdf>.

## CHAPTER 2 INTRODUCTION AND BACKGROUND

### 2.1 Introduction

In this action, the EPA seeks to set emission limits for GHGs, specifically CO<sub>2</sub>, emitted from fossil fuel-fired EGUs. This document presents the expected economic impacts of the proposed EGU New Source GHG Standards rule through 2022, including some projections for years up to 2030. Based on the analysis presented in Chapter 5, expected and anticipated economic conditions will lead electricity generators to choose fuels and technologies that are designed to meet the proposed standard without the need for additional capture or control, even in the absence of the rule. As a result, this rule is expected to have no, or negligible, costs or monetized benefits associated with it. This chapter contains background information on the rule and an outline of the chapters of the report.

#### 2.1.1 *Statutory Requirement*

Section 111 of the CAA requires performance standards for air pollutant emissions from categories of stationary sources that may reasonably contribute to endangerment of public health or welfare. In April 2007, the Supreme Court ruled in *Massachusetts v. EPA* that GHGs meet the definition of an “air pollutant” under the CAA. This ruling clarified that the authorities and requirements of the CAA apply to GHGs. As a result, the EPA must make decisions about whether to regulate GHGs under certain provisions of the CAA, based on relevant statutory criteria. The EPA issued a final determination that GHG emissions endanger both the public health and the public welfare of current and future generations in the *Endangerment and Cause or Contribute Findings for Greenhouse Gases Under Section 202(a) of the CAA* (74 FR 66,496; Dec. 15, 2009). Because fossil fuel-fired EGUs contribute significantly to domestic CO<sub>2</sub> emissions, the EPA is proposing this action to regulate these emissions from new EGU sources under section 111 of the CAA.

On April 13, 2012, the EPA proposed new source performance standards for emissions of CO<sub>2</sub> for new affected fossil fuel-fired EGUs (77 FR 22392). After consideration of public comments received – totaling approximately 2.5 million – the EPA determined that significant revisions in its proposed approach are warranted to tailor the required emission limits to the different types of sources in the electricity sector. As such, the EPA is, in a separate action, rescinding the original proposal and is re-proposing standards of performance for new affected fossil fuel-fired EGUs. This action addresses standards for new sources but does not address standards for modified, reconstructed, or existing sources.

### **2.1.2 Regulatory Analysis**

In accordance with Executive Order 12866, Executive Order 13563, and EPA's Guidelines for Preparing Economic Analyses, the EPA prepared this RIA for this "significant regulatory action." This rule is not anticipated to have an annual effect on the economy of \$100 million or more or adversely affect in a material way the economy, a sector of the economy, productivity, competition, jobs, the environment, public health or safety, or State, local, or tribal governments or communities and is therefore not an "economically significant rule." However, under EO 12866 (58 FR 51,735, October 4, 1993), this action is a "significant regulatory action" because it "raises novel legal or policy issues arising out of legal mandates." As a matter of policy, the EPA has attempted to provide a thorough analysis of the potential impacts of this rule, consistent with requirements of the Executive Orders.

This RIA addresses the potential costs and benefits of the new source emission limits that are the focus of this action. The EPA does not anticipate that any costs or quantified benefits will result from this proposed rule, if companies make the types of choices related to new generation that the EPA's modeling, EIA's modeling and many utility IRP's indicate they are likely to make. If some companies do choose to build new coal plants, there could be some compliance costs. However, in these cases, the rule will result in net societal benefits under a range of assumptions.

For new sources, the EPA and other energy modeling groups such as EIA<sup>1</sup> do not project that any new coal capacity without federally-supported CCS will be built in the analysis period. This is due in part to the low levelized cost of base load NGCC capacity relative to coal capacity, relatively low growth in electricity demand, and use of energy efficiency and renewable energy resources. This conclusion holds under a range of sensitivity analyses as well as in the EPA's baseline scenario. Furthermore, absent this rule, any new NGCC that may be built is expected to have an annual emission rate in compliance with the standard. Because this rule does not change these projections, it is expected to have no, or negligible, costs<sup>2</sup> or quantified benefits

---

<sup>1</sup> AEO 2009-2013.

<sup>2</sup> Because of existing and anticipated trends in the marketplace, the EPA does not project that any EGUs expected to be built within the time frame of our analysis will have to install additional controls to meet the standard. Additionally, because new generators would already be required to monitor and report their CO<sub>2</sub> emissions under the information collection requirements contained in the existing part 75 and 98 regulations (40 CFR part 75 and 40 CFR part 98), any additional monitoring or reporting costs from this proposed rule should be negligible. Costs are only incurred if there has been a violation of an emission standard caused by a malfunction and a source chooses to assert an affirmative defense. The owner/operator must meet the burden of proving all of the requirements in an affirmative defense. See Chapter 6 for more details on monitoring and reporting costs.

associated with it. Chapter 5 of this RIA also provides an illustrative analysis of the levelized cost of electricity and health and environmental impacts associated with representative new conventional coal and NGCC units, under a range of natural gas price assumptions. That analysis, along with information on historical<sup>3</sup> and projected<sup>4</sup> gas prices, supports the conclusion that this standard is highly likely to have no costs or benefits. While we do not project any new coal-fired EGUs without CCS to be built in the absence of this proposal, because some companies may choose to construct coal or other solid fossil fuel-fired units, Chapter 5 also includes an analysis of the project-level costs of a unit with and without CCS, to quantify the potential cost for a solid fossil fuel-fired unit with CCS. There is also a comparison of the costs and benefits for the proposed standard that can be met using partial CCS and a more stringent alternative requiring full CCS.

## **2.2 Background for the Proposed EGU New Source GHG Standards**

### **2.2.1 Baseline and Years of Analysis**

The rule on which this analysis is based proposes GHG emission limits for new EGUs. The baseline for this analysis, which uses the Integrated Planning Model (IPM), includes state rules that have been finalized and/or approved by a state's legislature or environmental agencies as well as final federal rules. Additional legally binding and enforceable commitments for GHG reductions considered in the baseline are discussed in Chapter 5 of this RIA.

All analysis is presented for compliance through the year 2022<sup>5</sup> and all estimates are presented in 2011 dollars. CAA Section 111(b) requires that the NSPS be reviewed every eight years. As a result, this rulemaking's analysis is primarily focused on projected impacts within the current eight-year NSPS timeframe. EPA's finding of no new, unplanned conventional coal-fired capacity (and therefore, no projected costs or quantified benefits) is robust beyond the analysis period (past 2030 in both EIA and EPA baseline modeling projections) and across a wide range of alternative potential market, technical, and regulatory scenarios that influence power sector investment decisions.<sup>6</sup> Sections 5.8 to 5.11 of this RIA discuss the social costs and benefits of the proposed standards in any limited cases where new coal plant builds are

---

<sup>3</sup> EIA. U.S. Natural Gas Prices. Available online at: [http://www.eia.gov/dnav/ng/ng\\_pri\\_sum\\_dcu\\_nus\\_a.htm](http://www.eia.gov/dnav/ng/ng_pri_sum_dcu_nus_a.htm).

<sup>4</sup> AEO 2009-2013.

<sup>5</sup> Conditions in the analysis year of 2022 are represented by a model year of 2020.

<sup>6</sup> For example, the low gas resource sensitivity scenario, one of the scenarios most favorable to new coal builds, does not begin to show new conventional coal builds until 2027. The No GHG Concern case does show limited amounts of conventional coal starting in 2023; however that model sensitivity case is unlikely to be reflected in actual markets given that investors factor in risks associated with all possible future policies (under both current authorities and potential legislation at the State and Federal levels) to reduce GHG emissions over the multi-decade life of the plant.

affected by the standard. Any estimates presented in this report represent annualized estimates of the benefits and costs of the proposed EGU New Source GHG Standards rather than the net present value of a stream of benefits and costs in these particular years of analysis.<sup>7</sup>

### **2.2.2 Definition of Affected Sources**

This action will directly regulate CO<sub>2</sub> emissions from affected EGUs that commence construction after the issuance of this proposed rule. This rulemaking does not address GHG emissions from existing, modified, or reconstructed sources.

#### *2.2.2.1 New Sources*

The statutory authority for this action is CAA section 111(b), which addresses standards of performance for new, modified, and reconstructed sources. Today's proposal applies to new sources, which are sources that "commence construction" after publication of the proposal. Based on current information, the Wolverine project in Rogers City, Michigan appears to be the only fossil fuel-fired boiler or IGCC EGU project presently under development without CCS with an air permit that has not already commenced construction. We anticipate proposing standards for this project when we finalize today's action if the project has not yet commenced construction and has not been canceled. See the preamble for further discussion.

#### *2.2.2.2 Modified Sources*

A modification is any physical or operational change to a source that increases the amount of any air pollutant emitted by the source or results in the emission of any air pollutant not previously emitted. However, projects to install pollution controls required under other CAA provisions are specifically exempted from the definition of "modifications" under 40 CFR 60.14(e)(5), even if they emit CO<sub>2</sub> as a byproduct. The significant majority of projects that the EPA believes EGUs are most likely to undertake in the foreseeable future that could increase the maximum achievable hourly rate of CO<sub>2</sub> emissions would be pollution control projects that are exempt under this definition. The EPA is not proposing a standard of performance for modifications at this time. As a result, existing sources that undertake modifications will continue to be treated as existing sources and thus not subject to the requirements of this rule.

---

<sup>7</sup> However, the CO<sub>2</sub>-related benefits, which are estimated using the social cost of carbon, vary depending on the year in which the change in CO<sub>2</sub> emissions occurs. The social cost of carbon increases over time because future emissions are expected to produce larger incremental damages as physical and economic systems become more stressed in response to greater climatic change. See Chapter 5 for details.

### *2.2.2.3 Reconstructed Sources*

The EPA's CAA section 111 regulations provide that reconstructed sources are to be treated as new sources and, therefore, subject to new source standards of performance. The regulations define reconstructed sources, in general, as existing sources: (i) that replace components to such an extent that the capital costs of the new components exceed 50 percent of the capital costs of an entirely new facility and (ii) for which compliance with standards of performance for new sources is technologically and economically feasible (40 CFR 60.15). Historically, very few power plants have undertaken reconstructions. We are not aware that any power plants are presently planning any project that would meet the requirements for a reconstruction. The EPA is not proposing a standard for reconstructions. As a result, sources that undertake reconstruction will be treated as existing sources and thus not subject to the requirements of this rule.

### *2.2.2.4 Existing Sources*

For the purposes of this rule, an existing EGU is defined as any fossil fuel-fired combustion unit that sells more than one-third of its potential electric output and more than 219,000 MWh net-electrical output to the grid on a three year rolling average basis and was in operation or commenced construction on or before publication of the proposed rule. Existing sources are not covered in this proposed rule.

## **2.2.3 Regulated Pollutant**

This rule sets a limit for CO<sub>2</sub> emissions from affected sources. The EPA is proposing these requirements because CO<sub>2</sub> is a GHG and fossil fuel-fired power plants are the country's largest stationary source emitters of GHGs. In 2009, the EPA found that by causing or contributing to climate change, GHGs endanger both the public health and the public welfare of current and future generations.

The EPA is aware that other GHGs such as nitrous oxide (N<sub>2</sub>O) (and to a lesser extent, methane (CH<sub>4</sub>)) may be emitted from fossil-fuel-fired EGUs, especially from coal-fired circulating fluidized bed combustors and from units with selective catalytic reduction and selective non-catalytic reduction systems installed for nitrogen oxide (NO<sub>x</sub>) control. The EPA is not proposing separate N<sub>2</sub>O or CH<sub>4</sub> emission limits or an equivalent CO<sub>2</sub> emission limit because of a lack of available data for these affected sources. Additional information on the quantity and significance of emissions and on the availability of cost effective controls would be needed before proposing standards for these pollutants.

### 2.2.4 Emission Limits

This rule proposes emission standards for affected fossil fuel-fired units within existing subparts – natural gas-fired stationary combustion turbines and fossil fuel-fired electric utility steam generating units (boilers and IGCC units). The EPA is proposing standards of performance for affected sources within the following subcategories: (1) natural gas-fired stationary combustion turbines with a heat input rating to the turbine engine that is greater than 850 million MMBtu/hr; (2) natural gas-fired stationary combustion turbines with a heat input rating to the turbine engine that is less than or equal to 850 MMBtu/hr; and (3) all fossil fuel-fired boilers and IGCC units. The respective emission limits are shown in table 2-1.

**Table 2-1. Proposed Emission Limits**

<b>Subcategory</b>	<b>Emission Limit (lb CO<sub>2</sub>/MWh)</b>
Stationary natural gas-fired combustion turbine EGUs with a heat input rating greater than 850 MMBtu/hr	1,000
Stationary natural gas-fired combustion turbine EGUs with a heat input rating less than or equal to 850 MMBtu/hr	1,100
Fossil fuel-fired boilers and IGCC	1,100

This action also proposes an alternative emission limit, available only to new fossil fuel-fired boilers and IGCC units, which can be met over an 84-operating month rolling average basis. The alternative emission limit will be between 1,000 and 1,050 lb CO<sub>2</sub>/MWh of gross energy output.

### 2.2.5 Emission Reductions

As will be discussed in more detail in Chapter 5 of this RIA, the EPA anticipates that the proposed EGU New Source GHG Standards will result in negligible changes in GHG emissions over the analysis period (through 2022 and following years). Even in the absence of this rule, the EPA expects that owners of new units will choose generation technologies that meet these standards due to expected economic conditions in the marketplace.

## 2.3 Organization of the Regulatory Impact Analysis

This report presents the EPA’s analysis of the potential benefits, costs, and other economic effects of the proposed EGU New Source GHG Standards to fulfill the requirements of an RIA. This RIA includes the following chapters:

- Chapter 3, Defining the Climate Change Problem and Rationale for the Rulemaking, describes the effects of GHG emissions on climate and offers support for the EPA undertaking this rulemaking.
- Chapter 4, Electric Power Sector Profile, describes the industry affected by the rule.
- Chapter 5, Costs, Benefits, Economic, and Energy Impacts, describes impacts of the proposed rule.
- Chapter 6, Statutory and Executive Order Impact Analyses, describes the small business, unfunded mandates, paperwork reduction act, environmental justice, and other analyses conducted for the rule to meet statutory and Executive Order requirements.



## CHAPTER 3

### DEFINING THE CLIMATE CHANGE PROBLEM AND RATIONALE FOR RULEMAKING

#### 3.1 Overview of Climate Change Impacts from GHG Emissions

Through the implementation of CAA regulations, EPA addresses the negative externalities caused by air pollution. In 2009, the EPA Administrator found that elevated concentrations of greenhouse gases in the atmosphere may reasonably be anticipated both to endanger public health and to endanger public welfare. It is these adverse impacts that make it necessary for the EPA to regulate GHGs from EGU sources. This proposed rule is designed to set emission limits for CO<sub>2</sub>, in order to minimize the rate of increase of concentrations of these gases in the atmosphere, and therefore reduce the risk of adverse effects.

This chapter summarizes the adverse effects on public health and public welfare detailed in the 2009 Endangerment Finding.<sup>1</sup> The major assessments by the U.S. Global Change Research Program (USGCRP), the Intergovernmental Panel on Climate Change (IPCC), and the National Research Council (NRC) served as the primary scientific basis for these effects.

##### 3.1.1 *Public Health*

Climate change threatens public health in a number of ways: direct temperature effects, the effect of higher CO<sub>2</sub> on other characteristics of air quality, the potential for changes in vector-borne diseases, and the potential for changes in the severity and frequency of extreme weather events. Additionally, susceptible populations may be particularly at risk. Each of these effects will be addressed in turn in this section, based on the 2009 Endangerment Finding.

Regarding direct temperature changes, it has already been observed that unusually hot days and heat waves are becoming more frequent, and that unusually cold days are becoming less frequent. Heat is already the leading cause of weather-related deaths in the United States. In the future, severe heat waves are projected to intensify in magnitude and duration over the portions of the United States where these events have already been observed. Heat waves are associated with marked short-term increases in mortality. Hot temperatures have also been associated with increased morbidity. If observed warming continues as projected, it will increase heat related mortality and morbidity, especially among the elderly, young, and frail. Different segments of the population are sensitive to these trends for different reasons. The most sensitive to hot temperatures are older adults, the chronically sick, the very young, city-

---

<sup>1</sup> Endangerment and Cause or Contribute Findings for Greenhouse Gases Under Section 202(a) of the Clean Air Act, 74 Fed. Reg. 66,496 (Dec. 15, 2009).

dwellers, and those taking medications that disrupt thermoregulation. Others that are demonstrated to be sensitive to this trend are the mentally ill, those lacking access to air conditioning, those working or playing outdoors, and socially isolated persons. As warming increases over time, these adverse effects would be expected to increase as the serious heat events become more frequent, prolonged, and extreme.

Conversely, increases in temperature are also expected to lead to some reduction in the risk of death related to extreme cold. However it is not clear whether reduced mortality in the United States from cold would be greater or less than increased heat-related mortality in the United States due to climate change. However, there is a risk that projections of cold-related deaths, and the potential for decreasing their numbers due to warmer winters, can be overestimated unless they take into account the tendency for deaths to increase in winter for reasons which are not strongly associated with cold temperatures, such as influenza. To illustrate the difficulty of measuring the total effect of these two related trends, the latest USGCRP report (2009) refers to a study (Medina-Ramon and Schwartz, 2007) that analyzed daily mortality and weather data in 50 U.S. cities from 1989 to 2000 and found that, on average, cold snaps in the United States increased death rates by 1.6 percent, while heat waves triggered a 5.7 percent increase in death rates. While a single study is not conclusive, this study concludes that increases in heat-related mortality due to global warming in the United States are likely to be greater than decreases in cold-related mortality.

Climate change is expected to increase regional ozone pollution compared to what ozone levels would be in the absence of climate change, with associated risks in respiratory illnesses and premature death. In addition to human health effects, tropospheric ozone has significant adverse effects on crop yields, pasture and forest growth, and the composition of plant and animal species populations.

Peer reviewed modeling studies discussed in the EPA's Interim Assessment (2009) show that modeled climate change causes increases in summertime ozone concentrations over substantial regions of the country, though this was not uniform. Some areas showed little change or slight decreases, though the decreases tend to be less pronounced than the increases. The key metric for regulating U.S. air quality is the maximum daily 8-hour average ozone concentration. For those regions that showed climate-induced increases, the increase in 2050, was in the range of 2 to 8 ppb, averaged over the summer season. The increases were substantially greater than 2 to 8 ppb during the peak pollution episodes that tend to occur over a number of days each summer. The overall effect of climate change was projected to increase ozone levels, compared to what would occur without this climate change, over broad areas of

the country, especially on the highest ozone days and in the largest metropolitan areas with the worst ozone problems. Ozone decreases are projected to be less pronounced, and generally to be limited to some regions of the country with smaller population.

In addition to impacts on heat-related mortality and air quality, there is also the potential for increased deaths, injuries, infectious diseases, and stress-related disorders and other adverse effects associated with social disruption and migration from more frequent extreme weather. Vulnerability to these disasters depends on the attributes of the people at risk and on broader social and environmental factors.

Increases in the frequency of heavy precipitation events are associated with increased risk of deaths and injuries as well as infectious, respiratory, and skin diseases. Floods are low-probability, high-impact events that can overwhelm physical infrastructure, human resilience, and social organization. Floods cause impacts to health that include deaths, injuries, infectious diseases, toxic contamination, and mental health problems.

Increases in tropical cyclone intensity (hurricanes and tropical storms) are linked to increases in the risk of deaths, injuries, waterborne and food borne diseases, as well as post-traumatic stress disorders. Storm surge is the major killer in coastal storms, and the risk of death by drowning from surge will be heightened by the projected rising sea levels and increased storm intensity. Flooding caused by intense cyclonic events can cause health impacts including direct injuries as well as increased incidence of waterborne diseases.

According to the assessment literature, there will also likely be an increase in the spread of serial episodes of food and water-borne pathogens among susceptible populations depending on the pathogens' survival, persistence, habitat range and transmission under changing climate and environmental conditions. Food borne diseases show some relationship with temperature. The range of some zoonotic disease carriers, such as the Lyme disease-carrying tick, may increase with temperature.

Climate change, including changes in CO<sub>2</sub> concentrations, could impact the production, distribution, dispersion, and allergenicity of aeroallergens and the growth and distribution of weeds, grasses, and trees that produce them. These changes in aeroallergens and subsequent human exposures could affect the prevalence and severity of allergy symptoms. However, the scientific literature does not provide definitive data or conclusions on how climate change might impact aeroallergens and subsequently the prevalence of allergenic illnesses in the United States. It has generally been observed that the presence of elevated CO<sub>2</sub> concentrations

and temperatures stimulate plants to increase photosynthesis, biomass, water use efficiency, and reproductive effort. The IPCC concluded that pollens are likely to increase with elevated temperature and CO<sub>2</sub>.

### **3.1.2 Public Welfare**

As with public health, there are multiple pathways in which the greenhouse gas air pollution and resultant climate change affect climate-sensitive economic sectors and environmental media. These sectors include food production and agriculture; forestry; water resources; sea level rise and coastal areas; energy, infrastructure, and settlements; and ecosystems and wildlife. Impacts also arise from climate change occurring outside of the United States, such as national security concerns for the United States that may arise as a result of climate change impacts in other regions of the world. Each of these effects will be addressed in turn in this section, based on the 2009 Finding.

Regarding food production and agriculture, elevated CO<sub>2</sub> concentrations can have a stimulatory effect, as may modest temperature increases and a resulting longer growing season. However, elevated CO<sub>2</sub> concentrations may also enhance pest and weed growth. In addition, higher temperature increases, changing precipitation patterns and variability, and any increases in ground-level ozone induced by higher temperatures, can work to counteract any direct stimulatory carbon dioxide effect, as well as lead to their own adverse impacts. A USGCRP report (2009) concluded that while for some crops such as grain and oilseed crops there may be a beneficial effect overall in the next couple decades, as temperature rises, these crops will increasingly begin to experience failure, especially if climate variability increases and precipitation lessens or becomes more variable. Changes in the intensity and frequency of extreme weather events such as droughts and heavy storms have the potential to have serious negative impact on U.S. food production and agriculture. Changing precipitation patterns, in addition to increasing temperatures and longer growing seasons, can change the demand for irrigation requirements, potentially increasing irrigation demand.

With respect to livestock, higher temperatures will very likely reduce livestock production during the summer season in some areas, but these losses will very likely be partially offset by warmer temperatures during the winter season. The impact on livestock productivity due to increased variability in weather patterns will likely be far greater than the effects associated with an absolute change in average climatic conditions.

For the forestry sector there are similar factors to consider. There is the potential for beneficial effects due to elevated concentrations of carbon dioxide, increased temperatures,

and nitrogen deposition, but there is also the potential for adverse effects from increasing temperatures, changing precipitation patterns, increased insects and disease, and the potential for more frequent and severe extreme weather events. According to the science assessment reports on which the Administrator relied for the 2009 Finding, climate change has very likely increased the size and number of wildfires, insect outbreaks, and increased tree mortality in the Interior West, the Southwest, and Alaska, and will continue to do so.

If existing trends in precipitation continue, it is expected that forest productivity will likely decrease in the Interior West, the Southwest, eastern portions of the Southeast, and Alaska, and that forest productivity will likely increase in the northeastern United States, the Lake States, and in western portions of the Southeast. An increase in drought events will very likely reduce forest productivity wherever such events occur.

The sensitivity of water resources to climate change is very important given the increasing demand for adequate water supplies and services for agricultural, municipal, and energy and industrial uses, and the current strains on this resource in many parts of the country. According to the assessment literature, climate change has already altered, and will likely continue to alter the water cycle, affecting where, when, and how much water is available for all uses. With higher temperatures, the water-holding capacity of the atmosphere and evaporation into the atmosphere increase, and this favors increased climate variability, with more intense precipitation and more droughts.

Climate change is causing and will increasingly cause shrinking snowpack induced by increasing temperature. In the western United States, there is already well-documented evidence of shrinking snowpack due to warming. Earlier meltings, with increased runoff in the winter and early spring, increase flood concerns and also result in substantially decreased summer flows. This pattern of reduced snowpack and changes to the flow regime pose very serious risks to major population regions, such as California, that rely on snowmelt-dominated watersheds for their water supply. While increased precipitation is expected to increase water flow levels in some eastern areas, this may be tempered by increased variability in the precipitation and the accompanying increased risk of floods and other concerns such as water pollution.

Climate change will likely further constrain already over-allocated water resources in some regions of the United States, increasing competition among agricultural, municipal, industrial, and ecological uses. Increased incidence of extreme weather and floods may also

overwhelm or damage water treatment and management systems, resulting in water quality impairments.

According to the assessment literature, sea level is rising along much of the U.S. coast and the rate of change will very likely increase in the future, exacerbating the impacts of progressive inundation, storm-surge flooding, and shoreline erosion. A large percentage of the U.S. population lives in these coastal areas. The most vulnerable areas are the Atlantic and Gulf Coasts, the Pacific Islands, and parts of Alaska. Cities such as New Orleans, Miami, and New York are particularly at risk, and could have difficulty coping with the sea level rise projected by the end of the century under a higher emissions scenario. Population growth and the rising value of infrastructure increases the vulnerability of coastal areas to climate variability and future climate change. Adverse impacts on islands present concerns for Hawaii and the U.S. territories. Reductions in Arctic sea ice increases extreme coastal erosion in Alaska, due to the increased exposure of the coastline to strong wave action. In the Great Lakes, where sea level rise is not a concern, both extremely high and low water levels resulting from changes to the hydrological cycle have been damaging and disruptive to shoreline communities.

Coastal wetland loss is being observed in the United States where these ecosystems are squeezed between natural and artificial landward boundaries and rising sea levels. Up to 21 percent of the remaining coastal wetlands in the U.S. mid-Atlantic region are potentially at risk of inundation between 2000 and 2100. Stress will increase on coastal habitats through the interaction of climate change with development and pollution related to development.

Although increases in mean sea level over the 21st century and beyond are projected to inundate unprotected, low-lying areas, the most devastating impacts are likely to be associated with storm surge. Superimposed on expected rates of sea level rise, projected storm intensity, wave height, and storm surge suggest more severe coastal flooding and erosion hazards. Higher sea level provides an elevated base from which storm surges occur and diminishes the rate at which low-lying areas drain, thereby increasing the risk of flooding from rainstorms. In New York City and Long Island, flooding from a combination of sea level rise and storm surge could be several meters deep. Projections suggest that the recurrence period of a 100-year flood event in this area might be reduced to 4–60 years by the 2080s. Additionally, some major urban centers in the United States, such as areas of New Orleans are situated in low-lying flood plains, presenting increased risk from storm surges.

With respect to infrastructure, climate change vulnerabilities of industry, settlement, and society are mainly related to changes in intensity and frequency of extreme weather events

rather than to gradual climate change. Extreme weather events could threaten U.S. energy infrastructure (transmission and distribution), transportation infrastructure (roads, bridges, airports and seaports), water infrastructure, and other built aspects of human settlements. Moreover, soil subsidence caused by the melting of permafrost in the Arctic region is a risk to gas and oil pipelines, electrical transmission towers, roads, and water systems.

Within settlements experiencing climate change stressors, certain parts of the population may be especially vulnerable based on their circumstances. These include the poor, the elderly, the very young, those already in poor health, the disabled, those living alone, and/or indigenous populations dependent on one or a few resources. In Alaska, indigenous communities are likely to experience disruptive impacts, including shifts in the range or abundance of wild species crucial to their livelihoods and well-being.

Climate change is exerting major influences on natural environments and biodiversity, and these influences are generally expected to grow with increased warming. Observed changes in the life cycles of plants and animals include shifts in habitat ranges, timing of migration patterns, and changes in reproductive timing and behavior.

The underlying assessment literature finds with high confidence that substantial changes in the structure and functioning of terrestrial ecosystems are very likely to occur with a global warming greater than 2 to 3 °C above pre-industrial levels, with predominantly negative consequences for biodiversity and the provisioning of ecosystem goods and services. With global average temperature changes above 2 °C, many terrestrial, freshwater, and marine species (particularly endemic species) are at a far greater risk of extinction than in the geological past. Climate change and ocean acidification will likely impair a wide range of planktonic and other marine calcifiers such as corals. Even without ocean acidification effects, increases in sea surface temperature of about 1 to 3 °C are projected to result in more frequent coral bleaching events and widespread coral mortality. In the Arctic, wildlife faces great challenges from the effects of climatic warming, as projected reductions in sea ice will drastically shrink marine habitat for polar bears, ice-inhabiting seals, and other animals.

Some common forest types are projected to expand, others are projected to contract, and others, such as spruce-fir, are likely to disappear from the contiguous United States. Changes in plant species composition in response to climate change can increase ecosystem vulnerability to other disturbances, including wildfires and biological invasion. Disturbances such as wildfires and insect outbreaks are increasing in the United States and are likely to intensify in a warmer future with warmer winters, drier soils and longer growing seasons. The

areal extent of drought-limited ecosystems is projected to increase 11 percent per °C warming in the United States. In California, temperature increases greater than 2°C may lead to conversion of shrubland into desert and grassland ecosystems and evergreen conifer forests into mixed deciduous forests. Greater intensity of extreme events may alter disturbance regimes in coastal ecosystems leading to changes in diversity and ecosystem functioning. Species inhabiting salt marshes, mangroves, and coral reefs are likely to be particularly vulnerable to these effects.

According to the USGCRP report of June 2009 and other sources, climate change impacts in certain regions of the world may exacerbate problems that raise humanitarian, trade, and national security issues for the United States.<sup>2</sup> The IPCC identifies the most vulnerable world regions as Africa, especially the sub-Saharan region, because of current low adaptive capacity as well as climate change; small islands, due to high exposure of population and infrastructure to risk of sea-level rise and increased storm surge; Asian mega-deltas due to large populations and high exposure to sea level rise, storm surge, and river flooding; and the Arctic, because of the effects of high rates of projected warming on natural systems. Climate change has been described as a potential threat multiplier with regard to national security issues. While some of these international risks do not readily lend themselves to precise analyses or future projections, given the unavoidable global nature of the climate change problem it is appropriate and prudent to consider how impacts in other world regions may present risks to the U.S. population.

### **3.2 References**

40 CFR Chapter I [EPA-HQ-OAR-2009-0171; FRL-9091-8] RIN 2060-ZA14, "Endangerment and Cause or Contribute Findings for Greenhouse Gases Under Section 202(a) of the Clean Air Act," Federal Register / Vol. 74, No. 239 / Tuesday, December 15, 2009 / Rules and Regulations.

Medina-Ramon, M. and J. Schwartz, 2007: Temperature, temperature extremes, and mortality: a study of acclimatization and effect modification in 50 U.S. cities. *Occupational and Environmental Medicine*, 64(12), 827-833.

---

<sup>2</sup> "In an increasingly interdependent world, U.S. vulnerability to climate change is linked to the fates of other nations. For example, conflicts or mass migrations of people resulting from food scarcity and other resource limits, health impacts or environmental stresses in other parts of the world could threaten U.S. national security." (Karl *et al.*, 2009).



U.S. Environmental Protection Agency (2009). *Assessment of the Impacts of Global Change on Regional U.S. Air Quality: A Synthesis of Climate Change Impacts on Ground-Level Ozone*. An Interim Report of the U.S. EPA Global Change Research Program. U.S. Environmental Protection Agency, Washington, DC, EPA/600/R-07/094.

U.S. Global Change Research Program (USGCRP). *Global Climate Change Impacts in the United States*. Thomas R. Karl, Jerry M. Melillo, and Thomas C. Peterson, (eds.). Cambridge University Press, 2009.

## **CHAPTER 4**

### **ELECTRIC POWER SECTOR PROFILE**

#### **4.1 Introduction**

This chapter discusses important aspects of the power sector that relate to the proposed EGU New Source GHG Standards, including the types of power-sector sources affected by the proposal, and provides background on the power sector and EGUs. In addition, this chapter provides some historical background on the EPA regulation of, and future projections for, the power sector.

#### **4.2 Power Sector Overview**

The production and delivery of electricity to customers consists of three distinct segments: generation, transmission, and distribution.

##### **4.2.1 Generation**

Electricity generation is the first process in the delivery of electricity to consumers. Most of the existing capacity for generating electricity does so by creating heat to create high pressure steam that is released to rotate turbines which, in turn, create electricity. The power sector consists of over 18,000 generating units, comprising fossil-fuel-fired units, nuclear units, and hydroelectric and other renewable sources dispersed throughout the country (see Table 4-1).

These electric generating sources provide electricity for commercial, industrial, and residential uses, each of which consumes roughly a quarter to a third of the total electricity produced (see Table 4-2). Some of these uses are highly variable, such as heating and air conditioning in residential and commercial buildings, while others are relatively constant, such as industrial processes that operate 24 hours a day.

**Table 4-1. Existing Electricity Generating Capacity by Energy Source, 2011**

Energy Source	Number of Generators	Generator Nameplate Capacity (MW)	Generator Net Summer Capacity (MW)
Coal	1,400	343,757	317,640
Petroleum	3,738	57,537	51,208
Natural Gas	5,574	477,387	415,191
Other Gases	91	2,202	1,934
Nuclear	104	107,001	101,419
Hydroelectric Conventional	4,048	78,194	78,652
Wind	781	45,982	45,676
Solar Thermal and Photovoltaic	326	1,564	1,524
Wood and Wood-Derived Fuels	345	8,014	7,077
Geothermal	226	3,500	2,409
Other Biomass	1,660	5,192	4,536
Hydroelectric Pumped Storage	154	20,816	22,293
Other Energy Sources	81	1,697	1,420
<b>Total</b>	<b>18,530</b>	<b>1,153,149</b>	<b>1,051,251</b>

Source: Table 4.3, EIA Electric Power Annual, 2011

Note: This table presents generation capacity. Actual net generation is presented in Table 4-3.

**Table 4-2. Total U.S. Electric Power Industry Retail Sales in 2011 (Billion kWh)**

	Sales/Direct Use (Billion kWh)	Share of Total End Use
Residential	1,423	37.9%
Commercial	1,328	35.4%
Industrial	991	26.4%
Transportation	8	0.2%
<b>Direct Use</b>	<b>133</b>	<b>3.5%</b>
<b>Total End Use</b>	<b>3,883</b>	<b>100%</b>

Source: Table 2.2, EIA Electric Power Annual, 2011

In 2011, electric generating sources produced 3,949 billion kWh to meet electricity demand. Roughly 70 percent of this electricity was produced through the combustion of fossil fuels, primarily coal and natural gas, with coal accounting for the largest single share (see Table 4-3).

**Table 4-3. Electricity Net Generation in 2011 (Billion kWh)**

	<b>Net Generation (Billion kWh)</b>	<b>Fuel Source Share</b>
Coal	1,718	43.5%
Petroleum	28	0.7%
Natural Gas	926	23.5%
Other Gases	3	0.1%
Nuclear	790	20.0%
Hydroelectric	312	7.9%
Other	172	4.3%
<b>Total</b>	<b>3,949</b>	<b>100%</b>

Source: Tables 3.2.A and 3.3.A, EIA Electric Power Annual, 2011

Note: Excludes generation from commercial and industrial sectors. Retail sales are not equal to net generation because net generation includes net exported electricity and loss of electricity that occurs through transmission and distribution.

Coal-fired generating units have historically supplied “base-load” electricity, the portion of electricity loads which are continually present, and typically operate throughout the day. Along with nuclear generation, these coal units meet the part of demand that is relatively constant. Although much of the coal fleet operates as base load, there can be notable differences across various facilities (see Table 4-4). For example, coal-fired units less than 100 megawatts (MW) in size compose 37 percent of the total number of coal-fired units, but only 6 percent of total coal-fired capacity. Gas-fired generation is better able to vary output and is the primary option used to meet the variable portion of the electricity load and has historically supplied “peak” and “intermediate” power, when there is increased demand for electricity (for example, when businesses operate throughout the day or when people return home from work and run appliances and heating/air-conditioning), versus late at night or very early in the morning, when demand for electricity is reduced.

The evolving economics of the power sector, in particular the increased natural gas supply and subsequent relatively low natural gas prices, have resulted in more gas being utilized as base load energy in addition to supplying electricity during peak load. Projections of new capacity and the impact of this rule on these new sources are discussed in more detail in Chapter 5 of this RIA.

**Table 4-4. Coal Steam Electricity Generating Units, by Size, Age, Capacity, and Thermal Efficiency (Heat Rate)**

Unit Size Grouping (MW)			No. Units	% of All Units	Avg. Age	Avg. Net Summer Capacity (MW)	Total Net Summer Capacity (MW)	% Total Capacity	Avg. Heat Rate (Btu/kWh)
0	to	25	193	15%	45	15	2,849	1%	11,154
>25	to	49	108	9%	42	38	4,081	1%	11,722
50	to	99	162	13%	47	75	12,132	4%	11,328
100	to	149	269	21%	49	141	38,051	12%	10,641
150	to	249	81	6%	43	224	18,184	6%	10,303
250	and up		453	36%	34	532	241,184	76%	10,193
<b>Totals</b>			<b>1,266</b>				<b>316,480</b>		

Source: National Electric Energy Data System (NEEDS) v.4.10

Note: The average heat rate reported is the mean of the heat rate of the units in each size category (as opposed to a generation-weighted or capacity-weighted average heat rate.) A lower heat rate indicates a higher level of fuel efficiency. Table is limited to coal-steam units online in 2010 or earlier, and excludes those units with planned retirements.

#### **4.2.2 Transmission**

Transmission is the term used to describe the movement of electricity over a network of high voltage lines, from electric generators to substations where power is stepped down for local distribution. In the U.S. and Canada, there are three separate interconnected networks of high voltage transmission lines,<sup>1</sup> each operating synchronously. Within each of these transmission networks, there are multiple areas where the operation of power plants is monitored and controlled to ensure that electricity generation and load are kept in balance. In some areas, the operation of the transmission system is under the control of a single regional operator; in others, individual utilities coordinate the operations of their generation, transmission, and distribution systems to balance their common generation and load needs.

<sup>1</sup>These three network interconnections are the western US and Canada, corresponding approximately to the area west of the Rocky Mountains; eastern US and Canada, not including most of Texas; and a third network operating in most of Texas. These are commonly referred to as the Western Interconnect Region, Eastern Interconnect Region, and ERCOT, respectively.

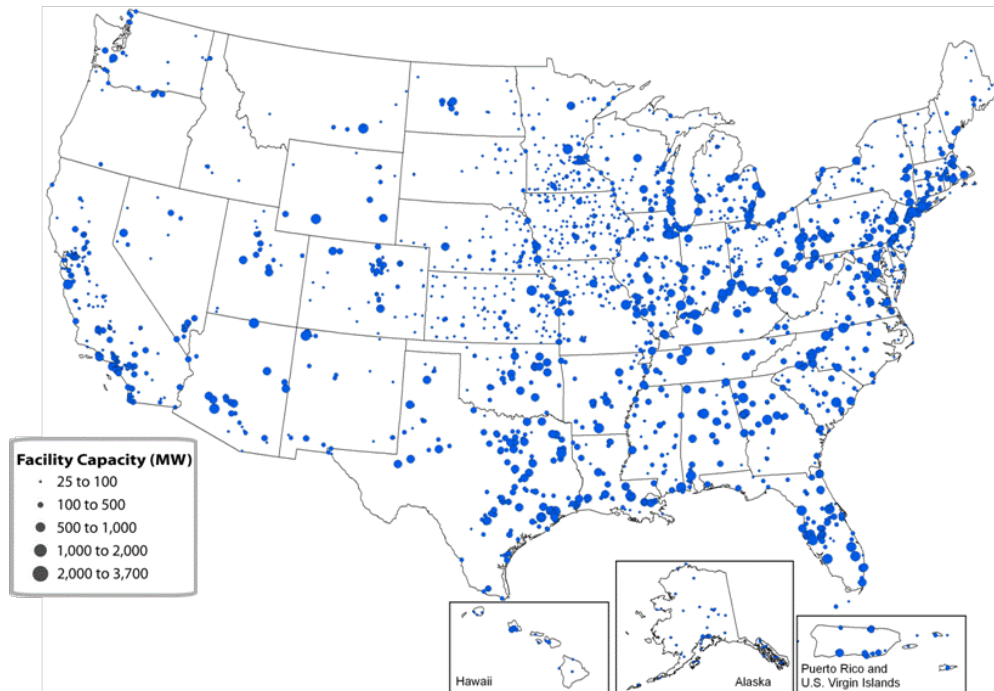

**Figure 4-1. Fossil Fuel-Fired Electricity Generating Facilities, by Size**

Source: National Electric Energy Data System (NEEDS) 4.10

Note: This map displays facilities in the NEEDS 4.10 IPM frame. NEEDS reflects available capacity on-line by the end of 2011. This includes planned new builds and planned retirements. In areas with a dense concentration of facilities, some facilities may be obscured.

### **4.2.3 Distribution**

Distribution of electricity involves networks of lower voltage lines and substations that take the higher voltage power from the transmission system and step it down to lower voltage levels to match the needs of customers. The transmission and distribution system is the classic example of a natural monopoly, in part because it is not practical to have more than one set of lines running from the electricity generating sources to substations or from substations to residences and businesses.

Transmission has generally been developed by the larger vertically integrated utilities that typically operate generation and distribution networks. Often distribution is handled by a large number of utilities that purchase and sell electricity, but do not generate it. Over the last couple of decades, several jurisdictions in the United States began restructuring the power industry to separate transmission and distribution from generation, ownership, and operation. As discussed below, electricity restructuring has focused primarily on efforts to reorganize the industry to encourage competition in the generation segment of the industry, including ensuring open access of generation to the transmission and distribution services needed to

deliver power to consumers. In many states, such efforts have also included separating generation assets from transmission and distribution assets to form distinct economic entities. Transmission and distribution remain price-regulated throughout the country based on the cost of service.

### **4.3 Deregulation and Restructuring**

The process of restructuring and deregulation of wholesale and retail electric markets has changed the structure of the electric power industry. In addition to reorganizing asset management between companies, restructuring sought a functional unbundling of the generation, transmission, distribution, and ancillary services the power sector has historically provided, with the aim of enhancing competition in the generation segment of the industry.

Beginning in the 1970s, government policy shifted against traditional regulatory approaches and in favor of deregulation for many important industries, including transportation (notably commercial airlines), communications, and energy, which were all thought to be natural monopolies (prior to 1970) that warranted governmental control of pricing. However, deregulation efforts in the power sector were most active during the 1990s. Some of the primary drivers for deregulation of electric power included the desire for more efficient investment choices, the economic incentive to provide least-cost electric rates through market competition, reduced costs of combustion turbine technology that opened the door for more companies to sell power with smaller investments, and complexity of monitoring utilities' cost of service and establishing cost-based rates for various customer classes.

The pace of restructuring in the electric power industry slowed significantly in response to market volatility in California and financial turmoil associated with bankruptcy filings of key energy companies. By the end of 2001, restructuring had either been delayed or suspended in eight states that previously enacted legislation or issued regulatory orders for its implementation (shown as "Suspended" in Figure 4-2 below). Eighteen other states that had seriously explored the possibility of deregulation in 2000 reported no legislative or regulatory activity in 2001 (EIA, 2003) ("Not Active" in Figure 4-2 below). Currently, there are 15 states where price deregulation of generation (restructuring) has occurred ("Active" in Figure 4-2 below). Power sector restructuring is more or less at a standstill; there have been no recent proposals to the Federal Energy Regulatory Commission (FERC) for actions aimed at wider restructuring, and no additional states have recently begun retail deregulation activity.

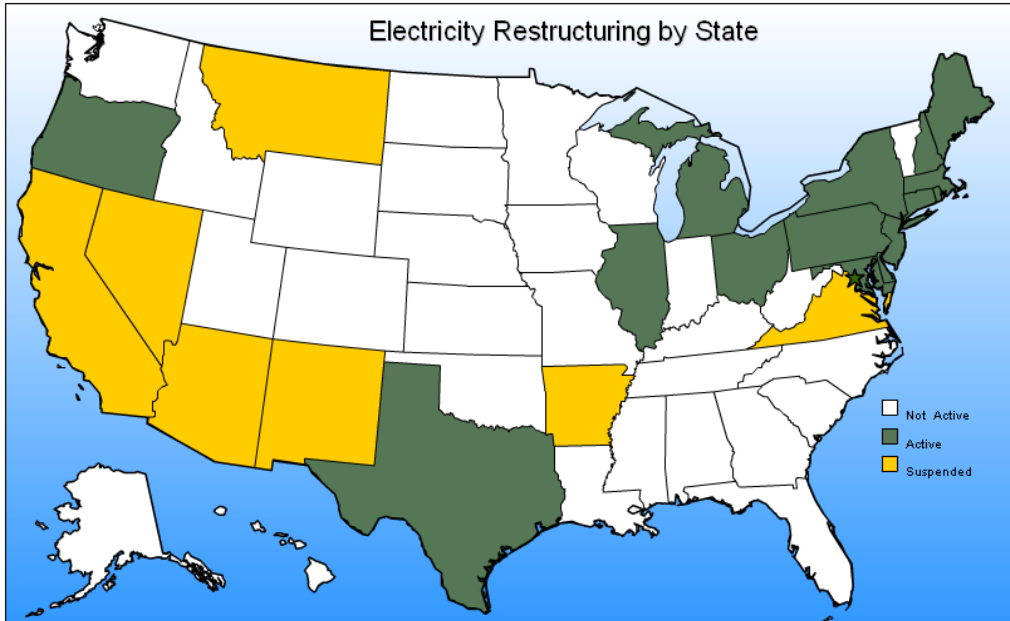

**Figure 4-2. Status of State Electricity Industry Restructuring Activities**

Source: EIA 2010a.

#### 4.4 Emissions of Greenhouse Gases from Electric Utilities

The burning of fossil fuels, which generates about 70 percent of our electricity nationwide, results in emissions of greenhouse gases. The power sector is a major contributor of CO<sub>2</sub> in particular, but also contributes to emissions of sulfur hexafluoride (SF<sub>6</sub>), CH<sub>4</sub>, and N<sub>2</sub>O. In 2011, the power sector accounted for 33 percent of total nationwide greenhouse gas emissions, measured in CO<sub>2</sub> equivalent, a slight increase from its 30 percent share in 1990. Table 4-5 and Figure 4-3 show the contributions of the power sector relative to other major economic sectors. Table 4-6 and Figure 4-4 show the contributions of CO<sub>2</sub> and other GHGs from the power sector.



**Table 4-5. Domestic Emissions of Greenhouse Gases, by Economic Sector (million metric tonnes of CO<sub>2</sub> equivalent)**

Sector/Source	1990	1995	2000	2005	2011
Electricity Generation	1,866	1,992	2,336	2,446	2,201
Transportation	1,553	1,697	1,927	2,012	1,829
Industry	1,539	1,558	1,504	1,416	1,332
Agriculture	458	511	501	517	547
Commercial	388	391	376	374	378
Residential	345	367	386	371	357
U.S. Territories	34	41	46	58	58
<b>Total Emissions</b>	<b>6,183</b>	<b>6,557</b>	<b>7,076</b>	<b>7,195</b>	<b>6,702</b>

Source: EPA 2013

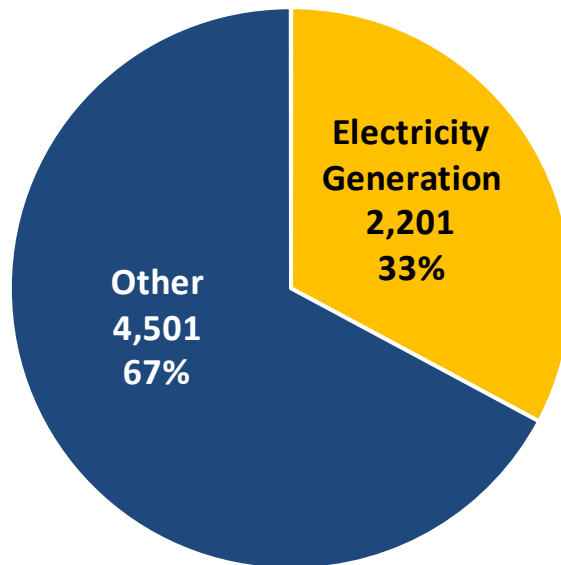

**Figure 4-3. Domestic Emissions of Greenhouse Gases, 2011 (million metric tonnes of CO<sub>2</sub> equivalent)**

Source: EPA 2013

**Table 4-6. Greenhouse Gas Emissions from the Electricity Sector (Generation, Transmission and Distribution), 2011 (million metric tonnes of CO<sub>2</sub> equivalent)**

Source	Total Emissions
<b>CO<sub>2</sub></b>	<b>2,175.5</b>
CO <sub>2</sub> from Fossil Fuel Combustion	2,158.5
<i>Coal</i>	1,722.7
<i>Natural Gas</i>	408.8
<i>Petroleum</i>	26.6
<i>Geothermal</i>	0.4
Incineration of Waste	12.4
Other Process Uses of Carbonates	4.6
<b>CH<sub>4</sub></b>	<b>0.4</b>
Stationary Combustion*	0.4
Incineration of Waste	+
<b>N<sub>2</sub>O</b>	<b>18.3</b>
Stationary Combustion*	17.9
Incineration of Waste	0.4
<b>SF<sub>6</sub>**</b>	<b>7.0</b>
Electrical Transmission and Distribution	7.0
<b>Total</b>	<b>2,201.2</b>

Source: EPA 2013

\* Includes only stationary combustion emissions related to the generation of electricity.

\*\* SF<sub>6</sub> is not covered by this rule, which specifically regulates GHG emissions from combustion.

+ Does not exceed 0.05 Tg CO<sub>2</sub> Eq. or 0.05 percent.

The amount of CO<sub>2</sub> emitted during the combustion of fossil fuels varies according to the carbon content and heating value of the fuel used (EIA, 2000) (see Table 4-7). Coal has higher carbon content than oil or natural gas and, thus, releases more CO<sub>2</sub> during combustion. Coal emits around 1.7 times as much carbon per unit of energy when burned as does natural gas (EPA 2013).

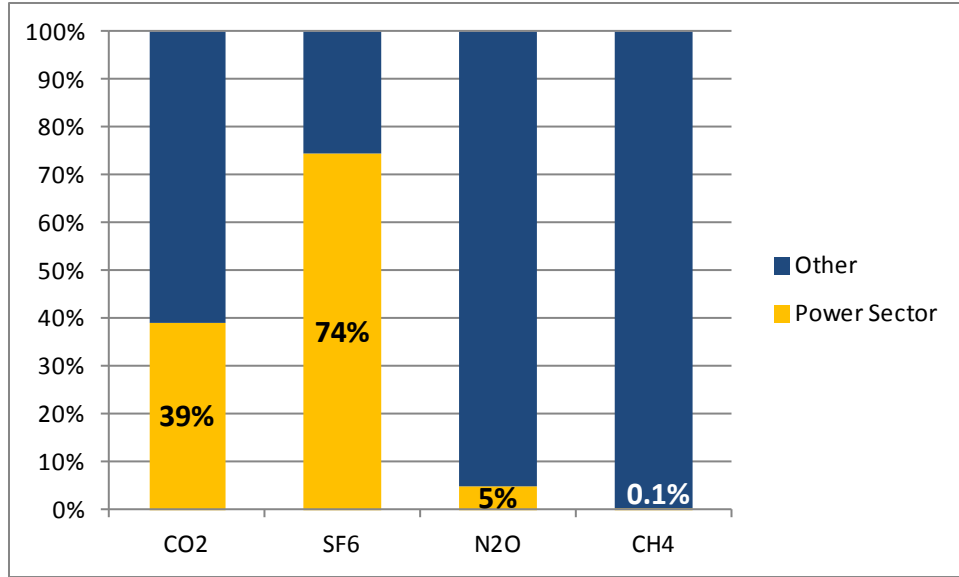

**Figure 4-4. GHG Emissions from the Power Sector Relative to Total Domestic GHG Emissions (2011)**

Source: EPA 2013

**Table 4-7. Fossil Fuel Emission Factors in EPA Modeling Applications**

Fuel Type	Carbon Dioxide (lbs/MMBtu)
Coal	
Bituminous	205.2 – 206.6
Subbituminous	212.7 – 213.1
Lignite	213.5 – 217.0
Natural Gas	117.1
Fuel Oil	
Distillate	161.4
Residual	161.4 – 173.9
Biomass*	195
Waste Fuels	
Waste Coal	205.7
Petroleum Coke	225.1
Fossil Waste	321.1
Non-Fossil Waste	0
Tires	189.5
Municipal Solid Waste	91.9

Source: Documentation for IPM Base Case v.4.10. See also Table 9.9 of IPM Documentation.

Note: CO<sub>2</sub> emissions presented here for biomass account for combustion only and do not reflect lifecycle emissions from initial photosynthesis (carbon sink) or harvesting activities and transportation (carbon source).

#### 4.5 Carbon Dioxide Control Technologies

In the power sector there are currently only a few technical approaches available for significantly reducing the CO<sub>2</sub> emissions of new fossil fuel combustion sources intended for intermediate and baseload operations. These include the use of: CCS, highest efficiency designs (e.g. supercritical or ultrasupercritical steam units, IGCC, or combined-cycle combustion-turbine/steam-turbine units), and/or low-emitting fuels (e.g. natural gas rather than coal).

Daily peak electricity demands, involving operation for relatively few hours per year, are often most economically met by simple-cycle combustion turbines (CT). Stationary CTs used for power generation can be installed quickly, at relatively low capital cost. They can be remotely started and loaded quickly, and can follow rapid demand changes. Full-load efficiencies of large current technology CTs are 30-33 percent (high heating value basis), as compared to efficiencies of 50 percent or more for new combined-cycle units that recover and use the exhaust heat otherwise wasted from a CT. A simple-cycle CT's lower efficiency causes it to burn much more fuel to produce a MWh of electricity than a combined-cycle unit. Thus, when burning natural

gas its CO<sub>2</sub> emission rate per MWh could be 40-60 percent higher than a more efficient NGCC unit.

Baseload electricity demand can be met with NGCC generation, coal and other fossil-fired steam generation, and IGCC technology, as well as generation from sources that do not emit CO<sub>2</sub>, such as nuclear and hydro. IGCC employs the use of a “gasifier” to transform fossil fuels into synthesis gas (“syngas”) and heat. The syngas is used to fuel a combined cycle generator, and the heat from the syngas conversion can produce steam for the steam turbine portion of the combined cycle generator. Electricity can be generated through this IGCC process somewhat more efficiently than through conventional boiler-steam generators. Additionally, with gasification, some of the syngas can be converted into other marketable products such as fertilizer, and CO<sub>2</sub> can be captured for use in EOR.

#### **4.5.1 Carbon Capture and Storage**

Carbon capture technology has been successfully applied since 1930 on several smaller scale industrial facilities and is currently in the demonstration phase for power sector applications. There are currently larger-scale projects under construction or in the advanced planning stages. CCS can be achieved through either pre-combustion or post-combustion capture of CO<sub>2</sub> from a gas stream associated with the fuel combusted. Furthermore, CCS can be designed and operated for full capture of the CO<sub>2</sub> in the gas stream (i.e., above 90 percent) or for partial capture (below 90 percent).

For post-combustion capture, CO<sub>2</sub> is stripped from the flue gas by passing the flue gas through a liquid absorbent which selectively reacts with the gaseous carbon dioxide to remove it from the combustion gas stream. The absorbent, upon saturation, transfers to a downstream operation which regenerates the absorbent by desorbing the CO<sub>2</sub> back to gaseous form. The absorbent recycles back into the process to repeat the capture cycle while the removed carbon dioxide is compressed, sent to storage and sequestered. This process is illustrated for a pulverized coal power plant in Figure 4-5. For post-combustion, a station's net generating output could be 20-30 percent lower due to the energy needs of the capture process.

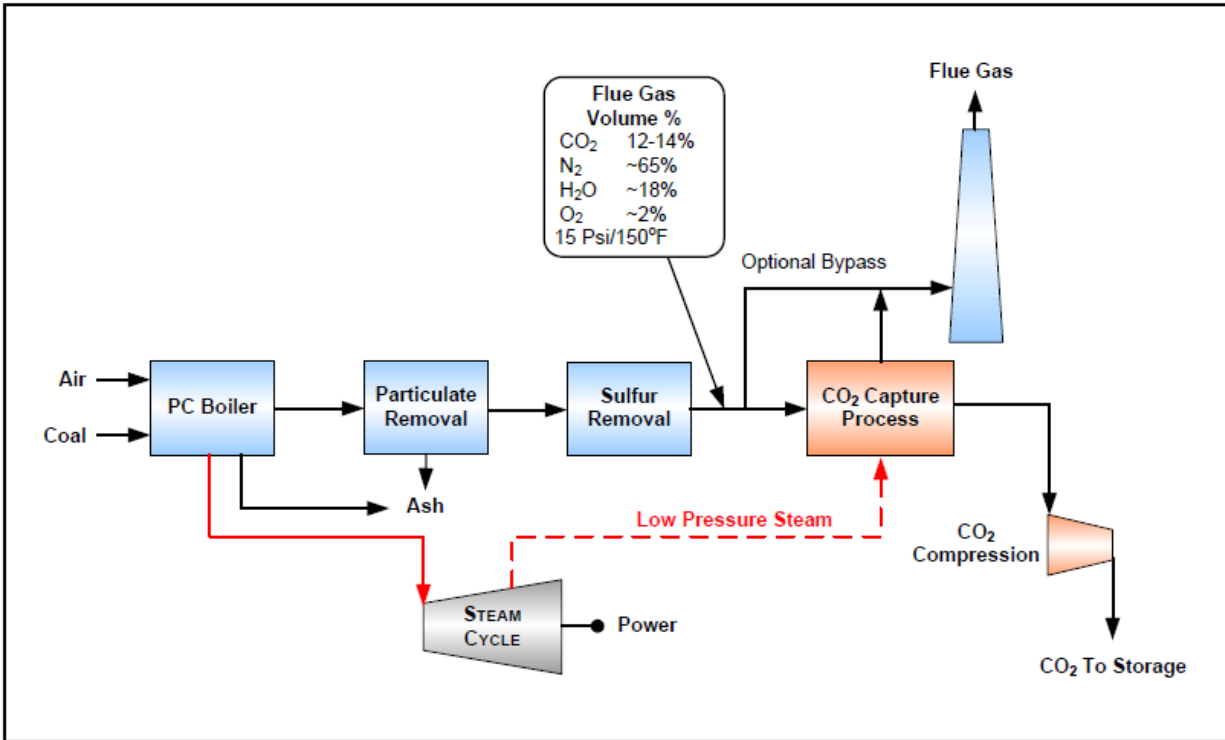
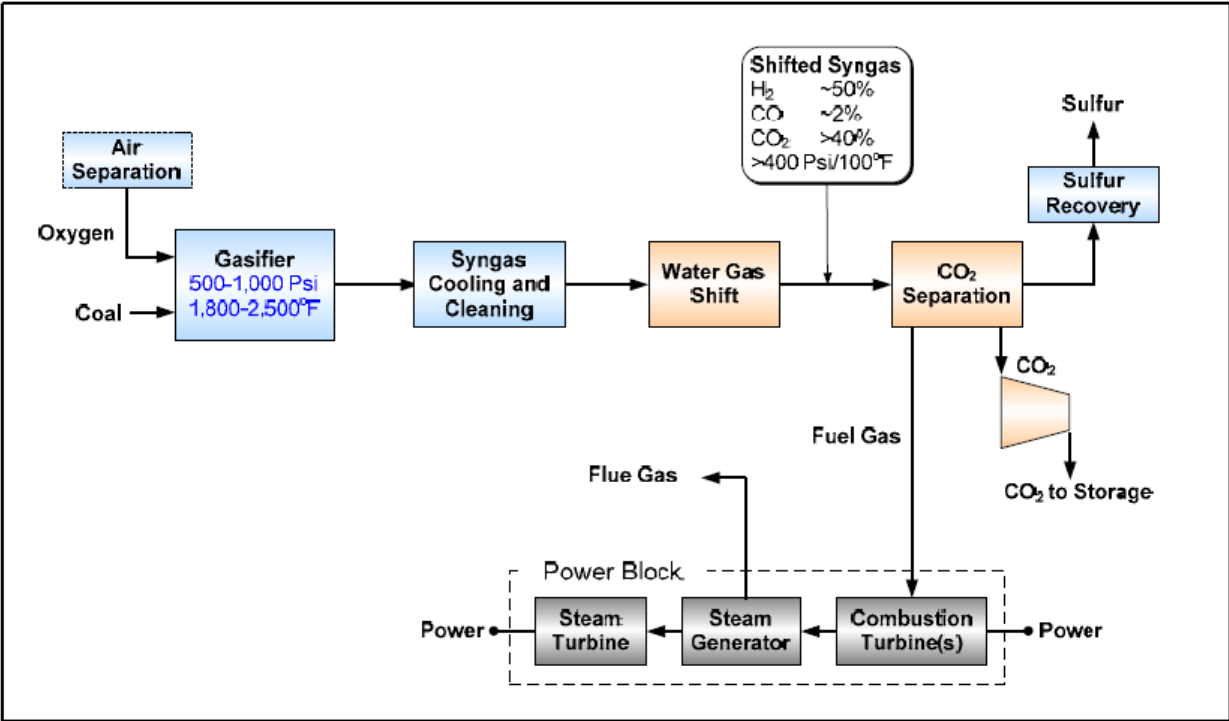

**Figure 4-5. Post-Combustion CO<sub>2</sub> Capture for a Pulverized Coal Power Plant**

Source: Interagency Task Force on Carbon Capture and Storage 2010

Pre-combustion capture is mainly applicable to IGCC facilities, where the fuel is converted into gaseous components (“syngas”) under heat and pressure and some percentage of the carbon contained in the syngas is captured before combustion. For pre-combustion technology, a significant amount of energy is needed to gasify the fuel(s). This process is illustrated in Figure 4-6. Application of post-combustion CCS with IGCC can be designed to use no water-gas shift, or single- or two-stage shift processes, to obtain varying percentages of CO<sub>2</sub> removal – from a “partial capture” percentage to 90 percent “full capture.” Pre-combustion CCS typically has a lesser impact on net energy output than does post-combustion CCS. For more detail on the current state of CCS technology, see the “Report of the Interagency Task Force on Carbon Capture and Storage” (2010).<sup>2</sup>

<sup>2</sup> For more information on the cost and performance of CCS, see [http://www.netl.doe.gov/energy-analyses/baseline\\_studies.html](http://www.netl.doe.gov/energy-analyses/baseline_studies.html).



**Figure 4-6. Pre-Combustion CO<sub>2</sub> Capture for an IGCC Power Plant**

Source: Interagency Task Force on Carbon Capture and Storage 2010

**4.6 Geologic Sequestration**

**4.6.1 Availability of Geologic Sequestration**

Geologic storage potential for CO<sub>2</sub> is widespread and available throughout the U.S. and Canada. Geologic formations suitable for sequestration include depleted oil and gas fields, deep coal seams, and saline formations. The Department of Energy’s (DOE) National Energy Technology Laboratory (NETL) estimates the current total CO<sub>2</sub> storage resource is approximately 2,380 to 20,353 billion metric tons (2,625 to 22,435 billion tons) in the U.S. and Canada.<sup>3</sup> DOE’s estimates are intended to be used as an initial assessment of potential geologic storage. The assessments are intended to identify general geographical distribution of CO<sub>2</sub> storage resources. This resource estimation is volumetrically based on physically accessible CO<sub>2</sub> storage in specific formations in sedimentary basins without consideration of injection rates, regulations, economics, or surface land usage. Other types of geologic formations such as organic rich shale and basalt may have the ability to store CO<sub>2</sub>, and DOE is currently

<sup>3</sup> The United States 2012 Carbon Utilization and Storage Atlas, Fourth Edition, U.S Department of Energy, Office of Fossil Energy, National Energy Technology Laboratory (NETL).

evaluating their potential future storage capacity. Potential sequestration sites must undergo appropriate site characterization to ensure that the site can safely and securely store CO<sub>2</sub>.

Estimates of CO<sub>2</sub> storage resources by state/province from the DOE report are provided in Table 4-8. These state and province level estimates are obtained from DOE's National Carbon Sequestration Database and Geographic Information System (NATCARB). Nearly every state in the U.S. has or is in close proximity to carbon storage potential including vast areas offshore. Information and methods used in estimating CO<sub>2</sub> storage resource can be found in the "Methodology for Development of Geologic Storage Estimates for Carbon Dioxide" in Appendix B of the Carbon Utilization and Storage Atlas.<sup>4</sup> It should be noted that the assessment of U.S. sequestration potential is an ongoing process. There is significant uncertainty in areas such as the Atlantic offshore due to a relative paucity of data and other factors.

In addition, the Department of Interior's U.S. Geological Survey (USGS) recently completed an evaluation of the technically accessible storage resource for carbon storage for 36 sedimentary basins in the onshore areas and State waters of the United States.<sup>5</sup> The USGS assessment estimates a range of 2,300 to 3,700 billion metric tons and a mean of 3,000 billion metric tons of CO<sub>2</sub> storage potential across the United States. Technically accessible storage resources are those that can be accessed using today's technology and pressurization and injection techniques. For comparison, this amount is 500 times the 2011 annual U.S. energy-related CO<sub>2</sub> emissions of 5.5 Gigatons (Gt)<sup>6</sup> Areas that were assessed by the USGS for CO<sub>2</sub> storage compliment and are not identical to the areas assessed by DOE, NATCARB. The USGS estimates are fractions of the total in-place resource that may be recoverable with technological advances or unforeseen changes in economic factors. This partly explains the difference between the USGS and DOE storage potential estimates. The USGS assessment methodology for CO<sub>2</sub> storage resources focuses on the technically accessible resource, not a total in-place resource volume. In addition, the USGS methodology is not an economic assessment, nor does it incorporate engineering constraints in the estimation of the volume of the resource. The methodology does not take into account potential storage formations with salinities less than 10,000 ppm (parts per million; mg/L (milligrams per liter)) total dissolved solids (TDS) which is the definitional limit the U.S. Environmental Protection Agency uses for underground sources of drinking water. Similar to the DOE's storage resource assessment, the

---

<sup>4</sup> Ibid.

<sup>5</sup> U.S. Geological Survey Geologic Carbon Dioxide Storage Resources Assessment Team, 2013, National assessment of geologic carbon dioxide storage resources – Summary: U.S. Geological Survey Factsheet 2013-3020, 6p.<http://pubs.usgs.gov/fs/2013/3020/>.

<sup>6</sup> U.S. Energy Information Administration, 2012



USGS methodology does not apply to site-specific evaluation of storage resources or capacity.<sup>7</sup> The USGS assessment provides further evidence of the widespread availability CO<sub>2</sub> storage reserves in the U.S. based on the comprehensive evaluation of the technically accessible storage resource for carbon storage for 36 sedimentary basins in the onshore areas and State waters of the United States.<sup>8</sup>

**Table 4-8. Total CO<sub>2</sub> Storage Resource<sup>9</sup>**

State/Province	Million Metric Tons*	
	Low Estimate	High Estimate
ALABAMA	122,490	694,380
ALASKA	8,640	19,750
ALBERTA	41,840	131,230
ARIZONA	130	1,170
ARKANSAS	6,180	63,670
BRITISH COLUMBIA	910	3,860
CALIFORNIA	33,890	420,630
COLORADO	37,610	357,190
CONNECTICUT		
DELAWARE	40	40
DISTRICT OF COLUMBIA		
FLORIDA	102,740	555,010
GEORGIA	145,340	159,050
HAWAII		
IDAHO	40	390
ILLINOIS	10,020	116,820
INDIANA	32,020	68,210
IOWA	10	50
KANSAS	10,880	86,340
KENTUCKY	2,920	7,650
LOUISIANA	169,500	2,103,980
MAINE		
MANITOBA	1,720	3,520
MARYLAND	1,860	1,930
MASSACHUSETTS		

<sup>7</sup> Brennan, S.T., Burruss, R.C., Merrill, M.D., Freeman, P.A., and Ruppert, L.F., 2010, A probabilistic assessment methodology for the evaluation of geologic carbon dioxide storage: U.S. Geological Survey Open-File Report 2010-1127, 31 p., available online at <http://pubs.usgs.gov/of/2010/1127>.

<sup>8</sup> U.S. Geological Survey Geologic Carbon Dioxide Storage Resources Assessment Team, 2013, National assessment of geologic carbon dioxide storage resources – Summary: U.S. Geological Survey Factsheet 2013-3020, 6p.<http://pubs.usgs.gov/fs/2013/3020/>.

<sup>9</sup> The United States 2012 Carbon Utilization and Storage Atlas, Fourth Edition, U.S Department of Energy, Office of Fossil Energy, National Energy Technology Laboratory (NETL).

**Table 4-8. Total CO<sub>2</sub> Storage Resource, cont.**

State/Province	Million Metric Tons*	
	Low Estimate	High Estimate
MICHIGAN	19,050	47,210
MINNESOTA		
MISSISSIPPI	145,010	1,185,030
MISSOURI	10	170
MONTANA	84,580	912,720
NEBRASKA	23,770	113,240
NEVADA		
New Brunswick		
NEW HAMPSHIRE		
NEW JERSEY	0	0
NEW MEXICO	42,760	359,090
NEW YORK	4,640	4,640
Newfoundland & Labrador		
NORTH CAROLINA	1,340	18,390
NORTH DAKOTA	67,090	147,480
Northwest Territories		
Nova Scotia		
Offshore Federal Only	489,840	6,440,090
OHIO	13,460	13,460
OKLAHOMA	56,950	244,550
Ontario		
OREGON	6,810	93,700
PENNSYLVANIA	22,100	22,100
PUERTO RICO		
Quebec		
RHODE ISLAND		
SASKATCHEWAN	38,690	121,910
SOUTH CAROLINA	30,100	34,180
SOUTH DAKOTA	8,760	24,030
TENNESSEE	430	3,860
TEXAS	443,800	4,329,930
UTAH	25,470	240,910
VERMONT		
VIRGINIA	440	2,910
WASHINGTON	36,620	496,730
WEST VIRGINIA	16,650	16,650
WISCONSIN	0	0
WYOMING	72,690	684,850
<b>North America Total</b>	<b>2,379,840</b>	<b>20,352,700</b>

\*States/Provinces with a “zero” value represent estimates of minimal CO<sub>2</sub> storage resource, while states/provinces with a blank represent areas that have not yet been assessed by the RCSPs

#### **4.6.2 Enhanced Oil and Gas Recovery in the U.S.**

Geologic storage options also include use of CO<sub>2</sub> in enhanced oil recovery. Enhanced recovery (ER), which includes both enhanced oil and gas recovery (EOR and EGR), refers to the injection of fluids into a reservoir to increase oil and/or gas production efficiency. ER is typically conducted at a reservoir after production yields have decreased from primary production. Fluids commonly used for ER include brine, fresh water, steam, nitrogen, alkali solutions, surfactant solutions, polymer solutions, and carbon dioxide. EOR using supercritical carbon dioxide, sometimes referred to as carbon dioxide ‘flooding’ or CO<sub>2</sub>-EOR, involves injecting carbon dioxide into an oil reservoir to help mobilize the remaining oil and make it available for recovery. The crude oil and CO<sub>2</sub> mixture is produced, and sent to a separator where the crude oil is separated from the gaseous hydrocarbons and CO<sub>2</sub>. The gaseous CO<sub>2</sub>-rich stream then is typically dehydrated, purified to remove hydrocarbons, recompressed, and reinjected into the oil or natural gas reservoir to further enhance recovery. The DOE’s Regional Carbon Sequestration Partnerships (RCSPs) have documented the location of more than 225 billion metric tons of CO<sub>2</sub> storage potential in oil and gas reservoirs across over 30 states.<sup>10</sup>

CO<sub>2</sub>-EOR has been successfully used at many production fields throughout the U.S. to increase oil recovery. The oil and natural gas industry in the United States has over 40 years of experience of injection and monitoring of CO<sub>2</sub> in the deep subsurface for the purposes of enhancing oil and natural gas production. This experience provides a strong foundation for the injection and monitoring technologies that will be needed for successful deployment of CCS. Although deep saline formations provide the most CO<sub>2</sub> storage opportunity (2,102 to 20,043 billion metric tons), oil and gas reservoirs are currently estimated to have 226 billion metric tons of CO<sub>2</sub> storage resource.<sup>11</sup> EPA anticipates that many early geologic sequestration (GS) projects may be sited in active or depleted oil and gas reservoirs because these formations have been previously well characterized for hydrocarbon recovery, likely already have suitable infrastructure (e.g., wells, pipelines, etc.), and may be suitable for long term containment of CO<sub>2</sub>.

#### **4.6.3 Trends in CO<sub>2</sub>-EOR**

CO<sub>2</sub>-EOR is the fastest-growing EOR technique in the U.S., providing approximately 281,000 barrels of oil per day in the U.S. which equals about 6% percent of U.S. crude oil production.<sup>12,13</sup>

---

<sup>10</sup> Ibid.

<sup>11</sup> Ibid.

<sup>12</sup> Oil and Gas Journal EOR Survey, April 2010.

<sup>13</sup> Improving Domestic Energy Security and Lowering CO<sub>2</sub> Emissions with “Next Generation” CO<sub>2</sub>-Enhanced Oil Recovery (CO<sub>2</sub>-EOR), DOE/NETL-2011/1504, June 20, 2011.

The vast majority of CO<sub>2</sub>-EOR is conducted in oil reservoirs in the U.S. Permian Basin, which extends through southwest Texas and southeast New Mexico. Other U.S. states where CO<sub>2</sub>-EOR is utilized are Alabama, Colorado, Illinois, Kansas, Louisiana, Michigan, Mississippi, New Mexico, Oklahoma, Utah, and Wyoming. A well-established and expanding network of pipeline infrastructure supports CO<sub>2</sub>-EOR in these areas (Figure 4-8). The CO<sub>2</sub> supply for EOR operations is largely obtained from underground formations or domes that contain CO<sub>2</sub>. While natural sources of CO<sub>2</sub> comprise the majority of CO<sub>2</sub> supplied for EOR operations, recent developments targeting anthropogenic sources of CO<sub>2</sub> (e.g., ethanol plants, gas processing, refineries, power plants) have expanded or led to planned expansions in existing infrastructure related to CO<sub>2</sub>-EOR.<sup>14</sup> Several hundred miles of dedicated CO<sub>2</sub> pipeline is under construction, planned, or proposed that would allow continued growth in CO<sub>2</sub> supply for EOR (see Figure 4-8).

Anthropogenic sources of CO<sub>2</sub> for EOR continue to increase as new projects are being planned or implemented. Based on an evaluation of publicly available sources<sup>15</sup>, there are currently 23 industrial source CCS projects in 12 states that are either operational, under-construction, or actively being pursued which are or will supply captured CO<sub>2</sub> for the purposes of EOR. This demonstrates that CCS projects associated with large point sources are occurring due to a demand for CO<sub>2</sub> by EOR operations. Nationally, according to EPA's Greenhouse Gas Reporting Program, approximately 60 million metric tons of CO<sub>2</sub> was received for injection to enhanced oil recovery operations in 2011. A recent study by DOE found that the market for captured CO<sub>2</sub> emissions from power plants created by economically feasible CO<sub>2</sub>-EOR projects would be sufficient to permanently store the CO<sub>2</sub> emissions from 93 large (1,000 MW) coal-fired power plants operated for 30 years.<sup>16</sup> There are also several state and Federal subsidy programs that are in place that can make CCS more affordable.<sup>17</sup> Based on all of these factors, EPA anticipates opportunities to utilize CO<sub>2</sub>-EOR operations for geologic storage to continue to increase.

Based on a recent resource assessment by DOE, the application of next generation CO<sub>2</sub>-EOR technologies would significantly increase oil production areas, further expanding the geographic extent and accessibility of CO<sub>2</sub>-EOR operations in the U.S.<sup>18</sup> Additionally, oil and gas

---

<sup>14</sup> Ibid.

<sup>15</sup> See technical supporting memo document (Docket EPA-HQ-OAR-2013-0495) Documentation for the Summary of Carbon Dioxide Industrial Capture to Enhanced Oil Recovery Projects.

<sup>16</sup> Improving Domestic Energy Security and Lowering CO<sub>2</sub> Emissions with "Next Generation" CO<sub>2</sub>-Enhanced Oil Recovery (CO<sub>2</sub>-EOR)", DOE/NETL-2011/1504, June 20, 2011.

<sup>17</sup> Report of the Interagency Task Force on Carbon Capture and Storage (August 2010).

<sup>18</sup> Improving Domestic Energy Security and Lowering CO<sub>2</sub> Emissions with "Next Generation" CO<sub>2</sub>-Enhanced Oil Recovery (CO<sub>2</sub>-EOR)", DOE/NETL-2011/1504, June 20, 2011.

fields now considered to be 'depleted' may resume operation because of increased availability and decreased cost of anthropogenic carbon dioxide, thereby increasing the demand for and accessibility of CO<sub>2</sub> utilization.

As demonstrated in this RIA, the use of CO<sub>2</sub> for EOR can significantly lower the cost of implementing CCS. The opportunity to sell the captured CO<sub>2</sub> for EOR, rather than paying directly for its long-term storage, strongly improves the overall economics of the new generating unit. A commercial market for CO<sub>2</sub> creates a role for CO<sub>2</sub>-EOR to continue CCS deployment. According to the International Energy Agency, of the CCS projects under construction or at an advanced stage of planning, 70% intend to use captured CO<sub>2</sub> to improve recovery of oil in mature fields (enhanced oil recovery, CO<sub>2</sub>-EOR).<sup>19</sup> Further, smaller, non-geologic sequestration markets exist for CO<sub>2</sub> as well, including food products, which can lower the cost of CCS.

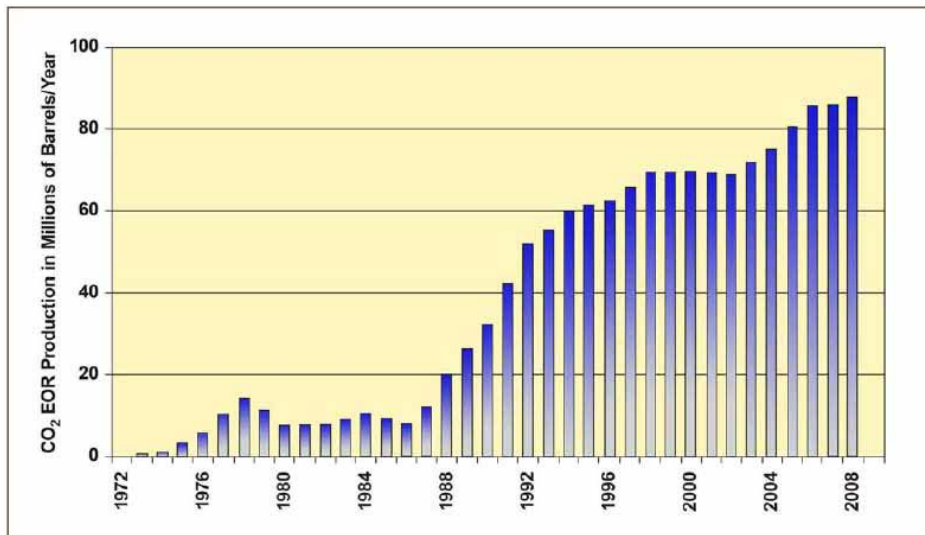

**Figure 4-7. Growth of U.S. Oil Production from CO<sub>2</sub>-based EOR**

Source: NETL 2010

<sup>19</sup> Tracking Clean Energy Progress 2013, International Energy Agency (IEA), Input to the Clean Energy Ministerial, OECD/IEA 2013.

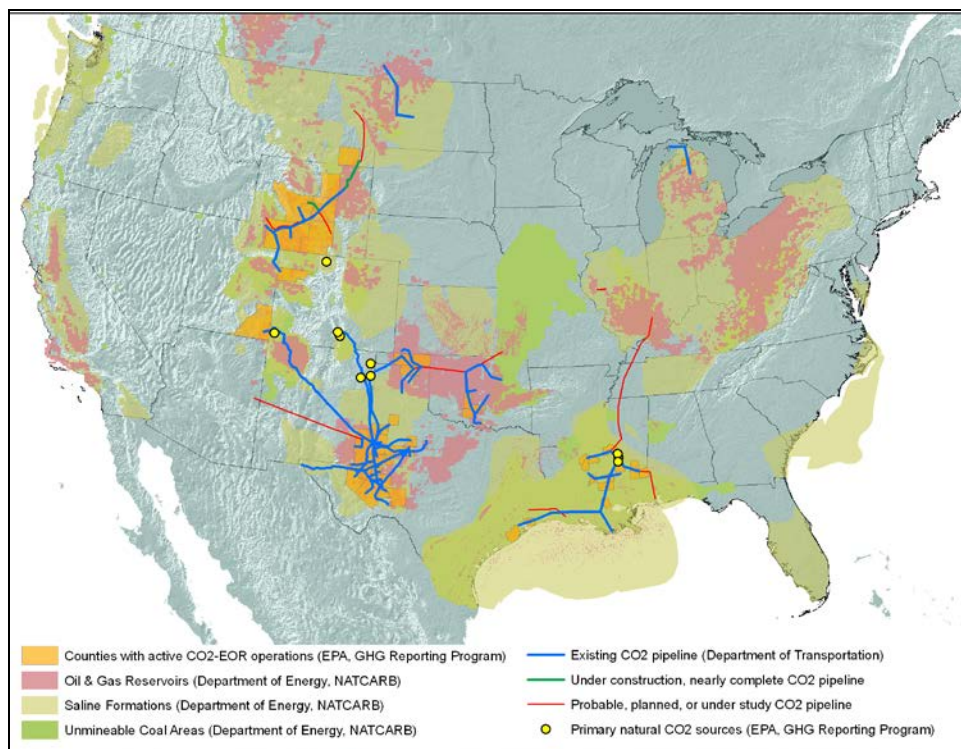

**Figure 4-8. U.S. CO<sub>2</sub> Storage Capacity and CO<sub>2</sub>-EOR operations**

Source: EPA 2013: Data sources: EPA’s Greenhouse Gas Reporting Program; Department of Energy, NATCARB; Department of Transportation, National Pipeline Management System.

#### 4.6.4 Alternatives to Geologic Sequestration

EPA recognizes there may be other commercial applications or end-uses for captured CO<sub>2</sub> which creates CO<sub>2</sub> market incentives and potentially for a meeting performance standard beyond injecting it underground for long-term containment. For example, alternatives to geologic sequestration such as applications such as mineralization of CO<sub>2</sub> for the production of precipitated calcium carbonate and some production process of cement have been identified as potential alternatives to geologic sequestration. The CCS Task Force report notes that there are several factors for determining the viability of CO<sub>2</sub> reuse, and there are currently significant technical barriers to large scale commercial-scale reuse. First, rates of conversion must be comparable to rates of CO<sub>2</sub> capture. Second, energy requirements for conversion must be low. Third, potential volumes of reactants and/or products may limit the scale of reuse relative to total emissions. Finally, reuse options need to consider the long-term fate of CO<sub>2</sub> and its lifecycle emissions.<sup>20</sup> The CCS Task Force also notes there are other potential commercial uses

<sup>20</sup> Report of the Interagency Task Force on Carbon Capture and Storage (August 2010).

for captured CO<sub>2</sub>, such as in food and beverage manufacturing, pulp and paper manufacturing, the rubber and plastic industry, fire suppression, and refrigeration and cooling.

As noted in the preamble, however, EPA has not yet determined if such uses would be applicable towards meeting the standard. Consideration of how these alternatives could meet the performance standard involves understanding the ultimate fate of the captured CO<sub>2</sub> and the degree to which the method permanently isolates the CO<sub>2</sub> from the atmosphere, as well as existing methodologies to verify this permanent storage.

## **4.7 GHG and Clean Energy Regulation in the Power Sector**

### **4.7.1 State Policies**

Several states have also recently established emission performance standards or other measures to limit emissions of GHGs from new EGUs that are comparable to this proposal in this rulemaking.

In 2003, then-Governor George Pataki sent a letter to his counterparts in the Northeast and Mid-Atlantic inviting them to participate in the development of a regional cap-and-trade program addressing power plant CO<sub>2</sub> emissions. This program, known as the Regional Greenhouse Gas Initiative (RGGI), began in 2009 and sets a regional CO<sub>2</sub> cap for participating states. The currently participating states include: Connecticut, Delaware, Maine, Maryland, Massachusetts, New Hampshire, New York, Rhode Island, and Vermont. The cap covers CO<sub>2</sub> emissions from all fossil-fired EGUs greater than 25 MW in participating states, and limits total emissions to 91 million short tons in 2014. This emissions budget is reduced 2.5% annually from 2015 to 2020.

In September 2006, California Governor Schwarzenegger signed into law Senate Bill 1368. The law limits long-term investments in baseload generation by the state's utilities to power plants that meet an emissions performance standard jointly established by the California Energy Commission and the California Public Utilities Commission. The Energy Commission has designed regulations that establish a standard for new and existing baseload generation owned by, or under long-term contract to publicly owned utilities, of 1,100 lb CO<sub>2</sub>/MWh.

In 2006 Governor Schwarzenegger also signed into law Assembly Bill 32, the Global Warming Solutions Act of 2006. This act includes a multi-sector GHG cap-and-trade program which covers approximately 85% of the state GHG emissions. EGUs are included in phase I of the program, which began in 2013. Phase II begins in 2020 and includes upstream sources. The cap is based on a 2 percent reduction from total 2012 expected emissions, and declines 2

percent annually through 2014, then 3 percent each year until 2020.

In May 2007, Washington Governor Gregoire signed Substitute Senate Bill 6001, which established statewide GHG emissions reduction goals, and imposed an emission standard that applies to any baseload electric generation that commenced operation after June 1, 2008 and is located in Washington, whether or not that generation serves load located within the state. Baseload generation facilities must initially comply with an emission limit of 1,100 lb CO<sub>2</sub>/MWh.

In July 2009, Oregon Governor Kulongoski signed Senate Bill 101, which mandated that facilities generating baseload electricity, whether gas- or coal-fired, must have emissions equal to or less than 1,100 lb CO<sub>2</sub>/MWh, and prohibited utilities from entering into long-term purchase agreements for baseload electricity with out-of-state facilities that do not meet that standard. Natural gas- and petroleum distillate-fired facilities that are primarily used to serve peak demand or to integrate energy from renewable resources are specifically exempted from the performance standard.

In August 2011, New York Governor Cuomo signed the Power NY Act of 2011. This regulation establishes CO<sub>2</sub> emission standards for new and modified electric generators greater than 25 MW. The standards vary based on the type of facility: baseload facilities must meet a CO<sub>2</sub> standard of 925 lb/MWh or 120 lb/MMBtu, and peaking facilities must meet a CO<sub>2</sub> standard of 1,450 lbs/MWh or 160 lbs/MMBtu.

Additionally, most states have implemented Renewable Portfolio Standards (RPS), or Renewable Electricity Standards (RES). These programs are designed to increase the renewable share of a state's total electricity generation. Currently 30 states and the District of Columbia have enforceable RPS or other mandatory renewable capacity policies, and 7 states have voluntary goals.<sup>21</sup> These programs vary widely in structure, enforcement, and scope.

#### **4.7.2 Federal Policies**

In April 2007, the Supreme Court concluded that GHGs met the CAA definition of an air pollutant, giving the EPA the authority to regulate GHGs under the CAA contingent upon an agency determination that GHG emissions from new motor vehicles cause or contribute to air pollution that may reasonably be anticipated to endanger public health or welfare. This decision to regulate GHG emissions for motor vehicles set the stage for the determination of whether other sources of GHG emissions, including stationary sources, would need to be regulated as well.

---

<sup>21</sup> EIA 2012a



In response to the FY2008 Consolidated Appropriations Act (H.R. 2764; Public Law 110–161), the EPA issued the Mandatory Reporting of Greenhouse Gases Rule (74 FR 5620) which required reporting of GHG data and other relevant information from fossil fuel suppliers and industrial gas suppliers, direct greenhouse gas emitters, and manufacturers of heavy-duty and off-road vehicles and engines. The purpose of the rule was to collect accurate and timely GHG data to inform future policy decisions. As such, it did not require that sources control greenhouse gases, but sources above certain threshold levels must monitor and report emissions.

In August 2007, the EPA issued a prevention of significant deterioration (PSD) permit to Deseret Power Electric Cooperative, authorizing it to construct a new waste-coal-fired EGU near its existing Bonanza Power Plant, in Bonanza, Utah. The permit did not include emissions control requirements for CO<sub>2</sub>. The EPA acknowledged the Supreme Court decision, but found that decision alone did not require PSD permits to include limits on CO<sub>2</sub> emissions. Sierra Club challenged the Deseret permit. In November 2008, the Environmental Appeals Board (EAB) remanded the permit to the EPA to reconsider “whether or not to impose a CO<sub>2</sub> BACT (best available control technology) limit in light of the ‘subject to regulation’ definition under the CAA.” The remand was based in part on EAB’s finding that there was not an established EPA interpretation of the regulatory phrase “subject to regulation.”

In December 2008, the Administrator issued a memo indicating that the PSD Permitting Program would apply to pollutants that are subject to either a provision in the CAA or a regulation adopted by the EPA under the CAA that requires actual control of emissions of that pollutant. The memo further explained that pollutants for which the EPA regulations only require monitoring or reporting, such as the provisions for CO<sub>2</sub> in the Acid Rain Program, are not subject to PSD permitting. Fifteen organizations petitioned the EPA for reconsideration, prompting the agency to issue a revised finding in March 2009. After reviewing comments, the EPA affirmed the position that PSD permitting is not triggered for a pollutant such as GHGs until a final nationwide rule requires actual control of emissions of the pollutant. For GHGs, this meant January 2011 when the first national rule limiting GHG emissions for cars and light trucks was scheduled to take effect. Therefore, a permit issued after January 2, 2011, would have to address GHG emissions.

The Administrator signed two distinct findings in December 2009 regarding greenhouse gases under section 202(a) of the Clean Air Act. The endangerment finding indicated that current and projected concentrations of the six key well-mixed greenhouse gases —CO<sub>2</sub>, CH<sub>4</sub>, N<sub>2</sub>O, hydrofluorocarbons (HFCs), perfluorocarbons (PFCs), and SF<sub>6</sub> — in the atmosphere

threaten the public health and welfare of current and future generations. These greenhouse gases have long lifetimes and, as a result, become homogeneously distributed through the lower level of the Earth's atmosphere (IPCC, 2001). This differentiates them from other greenhouse gases that are not homogeneously distributed in the atmosphere. The cause and contribute finding indicated that the combined emissions of these well-mixed greenhouse gases from new motor vehicles and new motor vehicle engines contribute to the greenhouse gas pollution which threatens public health and welfare. Both findings were published in the Federal Register on December 15, 2009 (Docket ID EPA-HQ-OAR-2009-0171). These findings did not themselves impose any requirements on any industry or other entities, but allowed the EPA to regulate greenhouse gases under the CAA (see preamble section II.E for regulatory background). This action was a prerequisite to implementing the EPA's proposed greenhouse gas emission standards for light-duty vehicles, which was finalized in January 2010. Once a pollutant is regulated under the CAA, it is subject to permitting requirements under the PSD and Title V programs. The 2009 Endangerment Finding and a denial of reconsideration were challenged in a lawsuit; on June 26, 2012, the DC Circuit Court upheld the Endangerment Finding and the Reconsideration Denial, ruling that the Finding was neither arbitrary nor capricious, was consistent with *Massachusetts v. EPA*, and was adequately supported by the administrative record. The Court found that the EPA had based its decision on "substantial scientific evidence," noted that the EPA's reliance on assessments was consistent with the methods decision-makers often use to make a science-based judgment, and stated that "EPA's interpretation of the governing CAA provisions is unambiguously correct."

In May 2010, the EPA issued the final Tailoring Rule which set thresholds for GHG emissions that define when permits under the New Source Review and Title V Operating Permit programs are required for new and existing industrial facilities. Facilities responsible for nearly 70 percent of the national GHG emissions from stationary sources, including EGUs, were subject to permitting requirements under the rule. This rule was upheld by the D.C. Circuit in 2012.

The EPA entered into two proposed settlement agreements in December 2010 to issue rules that will address greenhouse gas emissions from fossil fuel-fired power plants and refineries. These two industrial sectors make up nearly 40 percent of the nation's greenhouse gas emissions. On March 27, 2012, EPA proposed NSPS for new source natural gas, coal, and other solid fossil-fired EGUs. After consideration of information provided in more than 2.7 million comments on this proposal, as well as consideration of continuing changes in the electricity sector, the EPA determined that revisions in its proposed approach are warranted.

This rule replaces that proposal. Existing source standards are not addressed in this action. Details of the settlement agreements can be found on the EPA website.<sup>22</sup>

#### **4.7.3 Proposed Federal Policies, Non-GHG**

EPA is reviewing public comment and developing final regulations for the following three proposed rules, which will impact EGUs: Steam Electric Effluent Limitation Guidelines, Cooling Water Intake Structures, and Coal Combustion Residuals (CCR). These three proposed rules are summarized below. In general, most EPA rulemakings affecting the power sector focus on existing sources. Therefore, few interactions are likely between other power sector rules and this rule, which focuses only on new sources.

On June 7, 2013, EPA proposed a regulation that would strengthen the controls on discharges from certain steam electric power plants by revising technology-based effluent limitations guidelines and standards for the steam electric power generating point source category. Existing steam electric power plants contribute 50-60 percent of all toxic pollutants discharged to surface waters by all industrial categories currently regulated in the United States under the Clean Water Act. Furthermore, power plant discharges to surface waters are expected to increase as pollutants are increasingly captured by air pollution controls and transferred to wastewater discharges. This proposal would reduce the amount of toxic metals and other pollutants discharged to surface waters from power plants. EPA has proposed new requirements for both existing and new generating units. EPA estimates that the compliance costs for a new unit (capital and operations & maintenance) under the proposed standards represent at most 1.5 percent of the annualized cost of building and operating a new 1,300 MW coal-fired plant, with capital costs representing less than 1 percent of the overnight construction costs, and annual O&M costs representing less than 5 percent of the cost of operating a new plant.

Section 316(b) of the CWA, 33 U.S.C. 1326(b), requires that standards applicable to point sources under sections 301 and 306 of the Act require that the location, design, construction, and capacity of cooling water intake structures reflect the best technology available to minimize adverse environmental impacts. In April 2011, EPA proposed new standards to reduce injury and death of fish and other aquatic life caused by cooling water intake structures at existing power plants and manufacturing facilities. The proposed rule would subject existing power plants and manufacturing facilities withdrawing in excess of 2 million of gallons per day (MGD) of cooling water to an upper limit on the number of fish destroyed

---

<sup>22</sup> <http://www.epa.gov/airquality/ghgsettlement.html>

through impingement, as well as site-specific entrainment mortality standards. Certain plants that withdraw very large volumes of water would also be required to conduct studies for use by the permit writer in determining site-specific entrainment controls for such facilities. Finally, under the proposed rule, new generating units constructed at existing power plants would be required to reduce the intake of cooling water associated with the new unit, to a level that could be attained by using a closed-cycle cooling system. EPA is continuing the process of addressing comments and finalizing the rule.

On June 21, 2010, EPA co-proposed regulations that included two approaches to regulating the disposal of CCRs generated by electric utilities and independent power producers. CCRs are residues from the combustion of coal in steam electric power plants and include materials such as coal ash (fly ash and bottom ash) and flue gas desulfurization (FGD) wastes. Under one proposed approach, EPA would list these residuals as "special wastes," when destined for disposal in landfills or surface impoundments, and would apply the existing regulatory requirements established under Subtitle C of RCRA to such wastes. Under the second proposed approach, EPA would establish new regulations applicable specifically to CCRs under subtitle D of RCRA, the section of the statute applicable to solid (i.e., non-hazardous) wastes. Under both approaches, CCRs that are beneficially used would remain exempt under the Bevill exclusion. While the Agency is still evaluating all the available information and comments, and while a final risk assessment for the CCR rule has not yet been completed, reliance on the data and analyses discussed in the preamble to the recent Steam Electric ELG proposal may have the potential to lower the CCR rule risk assessment results by as much as an order of magnitude. If this proves to be the case, EPA's current thinking is that, the revised risks, coupled with the ELG requirements that the Agency may promulgate, and the increased Federal oversight such requirements could achieve, could provide strong support for a conclusion that regulation of CCR disposal under RCRA Subtitle D would be adequate.

#### **4.8 Revenues, Expenses, and Prices**

Due to lower retail electricity sales, total utility operating revenues declined in 2011 to \$281 billion from a peak of almost \$300 billion in 2008. Despite revenues not returning to 2008 levels in 2011, operating expenses were appreciably lower and as a result, net income also rose in comparison to both 2009 and 2010 (see Table 4-9). Recent economic events have put downward pressure on electricity demand, thus dampening electricity prices and consumption (utility revenues), but have also reduced the price and cost of fossil fuels and other expenses. Electricity sales and revenues associated with the generation, transmission, and distribution of

electricity are expected to rebound and increase modestly by 2015, when revenues are projected to be roughly \$359 billion (see Table 4-10).

Table 4-9 shows that investor-owned utilities (IOUs) earned income of about 11.9 percent compared to total revenues in 2011. Based on EIA's Annual Energy Outlook 2013, Table 4-10 shows that the power sector is projected to derive revenues of \$359 billion in 2015. Assuming the same income ratio from IOUs (with no income kept by public power), and using the same proportion of power sales from public power as observed in 2011, the EPA projects that the power sector will expend over \$320 billion in 2015 to generate, transmit, and distribute electricity to end-use consumers.

Over the past 50 years, real retail electricity prices have ranged from around 7 cents per kWh in the early 1970s, to around 11 cents, reached in the early 1980s. Generally, retail electricity prices do not change rapidly and do not display the variability of other energy or commodity prices, although the frequency at which these prices change varies across different types of customers. Retail rate regulation has largely insulated consumers from the rising and falling wholesale electricity price signals whose variation in the marketplace on an hourly, daily, and seasonal basis is critical for driving lowest-cost matching of supply and demand. In fact, the real price of electricity today is lower than it was in the early 1960s and 1980s (see Figure 4-9).

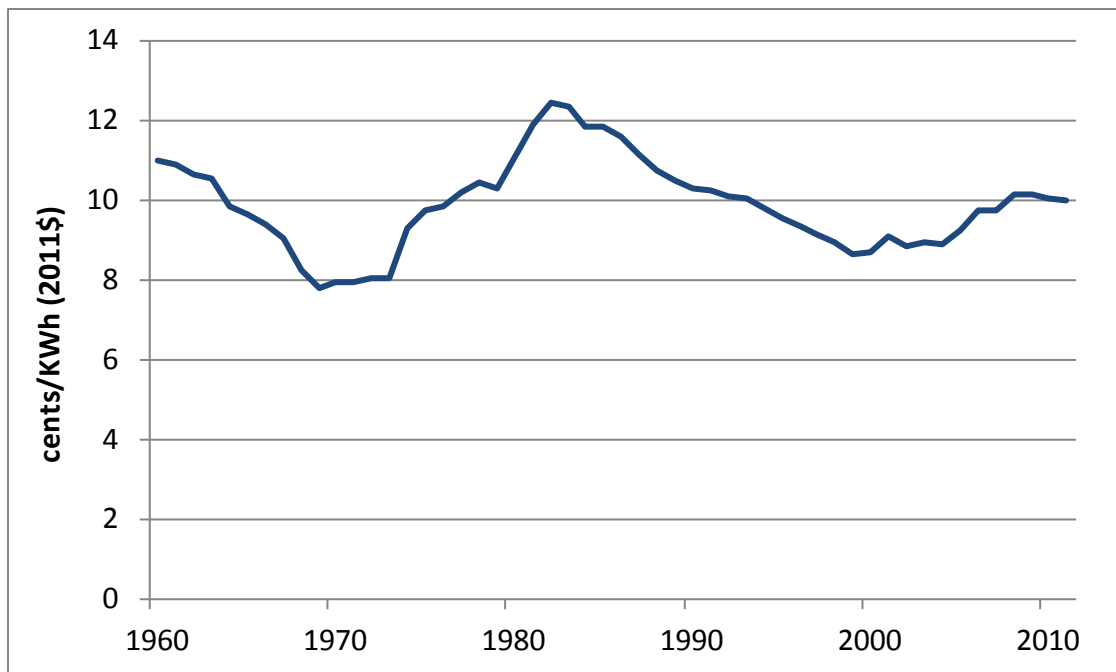

**Figure 4-9. National Average Retail Electricity Price (1960 – 2011)**

Source: EIA 2013

**Table 4-9. Revenue and Expense Statistics for Major U.S. Investor-Owned Electric Utilities for 2010 (\$millions)**

	2009	2010	2011
<b>Utility Operating Revenues</b>	<b>276,124</b>	<b>285,512</b>	<b>280,520</b>
Electric Utility	249,303	260,119	255,573
Other Utility	26,822	25,393	24,946
<b>Utility Operating Expenses</b>	<b>244,243</b>	<b>253,022</b>	<b>247,118</b>
Electric Utility	219,544	234,173	228,873
Operation	154,925	166,922	161,460
Production	118,816	128,831	122,520
Cost of Fuel	40,242	44,138	42,779
Purchased Power	67,630	67,284	61,447
Other	10,970	17,409	18,294
Transmission	6,742	6,948	6,876
Distribution	3,947	4,007	4,044
Customer Accounts	5,203	5,091	5,180
Customer Service	3,857	4,741	5,311
Sales	178	185	185
Admin. and General	15,991	17,120	17,343
Maintenance	14,092	14,957	15,772
Depreciation	20,095	20,951	22,555
Taxes and Other	29,081	31,343	29,086
Other Utility	24,698	18,849	18,245
<b>Net Utility Operating Income</b>	<b>31,881</b>	<b>32,490</b>	<b>33,402</b>

Source: Table 8.3, EIA Electric Power Annual, 2011

Note: This data does not include information for public utilities.

**Table 4-10. Projected Revenues by Service Category in 2015 for Public Power and Investor-Owned Utilities (billions)**

Generation	\$207
Transmission	\$40
Distribution	\$111
<b>Total</b>	<b>\$359</b>

Source: EIA 2013

Note: Data are derived by taking either total electricity use (for generation) or sales (transmission and distribution) and multiplying by forecasted prices by service category from Table 8 of EIA AEO 2013 (Electricity Supply, Disposition, Prices, and Emissions).

On a state-by-state basis, retail electricity prices vary considerably. The Northeast and California have average retail prices that can be as much as double those of other states (see Figure 4-10).

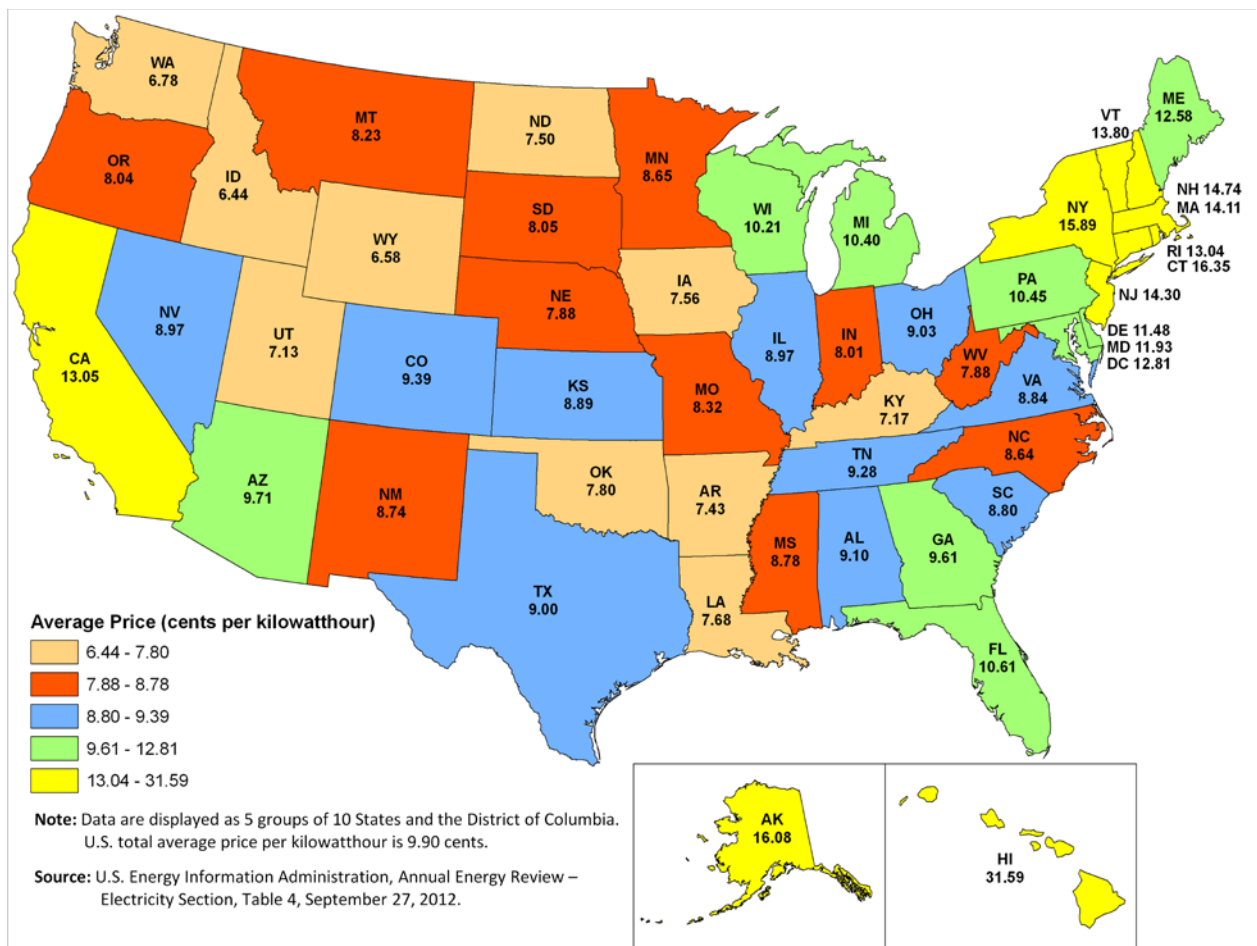

**Figure 4-10. Average Retail Electricity Price by State (cents/kWh), 2011**

Source: EIA 2012

#### 4.9 Natural Gas Market

The natural gas market in the United States has historically experienced significant price volatility from year to year, between seasons within a year, and can undergo major price swings during short-lived weather events (such as cold snaps leading to short-run spikes in heating demand). Over the last decade, gas prices (both Henry Hub prices and delivered prices to the power sector) have ranged from below \$3 to nearly \$10/mmBtu on an annual average basis (see Figure 4-11). During that time, the daily price of natural gas reached as high as \$15/mmBtu. Recent forecasts of natural gas availability have also experienced considerable revision as new sources of gas have been discovered and have come to market, although there continues to be some uncertainty surrounding the precise quantity of the resource base.

Current and projected natural gas prices are considerably lower than the prices observed over the past decade, largely due to advances in hydraulic fracturing and horizontal drilling techniques that have opened up new shale gas resources and substantially increased the supply of economically recoverable natural gas. According to AEO 2012 (EIA 2012):

Shale gas refers to natural gas that is trapped within shale formations. Shales are fine-grained sedimentary rocks that can be rich sources of petroleum and natural gas. Over the past decade, the combination of horizontal drilling and hydraulic fracturing has allowed access to large volumes of shale gas that were previously uneconomical to produce. The production of natural gas from shale formations has rejuvenated the natural gas industry in the United States.

The U.S. Energy Information Administration's Annual Energy Outlook 2012 (Early Release) estimates that the United States possessed 2,214 trillion cubic feet (Tcf) of technically recoverable natural gas resources as of January 1, 2010. Natural gas from proven and unproven shale resources accounts for 542 Tcf of this resource estimate. Many shale formations, especially the Marcellus, are so large that only small portions of the entire formations have been intensively production-tested. Consequently, the estimate of technically recoverable resources is highly uncertain, and is regularly updated as more information is gained through drilling and production. At the 2010 rate of U.S. consumption (about 24.1 Tcf per year), 2,214 Tcf of natural gas is enough to supply over 90 years of use. Although the estimate of the shale gas resource base is lower than in the prior edition of the Outlook, shale gas production estimates increased between the 2011 and 2012 Outlooks, driven by lower drilling costs and continued



drilling in shale plays with high concentrations of natural gas liquids and crude oil, which have a higher value in energy equivalent terms than dry natural gas.<sup>23</sup>

EIA's projections of natural gas conditions did not change substantially in AEO 2013 from the AEO 2012, and EIA is still forecasting abundant reserves consistent with the above findings. Recent historical data reported to EIA is also consistent with these trends, with 2012 being the highest year on record for domestic natural gas production.<sup>24</sup> The average delivered natural gas price to the power sector was \$3.44 per MMBtu in 2012, down from \$4.78/MMBtu in 2011.<sup>25</sup>

EIA projections of future natural gas prices assume trends that are consistent with historical and current market behavior, technological and demographic changes, and current laws and regulations.<sup>26</sup> Depending on actual conditions, there may be significant variation from the price projected in the reference case and the price observed. To address this uncertainty, EIA issues a range of alternative cases, including cases with higher and lower economic growth, which address many of the uncertainties inherent in the long-term projections. The EPA describes the AEO 2013 reference case and a number of relevant alternative cases in the analyses in Chapter 5.

---

<sup>23</sup> For more information, see: [http://www.eia.gov/forecasts/archive/aeo11/IF\\_all.cfm#prospectshale](http://www.eia.gov/forecasts/archive/aeo11/IF_all.cfm#prospectshale);  
[http://www.eia.gov/energy\\_in\\_brief/about\\_shale\\_gas.cfm](http://www.eia.gov/energy_in_brief/about_shale_gas.cfm)

<sup>24</sup> <http://www.eia.gov/dnav/ng/hist/n9010us2a.htm>

<sup>25</sup> <http://www.eia.gov/dnav/ng/hist/n3045us3A.htm>; Assumes that 1 TCF = 1.023 MMBtu natural gas  
(<http://www.eia.gov/tools/faqs/faq.cfm?id=45&t=8>)

<sup>26</sup> EIA 2010b.

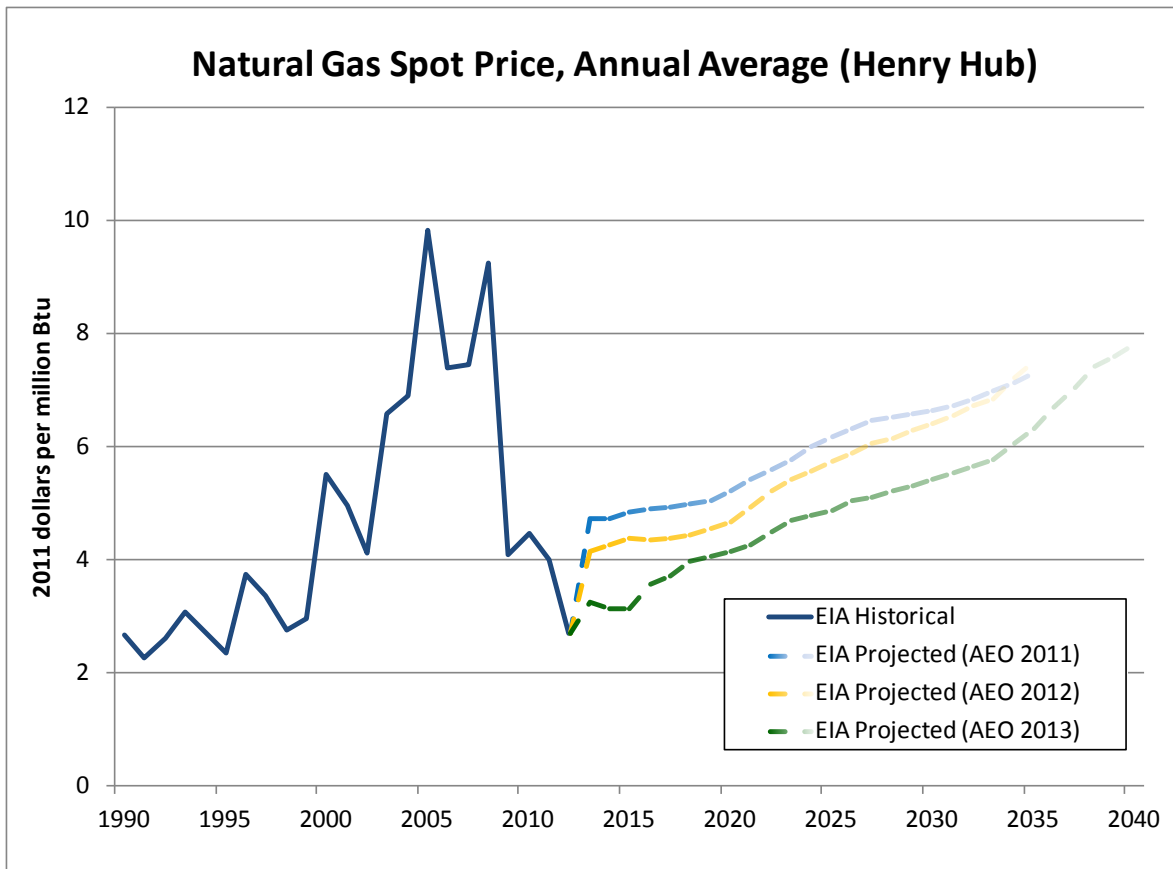

**Figure 4-11. Natural Gas Spot Price, Annual Average (Henry Hub)**

Source: EIA 2010c, EIA 2011, EIA 2012, EIA 2013

#### 4.10 Electricity Demand and Demand Response

Electricity performs a vital and high-value function in the economy. Historically, growth in electricity consumption has been closely aligned with economic growth. Overall, the U.S. economy has become more efficient over time, producing more output (gross domestic product – GDP) per unit of energy input, with per capita energy use fairly constant over the past 30 years (EIA, 2010d). The growth rate of electricity demanded has also been in overall decline for the past sixty years (see Figure 4-12), with several key drivers that are worth noting. First, there has been a significant structural shift in the U.S. economy towards less energy-intensive sectors, like services.<sup>27</sup> Second, companies have strong financial incentives to reduce expenditures, including those for energy. Third, companies are responding to the marketplace and continually develop and bring to market new technologies that reduce energy

<sup>27</sup> EIA 2013

consumption. Fourth, other policies, such as energy efficiency standards at the state and Federal level, have helped address certain market failures. These broader changes have altered the outlook for future electricity growth (see Figure 4-10).

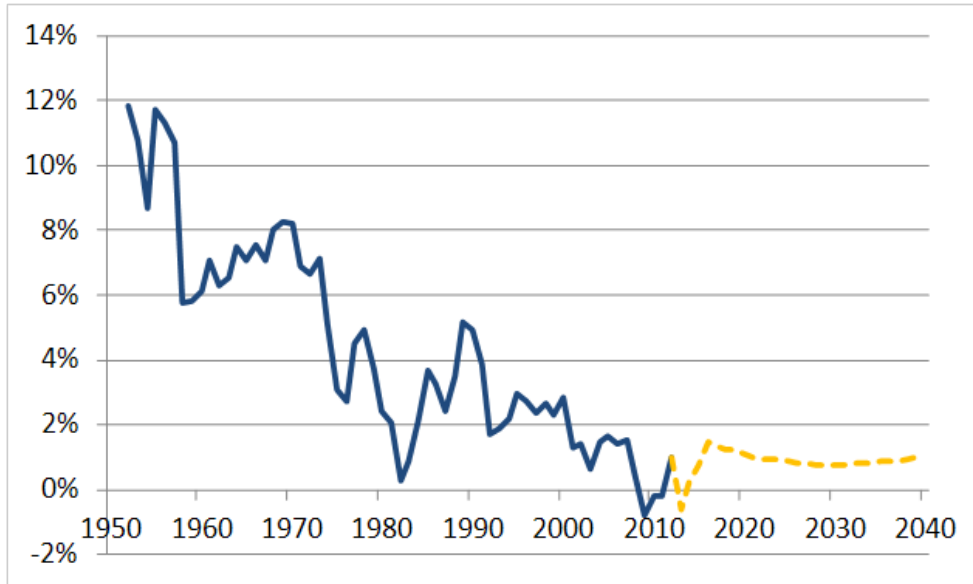

**Figure 4-7. Electricity Growth Rate (3-Year Rolling Average) and Projections from the Annual Energy Outlook 2013**

Source: EIA 2009, EIA 2013

Energy efficiency initiatives have become more common, and investments in energy efficiency are projected to continue to increase for the next 5 to 10 years, driven in part by the growing number of states that have adopted energy efficiency resource standards. These investments, and other energy efficiency policies at both the state and federal level, create incentives to reduce electricity consumption and peak load. According to EIA, demand-side management provided actual peak load reductions of 33.3 GW in 2010. For context, the current coal fleet is roughly 314 GW of capacity.

Demand for electricity, especially in the short run, is not very sensitive to changes in prices and is considered relatively price inelastic, although some demand reduction does occur in response to price. With that in mind, the EPA modeling does not typically incorporate a “demand response” in its electric generation modeling (Chapter 5) to the increases in electricity prices typically projected for EPA rulemakings. Electricity demand is considered to be constant in EPA modeling applications and the reduction in production costs that would result from lower demand is not considered in the primary analytical scenario that is modeled. This leads to some overstatement in the private compliance costs that the EPA estimates for rules where

compliance costs are anticipated for a rulemaking. Note that this NSPS is not anticipated to create compliance costs for projected new EGU sources.

#### 4.11 References

Brennan, S.T., Burruss, R.C., Merrill, M.D., Freeman, P.A., and Ruppert, L.F. *A probabilistic assessment methodology for the evaluation of geologic carbon dioxide storage: U.S. Geological Survey Open-File Report 2010–1127*. 2010. Available online at <http://pubs.usgs.gov/of/2010/1127>.

Interagency Task Force on Carbon Capture and Storage. *Report of the Interagency Task Force on Carbon Capture and Storage*. August 2010. Available online at: <http://www.epa.gov/climatechange/downloads/CCS-Task-Force-Report-2010.pdf>.

Intergovernmental Panel on Climate Change. *Climate Change 2001: The Scientific Basis*. 2001. Available online at: [http://www.grida.no/publications/other/ipcc\\_tar/?src=/climate/ipcc\\_tar/wg1/218.htm](http://www.grida.no/publications/other/ipcc_tar/?src=/climate/ipcc_tar/wg1/218.htm).

International Energy Agency (IEA). *Tracking Clean Energy Progress 2013*. Input to the Clean Energy Ministerial. 2013. Available online at: <http://www.iea.org/etp/tracking/>.

National Energy Technology Laboratory (NETL). *Reducing CO<sub>2</sub> Emissions by Improving the Efficiency of Existing Coal-fired Power Plant Fleet*. July 2008. Available online at: <http://www.netl.doe.gov/energy-analyses/pubs/CFPP%20Efficiency-FINAL.pdf>.

National Energy Technology Laboratory (NETL). *Improving Domestic Energy Security and Lowering CO<sub>2</sub> Emissions with “Next Generation” CO<sub>2</sub>-Enhanced Oil Recovery (CO<sub>2</sub>-EOR)*. June 20, 2011. DOE/NETL-2011/1504. Available online at: <http://www.netl.doe.gov/energy-analyses/refshelf/PubDetails.aspx?Action=View&PubId=391>.

National Energy Technology Laboratory (NETL). *The United States 2012 Carbon Utilization and Storage Atlas, Fourth Edition*. 2012. Available online at: [http://www.netl.doe.gov/technologies/carbon\\_seq/refshelf/atlasIV/](http://www.netl.doe.gov/technologies/carbon_seq/refshelf/atlasIV/).

National Energy Technology Laboratory (NETL). *Energy Analyses: Cost and Performance Baselines for Fossil Energy Plants*. 2013. Available online at: [http://www.netl.doe.gov/energy-analyses/baseline\\_studies.html](http://www.netl.doe.gov/energy-analyses/baseline_studies.html).

Oil and Gas Journal. *Enhanced Oil Recovery Survey*. 2010. Volume 108, Issue 14, April 19, 2010. p.41.

Pacific Northwest National Laboratory (PNNL). *An Assessment of the Commercial Availability of Carbon Dioxide Capture and Storage Technologies as of June 2009*. June 2009. Available online at: [http://www.pnl.gov/science/pdf/PNNL-18520\\_Status\\_of\\_CCS\\_062009.pdf](http://www.pnl.gov/science/pdf/PNNL-18520_Status_of_CCS_062009.pdf).

- U.S. Energy Information Administration (U.S. EIA). *Carbon Dioxide Emissions from the Generation of Electric Power in the United States*. July 2000. Available online at: <ftp://ftp.eia.doe.gov/environment/co2emiss00.pdf>.
- U.S. Energy Information Administration (U.S. EIA). *Electric Power Annual 2003*. 2003. Available online at: <http://www.eia.gov/electricity/annual/archive/03482003.pdf>.
- U.S. Energy Information Administration (U.S. EIA). *Electric Power Annual 2009*. 2009. Available online at: <http://www.eia.gov/electricity/annual/archive/03482009.pdf>.
- U.S. Energy Information Administration (U.S. EIA). *Electric Power Annual 2011*. 2013. Available online at: <http://www.eia.gov/electricity/annual/>.
- U.S. Energy Information Administration (U.S. EIA). "Status of Electricity Restructuring by State." 2010a. Available online at: [http://www.eia.gov/cneaf/electricity/page/restructuring/restructure\\_elect.html](http://www.eia.gov/cneaf/electricity/page/restructuring/restructure_elect.html).
- U.S. Energy Information Administration (U.S. EIA). *AEO 2010 Retrospective Review*. 2010b. Available online at: <http://www.eia.gov/forecasts/aeo/retrospective/>.
- U.S. Energy Information Administration (U.S. EIA). *Annual Energy Outlook 2010*. 2010c. Available online at: <http://www.eia.gov/oaia/archive/aeo10/index.html>.
- U.S. Energy Information Administration (U.S. EIA). *Annual Energy Review 2010*. 2010d. Available online at: <http://www.eia.gov/totalenergy/data/annual/pdf/aer.pdf>.
- U.S. Energy Information Administration (U.S. EIA). *Annual Energy Outlook 2011*. 2011. Available online at: <http://www.eia.gov/forecasts/archive/aeo11/>.
- U.S. Energy Information Administration (U.S. EIA). *Annual Energy Outlook 2012 (Early Release)*. 2012. Available online at: <http://www.eia.gov/forecasts/aeo/>.
- U.S. Energy Information Administration (U.S. EIA). *Today in Energy: s Most states have Renewable Portfolio Standards*. 2012a. Available online at: <http://www.eia.gov/todayinenergy/detail.cfm?id=4850>.
- U.S. Energy Information Administration (U.S. EIA). *Annual Energy Outlook 2013*. 2013. Available online at: <http://www.eia.gov/forecasts/aeo/>.
- U.S. Environmental Protection Agency (U.S. EPA). *Inventory of U.S. Greenhouse Gas Emissions and Sinks: 1990–2011*. April 2013. Available online at: <http://www.epa.gov/climatechange/Downloads/ghgemissions/US-GHG-Inventory-2013-Main-Text.pdf>.

U.S. Geological Survey Geologic (USGS) *National assessment of geologic carbon dioxide storage resources – Summary: U.S. Geological Survey Factsheet 2013-3020*. 2013. Available online at: <http://pubs.usgs.gov/fs/2013/3020/>.

## CHAPTER 5 COSTS, BENEFITS, ECONOMIC, AND ENERGY IMPACTS

### 5.1 Synopsis

This chapter reports the compliance cost, benefits, economic, and energy impact analyses performed for the proposed EGU New Source GHG Standards. EPA analyzed and assessed a wide range of potential scenarios and outcomes, using a detailed power sector model, other government projections for the power sector, and additional economic assessments and analysis to determine the potential impacts of this action.

The primary finding of this assessment is that in the absence of this proposed rule, all projected unplanned<sup>1</sup> capacity additions affected by this proposal during the analysis period would already be compliant with the rule's requirements (e.g., combined cycle natural gas, low capacity factor natural gas combustion turbine, and small amounts of coal with CCS supported by Federal and State funding). The analysis period is defined as through 2022<sup>2</sup> to reflect that CAA Section 111(b) requires that the NSPS be reviewed every eight years. EPA's conclusion was based on:

- EIA power sector modeling projections
- EPA power sector modeling projections
- Electric utility integrated resource planning (IRP) documents
- Projected new EGUs reported by industry to EIA

EPA's finding of no new, unplanned conventional coal-fired capacity is robust beyond the analysis period (past 2030 in both EIA and EPA baseline modeling projections) and across a wide range of alternative potential market, technical, and regulatory scenarios that influence power sector investment decisions. As a result, the proposed EGU New Source GHG Standards are not expected to change GHG emissions for newly constructed EGUs, and are anticipated to yield no monetized benefits and impose negligible costs, economic impacts, or energy impacts on the electricity sector or society. While EPA does not project any new coal-fired EGUs without CCS to be built in the absence of this proposal, this chapter presents an analysis of the project-level costs of building new coal-fired capacity with and without CCS to demonstrate

---

<sup>1</sup> Unplanned capacity represents projected capacity additions that are not under construction.

<sup>2</sup> IPM output for other years has been made available in the docket and is discussed where appropriate throughout the document.

that a requirement of partial CCS would not preclude new coal construction. An additional illustrative analysis, presented at the end of this chapter, shows that even in the unlikely event that new, noncompliant EGU capacity would be built in the absence of this rule the proposed EGU New Source GHG Standards would provide net social benefits under a range of assumptions.

## **5.2 Requirements of the Proposed GHG EGU NSPS**

In this action, the EPA is proposing standards of performance for two basic categories of new units that have not commenced construction: (i) fossil fuel-fired electric utility steam generating units (boilers and IGCC units); and (ii) natural gas-fired stationary combustion turbines that generate electricity for sale and meet certain size and operational criteria.

The EPA is proposing standards of performance for affected sources within the following subcategories: (1) natural gas-fired stationary combustion turbines with a heat input rating to the turbine engine that is greater than 850 MMBtu/hr; (2) natural gas-fired stationary combustion turbines with a heat input rating to the turbine engine that is less than or equal to 850 MMBtu/hr; and (3) all fossil fuel-fired boilers and IGCC units. All affected new fossil fuel-fired EGUs would be required to meet an output-based emission rate of a specific mass of CO<sub>2</sub> per MWh of electricity generated energy output on a gross basis. New natural gas-fired stationary combustion turbines with a heat input rating greater than 850 MMBtu/hr would be required to meet a standard of 1,000 lb CO<sub>2</sub>/MWh of gross energy output. New natural gas-fired stationary combustion turbines with a heat input rating less than or equal to 850 MMBtu/hr would be required to meet a standard of 1,100 lb CO<sub>2</sub>/MWh of gross energy output. New fossil fuel-fired boilers and IGCC units would be required to meet a standard of 1,100 lb CO<sub>2</sub>/MWh of gross energy output. These standards would be met on a 12-operating month rolling average basis. An alternative emission limit, available only to new fossil-fired boilers and IGCC units, can be met over an 84-operating month rolling average basis. The alternative emission limit will be between 1,000 and 1,050 lb CO<sub>2</sub>/MWh of gross energy output.

The proposed action applies to sources based on electric sales. More specifically, a facility is covered if it sells more than 1/3 of its potential electric output and more than 219,000 MWh net electric output to the grid. The proposed definition does not explicitly exclude simple cycle combustion turbines, but as a practical matter, it is generally expected not to apply as most simple cycle combustion turbines sell less than 1/3 of their potential electric output. For potential combustion turbines that anticipate selling more than 1/3 of their potential electric output, there are more cost effective and lower emitting technologies that could be constructed consistent with the proposed standards as will be demonstrated later in this



chapter. Please refer to the preamble for additional detail concerning affected sources and standards of performance.

### **5.3 Power Sector Modeling Framework**

#### **5.3.1 Modeling Overview**

Over the last decade, EPA has conducted extensive analyses of regulatory actions impacting the power sector. These efforts support the Agency's understanding of key policy variables and provide the framework for how the Agency estimates the costs and benefits associated with its actions. Current forecasts for the utilization of new and existing generating capacity are a key input into informing the design of EPA's proposal. Given excess capacity within the existing fleet and relatively low forecasts of electricity demand growth, there is limited new capacity - of any type - expected to be constructed over the next decade. A small number of new coal-fired power plants have been built in recent years; however, EPA does not expect the construction of any new, unplanned, conventional coal-fired capacity through the analysis period. This conclusion is based in part on the Agency's own power sector modeling utilizing IPM as well as EIA's Annual Energy Outlook 2013 (AEO 2013) projections.

IPM, developed by ICF Consulting, is a state-of-the-art, peer reviewed, dynamic linear programming model that can be used to project power sector behavior under future business as usual conditions and examine prospective air pollution control policies throughout the United States for the entire electric power system. EPA used IPM to project likely future electricity market conditions with and without the proposed rule. In addition to IPM, EPA has closely examined the AEO 2013 from the EIA.

To produce the AEO, EIA employs the National Energy Modeling System (NEMS), an energy-economy modeling system of the United States. According to EIA:<sup>3</sup>

“NEMS projects the production, imports, conversion, consumption, and prices of energy, subject to assumptions on macroeconomic and financial factors, world energy markets, resource availability and costs, behavioral and technological choice criteria, cost and performance characteristics of energy technologies, and demographics.”

The Electricity Market Module of NEMS produces projections of power sector behavior that minimize the cost of meeting electricity demand subject to the sector's inherent constraints, including the availability of existing generation capacity, transmission capacity and

---

<sup>3</sup> <http://www.eia.gov/oiaf/aeo/overview/>

cost, cost of utility and nonutility technologies, expected load shapes, fuel markets, regulations, and other factors. EIA's AEO projections independently support EPA's conclusions in that it projects no new generation capacity being constructed through the analysis period that would not already meet the level of the standard even in the absence of the standard. Both sets of modeling results are presented in Section 5.4.

### **5.3.2 The Integrated Planning Model**

IPM is a multi-regional, dynamic, deterministic linear programming model of the U.S. electric power sector. It provides forecasts of least cost capacity expansion, electricity dispatch, and emission control strategies while meeting energy demand and environmental, transmission, dispatch, and reliability constraints. EPA has used IPM for over two decades to better understand power sector behavior under future business as usual conditions and evaluate the economic and emission impacts of prospective environmental policies. The model is designed to reflect electricity markets as accurately as possible.<sup>4</sup> EPA uses the best available information from utilities, industry experts, gas and coal market experts, financial institutions, and government statistics as the basis for the detailed power sector modeling in IPM. The model documentation provides additional information on the assumptions discussed here as well as all other model assumptions and inputs.<sup>5</sup>

Although the Agency typically focuses on broad system effects when assessing the economic impacts of a particular policy, EPA's application of IPM includes a detailed and sophisticated regional representation of key power sector variables and its organization. When considering which new units are most cost effective to build and operate, the model considers the relative economics of various technologies based on a wide spectrum of current and future considerations, including capital costs, operation and maintenance costs, fuel costs, utility sector regulations, and emission profiles. The capital costs for new units account for regional differences in labor, material, and construction costs. These regional cost differentiation factors are based on assumptions used in the EIA's AEO.

As part of IPM's assessment of the relative economic value of building a new power plant, the model incorporates a detailed representation of the fossil-fuel supply system that is used to forecast equilibrium fuel prices, a key component of new power plant economics. The model includes an endogenous representation of the North American natural gas supply system through a natural gas module that reflects full supply/demand equilibrium of the North

---

<sup>4</sup> <http://www.epa.gov/airmarkt/progsregs/epa-ipm/index.html>

<sup>5</sup> <http://www.epa.gov/airmarkt/progsregs/epa-ipm/BaseCasev410.html#documentation>

American gas market. This module consists of 114 supply, demand, and storage nodes and 14 liquefied natural gas regasification facility locations that are tied together by a series of linkages (i.e., pipelines) that represent the North American natural gas transmission and distribution network.

IPM also endogenously models the coal supply and demand system throughout the continental U.S., and reflects non-power sector demand and imports/exports. IPM reflects 84 coal supply curves, 12 coal sulfur grades, and the coal transport network, which consists of 1,230 linkages representing rail, barge, and truck and conveyer linkages. The coal supply curves in IPM, which are publicly available<sup>6</sup>, were developed during a thorough bottom-up, mine-by-mine approach that depicts the coal choices and associated supply costs that power plants will face over the modeling time horizon. The IPM documentation outlines the methods and data used to quantify the economically recoverable coal reserves, characterize their cost, and build the 84 coal supply curves. The coal supply curves were developed in consultation with Wood Mackenzie, one of the leading energy consulting firms and specialists in coal supply. These curves have been independently reviewed by industry experts and have been made available for public review on several occasions over the past two years during other rulemaking processes.

EPA has used IPM extensively over the past two decades to analyze options for reducing power sector emissions. Recently, the model has been used to forecast the costs, emission changes, and power sector impacts for the Clean Air Interstate Rule (CAIR), Cross-State Air Pollution Rule (CSAPR), and the Mercury and Air Toxics Standards (MATS).<sup>7</sup>

The model undergoes periodic formal peer review, which includes separate expert panels for both the model itself and EPA's key modeling input assumptions.<sup>8</sup> The rulemaking process also provides opportunity for expert review and comment by a variety of stakeholders, including owners and operators of the electricity sector that is represented by the model, public interest groups, and other developers of U.S. electricity sector models. EPA is required to respond to significant comments submitted regarding the inputs used in IPM, its structure, and application. The feedback that the Agency receives provides a highly detailed check for key input assumptions, model representation, and modeling results. IPM has received extensive review by energy and environmental modeling experts in a variety of contexts. For example, in

---

<sup>6</sup> v4.10 of the coal supply curves may be found in Appendix 9-4 of <http://www.epa.gov/airmarkt/progsregs/epa-ipm/BaseCasev410.html#documentation>

<sup>7</sup> All of the IPM projections conducted for this rulemaking are available at EPA's website and in the public docket.

<sup>8</sup> <http://www.epa.gov/airmarkets/progsregs/epa-ipm/past-modeling.html>

the late 1990's, the Science Advisory Board reviewed IPM as part of the CAA Amendments Section 812 prospective studies that are periodically conducted.<sup>9</sup> The model has also undergone considerable interagency scrutiny when it has been used to conduct over one dozen legislative analyses (performed at Congress' request) over the past decade. In addition, Regional Planning Organizations throughout the U.S. have extensively examined IPM as a key element in the state implementation plan (SIP) process for achieving the National Ambient Air Quality Standards. The Agency has also used the model in a number of comparative modeling exercises sponsored by Stanford University's Energy Modeling Forum over the past 15 years.

IPM has also been employed by states (e.g., for RGGI, the Western Regional Air Partnership, Ozone Transport Assessment Group), other Federal and State agencies, environmental groups, and industry, all of whom subject the model to their own review procedures. States have used the model extensively to inform issues related to ozone in the northeastern U.S. This groundbreaking work set the stage for the NO<sub>x</sub> SIP call, which has helped reduce summer NO<sub>x</sub> emissions and the formation of ozone in densely populated areas in the northeast.

## **5.4 Analyses of Future Generating Capacity**

### **5.4.1 Base Case Power Sector Modeling Projections**

EPA conducted analysis and modeling in support of the April 2012 EGU GHG New Source Standards proposal, and concluded that new unplanned noncompliant base load power plants are not expected to be economic well beyond the analysis period. EPA conducted an analysis of the economic impacts by modeling a base case scenario of future electricity market conditions. EPA's IPM modeling relied on the AEO 2010 for the electric demand forecast for the U.S. and employed a set of EPA assumptions regarding fuel supplies, the performance and cost of electric generation technologies, pollution controls, and numerous other parameters.<sup>10</sup> The base case accounts for the effects of the finalized MATS and CSAPR rules, and New Source Review settlements and state rules through December 2010 impacting sulfur dioxide (SO<sub>2</sub>), NO<sub>x</sub>, directly emitted particulate matter and CO<sub>2</sub>.<sup>11</sup>

The most current EIA projections are reflected in AEO 2013 and are summarized in the following tables alongside the EPA projections. New coal-fired capacity through 2030 in the

---

<sup>9</sup> <http://www.epa.gov/air/sect812/>

<sup>10</sup> [http://www.epa.gov/airmarkt/progsregs/epa-ipm/proposedEGU\\_GHG\\_NSPS.html](http://www.epa.gov/airmarkt/progsregs/epa-ipm/proposedEGU_GHG_NSPS.html)

<sup>11</sup> The legal status of CSAPR and CAIR has no impact on this proposal's evaluation, as neither CSAPR nor CAIR significantly influences the type of new capacity additions projected to be economic.

AEO 2013 reference case is entirely CCS-equipped and would be in compliance with this proposal (0.3 GW). The projected CCS-equipped capacity is assumed to occur in response to existing Federal, State, and local incentives for the technology.<sup>12</sup> According to the AEO 2013 – which represents existing policies and regulations influencing the power sector - the vast majority of new, unplanned generating capacity is forecast to be either natural gas-fired or renewable.<sup>13</sup> The economics favoring new natural gas combined cycle (NGCC) additions instead of conventional coal are robust under a range of sensitivity cases examined in the AEO 2013. Sensitivity cases that separately examine higher economic growth, lower coal prices, no risk premium for greenhouse gas emissions liability from conventional coal, and lower oil and natural gas resources also forecast zero unplanned additions of coal-fired capacity without CCS in the analysis period. Recent previous versions of the AEO came to similar conclusions. Based on these previous AEO analyses, DOE concluded that “the low capital expense, technical maturity, and dispatchability of natural gas generation are likely to dominate investment decisions under current policies and projected prices.”<sup>14</sup>

In comparing the EPA and EIA modeling projections reported here, the most important variables influencing the choice of technology for new generating capacity are more favorable to new coal-fired capacity in the EPA analysis. For example, electric demand in 2020 was assumed to be 4,305 billion kWh (taken from AEO 2010) in EPA’s modeling projections, which is over 4% higher than electric demand in AEO 2013.<sup>15</sup> Projected fuel prices for natural gas and coal are also more favorable to new coal-fired capacity relative to new NGCC capacity in the EPA analysis than in the AEO 2013 projections.

---

<sup>12</sup> These programs include the Emergency Economic Stabilization Act of 2008, the American Reinvestment and Recovery Act of 2009 (which assisted in funding for such programs as the Clean Coal Power Initiative through DOE and tax credits for Clean Energy Manufactures through DOE and the Treasury Department), as well as loans provided by USDA for CO2 capture projects.

<sup>13</sup> [http://www.eia.gov/forecasts/aeo/chapter\\_legs\\_regs.cfm](http://www.eia.gov/forecasts/aeo/chapter_legs_regs.cfm)

<sup>14</sup> Department of Energy (2011). *Report on the First Quadrennial Technology Review*. Available at [http://energy.gov/sites/prod/files/QTR\\_report.pdf](http://energy.gov/sites/prod/files/QTR_report.pdf).

<sup>15</sup> In a long-term power sector modeling framework, calendar years are typically grouped into model run years. In EPA’s IPM projections reported in this chapter, 2020 is the run year that is representative of results from calendar years 2017-2024. Consequently, the chapter often presents 2020 projections and results from EPA and EIA as opposed to projections for the last year of the analysis period (2022).

**Table 5-1. Reference Case Unplanned Cumulative Capacity Additions (GW)**

Capacity Type	EPA	AEO 2013		
	2020	2020	2025	2030
Conventional Coal	0	0	0	0
Coal with CCS	2	0.3	0.3	0.3
Natural Gas CC	7.0	3.1	17.4	48.2
Natural Gas CT	3.0	15.4	28.0	43.3
Nuclear	0	0	0	0
Renewables <sup>16</sup>	26.9	3.7	6.4	10.5
Distributed Generation	0	0.9	1.9	3.1
<b>Total</b>	<b>38.9</b>	<b>23.4</b>	<b>54.1</b>	<b>105.4</b>

Notes: The sum of the table values in each column may not match the total figure due to rounding.

Source: EPA 2020 projection from IPM run by EPA, 2011; EIA 2020-2030 projection from EIA Annual Energy Outlook 2013

The capacity projections of EIA and EPA represent a continuation of current trends, where natural gas-fired capacity has been the technology of choice for base load and intermediate load power generation over the last few years (see Figure 5-2), due in large part to its significant levelized cost of electricity<sup>17</sup> (LCOE) advantage over coal-fired generating technologies. A greater discussion of the relative LCOE of different generating technologies is provided beginning in Section 5.5.

<sup>16</sup> Renewable projections are higher in the EPA reference case due largely to EPA's 2011 modeling projections predating AEO 2013 projections; therefore, all renewable builds that occurred in the interim would be accounted for in AEO 2013 as 'planned' capacity and are omitted from the table above. The overall amount of total renewable capacity by 2020 is largely similar.

<sup>17</sup>The levelized cost of electricity is an economic assessment of the cost of electricity from a new generating unit or plant, including all the costs over its lifetime: initial investment, operations and maintenance, cost of fuel, and cost of capital.

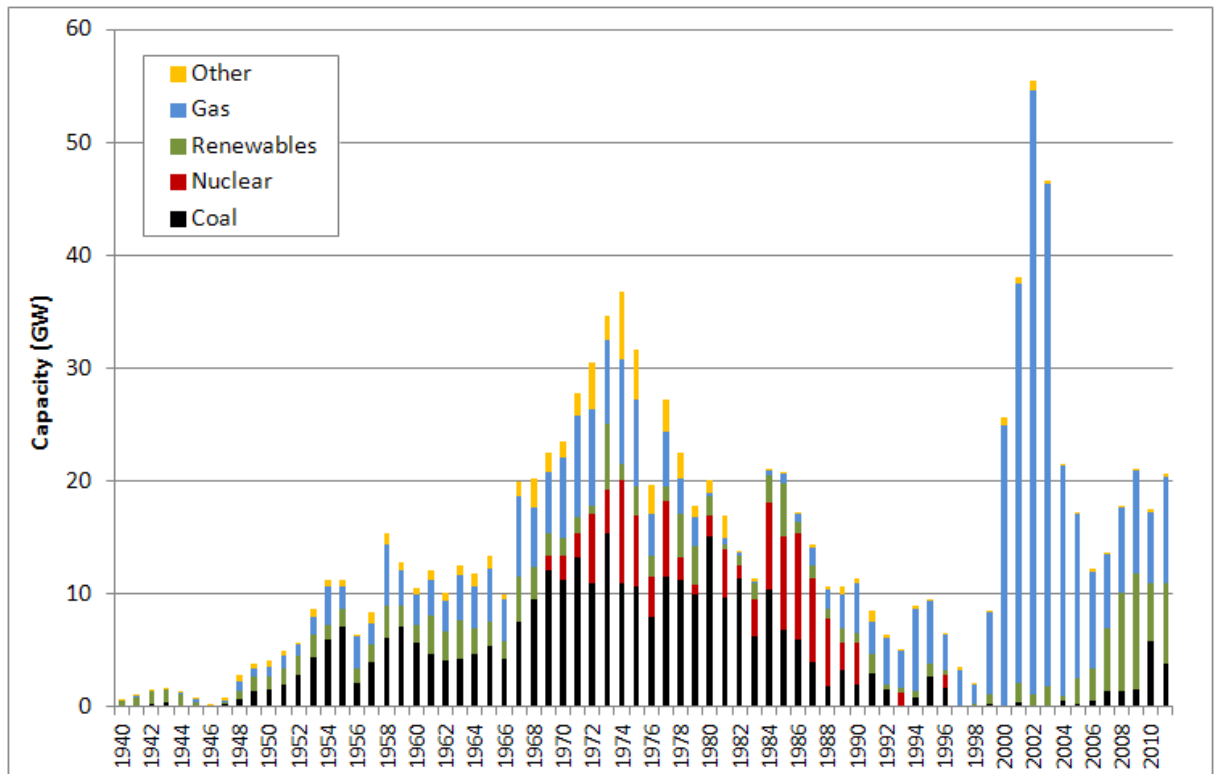

**Figure 5-1. Historical U.S. Power Plant Capacity Additions, by Technology, 1940-2011**

Source: Form EIA-860 (2011)

Note: Renewables include hydro, geothermal, biomass, solar, and wind energy technologies.

In addition to new builds, increased electricity demand is expected to be partially fulfilled by increased utilization of existing generating capacity. Generation projections are the result of least-cost economic modeling both in IPM and AEO 2013, and reflect the most cost-effective dispatch and investment decisions modeled, given a variety of variables and constraints. Even without the deployment of unplanned conventional coal-fired capacity, U.S. electricity demand will continue to be met by a diverse mix of electricity generation sources with coal projected to continue to provide the largest share of electricity (39% of total 2020 generation in AEO2013 and 46% in EPA’s projections), as displayed in Table 5-2.

**Table 5-2. 2011 U.S. Electricity Net Generation and Projections for 2020, 2025, and 2030 (Billion kWh)**

	Historical	EPA	AEO 2013		
	2011	2020	2020	2025	2030
Coal	1,718	1,976	1,640	1,707	1,745
Oil	15	Negligible	15	16	16
Natural Gas	926	869	1,078	1,127	1,221
Nuclear	790	840	885	912	908
Hydroelectric	318	286	289	291	292
Non-Hydro Renewables	164	289	270	295	310
Other	18	45	5	9	13
<b>Total</b>	<b>3,949</b>	<b>4,305</b>	<b>4,182</b>	<b>4,356</b>	<b>4,506</b>

Source: Historical data from Form EIA-860, 2011. EPA 2020 projection from IPM run by EPA, 2011; EIA 2020-2030 projection from EIA Annual Energy Outlook 2013. Notes: Net summer generating capacity. The sum of the table values in each column may not match the total figure due to rounding. "Non-Hydro Renewables" include biomass, geothermal, solar, and wind electric generation capacity. The capacity of a generating unit that is co-firing gas in a coal boiler is split in this table between "pulverized coal" and "Oil/Gas Steam" proportionally by fuel use.

It has been previously noted that since the time of the IPM Base Case analysis, projections for key market variables are now less favorable to the development of coal-fired capacity. State and regional regulations have necessarily evolved since EPA's 2011 modeling projections, most notably regulations of GHG emissions from the power sector and state renewable portfolio standards (RPS):

- State regulations addressing CO<sub>2</sub> emissions – Several states have adopted measures to address emissions of CO<sub>2</sub> from the power sector. These approaches include flexible market-based programs like California's Assembly Bill 32 and the RGGI in the Northeast, and specific GHG performance standards for new power plants in California, Oregon, New York, and Washington.
- State Renewable Portfolio Standards (RPS) – According to EIA, 30 states and the District of Columbia have an enforceable RPS, or similar laws.<sup>18</sup> There are eight other States that have voluntary goals.<sup>19</sup> These measures, in conjunction with Federal financial incentives, are key drivers of the significant growth in new renewable energy seen over the past few years and expected over the next decade.

<sup>18</sup> [http://www.eia.gov/forecasts/aeo/legs\\_regs\\_all.cfm#state](http://www.eia.gov/forecasts/aeo/legs_regs_all.cfm#state)

<sup>19</sup> <http://www.dsireusa.org/rpsdata/index.cfm>



- State and Utility IRPs – IRPs, which are usually adopted by utilities in response to state requirements, allow regulators and utilities to consider a broader array of measures to meet future electric demand most cost effectively. IRPs also help electric planners to consider key strategic and policy goals like electric reliability, environmental impacts, and the economic efficiency of power sector investments.<sup>20</sup> In general, these plans confirm the expectation that utilities anticipate that any new sources of generation will be from renewables, in response to state and federal regulations and incentives, and natural gas prices. Furthermore, these plans reflect an expectation of relatively low demand growth due, in part, to policies and regulations to reduce the electricity consumption such as energy efficiency regulations and policies, evolution of the Smart Grid, and demand response measures.

Any recently adopted state and local climate or related electricity sector regulations that are not included in the IPM Base Case analysis, California’s AB 32 for example, also make the development of coal-fired capacity less favorable.

#### **5.4.2 Alternative Scenarios from AEO 2013**

Power sector modeling that projects no new, unplanned, conventional coal-fired capacity in the analysis period have been demonstrated to be robust under a range of alternative assumptions that influence the industry’s decisions to build new power plants. For example, EIA typically supplements the AEO with scenarios that explore key market, technical, and regulatory issues. Of the 26 scenarios contained in the AEO 2013, none projected unplanned, conventional coal capacity in the analysis period, including the four scenarios that may be considered most favorable to the development of coal-fired capacity displayed below:<sup>21</sup>

---

<sup>20</sup> E.g., <http://www.pacificpower.net/about/irp.html>

<sup>21</sup> AEO 2013 scenario definitions: High Economic Growth increases annual real GDP growth by 0.4%; Low Coal Cost assumes greater regional productivity growth rates and lower wages, equipment, and transportation costs for the coal industry; Low Oil and Gas Resource reduces the ultimate estimated recovery of shale gas, tight gas, and tight oil by 50%; No GHG Concern removes the perceived risk of incurring costs under a future GHG policy from market investment decisions.

**Table 5-3. AEO 2013 Unplanned Cumulative Capacity Additions, GW (2020<sup>22</sup>)**

Capacity Type	Reference	High Growth	Low Coal Cost	Low Gas Resource	No GHG Concern
Conventional Coal	0	0	0	0	0
Coal with CCS	0.3	0.3	0.3	0.3	0.3
Natural Gas	18.5	19.5	17.6	13.7	17.8
Nuclear	0	0	0	0	0
Non-Hydro Renewables	3.7	13.5	5.0	5.2	4.1
Other	0.9	0.6	0.8	0.2	0.8
<b>Total</b>	<b>23.4</b>	<b>33.9</b>	<b>23.8</b>	<b>19.3</b>	<b>23.1</b>

### 5.4.3 Power Sector Fuel Price Dynamics and Trends

As mature technologies, the cost and performance characteristics of conventional coal-fired capacity and NGCC are projected by EPA to be relatively stable over time in comparison to emerging generation technologies.<sup>23</sup> Therefore, expectations of future fuel prices play a key role in determining the overall cost competitiveness of conventional coal versus NGCC.

Current and projected natural gas prices are considerably lower than observed prices over the past decade. This is largely due to advances in hydraulic fracturing and horizontal drilling techniques that have opened up new shale gas resources and substantially increased the supply of economically recoverable natural gas. According to EIA:

Shale gas refers to natural gas that is trapped within shale formations. Shales are fine-grained sedimentary rocks that can be rich sources of petroleum and natural gas. Over the past decade, the combination of horizontal drilling and hydraulic fracturing has allowed access to large volumes of shale gas that were previously uneconomical to produce. The production of natural gas from shale formations has rejuvenated the natural gas industry in the United States.

Of the natural gas consumed in the United States in 2011, about 95% was produced domestically; thus, the supply of natural gas is not as dependent on foreign producers as is the supply of crude oil, and the delivery system is less subject to interruption. The availability of large quantities of shale gas should enable the United

<sup>22</sup> The 2020 run year represents conditions out through 2022, consistent with the eight year NSPS review cycle.

<sup>23</sup> <http://www.epa.gov/airmarkt/progsregs/epa-ipm/docs/v410/Chapter4.pdf>

States to consume a predominantly domestic supply of gas for many years and produce more natural gas than it consumes.

The U.S. Energy Information Administration's [Annual Energy Outlook 2013 Early Release](#) projects U.S. natural gas production to increase from 23.0 trillion cubic feet in 2011 to 33.1 trillion cubic feet in 2040, a 44% increase. Almost all of this increase in domestic natural gas production is due to projected growth in shale gas production, which grows from 7.8 trillion cubic feet in 2011 to 16.7 trillion cubic feet in 2040.<sup>24</sup>

Recent historical data reported to EIA is also consistent with these trends, with 2012 being the highest year on record for domestic natural gas production.<sup>25</sup> The average delivered natural gas price to the power sector was \$3.44 per MMBtu in 2012, down from \$4.78/MMBtu in 2011.<sup>26</sup>

Increases in the natural gas resource base have led to fundamental changes in the outlook for natural gas. While sources may disagree on the absolute level of increases from shale resources, there is general agreement that recoverable natural gas resources will be substantially higher for the foreseeable future than previously anticipated, exerting downward pressure on natural gas prices.<sup>27,28</sup> EPA and EIA modeling incorporates the impact of these additional resources on the forecasts of the price of natural gas used by electric generating units. The increases in the natural gas resource base are reflected not only in current natural gas prices and projections (e.g., AEO 2013), but also in current capacity planning by utilities and electricity producers across the country. The North American Electric Reliability Corporation's (NERC) Long Term Reliability Assessment, which is based on utility plans for new capacity over a 10-year period, reinforces this consensus by stating that "gas-fired generation [is] the primary choice for new capacity."<sup>29</sup>

EPA's and EIA's modeling frameworks are designed to reflect the longer term, fundamentals-based perspective that electric utilities and developers employ in evaluating

---

<sup>24</sup> [http://www.eia.gov/energy\\_in\\_brief/article/about\\_shale\\_gas.cfm](http://www.eia.gov/energy_in_brief/article/about_shale_gas.cfm)

<sup>25</sup> <http://www.eia.gov/dnav/ng/hist/n9010us2a.htm>

<sup>26</sup> <http://www.eia.gov/dnav/ng/hist/n3045us3A.htm>; Assumes that 1 TCF = 1.023 MMBtu natural gas (<http://www.eia.gov/tools/faqs/faq.cfm?id=45&t=8>)

<sup>27</sup> National Petroleum Council. 2011. *Prudent Development: Realizing the Potential of North America's Abundant Natural Gas and Oil Resources*. <http://www.npc.org/reports/rd.html> (see Figure 1.2 on p. 47).

<sup>28</sup> EIA. 2013. U.S. Crude Oil and Natural Gas Proved Reserves, 2011. <http://www.eia.gov/naturalgas/crudeoilreserves/pdf/uscrudeoil.pdf>

<sup>29</sup> NERC, Long-Term Reliability Assessments for 2012. New capacity includes both planned and conceptual resources as defined by NERC.

capital investments, while utilizing scenario testing to account for broader fuel market uncertainties. Short-term fuel price volatility is not the most relevant factor in this context because new power plants have asset lives measured in decades, not in months or years, and new capacity investment decisions are based on long-run expected prices, not month-to-month, or even year-to year, variations in fuel prices. Shorter-term prices will affect how units are dispatched, but these potential dispatch impacts are considered with other factors over a longer time horizon and factored into the choice of which type of plant to build. In contrast, the uncertainty surrounding long-term fuel prices will exert significantly greater influence on the technology selected for new capacity additions. In a modeling context with perfect foresight, this longer term uncertainty may be evaluated by the scenario testing presented throughout this analysis.

In addition to major changes in the gas supply outlook, there have been notable changes in the coal supply outlook. Coal costs have generally increased over the past few years due primarily to increased production costs. These costs have increased as the most accessible and economically viable mines are depleted, requiring movement into coal reserves that are more costly to mine. The basic trends in coal supply are not expected to change for the foreseeable future.<sup>30</sup>

Taken together, current and expected natural gas and coal market trends are contributing to a fundamental shift in the economic conditions for new power plant development that utilities and developers have recognized and responded to in planning.<sup>31</sup>

#### **5.4.4 Power Sector Fuel Projections**

To examine the potential impacts of uncertainty inherent in natural gas and coal markets, the EIA used scenario analysis to generate the 2020 fuel price projections in table 5-5.

---

<sup>30</sup> <http://www.eia.gov/forecasts/aeo/assumptions/pdf/coal.pdf>

<sup>31</sup> For example: "We don't have any plans to build new coal plants. So the rules won't have much of an impact. Any additional generation plants we'd build for the next generation will be natural gas." American Electric Power, 3/26/2012, National Journal; "As we look out over the next two decades, we do not plan to build another coal plant. ... As the evidence is coming in, [shale gas] is proving to be the real deal. If we have no plans, as one of the largest utilities and largest users of coal in this country, no plans to build a new coal plant for two decades, the regulations are not relevant." Jim Rogers (Duke), 3/27/2012, NPR All Things Considered.; "If you actually look at the economics today, you would be burning gas, not coal," Jack Fusco, Calpine, 12/1/2010, Marketplace; "Coal's most ardent defenders are in no hurry to build new ones in this environment." John Rowe, Exelon, 9/2011, EnergyBiz; "With low gas prices, gas-fired generation kind of snowplows everything else" Lew Hay, NextEra, 11/1/2010, Dow Jones.

**Table 5-4. National Delivered 2020 Fuel Prices by AEO 2013 Scenario (2011\$/MMBtu)**

Scenario <sup>32</sup>	Natural Gas	Coal
Reference	5.00	2.52
High Growth	5.45	2.57
Low Growth	4.64	2.47
High Coal Cost	5.26	2.93
Low Coal Cost	4.85	2.17
High Gas/Oil Resource	3.60	2.47
Low Gas/Oil Resource	6.18	2.78

However, given that power plants are long-lived assets, capacity planning decisions are necessarily undertaken with a forward view of expected market and regulatory conditions. In producing the AEO 2013, EIA capacity expansion projections are informed by a lifecycle cost analysis over a 30-year period in which the expectations of future prices are consistent with the projections realized in the model (i.e. the model executes decisions with perfect foresight of future market, technical, and regulatory conditions). Therefore, the fuel price that informs capacity expansion decisions in 2020 is not the 2020 price, but the entire future fuel price stream. For example, Figure 5-6 displays EIA's natural gas price projections for the Reference Case and several scenarios through 2040.

---

<sup>32</sup> AEO 2013 scenario definitions: High Economic Growth increases annual real GDP growth by 0.4%; Low Economic Growth decreases real GDP growth by 0.6%; High Coal Cost assumes lower regional productivity growth rates and higher wages, equipment, and transportation costs for the coal industry; Low Coal Cost assumes greater regional productivity growth rates and lower wages, equipment, and transportation costs for the coal industry; High Oil and Gas Resource expands the ultimate estimated recovery of shale gas, tight gas, and tight oil by 100%; Low Oil and Gas Resource reduces the ultimate estimated recovery of shale gas, tight gas, and tight oil by 50%.

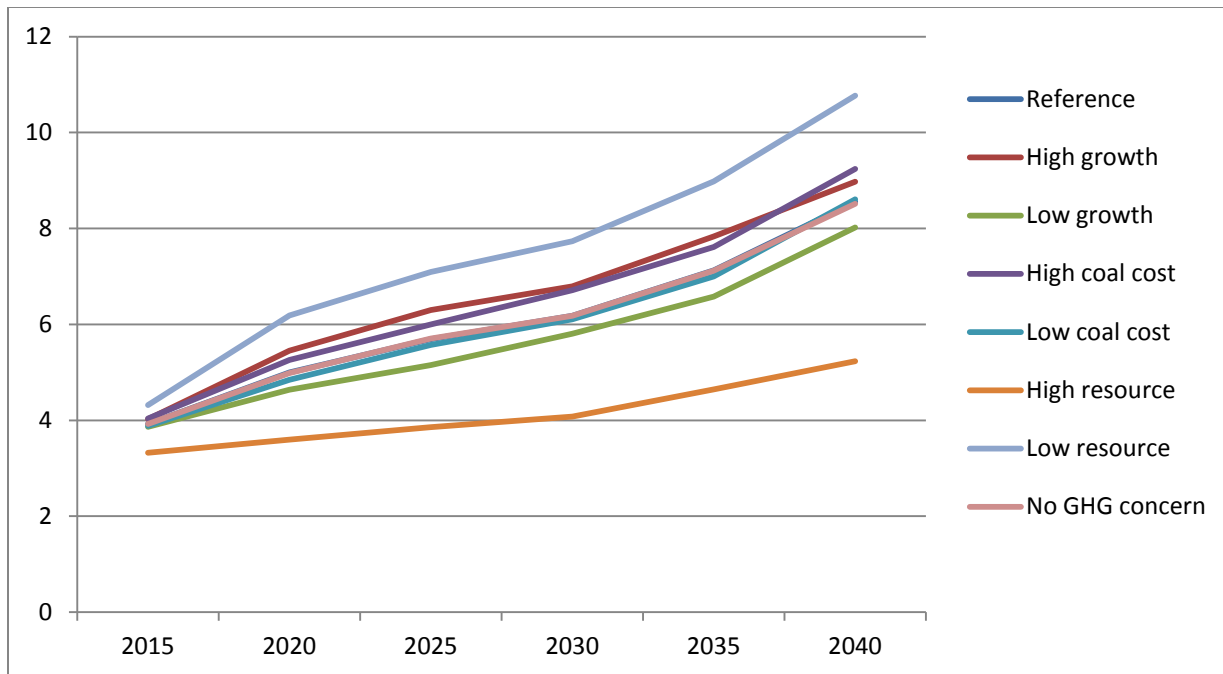

**Figure 5-2. National Delivered Natural Gas Prices by Select AEO 2013 Scenario (2011\$/MMBtu)**

Natural gas prices are expected to increase after 2020 in all scenarios<sup>33</sup>; however, rising natural gas prices through 2040 – including in EIA’s low gas/oil resource scenario - are still not sufficient to support new, conventional coal-fired generation in the analysis period (i.e., through 2022), demonstrating that natural gas prices at currently low levels are not required to persist for NGCC to maintain its economic advantage over coal-fired technologies.

While the uniformity of EIA scenarios in projecting no new, unplanned, conventional coal-fired capacity through the analysis period is compelling, the scenario projections cannot fully illustrate the extent of the economic advantage that NGCC maintains over conventional coal – only that the advantage remains intact across a broad range of market and technical scenarios. To identify potential market conditions that could fully erode the private cost advantages of NGCC over conventional coal during the analysis period the following section adopts a static, engineering cost analysis.

<sup>33</sup> Coal prices are also expected to rise in all scenarios.

## 5.5 Levelized Cost of Electricity Analysis

### 5.5.1 Overview of the Concept of Levelized Cost of Electricity

New capacity projections from the EPA and EIA reviewed in the previous section indicate that the NSPS is not projected to require changes in the design or construction of new EGUs from what would be expected in the absence of the rule. Thus, under both the baseline projections as well as alternative AEO 2013 scenarios, the proposed EGU New Source GHG Standards are not projected to result in any emission reductions, monetized benefits, or costs.

Despite this conclusion, it is important to supplement the power sector modeling projections to quantify the robustness of the economic advantage of new NGCC relative to new coal without CCS. To achieve this task, EPA will rely on the concept of LCOE. LCOE is a widely used metric that represents the cost, in dollars per output, of building and operating a generating facility over the entirety of its economic life. Evaluating competitiveness on the basis of LCOE is particularly useful in establishing cost comparisons between generation types with similar operating characteristics but with different cost and financial characteristics. The typical cost components associated with LCOE include capital, fixed operating and maintenance (FOM), variable operating and maintenance (VOM), and fuel.

The levelized capital cost is the result of the annualized capital cost spread over the annual output of the generation facility. The annualized capital cost (expressed in \$/kW-yr) is the product of the \$/kW capital cost and the capital recovery factor (CRF). A CRF may be calculated using the project's interest rate ( $i$ ) and book life ( $n$ ).<sup>34</sup>

The levelized capital and FOM costs may be calculated by taking the annualized capital and FOM (expressed in \$/kW-yr) and spreading the expense over the annual generation of the facility using the expected average annual capacity factor (the percent of full load at which a unit would produce its actual annual generation if it operated for 8760 hours).

The VOM, which is already expressed in terms of cost per unit output, may be presented with or without fuel expense. The fuel expense is typically the largest component of VOM (non-fuel components to VOM include start-up fuel, consumables, inspections, etc.) and for certain capacity types – such as NGCC – fuel expense may represent the majority of the LCOE. To calculate a levelized fuel cost, it is necessary to introduce the concept of a levelized fuel price.

---

<sup>34</sup> The interest rate assumed for NGCC projects is 9.06%; the interest rate assumed for coal-fired projects is 9.57%. Both types of projects are assumed to have a 30-year book life, resulting in a capital recovery factor of 9.78% for NGCC projects and 10.23% for coal-fired projects.

Because levelized costs consider the entire lifecycle of the facility, the levelized fuel price calculates the single value payments necessary to reflect the stream of annual delivered fuel prices over the economic life of the facility at a given discount rate.<sup>35</sup> Levelizing fuel prices recognizes the necessity to consider the trajectory of fuel costs over the facility's entire economic life.

It should be noted that there are other important considerations beyond LCOE that impact power plant investment decisions. New power plant developers must consider the particular demand characteristics in any particular region, the existing mix of generators, operational flexibility of different types of generation, prevailing and expected electricity prices, and other potential revenue opportunities (e.g., the capacity value of a particular unit, where certain power markets have mechanisms to compensate units for availability to maintain reliability, sale of co-products, etc.). Broader system-wide power sector modeling – such as the analyses conducted by EPA and scenarios conducted by EIA – is able to more effectively capture these considerations.

### 5.5.2 Cost and Performance of Technologies

The NGCC and coal-fired generation technology cost and performance assumptions that form the basis for the LCOE analysis in this chapter are sourced from the DOE's NETL.<sup>36</sup> NETL cost and performance characteristics were selected for coal-fired technologies because the NETL estimates were unique in the detail of their cost and performance estimates for a range of CO<sub>2</sub> capture levels for both new super critical pulverized coal (SCPC) and IGCC facilities.<sup>37,38</sup> The CO<sub>2</sub> capture sensitivity analysis included an evaluation of the cost, performance, and

---

<sup>35</sup> As an illustration of applying a discount rate to a stream of future fuel prices, the levelized fuel price will be less than the mean fuel price if prices are increasing; equal to the mean if fuel prices are constant; and greater than the mean if fuel prices are declining. The weighting of nearer-term prices through the application of a discount rate is consistent with modeling economic behavior. EPA utilized a 5% discount rate to calculate levelized fuel prices, a value consistent with the discount rate embedded in IPM.

<sup>36</sup> <http://www.netl.doe.gov/energy-analyses/pubs/Gerdes-08022011.pdf>

<sup>37</sup> All potential build types are compliant with all current environmental regulations, including EPA's Mercury and Air Toxics Standards (MATS).

<sup>38</sup> For an emerging technology like CCS, costs can be estimated for a "first-of-a-kind" (FOAK) plant or an "n<sup>th</sup>-of-a-kind" (NOAK) plant, the latter of which has lower costs due to the "learning by doing" and risk reduction benefits that result from serial deployments as well as from continuing research, development and demonstration projects. The estimates provided in Table 5-5 for a new NGCC unit and for a SCPC plant without CO<sub>2</sub> capture are based on mature technologies and are thus NOAK costs. For plants that utilize technologies that are not yet fully mature, such the IGCC or any plant that includes CO<sub>2</sub> capture, the cost estimates in Table 5-5 represent a plant that is somewhere between FOAK and NOAK, sometimes referred to as "next-of-a-kind". Because there are a number of projects currently under development, the EPA believes it is reasonable to focus on the next-of-a-kind costs provided in Table 5-5. See the preamble for additional discussion.



environmental profile of these facilities under different configurations that were tailored to achieve a specific level of carbon capture. EPA selected NETL cost and performance characteristics for NGCC to ensure that the cost comparisons between NGCC and coal-fired technologies – the primary comparison made in this chapter – represented a single, internally consistent framework. For technologies where NETL cost and performance estimates were not available or sufficiently recent – such as for nuclear and simple cycle CT – EPA adopted EIA’s AEO 2013 estimates of LCOE.

To represent a new SCPC facility, NETL assumed a new boiler with a combination of low-NOx burners (LNB) with overfire air (OFA) and a selective catalytic reduction (SCR) system for NOx control. The plant was assumed to have a fabric filter and a wet limestone FGD scrubber for particulate matter and SO<sub>2</sub> control, respectively. For configurations including CCS, the plant was assumed to have a sodium hydroxide (NaOH) polishing scrubber to ensure that the flue gas entering the CO<sub>2</sub> capture system has a SO<sub>2</sub> concentration of 10 ppmv or less. The SCPC w/ CCS plant configurations were equipped with Fluor’s Econamine FG Plus<sup>SM</sup> process for post-combustion CO<sub>2</sub> capture via temperature swing absorption with a monoethanolamine (MEA) solution as the chemical solvent.

Specific to the partial capture configurations for SCPC, the NETL study identified two options. The first option identified was to process the entire flue gas stream through the MEA capture system, but at reduced solvent circulation rates. The second option was to maintain the same high solvent circulation rate and stripping steam requirement as would be used for full capture, but only treat a portion of the total flue gas stream. The NETL report determined that this “slip stream” approach was the most economical because a reduction in flue gas flow rate will: (1) decrease the quantity of energy consumed by flue gas blowers; (2) reduce the size of the CO<sub>2</sub> absorption columns; and (3) trim the cooling water requirement of the direct contact cooling system.<sup>39</sup> The “slip stream” approach – which leads to lower capital and operating costs – was adopted by EPA for cost and performance estimates under partial capture.

For a new IGCC EGU, the NETL study evaluated a number of IGCC plant configurations. EPA adopted the configurations presented as the most viable – from both an economic and technological perspective – for the no capture, partial capture, and full capture cases. The no CO<sub>2</sub> capture case employed an IGCC that used the two-stage acid gas (Selexol™) process for acid gas control (i.e., hydrogen sulfide (H<sub>2</sub>S) and CO<sub>2</sub>) but no WGS reactor. The 25 percent CO<sub>2</sub>

---

<sup>39</sup> NETL based this determination primarily upon literature review. Please refer to page 2 of <http://www.netl.doe.gov/energy-analyses/pubs/Gerdes-08022011.pdf>

capture case utilized the same two-stage Selexol™ unit to maximize CO<sub>2</sub> capture from the unshifted syngas. To achieve higher CO<sub>2</sub> capture levels – including full capture - the IGCC was assumed to be configured with a two-stage WGR with bypass and the two-stage acid gas (Selexol™) scrubbing system.<sup>40</sup> In summary, the technology cost and performance characteristics utilized by EPA in developing the LCOE estimates provided in this chapter are listed below in Table 5-7.

**Table 5-5. Technology Cost and Performance (2011\$)**

Capacity Type	Total Overnight Capital Cost (\$/kw)	Fixed Operations & Maintenance (\$/kw-yr)	Variable Operations & Maintenance (\$/MWh)	2020 Fuel Cost (\$/MMBtu)	Net Plant HHV Efficiency (%)
NGCC	891	26.7	1.8	5.00	50.2
SCPC	2,452	70.6	7.7	2.94	39.3
SCPC w/ Partial CCS (1,100 lbs/MWh gross)	3,301	90.7	10.5	2.94	34.5
SCPC w/Full CCS (200 lbs/MWh gross)	4,391	116.6	14.1	2.94	28.4
IGCC	2,969	94.8	9.3	2.94	39.0
IGCC w/ Partial CCS (1,100 lbs/MWh gross)	3,274	103.2	10.1	2.94	37.3
IGCC w/ Full CCS (150 lbs/MWh gross)	4,086	125.6	12.1	2.94	32.6

Notes: The coal assumed is a bituminous coal with a sulfur content of 2.8% (dry) at a price of \$2.94/MMBtu, consistent with the NETL analysis from which technology cost and performance as well as fuel price was sourced.<sup>41</sup> The natural gas price is the 2020 price from EIA's AEO 2013 Reference Case. NETL explains that there are a range of future potential costs that are up to 15% below, or 30% above the central estimate provided in Table 5-5.), consistent with a "feasibility study" level of design engineering applied to the various cases in this study. The value of the studies lie not in the absolute accuracy of the individual case results but in the fact that all cases were evaluated under the same set of technical and economic assumptions. This consistency of approach allows meaningful comparisons among the cases evaluated.

<sup>40</sup> For additional detail and discussion on the specific technology configurations selected for this analysis, please refer to the preamble.

<sup>41</sup> <http://www.netl.doe.gov/energy-analyses/pubs/BaselineCostUpdate.pdf>

### 5.5.3 Levelized Cost of Electricity of New Generation Technologies

This section presents four LCOE comparisons<sup>42</sup>:

1. NGCC to Uncontrolled Coal – to demonstrate the cost advantages of NGCC over a range of natural gas prices and regional market conditions.
2. Uncontrolled Coal to Coal with partial CCS – to demonstrate that any requirement for CCS could be accommodated and would not, based on the cost increment of constructing and operating the CCS portion, preclude new coal construction.
3. Coal with partial CCS to Nuclear – to demonstrate that the overall cost of building coal with partial CCS is not fundamentally different than the overall cost of constructing a nuclear facility.
4. NGCC to CT – to demonstrate the unlikelihood of a new combustion turbine being built with the expectation of exceeding a 33% annual capacity factor and thus being covered by this proposal.

It should be noted that the LCOE comparisons presented in this section only represent the cost to the generator and do not reflect the additional social costs that are associated with emissions of greenhouse gases or other air pollutants. A broader consideration of the health and welfare impacts of emissions from these technologies is considered beginning in Section 5.7.

Additionally, it is important to note that both EIA and EPA apply a climate uncertainty adder (CUA) - represented by a three percent increase to the weighted average cost of capital – to new, conventional coal-fired capacity types. EIA developed the CUA to address differences in how investments in new capacity are evaluated in power sector models as compared to resource planning exercises commonly conducted by the industry. While baseline power sector modeling scenarios may not specify potential future GHG regulatory requirements, investors in the industry typically incorporate some expectation of a future cost to limit CO<sub>2</sub> emissions in resource planning evaluations that influence investment decisions.<sup>43</sup> Therefore, the CUA reflects the additional risk typically assigned by project developers and utilities to GHG-

---

<sup>42</sup> “The illustrative unit cost and performance characteristics used in this section assume representative costs associated with spatially dependent components, such as connecting to existing fuel delivery infrastructure and the transmission grid. In practice units may experience higher or lower costs for these components depending on where they are located.

<sup>43</sup> [http://www.eia.gov/forecasts/aeo/electricity\\_generation.cfm](http://www.eia.gov/forecasts/aeo/electricity_generation.cfm)

intensive projects in a context of climate uncertainty. When comparing private investment costs, EPA believes the inclusion of the CUA in LCOE estimates is consistent with the industry's current planning and evaluation framework for future projects (demonstrable through IRPs and public utility commission orders) and is therefore necessary to adopt in evaluating the behavioral response to the cost competitiveness of alternative generating technologies.<sup>44</sup>

In defining the CUA, EIA states that “the adjustment should not be seen as an increase in the actual cost of financing, but rather as representing the implicit hurdle being added to GHG-intensive projects to account for the possibility they may eventually have to purchase allowances or invest in other GHG emission-reducing projects that offset their emissions.”<sup>45</sup> Therefore, EPA recognizes the application of the CUA is context dependent – as a part of the planning process it is appropriately applied in an evaluative sense to prospective projects, and then removed once a project transitions from planning to execution. Although a perspective that omits the CUA is inconsistent with the purposes of the analysis contained in this section (i.e., analyzing the project characteristics and market conditions that would lead a developer or utility to select a certain project, not determine what the actual project costs would be once that project selection is made), LCOE estimates for uncontrolled coal-fired projects are presented both with and without the CUA. All LCOE estimates of coal-fired facilities with CCS (partial or full) are presented without the CUA.

#### **5.5.4 Levelized Cost of Electricity of NGCC and Uncontrolled Coal**

EPA's base LCOE estimates for NGCC, SCPC, and IGCC are displayed below by cost component (capital, FOM, VOM, fuel) and assume a construction date of 2020:

---

<sup>44</sup> For example, a 2011 Synapse Report lists 15 utilities that adopted a value for CO<sub>2</sub> in their integrated resource planning. <http://www.synapse-energy.com/Downloads/SynapsePaper.2011-02.0.2011-Carbon-Paper.A0029.pdf>. In addition to utilities, several state commissions have mandated the inclusion of a cost of CO<sub>2</sub> in long-term planning (e.g., Minnesota utilities must adopt a price beginning in 2017).

<sup>45</sup> [http://www.eia.gov/forecasts/aeo/electricity\\_generation.cfm](http://www.eia.gov/forecasts/aeo/electricity_generation.cfm)

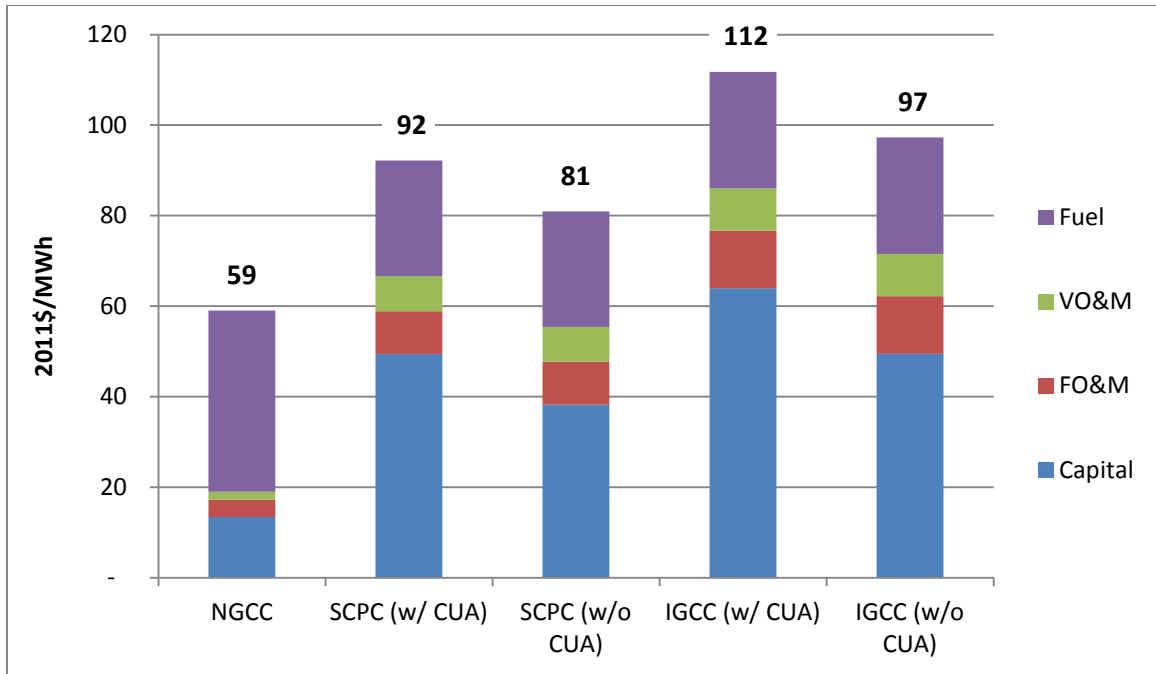

**Figure 5-3. Illustrative Wholesale Levelized Cost of Electricity of Alternative New Generation Technologies by Cost Component, EPA<sup>46</sup>**

Notes: The coal assumed is a bituminous coal with a sulfur content of 2.8% (dry) at a price of \$2.94/MMBtu, consistent with the NETL analysis from which technology cost and performance was sourced<sup>47</sup>. The \$2.94/MMBtu delivered coal price is assumed for all years; therefore, the price serves as both the 2020 fuel cost as well as the levelized fuel cost over any future period of time. This assumption produces a 20-year levelized coal price consistent with the AEO2013 Reference Case's \$2.79/MMBtu projection average delivered price to the electricity sector for all coals. A capacity factor of 85 percent is assumed across all technologies. For comparison, EIA estimates levelized costs under AEO 2013 assumptions for SCPC and IGCC are \$99/MWh and \$122/MWh, respectively, including a 3% CUA and excluding transmission investment costs.<sup>48</sup> The levelized costs presented above are based on NETL assumptions and will necessarily differ from AEO 2013 levelized costs for a variety of reasons, including cost and performance characteristics, financial assumptions, and fuel input prices. The LCOE for NGCC assumes a \$6.11/MMBtu levelized natural gas price – additional information on this assumption is provided later in this section (see Table 5-6).

On a levelized cost basis, NGCC is significantly cheaper than all of the uncontrolled coal-fired options, including those options that assume no CUA. In addition to the disparity in LCOE totals, the cost composition exhibits fundamental differences between natural gas- and coal-

<sup>46</sup> Although EPA believes that this cost data is broadly representative of the economics between new coal and new natural gas facilities, this analysis assumes representative new units and does not reflect the full array of new generating sources that could potentially be built. To the extent that other types of new units that would be affected by this rule are built, they may exhibit different costs than those presented here. For example, new conventional coal facilities of a size smaller than what is assumed in the base estimate would tend to exhibit a relatively higher LCOE, while some technologies could potentially display a lower LCOE if – all else equal – fuel could be obtained at a lower price than that assumed in this analysis (such as may be the case for petroleum coke or waste coal facilities). These potential differences do not fundamentally change the analysis presented in this chapter.

<sup>47</sup> <http://www.netl.doe.gov/energy-analyses/pubs/Gerdes-08022011.pdf>

<sup>48</sup> [http://www.eia.gov/forecasts/aeo/electricity\\_generation.cfm](http://www.eia.gov/forecasts/aeo/electricity_generation.cfm)

fired facilities, with NGCC dominated by fuel expense and the levelized cost of coal-fired technologies driven by capital expense. Consequently, this section will explore the impact of changes in natural gas price and the capital costs of coal-fired facilities to better quantify the magnitude of the relative cost advantage NGCC exhibits over coal-fired alternatives.

The figure below presents the LCOE of an NGCC facility at three levelized natural gas price levels. For reference, the base LCOE estimates for SCPC and IGCC are included as well.<sup>49</sup>

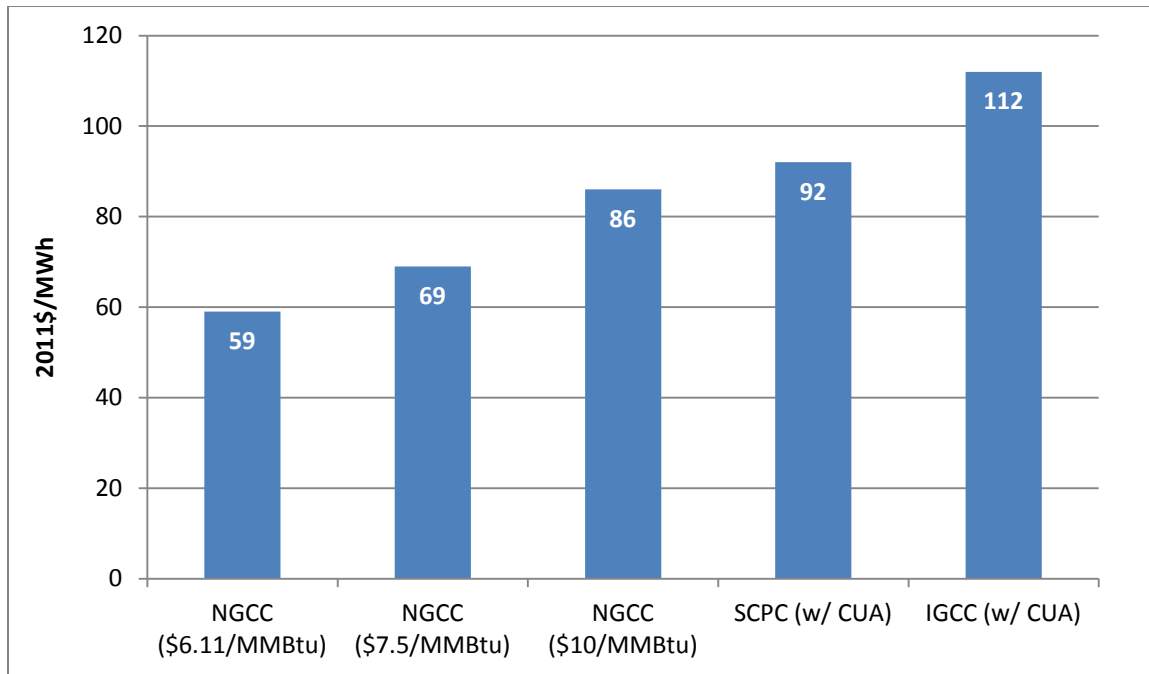

**Figure 5-4. Illustrative Wholesale Levelized Cost of Electricity of Alternative New Generation Technologies Across Select Natural Gas Prices, EPA**

It is only when natural gas prices exceed \$10/MMBtu on a levelized basis (in 2011 dollars) that new coal-fired generation without CCS approaches parity with NGCC in terms of LCOE (none of the EPA sensitivities or AEO 2013 scenarios described in this chapter project national average natural gas prices near that level).<sup>50</sup> To achieve a \$10/MMBtu levelized price

<sup>49</sup> Some new units could be designed to combust waste coal or petroleum coke (pet coke), which may be affected by this rule. These technologies could exhibit different local economics, particularly in the delivered price of fuel. From a capital and operating perspective, EPA believes the cost and performance of these units are broadly similar and therefore well represented by new, conventional coal-fired facilities (i.e. SCPC).

<sup>50</sup> As noted earlier in this chapter, investment decisions require consideration of fuel price projections over long periods of time; similarly, the power sector modeling cited here make fuel price projections over long periods of time. Neither these modeling projections nor these LCOE calculations are meant to suggest that the gas price could not reach as high as \$10/MMBtu at any given point in time; the point is that these analyses do not

in 2020 would require a significantly more pessimistic natural gas outlook than what is contained in AEO’s low natural gas resource scenario. To illustrate, Table 5-6 report the levelized natural gas prices (initial year of 2020) for both a 20-year period (to accommodate the end of EIA’s modeling projections in 2040) and 30-year period (calculated by continuing the projected level of price increases through 2050).

**Table 5-6. Levelized Natural Gas Prices by Select AEO 2013 Scenario (2011\$/MMBtu)**

Scenario	20-Year AEO Projection (2020-2039)	30-Year AEO-Based Projection (2020-2049)
Reference	6.11	6.79
High Growth	6.69	7.30
Low Growth	5.64	6.32
High Coal Cost	6.51	7.28
Low Coal Cost	6.00	6.74
High Gas/Oil Resource	4.09	4.40
Low Gas/Oil Resource	7.63	8.50

Note: Discount rate of 5%, consistent with IPM assumptions. The 30-year natural gas price is calculated by applying the price increase from 2039 to 2040 in all subsequent years through 2049.

To achieve a price that exceeds \$10/MMBtu on a 20-year levelized basis in 2020 would require a natural gas price projection more than 30% higher than EIA’s low resource scenario in all years – see Figure 5-5 below. This elevated natural gas price would result in a \$10.15/MMBtu average annual price in 2030 (\$16.23/MMBtu nominal) and a \$13.66/MMBtu price in 2039 (\$27.27/MMBtu nominal).<sup>51</sup>

---

expect such a price level to be sustained over a period of time that would influence an economic assessment of which type of new capacity offers a better investment.

<sup>51</sup> Nominal prices assuming an annual inflation rate of 2.5%.

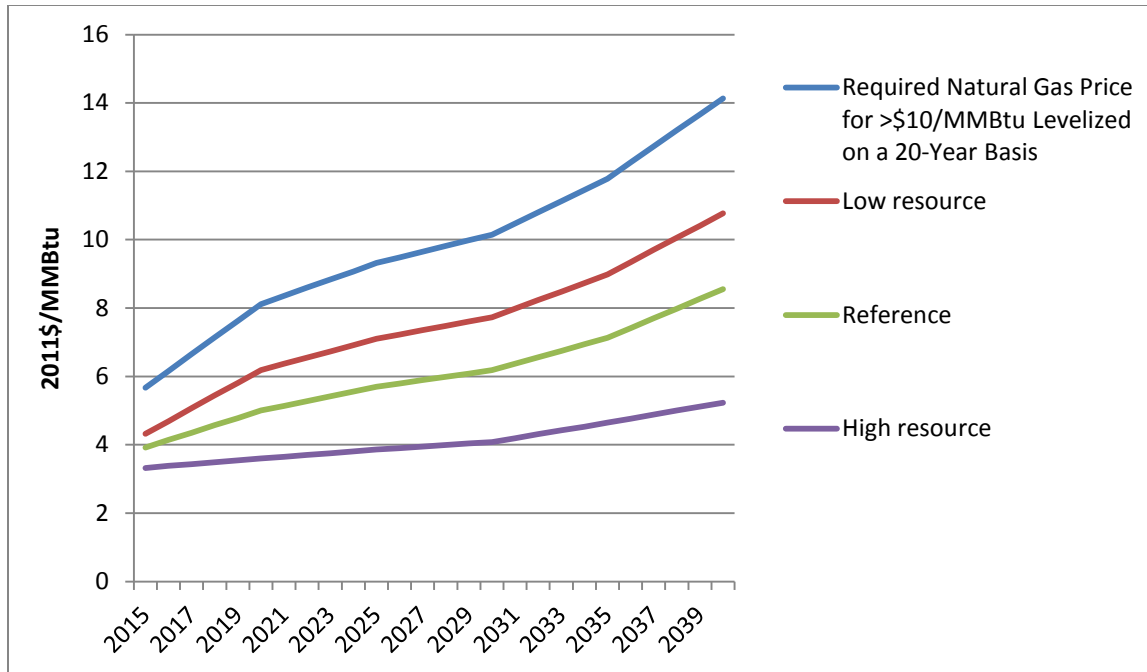

**Figure 5-5. Projected Real National Delivered Natural Gas Price for Select AEO 2013 Scenarios and Illustrative Path for > \$10/MMBtu Levelized Cost**

To conclude the comparison of NGCC with uncontrolled coal-fired alternatives, it is important to note that the LCOE calculations are based on assumptions regarding the average national cost of generation at new facilities. It is known that there is significant spatial variation in the costs of new generation due to design differences, labor wage and productivity differences, and delivered fuel prices among other potential factors.<sup>52</sup>

For example, EIA utilizes capital cost scalars to capture regional differences in labor, material, and construction costs. The minimum and maximum capital cost scalars across all regions in AEO 2013 for SCPC, IGCC, and NGCC build options are presented below in Table 5-7.<sup>53</sup>

**Table 5-7. AEO 2013 Regional Capital Cost Scalars by Capacity Type**

Capacity Type	Minimum Capital Cost Scalar	Maximum Capital Cost Scalar
SCPC	0.885	1.152
IGCC	0.908	1.136
NGCC	0.893	1.205

<sup>52</sup> [http://www.eia.gov/oiaf/beck\\_plantcosts/pdf/updatedplantcosts.pdf](http://www.eia.gov/oiaf/beck_plantcosts/pdf/updatedplantcosts.pdf)

<sup>53</sup> Excluding the New York City and Long Island areas, as well as those areas of the country that prohibit the development of new, uncontrolled coal-fired facilities.



Applying the regional capital cost scalars displayed above to the base LCOE estimates developed earlier in this section produces only a small change in the relative competitiveness of the technologies as seen in Table 5-8.

**Table 5-8. LCOE Estimates with Minimum and Maximum AEO 2013 Regional Capital Cost Scalars (2011\$/MWh)**

Capacity Type	Reference (w/ 3% CUA)	Minimum Capital Cost Scalar	Maximum Capital Cost Scalar
SCPC	92	86	100
IGCC	112	106	120
NGCC	59	58	62

The LCOE of SCPC in the lowest capital cost region still results in an LCOE that is ~40% higher than an NGCC located in the most expensive capital cost region. IGCC remains more than 70% higher under a similar adjustment. In addition to the relatively small changes in LCOE displayed above, the relative movement in LCOE that can be attributed to regional variations in capital cost is further muted by the fact that a high or low capital cost region for coal-fired build types is projected to be a high or low capital cost region for gas-fired build types. Due to its capital-intensive nature, the most favorable regions for development of new coal-fired capacity over NGCC are the lowest cost areas – an assumption that only narrows NGCC’s LCOE advantage by \$5/MWh for both SCPC and IGCC. To completely negate the base \$33/MWh LCOE advantage of NGCC over SCPC solely with a reduction in coal-fired capital costs, overnight capital costs for SCPC would have to be reduced from \$2,452/kW to ~\$800/kW; IGCC overnight capital costs would have to be reduced to ~\$500/kW.

The other primary driver in determining the regional impact on competitiveness of new build options is delivered fuel prices. As part of the AEO, EIA releases electric power projections – including fuel prices – for each of the 22 Electricity Market Module (EMM) regions. The two regions with the highest projected 2020 natural gas prices in the AEO 2013 are the Western Electricity Coordinating Council/Southwest (‘Southwest’) and the Florida Reliability Coordinating Council (FRCC). The 20-year levelized natural gas and coal price forecasts (2020-2039) in the AEO 2013 reference case are displayed in Figure 5-6 for both regions.

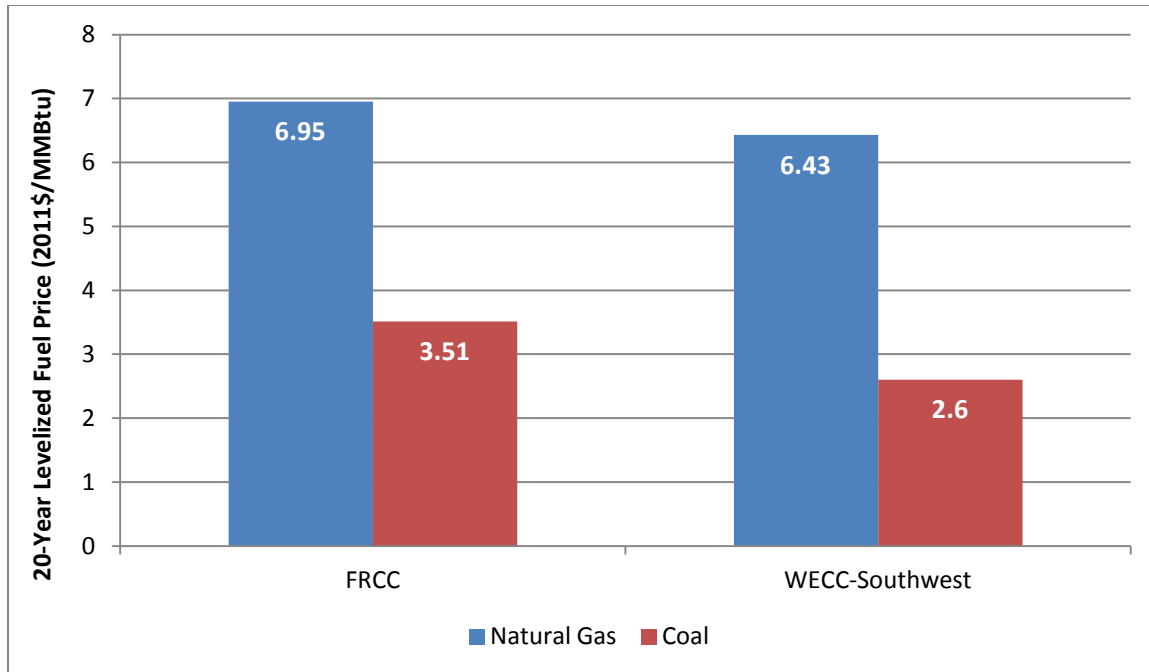

**Figure 5-6. Levelized Regional Fuel Price from AEO 2013 Reference Case, 2020-2039 (2011\$/MMBtu)<sup>54</sup>**

While the FRCC region experiences the highest overall natural gas prices, the Southwest region realizes a greater \$/MMBtu differential between coal and natural gas prices under the AEO projections; the impact on the LCOE of SCPC, IGCC, and NGCC is reported in Table 5-9 for both sets of fuel prices.

**Table 5-9. LCOE Estimates For Minimum and Maximum AEO 2013 Regional Capital Cost Scalars (2011\$/MWh)**

Capacity Type	Reference (w/ 3% CUA)	FRCC Fuel Prices	Southwest Fuel Prices
SCPC (w/ 3% CUA)	92	97	89
IGCC (w/ 3% CUA)	112	117	109
NGCC	59	65	62

Due to the greater fuel price differential, the more favorable region for the development of coal-fired facilities from an LCOE perspective is the Southwest, where the regional fuel prices reduce the LCOE advantage of NGCC to \$27/MWh over SCPC and \$47/MWh over IGCC.

<sup>54</sup> Assuming 5% discount rate.

In conclusion, even the most favorable combination of regional variability in capital costs and delivered fuel prices represented by EIA are insufficient to support new, unplanned, conventional coal-fired capacity in the analysis period.

#### **5.5.5 Levelized Cost of Electricity of Uncontrolled Coal and Coal with Carbon Capture and Storage (CCS)**

The power sector continues to move away from the construction of coal-fired power plants in favor of natural gas-fired power plants due, in part, to the significant LCOE differential explored in the previous section. Even so, it is possible that a limited number of conventional coal-fired power plants might be constructed in the analysis period. In these circumstances, EPA believes that any requirement for CCS could be accommodated and would not, based on the incremental cost of the CCS portion of the new unit, preclude the construction of the new coal-fired facility.<sup>55</sup>

One factor in this determination is the availability of ER opportunities for new coal-fired facilities. ER, which includes both EOR and EGR, refers to the injection of fluids into a reservoir to increase oil and/or gas production efficiency. CO<sub>2</sub>-EOR has been successfully used at many production fields throughout the United States. The oil and natural gas industry in the United States has over 40 years of experience in injection and monitoring of CO<sub>2</sub>. This experience provides a strong foundation for the technologies used in the deployment of CCS on coal-fired electric generating units. Although deep saline formations provide the most CO<sub>2</sub> storage opportunity (2,102 to 20,043 billion metric tons), oil and gas reservoirs are estimated to have 226 billion metric tons of CO<sub>2</sub> storage resource.<sup>56</sup>

The use of CO<sub>2</sub> for EOR can significantly lower the cost of implementing CCS. The opportunity to sell the captured CO<sub>2</sub> rather than paying directly for its long-term storage, greatly improves the economics of the new generating unit. According to the International Energy Agency, of the CCS projects under construction or at an advanced stage of planning, 70% intend to use captured CO<sub>2</sub> to improve recovery of oil in mature fields, including Southern Company's Kemper County Energy Facility, Summit Power's Texas Clean Energy Project, and the Hydrogen Energy California Project.

---

<sup>55</sup> The preamble provides a complete list of existing sources that have demonstrated CCS as well as new coal-fired facilities that will utilize CCS and are very near to completion.

<sup>56</sup> U.S. Department of Energy National Energy Technology Laboratory (2012). United States Carbon Utilization and Storage Atlas, Fourth Edition.

There are two EOR opportunities presented in Figure 5-16 – ‘High’ and ‘Low.’ The high EOR opportunity assumes a CO<sub>2</sub> sale price of \$40 per metric ton; the low EOR opportunity assumes a CO<sub>2</sub> sale price of \$20 per metric ton.<sup>57</sup> For either opportunity, it is assumed that the facility is only responsible for the costs of transmitting the captured CO<sub>2</sub> to the fence line, as is currently the practice.<sup>58</sup> Costs for the transportation, storage, and monitoring (TSM) of CO<sub>2</sub> are included in this analysis. For non-EOR applications, TSM costs of ~\$5-\$15 dollars per ton of CO<sub>2</sub> are applied based on the level of capture.<sup>59</sup> Figure 5-7 compares the LCOE for uncontrolled coal to coal with partial CCS both with and without EOR. Although this proposal has determined partial CCS is BSER for affected coal-fired facilities, the LCOE associated with full capture is presented as well for illustrative purposes.

---

<sup>57</sup> The High and Low CO<sub>2</sub> sale prices utilized by EPA are consistent with NETL’s Base Case and Low Case sale prices, respectively ([http://www.netl.doe.gov/energy-analyses/pubs/storing%20co2%20w%20eor\\_final.pdf](http://www.netl.doe.gov/energy-analyses/pubs/storing%20co2%20w%20eor_final.pdf)). In addition, this range is broadly consistent with the CO<sub>2</sub> sale price data collected by the Department of Interior for projects located on federal lands (<http://statistics.onrr.gov/ReportTool.aspx>). Prices are expressed in 2011\$ and the price is expected to be static over time.

<sup>58</sup> For EOR applications the point of sale is typically the facility fence line, in which case the coal facility operator will avoid the TSM cost. Consequently, the economic benefit of EOR may be greater than simply the price paid for CO<sub>2</sub>.

<sup>59</sup> This range is broadly consistent with estimates provided by NETL ([http://www.netl.doe.gov/energy-analyses/pubs/QGESS\\_CO2T%26S\\_Rev2\\_20130408.pdf](http://www.netl.doe.gov/energy-analyses/pubs/QGESS_CO2T%26S_Rev2_20130408.pdf)) and the Global CCS Institute (<http://www.globalccsinstitute.com/publications/economic-assessment-carbon-capture-and-storage-technologies-2011-update>).

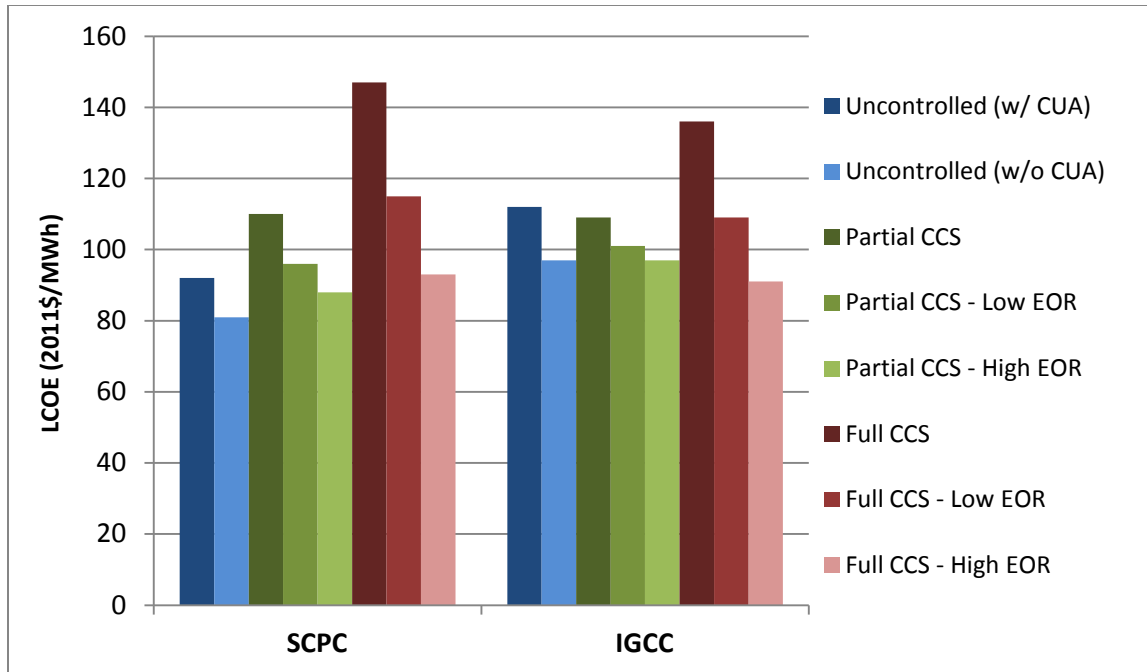

**Figure 5-7. Levelized Cost of Electricity, Uncontrolled Coal and Coal with Full and Partial CCS (1,100 lbs/MWh gross)**

NOTE: EIA estimated LCOE under AEO 2013 assumptions for full capture SCPC+CCS is estimated at a LCOE of \$134 without EOR. No estimate is provided for IGCC+CCS or partial capture technologies.<sup>60</sup>

EPA believes the opportunity to engage in EOR opportunities is not significantly limited by the location of those opportunities or the current CO<sub>2</sub> pipeline infrastructure (12 states currently have existing or under construction CO<sub>2</sub> pipelines). Provision of electric power does not require coal-fired facilities to be co-located with the demand it is intended to serve. Please refer to Chapter 4 for a more detailed discussion of ER, including its geographic availability, expected future growth, and overall impact on the economics of CCS.

### 5.5.6 Levelized Cost of Electricity of Coal with Carbon Capture and Storage and Nuclear

There are five nuclear units currently under construction in the United States – Vogtle Units 3 and 4, Summer Units 2 and 3, and Watts Bar 2 – as well as nine active applications under U.S. Nuclear Regulatory Commission (NRC) review covering an additional 14 potential units. The addition of Units 3 and 4 at Georgia Power’s Plant Vogtle will be the first new nuclear units built in the United States in 30 years. Although it is unlikely that all of the proposed nuclear projects will be built, the renewed interest in new nuclear facilities – despite persistently high capital costs – is driven by a host of factors, including climate and air quality

<sup>60</sup> [http://www.eia.gov/forecasts/aeo/electricity\\_generation.cfm](http://www.eia.gov/forecasts/aeo/electricity_generation.cfm)

concern, the value attached to fuel diversity, regional or local base load capacity needs, and supportive regulatory environments.

As shown in Figure 5-8 on an LCOE basis, the cost of new nuclear is similar to the cost of new coal with partial CCS without EOR. Factoring in the revenues associated with the low EOR opportunity (\$20 per ton of CO<sub>2</sub> and no transportation storage and monitoring – TSM – obligation) reduces the cost of coal with CCS to levels that are 6-10% lower than new nuclear; assuming a high EOR opportunity (\$40 per ton of CO<sub>2</sub> and no TSM obligation) reduces the cost of SCPC with CCS and IGCC with CCS to 18% and 9% below new nuclear, respectively. The current activity related to new nuclear development at a cost that is broadly similar to coal with CCS is a demonstration of the industry’s willingness to develop higher cost projects that produce low-emitting base load capacity that contributes to fuel diversity.

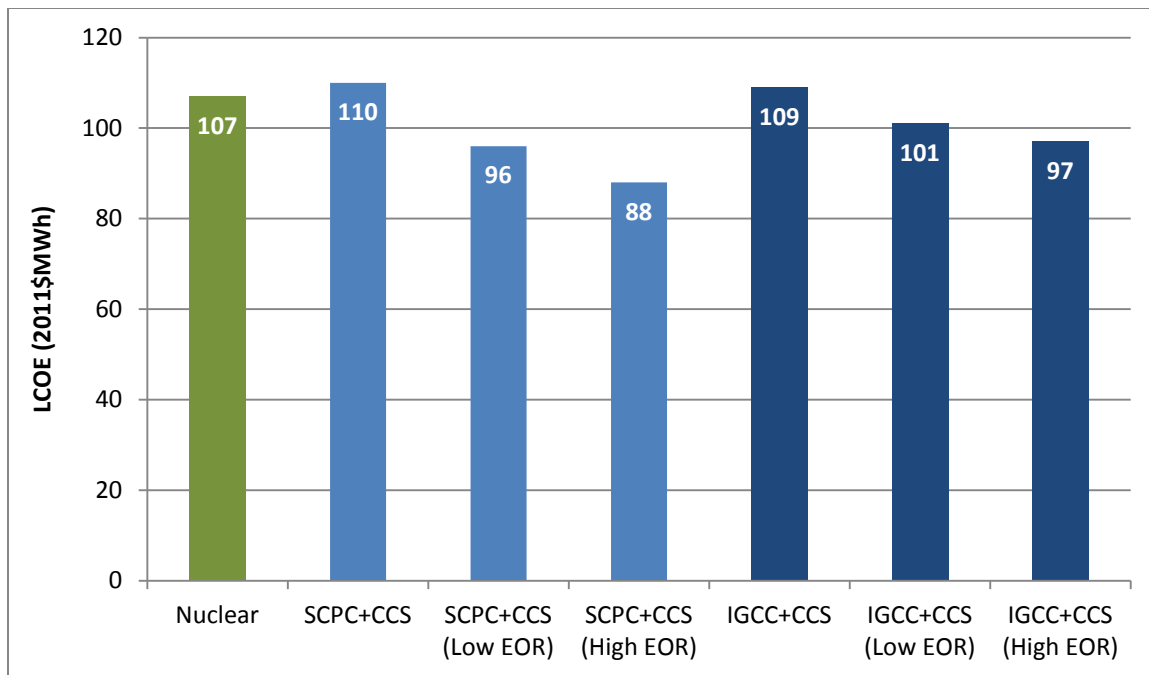

**Figure 5-8. Levelized Cost of Electricity, Nuclear and Coal with Partial CCS (1,100 lbs/MWh gross)**

### 5.5.7 Levelized Cost of Simple Cycle Combustion Turbine and Natural Gas Combined Cycle

CTs fulfill a fundamentally different function in power sector operations than that of NGCC and coal-fired facilities. CTs are designed to start quickly in order to meet demand for electricity during peak operating periods and are generally less expensive to build (on a capital cost basis) but are also less fuel efficient than combined cycle technology, (which employs heat recovery systems). Due to lower fuel efficiencies, CTs produce a significantly higher cost of

electricity (cost per kWh) at higher capacity factors and consequently are typically utilized at levels well below the proposed threshold for sources affected by the proposed EGU New Source GHG Standards (1/3 of potential electric output). Instead, these units are most often built to ensure reserve margins are met during peak periods (typically in the summer), and in some instances are able to generate additional revenues by selling capacity into power markets. Thus, in practice, EPA expects that potential CT units would not meet the applicability threshold in this proposed action and would not be subject to any standard.

Mirroring real world behavior, relatively low levels of CT generation are projected in both EPA and EIA modeling frameworks. AEO 2013 projects a capacity factor for CTs of less than 20% in all regions and in all years. EPA's IPM modeling projects a capacity factor for individual new CTs of 8.5% or less in all simulation years. Thus, these potential new units do not meet the applicability threshold for this proposal, and there is no projected cost or emissions impact on new CT units.

To illustrate the economic impracticality of utilizing combustion turbines in an intermediate and base load mode of operation, Figure 5-18 displays the LCOE estimates for a CT and NGCC at increasing capacity factors. The estimates utilize the AEO2013 Reference Case natural gas price for 2014 (representative of the lowest – and therefore most favorable to the relative levelized cost of a CT – natural gas price during the analysis period).

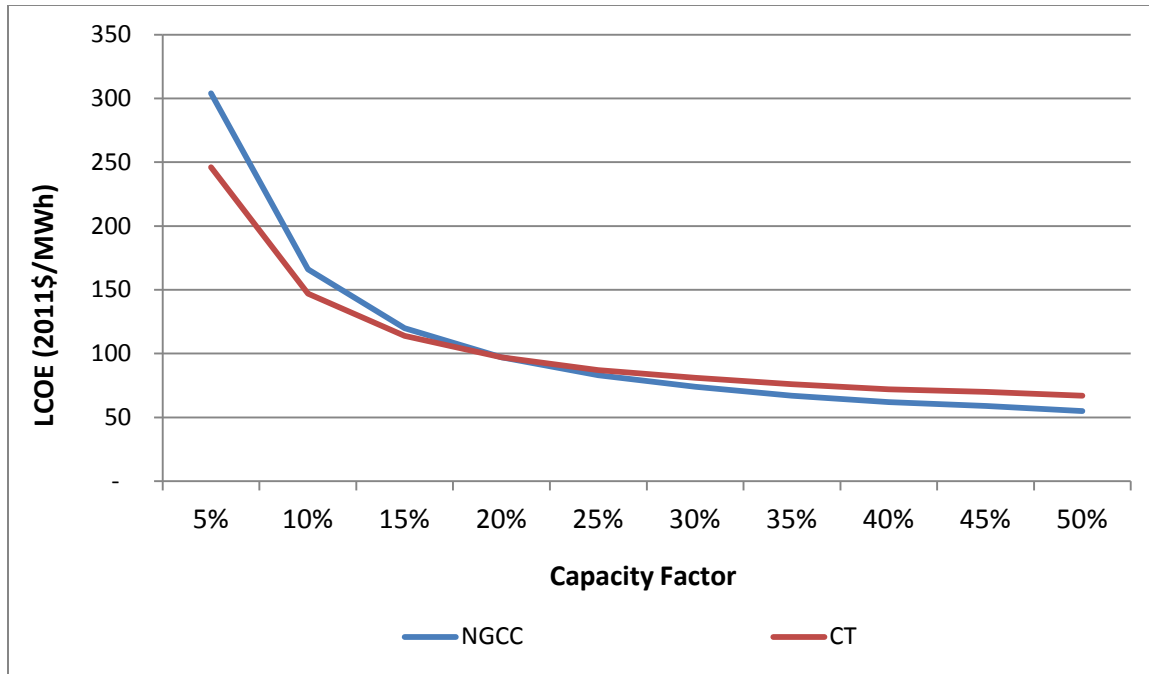

**Figure 5-9. Levelized Cost of Electricity Across a Range of Capacity Factors, CT and NGCC (\$2011/MWh at \$3.84/MMBtu Levelized Natural Gas Price)**

In the LCOE figure above, utilizing a CT for generation is less expensive than an NGCC only at capacity factors of less than 20%.<sup>61</sup> If expected utilization is greater than 20%, it can reasonably be expected that a utility or developer would seek to deploy NGCC over CT for a host of economic, environmental, and technical reasons. Unanticipated short term utilization of CTs above a 33% capacity factor would not be expected to alter this dynamic as utilization is evaluated over a 3-year averaging period to determine the applicability of the proposed standards.

## 5.6 Comparison of Emissions from Generation Technologies

As discussed earlier in this chapter, NGCC units are on average expected to be more economical to build and operate than new coal units. These natural gas units also have lower emission profiles for CO<sub>2</sub> and criteria air pollutants than new coal units. While the proposed EGU New Source GHG Standards is anticipated to have negligible costs or quantified benefits under a range of likely market conditions, it is instructive to consider the differences in emissions of CO<sub>2</sub> and other air pollutants between the two types of units.

<sup>61</sup> CT cost, performance, and financial assumptions from AEO 2013.



As Table 5-19 below shows, emissions from a typical new NGCC unit are significantly lower than those from a new coal unit.<sup>62</sup> For example, a typical new supercritical pulverized coal facility that burns bituminous coal in compliance with new utility regulations (e.g., MATS) would have considerably greater CO<sub>2</sub>, SO<sub>2</sub>, NO<sub>x</sub>, toxic metals, acid gases, and particulate emissions than a comparable natural gas combined cycle facility. A typical natural gas combined cycle unit emits two million metric tons less CO<sub>2</sub> per year than a typical new conventional coal unit, as well as 2,000 fewer short tons SO<sub>2</sub> and about 1,200 fewer short tons of NO<sub>x</sub> each year. Importantly, these differences in emissions assume a new coal unit that complies with all applicable final regulations, including MATS. Reductions in SO<sub>2</sub> emissions are a particularly significant driver for monetized health benefits, as SO<sub>2</sub> is a precursor to the formation of particulates in the atmosphere, and particulates are associated with premature death and other serious health effects. Further information on these pollutants' health effects is included in the next subsection.

**Table 5-10. Illustrative Emissions Profiles, New Coal and Natural Gas-Fired Generating Units**

	<i>Natural Gas CC</i>		<i>SCPC</i>		<i>SCPC+CCS (1,100 lbs/MWh Gross)</i>		<i>IGCC</i>		<i>IGCC+CCS (1,100 lbs/MWh Gross)</i>	
	Emissions (tons/year)	Emission Rate (lbs/MWh net)	Emissions (tons/year)	Emission Rate (lbs/MWh net)	Emissions (tons/year)	Emission Rate (lbs/MWh net)	Emissions (tons/year)	Emission Rate (lbs/MWh net)	Emissions (tons/year)	Emission Rate (lbs/MWh net)
SO <sub>2</sub>	10	0.0041	1,700	0.74	1,100	0.48	23	0.010	30	0.013
NO <sub>x</sub>	130	0.060	1,400	0.61	1,500	0.69	1,200	0.52	1,200	0.52
CO <sub>2</sub>	1.7 million	800	4.0 million	1,800	2.7 million	1,200	3.8 million	1,700	3.0 million	1,400

Notes: SO<sub>2</sub> and NO<sub>x</sub> in short tons, CO<sub>2</sub> in metric tons. Values rounded to two significant digits. Emission characteristics are based on, and thus consistent with the cost and performance assumptions of, the illustrative units described in LCOE analysis above (e.g., that these are base load units running at 85 percent capacity factor, all coal units are assumed to be using bituminous coal with a sulfur content of 2.8% dry, etc.). Here we further assume all units are of the same capacity (600 MW net). Utilizing a consistent net capacity metric across plant types requires a higher gross capacity for those types with greater need for auxiliary power. The tons of emissions associated with a facility are driven by gross capacity.

## 5.7 Benefits of Reducing GHGs and Other Pollutants

Society is not only affected by differences in the private generating costs of different technologies, it also experiences the benefit or the burden of relative differences in emissions

<sup>62</sup> Estimated emissions of CO<sub>2</sub>, SO<sub>2</sub>, and NO<sub>x</sub> for the illustrative new coal and natural gas combined cycle units could vary depending on a variety of assumptions including heat rate, fuel type, and emission controls, to name a few.

produced by these generation technologies. As such, the appropriate social welfare comparison should also account for the health, ecological and other emissions impacts of different generation technologies. In particular, emissions of CO<sub>2</sub> and other pollutants lead to additional social costs of these technologies. Any relative differences in these emissions between newly built electric generating technologies would translate into relative climate-related and human health benefits. This section provides a general discussion about how the climate-related and human health benefits of emission reductions are estimated.

### **5.7.1 Social Cost of Carbon**

The social cost of carbon (SCC) is a metric that estimates the monetary value of impacts associated with marginal changes in CO<sub>2</sub> emissions in a given year. It is intended to include (but is not limited to) changes in net agricultural productivity, human health, property damages from increased flood risk, and the value of ecosystem services due to climate change. It is typically used to assess the avoided damages, i.e. benefits, of rulemakings that achieve marginal reductions in CO<sub>2</sub> emissions. This analysis applies SCC to illustrate the value of the difference in CO<sub>2</sub> emissions among different generation technologies discussed in Section 5.5.

The federal government typically uses the SCC to estimate the social benefits of CO<sub>2</sub> reductions from regulatory actions that impact cumulative global emissions. An interagency process that included the EPA and other executive branch entities used three integrated assessment models (IAMs) to develop SCC estimates and selected four global values for use in regulatory analyses. Three values are based on the average SCC from the three IAMs, at discount rates of 5, 3, and 2.5 percent. SCCs at several discount rates are included because the literature shows that the SCC is quite sensitive to assumptions about the discount rate, and because no consensus exists on the appropriate rate to use in an intergenerational context (where costs and benefits are incurred by different generations). The fourth value is the 95th percentile of the SCC from all three models at a 3 percent discount rate. It is included to represent higher-than-expected impacts from temperature change further out in the tails of the SCC distribution (representing less likely, but potentially catastrophic, outcomes). The SCC Technical Support Document (SCC TSD) provides a complete discussion of the methods used to develop these estimates.<sup>63</sup>

---

<sup>63</sup> Docket ID EPA-HQ-OAR-2009-0472-114577, *Technical Support Document: Social Cost of Carbon for Regulatory Impact Analysis Under Executive Order 12866, Interagency Working Group on Social Cost of Carbon*, with participation by Council of Economic Advisers, Council on Environmental Quality, Department of Agriculture, Department of Commerce, Department of Energy, Department of Transportation, Environmental Protection Agency, National Economic Council, Office of Energy and Climate Change, Office of Management and Budget,

The federal government recently updated these estimates, using new versions of each integrated assessment model and published them in May 2013. The 2013 process did not revisit the 2010 interagency modeling decisions (e.g., with regard to the discount rate, reference case socioeconomic and emission scenarios or equilibrium climate sensitivity). Rather, improvements in the way damages are modeled are confined to those that have been incorporated into the latest versions of the models by the developers themselves and used in peer-reviewed publications. The model updates that are relevant to the SCC estimates include: an explicit representation of sea level rise damages in the Dynamic Integrated Climate and Economy (DICE) and Policy Analysis of the Greenhouse Effect (PAGE) models; updated adaptation assumptions, revisions to ensure damages are constrained by GDP, updated regional scaling of damages, and a revised treatment of potentially abrupt shifts in climate damages in the PAGE model; an updated carbon cycle in the DICE model; and updated damage functions for sea level rise impacts, the agricultural sector, and reduced space heating requirements, as well as changes to the transient response of temperature to the buildup of GHG concentrations and the inclusion of indirect effects of methane emissions in the Climate Framework for Uncertainty, Negotiation, and Distribution (FUND) model.<sup>64</sup>

The SCC estimates from the updated versions of the models are higher than those reported in the 2010 TSD, which were used in the April 2012 EGU New Source GHG Standards RIA. By way of comparison, the four 2020 SCC estimates reported in the 2010 TSD and used in the April 2012 EGU New Source GHG Standards proposal were \$7, \$28, \$44 and \$86 per metric ton (2011\$). The corresponding four updated SCC estimates for 2020 are \$13, \$46, \$69, and \$138 per metric ton (2011\$).<sup>65,66</sup>

---

Office of Science and Technology Policy, and Department of Treasury (February 2010). Also available at <http://www.whitehouse.gov/sites/default/files/omb/inforeg/for-agencies/Social-Cost-of-Carbon-for-RIA.pdf>

<sup>64</sup> Docket ID EPA-HQ-OAR-2013-0495, *Technical Support Document: Technical Update of the Social Cost of Carbon for Regulatory Impact Analysis Under Executive Order 12866*, Interagency Working Group on Social Cost of Carbon, with participation by Council of Economic Advisers, Council on Environmental Quality, Department of Agriculture, Department of Commerce, Department of Energy, Department of Transportation, Environmental Protection Agency, National Economic Council, Office of Energy and Climate Change, Office of Management and Budget, Office of Science and Technology Policy, and Department of Treasury (May 2013). Also available at [http://www.whitehouse.gov/sites/default/files/omb/inforeg/social\\_cost\\_of\\_carbon\\_for\\_ria\\_2013\\_update.pdf](http://www.whitehouse.gov/sites/default/files/omb/inforeg/social_cost_of_carbon_for_ria_2013_update.pdf)

<sup>65</sup> The 2010 and 2013 TSDs present SCC in \$2007. The estimates were adjusted to \$2011 using GDP Implicit Price Deflator, <http://www.gpo.gov/fdsys/pkg/ECONI-2013-02/pdf/ECONI-2013-02-Pg3.pdf>.

<sup>66</sup> The 2010 SCC TSD concluded that a global measure of the benefits from reducing U.S. emissions is preferable. The development of a domestic SCC is greatly complicated by the relatively few region- or country-specific estimates of SCC in the literature. See Interagency Working Group on Social Cost of Carbon. 2010. *Technical Support Document: Social Cost of Carbon for Regulatory Impact Analysis Under Executive Order 12866*.

When attempting to assess the incremental economic impacts of carbon dioxide emissions, the analyst faces a number of serious challenges. A report from the National Academies of Science (NRC 2009) points out that any assessment will suffer from uncertainty, speculation, and lack of information about (1) future emissions of greenhouse gases, (2) the effects of past and future emissions on the climate system, (3) the impact of changes in climate on the physical and biological environment, and (4) the translation of these environmental impacts into economic damages.<sup>67</sup> As a result, any effort to quantify and monetize the harms associated with climate change will raise serious questions of science, economics, and ethics and should be viewed as provisional.

The 2010 SCC TSD noted a number of limitations to the SCC analysis, including the incomplete way in which the integrated assessment models capture catastrophic and non-catastrophic impacts, their incomplete treatment of adaptation and technological change, uncertainty in the extrapolation of damages to high temperatures, and assumptions regarding risk aversion. Current integrated assessment models do not assign value to all of the important physical, ecological, and economic impacts of climate change recognized in the climate change literature because of a lack of precise information on the nature of damages and because the science incorporated into these models understandably lags behind the most recent research. The limited amount of research linking climate impacts to economic damages makes the interagency modeling exercise even more difficult.

While the new versions of the models used to estimate the values presented below offer some improvements in these areas, further work remains warranted. Accordingly, the EPA and other agencies continue to engage in research on modeling and valuation of climate impacts with the goal to improve these estimates. Additional details are provided in the SCC TSDs.

Table 5-11 presents the updated global SCC estimates for the years 2015 to 2050. In order to calculate the dollar value for emission reductions, the SCC estimate for each emissions year would be applied to changes in CO<sub>2</sub> emissions for that year, and then discounted back to the analysis year using the same discount rate used to estimate the SCC.<sup>68</sup> The SCC increases

---

<sup>67</sup> National Research Council (2009). *Hidden Costs of Energy: Unpriced Consequences of Energy Production and Use*. National Academies Press. See docket ID EPA-HQ-OAR-2009-0472-11486.

<sup>68</sup> This analysis considered the climate impacts of only CO<sub>2</sub> emission change, as the U.S. Interagency Working Group on the Social Cost of Carbon has thus far only considered estimates for the social cost of CO<sub>2</sub>. While CO<sub>2</sub> is the dominant GHG emitted by the sector, we recognize the representative facilities within these comparisons may also have different emission rates for other climate forcers which will serve a minor role in determining the overall social cost of generation.

over time because future emissions are expected to produce larger incremental damages as physical and economic systems become more stressed in response to greater climate change. Note that the interagency group estimated the growth rate of the SCC directly using the three integrated assessment models rather than assuming a constant annual growth rate. This helps to ensure that the estimates are internally consistent with other modeling assumptions.

**Table 5-11. Social Cost of CO<sub>2</sub>, 2015-2050<sup>a</sup> (in 2011\$)**

Year	Discount Rate and Statistic			
	5% Average	3% Average	2.5% Average	3% 95 <sup>th</sup> percentile
2015	\$13	\$41	\$62	\$116
2020	\$13	\$46	\$69	\$138
2025	\$15	\$51	\$75	\$154
2030	\$17	\$55	\$81	\$170
2035	\$20	\$61	\$86	\$188
2040	\$22	\$66	\$93	\$205
2045	\$26	\$70	\$98	\$220
2050	\$29	\$76	\$105	\$236

<sup>a</sup> The SCC values vary depending on the year of CO<sub>2</sub> emissions and are defined in real terms. These SCC values are stated in \$/metric ton.

### 5.7.2 Health Co-Benefits of SO<sub>2</sub> and NO<sub>x</sub> Reductions

Reducing power sector CO<sub>2</sub> under this rule would also result in reductions of SO<sub>2</sub> and NO<sub>x</sub> emissions, which in turn would yield health benefits (we refer to these additional benefits as “co-benefits”). SO<sub>2</sub> is a precursor for fine particulate matter (PM<sub>2.5</sub>) formation while NO<sub>x</sub> is a precursor for PM<sub>2.5</sub> and ground-level ozone formation. As such, reductions of SO<sub>2</sub> and NO<sub>x</sub> would in turn lower overall ambient concentrations of PM<sub>2.5</sub> and ozone. Reducing exposure to PM<sub>2.5</sub> and ozone is associated with significant human health benefits including avoided mortality and morbidity. Researchers have associated PM<sub>2.5</sub> and ozone exposure with adverse health effects in numerous toxicological, clinical, and epidemiological studies (U.S. EPA, 2009; U.S. EPA, 2013b). Health effects associated with exposure to PM<sub>2.5</sub> include premature mortality for adults and infants, cardiovascular morbidity such as heart attacks and hospital admissions, and respiratory morbidity such as asthma attacks, bronchitis, hospital and emergency room visits, work loss days, restricted activity days, and respiratory symptoms. Health effects associated with exposure to ozone include premature mortality and respiratory morbidity such as hospital admissions, emergency room visits, and school loss days. In addition to human health co-benefits associated with PM<sub>2.5</sub> and ozone exposure, reducing SO<sub>2</sub> and NO<sub>x</sub> emissions under this rule would result in reduced health impacts from direct exposure to these pollutants.

Reducing SO<sub>2</sub> and NO<sub>x</sub> emissions would also result in other human welfare (non-health) improvements including improvements in ecosystem services. SO<sub>2</sub> and NO<sub>x</sub> emissions can adversely impact vegetation and ecosystems through acidic deposition and nutrient enrichment, and can affect certain manmade materials, visibility, and climate (U.S. EPA, 2009; U.S. EPA, 2008).

For a full discussion of the human health, ecosystem and other benefits of reducing SO<sub>2</sub> and NO<sub>x</sub> emissions from power sector sources, please refer to the RIA for MATS (U.S. EPA, 2011).

The avoided incidences of health effects and monetized value of health or non-health improvements that result from SO<sub>2</sub> and NO<sub>x</sub> emissions reductions depend on the location of those reductions. However, when assessing the co-benefits of differences in emissions from different generation technologies in the following sections, the EPA does not assert a specific location for the new unit. As a result, the EPA does not have the data to perform a full health impact assessment for a specific modeled scenario.<sup>69</sup> Instead, the EPA relied on a national-average benefit per-ton (BPT) method to estimate PM<sub>2.5</sub>-related health impacts of SO<sub>2</sub> and NO<sub>x</sub> emissions. The BPT approach provides an estimate of the total monetized human health benefits (the sum of premature mortality and morbidity) of reducing one ton of PM<sub>2.5</sub> precursor (i.e., NO<sub>x</sub> and SO<sub>2</sub>) from the sector. To develop the BPT estimates used in this analysis the EPA utilized detailed air quality modeling of power sector SO<sub>2</sub> and NO<sub>x</sub> emissions along with the BenMAP model<sup>70</sup> to estimate the benefits of air quality improvements using projected 2020 population, baseline incidence rates, and economic factors.

The SO<sub>2</sub>- and NO<sub>x</sub>-related BPT estimates utilized in this analysis are derived from the Technical Support Document (TSD) on estimating the BPT of reducing PM<sub>2.5</sub> and its precursors (U.S. EPA, 2013a). These BPT values are estimated in a methodologically consistent manner with those reported in Fann et al. (2012). They differ from those reported in Fann et al. (2012) as they reflect the health impact studies and population data updated in the benefits analysis of the final PM NAAQS RIA (U.S. EPA, 2012). The recalculation of the Fann et al. (2012) BPT values based on the updated data from the PM NAAQS RIA (U.S. EPA, 2012) is described in the TSD (U.S. EPA, 2013a).

---

<sup>69</sup> If the EPA conjectured a location for a particular new unit it may be possible to perform a full health impact assessment of different technologies at that location. Doing so for a number of locations is beyond the scope of this analysis and would be better captured in sector-wide modeling. For more information on the EPA's methods for conducting health impact assessments, please refer to Chapter 5 of the final PM NAAQS RIA. (U.S. EPA, 2012)

<sup>70</sup> Available at <http://www.epa.gov/air/benmap>.

Despite our attempts to quantify and monetize as many of the co-benefits of reducing emissions from electricity generating sources as possible, not all known health and non-health co-benefits from reducing SO<sub>2</sub> and NO<sub>x</sub> are accounted for in this assessment. For more information about unquantified health and non-health co-benefits of SO<sub>2</sub> and NO<sub>x</sub> please refer to tables 5-2 and 6-2 of the PM NAAQS RIA (U.S. EPA, 2012), respectively. Furthermore, the analysis that follows does not account for known differences in the emissions of other air and water pollutants between the different generating technologies, including, for example, directly-emitted PM.

As we do not conjecture a specific location for the new units being compared, this RIA is unable to include the type of detailed uncertainty assessment found in the PM NAAQS RIA (U.S. EPA, 2012). However, the results of the uncertainty analyses presented in the PM NAAQS RIA can provide some information regarding the uncertainty inherent in the benefits results presented in this analysis. In addition to these uncertainties, use of BPT estimates come with additional uncertainty. Specifically, all national-average BPT estimates reflect a specific geographic distribution of SO<sub>2</sub> and NO<sub>x</sub> reductions resulting in a specific reduction in PM<sub>2.5</sub> exposure and may not fully reflect local or regional variability in population density, meteorology, exposure, baseline health incidence rates, or other factors that might lead to an over-estimate or under-estimate of the actual benefits associated with PM<sub>2.5</sub> precursors in a specific location. These estimates are purely illustrative as the EPA does not assert a specific location for the illustrative electricity generation technologies and is therefore unable to specifically determine the population that would be affected by their emissions. Therefore, the benefits for any specific unit can be different than the estimates shown here.

Notwithstanding these limitations, reducing one thousand tons of annual SO<sub>2</sub> from U.S. power sector sources has been estimated to yield between 4 and 9 incidences of premature mortality avoided and monetized PM<sub>2.5</sub>-related health benefits (including these incidences of premature mortality avoided) between \$38 million and \$85 million in 2020 (2011\$) using a 3% discount rate or between \$34 million and \$76 million (2011\$) using a 7% discount rate. Additionally, reducing one thousand tons of annual NO<sub>x</sub> from U.S. EGUs has been estimated to yield up to 1 incidence of premature mortality avoided and monetized PM<sub>2.5</sub>-related health benefits (including these incidences of premature mortality avoided) of between \$5.5 million and \$12 million in 2020 (2011\$) using a 3% discount rate or between \$5.0 million and \$11 million (2011\$) using a 7% discount rate. For each pollutant, the range of estimated benefits for each discount rate is due to the EPA's use of two alternative primary estimates of PM<sub>2.5</sub>-related

mortality impacts: a lower primary estimate based on Krewski et al. (2009) and a higher primary estimate based on Lepeule et al. (2012).

**Table 5-12. Monetized Health Co-Benefits Per Ton of PM<sub>2.5</sub> Precursor Reductions in 2020<sup>a</sup> (in 2011\$)**

	PM <sub>2.5</sub> Precursor	
	SO <sub>2</sub>	NO <sub>x</sub>
3% Discount Rate		
Krewski et al. (2009)	\$38,000	\$5,5000
Lepeule et al. (2012)	\$85,000	\$12,000
7% Discount Rate		
Krewski et al. (2009)	\$34,000	\$5,000
Lepeule et al. (2012)	\$76,000	\$11,000

<sup>a</sup> As described in Section 5.7.2, the SO<sub>2</sub>- and NO<sub>x</sub>-related BPT estimates are from the Technical Support Document on Estimating the Benefit Per Ton of Reducing PM<sub>2.5</sub> from 17 Sectors (U.S. EPA, 2013a) and are adjusted to 2011\$.

## 5.8 Comparison of Health and Welfare Impacts from Generation Technologies

As previously discussed in this chapter, the emissions of GHGs and other pollutants associated with new sources of electricity generation are greater for coal-fired units than for natural gas combined cycle units (even when accounting for compliance with MATS). Reducing the emissions associated with electricity generation results in both climate and human health and non-health benefits.

To consider the social benefits associated with the adoption of lower emitting new generation technologies, we determine the differences in emissions in the illustrative emission profiles between technologies in Table 5-10 and apply the 2020 social benefit values discussed in Section 5.7. Specifically, we multiply the difference in CO<sub>2</sub> emissions between two technologies by the estimates of the SCC, multiply the difference in SO<sub>2</sub> and NO<sub>x</sub> emissions by the PM<sub>2.5</sub>-related SO<sub>2</sub> and NO<sub>x</sub> BPT estimates, and add those values to get a measure of 2020 social benefits of the adoption of lower emitting generation technology. We subsequently divide by the number of MWh underlying the emission estimates to derive the social benefits per unit of generation.

Only the direct emissions of CO<sub>2</sub>, SO<sub>2</sub>, and NO<sub>x</sub> are considered in this illustrative exercise. Other air and water pollutants emitted by these technologies and emissions from the extraction and transport of the fuels used by these technologies are not considered. For example, coal has higher mercury emissions than natural gas, but the relative benefits from the difference in mercury emissions are not considered. Furthermore, there may be differences in



upstream greenhouse gas emissions (in particular, methane) from different technologies but those were not quantified for this assessment.

Table 5-13 reports the 2020 incremental climate and health benefits associated with an illustrative new NGCC plant relative to illustrative new SCPC and IGCC coal plants, given different mortality risk studies and assumptions about the discount rate. These incremental benefits should be relatively invariant across natural gas prices and other economic factors. Depending on the discount rate and mortality risk study used, 2020 incremental benefits associated with generation from a representative new natural gas combined cycle unit relative to a new coal unit are \$6.6 to \$95 per MWh (2011\$).<sup>71</sup>

The precise social benefits associated with reduced CO<sub>2</sub> emissions, which are the focus of this rule, depend on the specific fuels used but do not depend on the location of generation because the location of CO<sub>2</sub> emissions does not influence their impact on the evolution of global climate conditions. As with the relative investment costs of a new coal unit and a new natural gas combined cycle system, the precise incremental health co-benefits associated with lower emissions depend on the location under consideration and the specific fuels that would be used. An ideal benefit-cost analysis would account for these local circumstances (and consider alternative sources of generation).

However, these factors will not change the qualitative conclusion. There will always be incremental climate and human health benefits associated with a new natural gas combined cycle unit relative to a new coal unit, independent of the location.

---

<sup>71</sup> Different discount rates are applied to SCC than to the other benefit estimates because CO<sub>2</sub> emissions are long-lived and subsequent damages occur over many years. Moreover, several rates are applied to SCC because the literature shows that it is sensitive to assumptions about discount rate and because no consensus exists on the appropriate rate to use in an intergenerational context. The SCC interagency group centered its attention on the 3 percent discount rate but emphasized the importance of considering all four SCC estimates. See the 2010 SCC TSD. Docket ID EPA-HQ-OAR-2009-0472-114577 or <http://www.whitehouse.gov/sites/default/files/omb/inforeg/for-agencies/Social-Cost-of-Carbon-for-RIA.pdf> for details.

**Table 5-13. 2020 Incremental Benefits (\$/MWh, 2011\$) of Emission Reductions from Illustrative New Natural Gas Combined Cycle Generation *Relative to* New SCPC or IGCC Coal Generation without CCS<sup>72</sup>**

	SCPC	IGCC		
<b>CO<sub>2</sub>-Related Benefits using SCC</b>				
5% Discount Rate	\$5.6	\$5.4		
3% Discount Rate	\$20	\$19		
2.5% Discount Rate	\$31	\$29		
3% Discount Rate (95 <sup>th</sup> percentile)	\$61	\$58		
<b>PM<sub>2.5</sub>-Related Co-Benefits from SO<sub>2</sub> and NO<sub>x</sub> Reductions</b>				
3% discount rate				
Krewski et al. (2009)	\$15	\$1.4		
Lepeule et al. (2012)	\$35	\$3.1		
7% discount rate				
Krewski et al. (2009)	\$14	\$1.2		
Lepeule et al. (2012)	\$31	\$2.8		
<b>Combined CO<sub>2</sub>-Related and PM<sub>2.5</sub>-Related Benefits</b>				
	Discount Rate Applied to PM <sub>2.5</sub> -Related Benefits (range based on adult mortality function)			
SCC Discount Rate	3%	7%	3%	7%
5% Discount Rate	\$21 to \$40	\$20 to \$37	\$6.7 to \$8.5	\$6.6 to \$8.2
3% Discount Rate	\$36 to \$55	\$34 to \$52	\$21 to \$22	\$20 to \$22
2.5% Discount Rate	\$46 to \$65	\$44 to \$62	\$30 to \$32	\$30 to \$32
3% Discount Rate (95 <sup>th</sup> percentile)	\$76 to \$95	\$75 to \$92	\$59 to \$61	\$59 to \$60

Notes: The emission rates and operating characteristics of the units being compared in this table are reported in Table 5.10. Benefits are estimated for a 2020 analysis year. The range of benefits within each SCC value and discount rate for PM<sub>2.5</sub>-related benefits pairing reflects the use of two core estimates of PM<sub>2.5</sub>-related premature mortality.<sup>73</sup> The EPA has evaluated the range of potential impacts per MWh by combining all SCC values with health benefits values at the 3 percent and 7 percent discount rates. To be consistent with concepts of intergenerational discounting, values for health benefits, which occur within a generation, would only be combined with SCC values using a lower discount rate, e.g. the 7 percent health benefit estimates would be combined with 5 percent or lower SCC values, but the 3 percent health benefit would not be combined with the 5 percent SCC value. While the 5 percent SCC and 3 percent health benefit estimate falls within the range of values we analyze, this individual estimate should not be used independently in an analysis, as it represents a combination of discount rates that is unlikely to occur. Combining the 3 percent SCC values with the 3 percent health benefit values assumes that there is no difference in discount rates between intragenerational and intergenerational impacts.

<sup>72</sup> The benefits presented here are estimated on an output basis to enable easier comparisons and to illustrate the potential impacts of moving from new coal without CCS to new NGCC. This analysis assumes representative new units and does not reflect the full array of new generating sources that could potentially be built (e.g., a comparison of a small new conventional coal plant with a small natural gas plant, or a comparison of a waste coal or petroleum coke facility to a natural gas plant of a comparable size and capacity factor). However, the incremental benefits associated with other facilities that could be built, and which would be subject to this proposal, would not change noticeably (i.e., these new facilities would be subject to emissions standards for other pollutants and would emit similar levels of SO<sub>2</sub>, NO<sub>x</sub>, and CO<sub>2</sub>, on an output basis) except for differences in local conditions, as discussed previously.

<sup>73</sup> The range of estimated benefits for each discount rate is due to the EPA's use of two alternative primary estimates of PM<sub>2.5</sub>-related mortality impacts: a lower primary estimate based on Krewski et al. (2009) and a higher primary estimate based on Lepeule et al. (2012).

The conclusion from this analysis is that there are significant environmental and health benefits associated with electricity generation from a representative new NGCC unit relative to a new conventional coal unit. Other studies of the social costs of coal and natural gas fired generation provide similar findings (Muller et. al., 2011; NRC, 2009).<sup>74</sup>

As explained previously, the power sector continues to move away from the construction of coal-fired power plants in favor of natural gas-fired power plants due, in part, to the significant cost differential. Even so, it is possible that a limited number of unplanned coal-fired power plants will be constructed during the analysis period. In these circumstances, units built with CCS in place of conventional coal-fired units would result in relative climate and human health and non-health benefits. Table 5-14 reports the 2020 incremental benefits associated with an illustrative new coal-fired plant with CCS relative to illustrative new SCPC and IGCC coal plants, given different mortality risk studies and assumptions about the discount rate. Depending on the coal-fired generation type, discount rate, and mortality risk study used, 2020 incremental benefits associated with generation from a representative new coal-fired unit with CCS relative to a new coal unit without CCS are \$2.0 to \$45 per MWh (2011\$).<sup>75</sup>

---

<sup>74</sup> Muller et al. 2011 conclude that, “coal-fired power plants have air pollution damages larger than their value added”, while the same is not true for natural gas plants (see Table 5). However, these comparisons are based on typical existing coal and natural gas units, including natural gas boilers, and are not sensitive to location (although the underlying analysis in the study does account for differences in the location of existing units when estimating damages). The NRC 2009 study shows that only the most polluting natural gas units may cause greater damages than even the least polluting existing coal plants (compare Tables 2-9 and 2-15). However, the NRC comparison does not compare new units located in the same place, and so some of the natural gas units with the greatest damages may be attributable to their location, and includes natural gas steam boilers, which have a higher emission rates per unit of generation than natural gas combined cycle units.

<sup>75</sup> Different discount rates are applied to SCC than to the other benefit estimates because CO<sub>2</sub> emissions are long-lived and subsequent damages occur over many years. Moreover, several rates are applied to SCC because the literature shows that it is sensitive to assumptions about discount rate and because no consensus exists on the appropriate rate to use in an intergenerational context. The SCC interagency group centered its attention on the 3 percent discount rate but emphasized the importance of considering all four SCC estimates. See the 2010 SCC TSD for details. Docket ID EPA-HQ-OAR-2009-0472-114577 or <http://www.whitehouse.gov/sites/default/files/omb/inforeg/for-agencies/Social-Cost-of-Carbon-for-RIA.pdf>.

**Table 5-14. 2020 Incremental Benefits (\$/MWh, 2011\$) of Emission Reductions from Coal-Fired Generation with CCS meeting 1,100 lbs/MWh *Relative* to New Coal-Fired Generation Without CCS**

	SCPC	IGCC		
<b>CO2-Related Benefits using SCC</b>				
5% Discount Rate	\$3.2	\$2.1		
3% Discount Rate	\$11	\$7.5		
2.5% Discount Rate	\$17	\$11		
3% Discount Rate (95th percentile)	\$34	\$23		
<b>PM2.5-Related Benefits from SO2 and NOX Reductions</b>				
3% discount rate				
Krewski et al. (2009)	\$4.7	*		
Lepeule et al. (2012)	\$11	*		
7% discount rate				
Krewski et al. (2009)	\$4.2	*		
Lepeule et al. (2012)	\$9.5	*		
<b>Combined CO2-Related and PM2.5-Related Benefits</b>				
	Discount Rate Applied to PM2.5-Related Benefits (range based on adult mortality function)			
SCC Discount Rate	3%	7%	3%	7%
5% Discount Rate	\$7.9 to \$14	\$7.4 to \$13	\$2.0 to \$2.0	\$2.0 to \$2.1
3% Discount Rate	\$16 to \$22	\$16 to \$21	\$7.4 to \$7.5	\$7.4 to \$7.5
2.5% Discount Rate	\$22 to \$28	\$22 to \$27	\$11 to \$11	\$11 to \$11
3% Discount Rate (95th percentile)	\$39 to \$45	\$39 to \$44	\$22 to \$23	\$22 to \$23

\*IGCC with CCS results in a small SO<sub>2</sub> emissions increase when compared to IGCC without CCS. As a result, there would be a negligible health disbenefit associated with these emissions increases.

Notes: Benefits are estimated for a 2020 analysis year. The range of benefits within each SCC value and discount rate for PM<sub>2.5</sub>-related benefits pairing reflects the use of two core estimates of PM<sub>2.5</sub>-related premature mortality.<sup>76</sup> The EPA has evaluated the range of potential impacts per MWh by combining all SCC values with health benefits values at the 3 percent and 7 percent discount rates. To be consistent with concepts of intergenerational discounting, values for health benefits, which occur within a generation, would only be combined with SCC values using a lower discount rate, e.g. the 7 percent health benefit estimates would be combined with 5 percent or lower SCC values, but the 3 percent health benefit would not be combined with the 5 percent SCC value. While the 5 percent SCC and 3 percent health benefit estimate falls within the range of values we analyze, this individual estimate should not be used independently in an analysis, as it represents a combination of discount rates that is unlikely to occur. Combining the 3 percent SCC values with the 3 percent health benefit values assumes that there is no difference in discount rates between intragenerational and intergenerational impacts.

## 5.9 Illustrative Analysis – Benefits and Costs across a Range of Gas Prices

As the analysis in Sections 5.4 and 5.5 demonstrated, under a wide range of likely electricity market conditions – including the EPA and EIA baseline scenarios as well as multiple alternative scenarios – the EPA projects that the industry will choose to construct new units

<sup>76</sup> The range of estimated benefits for each discount rate is due to the EPA's use of two alternative primary estimates of PM<sub>2.5</sub>-related mortality impacts: a lower primary estimate based on Krewski et al. (2009) and a higher primary estimate based on Lepeule et al. (2012).

that already meet the standards of this proposed rulemaking, regardless of this proposal. In this section, we consider the unlikely scenario where construction of new supercritical coal capacity without CCS occurs during the analysis period in the absence of the rule. The analysis in this section indicates that in this scenario, which implies that the proposed EGU New Source GHG Standards would result in costs to the investor, but would lead to greater climate and human health benefits and is highly likely to provide net benefits to society as a whole.<sup>77</sup>

The starting point for this analysis is the illustrative comparison (presented in Section 5.5.4) of the relative LCOE of representative new SCPC and IGCC coal EGUs and representative NGCC units.<sup>78</sup> This comparison demonstrates a significant difference in the LCOE between the coal-fired and natural gas-fired generating technologies. The estimated LCOE for a representative NGCC unit is roughly \$33 and \$38 per MWh less than for a representative new SCPC or IGCC coal unit, respectively (see Figure 5-3).<sup>79</sup> This is consistent with the EPA's projection, discussed at length in this chapter, that the proposed EGU New Source GHG Standards are not projected to impose any costs (or generate quantified net benefits) under current and likely future market conditions.

To supplement this determination, this section presents an analysis of three relevant ranges within the distribution of future natural gas prices that can be classified as likely gas prices, unexpectedly high natural gas prices, and unprecedented natural gas prices. Because the cost of natural gas is a significant share of the LCOE for NGCC, we evaluate how changes in natural gas prices affect differences in private and social cost of new technologies. In general, this analysis shows that there would likely be a net social benefit,<sup>80</sup> even under scenarios with higher than expected gas prices, if new NGCC units were built in place of new coal-fired units as a result of this policy. Under some conditions, higher natural gas prices may result in a net social cost, holding all other parameters constant and disregarding social benefits that we are

---

<sup>77</sup> EO 13563 states that each agency must "propose or adopt a regulation only upon a reasoned determination that its benefits justify its costs (recognizing that some benefits are hard to quantify)." While the presence of net social benefits for a given regulatory option is not the only condition necessary for optimal regulatory design, it does signify that the regulatory option is welfare improving for society.

<sup>78</sup> By fixing generation in this comparison, we are assuming that both technologies generate the same benefits in the form of electricity generating services. We assume in the discussion that the benefit of electricity production to consumers outweighs the private and social investment cost. However, at particularly high fuel prices this might not be the case. For a discussion of when comparing the levelized costs of different generating technologies provides informative results and when it does not see, for example, Joskow 2010 and 2011.

<sup>79</sup> LCOE of NGCC relative to SCPC with 3% CUA and IGCC without 3% CUA.

<sup>80</sup> The benefits estimated in this section are based on a single year (2020) of emissions from different generating technologies. Due to data limitations, we are not able to estimate annualized benefits from the stream of emissions over the lifetime of the generating technologies. This results in a conservative comparison of benefits to costs where LCOE represents annualized lifetime costs of generating technologies.

unable to monetize.<sup>81</sup> Additionally, given certain market conditions, some operators may choose to construct a new coal-fired unit with CCS. The relative private costs and social benefits of a new coal-fired unit with CCS are discussed in Section 5.10.

### 5.9.1 Likely Natural Gas Prices

As shown earlier, it is only when natural gas prices reach \$10.94/MMBtu on a levelized basis (in 2011 dollars) that new coal-fired generation without CCS becomes competitive in terms of its cost of electricity. None of the EPA sensitivities or AEO2013 scenarios approach this natural gas price level on either a forward looking 20-year levelized price basis or on an average annual price basis at any point during the analysis period.<sup>82</sup>

### 5.9.2 Unexpectedly High Natural Gas Prices

At natural gas prices above \$10.94/mmBtu, the private levelized cost of electricity for a representative new SCPC unit falls below that of a new NGCC unit. Therefore, at anticipated levelized fuel prices above that price level some new SCPC coal units might be constructed in the absence of this proposed rulemaking, provided there is sufficient demand and new coal without CCS is competitive with other generating technologies.<sup>83</sup> In this scenario, there would be some compliance cost if a new NGCC unit or a coal-fired unit with CCS were built as a result of the standard. However, generation from either a new NGCC unit or a coal-fired unit with CCS would also have incremental environmental and health benefits by reducing global warming pollution and particulate matter (as a result of SO<sub>2</sub> and NO<sub>x</sub> emissions) relative to generation from a new coal unit.

For average annual natural gas prices greater than \$10.94/mmBtu, the resulting emission reduction benefits of building NGCC will outweigh the costs of constructing an NGCC unit in lieu of a coal plant without CCS – indicating that the standard would yield net benefits

---

<sup>81</sup> The net cost scenario is unlikely to occur over our analysis period and for a significant period beyond. For example, high economic growth would increase both natural gas and coal prices at the same time - making it harder to alter the underlying cost advantage of NGCC generation. It is important to note that this analysis is limited in the types of benefits and costs considered, given that it does not address the life-cycle pollution associated with fossil fuels along with the limitations of current SCC estimates. As previously discussed, the current SCC estimates do not capture all important all of the physical, ecological, and economic impacts of climate change recognized in the climate change literature. Despite our attempts to quantify and monetize as many of the co-benefits as possible, the health and welfare co-benefits are not fully quantified or monetized in this assessment. For more information about unquantified health and welfare co-benefits please refer to tables 5-2 and 6-2 of the PM NAAQS RIA (U.S. EPA, 2012), respectively.

<sup>82</sup> EIA's projected natural gas price for 2022 in its reference scenario for AEO2013 is \$5.31 (in 2011 dollars). EIA's "Low oil and gas resource" scenario projects an average delivered electricity sector gas price of \$6.64/mmBtu (in 2011 dollars) in 2022.

<sup>83</sup> See section 5.5 for a discussion of how local conditions and other factors may influence the LCOE comparison.

for the analysis year. For example, at an average annual gas price of \$11/MMBtu, the illustrative NGCC unit would generate power for approximately \$1/MWh more than an SCPC coal unit on a levelized basis,<sup>84</sup> and result in incremental benefits from emissions of \$20 to \$95/MWh (see analysis of 2020 relative benefits of NGCC: table 5-13).<sup>85</sup> The net benefit of this scenario would be \$19 to \$95/MWh.<sup>86</sup> As illustrated in section 5.10, if an SCPC coal unit with CCS (as opposed to an NGCC unit) were built instead of an SCPC coal unit without CCS, the CCS equipped unit would result in an incremental cost of \$18/MWh and incremental benefits from emissions of \$7.4 to \$45/MWh relative to an SCPC unit without CCS (see analysis of 2020 relative benefits of CCS: table 5-14). The net impact of this scenario would range from a net cost of \$11/MWh to a net benefit of \$27/MWh.

For context, a natural gas price level of \$10/MMBtu (in 2011 dollars) is higher than any annual natural gas price to the electric power sector since at least 1996, when the EIA data series stops.<sup>87</sup> In addition, the highest projected average annual natural gas price during the analysis period in any of the AEO2013 scenarios cited in this chapter is \$6.64/MMBtu in the Low Oil and Gas Resource scenario. Further, the continued development of unconventional natural gas resources in the U.S. suggests that gas prices would actually tend to be towards the lower end of the historical range. As discussed above, none of the EIA sensitivity cases (which account for future fuel prices for both gas and coal) show scenarios where noncompliant coal becomes more economic than NGCC before 2020.

### 5.9.3 Unprecedented Natural Gas Prices

At extremely high natural gas prices, the generating costs of coal without CCS would be sufficiently lower than the cost of new natural gas that the net benefit of the standard in a given year could be negative (i.e., a net cost) under some ranges of benefit estimates. For example, at gas prices of \$14/MMBtu, the illustrative NGCC unit would generate power for roughly \$21 and \$16/MWh more than conventional SCPC and IGCC coal units, respectively but result in social benefits from lower emissions of \$20 to \$95/MWh and \$6.6 to \$61/MWh relative to the SCPC and IGCC coal units, respectively (see analysis of 2020 relative benefits of NGCC: table 5-13). If an NGCC unit were built as a result of the standard, the resulting net

---

<sup>84</sup> Assuming an increase of \$6.80/MWh in the cost of gas generation for every \$1/MMBtu increase in natural gas prices.

<sup>85</sup> Assuming that coal prices do not increase along with natural gas prices as they historically have.

<sup>86</sup> The higher value of net benefits calculated here is equal to the higher value of incremental benefits due to rounding.

<sup>87</sup> See: <http://www.eia.gov/dnav/ng/hist/n3045us3A.htm>. EIA reports average annual delivered natural gas prices to the electricity sector for the past 16 years (since 1997).

impact would range from a net social cost of \$1.5/MWh to a net social benefit of \$74/MWh relative to SCPC and from a net social cost of \$9.5/MWh to a net social benefit of \$45/MWh relative to IGCC.

As noted in the previous subsection, natural gas prices at these levels would be unprecedented as they have not been observed as long as EIA has collected data on natural gas prices. As a result, the EPA believes that the probability of natural gas prices reaching average annual levels at which this standard would generate net social costs under some ranges of benefit estimates is extremely small.

We emphasize that differences in generating costs, plant design, local factors, and the relative differences between fuels costs can all have major impacts on the precise circumstances under which this standard would be projected to have no costs, net social benefits or net social costs. However, based on historical and expected average annual gas prices, we project that this standard is most likely to have negligible costs, and, if it does result in costs, it is also likely to produce positive, although modest, net social benefits. The probability that this proposed standard would result in net social costs is exceedingly low.

#### **5.10 Illustrative Analysis – Benefits and Costs of CCS Compared with Conventional Coal**

The previous section evaluated the social benefit of an investor constructing a new NGCC unit in lieu of an uncontrolled unit in response to the proposed rule. If an operator chose to construct a new coal unit, this proposed rule would result in some costs in order to build a unit with partial CCS. However, there would also be climate and other benefits resulting from reductions in CO<sub>2</sub>, SO<sub>2</sub>, and NO<sub>x</sub> emissions.<sup>88</sup> For each coal-fired generation type, SCPC and IGCC, the EPA analyzed the cost and 2020 emission impacts for the proposed emission limit using partial capture, plus a more stringent full capture scenario. Consistent with the LCOE estimates provided earlier in this chapter, the partial capture CCS scenarios achieve the proposed emissions rate of 1,100 lb CO<sub>2</sub>/MWh gross output. The full capture CCS scenarios achieve an emissions rate of 200 lb CO<sub>2</sub>/MWh and 150 lb CO<sub>2</sub>/MWh for SCPC and IGCC, respectively. Tables 5-15 and 5-16 show the costs and 2020 net benefits per MWh of each of these scenarios relative to a no capture scenario.

In the near term, any new coal-fired EGU with CCS would most likely be located in areas amenable to using the captured CO<sub>2</sub> in EOR operations. This is because EOR provides a revenue

---

<sup>88</sup> When comparing the private costs of different technologies, we account for the CUA in the investor decision making, but when we compare the difference in the social costs of these technologies (i.e., the private cost plus the cost associated with their emissions) the CUA is not included.



stream that is not available for other forms of geologic storage. For example, the Texas Clean Energy project<sup>89</sup> is planning to capture 90% of the CO<sub>2</sub> and sell it for EOR. To evaluate the potential revenues from EOR we estimate the revenue in each scenario if CO<sub>2</sub> could be sold for \$20 to \$40/ton based on assumptions used by NETL in evaluating the EOR opportunities.<sup>90</sup>

**Table 5-15. Illustrative Costs and 2020 Social Benefits for SCPC with Partial Capture and Full Capture CCS Relative to SCPC without CCS (per MWh 2011\$)**

	Partial CCS	Full CCS
Additional LCOE of CCS <sup>a</sup>	\$29	\$66
Revenue from EOR (Low - High EOR)	\$14 to \$22	\$32 to \$54
Additional LCOE, net of EOR	\$15 to \$7	\$34 to \$12
Value of Monetized Benefits for 2020 Emissions SCC 5% with Krewski 3% to SCC 3% (95th) with Lepeule 3% <sup>b</sup>	\$7.9 to \$45	\$22 to \$120
Net Monetized Benefits for 2020 Emissions Without EOR Revenue	-\$21 to \$16	-\$44 to \$59
With EOR Revenue	-\$7.1 to \$38	-\$12 to \$110

<sup>a</sup> LCOE of SCPC without CCS does not include 3% CUA.

<sup>b</sup> Benefits are estimated for a 2020 analysis year. Values shown are calculated using different discount rates. Four estimates of the SCC in the year 2020 were used: \$13, \$46, and \$69 per metric ton (average SCC at discount rates of 5, 3, and 2.5 percent, respectively) and \$138 per metric ton (95th percentile SCC at 3 percent). The average SCC at 5 percent produced the lowest estimate and the 95th percentile estimate at 3 percent produced the highest estimate. See RIA 5.7.1 for complete discussion about these estimates.

**Table 5-16. Illustrative Costs and 2020 Social Benefits for IGCC with Partial Capture and Full Capture CCS Relative to IGCC without CCS (per MWh 2011\$)**

	Partial CCS	Full CCS
Additional LCOE of CCS <sup>a</sup>	\$12	\$39
Revenue from EOR (Low - High EOR)	\$8 to \$12	\$27 to \$45
Additional LCOE, net of EOR	\$4 to \$0	\$12 to -\$6
Value of Monetized Benefits for 2020 Emissions SCC 5% with Krewski 3% to SCC 3% (95th) with Lepeule 3% <sup>b</sup>	\$2 to \$22	\$8.3 to \$94
Net Monetized Benefits for 2020 Emissions Without EOR Revenue	-\$10 to \$11	-\$31 to \$55
With EOR Revenue	-\$2 to \$23	-\$3.7 to \$100

<sup>a</sup> LCOE of IGCC without CCS does not include 3% CUA.

<sup>b</sup> Benefits are estimated for a 2020 analysis year. Values shown are calculated using different discount rates. Four estimates of the SCC in the year 2020 were used: \$13, \$46, and \$69 per metric ton (average SCC at discount rates of 5, 3, and 2.5 percent, respectively) and \$138 per metric ton (95th percentile SCC at 3 percent). The average SCC at 5 percent produced the lowest estimate and the 95th percentile estimate at 3 percent produced the highest estimate. See RIA 5.7.1 for complete discussion about these estimates.

<sup>89</sup> <http://www.texascleanenergyproject.com/>

<sup>90</sup> [http://www.netl.doe.gov/energy-analyses/pubs/storing%20co2%20w%20eor\\_final.pdf](http://www.netl.doe.gov/energy-analyses/pubs/storing%20co2%20w%20eor_final.pdf)

The EPA estimated the benefits associated with avoided CO<sub>2</sub>, SO<sub>2</sub>, and NO<sub>x</sub> emissions using the methods described previously in this chapter. Similarly, the cost estimates EPA used are described previously in this chapter. As before, it is important to note that these comparisons omit additional benefits that may be associated with the abatement of greenhouse gas emissions.

### **5.11 Impact of the Proposed Rule on Option Costs**

Consistent with EPA's practice in evaluating the benefits and costs of significant rules, Section 5.5 of this chapter uses detailed electricity sector modeling of expected market conditions, along with alternative scenario analysis, to demonstrate, that under a broad range of conditions, new EGUs expected to be built in the period of analysis would be in compliance with this proposed rule, even in the absence of this rule. As a result, the quantifiable benefits and costs of the proposed EGU New Source GHG Standards are zero in the analysis period. This analysis is extended in Sections 5.9 through 5.10 to acknowledge unexpected conditions that could occur during the period of analysis in which the construction of a new coal unit without CCS would be desirable from the perspective of an individual investor and evaluates the costs and benefits of constructing a generating technology that complies with the proposed rule instead. This section further extends, and draws on, those analyses to discuss, qualitatively, how EPA views the potential social benefits and costs of the proposed EGU New Source GHG Standards.

When there is uncertainty about future conditions that could impact an investment decision, investors place a value on retaining the ability to choose from a range of different investments. This is referred to as "option value." Any cost of this proposed rule is the investor's loss of the option value associated with the ability to build new coal units without CCS. In the future, as uncertainty in market conditions is resolved investors will respond to expected electricity demand based on the available choice set, taking as given other market and regulatory constraints. The cost that society incurs when the choices available to the investors are restricted is represented by the least cost option value associated with the choices that are eliminated (Dixit and Pindyck, 1994; Trigeorgis, 1996). This option value is determined by the likelihood that the restricted choices would be exercised absent the policy, the social cost of substitutes, and the value of being able to adjust diversity of fuels that can be used by the generating fleet.<sup>91</sup> If it is highly unlikely that the restricted choices would be exercised in the

---

<sup>91</sup> The option value associated with constructing new coal-fired capacity without partial CCS as part of a portfolio that hedges against uncertainty in future fuel prices will be conditional upon the current composition of the fleet. If the current stock was constructed in expectation of relative fuel prices that more strongly favored

absence of the policy, or substitutes are available at a minimal incremental cost, then the option value will be negligible, and therefore so to will be the social cost of the restriction.

In the case of this proposal, the choice set for firms that generate and sell electricity is not being significantly restricted. The proposal eliminates the option to construct new uncontrolled coal units, for which there are other generating substitutes, including renewables, natural gas, and coal with CCS.<sup>92</sup> The value of this option is conditional upon the likelihood that it would be exercised during the analysis period and the cost of available substitutes. As discussed in Section 5.9 it is highly unlikely that over the analysis period there will be enough expansion in relative fuel prices (i.e. natural gas prices relative to coal) to make new coal-fired EGUs cost competitive. Therefore, the option value, from the perspective of society, associated with allowing investors to construct a new coal fired EGU is currently expected to be minimal. As a result, any impact this proposal may have on the option value will be minimal as well.

If current conditions were significantly different and there existed a higher probability that the option to build a new coal-fired unit without SCC might be exercised during the analysis period, the impact on the option value will be primarily driven by the incremental cost of increasing utilization at existing units, investing in cost-saving energy efficiency or constructing a new unit with a substitute fuel (e.g., renewables, natural gas, etc.). Because investors retain the ability to construct coal with CCS, the effect on the option value will be equal to the incremental cost of CCS.<sup>93</sup> Additionally, this is based not on the cost of CCS today, but the expected cost of CCS in the future. If market conditions were to deviate significantly from expectations such that the likelihood of investors constructing new coal units with CCS increased, so would research and development spending on the technology, thereby driving down its expected costs.

It is difficult to precisely estimate the option cost of this proposed rule given the numerous sources of uncertainty that influence investment decisions in the electricity sector and existing modeling tools. However, the analysis reported in this chapter has considered important variables that influence investment decisions in the electricity sector and found that across a wide range of potential outcomes this rule would have no quantifiable costs. Furthermore, considering the additional analysis in sections 5.9 and 5.10 and the discussion

---

higher emitting fuels, then the composition of the generating fleet may already be too heavily weighted toward the ability to use those fuels, given the current expected distribution of relative fuel prices.

<sup>92</sup> By definition the option value associated with coal without partial CCS will be less than the option value associated with the ability to construct and operate any type of new coal fired unit..

<sup>93</sup> Including any additional costs associated with differences in electricity transmission, coal delivery, etc. associated with a coal unit with CCS being constructed in lieu of the construction of a non-compliant unit.

above, the option cost of the rule is concluded to be small and bounded by the cost of CCS. Additionally, if conditions arise that would have led to the construction of coal-fired units without CCS absent the proposed rule, the quantifiable social benefits of limiting the construction of those units likely exceed the cost. However, as discussed throughout this RIA, when considering the most likely outcomes, the proposed rule is anticipated to yield no monetized benefits and impose negligible costs over the analysis period.

### **5.12 Summary of Costs, Benefits, and Energy Impacts**

Under a wide range of electricity market conditions – including EPA’s baseline scenario as well as multiple sensitivity analyses – EPA projects that the industry will choose to construct new units that already meet these standards, regardless of this proposal. As a result, EPA anticipates that the proposed EGU New Source GHG Standards will result in negligible CO<sub>2</sub> emission changes, energy impacts, benefits or costs for new units constructed by 2020. Likewise, the Agency does not anticipate any notable impacts on the price of electricity or energy supplies. Additionally, for the reasons described above, the proposed rule is not expected to raise any reliability concerns, since reserve margins will not be impacted and the rule does not impose any requirements on existing facilities.

### **5.13 Macroeconomic and Employment Impacts**

These proposed EGU New Source GHG Standards is not anticipated to change GHG emissions for newly constructed electric generating units, and is anticipated to impose negligible costs or monetized benefits. EPA typically presents the economic impacts to secondary markets (e.g., changes in industrial markets resulting from changes in electricity prices) and impacts to employment or labor markets associated with proposed rules based on the estimated compliance costs and other energy impacts, which serve as an input to such analyses. However, since the EPA does not forecast a change in behavior relative to the baseline in response to this proposed rule, there are no notable macroeconomic or employment impacts expected as a result of this proposed rule.

### **5.14 References**

Dixit, Avinash and Pindyck, Robert. *Investment Under Uncertainty*. 1994. Princeton University Press.

Fann, N., K.R. Baker, C.M. Fulcher. 2012. Characterizing the PM<sub>2.5</sub>-related health benefits of emission reductions for 17 industrial, area and mobile emission sectors across the U.S. *Environment International*, Volume 49, 15 November 2012, Pages 141-151, ISSN 0160-4120, <http://dx.doi.org/10.1016/j.envint.2012.08.017>.

- Joskow, P.L. 2010. Comparing the Cost of Intermittent and Dispatchable Electricity Generating Technologies. MIT Center for Energy and Environmental Policy Research Working Paper 10-013.
- P.L. Joskow. 2011. Comparing the Costs of Intermittent and Dispatchable Electricity Generating Technologies. *American Economic Review*. vol. 101:238-41.
- Krewski, D., R.T. Burnett, M.S. Goldberg, K. Hoover, J. Siemiatycki, M. Jerrett, M. Abrahamowicz, and W.H. White. 2009. "Reanalysis of the Harvard Six Cities Study and the American Cancer Society Study of Particulate Air Pollution and Mortality." Special Report to the Health Effects Institute. Cambridge, MA. July.
- Lepeule, J., F. Laden, D. Dockery, and J. Schwartz. 2012. "Chronic Exposure to Fine Particles and Mortality: An Extended Follow-Up of the Harvard Six Cities Study from 1974 to 2009." *Environ Health Perspect*. In press. Available at: <http://dx.doi.org/10.1289/ehp.1104660>.
- Malik, N.S. 2010, November 1. NextEra CEO sees clean energy standards replacing recent climate proposals [Radio transcript]. Dow Jones News [Online]. Available: Dow Jones Interactive Directory: Publications Library.
- Mufson, S. 2011, January 2. Coal's burnout. *The Washington Post*. Retrieved from <http://www.washingtonpost.com/newssearch>.
- Muller, N.Z., R. Mendelsohn, and W. Nordhaus. 2011. Environmental Accounting for Pollution in the United States Economy. *American Economic Review*. 101:1649-1675.
- National Energy Technology Laboratory (NETL). Cost and Performance of PC and IGCC Plants for a Range of Carbon Dioxide Capture. Revised Sept. 16, 2013. Available online at: <http://www.netl.doe.gov/energy-analyses/pubs/Gerdes-08022011.pdf>.
- Rosenberg, M. 2011, September/October. "The Reign of Cheap Gas." *EnergyBiz Magazine*. Retrieved from <http://www.energybiz.com/magazine/article/234577/reign-cheap-gas>.
- Tong, S. 2010, November 1. Placing Bets on Clean Energy. [Radio transcript]. American Public Media: *Marketplace* [Online]. Available: Marketplace Programs on Demand.
- National Petroleum Council. 2011. Prudent Development: Realizing the Potential of North America's Abundant Natural Gas and Oil Resources. Available online at: <http://www.npc.org/reports/rd.html>.
- National Research of Council (NRC). 2009. Hidden Costs of Energy: Unpriced Consequences of Energy Production and Use. National Academies Press: Washington, D.C.
- Trigeorgis, Lenos. *Real Options: Managerial Flexibility and Strategy in Resource Allocation*. 1996. The MIT Press.

- U.S. Energy Information Administration (U.S. EIA). Annual Energy Outlook 2010. 2010. Available online at: <http://www.eia.gov/oiaf/archive/aeo10/index.html>.
- U.S. Energy Information Administration (U.S. EIA). Annual Energy Outlook 2013. 2013. Available online at: <http://www.eia.gov/forecasts/aeo/>.
- U.S. Environmental Protection Agency (U.S. EPA). 2008. Integrated Science Assessment for Oxides of Nitrogen and Sulfur –Ecological Criteria National (Final Report). National Center for Environmental Assessment, Research Triangle Park, NC. EPA/600/R-08/139. December. Available on the Internet at <http://cfpub.epa.gov/ncea/cfm/recordisplay.cfm?deid=201485>.
- U.S. Environmental Protection Agency (U.S. EPA). 2009. Integrated Science Assessment for Particulate Matter (Final Report). EPA-600-R-08-139F. National Center for Environmental Assessment – RTP Division. December. Available on the Internet at <http://cfpub.epa.gov/ncea/cfm/recordisplay.cfm?deid=216546>.
- U.S. Environmental Protection Agency (U.S. EPA). 2011. Regulatory Impact Analysis for the Final Mercury and Air Toxics Standards. Office of Air Quality Planning and Standards, Research Triangle Park, NC. December. Available on the Internet at <http://www.epa.gov/ttn/ecas/regdata/RIAs/matsriafinal.pdf>.
- U.S. Environmental Protection Agency (U.S. EPA). 2012. Regulatory Impact Analysis (RIA) for the Final Revisions to the National Ambient Air Quality Standards for Particulate Matter. Office of Air Quality Planning and Standards, Research Triangle Park, NC. December. Available on the Internet at <http://www.epa.gov/ttn/ecas/regdata/RIAs/finalria.pdf>.
- U.S. Environmental Protection Agency (U.S. EPA). 2013a. Technical Support Document Estimating the Benefit per Ton of Reducing PM<sub>2.5</sub> Precursors from 17 Sectors. Office of Air Quality Planning and Standards, Research Triangle Park, NC. January. Available on the Internet at: [http://www.epa.gov/airquality/benmap/models/Source Apportionment BPT TSD 1 3 1 13.pdf](http://www.epa.gov/airquality/benmap/models/Source%20Apportionment%20BPT%20TSD%201%203%201%2013.pdf).
- U.S. Environmental Protection Agency (U.S. EPA). 2013b. Integrated Science Assessment for Ozone and Related Photochemical Oxidants. EPA/600/R-10/076F. Research Triangle Park, NC: U.S. EPA. February. Available on the Internet at [http://oaspub.epa.gov/eims/eimscomm.getfile?p\\_download\\_id=511347](http://oaspub.epa.gov/eims/eimscomm.getfile?p_download_id=511347).

## CHAPTER 6

### STATUTORY AND EXECUTIVE ORDER ANALYSES

#### 6.1 Synopsis

This chapter presents discussion and analyses relating to Executive Orders and statutory requirements relevant to the proposed EGU New Source GHG Standards. We discuss analyses conducted to meet the requirements of Executive Orders 12866 and 13563, as well as potential impacts to affected small entities required by the Regulatory Flexibility Act (RFA), as amended by the Small Business Regulatory Enforcement Fairness Act (SBREFA). We also discuss the requirements of the Unfunded Mandates Reform Act of 1995 (UMRA) and assess the impact of the proposed rule on state, local and tribal governments and the private sector, along with the analysis conducted to comply with the Paperwork Reduction Act (PRA). In addition, we address the requirements of Executive Order (EO) 13045: Protection of Children from Environmental Health and Safety Risks; EO 13132: Federalism; EO 13175: Consultation and Coordination with Indian Tribal Governments; EO 12898: Federal Actions to Address Environmental Justice in Minority Populations and Low-Income Populations; EO 13211: Actions that Significantly Affect Energy Supply, Distribution, or Use; and the National Technology Transfer and Advancement Act (NTTAA).

#### 6.2 Executive Order 12866, Regulatory Planning and Review, and Executive Order 13563, Improving Regulation and Regulatory Review

Under EO 12866 (58 FR 51,735, October 4, 1993), this action is a “significant regulatory action” because it “raises novel legal or policy issues arising out of legal mandates.” Accordingly, the EPA submitted this action to the Office of Management and Budget (OMB) for review under Executive Orders 12866 and 13563 (76 FR 3821, January 21, 2011) and any changes made in response to OMB recommendations have been documented in the docket for this action.

In addition, the EPA prepared an analysis of the potential costs and benefits associated with this action. This analysis is contained in this RIA. Based on the analysis presented in Chapter 5, the EPA believes this rule will have negligible compliance costs associated with it, over a range of likely sensitivity conditions, because electric power companies would choose to build new EGUs that comply with the regulatory requirements of this proposal even in the absence of the proposal given existing and expected market conditions. The EPA does not project any new coal-fired EGUs without CCS to be built in the absence of this proposal. However, because some companies may choose to construct coal or other solid fossil fuel-fired

units, this RIA also analyzes project-level costs of a unit with and without CCS, to quantify the potential cost for a solid fossil fuel-fired unit with CCS and estimate the social benefits of requiring CCS on a new uncontrolled unit.

### **6.3 Paperwork Reduction Act**

The information collection requirements in this proposed rule have been submitted for approval to the Office of Management and Budget under the Paperwork Reduction Act, 44 U.S.C. 3501 et seq. The information collection requirements are not enforceable until OMB approves them. The Information Collection Request (ICR) document prepared by the EPA has been assigned EPA ICR tracking number 2465.02 and OMB control number 2060-0685.

This proposed action will impose minimal new information collection burden on affected sources beyond what those sources are already subject to under the authorities of CAA parts 75 and 98. OMB has previously approved the information collection requirements contained in the existing part 75 and 98 regulations (40 CFR part 75 and 40 CFR part 98) under the provisions of the PRA, 44 U.S.C. 3501 et seq. and has assigned OMB control numbers 2060-0626 and 2060-0629, respectively. Apart from certain reporting costs based on requirements in the NSPS General Provisions (40 CFR part 60, subpart A), which are mandatory for all owners/operators subject to CAA section 111 national emission standards, there are no new information collection costs, as the information required by this proposed rule is already collected and reported by other regulatory programs. The recordkeeping and reporting requirements are specifically authorized by CAA section 114 (42 U.S.C. 7414). All information submitted to the EPA pursuant to the recordkeeping and reporting requirements for which a claim of confidentiality is made is safeguarded according to Agency policies set forth in 40 CFR part 2, subpart B.

The EPA believes that electric power companies will choose to build new EGUs that comply with the regulatory requirements of this proposal because of existing and expected market conditions. The EPA does not project any new coal-fired EGUs that commence construction after this proposal to commence operation over the 3-year period covered by this ICR. We estimate that 17 new affected NGCC units will commence operation during that time period. As a result of this proposal, those units will be required to prepare a summary report, which includes reporting of emissions and downtime every 3 months.

When a malfunction occurs, sources must report them according to the applicable reporting requirements of 40 CFR part 60, subparts Da and KKKK or subpart TTTT 60.5530. An affirmative defense to civil penalties for exceedances of emission limits that are caused by



malfunctions is available to a source if it can demonstrate that certain criteria and requirements are satisfied. The criteria ensure that the affirmative defense is available only where the event that causes an exceedance of the emission limit meets the narrow definition of malfunction<sup>1</sup> and where the source took necessary actions to minimize emissions. In addition, the source must meet certain notification and reporting requirements. For example, the source must prepare a written root cause analysis and submit a written report to the Administrator documenting that it has met the conditions and requirements for assertion of the affirmative defense.

To provide the public with an estimate of the relative magnitude of the burden associated with an assertion of affirmative defense, the EPA has estimated what the notification, recordkeeping, and reporting requirements associated with the assertion of the affirmative defense might entail. The EPA's estimate for the required notification, reports, and records, including the root cause analysis, associated with a single incident totals approximately \$3,141, and is based on the time and effort required of a source to review relevant data, interview plant employees, and document the events surrounding a malfunction that has caused an exceedance of an emission limit. The estimate also includes time to produce and retain the record and reports for submission to the EPA. The EPA provides this illustrative estimate of this burden, because these costs are only incurred if there has been a violation, and a source chooses to take advantage of the affirmative defense.

Given the variety of circumstances under which malfunctions could occur, as well as differences among sources' operation and maintenance practices, we cannot reliably predict the severity and frequency of malfunction-related excess emissions events for a particular source. It is important to note that the EPA has no basis currently for estimating the number of malfunctions that would qualify for an affirmative defense. Current historical records would be an inappropriate basis, as this rule applies only to sources built in the future. Of the number of excess emissions events that may be reported by source operators, only a small number would be expected to result from a malfunction, and only a subset of excess emissions caused by malfunctions would result in the source choosing to assert an affirmative defense. Thus, we believe the number of instances in which source operators might be expected to avail themselves of the affirmative defense will be extremely small. In fact, we estimate that there will be no such occurrences for any new sources subject to 40 CFR part 60, subpart Da or KKKK

---

<sup>1</sup> Malfunction means any sudden, infrequent, and not reasonably preventable failure of air pollution control and monitoring equipment, process equipment, or a process to operate in a normal or usual manner which causes, or has the potential to cause, the emission limitations in an applicable standard to be exceeded. Failures that are caused in part by poor maintenance or careless operation are not malfunctions.

over the 3-year period covered by this ICR. We expect to gather information on such events in the future, and will revise this estimate as better information becomes available.

The annual information collection burden for this collection consists only of reporting burden as explained above. The reporting burden for this collection (averaged over the first 3 years after the effective date of the standards) is estimated to be \$15,570 and 396 labor hours. This estimate includes quarterly summary reports which include reporting of emissions and downtime. All burden estimates are in 2010 dollars, consistent with the information collection request. Average burden hours per response are estimated to be 8 hours. The total number of respondents over the 3-year ICR period is estimated to be 36. Burden is defined at 5 CFR 1320.3(b).

An agency may not conduct or sponsor, and a person is not required to respond to, a collection of information unless it displays a currently valid OMB control number. The OMB control numbers for EPA's regulations in 40 CFR are listed in 40 CFR part 9.

To comment on the Agency's need for this information, the accuracy of the provided burden estimates, and any suggested methods for minimizing respondent burden, the EPA has established a public docket for this rule, which includes this ICR, under Docket ID number EPA-HQ-OAR-2013-0495. Submit any comments related to the ICR to the EPA and OMB. See ADDRESSES section at the beginning of this notice for where to submit comments to the EPA. Send comments to OMB at the Office of Information and Regulatory Affairs, Office of Management and Budget, 725 17th Street, NW, Washington, DC 20503, Attention: Desk Officer for EPA. Since OMB is required to make a decision concerning the ICR between 30 and 60 days after publication in the Federal Register, a comment to OMB is best assured of having its full effect if OMB receives it by 30 days after publication in the federal register. The final rule will respond to any OMB or public comments on the information collection requirements contained in this proposal.

#### **6.4 Regulatory Flexibility Act**

The RFA generally requires an agency to prepare a regulatory flexibility analysis of any rule subject to notice and comment rulemaking requirements under the Administrative Procedure Act or any other statute unless the agency certifies that the rule will not have a significant economic impact on a substantial number of small entities. Small entities include small businesses, small organizations, and small governmental jurisdictions.

For purposes of assessing the impacts of this rule on small entities, small entity is defined as:

(1) A small business that is defined by the Small Business Administration’s regulations at 13 CFR 121.201 (for the electric power generation industry, the small business size standard is an ultimate parent entity defined as having a total electric output of 4 million MWh or less in the previous fiscal year. The NAICS codes for the affected industry are in Table 6-1 below);

(2) A small governmental jurisdiction that is a government of a city, county, town, school district, or special district with a population of less than 50,000; and

(3) A small organization that is any not-for-profit enterprise which is independently owned and operated and is not dominant in its field.

**Table 6-1. Potentially Regulated Categories and Entities<sup>a</sup>**

Category	NAICS Code	Examples of Potentially Regulated Entities
Industry	221112	Fossil fuel electric power generating units.
State/Local Government	221112 <sup>b</sup>	Fossil fuel electric power generating units owned by municipalities.

<sup>a</sup> Include NAICS categories for source categories that own and operate electric power generating units (includes boilers and stationary combined cycle combustion turbines).

<sup>b</sup> State or local government-owned and operated establishments are classified according to the activity in which they are engaged.

After considering the economic impacts of this proposed rule on small entities, the Administrator of EPA certifies that this action will not have a significant economic impact on a substantial number of small entities.

We do not include an analysis of the illustrative impacts on small entities that may result from implementation of this proposed rule by states because we anticipate negligible compliance costs over a range of likely scenarios as a result of this proposal. Thus the cost-to-sales ratios for any affected small entity would be zero costs as compared to annual sales revenue for the entity. The EPA believes that electric power companies will choose to build new EGUs that comply with the regulatory requirements of this proposed rule because of existing and expected market conditions. (See the Chapter 5 for further discussion of sensitivities.) The EPA does not project any new coal-fired EGUs without CCS to be built. Accordingly, there are no anticipated economic impacts as a result of this proposed rule.

Nevertheless, the EPA is aware that there is substantial interest in this rule among small entities (municipal and rural electric cooperatives). In light of this interest, prior to the April 13, 2012 proposal (77 FR 22392), the EPA determined to seek early input from representatives of small entities while formulating the provisions of this proposed regulation. Such outreach is also consistent with the President's January 18, 2011 Memorandum on Regulatory Flexibility, Small Business, and Job Creation, which emphasizes the important role small businesses play in the American economy. This process enabled the EPA to hear directly from these representatives, at a very preliminary stage, about how it should approach the complex question of how to apply Section 111 of the CAA to the regulation of GHGs from these source categories. The EPA's outreach regarded planned actions for new and existing sources, but only new sources will be affected by this proposed action.

The EPA conducted an initial outreach meeting with small entity representatives on April 6, 2011. The purpose of the meeting was to provide an overview of recent EPA proposals impacting the power sector. Specifically, overviews of the Transport Rule, the Mercury and Air Toxics Standards, and the Clean Water Act 316(b) Rule proposals were presented.

The EPA conducted outreach with representatives from 20 various small entities that potentially would be affected by this rule. The representatives included small entity municipalities, cooperatives, and private investors. We distributed outreach materials to the small entity representatives; these materials included background, an overview of affected sources and GHG emissions from the power sector, an overview of CAA section 111, an assessment of CO<sub>2</sub> emissions control technologies, potential impacts on small entities, and a summary of the listening sessions. We met with eight of the small entity representatives, as well as three participants from organizations representing power producers, on June 17, 2011, to discuss the outreach materials, potential requirements of the rule, and regulatory areas where the EPA has discretion and could potentially provide flexibility.

A second outreach meeting was conducted on July 13, 2011. We met with nine of the small entity representatives, as well as three participants from organizations representing power producers. During the second outreach meeting, various small entity representatives and participants from organizations representing power producers presented information regarding issues of concern with respect to development of standards for GHG emissions. Specifically, topics suggested by the small entity representatives and discussed included: boilers with limited opportunities for efficiency improvements due to New Source Review (NSR) complications for conventional pollutants; variances per kilowatt-hour and in heat rates over monthly and annual operations; significance of plant age; legal issues; importance of future

determination of carbon neutrality of biomass; and differences between municipal government electric utilities and other utilities.

While formulating the provisions of this proposed regulation, the EPA also considered the input provided in the over 2.5 million public comments on the April 13, 2012 proposed rule (77 FR 22392). We invite comments on all aspects of the proposal and its impacts, including potential adverse impacts, on small entities.

## **6.5 Unfunded Mandates Reform Act (UMRA)**

This proposed rule does not contain a Federal mandate that may result in expenditures of \$100 million or more for State, local, or tribal governments, in the aggregate, or the private sector in any one year. The EPA believes this proposed rule will have negligible compliance costs associated with it over a range of likely sensitivity conditions because electric power companies will choose to build new EGUs that comply with the regulatory requirements of this proposed rule because of existing and expected market conditions. (See Chapter 5 for further discussion of sensitivities.) The EPA does not project any new coal-fired EGUs without CCS to be built. Thus, this proposed rule is not subject to the requirements of sections 202 or 205 of UMRA.

This proposed rule is also not subject to the requirements of section 203 of UMRA because it contains no regulatory requirements that might significantly or uniquely affect small governments.

In light of the interest in this rule among governmental entities, the EPA initiated consultations with governmental entities while formulating the provisions of the proposed regulation (77 FR 22392, April 13, 2012). The EPA invited the following 10 national organizations representing state and local elected officials to a meeting held on April 12, 2011, in Washington DC: 1) National Governors Association; 2) National Conference of State Legislatures, 3) Council of State Governments, 4) National League of Cities, 5) U.S. Conference of Mayors, 6) National Association of Counties, 7) International City/County Management Association, 8) National Association of Towns and Townships, 9) County Executives of America, and 10) Environmental Council of States. These 10 organizations representing elected state and local officials have been identified by the EPA as the “Big 10” organizations appropriate to contact for purposes of consultation with elected officials. The purposes of the consultation were to provide general background on the proposal, answer questions, and solicit input from

state/local governments. The EPA's consultation regarded planned actions for new and existing sources, but only new sources will be affected by this proposed action.

During the meeting, officials asked clarifying questions regarding CAA section 111 requirements and efficiency improvements that would reduce CO<sub>2</sub> emissions. In addition, they expressed concern with regard to the potential burden associated with impacts on state and local entities that own/operate affected utility boilers, as well as on state and local entities with regard to implementing the rule. Subsequent to the April 12, 2011 meeting, the EPA received a letter from the National Conference of State Legislatures. In that letter, the National Conference of State Legislatures urged the EPA to ensure that the choice of regulatory options maximizes benefit and minimizes implementation and compliance costs on state and local governments; to pay particular attention to options that would provide states with as much flexibility as possible; and to take into consideration the constraints of the state legislative calendars and ensure that sufficient time is allowed for state actions necessary to come into compliance.

While formulating the provisions of this proposed regulation, the EPA also considered the input provided in the over 2.5 million public comments on the April 13, 2012 proposed rule (77 FR 22392).

## **6.6 Executive Order 13132, Federalism**

This proposed action does not have federalism implications. It will not have substantial direct effects on the States, on the relationship between the national government and the States, or on the distribution of power and responsibilities among the various levels of government, as specified in EO 13132. This action will not impose substantial direct compliance costs on state or local governments nor will it preempt state law. Thus, Executive Order 13132 does not apply to this action. Prior to the April 13, 2012 proposal (77 FR 22392), the EPA consulted with state and local officials in the process of developing the proposed rule to permit them to have meaningful and timely input into its development. The EPA's consultation regarded planned actions for new and existing sources, but only new sources will be affected by this action. The UMRA discussion in this chapter includes a description of the consultation. The EPA met with 10 national organizations representing state and local elected officials to provide general background on the proposal, answer questions, and solicit input from state/local governments. The UMRA discussion in the preamble includes a description of the consultation. While formulating the provisions of this proposed regulation, the EPA also considered the input provided in the over 2.5 million public comments on the April 13, 2012 proposed rule (77 FR

22392). In the spirit of EO 13132, and consistent with EPA policy to promote communications between the EPA and state and local governments, the EPA specifically solicits comment on this proposed action from state and local officials.

#### **6.7 Executive Order 13175, Consultation and Coordination with Indian Tribal Governments**

This action does not have tribal implications, as specified in Executive Order 13175 (65 FR 67249, November 9, 2000). It would neither impose substantial direct compliance costs on tribal governments, nor preempt Tribal law. This proposed rule would impose requirements on owners and operators of new EGUs. The EPA is aware of three coal-fired EGUs located in Indian Country but is not aware of any EGUs owned or operated by tribal entities. The EPA notes that this proposal does not affect existing sources such as the three coal-fired EGUs located in Indian Country, but addresses CO<sub>2</sub> emissions for new EGU sources only. Thus, Executive Order 13175 does not apply to this action.

Although Executive Order 13175 does not apply to this action, EPA consulted with tribal officials in developing this action. Because the EPA is aware of Tribal interest in this proposed rule, prior to the April 13, 2012 proposal (77 FR 22392), the EPA offered consultation with tribal officials early in the process of developing the proposed regulation to permit them to have meaningful and timely input into its development. The EPA's consultation regarded planned actions for new and existing sources, but only new sources would be affected by this proposed action.

Consultation letters were sent to 584 tribal leaders. The letters provided information regarding the EPA's development of NSPS and emission guidelines for EGUs and offered consultation. A consultation/outreach meeting was held on May 23, 2011, with the Forest County Potawatomi Community, the Fond du Lac Band of Lake Superior Chippewa Reservation, and the Leech Lake Band of Ojibwe. Other tribes participated in the call for information gathering purposes. In this meeting, the EPA provided background information on the GHG emission standards to be developed and a summary of issues being explored by the agency. Tribes suggested that the EPA consider expanding coverage of the GHG standards to include combustion turbines, lowering the 250 MMBtu per hour heat input threshold so as to capture more EGUs, and including credit for use of renewables. The tribes were also interested in the scope of the emissions averaging being considered by the agency (e.g., over what time period, across what units) for a possible existing source standard. In addition, the EPA held a series of

listening sessions on the proposed action. Tribes participated in a session on February 17, 2011 with the state agencies, as well as in a separate session with tribes on April 20, 2011.

While formulating the provisions of this proposed regulation, the EPA also considered the input provided in the over 2.5 million public comments on the April 13, 2012 proposed rule (77 FR 22392).

The EPA will also hold additional meetings with tribal environmental staff to inform them of the content of this proposal, as well as provide additional consultation with tribal elected officials where it is appropriate. We specifically solicit additional comment on this proposed rule from tribal officials.

#### **6.8 Executive Order 13045, Protection of Children from Environmental Health Risks and Safety Risks**

The EPA interprets EO 13045 (62 FR 19885, April 23, 1997) as applying to those regulatory actions that concern health or safety risks, such that the analysis required under section 5-501 of the Order has potential to influence the regulation. This action is not subject to EO 13045 because it is based solely on technology performance.

#### **6.9 Executive Order 13211, Actions Concerning Regulations That Significantly Affect Energy Supply, Distribution, or Use**

This proposed action is not a “significant energy action” as defined in Executive Order 13211 (66 FR 28355, May 22, 2001), because it is not likely to have a significant adverse effect on the supply, distribution, or use of energy. This proposed action is anticipated to have negligible impacts on emissions, costs or energy supply decisions for the affected electric utility industry.

#### **6.10 National Technology Transfer and Advancement Act**

Section 12(d) of the NTTAA of 1995 (Public Law No. 104-113; 15 U.S.C. 272 note) directs the EPA to use Voluntary Consensus Standards (VCS) in their regulatory and procurement activities unless to do so would be inconsistent with applicable law or otherwise impractical. VCS are technical standards (e.g., materials specifications, test methods, sampling procedures, business practices) developed or adopted by one or more voluntary consensus bodies. The NTTAA directs the EPA to provide Congress, through annual reports to the OMB, with explanations when an agency does not use available and applicable VCS.



This proposed rulemaking involves technical standards. The EPA proposes to use the following standards in this proposed rule: D5287-08 (Standard Practice for Automatic Sampling of Gaseous Fuels), D4057-06 (Standard Practice for Manual Sampling of Petroleum and Petroleum Products), and D4177-95 (2010) (Standard Practice for Automatic Sampling of Petroleum and Petroleum Products). The EPA is proposing use of Appendices B, D, F, and G to 40 CFR part 75; these Appendices contain standards that have already been reviewed under the NTTAA.

The EPA welcomes comments on this aspect of the proposed rulemaking and, specifically, invites the public to identify potentially-applicable VCS and to explain why such standards should be used in this action.

#### **6.11 Executive Order 12898: Federal Actions to Address Environmental Justice in Minority Populations and Low-Income Populations**

Executive Order 12898 (59 FR 7629, February 16, 1994) establishes Federal executive policy on environmental justice. Its main provision directs Federal agencies, to the greatest extent practicable and permitted by law, to make environmental justice part of their mission by identifying and addressing, as appropriate, disproportionately high and adverse human health or environmental effects of their programs, policies, and activities on minority populations and low-income populations in the U.S.

This proposed rule limits GHG emissions from new fossil fuel-fired EGUs by establishing national emission standards for CO<sub>2</sub>. The EPA has determined that this proposed rule will not result in disproportionately high and adverse human health or environmental effects on minority, low-income, and indigenous populations because it increases the level of environmental protection for all affected populations without having any disproportionately high and adverse human health or environmental effects on any population, including any minority, low-income, or indigenous populations.

---

United States  
Environmental Protection  
Agency

Office of Air Quality Planning and Standards  
Health and Environmental Impacts Division  
Research Triangle Park, NC

Publication No. EPA-452/R-13-003  
September 2013

---