

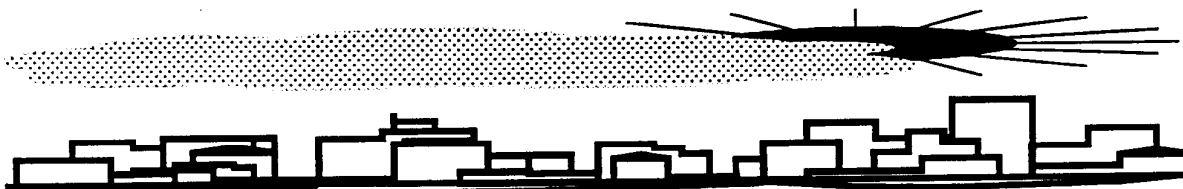

# LOCATING AND ESTIMATING AIR EMISSIONS FROM SOURCES OF METHYL CHLOROFORM



L & E

EPA-454/R-93-045

LOCATING AND ESTIMATING AIR EMISSIONS  
FROM SOURCES OF METHYL CHLOROFORM

Office of Air Quality Planning and Standards  
U.S. Environmental Protection Agency  
Research Triangle Park, North Carolina 27711

February 1994

## DISCLAIMER

This report has been reviewed by the Office of Air Quality Planning and Standards, and has been approved for publication. Any mention of tradenames or commercial products is not intended to constitute endorsement or recommendation for use.

# CONTENTS

Section	Page
DISCLAIMER . . . . .	ii
LIST OF FIGURES . . . . .	v
LIST OF TABLES . . . . .	vi
1.0 PURPOSE OF DOCUMENT . . . . .	1-1
1.1 Reference for Section 1.0 . . . . .	1-5
2.0 OVERVIEW OF DOCUMENT CONTENTS . . . . .	2-1
2.1 References for Section 2.0 . . . . .	2-5
3.0 BACKGROUND . . . . .	3-1
3.1 Nature of Pollutant . . . . .	3-1
3.2 Regulatory Actions Affecting Methyl Chloroform Production and Use . . . . .	3-4
3.3 Overview of Production and Use . . . . .	3-7
3.4 References for Section 3.0 . . . . .	3-10
4.0 EMISSIONS FROM METHYL CHLOROFORM PRODUCTION . . . . .	4-1
4.1 Production Process Descriptions . . . . .	4-2
4.1.1 Hydrochlorination of Vinyl Chloride . . . . .	4-4
4.1.2 Hydrochlorination of Vinylidene Chloride . . . . .	4-7
4.1.3 Noncatalytic Chlorination of Ethane . . . . .	4-7
4.2 Emissions . . . . .	4-10
4.2.1 Process Emissions . . . . .	4-12
4.2.2 Storage Emissions . . . . .	4-13
4.2.3 Equipment Leak Emissions (Fugitive Emissions) . . . . .	4-15
4.3 References for Section 4.0 . . . . .	4-19
5.0 EMISSIONS FROM MAJOR USES OF METHYL CHLOROFORM . . . . .	5-1
5.1 Solvent Cleaning . . . . .	5-2
5.1.1 Process Description . . . . .	5-3
5.1.2 Emissions . . . . .	5-5
5.2 Paint and Ink Manufacturing . . . . .	5-8
5.2.1 Process Description . . . . .	5-11
5.2.2 Emissions . . . . .	5-15
5.3 Aerosol Manufacturing . . . . .	5-16
5.4 Adhesive Manufacturing . . . . .	5-18
5.5 Chemical Intermediates . . . . .	5-20
5.6 Miscellaneous End Uses of Methyl Chloroform . . . . .	5-22
5.7 References for Section 5.0 . . . . .	5-24

## TABLE OF CONTENTS (continued)

Section	Page	
6.0	RESIDUAL AND BY-PRODUCT EMISSIONS OF METHYL CHLOROFORM . . . . .	6-1
6.1	Surface Coating Operations . . . . .	6-1
6.1.1	Process Description . . . . .	6-3
6.1.2	Emissions . . . . .	6-3
6.2	Wastewater Treatment Processes . . . . .	6-7
6.3	Pulp and Paper Production . . . . .	6-10
6.3.1	Description of Pulp Processing . . . . .	6-10
6.3.2	Atmospheric Emissions from Pulp Processing . . . . .	6-12
6.4	References for Section 6.0 . . . . .	6-13
7.0	AMBIENT AIR AND STATIONARY SOURCE TEST PROCEDURES . . . . .	7-1
7.1	EPA Method TO-1 . . . . .	7-1
7.2	EPA Method TO-2 . . . . .	7-2
7.3	EPA Method TO-14 . . . . .	7-5
7.4	EPA Method 0030 . . . . .	7-8
7.5	EPA Method 5040 . . . . .	7-8
7.6	References for Section 7.0 . . . . .	7-12
APPENDIX A	POTENTIAL SOURCE CATEGORIES OF METHYL CHLOROFORM EMISSIONS . . . . .	A-1
APPENDIX B	LISTS OF PAINT, INK, AND PRINTING FACILITIES WITH ANNUAL SALES GREATER THAN \$1 MILLION . . . . .	B-1
APPENDIX C	SUMMARY OF EMISSION FACTORS LISTED IN THIS DOCUMENT . . . . .	C-1

## LIST OF FIGURES

<b>Number</b>		<b>Page</b>
3-1	Chemical Use Tree for Methyl Chloroform . . . . .	3-8
4-1	Process Flow Diagram for the Hydrochlorination of Vinyl Chloride . . . . .	4-5
5-1	Flow Diagram of the Paint and Ink Manufacturing Process . . . . .	5-14
6-1	Flow Diagram of a Surface Coating Operation . . . . .	6-4
6-2	Typical Kraft Sulfate Pulping and Recovery Process . . . . .	6-11
7-1	EPA Method TO-1 Sampling System . . . . .	7-3
7-2	Tenax <sup>®</sup> Cartridge Design . . . . .	7-4
7-3	Carbon Molecular Sieve Trap (CMS) Construction . . . . .	7-6
7-4	Canister Sampling System . . . . .	7-7
7-5	Schematic of Volatile Organic Sampling Train (VOST) . . . . .	7-9
7-6	Schematic Diagram of Trap Desorption/Analysis System . . . . .	7-11

## LIST OF TABLES

<b>Number</b>		<b>Page</b>
3-1	Chemical Identification of Methyl Chloroform . . . . .	3-2
3-2	Physical and Chemical Properties of Methyl Chloroform . . . . .	3-3
3-3	Corporate Reduction and Phase-out Policies for Methyl Chloroform . . . . .	3-5
3-4	End Uses of Methyl Chloroform . . . . .	3-9
4-1	Methyl Chloroform Production Locations and Capacities . . . . .	4-2
4-2	Estimated Domestic U.S. Supply and Demand of Methyl Chloroform . . . . .	4-3
4-3	Methyl Chloroform Production Emissions . . . . .	4-11
4-4	Methyl Chloroform Emission Factors from Methyl Chloroform Production . . . . .	4-12
4-5	Average Emission Factors for Fugitive Equipment Leak Emissions . . . . .	4-16
4-6	Control Techniques and Efficiencies Applicable to Equipment Leak Emissions . . . . .	4-18
5-1	Summary of Emissions Tests on Idling OTVC (Using Methyl Chloroform as Solvent) . . . . .	5-8
5-2	Summary of Emissions Tests on Working OTVC (Using Methyl Chloroform as Solvent) . . . . .	5-9
5-3	Estimated Consumption of Solvents in Paints and Coatings, by Market . . . . .	5-12
5-4	Aerosol Products Containing Methyl Chloroform . . . . .	5-17
5-5	Adhesive Subcategories and Number of Facilities Using Methyl Chloroform . . . . .	5-19
6-1	Methyl Chloroform Source Categories in Surface Coating Operations . . . . .	6-2

## EXECUTIVE SUMMARY

Emissions of methyl chloroform into the atmosphere are of special significance because of the 1990 Clean Air Act Amendments. These amendments mandate that methyl chloroform emissions be subject to standards that allow for the maximum degree of reduction of emissions and that, by 1995, a list of source categories be established that accounts for no less than 90 percent of methyl chloroform emissions. This document is designed to assist groups interested in inventorying air emissions of methyl chloroform by providing a compilation of available information on sources and emissions of this substance.

Methyl chloroform, also commonly known as 1,1,1, trichloroethane, is a man-made chlorinated solvent. In the U.S., methyl chloroform is produced by three facilities. All three produce methyl chloroform by the hydrochlorination of vinyl chloride to yield 1,1-dichloroethane, which is then thermally dechlorinated to methyl chloroform. The total annual production capacity in the U.S. for 1992 was 477,000 megagrams (1050 million pounds).

Metal cleaning accounts for 49% of the total methyl chloroform used. It is also used for the manufacture of aerosols, adhesives, coating and inks, as chemical intermediates, and in the textiles and electronics industries.

At the time of publication of this document, estimates of nationwide methyl chloroform emissions were not available. Updates to this document will attempt to incorporate any nationwide emission estimates subsequently developed.

It is important to note that production of methyl chloroform will decline as a result of the Montreal Protocol on Substances that Deplete the Ozone Layer (Montreal Protocol) and Title VI of the 1990 Clean Air Act Amendments. Methyl chloroform is classified as a controlled



substance and is scheduled for phase-out by 2005 under the Montreal Protocol and 2002 under the amendments. The EPA also published a final rule in the Federal Register on December 10, 1993 that accelerates the schedule for phase-out of methyl chloroform production to January 1, 1996.

SECTION 1.0  
PURPOSE OF DOCUMENT

The Environmental Protection Agency (EPA) and State and local air pollution control agencies are becoming increasingly aware of the presence of substances in the ambient air that may be toxic to humans at certain concentrations. This awareness, in turn, has led to attempts to identify source/receptor relationships for these substances and to develop control programs to regulate emissions. Unfortunately, very little information is available on the ambient air concentrations of these substances or on the sources that may be discharging them to the atmosphere.

To assist groups interested in inventorying air emissions of various potentially toxic substances, EPA is preparing a series of documents such as this that compiles available information on sources and emissions of these substances. Prior documents in the series are listed below:

<u>Substance</u>	<u>EPA Publication Number</u>
Acrylonitrile	EPA-450/4-84-007a
Carbon Tetrachloride	EPA-450/4-84-007b
Chloroform	EPA-450/4-84-007c
Ethylene Dichloride	EPA-450/4-84-007d
Formaldehyde (Revised)	EPA-450/2-91-012
Nickel	EPA-450/4-84-007f
Chromium	EPA-450/4-84-007g
Manganese	EPA-450/4-84-007h
Phosgene	EPA-450/4-84-007i
Epichlorohydrin	EPA-450/4-84-007j
Vinylidene Chloride	EPA-450/4-84-007k
Ethylene Oxide	EPA-450/4-84-007l
Chlorobenzenes	EPA-450/4-84-007m
Polychlorinated Biphenyls (PCBs)	EPA-450/4-84-007n
Polycyclic Organic Matter (POM)	EPA-450/4-84-007p
Benzene	EPA-450/4-84-007q
Organic Liquid Storage Tanks	EPA-450/4-88-004
Coal and Oil Combustion Sources	EPA-450/2-89-001
Municipal Waste Combustors	EPA-450/2-89-006
Perchloroethylene and Trichloroethylene	EPA-450/2-90-013

<u>Substance</u>	<u>EPA Publication Number</u>
1,3-Butadiene	EPA-450/2-89-021
Chromium (supplement)	EPA-450/2-89-002
Sewage Sludge	EPA-450/2-90-009
Styrene	EPA-450/4-91-029
Methylene Chloride	EPA-454/R-93-006

This document deals specifically with methyl chloroform. Its intended audience includes federal, State, and local air pollution personnel and others who are interested in locating potential emitters of methyl chloroform, and making gross estimates of air emissions therefrom.

Because of the limited amounts of data available on potential sources of methyl chloroform emissions, and since the process configurations, control equipment, and operating procedures of many sources will not be the same as those described here, this document is best used as a primer to inform air pollution personnel about (1) the types of sources that may emit methyl chloroform, (2) process variations and release points that may be expected within these sources, and (3) available emissions information indicating the potential for methyl chloroform to be released into the air from each operation.

The reader is strongly cautioned against using the emissions information contained in this document to try to develop an exact assessment of emissions from any particular facility. Because insufficient data are available to develop statistical estimates of the accuracy of these emission factors, no estimate can be made of the error that could result when these factors are used to calculate emissions from any given facility. It is possible, in some extreme cases, that order-of-magnitude differences could result between actual and calculated emissions, depending on differences in source configurations, control equipment, and operating practices. Thus, in situations where an accurate assessment of methyl chloroform emissions is necessary, source-specific information should be obtained to confirm the existence of particular emitting operations, the types and effectiveness of control measures, and the impact of operating practices. A source test and in some cases a material balance should be considered as the best means to determine air emissions directly from an operation.

In addition to the information presented in this document, another potential source of emissions data for methyl chloroform is the Toxic Chemical Release Inventory (TRI) database required by Section 313 of Title III of the Superfund Amendments and Reauthorization Act of 1986 (SARA 313).<sup>1</sup> SARA 313 requires owners and operators of certain facilities that manufacture, import, process, or otherwise use certain toxic chemicals to report annually their releases of these chemicals to any environmental media. As part of SARA 313, EPA provides public access to the annual emissions data. The TRI data include general facility information, chemical information, and emissions data. Air emissions data are reported as total facility release estimates, broken out into fugitive and point components. No individual process or stack data are provided to EPA. The TRI requires the use of available stack monitoring or measurement of emissions to comply with SARA 313. If monitoring data are unavailable, emissions are to be quantified based on best estimates of releases to the environment.

The reader is cautioned that the TRI will not likely provide facility, emissions, and chemical release data sufficient for conducting detailed exposure modeling and risk assessment. In many cases, the TRI data are based on annual estimates of emissions (*i.e.*, on emission factors, material balances, engineering judgement). Although the TRI database was consulted during the development of this report, it should be referred to as an additional source to locate potential emitters of methyl chloroform, and to make preliminary estimates of air emissions from these facilities. In addition, the reader should be cautioned that only facilities using greater than 25,000 pounds of methyl chloroform in production activities (*e.g.*, incorporated into the product) or greater than 10,000 pounds for other purposes (*e.g.*, degreasing) would be required to file emissions under SARA 313. Facilities with smaller uses would not necessarily appear in the TRI database. To obtain an exact assessment of air emissions from processes at a specific facility, source tests or in some cases detailed material balance calculations should be conducted, and detailed plant site information should be compiled.

Each L&E document, as standard procedure, is sent to government, industry, and environmental groups wherever EPA is aware of expertise. These groups are given the opportunity to review the document, comment, and provide additional data where applicable. Where necessary, the documents are then revised to incorporate these comments. Although these

documents have undergone extensive review, there may still be shortcomings. Comments subsequent to publication are welcome and will be addressed based on available time and resources. In addition, any information is welcome on process descriptions, operating parameters, control measures, and emissions information that would enable EPA to improve the contents of this document. Comments and information may be sent to the following address:

Chief, Emission Factor and Methodologies Section  
Emission Inventory Branch, (MD-14)  
U.S. Environmental Protection Agency  
Research Triangle Park, NC 27711

1.1 REFERENCE FOR SECTION 1.0

1. Toxic Chemical Release Reporting: Community Right-To-Know. Federal Register **52**(107): 21152-21208. June 4, 1987.

## SECTION 2.0 OVERVIEW OF DOCUMENT CONTENTS

The purpose of this document is to assist federal, State, and local air pollution agencies and others who are interested in locating potential air emitters of methyl chloroform and making gross estimates of air emissions therefrom. Because of the limited background data available, the information summarized in this document does not and should not be assumed to represent the source configuration or emissions associated with any particular facility.

This section provides an overview of the contents of this document. It briefly outlines the nature, extent, and format of the material presented in the remaining sections of this report.

Section 3.0 of this document briefly summarizes the physical and chemical characteristics of methyl chloroform, and provides an overview of its production and use. This background section may be useful to someone who needs to develop a general perspective on the nature of this substance and how it is manufactured and consumed.

Section 4.0 of this document focuses on major production source categories that may discharge air emissions containing methyl chloroform. Section 5.0 discusses the uses of methyl chloroform as industrial feedstocks and major solvent uses, particularly degreasing and coating operations. Section 6.0 addresses emissions as a result of releases from methyl chloroform-containing products after manufacture and emissions resulting from the manufacture of products other than methyl chloroform, or as a by-product of processes (*e.g.*, kraft pulping). Example process descriptions and flow diagrams are provided in addition to available emission factor estimates for each major industrial source category described in Sections 4.0, 5.0, and 6.0. Individual companies involved with either the production or use of methyl chloroform are reported throughout the document. The information reported is extracted primarily from trade publications.

Section 7.0 of this document summarizes available procedures for source sampling and analysis of methyl chloroform. The summaries provide an overview of applicable sampling and analytical procedures, citing references for those interested in conducting source tests.

Appendix A identifies potential source categories of methyl chloroform emissions by Standard Industrial Classification (SIC) code and associated description. These potential source categories do not necessarily denote significant sources of methyl chloroform emissions. The readers interested in cross referencing SICs with Source Classification Codes (SCCs) and associated descriptions should consult the *Crosswalk/Air Toxic Emission Factor Database Management System*, Version 1.2 (October 1991) and/or the *Volatile Organic Compound (VOC)/Particulate Matter (PM) Speciation Database Management System*, Version 1.4 (October 1991).<sup>1,2</sup> Appendix B lists paint and ink manufacturing facilities and printing facilities with sales greater than \$1,000,000. Appendix C summarizes, in table format, all emission factors listed in this document.

Each emission factor listed in Sections 3.0 through 6.0 has been assigned an emission factor grade based on the criteria for assigning data quality and emission factor ratings as required in the document *Technical Procedures for Developing AP-42 Emission Factors and Preparing AP-42 Sections*. These criteria for rating test data used to develop emission factors are presented below.<sup>3</sup> The data used to develop emission factors are rated as follows:

- A - Tests performed by a sound methodology and reported in enough detail for adequate validation. These tests are not necessarily EPA reference test methods, although such reference methods are certainly to be used as a guide.
- B - Tests that are performed by a generally sound methodology but lack enough detail for adequate validation.
- C - Tests that are based on a nonvalidated or draft methodology or that lack a significant amount of background data.
- D - Tests that are based on a generally unacceptable method but may provide an order-of-magnitude value for the source.



Because of the almost impossible task of assigning a meaningful confidence limit to industry-specific variables (*i.e.*, sample size vs. sample population, industry and facility variability, method of measurement), the use of a statistical confidence interval for an emission factor is not practical. Therefore, some subjective quality rating is necessary. The following emission factor quality ratings are applied to the emission factor tables.

A - Excellent. The emission factor was developed only from A-rated test data taken from many randomly chosen facilities in the industry population. The source category\* is specific enough to minimize variability within the source category population.

B - Above average. The emission factor was developed only from A-rated test data from a reasonable number of facilities. Although no specific bias is evident, it is not clear if the facilities tested represent a random sample of the industries. As in the A rating, the source category is specific enough to minimize variability within the source category population.

C - Average. The emission factor was developed only from A- and B-rated test data from a reasonable number of facilities. Although no specific bias is evident, it is not clear if the facilities tested represent a random sample of the industry. As in the A rating, the source category is specific enough to minimize variability within the source category population.

D - Below average. The emission factor was developed only from A- and B-rated test data from a small number of facilities, and there may be reason to suspect that these facilities do not represent a random sample of the industry. There also may be evidence of variability within the source category population. Limitations on the use of the emission factor are footnoted in the emission factor table.

E - Poor. The emission factor was developed from C- and D-rated test data, and there may be reason to suspect that the facilities tested do not represent a random sample of the industry. There also may be evidence of variability within the source category population. Limitations on the use of these factors are always footnoted.

U - Unrated or Unratable. The emission factor was developed from suspect data with no supporting documentation to accurately apply an A through E rating. A "U" rating may be applied in the following circumstances:<sup>4</sup>

- a gross mass balance estimation
- QA/QC deficiencies found with C- and D-rated test data
- gross engineering judgement
- technology transfer

---

\*Source category: A category in the emission factor table for which an emission factor has been calculated; generally a single process.

This document does not contain any discussion of health or other environmental effects of methyl chloroform. It does include a discussion of ambient air monitoring techniques; however, these ambient air monitoring methods may require modifications for stack sampling and may affect data quality.

## 2.1 REFERENCES FOR SECTION 2.0

1. U.S. Environmental Protection Agency. *Crosswalk/Air Toxic Emission Factor Database Management System*, Version 1.2. Office of Air Quality Planning and Standards. Research Triangle Park, NC. October 1991.
2. U.S. Environmental Protection Agency. *Volatile Organic Compound (VOC)/Particulate Matter (PM) Speciation Database Management System*, Version 1.4. Office of Air Quality Planning and Standards, Research Triangle Park, NC. September 1990.
3. U.S. Environmental Protection Agency. *Technical Procedures for Developing AP-42 Emission Factors and Preparing AP-42 Sections*, Draft Document. Office of Air Quality Planning and Standards. Research Triangle Park, NC. March 1992.
4. Group discussion meeting on applying "U" rating to emission factors. Anne Pope, EIB; Robin Baker Jones, Midwest Research Institute; Garry Brooks, Radian Corporation; and Theresa Moody, TRC Environmental Corporation.

## SECTION 3.0 BACKGROUND

### 3.1 NATURE OF POLLUTANT

Methyl chloroform or 1,1,1-trichloroethane, is a man-made chlorinated solvent. The first commercial success of methyl chloroform was as a replacement for the toxic carbon tetrachloride in room temperature metal cleaning operations.<sup>1,2</sup> Cleaning operations, including cold cleaning and vapor degreasing, remain the largest end use of methyl chloroform.

Methyl chloroform's molecular structure is represented as:

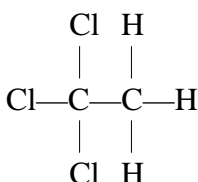

Table 3-1 summarizes the chemical identification information for methyl chloroform, and Table 3-2 presents methyl chloroform's chemical and physical properties. Methyl chloroform tends to decompose in the presence of heat, light, oxygen, and water. Decomposition may be accelerated by the presence of metals or metal salts and by the decomposition products of chlorohydrocarbons. For this reason, methyl chloroform is normally stabilized prior to shipment with one of three types of stabilization chemicals:

- antioxidants
- compounds which will neutralize the autocatalytic action of products resulting during decomposition reactions
- chemicals that inhibit catalytic action of metals

Stabilizers, such as 1,2-butylene oxide, cyclohexene oxide, nitromethane, 1,4-dioxane, diallylamine, or cyclic amines, are often added to methyl chloroform in quantities up to five percent to prevent decomposition. Stabilization is especially important if the methyl chloroform

**TABLE 3-1.**  
**CHEMICAL IDENTIFICATION OF METHYL CHLOROFORM**

Chemical name	Methyl chloroform
Synonyms	1,1,1-trichloroethane; ethylidene chloride; methyltrichloromethane; trielene; algylen; trichloromethylmethane; chloroethane; inhibisol; trichloran; gemalgene; TCA; TCEA; aerothene; $\alpha$ -Trichloroethane; 1,1,1-TCE; 1,1,1-Tri; trichloroethane
Molecular formula	$C_2H_3Cl_3$
Identification numbers: <sup>a</sup>	
CAS Registry	71-55-6
NIOSH RTECS	KJ 2975000
EPA Hazardous Waste	U226, F002
OHM/TADS	8100101
DOT/UN/NA/IMCO	UN 2831; 1,1,1-Trichloroethane IMO 6.1; 1,1,1-Trichloroethane
HSDB	157
STCC	49 411 76; 1,1,1-Trichloroethane

Source: References 3-5.

<sup>a</sup>CAS (Chemical Abstracts Services); NIOSH (National Institute of Occupational Safety and Health); RTECS (Registry of Toxic Effects of Chemical Substances); EPA (Environmental Protection Agency); OHM/TADS (Oil and Hazardous Materials/Technical Assistance Data System); DOT/UN/NA/IMCO (Department of Transportation/United Nations/North America/International Maritime Dangerous Goods Code); HSDB (Hazardous Substance Database); STCC (Standard Transport Commodity Code).

**TABLE 3-2.**  
**PHYSICAL AND CHEMICAL PROPERTIES OF METHYL**  
**CHLOROFORM**

Property	Value
Molecular weight (grams)	133.42
Melting point	-30.4°C (-22.7°F)
Boiling point (760 mm Hg)	74.1°C (165.4°F)
Density, g/cm <sup>3</sup> at 25°C (77°F) at 20°C (68°F)	1.136 1.324
Physical state (ambient conditions) Color	Liquid Clear
Specific heat at 20°C (68°F) liquid gas Heat capacity at 25°C (77°F) and 760 mm Hg liquid gas	1.004 J/g 0.782 J/g 34.4 cal/gmol 22.4 cal/gmol
Solubility: Water at 20°C (68°F)  Organic solvents	Insoluble (0.095 g in 100 g water) 0.034 g (water in 100 g methyl chloroform)  Soluble in acetone, benzene, carbon tetrachloride, methanol and ether
Partition coefficients: Log <sub>10</sub> octanol/water	2.49 (20°C or 68°F)
Vapor pressure at 20°C (68°F) at 40°C(104°F)	13.3 kPa (99.8 mm Hg) 31.7 kPa (237.8 mm Hg)
Autoignition temperature	537°C (999°F)
Critical temperature	311.5°C (592.7°F)
Critical pressure	4.48 MPa (44.2 atm)
Binary azeotropes, boiling point with 4.3 percent water with 23 percent methanol with 17.4 percent ethanol with 17 percent isopropyl alcohol with 17.2 percent tert-butyl alcohol	65.0°C (149°F) 55.5°C (131.9°F) 64.4°C (147.9°F) 68.2°C (154.8°F) 70.2°C (158.4°F)
Conversion factors (Vapor weight to volume)	1 ppm = 5.46 mg/L (25°C or 77°F)
Viscosity at 20°C (68°F)	0.858 mPa•s

Source: References 2,4-8.

is to be used for vapor degreasing operations where the chemical will be exposed to high temperatures, metals, and other contaminants.<sup>9</sup>

Methyl chloroform released to the water is expected to have an evaporative half-life ranging from several hours to a few weeks depending on wind and mixing conditions.<sup>10</sup> Methyl chloroform is released to the atmosphere during its manufacture and from the use of methyl chloroform-containing materials. Methyl chloroform has also been detected in small amounts in the ambient air and wastewater at kraft pulp mills and wastewater treatment facilities.<sup>10,11</sup>

Methyl chloroform is relatively stable in the atmosphere with an estimated half-life of 6 months to 25 years.<sup>12</sup> Only a small portion of the methyl chloroform released to the air is removed in the troposphere (*i.e.*, the region of the atmosphere extending from the ground to as high as 15 kilometers) by reaction with hydroxyl radicals. For this reason, the EPA has identified methyl chloroform as being negligibly photochemically reactive. However, the portion that does not react in the troposphere may be conveyed to the stratosphere. There, the methyl chloroform participates in the depletion of the stratospheric ozone layer.<sup>13</sup> Methyl chloroform is the highest volume ozone-depleting chemical and is responsible for 16 percent of the ozone-destroying chlorine now in the stratosphere from anthropogenic sources.<sup>14,15</sup>

### 3.2 REGULATORY ACTIONS AFFECTING METHYL CHLOROFORM PRODUCTION AND USE

Consumption and production of methyl chloroform will decline as a result of the implementation of the 1987 Montreal Protocol on Substances that Deplete the Ozone Layer and Title VI of the 1990 Clean Air Act Amendments (CAAA).<sup>16</sup> Under both of these provisions, methyl chloroform is classified as a controlled substance scheduled for phase-out within the next ten years (*i.e.*, 2005 under the 1990 Revision of the Montreal Protocol and 2002 under the 1990 CAAA).<sup>17,18</sup> In addition to the scheduled regulatory phase-outs, several corporations have voluntarily implemented reduction and phase-out policies. A summary of these corporate strategies is included in Table 3-3.

**TABLE 3-3.  
CORPORATE REDUCTION AND PHASE-OUT POLICIES FOR  
METHYL CHLOROFORM**

Year	Type of Policy/ Implementing Corporation	Location	Comments
1990	Significant reductions: Eveready Mobil	Asheboro, NC Shawnee, OK	(90% reduction from 1988 level.) Replace use in maintenance-rebuild area.
1991	Discontinue use: Fischer Controls International	Marshalltown, IA	
1992	Significant reductions: Boeing	Company-wide	20% reduction
1995	Discontinue use: MEMC Electronic Materials	Spartanburg, SC	
	Significant reductions: Boeing	Company-wide	50% reduction
2000	Significant reductions: American Electronics Association	Member companies	40% overall emissions reduction

Source: Reference 14.



Both the Montreal Protocol and the CAAA Title VI contain several definitions and exemptions which apply to methyl chloroform production and consumption. Title VI defines a controlled substance as

...(a listed substance) existing alone or in a mixture, but excluding any such substance or mixture that is in a manufactured product other than a container used for the transportation or storage of the substance or mixture. ...If a listed substance or mixture must first be transferred from a bulk container to another container, vessel, or piece of equipment in order to realize its intended use, the listed substance or mixture is a controlled substance.

Production, as defined by the CAAA, is the

manufacture of a substance from any raw material or feedstock chemical, but does not include the manufacture of a substance that is used and entirely consumed (except for trace quantities) in the manufacture of other chemicals or the reuse or recycling of a substance.

Coincidental unavoidable by-product (CUBP) is defined by the CAA, as "a product that is unintentionally manufactured in the course of manufacturing another product." While spills and vent releases of methyl chloroform in excess of 45 kgs (100 lbs) per event are "produced" and "controlled," the production of a CUBP immediately contained and destroyed by the producer using the maximum achievable control technology (MACT) is considered neither produced nor controlled.<sup>15</sup> Another production exception is the "use and entire consumption in the manufacture of other chemicals." In order to fit this clause, methyl chloroform must be transformed or broken down so that it is physically impossible to recover after its use.<sup>18</sup> According to clarifications provided by EPA, commercial processes in which methyl chloroform is used and entirely consumed but not transformed (*e.g.*, uses of methyl chloroform as reaction inhibitors, solvents, or inert direct coolants) are controlled and subject to the phase-out requirements.<sup>17,18</sup> This means that most of the end-uses of methyl chloroform (*e.g.*, solvent degreasing, adhesives, and coatings and inks) will fall under the phase-out requirements.<sup>15</sup>

Section 604(d)(1) of the CAAA provides for another exemption to the 1992 phase-out requirements for essential uses of methyl chloroform for which no safe and effective substitute is available. One essential use is anticipated to be in the limited production of halon-1211, halon-1301, and halon-2402 for purposes of aviation safety. Another potential essential use is in the nondestructive testing for metal fatigue and corrosion of existing airplane engines and airplane parts susceptible to metal fatigue. The third potential exception for essential uses of methyl chloroform is for use in medical devices.<sup>18</sup> Facilities using methyl chloroform in manufacturing must label the product stating that a stratospheric ozone depleting substance has been used. However, the EPA will not make a final determination on essential use exemptions until the availability of methyl chloroform is more constrained.

### 3.3 OVERVIEW OF PRODUCTION AND USE

The total annual capacity of methyl chloroform manufacturing facilities in the United States has been 477 million kgs (1,050 million lbs) for the years 1986 through 1992.<sup>3,19</sup> The three domestic facilities known to manufacture methyl chloroform do so by the hydrochlorination of vinyl chloride to yield 1,1-dichloroethane, which is then thermally chlorinated to methyl chloroform. Currently, production of methyl chloroform exceeds demand.<sup>15</sup>

The primary end use for methyl chloroform is metal cleaning. Together, vapor degreasing and cold cleaning account for 49 percent of methyl chloroform end use.<sup>19</sup> Other end uses include aerosols (12 percent), adhesives (10 percent), chemical intermediates (10 percent), coatings and inks (7 percent), textiles (4 percent), electronics (3 percent), and miscellaneous uses (5 percent).<sup>19</sup> Facilities in every category of the manufacturing sector (represented by SIC codes 20-39) have reported emissions of methyl chloroform in the Toxic Chemical Release Inventory.<sup>14,20</sup> Figure 3-1 and Table 3-4 present some of the end uses of methyl chloroform. These uses will be discussed in detail in Sections 5.0 and 6.0. A list of all potential methyl chloroform emission sources organized according to SIC code and associated description is presented in Appendix A. It is important to note that these source categories do not necessarily denote significant sources of methyl chloroform emissions.

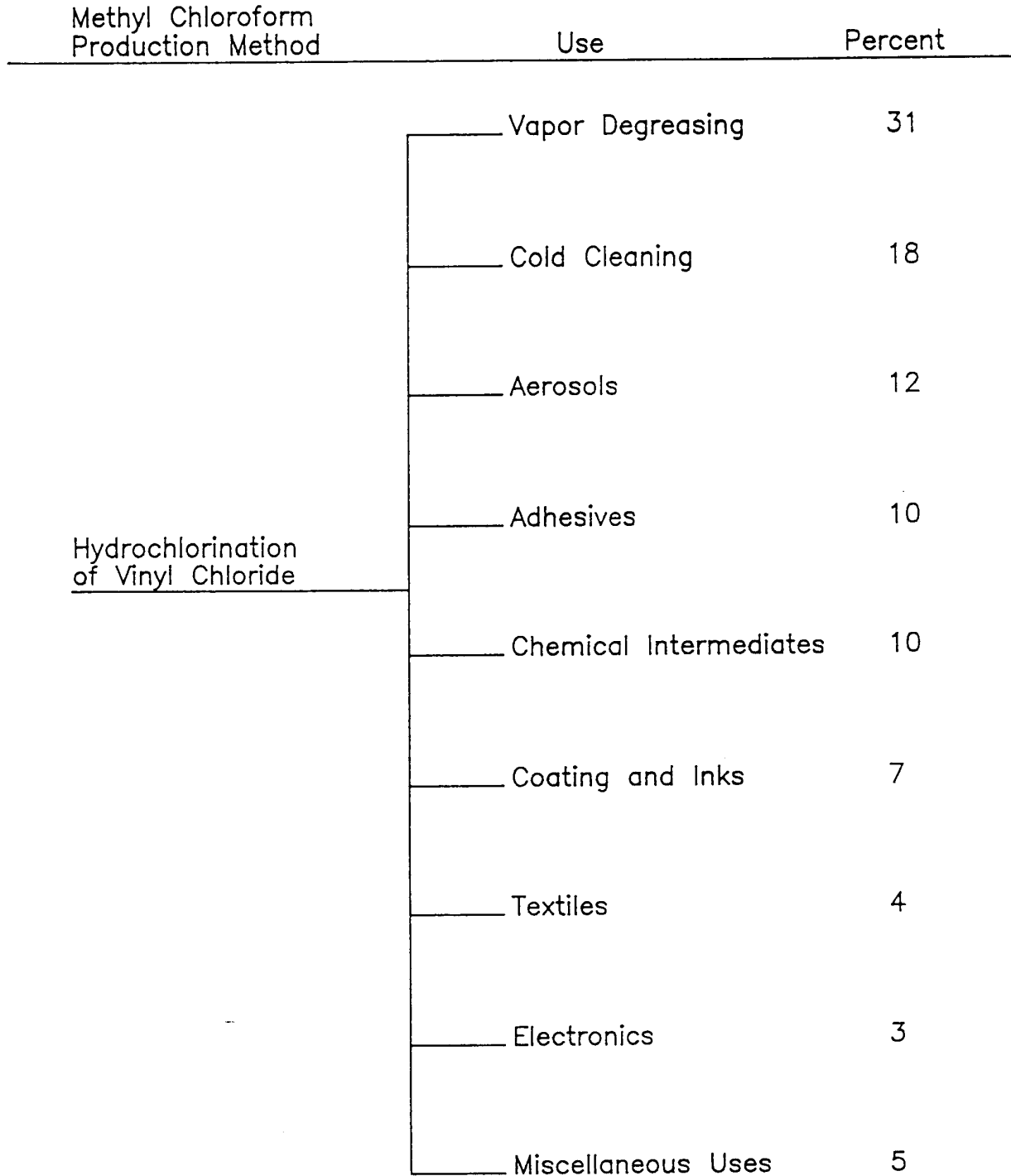

Figure 3-1. Chemical use tree for methyl chloroform.<sup>3,19</sup>

**TABLE 3-4.  
END USES OF METHYL CHLOROFORM**

Use Category	End Use
Metal Cleaning	cold cleaning conveyorized non-boiling degreasers conveyorized vapor degreasers
Aerosols	household products automotive products coatings and finishes personal care products pesticides
Adhesives	consumer and industrial formulations substitute for other solvents in urethane adhesives
Chemical Intermediates	hydrochlorofluorocarbon (HCFC) 142b hydrochlorofluorocarbon (HCFC) 141b
Coatings and Inks	traffic paints (lane lines, road arrows) grease cutter cleaner for typewriter keys gravure and flexographic inks
Textiles	scouring agents cleaning textile and machinery tools dye carrier spotting fluid
Electronics	cleaner to remove flux on printed circuit boards plasma etchant gases dry film photoresist developer
Miscellaneous	drain cleaners septic tank cleaners pharmaceutical extractant glossing and weatherproofing leather products plastic film cleaners (movie, video, TV film) coolant in cutting oils

Source: References 9, 11.

### 3.4 REFERENCES FOR SECTION 3.0

1. Archer, W.L, "Other Chloroethanes," *Kirk-Othmer Encyclopedia of Chemical Technology*, Third Edition. Vol. 5. John Wiley and Sons, New York, NY. pp. 722-742. 1979.
2. Considine, Douglas M., ed., *Chemical and Process Technology Encyclopedia*. McGraw-Hill Book Company, New York, NY. 1974.
3. "1,1,1-Trichloroethane," *Chemical Products Synopsis*. Mannsville Chemical Products, Ashbury Park, NJ. October 1990.
4. Hazardous Substance Database (HSDB): 1,1,1-Trichloroethane. National Institutes of Health, National Library of Medicine, Bethesda, MD. 1990.
5. Sax, Irving N. and Richard J. Lewis, Sr., *Dangerous Properties of Industrial Materials*. Volume III. Seventh Edition. Van Nostrand Reinhold, New York, NY. p. 3327. 1989.
6. *The Merck Index*, Tenth Edition. Merck Co., Inc., Rahway, NJ. p. 1377. 1983.
7. Weast, R.C., ed., *CRC Handbook of Chemistry and Physics*, Sixty-Ninth Edition. CRC Press, Inc., Boca Raton, FL. p. C-266. 1988.
8. Chiou, C.T., Peters, L.J., and Freed, V.H, "A Physical Concept of Soil-Water Equilibria for Nonionic Organic Compounds," *Science* 206: 831-832. 1979.
9. "C<sub>2</sub> Chlorinated Solvents," *Chemical and Economics Handbook*. SRI International, Menlo Park, CA. December 1988.
10. Personal communication with R. Sherwood, Pope and Talbot Pulp, Inc., Halsey, Oregon, by B. McMinn, TRC Environmental Corporation. "TRI Emissions of Methyl Chloroform." June 22, 1992.
11. Memorandum from M. A. Callahan, U.S. Environmental Protection Agency, to E. Anderson, U.S. Environmental Protection Agency. Public Docket A-84-41, II-B-1. Draft Exposure Assessment for TSPC Solvents.
12. Howard, Philip H., ed., *Handbook of Environmental Fate and Exposure Data for Organic Chemicals*, Volume II, Solvents. Lewis Publishers, Chelsea, MI. pp. 450-460. 1990.
13. U.S. Environmental Protection Agency. *Health Assessment Document for 1,1,1-Trichloroethane (Methyl Chloroform)*. EPA-600/8-82-003f. Office of Health and Environmental Assessment. Washington DC. 1984.

14. Sheiman, Deborah A., *et al.*, *A Who's Who of American Ozone Depleters: A Guide to 3,014 Factories Emitting Three Ozone-Depleting Chemicals*. Natural Resources Defense Council. January 1990.
15. U.S. Environmental Protection Agency. 40 CFR 82, "Protection of Stratospheric Ozone; Final Rule," *Federal Register*, July 30, 1992.
16. U.S. Environmental Protection Agency. 40 CFR 82, "Protection of Stratospheric Ozone," *Federal Register*, December 30, 1991.
17. United Nations Environment Programme. *Handbook for the Montreal Protocol on Substances that Deplete the Ozone Layer*. Ozone Secretariat. Nairobi, Kenya. May 1991.
18. Public Law 101-549. *The Clean Air Act Amendments of 1990*, Title VI - Stratospheric Ozone Protection. November 15, 1990.
19. "Chemical Profile: 1,1,1-Trichloroethane," *Chemical Marketing Reporter*. January 27, 1992.
20. Toxic Chemical Release Inventory (TRI). 1990.

## SECTION 4.0

### EMISSIONS FROM METHYL CHLOROFORM PRODUCTION

Methyl chloroform production and the associated air emissions are described in this section. Process flow diagrams are included where appropriate, with specific streams or vents in the figures labeled to correspond with the discussion in the text. Emission factors for the production processes are presented when available, and control technologies are described. If a particular facility is being included in an inventory, the reader is encouraged to contact the specific facility to verify the nature of the process used, production volume, and control technologies that are in place before applying any of the emission factors presented in this document.

Methyl chloroform is currently produced by three companies at three plants in the United States. The production locations and capacities are presented in Table 4-1. In 1992, the total annual capacity for all methyl chloroform manufacturing facilities was estimated at 477 million kgs (1,050 million lbs) per year.<sup>1</sup> In 1989, methyl chloroform production was 356 million kgs (783 million lbs).<sup>2</sup> Total production for 1992 is expected to be approximately 273 million kgs (600 million lbs), about 57 percent of available capacity. With the production and consumption phase-out required by Title VI of the 1990 Clean Air Act Amendments and the Montreal Protocol, demand for methyl chloroform should decrease by 11.6 percent per year through 1996, at which time demand is expected to be 165 million kgs (367 million lbs).<sup>1</sup> The 1990 CAAA mandate that new production of methyl chloroform be phased out by 2002. Effective January 1, 1991, an excise tax of 13.7 cents per pound was imposed on first time sales of methyl chloroform. The tax will gradually rise to 31 cents per pound by 1995.<sup>2</sup> Table 4-2 shows historical and projected figures for methyl chloroform capacity, production, imports, exports, and demand.

**TABLE 4-1.  
METHYL CHLOROFORM PRODUCTION LOCATIONS AND  
CAPACITIES**

<b>Facility</b>	<b>Location</b>	<b>1992 Capacity</b> millions of kilograms (millions of pounds)	
Dow Chemical Corporation	Freeport, TX	227	(500)
PPG Industries	Lake Charles, LA	159	(350)
Vulcan Materials Company	Geismar, LA	91	(200)
<b>TOTAL</b>		477	(1,050)

Source: Reference 1.

NOTE: This listing is subject to change as market conditions change, facility ownership changes, plants are closed, etc. The reader should verify the existence of particular facilities by consulting current listings and/or the plants themselves. The level of methyl chloroform emissions from any given facility is a function of variables such as capacity, throughput, and control measures, and should be determined through direct contacts with plant personnel. These operating plants and locations were current as of January 1992.

---

#### 4.1 PRODUCTION PROCESS DESCRIPTIONS

Methyl chloroform may be produced by several different processes. However, the only method that is presently used in the United States involves the hydrochlorination of vinyl chloride. Two additional production methods (hydrochlorination of vinylidene chloride and chlorination of ethane) are included in the following sections for informational purposes.



**TABLE 4-2.**  
**ESTIMATED DOMESTIC U.S. SUPPLY AND DEMAND OF METHYL CHLOROFORM<sup>a</sup>**

Millions of kilograms (millions of pounds)									
	1980	1985	1986	1987	1988	1989	1990	1991	1992
Capacity	434 (955)	455 (1000)	477(1050)	477 (1050)	477 (1050)	477 (1050)	477 (1050)	477 (1050)	477 (1050)
Production	315 (692)	268 (590)	296 (652)	315 (694)	329 (724)	356 (783)	365 (803)	295 (649)	273 (600 <sup>c</sup> )
Imports	None	6 (13)	5 (12)	8 (17)	10 (22)	13 (28)	4 (8 <sup>b</sup> )	None	None
Exports	28 (61)	18 (40)	39 (87)	50 (110)	43 (95)	56 (124)	56 (123 <sup>b</sup> )	None	None
Demand	287 (631)	256 (563)	262 (577)	273 (601)	296 (651)	312 (687)	293 (645 <sup>b</sup> )	None	282 (620 <sup>b</sup> )

Exports were reported by the USITC after 1978. Imports were reported for the first time in 1989 by the U.S. Government. Imports indicated above for years prior to 1989 are based on trade estimates. Production of 395 million kgs (869 million lbs) as reported by the USITC for 1985 was probably erroneously high and has been more realistically estimated at 268 million kgs (590 million lbs).

<sup>a</sup> Source: References 1, 2, 4.

<sup>b</sup> Figure is based on estimates from Reference 2.

<sup>c</sup> Figure is based on estimates from Reference 1.

#### 4.1.1 Hydrochlorination of Vinyl Chloride

The production of methyl chloroform by the hydrochlorination of vinyl chloride is a three step process. Figure 4-1 illustrates the hydrochlorination process. The process reactions are shown below:<sup>3</sup>

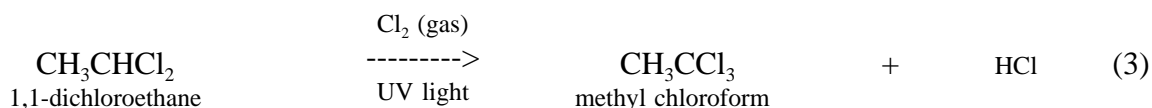
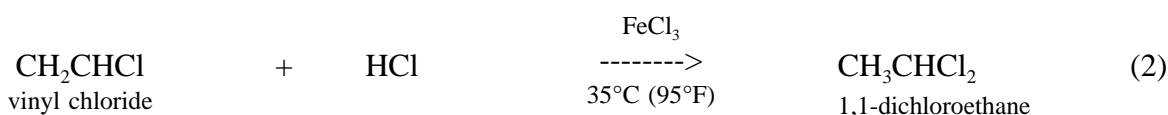

Reaction 1 involves the production of vinyl chloride monomer from 1,2-dichloroethane via dehydrochlorination (not shown in Figure 4-1). 1,2-Dichloroethane is introduced into a pyrolysis furnace where it is cracked in the vapor phase at temperatures of 450° to 620°C (842° to 1,148°F) and pressures of 450 to 930 kPa (3.4 to 7.0 atm). The conversion of 1,2-dichloroethane to vinyl chloride approaches 50 percent. The product gas stream from the furnace, containing vinyl chloride monomer, 1,2-dichloroethane, and hydrogen chloride, is quenched with liquid 1,2-dichloroethane and fed to a condenser. The hydrogen chloride is removed from the condenser in the gas phase and recovered for future use. The liquid stream from the condenser is fed to a distillation column where it is separated into vinyl chloride monomer product, unreacted 1,2-dichloroethane, and heavy-ends. The unreacted 1,2-dichloroethane is recycled either to the quench column or to the finishing section of a 1,2-dichloroethane plant.<sup>5</sup> The vinyl chloride product is then either sold to a facility that manufactures methyl chloroform, or, in the case of the Lake Charles PPG facility, the vinyl chloride monomer is routed to the section of the plant that manufactures methyl chloroform.<sup>2,6</sup>

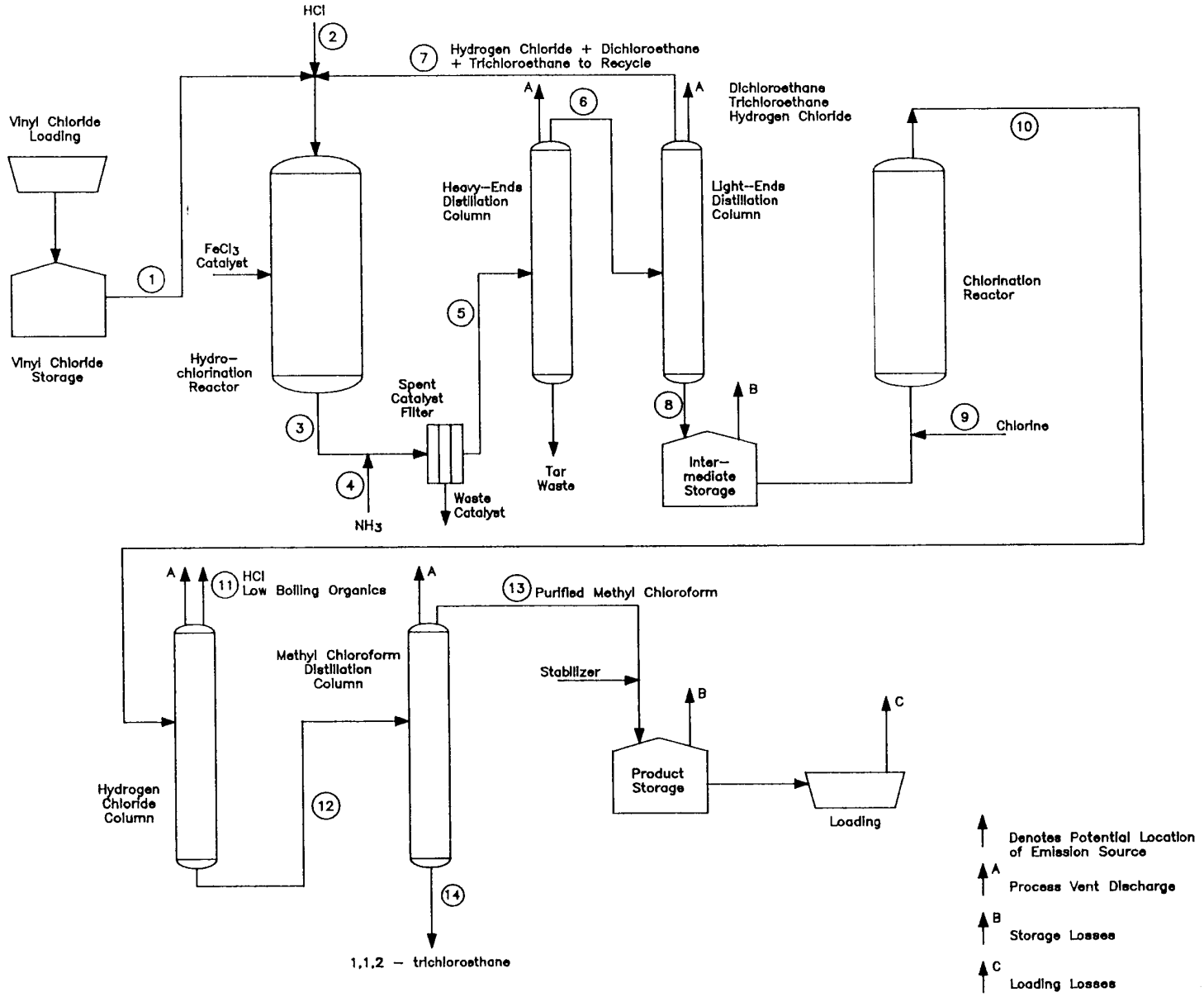

Figure 4-1. Process flow diagram for the hydrochlorination of vinyl chloride.<sup>5</sup>

Reaction 2 involves the production of the intermediate 1,1-dichloroethane via the hydrochlorination process. Vinyl chloride (Stream 1 in Figure 4-1) and hydrogen chloride (Stream 2) are combined with recycled hydrogen chloride, recycled methyl chloroform, and recycled dichloroethane (Stream 7) and fed to a hydrochlorination reactor. Catalytic conversion occurs in the presence of a ferric chloride catalyst at approximately 35°C (95°F).<sup>4,5,7</sup> Ammonia (Stream 4) is added to the reactor effluent (Stream 3) forming a solid complex with the residual hydrogen chloride and the ferric acid catalyst. The complex is removed by the spent catalyst filter as a semisolid waste stream. The filtered hydrocarbon stream (Stream 5) passes to the heavy-ends distillation column, where high-boiling chlorinated organics (tars) are removed as a waste stream from the bottom.<sup>5,8</sup>

The overhead (Stream 6) passes to the light-ends distillation column, where a separation is made between 1,1-dichloroethane and the lighter components, primarily unreacted vinyl chloride. The overhead stream (Stream 7) is recycled to the hydrochlorination reactor. The 1,1-dichloroethane product is removed as the bottom stream (Stream 8) and transferred to intermediate storage or directly to the chlorination reactor.<sup>5,8,9</sup>

The third reaction begins when 1,1-dichloroethane from intermediate storage, or the light-ends column, and chlorine (Stream 9) are combined and fed to the chlorination reactor, where the 1,1-dichloroethane is converted to methyl chloroform. The reaction is exothermic, noncatalytic and occurs at a temperature of about 400°C (752°F). The reactor product (Stream 10), crude methyl chloroform, passes to the hydrogen chloride column where the hydrogen chloride formed in the reaction and some low-boiling organic compounds are removed (Stream 11). This stream may be used to supply the hydrogen chloride requirements of other chlorinated organic processes directly (*e.g.*, the 1,2-dichloroethane process) or it may be purified to remove the contained organics before the stream is used.<sup>5,8</sup>

The bottom stream (Stream 12) from the hydrogen chloride column passes to the methyl chloroform column. The purified methyl chloroform product (Stream 13) is removed overhead, stabilized, and transferred to storage. The bottom stream (Stream 14) from the methyl

chloroform column (primarily 1,1,2-trichloroethane) is transferred as feed to other chlorinated organic processes (*e.g.*, perchloroethylene or trichloroethylene).<sup>5</sup> Yields of methyl chloroform from this process exceed 95 percent.<sup>8</sup>

#### 4.1.2 Hydrochlorination of Vinylidene Chloride

In 1975, the production of methyl chloroform by the hydrochlorination of vinylidene chloride accounted for approximately 20 percent of total methyl chloroform production.<sup>8</sup> Although this process is no longer used for the United States, it is used in Europe and Japan and is included in this document as a reference. The following reactions show a simplified version of the chlorination process.<sup>8,10</sup>

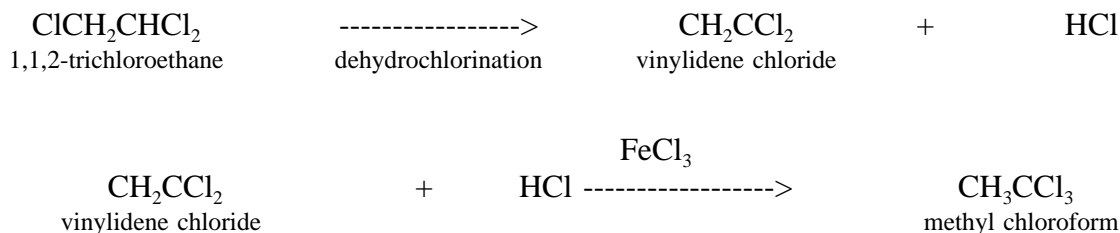

The reaction of vinylidene chloride with the evolved hydrogen chloride yields methyl chloroform. This reaction is carried out at approximately 30°C (86°F) under slightly superatmospheric pressure in the presence of a catalyst such as ferric chloride. Methyl chloroform is continuously withdrawn from the hydrochlorination step and is purified by fractional distillation. If methyl chloroform is to be sold as a product, it is desiccated to remove moisture and stabilized to make it suitable for commercial use. Yields of methyl chloroform from this process exceed 98 percent.<sup>4</sup>

#### 4.1.3 Noncatalytic Chlorination of Ethane

Like the hydrochlorination of vinylidene chloride, the ethane chlorination process is no longer used in the United States but is used in Europe and Japan. The Vulcan Materials Company in Geismar, Louisiana operated a 31.8 million kgs (70 million lbs) per year ethane-

based production facility until 1979, when the facility converted to producing methyl chloroform via hydrochlorination of vinyl chloride.<sup>7</sup> The reader is directed to the documents referenced at the end of this section for a process flow diagram.<sup>5</sup>

The chlorination of ethane yields several products and by-products including methyl chloroform and minor quantities of 1,2-dichloroethane and 1,1,2-trichloroethane. The ethane chlorination process includes the following reactions:<sup>5</sup>

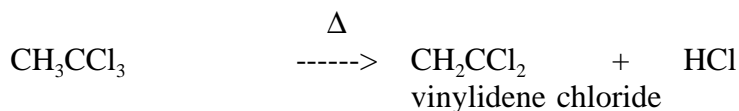
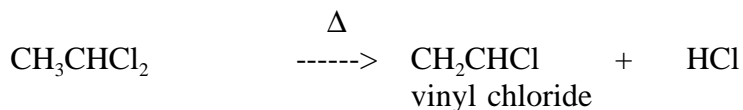
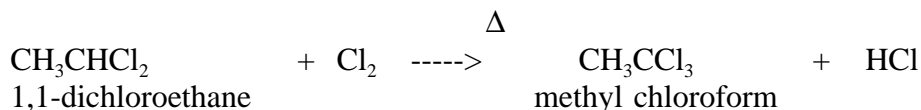
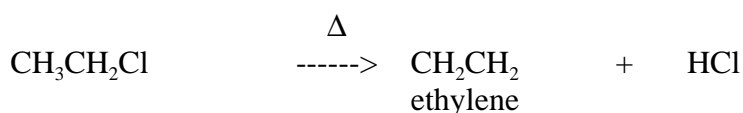
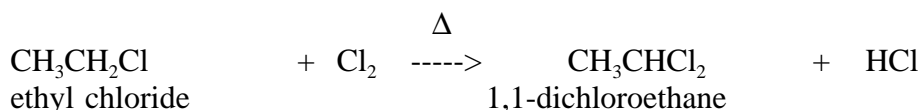
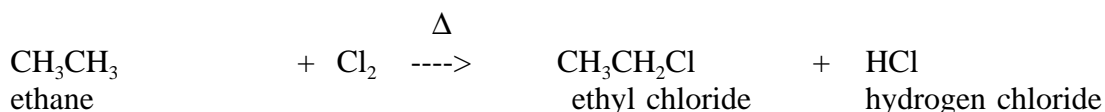

The raw material ratios and reactor conditions determine the relative proportions of methyl chloroform and by-products produced. If methyl chloroform is the only product desired, the by-product chloroethane and 1,1-dichloroethane can be recycled to the chlorination reactor. Vinyl chloride, an additional by-product, can be catalytically hydrochlorinated to yield 1,1-dichloroethane and methyl chloroform, respectively according to the following reactions.<sup>5</sup>

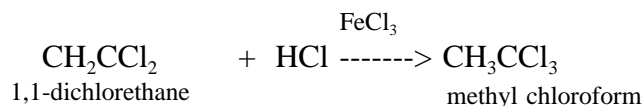
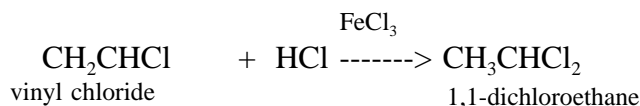

The noncatalytic chlorination of ethane process begins with the recycle and conversion of by-product chlorinated species, including vinylidene chloride, to form methyl chloroform.<sup>5</sup> Chlorine and ethane are fed to the chlorination reactor along with recycle streams of 1,1-dichloroethane and chloroethane. The reactor is operated adiabatically, (*i.e.*, the heat flow between the reactor and its surroundings is zero) with a residence time of about 15 seconds, and is maintained at a pressure of about 600 kPa (5.9 atm) and an average temperature of about 400°C (752°F).<sup>5</sup>

The reactor exit stream is a gas containing ethane, ethylene, vinyl chloride, chloroethane, vinylidene chloride, 1,1-dichloroethane, 1,2-dichloroethane, 1,1,2-trichloroethane, methyl chloroform, hydrogen chloride, and minor amounts of other chlorinated hydrocarbons. This stream enters a quench column, where it is cooled, and a residue comprising mainly tetrachloroethanes and hexachloroethane is removed.<sup>5</sup>

The overhead stream from the quench column is fed to a hydrogen chloride column, in which ethane, ethylene, and HCl are removed from chlorinated hydrocarbons. A portion of the overheads containing HCl is used to provide the HCl requirements for vinylidene chloride and vinyl chloride hydrochlorination in a later step. The remainder is purified for use in other processes.<sup>5</sup>

The bottoms from the HCl column containing chlorinated hydrocarbons are fed to a heavy ends column, where a bottoms stream, mainly comprised of 1,2-dichloroethane and 1,1,2-trichloroethane, is removed for use in other processes. Overheads from the heavy ends column containing methyl chloroform, vinyl chloride, vinylidene chloride, chloroethane and

1,1-dichloroethane are fed to the methyl chloroform column, which removes the product as a bottoms steam.<sup>5</sup>

Overheads from the product recovery column are fed to another column, where 1,1-dichloroethane is removed as bottoms and recycled to the chlorination reactor. Overheads from this column, containing mainly vinyl chloride, vinylidene chloride, and chloroethane, are fed along with the HCl by-product stream to a hydrochlorination reactor. This reactor operates at a temperature of about 18°C (65°F), a pressure of about 450 kPa (4.4 atm), and with ferric chloride catalyst. Alternatively, these by-products may be used in other processes at the plant.<sup>5</sup>

The hydrochlorination reactor converts vinyl chloride and vinylidene chloride to 1,1-dichloroethane and methyl chloroform, respectively. Thus, the reactor product stream consists of unreacted chloroethane, 1,1-dichloroethane and methyl chloroform. This product stream is mixed with ammonia (NH<sub>3</sub>) to neutralize residual HCl and catalyst. Spent neutralized catalyst is removed in a filter and the product is then fed to a product recovery column. The bottoms from this column, mostly methyl chloroform, are recycled to the methyl chloroform column. Overheads, composed of chloroethane and 1,1-dichloroethane, are recycled to the chlorination reactor.<sup>5</sup>

## 4.2 EMISSIONS

Air emissions associated with methyl chloroform production arise from loading operations, storage, process vents, and equipment leaks. Methyl chloroform emissions from secondary sources, such as waste treatment, are discussed in Section 6.0. Table 4-3 lists 1978 production emissions for the three facilities currently manufacturing methyl chloroform. The table also includes emissions for the Dow Plaquemine, Louisiana facility, which closed in the early 1980s.<sup>11</sup> In 1978, both Dow facilities and PPG employed the hydrochlorination of vinyl chloride production process while Vulcan made methyl chloroform by the noncatalytic chlorination of ethane.<sup>7,12</sup> Although the data in Table 4-3 are based on 1978 production data, current total emissions are expected to be similar to 1978 production and capacity values which approximate



**TABLE 4-3.  
METHYL CHLOROFORM PRODUCTION EMISSIONS**

Company	Location	1978 Production in millions of kg (millions of lbs)	1978 Capacity in millions of kg (millions of lbs)	Thousands of kilograms (thousands of pounds)			
				Process Emissions	Storage Emissions	Fugitive Emissions	Total Emissions
Dow	Freeport, TX	121 (266)	227 (500)	42.5 (93.6)	134.9 (295.3)	59.1 (130.2)	235.5 (519.1)
Dow	Plaquemine, LA	73 (160)	136 (300)	0.0 (0.0)	7.9 (17.4)	3.4 (7.6)	11.3 (25.0)
PPG	Lake Charles, LA	73 (160)	136 (300)	52.2 (115.0)	164.7 (363.2)	72.5 (160.0)	289.6 (638.4)
Vulcan	Geismar, LA	15 (34)	29 (65)	11.2 (24.6)	35.0 (77.2)	15.4 (34.0)	61.6 (135.7)
Total		282 (620)	528 (1165)	105.9 (233.2)	342.5 (753.1)	150.4 (331.8)	598.0 (1,318.2)

Source: Reference 11.

the projected 1992 production and capacity figures indicated in Tables 4-1 and 4-2.<sup>1,11,12</sup>

#### 4.2.1 Process Emissions

Figure 4-1 illustrates that during methyl chloroform production by the hydrochlorination of vinyl chloride, process vent discharges (A) of methyl chloroform occur primarily from the hydrogen chloride vent and the distillation column vents. Table 4-4 presents available emission factor estimates for methyl chloroform production. Little information was found on emission controls.

**TABLE 4-4.  
METHYL CHLOROFORM EMISSION FACTORS FROM  
METHYL CHLOROFORM PRODUCTION**

Potential Emission Source	Emission Factor kg/metric ton (lb/ton)	Emission Factor Rating
Condenser/Distillation Column	0.720 (1.440)	E
Distillation Col./Incinerator Control/ Production from Ethane	0.003 (0.006)	E
Separation Unit/Production by Hydrochlorination	0.500 (1.000)	E
Heat Transfer Unit/Production by Hydrochlorination	9.000 (18.000)	E

Note: Emission factors were developed from model plant calculations, mass balance calculations, and testing.

Source: Reference 13.

---

The documents referenced at the end of this section provide discussions of potential emission sources of methyl chloroform from the hydrochlorination of vinylidene chloride and the noncatalytic chlorination of ethane.<sup>5</sup>

#### 4.2.2 Storage Emissions

Other possible sources of methyl chloroform emissions are storage tank losses (point B in Figure 4-1) and handling losses (point C in Figure 4-1) that occur during product loading into drums, tank trucks, tank cars, barges, or ships. Storage tank losses are either working losses that occur while filling the tank, or breathing losses due to expansion from temperature changes. These emissions are described briefly in this section. For more information, including equations for estimating storage tank emissions, the reader is referred to the U.S. Environmental Protection Agency's report titled *Estimating Air Toxics Emissions from Organic Liquid Storage Tanks* (EPA-450/4-88-004).<sup>14</sup>

Methyl chloroform is usually stored in floating roof tanks which decrease the degree of evaporation loss of organic liquids. There are two main types of floating roof tanks: external and internal. External floating roof tanks consist of a cylindrical steel shell equipped with a roof which floats on the surface of the stored liquid, rising and falling with the liquid level. The liquid is completely covered by the floating roof, except at the small annular space between the roof and the tank wall. A seal attached to the roof contacts the tank wall and covers the annular space. The seal slides against the tank wall as the roof is raised or lowered. The purpose of the floating roof and the seal is to reduce the evaporation loss of the stored liquid.<sup>14</sup>

The internal floating roof tank has both a permanent fixed roof and a floating deck inside. The deck rises and falls with the liquid level and either rests directly on the liquid surface or rests on pontoons several inches above the liquid level. There are two basic types of internal floating roof tanks: tanks in which the fixed roof is supported by vertical columns within the tank, and tanks with a self-supporting fixed roof and no internal support columns. Fixed roof tanks that have been retrofitted to employ a floating deck are typical of the first type, while external floating roof tanks typically have a self-supporting roof when converted to an internal floating roof tank. These tanks are freely vented by circulation vents at the top of the fixed roof. The vents minimize the possibility of organic vapor accumulation in concentrations approaching the flammable range.<sup>14</sup>

Methyl chloroform emissions from external and internal floating roof tanks are characterized as standing storage and withdrawal losses. Standing storage losses include rim seal loss, deck fitting loss, and deck seam loss for the internal tanks; and rim seal loss for the external tanks. Variables needed for determining floating roof storage tank emissions include tank parameters (*e.g.*, height, diameter, and capacity), temperatures, and other environmental parameters, and characteristics of the stored solvent liquid (*e.g.*, molecular weight and vapor pressure).<sup>14</sup>

Standing storage loss from external floating roof tanks is the major source of evaporative loss from solvent storage tanks. This results from wind-induced mechanisms as air flows across the top of the external floating roof tank. These mechanisms may vary, depending upon the type of seals used to close the annular vapor space between the floating roof and the tank wall.<sup>14</sup>

Internal floating roof tanks generally incorporate two types of primary seals that perform by closing the annular space between the edge of the floating roof and the tank wall. Historically, secondary seals were not commonly used with internal floating roof tanks. However, recent regulations concerning internal floating roof tanks have led to increased use of secondary seals. Another form of emissions from the internal floating roof tanks is through deck fitting loss. These emissions result from penetrations in the roof by deck fittings, fixed roof column supports, or other openings.<sup>14</sup>

Withdrawal loss is a potential source of atmospheric emissions from floating roof tanks. Loss occurs through vaporization of the liquid that clings to the tank wall and is exposed to the atmosphere when the floating roof lowers when liquid is withdrawn.<sup>14</sup>

In addition to residual emissions of methyl chloroform from floating roof storage tanks, some residual emissions can occur from the handling and shipping of the chemical through the use of tank trucks and tank cars. An emission factor of 0.605 g/kg (1.22 lb/ton) methyl chloroform produced was identified for evaporative loss through the handling of methyl

chloroform.<sup>13</sup> This emission factor has an assigned quality rating of "U." Insufficient information is available to accurately assign a quality rating to the emission factor.

#### 4.2.3 Equipment Leak Emissions (Fugitive Emissions)

Emissions occur from process equipment components whenever the liquid or gas streams leak from the equipment. Equipment leaks can occur from the following components: pump seals, process valves, compressor safety relief valves, flanges, open-ended lines, and sampling connections. Emission estimates can be calculated in the five ways described in the EPA publication *Protocols for Generating Unit-Specific Emission Estimates for VOC and VHAP* (EPA-450/3-88-010).<sup>15</sup> The methods differ in complexity; however, the more complex the method, the more reliable the emission estimate.

The simplest method requires that the number of each component type be known. Furthermore, for each component, the methyl chloroform content of the stream and the time the component is in service are needed. This information is then multiplied by the EPA's average emission factors for the Synthetic Organic Chemical Manufacturing Industries (SOCMI) shown in Table 4-5.<sup>15</sup> This method should only be used if no other data are available, as it may result in an overestimation of actual equipment leak emissions. For each component, estimated emissions are:

$$\left[ \begin{array}{c} \text{No. of} \\ \text{equipment} \\ \text{components} \end{array} \right] \times \left[ \begin{array}{c} \text{Weight \%} \\ \text{methyl chloroform} \\ \text{in the stream} \end{array} \right] \times \left[ \begin{array}{c} \text{Component-} \\ \text{specific} \\ \text{emission factor} \end{array} \right] \times \left[ \begin{array}{c} \text{No. hrs/yr in} \\ \text{methyl chloroform} \\ \text{service} \end{array} \right]$$

To obtain more accurate equipment leak emission estimates, one of the more complex estimation methods should be used. These methods require that some level of emission measurement for the facility's equipment components be performed. These are described briefly, and the reader is referred to the *Protocols* document for the calculation details.<sup>15</sup>

The first method, the leak/no leak approach, is based on a determination of the number of leaking and non-leaking components. These values are then multiplied by two different sets

**TABLE 4-5.  
AVERAGE EMISSION FACTORS FOR FUGITIVE  
EQUIPMENT LEAK EMISSIONS**

Equipment	Service	Emission Factor (kg/hr/source)	Emission Factor (lb/hr/source)	Quality Rating <sup>a</sup>
Valves	Gas	0.0056	0.0123	U
	Light Liquid	0.0071	0.0157	
	Heavy Liquid	0.00023	0.00051	
Pump Seals	Light Liquid	0.0494	0.1089	U
	Heavy Liquid	0.0214	0.0472	
Compressor Seals	Gas/Vapor	0.228	0.5027	U
Pressure Relief Seals	Gas/Vapor	0.104	0.2293	U
Flanges	All	0.00083	0.0018	U
Open-Ended Lines	All	0.0017	0.0037	U
Sampling Connections	All	0.0150	0.0331	U

<sup>a</sup>Based on engineering judgement.

Source: Reference 15.

of EPA-derived emission factors as presented in the *Protocols* document.<sup>15</sup> The second method groups screening results into three ranges: 0-1,000 ppmv; 1,001-10,000 ppmv; and greater than 10,000 ppmv. The number of each component falling in a particular range is multiplied by the component-specific emission factor for that range. These emission factors, like the factor for the leak/no leak approach, have also been developed by EPA. The next method uses screening data in correlation equations derived from earlier work by EPA.

The last procedure calls for the facility to develop its own correlation equations but requires more rigorous testing, bagging, and analyzing of equipment leaks to determine mass emission rates.

Although no specific information on controls used by the industry was identified, equipment components in methyl chloroform service will have some controls in place. Generally, control of fugitive emissions will require the use of sealless or double mechanical seal pumps, an inspection and maintenance program, as well as replacement of leaking valves and fittings in conjunction with an inspection and maintenance program. Typical controls for equipment leaks are listed in Table 4-6. Additionally, some leakless equipment is available such as leakless valves and sealless pumps.<sup>16</sup>

**TABLE 4-6.  
CONTROL TECHNIQUES AND EFFICIENCIES APPLICABLE TO  
EQUIPMENT LEAK EMISSIONS**

Equipment component (Emission source)	Control Technique	Percent reduction <sup>a</sup>
Pump Seals:		
Packed and Mechanical	Seal area enclosure vented to a combustion device	100
	Monthly LDAR <sup>b</sup>	61
	Quarterly LDAR	32
	Semiannual LDAR	0
	Annual LDAR	0
Double Mechanical <sup>c</sup>	N/A <sup>d</sup>	-----
Compressors	Vent degassing reservoir to combustion device	100
Flanges	None available	0
Valves:		
Gas	Monthly LDAR	73
	Quarterly LDAR	64
	Semiannual LDAR	50
	Annual LDAR	24
Liquid	Monthly LDAR	59
	Quarterly LDAR	44
	Semiannual LDAR	22
	Annual LDAR	0
Pressure Relief Devices		
Gas	Monthly LDAR	50
	Quarterly LDAR	44
	Rupture Disk	100
Sample Connections	Closed-purge sampling	100
Open-ended Lines	Caps on open ends	100

<sup>a</sup>If a negative reduction for a control technique was indicated, zero was used.

<sup>b</sup>LDAR (Leak detection and repair).

<sup>c</sup>Assumes the seal barrier fluid is maintained at a pressure above the pump stuffing box pressure and the system is equipped with a sensor that detects failure of the seal and/or barrier fluid system.

<sup>d</sup>N/A (Not applicable). There are no VOC emissions reported from this component.

Source: Reference 17.



#### 4.3 REFERENCES FOR SECTION 4.0

1. "Chemical Profile: 1,1,1-Trichloroethane," *Chemical Marketing Reporter*. January 27, 1992.
2. "1,1,1-Trichloroethane," *Chemical Products Synopsis*, Mannsville Chemical Products, Asbury Park, NJ. October 1990.
3. U.S. Environmental Protection Agency. *Source Assessment: Chlorinated Hydrocarbons Manufacture*. EPA-600/2-79-019g. Industrial Environmental Research Laboratory. Research Triangle Park, NC. August 1979.
4. "Chemical & Engineering News. 1992," *Chemical & Engineering News* 70(26). 1992.
5. U.S. Environmental Protection Agency. *Organic Chemical Manufacturing*, Volume 8, Report 4, 1,1,1-Trichloroethane and Perchloroethylene, Trichloroethylene, and Vinylidene Chloride (Abbreviated Report). EPA-450/3-80-028c. Office of Air Quality Planning and Standards. Research Triangle Park, NC. October 1980.
6. "Vinyl Chloride," *Chemical Products Synopsis*, Mannsville Chemical Products, Asbury Park, NJ. February 1991.
7. "C<sub>2</sub> Chlorinated Solvents," *Chemical and Economics Handbook*, SRI International, Menlo Park, CA. December 1988.
8. Lowenheim, F.A., and Moran, M.K. "1,1,1-Trichloroethane," *Faith, Keyes, and Clark's Industrial Chemicals*, Fourth ed., pp. 836-843. 1975.
9. *Air Pollution from Chlorination Processes*. Processes Research, Inc. APTD 1110. CPA 70 1. Cincinnati, OH. 172 pp. March 31, 1972.
10. U.S. Environmental Protection Agency. *Health Assessment Document for 1,1,1-Trichloroethane (Methyl Chloroform)*. EPA-600/8-82-003f. Office of Health and Environmental Assessment. Washington, DC. February 1984.
11. U.S. Environmental Protection Agency. *Human Exposure to Atmospheric Concentrations of Selected Chemicals*, Volume II, Appendix A-18. Office of Air Quality Planning and Standards. Research Triangle Park, NC. 1984.
12. "1,1,1-Trichloroethane," *Chemical Products Synopsis*, Mannsville Chemical Products, Cortland, NY. November 1980.

13. U.S. Environmental Protection Agency. *The Crosswalk/Air Toxic Emission Factor Database Management System, Version 1.2*. Office of Air Quality Planning and Standards. Research Triangle Park, NC. October 1991.
14. U.S. Environmental Protection Agency. *Estimating Air Toxics Emissions from Organic Liquid Storage Tanks*. EPA-450/4-88-004. Office of Air Quality Planning and Standards. Research Triangle Park, NC. October 1988.
15. U.S. Environmental Protection Agency. *Protocols for Generating Unit-Specific Emission Estimates for Equipment Leaks of VOC and VHAP*. EPA-450/3-88-010. Office of Air Quality Planning and Standards. Research Triangle Park, NC. 1988.
16. U.S. Environmental Protection Agency. *Estimating Releases and Waste Treatment Efficiencies for the Toxic Chemical Release Inventory Form*. EPA-560/4-88-002. Office of Pesticides and Toxic Substances. Washington, DC. 1987.

## SECTION 5.0

### EMISSIONS FROM MAJOR USES OF METHYL CHLOROFORM

This section discusses emissions from major industrial processes that use methyl chloroform as a solvent or a feedstock. The processes described are solvent cleaning (*e.g.*, vapor degreasing and cold cleaning) operations, paint and ink manufacturing, aerosol manufacturing, adhesive manufacturing, production of hydrochlorofluorocarbons (HCFC), including hydrochlorofluorocarbon 142b (HCFC-142b) and hydrochlorofluorocarbon 141b (HCFC-141b), and miscellaneous uses.<sup>1</sup> In addition, product and process descriptions are provided for uses of methyl chloroform in solvent applications. The application of methyl chloroform-containing paints, coatings, and inks is discussed in Section 6.0. Because of limited application information, the manufacture and application of aerosols and adhesives containing methyl chloroform is discussed in this section. Process flow diagrams are included as appropriate, with specific streams or vents in the figures labeled to correspond with the discussion in the text.

Emissions of methyl chloroform are expected from all facilities involved in the previously mentioned operations. However, insufficient information is available to develop emission factors for fugitives or process emission sources. Any available information is provided in each subsection. The reader is encouraged to contact the Toxic Chemical Release Inventory and specific production facilities for information on methyl chloroform emissions and control technologies. It should be noted, however, that TRI emission estimates may be based upon engineering estimates, may include accidental emission releases, and may not be reliable.

Residual emissions from methyl chloroform-containing materials are discussed separately in Section 6.0. Methyl chloroform emissions produced as a result of a chemical reaction (by-product emissions) are also discussed in Section 6.0.

## 5.1 SOLVENT CLEANING

The first commercial success of methyl chloroform was as a replacement for carbon tetrachloride in room temperature, metal cleaning operations.<sup>1</sup> Cleaning operations, including cold cleaning and vapor degreasing, remain the largest end use of methyl chloroform.<sup>2,3</sup> Methyl chloroform is the most widely used and the most cost-effective chlorinated solvent.<sup>2,4</sup> Domestic production and demand for methyl chloroform exceeds demands for other chlorinated solvents, such as perchloroethylene (PCE), trichloroethylene (TCE), and methylene chloride. Although terpenes, aqueous cleaners, and organic surfactants are being used as replacements for methyl chloroform in some cleaning applications because of the restrictions required under the Montreal Protocol and the 1990 Clean Air Act Amendments, there is no direct replacement for methyl chloroform in other cleaning applications.<sup>2,3</sup>

Methyl chloroform will dissolve oils, greases, waxes, tars, fats, gums, and resins, yet it will not attack or harm most plastics and elastomers. Methyl chloroform is the preferred solvent for the cleaning of electronic components, electrical parts, and printed circuit boards where other solvents may damage the insulation or cause heat warping. It is also used in metal cleaning and in maintenance cleaning of products such as aircraft, automobiles, diesel engines, electric motors, generators, and compressed gas cylinders.<sup>2,4</sup> The five two-digit SIC groups that use the largest amount of methyl chloroform for cleaning are as follows: SIC 25 (furniture and fixtures), SIC 34 (fabricated metal products), SIC 36 (electric and electronic equipment), SIC 37 (transportation equipment) and SIC 39 (miscellaneous manufacturing industries). Other industries that use methyl chloroform in cleaning operations include SIC 20 (food and kindred products), SIC 33 (primary metals), SIC 35 (nonelectric machinery), and SIC 38 (instruments and clocks). Non-manufacturing industries (*e.g.*, railroad, bus, aircraft, and truck maintenance facilities), automotive and electric tool repair shops, automobile dealers, and service stations also use methyl chloroform in cleaning operations.<sup>5,6</sup>

Methyl chloroform exhibits chemical instability when exposed to the severe conditions (*i.e.*, high temperatures, metals, or metal salts) encountered in vapor degreasing or other cleaning operations. For this reason, methyl chloroform normally contains up to five percent stabilizer to prevent decomposition. If the level of stabilizer falls below a certain level, methyl chloroform may hydrolyze.<sup>2,4</sup> Methyl chloroform is not normally used with aluminum products unless suitable quantities of stabilizer are present. Uninhibited (unstabilized) methyl chloroform may react with aluminum to produce aluminum chloride; 2,2,3,3-tetrachlorobutane; 1,1-dichloroethylene; and hydrogen chloride. Adequate metal inhibitors can prevent methyl chloroform-aluminum reactivity and allow the solvent to be used in aluminum metal-cleaning applications.<sup>7</sup> A discussion of stabilizers is included in Section 3.0.

Many of the facilities that employ metal cleaning operations are small (employing less than 50 people), and, therefore do not purchase methyl chloroform directly from the manufacturing facilities listed in Table 4-1. It is estimated that 80 to 85 percent of the chlorinated solvent (*i.e.*, methyl chloroform, methylene chloride, PCE, and TCE) sales to users are handled through distributors. The largest distributors of chlorinated solvents in the United States are Van Waters & Rogers, Ashland Chemical, ChemCentral, Thompson-Hayward, and Union Chemicals.<sup>4</sup>

#### 5.1.1 Process Description

Solvent cleaners can be divided into three main categories: cold cleaners, open-top vapor cleaners (OTVC), and conveyORIZED (often called in-line) cleaners. Although most in-line cleaners are vapor degreasers, some are cold cleaners. In 1987, an estimated 150 million kgs (330 million lbs) of chlorinated solvent were used by OTVC; 50 million kgs (110 million lbs) by in-line vapor cleaners; 30 million kgs (66 million lbs) by in-line cold cleaners; and 2 million kgs (4.4 million lbs) by other cold cleaners.<sup>5</sup> The 1992 methyl chloroform consumption estimates for OTVC were the same as the 1987 figures, while estimates for cold cleaners decreased by 2.27 million kgs (5 million lbs).<sup>4</sup>

Spraying, brushing, flushing, and immersion are cleaning techniques used with cold cleaners.<sup>5</sup> However, methyl chloroform is not a widely used cold cleaning solvent. The major cold cleaner manufacturers indicate that none of them currently sells or have recently sold units for use with solvents other than methylene chloride and nonhalogenated solvents. Although there may be some older units that use other chlorinated solvents, the total number of these units nationwide is negligible.<sup>8</sup>

Open top vapor cleaners are used primarily in metalworking operations and other manufacturing facilities. They are seldom used for ordinary maintenance cleaning because cold cleaners using petroleum distillate solvents can usually perform this type of cleaning at a lower cost. Exceptions applying to the use of methyl chloroform include maintenance cleaning of electronic components, small equipment parts, aircraft parts, and other miscellaneous parts that require a high degree of cleanliness.<sup>5</sup>

A typical OTVC consists of a tank equipped with a heating system (*e.g.*, steam, electricity, or fuel combustion) and cooling coils.<sup>9</sup> Heating elements on the inside bottom of the tank raise the temperature of the solvent to its boiling point, creating vapor. The cooling coils located on the inside perimeter of the tank above the liquid level condense the solvent vapors, creating a controlled vapor zone which prevents vapors from escaping from the tank. The parts to be cleaned are lowered into the vapor zone where solvent condenses on their surfaces and dissolves the adhering dirt and oils.<sup>5,8</sup> Additional cleaning action can occur if the parts are lowered into the solvent bath or are sprayed with the solvent prior to the condensation phase. Once thoroughly cleaned, the parts are removed from the tank and dried. Nearly all vapor degreasers are equipped with a water separator that collects the condensate (containing both water moisture and condensed solvent) and separates it into its organic and aqueous phases. The water phase is removed while the condensed solvent is fed back into the solvent bath of the vapor degreaser.<sup>10</sup>

In-line cleaners feature automated conveying systems for continuous cleaning of parts. Most in-line cleaners use vapor cleaning rather than cold cleaning as their cleaning mechanism. In-line cleaners use the same cleaning techniques as OTVC, but operate on a larger scale in an automated, conveyORIZED fashion.<sup>5,8</sup> The five main types of in-line cleaners using chlorinated solvents include cross-rod, monorail, belt, strip, and printed circuit board processing equipment (*e.g.*, photoresist strippers, flux cleaners, and developers). The photoresist stripper, a device used in printed circuit board processing, is typically the only in-line cleaner that employs cold cleaning. Although in-line cleaners tend to be the largest of the three types of solvent cleaners, they emit less solvent per part cleaned because they are usually enclosed systems.<sup>5</sup>

### 5.1.2 Emissions

Solvent evaporation occurs both directly and indirectly with all types of solvent cleaning equipment. Major causes of emissions include the loss of solvent vapor from the cleaning tank due to diffusion and convection. Diffusion (*e.g.*, evaporation from liquid solvent in a cold cleaner) or convection (*e.g.*, evaporation from liquid solvent induced by warm freeboards) occurs during idling at the air/solvent vapor interface. The freeboard ratio is an index for freeboard height and is equal to the freeboard height divided by the cleaner width. Evaporation of solvent also occurs as parts are introduced or extracted (*i.e.*, drag out) during the cleaning process or when parts are spray cleaned. These evaporative losses are referred to as workload losses.<sup>5,8</sup> Other potentially significant losses that contribute to the total solvent emissions from a solvent cleaner include filling/draining losses, wastewater losses, start-up/shutdown losses, downtime losses, and losses from leaks from the cleaning mechanism of associated equipment. In addition, losses occur from solvent storage and solvent transfer.<sup>5</sup> The quantity of emissions varies depending on the type, design, and size of the cleaner, the hours of operation, operating techniques, and the type of material being cleaned. Because emissions are ultimately a function of solvent use, techniques and practices designed to conserve solvent use are beneficial in reducing atmospheric emissions.<sup>5,8</sup>

Potential control methods for organic solvent cleaners include add-on equipment and improved operating practices. Add-on equipment can be as simple as adding covers to equipment openings, enclosing equipment, increasing freeboard height, adding freeboard refrigeration devices, and using automated parts handling systems. The freeboard height is the distance from the liquid solvent surface or top of the vapor to the lip of the tank. Increasing the freeboard height decreases drafts, and thereby solvent diffusion, within the cleaner. These devices limit diffusional and convective losses from solvent tanks and evaporative losses due to solvent carry-out. More sophisticated control techniques include carbon adsorption systems to recover solvent vapors.<sup>8</sup>

Improved operating practices may limit emissions from solvent cleaning. These improvements, characterized by practices that reduce solvent exposure to the atmosphere, include minimizing open surface area, keeping cleaner covers closed, fully draining parts prior to removal from cleaner, maintaining moderate conveyor speeds, keeping ventilation rates moderate, using a coarse spray or solid stream of solvent instead of a fine spray, not using compressed air sprays to blow-dry parts or to mix cleaning baths, and by placing wipe rags in a closed container and reusing them whenever possible. The emission reductions achievable through the use of control devices vary depending on the operating schedule of the machine.

In vapor cleaning, improper heat balance, air currents, high water content, and solvent degradation are the primary factors affecting solvent losses, necessitating greater virgin solvent use. Equipment configurations and operational practices that abate the problems will be useful in reducing potential solvent emissions from vapor cleaning. Conservation practices for vapor cleaners as recommended by a major cleaning solvent manufacturer are summarized below.<sup>8</sup>

1. Use least amount of heat necessary to keep solvent at a boil and provide adequate vapor production.
2. Regulate cooling level by water temperature or flow rate adjustments.
3. Monitor water jacket temperature and flow rate to prevent migration of hot solvent vapor up cleaner side walls.



4. Use cold coil traps to lessen vapor losses.
5. Use covers, especially during idle periods, on open-top cleaners.
6. Avoid drafts over the cleaner by locating the unit to minimize natural drafts or use baffles to prevent vapors from being disturbed.
7. Extend the freeboard height of the cleaner.
8. Spray in the vapor zone of the cleaner to minimize the generation of a vapor-air mixture and the disruption of the vapor interface.
9. Use minimum exhaust velocity necessary to provide proper vapor control in the work area.
10. Arrange air movement in the room to minimize wind tunnel effects.
11. Avoid rapid parts or basket movement in the vapor zone.
12. Minimize the level of dissolved water in the solvent.
13. Minimize the introduction of water to prevent the depletion of solvent stabilizers.
14. Have a separate water trough for refrigerated coils.
15. Minimize and remove visible signs of corrosion to minimize solvent decomposition.
16. Monitor and maintain solvent stabilizers, inhibitors, and acid acceptors.
17. Remove metal parts, fines, and sludge to prevent stabilizer depletion and resulting solvent decomposition.
18. Avoid high oil concentration build-up.
19. Minimize solvent carry-out on parts.
20. Bring parts to vapor temperature prior to removal to minimize dragout.
21. Do not overload the cleaning capacity of the cleaner.
22. Use properly sized baskets in the cleaner to reduce vapor-air mixing.
23. Do not expose heating coils to solvent vapor.

24. Use only clean or non-porous materials in the cleaning process.
25. Operate a cleaner leak detection and repair program.

Tables 5-1 and 5-2 present available emission factor data for methyl chloroform emissions from OTVC solvent cleaners. A more detailed description of emissions is available from the EPA document *Alternative Control Technology Document - Halogenated Solvent Cleaners* (EPA-450/3-89-030) and the solvent degreasing project file in the Office of Air Quality Planning and Standards, Research Triangle Park, North Carolina.<sup>5</sup> Information in the project file was unavailable at the time of document preparation.

**TABLE 5-1.  
SUMMARY OF EMISSIONS TESTS ON IDLING OTVC  
(USING METHYL CHLOROFORM AS SOLVENT)**

Primary Condenser Temperature in °C (°F)	Emission Rate <sup>b</sup> kg/m <sup>2</sup> /hr (lb/ft <sup>2</sup> /hr)	Rating
10 (50)	0.425 (0.087)	C
21 (70)	0.586 (0.120)	C
29 (84)	0.698 (0.143)	C

<sup>a</sup> FBR (freeboard ratio).

<sup>b</sup> Emissions are based on a 0.9 m<sup>2</sup> Auto-Sonics Cleaner with a FBR = 0.7.

Source: Reference 8.

---

## 5.2 PAINT AND INK MANUFACTURING

Methyl chloroform is one solvent used as a raw material in the manufacture of paints and inks. It can be blended with slow or medium evaporating solvents to achieve the flow, leveling, and application properties required by paint and ink formulators. Methyl chloroform exhibits

**TABLE 5-2.  
SUMMARY OF EMISSIONS TESTS ON WORKING OTVC (USING METHYL  
CHLOROFORM AS SOLVENT)**

Conditions						
Cleaner Size (m <sup>2</sup> )	Cleaner Make	Air Speed (FPM)	Primary Condenser Temperature in °C (°F)	FBR <sup>a</sup>	Emission Rate kg/m <sup>2</sup> /hr (lb/ft <sup>2</sup> /hr)	Rating
1.8	Detrex	calm	-- <sup>b</sup>	0.75	0.483 (0.099)	C
1.8	Detrex	130	-- <sup>b</sup>	0.75	0.845 (0.173)	C
1.8	Detrex	160	-- <sup>b</sup>	0.75	1.138 (0.233)	C
1.4	Auto-Sonics	-- <sup>b</sup>	-- <sup>b</sup>	-- <sup>b</sup>	0.308 (0.063)	D
0.9	Auto-Sonics	-- <sup>b</sup>	10 (50)	-- <sup>b</sup>	0.488 (0.100)	C
0.9	Auto-Sonics	-- <sup>b</sup>	21 (70)	-- <sup>b</sup>	0.684 (0.140)	C
0.9	Auto-Sonics	-- <sup>b</sup>	29 (84)	-- <sup>b</sup>	0.830 (0.170)	C
0.4	Auto-Sonics	30	21 (70)	0.75	0.547 (0.112)	C
0.4	Auto-Sonics	30	21 (70)	1.0	0.449 (0.092)	C

<sup>a</sup>FBR (freeboard ratio). The freeboard ratio is an index for freeboard height and is equal to the freeboard height divided by the cleaner width. The freeboard height is the distance from the liquid solvent surface or top of the vapor to the lip of the tank. Increasing the freeboard height decreases drafts, and thereby solvent diffusion, within the cleaner.

"Working" emissions include diffusion, convection, and workload losses (but not leaks, solvent transfer losses or downtime losses).

<sup>b</sup>Information unknown or not available.

Source: Reference 8.

resin solubility, nonflammability, and provides enhanced cleaning ability (which leads to improved paint adhesion on the substrate).<sup>6</sup> Because methyl chloroform has been determined by the EPA to be of negligible photochemical reactivity, it has been used as a substitute for solvents (e.g., some aliphatic and aromatics) in traditionally high VOC coating formulations. The use of methyl chloroform has enabled many coating manufacturers to meet current governmental health, safety, and environmental regulations.<sup>12</sup>

In 1989, 10.2 million kgs (22.5 million lbs) of methyl chloroform were consumed in paints and coatings (SIC 2851).<sup>12</sup> An additional 14.7 million kilograms (32.3 million lbs) of methyl chloroform are estimated to be consumed in inks. Consumption in paints and inks accounts for approximately seven percent of total methyl chloroform end uses.<sup>3</sup> The largest use of methyl chloroform in coatings is in air drying paints such as traffic paints and aerosol cans. Section 6.1 discusses the application of methyl chloroform-containing paints (surface coating).

Paints and inks are made by blending pigments, solvents, resins (or binders), oils (for some inks), and other additives. The fluid component of the paint or ink, made of binders (oils and/or resins) and solvents, is called the vehicle. Vehicles transfer the pigment/binder mixture to a surface in a thin, uniform film and normally play no role in film formation. When a paint or ink is deposited on a substrate, the vehicle solvent(s) should evaporate completely. (In the case of reactive diluents and two- and three-component coatings, a portion of the vehicle becomes part of the coating film.) Methyl chloroform is only one of the vehicle solvents used by paint and ink manufacturers.<sup>13</sup>

In 1987, Paint and Allied Products facilities (SIC 2851) were composed of 1,123 companies operating 1,426 plants, two-thirds of which were located in 10 states. The 1987 Census of Manufacturers reports that the 504 ink manufacturing facilities in the United States (SIC 2893) are owned by 224 companies which employ a total of 11,100 people in nineteen States and the District of Columbia. Over 50 percent of paint manufacturing plants and 60 percent of ink manufacturing facilities are small, employing fewer than 20 people and specializing in a limited product line marketed within a small geographic region.<sup>13</sup> *Ward's*

*Business Directory* lists 364 paint and allied products facilities in SIC 2851 with 1990 sales greater than \$1,000,000. *Ward's* also lists 56 ink manufacturing facilities in SIC 2893 with 1990 sales greater than \$1,000,000.<sup>14</sup> These lists are provided in Appendix B, Table B-1 and Table B-2.

One method used to categorize the products of the paint manufacturing industry is by end-use (*e.g.*, markets served). The use categories are architectural coatings, product coatings for original equipment manufacturers (OEM), and special purpose coatings. A summary of chlorinated solvents consumption in the paint use divisions by use category and subcategory is found in Table 5-3. Methyl chloroform accounts for 35 to 40 percent of the chlorinated solvents used in paints and coatings.<sup>12</sup>

No specific information was available providing the amount of methyl chloroform consumed in inks. However, methyl chloroform (and other organic solvents) are most often used in inks that employ a solvent carrier such as flexographic and gravure inks.<sup>4</sup> The other two primary ink classifications, letterpress, and lithographic and offset inks, are of an oil or paste base and are considered to be minor emission sources.<sup>13</sup>

### 5.2.1 Process Description

Paint and ink facilities use similar manufacturing processes to produce their respective products in batch scale production fashion. Most small plants (*i.e.*, facilities employing less than 20 people) produce paint in 40 to 2,000 liter (10 to 528 gallon) batches, while larger facilities produce paint in 800 to 11,000 liter (211 to 2,906 gallon) batches with stock items made in 40,000 liter (10,568 gallon) runs. Inks are produced in batches ranging from 4 liters to over 4,000 liters (1 to 1,057 gallons).<sup>13</sup>

**TABLE 5-3.**  
**ESTIMATED CONSUMPTION OF SOLVENTS IN PAINTS AND COATINGS,**  
**BY MARKET**

Coating Market	Total Solvent Consumption millions of kilograms (millions of pounds)		Chlorinated Solvent Consumption millions of kilograms (millions of pounds)	
	1988	1989	1988	1989
<b>Product OEM Coatings (TOTAL)</b>	633 (1,396)	635 (1,400)	2.7 (6.1)	2.8 (6.2)
Miscellaneous Product Finishes	116 (256)	116 (256)	2.7 (6.1)	2.8 (6.2)
<b>Architectural Coatings (TOTAL)</b>	283 (624)	276 (608)	0	0
<b>Special Purpose Coatings (TOTAL)</b>	298 (657)	300 (661)	9.5 (21)	9.5 (21)
Traffic Paints	59 (130)	59 (130)	5.5 (12.2)	5.5 (12.2)
Aerosols	42 (93)	42 (93)	4 (8.9)	4 (8.9)
<b>Thinner and Miscellaneous</b>	488 (1,076)	764 (1,684)	10.4 (23)	10.4 (23)
<b>TOTAL PAINTS AND COATINGS</b>	1,919 (4,232)	2,192 (4,832)	34.8 (77.3)	35.0 (77.5)

Note: Totals may not add due to rounding.  
Source: Reference 12.

In most cases, manufacturing facilities purchase raw materials (*e.g.*, pigments, solvents, resins, and other additives) and then formulate, or blend, a finished product. Normally, no chemical reactions take place during the process. Batch process production of paint and ink involves four major steps:

- preassembly and premix
- pigment grinding/milling
- product finishing/blending
- product filling/packaging

The manufacturing process is summarized in Figure 5-1.<sup>13</sup>

The first step in the manufacturing process is preassembly and premix. In this step, the liquid raw materials (*e.g.*, resins, solvents, oils, alcohols, and/or water) are "assembled" and mixed in containers to form a viscous material to which pigments are added. The premix stage results in the formation of an intermediate product which is referred to as the base or mill base. With further processing, this base with high pigment concentration may become any one of a variety of specific end products.<sup>13</sup>

The incorporation of the pigment into the paint or ink vehicle to yield a fine particle dispersion is referred to as pigment grinding or milling. The goal of pigment grinding is to achieve fine, uniformly-ground, smooth, round pigment particles which are permanently separated from other pigment particles. The degree to which this is realized determines the coating effectiveness and permanency of the paint or ink. Some of the more commonly used types of dispersion (milling) equipment are roller mills, ball and pebble mills, attritors, sand mills, bead and shot mills, high-speed stone and colloid mills, high-speed disk dispersers, impingement mills, and horizontal media mills.<sup>13</sup>

Final product specifications are achieved in the product finishing step which consists of three intermediate stages: thinning, tinting and blending. Material letdown, or thinning, is the process by which a completed mill base dispersion is let down or reduced with solvent and/or binder to give a coating which is designed to provide a durable, serviceable film that is easily

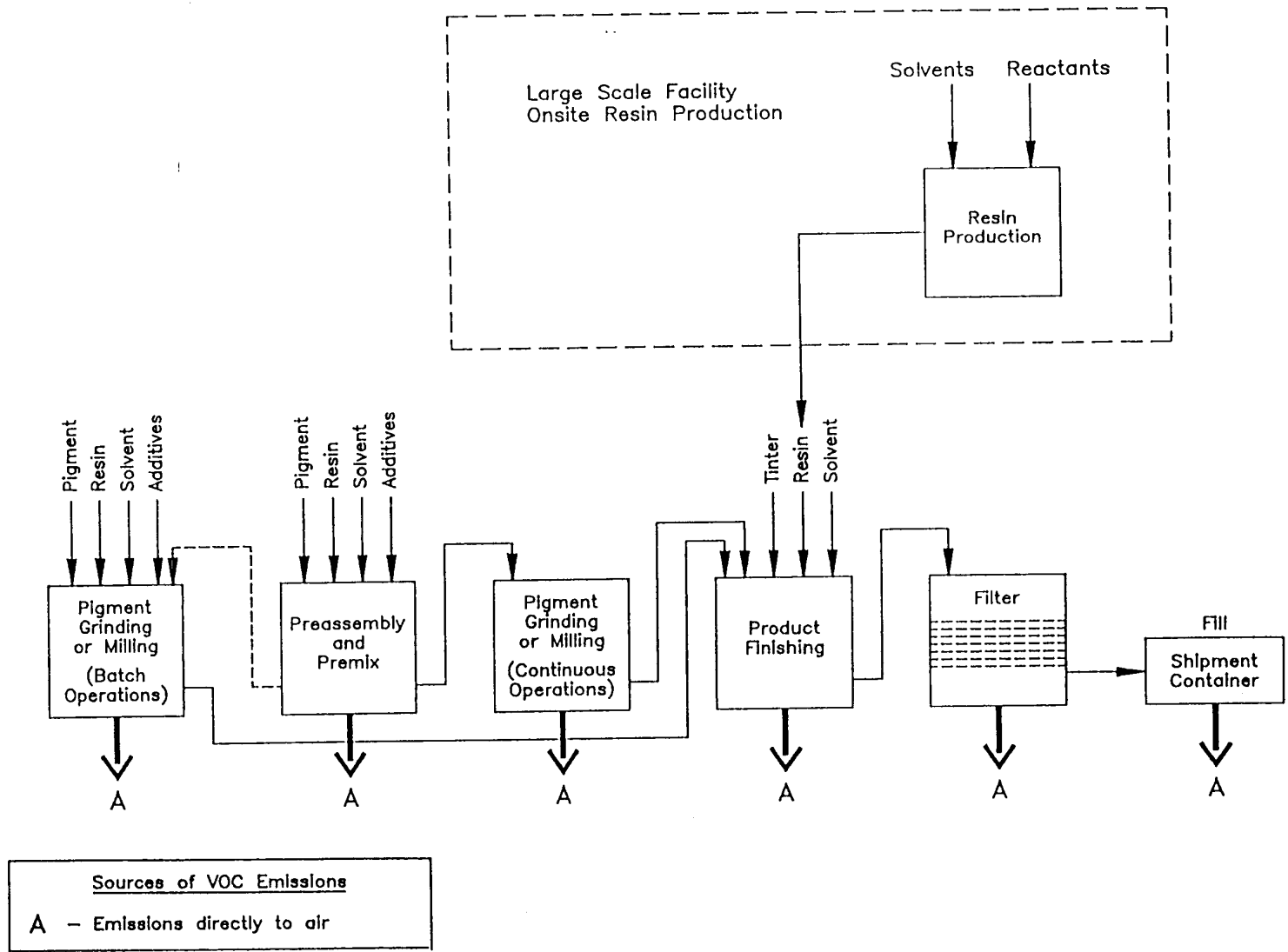

Figure 5-1. Flow diagram of the paint and ink manufacturing process.<sup>13</sup>



applied to the substrate. Tinting is the process of adjusting the color of completed mill base dispersions. Various combinations of pigments, solvents, resins, and pastes are added to the material to meet the color requirements. Blending is the process of incorporating the additions into the material in order to meet the desired product specifications.<sup>13</sup>

The final step in paint and ink manufacturing is product filling operations. After the material has been blended, it is transferred from the blend tanks into containers for product shipment. The transfer step normally involves product filtration.<sup>13</sup>

### 5.2.2 Emissions

The primary factors affecting the emission of methyl chloroform are the types of solvents and resins used in the manufacturing process, the temperature at which these compounds are mixed, and the methods and materials used during cleanup operations.<sup>13</sup>

Methyl chloroform is released from several types of equipment and handling operations throughout the paint and ink manufacturing process and during cleanup operations. During the preassembly and premix stage, equipment such as mix tanks or drums may produce emissions while resins are being thinned and materials are being added. Methyl chloroform emissions also occur during the pigment grinding step when materials are added to the dispersion equipment. The emissions that occur during the product finishing step are mainly a result of material additions during the thinning and tinting stages. Another emission source is product filtering. As product flows through a filtering device, it may be exposed to the air, resulting in releases of the incorporated methyl chloroform. Methyl chloroform emissions during filling operations result from product free-fall and material splashing. Fugitive emissions also result from flanges, valves, and pumps used to transfer material from equipment for one manufacturing stage to equipment for the next stage.<sup>13</sup> Emissions occurring during the manufacturing stages may be reduced by using equipment and process modifications such as tank lids or closed-system milling equipment.

In addition to emissions from process operations, methyl chloroform is also released from a variety of cleaning operations following the manufacture of solvent based products. In many facilities, manufacturing equipment is cleaned manually (with solvents, brushes, and/or rags) on the production floor on an as-needed basis. The standard method of cleaning grinding equipment involves emptying the mill of product and then adding solvent to the vessel to capture remaining product residue. Emissions occur during cleaning solvent addition and removal, as well as during the cleaning process.<sup>13</sup> Emissions from cleaning equipment may be reduced by using rubber wipers, high-pressure spray heads, or automatic tub washers.<sup>13</sup>

There is little emission factor information available for the manufacture of paints and inks. Figures range from process solvent losses of one to two percent under well controlled conditions to much higher percentages. The process solvent losses vary significantly from facility to facility and therefore these emissions should be evaluated on a case by case basis. Many paint and ink manufacturing facilities calculate total plant VOC emissions based on raw material consumption rather than calculating emissions from processes or equipment by an alternative method. Total emissions therefore reflect solvent losses during manufacturing, cleaning operations, and storage.<sup>13</sup>

### 5.3 AEROSOL MANUFACTURING

Methyl chloroform is used as a vapor pressure depressant in many aerosol formulations, particularly in personal care products. Methyl chloroform is also used as a formulating solvent and carrier in aerosol products such as spray paints, insecticides, and auto care items (*e.g.*, lubricants, degreasers, and brake cleaners).<sup>2,4</sup> Some of the aerosol products known to contain methyl chloroform are listed in Table 5-4. In 1987, approximately 36 million kgs (80 million lbs) of methyl chloroform were consumed in aerosol formulations. Consumption is expected to drop to 27 million kgs (60 million lbs) in 1992.<sup>4</sup>

It has been estimated that the use of aerosol formulations accounts for releases of approximately 20 million kgs (44 million lbs) of methyl chloroform each year. Of this amount, over 18 million kgs (40 million lbs) are released to the air. The remaining amount is contained

**TABLE 5-4.  
AEROSOL PRODUCTS CONTAINING METHYL  
CHLOROFORM**

Product Category	End-Use	Comments
Household Products:	Adhesives Dusting spray Leather and suede products shoe polish formulation suede cleaner and conditioner Spot remover Fabric protector/water repellant Metal cleaner/protective polish Exhaust fan and hood cleaner Mattress refresher Teflon/renewal	
Automotive:	Engine degreaser and cleaner Brake cleaner Belt dressings Lubricants	
Coatings and Finishes:	Lacquer stains Fixative and protective coatings Racing bottom treatment reagent Polyurethane coatings	
Registered Pesticides:	Dog Shield - Dog Repellant Prentox - 50% DDVP conc. Prentox - DDVP - aerosol conc. #G-1533	Personal protection from dog
	Prentox DDVP aerosol conc. Capitol DDVP conc. aerosol	For manufacturing purposes only
	Fumo - aero-spray	Industrial use only
	Bruce Terminex	Professional insecticide
	Clipper Mate Stephenson Chem. - DDVAP 14% Stephenson Chem. - DD-VP-20%	Lubricates, sanitizers cools
	Carmel Chem. - nonflammable vapona fogging insecticide	Insecticide
	Carmel Chem. - nonflammable tobacco - pyrethrum spray form F-13	Tobacco insecticide
	Pybutox - aerosol - F-201 D	Insecticide/miticide
	Gabriel DD-VP-90% conc. Moorehead 5% DD-VP spray	Insecticide/miticide
	Moorehead 10% DD-VP spray	Tobacco warehouses
	Moorehead 50% - WE conc.	Tobacco warehouses
	Swit - wasp and hornet spray Anti Shield	Insecticide

Source: Reference 15.

in solid waste. These figures are based on the assumption that 90 percent of an aerosol formulation is sprayed. An additional 5 percent is lost to the air due to container breakage prior to or during disposal. The remaining 5 percent remains in the packaging container and is sent to landfills.<sup>15</sup>

#### 5.4 ADHESIVE MANUFACTURING

Adhesives are substances used to bond two or more materials by surface attachment. They are generally applied to facilitate the bonding of paper, wood, ceramics, cork, and other materials. The three basic types of adhesives are structural adhesives, holding adhesives, and caulking or sealing adhesives. Structural adhesives are used when the bond is required to be as strong, if not stronger, than the materials of the parts. Holding adhesives are used to keep materials in their position, as tiles on a floor or wall. Adhesives used to fill in cracks and voids are caulking or sealing adhesives.<sup>16</sup> Adhesives may also be either organic, inorganic, or hybrids and consist of either water or solvent carriers.<sup>17</sup> Methyl chloroform is often used as a solvent raw material in the manufacture of synthetic, organic, solvent-based, holding adhesives. Solvent-based adhesive formulations contain approximately 67 percent by weight solvent and 33 percent by weight coating solids. The coating solids portion of the formulation consists of elastomers (*e.g.*, natural rubber, styrene-butadiene rubber, polyacrylates), tackifying resins (*e.g.*, polyterpene resins, petroleum hydrocarbon resins, and asphalts), plasticizers (*e.g.*, phthalate esters, polybutenes, mineral oil), and fillers (zinc oxide, silica, clay). Some of the commonly used adhesive solvents include toluene, xylene, heptane, hexane, methyl ethyl ketone (MEK), and acetates.<sup>18</sup>

Methyl chloroform is frequently a substitute for ethyl acetate or methyl ethyl ketone in urethane adhesives used to laminate flexible packaging films.<sup>4,17</sup> In 1987, 29 million kgs (65 million lbs) of methyl chloroform were consumed in adhesives. Methyl chloroform consumption is expected to remain constant through 1992.<sup>4</sup> This consumption accounts for approximately 10 percent of methyl chloroform end-uses.<sup>2,3</sup> Table 5-5 lists adhesive subcategories and the number of facilities within these subcategories using methyl chloroform-based formulations.

**TABLE 5-5.  
ADHESIVE SUBCATEGORIES AND NUMBER OF FACILITIES USING METHYL  
CHLOROFORM**

Adhesive Subcategory	Number of Plants Manufacturing Subcategory	Annual Production in million kgs (million lbs)		Percent of Plants Using Methyl Chloroform in Subcategory Adhesive Formulation
Solution of protein material in water	87	90.3	(199)	0
Solution of carbohydrates in water	110	129.4	(285.2)	7
Solution of inorganic materials in water	31	518	(1,141.7)	3
Dispersion of natural elastomer in water	74	15	(33.1)	3
Solutions or dispersions of other natural organics in water	46	23	(50.7)	9
Solutions or dispersions of synthetic elastomers in water	113	532	(1,172.5)	6
Solutions, emulsions, dispersions of synthetic resins in water	208	606.6	(1,336.9)	23
Solutions of natural organic compound in water	54	44.5	(98.1)	9
Solutions, dispersions of natural elastomer in solvent	48	29.5	(65.0)	17
Solutions of synthetic resin in solvent	139	91.3	(201.2)	15
Solution of synthetic elastomer in solvent	116	164	(361.4)	34
100% synthetic or natural resin, "hot melt" products	79	180.1	(396.9)	0
Chemically reactive	73	52.7	(116.2)	1
Dry blends	45	78.5	(173)	0
Others	14	33.2	(73.2)	43

Source: Reference 15.

Emissions of methyl chloroform are expected to result from both the manufacturing and application of methyl chloroform-containing adhesives. Emission sources from the manufacture of adhesives are expected to be similar to those encountered in the manufacture of paints and inks as the manufacturing processes are similar. A discussion of these emissions is included in Section 5.2.2; however, specific emission factors for methyl chloroform adhesive manufacturing were unavailable at the time this document was prepared.

Emissions resulting from the coating or application of methyl chloroform-containing adhesives occur primarily at the point of application and in the drying area/oven. In an uncontrolled facility, essentially 100 percent of the solvent used in the adhesive formulation is emitted to the atmosphere. Additional losses occur from solvent storage and handling, equipment cleaning, and miscellaneous spills.<sup>19</sup> Controls used in the application of adhesives are similar to those used in the application of other surface coatings. A general discussion of these controls is included in Section 6.1. Total methyl chloroform emissions from the use of adhesive formulations have been estimated to be 19.8 million kgs (43.6 million lbs). Of this quantity, 17.4 million kgs (38.3 million lbs) are emitted to the air, 0.9 million kgs (2.0 million lbs) are released as solid waste, 0.3 million kgs (0.7 million lbs) are released to water, 57 thousand kgs (125 thousand lbs) are destroyed, and 1 million kgs (2.2 million lbs) are recovered.<sup>15</sup>

## 5.5 CHEMICAL INTERMEDIATES

Chlorofluorocarbons (CFCs) are compounds composed of carbon, fluorine, chlorine and hydrogen and are used chiefly as refrigerants. CFCs are also used in air-conditioning equipment, as blowing agents, fire extinguishing agents, and cleaning fluids and solvents. They are sometimes erroneously referred to as freons which is actually a Trademark name for a series of CFC products. HCFCs are compounds comprised of carbon, fluorine, chlorine, and an additional halogen, usually bromine and have been developed as substitutes for some CFC applications. The term halon is also a Trademark name for a series of fluorinated brominated CFCs.

Methyl chloroform is used as a chemical intermediate in the synthesis of several HCFCs including HCFC-142b and HCFC-141b, and several halons such as halon-1211 (bromochlorodifluoromethane), halon-1301 or Freon 13B1<sup>®</sup> (bromotrifluoromethane), and halon-2402 (dibromotetrafluoroethane). Neither HCFC-141b nor HCFC-142b is subject to the Montreal Protocol requirements for the year 2000, or 1990 CAAA consumption and production phase-outs as discussed in Section 3.2; however, both are 1990 CAAA Class II substances which are scheduled for phase-out by 2020.<sup>4,20</sup>

HCFC-142b, manufactured by Pennwalt Corporation in Calvert City, Kentucky and Thorofare, New Jersey, is a precursor for the vinylidene fluoride monomer introduced in 1984 as a propellant for premium fragrances. Pennwalt is also selling mixtures of HCFC-142b and HCFC-22 having properties similar to those of chlorofluorocarbon (CFC)-11 and CFC-12. In addition, Pennwalt is evaluating HCFC-141b, a co-product in the manufacture of HCFC-142b, as an alternative to CFC-11 used as a blowing agent in the manufacture of flexible and rigid polyurethane foams and polystyrene and polyethylene foams. In spite of their advantages as potential CFC replacements, HCFC-142b and HCFC-141b are more expensive than CFC-11 and CFC-12, and they are moderately flammable. In 1987, nearly 18 million kgs (40 million lbs) of methyl chloroform were consumed in the manufacture of HCFC-142b.<sup>4</sup>

Although production of the three halons (*i.e.*, halon-1211, halon-1301, and halon-2402) is restricted by both the Montreal Protocol and the 1990 CAAA and they are scheduled for phase-out by the year 2000, small quantities may continue to be produced after the year 2000. All three of these chemicals are used in nondestructive testing for metal fatigue and corrosion of existing airplane engines and airplane parts susceptible to metal fatigue and may qualify for the aviation safety exemption of the 1990 CAAA. The Federal Aviation Administration must provide a report to Congress in 1998 which addresses the use of these halons, and other chemicals scheduled for phase-out, in aviation safety.<sup>20</sup>

Methyl chloroform emissions from the manufacture and use of halons, CFCs, and HCFCs were unavailable at the time this document was prepared.

## 5.6 MISCELLANEOUS END USES OF METHYL CHLOROFORM

Methyl chloroform is used in several applications in textile processing including scouring agents, equipment cleaning, dye carriers, and spotting fluids. Equipment cleaning may be accomplished by one of the methods discussed in Section 5.1 or by wipe cleaning, a process in which equipment (primarily texturizing machines) is merely wiped down with a solvent-laden cloth.<sup>4,15</sup> Dye carriers transfer the pigment particles from the dye solution to the fiber while scouring agents remove the natural (*e.g.*, waxes, oils, and pectins) and applied (*e.g.*, identification paints, insecticides, or bactericides) impurities from natural fibers such as cotton and wool.<sup>21</sup> These uses accounted for 5.4 million kgs (12 million lbs) of methyl chloroform consumption in 1989.<sup>2-4</sup> The 1992 consumption of methyl chloroform in textile applications is expected to be nearly 7 million kilograms (15 million pounds).<sup>4</sup>

Methyl chloroform has several uses within the electronics industry. Methyl chloroform is the preferred solvent for the cleaning of printed circuit boards, as was mentioned in Section 5.1. It is used to remove the flux left on the boards after the soldering of surface mounted devices. Methyl chloroform is also used as a developer of dry film photoresists in the solvent processing of printed circuit boards. This use, however, is expected to decrease with the increased use of aqueous cleaners. Another end use of methyl chloroform in the electronics industry is the *in situ* production of plasma etchant gases used in the production of semiconductors. Total methyl chloroform consumption in the electronics industry was 11 million kgs (25 million lbs) in 1987. Electronic industry consumption is anticipated to decline to 9 million kgs (20 million lbs) in 1992.<sup>4</sup>

Additional end uses of methyl chloroform include use as a coolant and lubricant in cutting oils, a component in plastic film (*e.g.*, movie, video, television film) cleaners, and a carrier solvent for silicone paper coatings and protective coatings. The total methyl chloroform consumption in miscellaneous uses was 21 million kgs (46 million lbs) in 1987. Miscellaneous use consumption is anticipated to decline to 20 million kgs (45 million lbs) in 1992.<sup>4</sup>



No emissions data are available for textile processing, electronics manufacturing, or other miscellaneous uses of methyl chloroform. To determine actual emissions from particular processes, specific plants should be contacted.

## 5.7 REFERENCES FOR SECTION 5.0

1. Considine, Douglas M., ed., *Chemical and Process Technology Encyclopedia*. McGraw-Hill Book Company, New York, NY. 1974.
2. "1,1,1-Trichloroethane," *Chemical Products Synopsis*. Mannsville Chemical Products, Asbury Park, NJ. October 1990.
3. "Chemical Profile: 1,1,1-Trichloroethane," *Chemical Marketing Reporter*. January 27, 1992.
4. "C<sub>2</sub> Chlorinated Solvents," *Chemical and Economics Handbook*, SRI International, Menlo Park, CA. December 1988.
5. U.S. Environmental Protection Agency. *Alternative Control Technology Document - Halogenated Solvent Cleaners*. EPA-450/3-89-030. Office of Air Quality Planning and Standards. Research Triangle Park, NC. August 1989.
6. Toxic Chemical Release Inventory (TRI). 1990.
7. Archer, W.L., "Other Chloroethanes," *Kirk-Othmer Encyclopedia of Chemical Technology*, Third Edition, Vol. 5. 1979. pp. 722-742. 1979.
8. U.S. Environmental Protection Agency. *Locating and Estimating Air Emissions from Sources of Perchloroethylene and Trichloroethylene*. EPA-450/2-89-013. Office of Air Quality Planning and Standards. Research Triangle Park, NC. August 1989.
9. U.S. Environmental Protection Agency. *Control of Volatile Organic Emissions from Solvent Metal Cleaning*. EPA-450/2-77-022. Office of Air Quality Planning and Standards. Research Triangle Park, NC. November 1977.
10. U.S. Environmental Protection Agency. *Organic Solvent Cleaners - Background Information on Proposed Standards*. EPA-450/2-78-045a. Office of Air Quality Planning and Standards. Research Triangle Park, NC. October 1979.
11. Sheiman, Deborah, *et al.*, *A Who's Who of American Ozone Depleters: A Guide to 3,014 Factories Emitting Three Ozone Depleting Chemicals*. Natural Resources Defense Council. January 1990.
12. SRI International. *U.S. Paint Industry Database*. Prepared for the National Paint and Coatings Association. Washington, DC. 1990.
13. U.S. Environmental Protection Agency. *Control of VOC Emissions from Ink and Paint Manufacturing Processes*. EPA-450/3-92-013. Office of Air Quality Planning and Standards. Research Triangle Park, NC. 1991.

14. Gale Research, Inc. *Ward's Business Directory of U.S. Private and Public Companies-1991, Volume 4*. Detroit, MI. 1991.
15. Memorandum from Michael A. Callahan, U.S. Environmental Protection Agency, TSPC Solvents Work Group #2, to Elizabeth Anderson, U.S. Environmental Protection Agency, TSPC Solvents Work Group #1, "Draft Exposure Assessment for TSPC Solvents." Public Docket No. A-84-41, II-B-1.
16. Considine, Douglas M., ed., *Chemical and Process Technology Encyclopedia*. McGraw-Hill, Inc. pp. 38-39. 1974.
17. U.S. Environmental Protection Agency. *Summary of Technical Information for Selected Volatile Organic Compound Source Categories*. EPA-450/3-81-007. Office of Air Quality Planning and Standards. Research Triangle Park, NC. May 1981.
18. U.S. Environmental Protection Agency. *Compilation of Air Pollutant Emission Factors*. AP-42, Fourth Edition and Supplements, Office of Air Quality Planning and Standards. Research Triangle Park, NC. pp. 4.2.2.9-1 and 4.2.2.9-3. 1985.
19. U.S. Environmental Protection Agency. *Procedures for the Preparation of Emission Inventories for Carbon Monoxide and Precursors of Ozone - Volume I* EPA-450/4-91-016. Office of Air Quality Planning and Standards. Research Triangle Park, NC. May 1991.
20. Public Law 101-549. *The Clean Air Act Amendments of 1990*, Title VI - Stratospheric Ozone Protection. November 15, 1990.
21. U.S. Environmental Protection Agency. *Control Techniques for Volatile Organic Emissions from Stationary Sources*. EPA-450/2-78-022. Office of Air Quality Planning and Standards. Research Triangle Park, NC. May 1978.

## SECTION 6.0

### RESIDUAL AND BY-PRODUCT EMISSIONS OF METHYL CHLOROFORM

This section examines residual emissions from the use or processing of methyl chloroform-containing materials. Methyl chloroform may be emitted when methyl chloroform-containing products such as paint and coatings release small amounts over time. Methyl chloroform emissions can also occur as the result of the manufacture of another product. These emissions are described in this section as by-product emissions. Pulp processing is a process leading to by-product emissions of methyl chloroform.

The production descriptions and emissions data presented in this section represent some of the most common and relevant processes and products. Because of methyl chloroform's widespread use, all processes cannot be included in this document.

#### 6.1 SURFACE COATING OPERATIONS

Surface coating operations involve the application of paint, varnish, lacquer or primer for decorative, functional, or protective purposes. In 1989, 10.2 million kgs (22.5 million lbs) of methyl chloroform were consumed in paints and coatings.<sup>1</sup> Consumption of solvents in specific end-use markets was presented in Section 5.2, Table 5-3. Table 6-1 contains a list of surface coating source categories and associated SICs in which methyl chloroform is used. Table 6-1 also presents potential methyl chloroform emission points and emissions reduction opportunities. References are provided for additional information.

The general application methods for surface coating operations are discussed below. Because surface coating is a very broad category, detailed process descriptions and process flow diagrams for each category are not included in this document; however, the reader is encouraged to review the references mentioned at the end of this section and in Table 6-1.

**TABLE 6-1.  
METHYL CHLOROFORM SOURCE CATEGORIES IN  
SURFACE COATING OPERATIONS**

General Source Category	Associated SIC(s)	Emission Point Sources	Emissions reduction by process/product modification	Additional References
Paper and Paperboard	2621, 2631, 2652-53, 2656, 2657, 2671-72, 2675, 2676, 2678-79	[1] Application area [2] Oven areas [3] Coating mixing [4] Coating and solvent storage [5] Equipment cleanup [6] All solvent used and not recovered or destroyed can be considered potential emission sources	[1] Carbon adsorber [2] Thermal incinerator [3] Catalytic incinerator [4] Condensers	8
Adhesives and Sealants	2891	[1] Adhesive application [2] Drying oven exhaust [3] Solvent mixing [4] Solvent storage [5] All solvent used and not recovered or destroyed can be considered potential emission sources	[1] Thermal incineration [2] Carbon adsorption	9,10
Wood Products	2426-29, 2434, 452, 2511-12, 2515, 2517, 2519, 2521, 2531, 2541, 3995	[1] Application area [2] Flashoff coating operations [3] Oven areas [4] Coating mixing [5] Coating and solvent storage [6] Equipment cleanup [7] All solvent used and not recovered or destroyed can be considered potential emission sources	[1] Waterborne coatings [2] Carbon adsorption [3] Thermal incineration [4] Catalytic incineration	11
Flatwood Products	2435-36, 2491-99	[1] Application area [2] Flashoff area: Filler, sealer, basecoat, topcoat, inks [3] Oven areas [4] Coating mixing [5] Coating and solvent storage [6] Equipment cleanup [7] All solvent used and not recovered or destroyed can be considered potential emission sources	[1] Waterborne coating for filler and basecoat [2] Ultraviolet cure coatings [3] Afterburners [4] Carbon adsorption	12,13

Source: References 2-7.

### 6.1.1 Process Description

Industrial surface coating operations use several different methods to apply coatings to substrates. Some of the more commonly used techniques include spraying, dipping, rolling, flow coating, knife coating, and brushing. In addition to the application of coatings to substrates, many surface coating operations also include surface preparation steps (*e.g.*, cleaning and degreasing), drying and curing stages. Spraying operations are normally performed in a spray booth using one of the following spray application methods: air atomization; airless atomization; air-assisted airless; high-volume, low-pressure (HVLP); and electrostatic. Dip coating involves briefly immersing the substrate in a tank containing a bath of paint. The object is slowly removed from the tank, allowing excess paint to drain back into the tank. Roller coating is used to apply coatings and inks to flat surfaces. A typical roller coating machine contains three or more power driven rollers, one of which is partially immersed in the coating material. The paint is transferred to a second, parallel roller by direct contact. The sheet to be coated is run between the second and third rollers, and is coated by transfer of paint from the second roller. Flow coating is used on articles which cannot be dipped due to their buoyancy, such as fuel oil tanks, gas cylinders, or pressure bottles. In this operation the coating material is fed through overhead nozzles which apply the paint in a steady stream over the article to be coated. Excess paint is allowed to drain from the coated object and is then recycled. Knife coating is used primarily to coat paper or fabric webs. The adjustable blade or "knife" distributes a liquid coating evenly over a moving surface.

### 6.1.2 Emissions<sup>14,15</sup>

Figure 6-1 is a generic flow diagram of a surface coating operation. Process operations, auxiliary facilities, and emission points are illustrated. Note that this is a generic figure and may differ significantly from any specific coating operation. The operations shown include degreasing, surface coating, and drying and curing. Auxiliary facilities include degreasing solvent storage, surface coating storage and blending, and steam generation. Industrial categories,

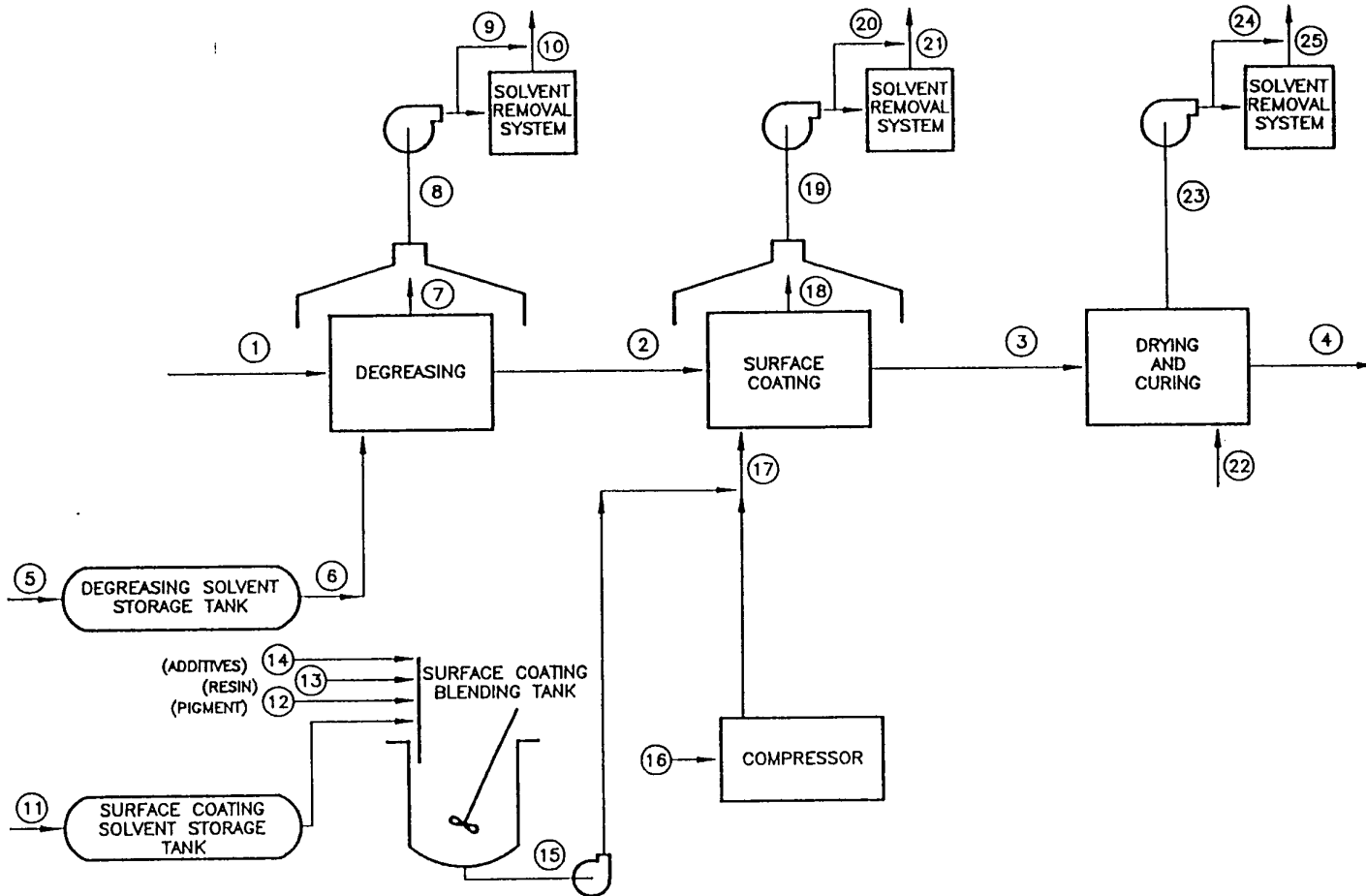

Figure 6-1. Flow diagram of a surface coating operation.<sup>14</sup>

specific operations and emission points resulting in expected methyl chloroform emissions from surface coating operations are presented in Table 6-1 and as part of Appendix A.

Streams 1, 2, 3, and 4 depict the flow of products through the plant. Stream 1 represents the input of uncoated products to the surface coating system. Stream 2 represents the flow of degreased or scoured products to the surface coating operation. The type of surface coating operation used will depend upon the product-type coated, coating requirements, and the method of application. Stream 3 represents the product flow to the drying and curing operation. Stream 4 represents the flow of coated finished products from the surface coating section of a manufacturing plant.

Streams 5 through 10 represent the flow of degreasing solvent through the surface coating section of a manufacturing plant. Streams 5 and 6 depict the flow of solvent into the plant and to the degreasing unit. Streams 7 and 8 represent the flow of solvent vapors from the degreasing unit through the fume handling system. Uncontrolled and controlled emissions are represented by streams 9 and 10, respectively.

Streams 11 through 21 represent the flow of surface coating raw materials through the plant. Streams 11, 12, 13, and 14 represent the flow of solvent, pigment, resin, and additives to the surface coating blending tank. Stream 15 is the flow of coating to the surface coating unit. For those operations that use spray painting, stream 16 is the flow of compressed air. Streams 18 and 19 represent the flow of solvent and resin from the surface coating unit through the fume handling equipment. Uncontrolled and controlled emissions are depicted by streams 20 and 21. Potential emission point sources were previously identified in Table 6-1.

In Figure 6-1, streams 22 through 25 represent the flow of gases (*e.g.*, fuel, steam or electrically heated air) to the drying and curing operation. Drying and curing operations occur in flash-off areas and curing ovens. Flash-off areas are the places between application areas, or between an application area and an oven, in which solvent is allowed to volatilize from the coated piece. Ovens are used between some coating steps to cure the coating prior to the next



step in the finishing sequence. Streams 24 and 25 represent uncontrolled and controlled emissions. No emission factor data were found in the literature.

Facilities with surface coating operations may purchase and apply ready-to-use coatings, or they may dilute their purchased coatings to decrease the coating viscosity and improve performance and ease of application. Methyl chloroform is used in solvent-based coating formulations either as part of the coating vehicle or as a thinner. If a coating formulation is to be diluted in-house, several factors (*e.g.*, temperature, humidity, and type of coating) can determine the required dilution ratio. Consequently, the amount of methyl chloroform used may vary.<sup>2,14,16,17</sup> Emissions from the mixing and blending of surface coatings were previously discussed in Section 5.2.2.

Methyl chloroform may also be used in clean-up operations. Clean-up solvent is used to clean application equipment, piping, spray booths, coating storage and distribution equipment, and to strip cured coatings from wood parts or machinery.<sup>14</sup>

One method of reducing methyl chloroform emissions from surface-coating operations is to modify the surface-coating formulation. Conventional coatings normally contain at least 70 percent by volume solvent (either one solvent or a mixture of solvents) to permit easy handling and application. Minimizing or eliminating the use of these solvents in surface-coating formulations is the most effective way to reduce VOC emissions. Alternatives to these conventional coatings include water-based coatings, high-solids coatings, powder coatings, and radiation-curable coatings.<sup>14</sup>

Large surface-coating facilities may use add-on control devices to capture and control solvent emissions. Some commonly used capture devices include covers, vents, hoods, and partial or total enclosures. Adsorbers, condensers and incinerators, with control efficiencies of 95 to 98 percent, are the most common control devices used in surface coating operations.<sup>14,16,17</sup>

## 6.2 WASTEWATER TREATMENT PROCESSES

Atmospheric emissions of volatile organic compounds such as methyl chloroform can occur at any wastewater treatment process where the wastewater comes into contact with the surrounding ambient air. The majority of air emissions from wastewater treatment facilities may be expected from the initial physical processes (*e.g.*, screening, sedimentation, floatation, and filtration), due to both a higher pollutant concentration in the influent and a greater surface area caused by turbulence and mixing. Other sources of emissions include equalization and aeration basins, and clarifiers. Significant volatile organic compound emissions may occur if an oil/water separation treatment step is incorporated within the process. The lighter organic compounds rise within the wastewater to form an oil-based layer that rests on top of the main body of wastewater in the separation basin. Factors affecting volatilization of organic compounds from the top organic layer include characteristics of the wastewater and oil layers, the ambient wind speed, design characteristics of the wastewater treatment operation, the concentration of pollutants in the wastewater, detention time in the treatment system, and partition coefficients of the pollutants.<sup>18,19</sup>

Methyl chloroform has been estimated as one of the most pervasive volatile organic compounds emitted from publicly owned treatment works (POTWs) nationally, with approximately 3 million kgs (6.6 million lbs) emitted per year prior to 1986.<sup>20</sup> A study of two wastewater treatment facilities in the Chicago area revealed that volatilization is the primary removal mechanism of methyl chloroform from wastewater. Adsorption and biodegradation removal mechanisms were insignificant and absent, respectively. Estimated total methyl chloroform emissions from the two facilities in the Chicago study were 9,299 kgs (20,460 lbs) per year.<sup>21</sup> A California-based study of uncontrolled statewide municipal wastewater treatment plants (51 plants in sample) estimated methyl chloroform emissions of 90,900 kgs (200,000 lbs) per year.<sup>22</sup> Finally, a 1989 volatile organic compound receptor modeling study cites significant methyl chloroform emissions data from two in-plant ambient air studies and three modeling studies.<sup>23</sup>

Because of the many factors that may affect emissions of volatile organics, including methyl chloroform, from wastewater treatment processes, estimating actual emissions must be performed on a chemical-by-chemical, process-by-process basis. Several models have been developed that estimate emissions from wastewater treatment processes. A brief description of some appropriate models are presented below; however, further information should be consulted in the appropriate reference(s) provided in Section 6.4.<sup>24-28</sup>

The SIMS model (Surface Impoundment Modeling System), developed by the Control Technology Center of the U.S. Environmental Protection Agency, is a personal computer-based software program designed to estimate atmospheric emissions from surface impoundments and wastewater collection devices.<sup>24</sup> Emissions estimates are based on mass transfer models developed by the Emissions Standards Division (ESD) of the EPA and are available for 147 compounds.

CHEMDAT7 is a spreadsheet program developed by the Office of Air Quality Planning and Standards, EPA, that includes analytical models for estimating volatile organic compound emissions from hazardous waste, treatment, storage, and disposal facility (TSDF) processes under user-specified input parameters.<sup>25</sup> This model only addresses emissions through volatilization and biodegradation mechanisms, and includes emissions from non-aerated, aerated, and disposal impoundments, land treatment, and landfills. The CHEMDAT7 database covers 700 compounds.

The Civil Engineering Department at the University of California, Davis, along with CH2M-Hill and the Bay Area Air Toxics Group, developed the Bay Area Sewage Toxics Emission (BASTE) Model that can estimate VOC losses from a series of wastewater treatment processes for an entire treatment facility.<sup>26</sup> The BASTE Model can calculate losses associated with volatilization, adsorption, and biodegradation of VOCs, and it does allow for temperature changes and will model all aspects of a POTW. This model can simulate completely mixed systems, but is limited to the number of chemicals it will allow to be input into the model. The input parameters are generally more complex than for the other models, yet the BASTE model provides a higher degree of flexibility.<sup>26</sup>

Another model for estimating VOCs from wastewater treatment facilities was developed by Camp Dresser & McKee of Boston, MA, for estimating VOC emissions for a future plant.<sup>27</sup> According to the Pincince model, approximately 95 percent of the total VOC emissions occur at weirs such as the primary and secondary splitter boxes, at the grit chamber and primary clarifier weirs, and at the ends of the aeration tanks. Approximately four percent of the total VOC emissions were from the aeration tanks when high-purity oxygen was used. These estimates are considered conservative, since the Pincince model does not account for compounds which are adsorbed and subsequently released. Factors that the model does consider include Henry's law coefficients, the octanol-water partition coefficient ( $K_{ow}$ ), the nature of the air/water interface, wind speed, and process design parameters.

The Tsivoglou and Neal Reaeration model can be used with the SIMS model to estimate VOC emissions from the devices that comprise the headworks of a POTW (since the SIMS model does not account for emissions from these devices or for adsorption onto solids).<sup>28</sup> This Reaeration model estimates the oxygen mass transfer rate constant as a function of the change in elevation and time of flow between two locations in a stream. The oxygen mass transfer coefficient is then adjusted to estimate the VOC mass transfer coefficient.

Several inherent problems exist with using these models. First, the VOC concentrations in the wastewater are highly variable among the influent, effluent, and sludge partitions; therefore, a single emission estimate would be highly questionable. Second, the estimates are usually based on constant behavior of relatively pure compounds, so mixing and variable chemical concentrations would render the emission factors less useful. Finally, these estimates are generally on the conservative side, and actual emissions will often tend to be higher than the estimates.

## 6.3 PULP AND PAPER PRODUCTION

### 6.3.1 Description of Pulp Processing

Pulping consists of converting raw materials into fibers which can be used in products such as paper, paperboard, or building materials. Although the raw materials include fibers from waste paper (*i.e.*, secondary fibers), cotton or wool, the principle source is wood fibers from trees (*i.e.*, virgin fibers). Wood pulp is treated either mechanically or chemically to liberate the fibers. Chemical processes [including kraft (sulfate), sulfite, neutral sulfite semichemical (NSSC), or soda pulping] produce fibers by dissolving the binding material in the wood (*i.e.*, the lignin) in chemical solutions.<sup>29</sup>

Kraft (sulfate) pulping is the most common pulping method in the United States. In 1990, paper and paperboard mills consumed 55 million kgs (122 million lbs) of wood pulp. Bleached sulfate accounted for 24 million kgs (52 million lbs) and unbleached sulfate accounted for 20 million kgs (45 million lbs).<sup>30</sup> An overview of the kraft pulping process is presented in Figure 6-2. Wood chips are normally loaded into a batch digester where they are cooked at elevated temperatures of 170° to 180°C (338° to 356°F) and pressure in a "white liquor." The white liquor is typically a water solution of sodium sulfide and sodium hydroxide.<sup>31,32</sup> Once the liquor has dissolved the lignin and loosened the wood fibers, the wood chip mixture is transferred to a blow tank where the fibers are freed. The mixture then moves to a pulp filter which separates the pulp from knots, chips, uncooked pieces of wood, and the cooking liquor. The wood pulp proceeds through various stages of washing, and often bleaching, after which it is pressed and dried into the final product.<sup>29,32</sup>

Bleaching is often included as part of the pulp treating process to improve the intensity and permanency of the whiteness in the pulp. Bleaching uses chlorine and chlorine compounds in three different forms. In the chlorination stage, pulp is treated with gaseous chlorine primarily to oxidize and chlorinate the remaining lignin which is then dissolved from the pulp in successive steps. The pulp is washed and sent to the caustic extraction stage where sodium hydroxide

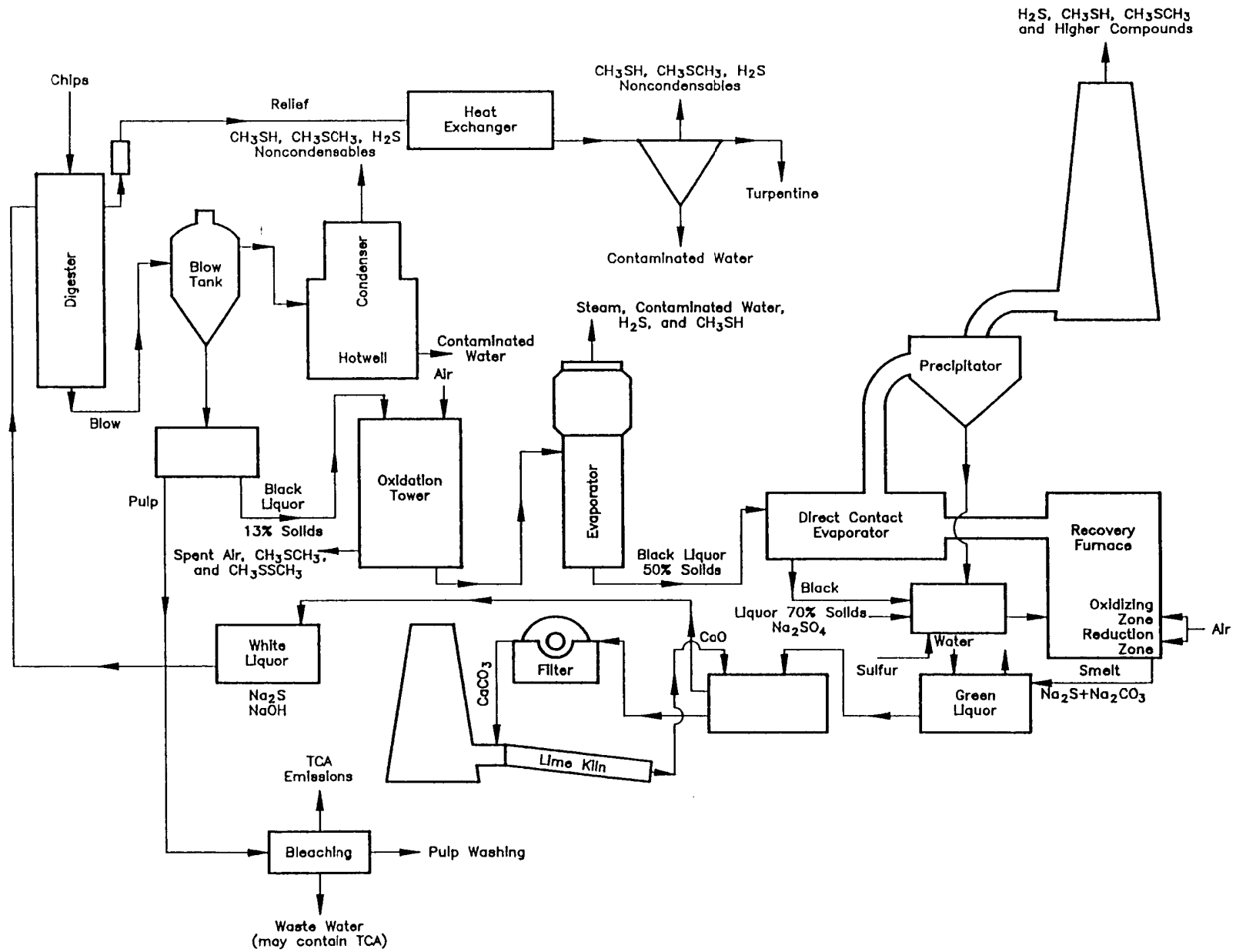

Figure 6-2. Typical kraft sulfate pulping and recovery process.<sup>32</sup>

(pH 12) breaks down and removes the lignin. A second washing occurs after which the pulp is treated with sodium hypochlorite and/or peroxide.<sup>32,33</sup>

The remainder of the kraft process is designed to recover the heat and cooking chemicals from the digester. The spent cooking liquor and the pulp wash water are combined to form a weak black liquor which is concentrated to 55 percent solids in a multiple-effect evaporator and then further concentrated to 65 percent solids in a direct-contact evaporator using flue gases from the recovery furnace. The concentrated black liquor is fired in a recovery furnace where organics in the liquor are burned to provide heat for steam. The inorganic portion of the black liquor collects as molten smelt at the bottom of the furnace. The smelt is dissolved in water to form green liquor and then transferred to a causticizing tank where quicklime (calcium oxide) is added to convert the solution back to white liquor for return to the digester system.<sup>32</sup>

### 6.3.2 Atmospheric Emissions from Pulp Processing

The primary emissions from pulping operations are reduced sulfur compounds such as hydrogen sulfide, methylmercaptan, dimethyl sulfide, and dimethyl disulfide.<sup>32</sup> However, the Toxic Chemical Release Inventory (TRI) indicates that facilities classified under SIC 2611 (Pulp Mills) emit significant amounts of methyl chloroform. Upon contacting TRI facilities classified under SIC 2611, it was discovered that the majority of atmospheric emissions of methyl chloroform occur from secondary processes such as paper coating or equipment cleaning. One facility did report that both air and water emissions of methyl chloroform resulted from reactions occurring during the bleaching process.<sup>34</sup> This facility also cited the *Handbook of Chemical Specific Information for SARA 313 Form R Reporting*, a publication distributed by the National Council of the Paper Industry for Air and Stream Improvement, as documenting these emissions and describing the environmental fate of methyl chloroform.<sup>35</sup> This document was unavailable for use in preparing this report.

#### 6.4 REFERENCES FOR SECTION 6.0

1. SRI International. *U.S. Paint Industry Database*. Prepared for the National Paint and Coatings Association. Washington, DC. 1990.
2. U.S. Environmental Protection Agency. *VOC Pollution Prevention Options for the Surface Coating Industry*. Research Triangle Park, NC. 1991.
3. U.S. Environmental Protection Agency. *Procedures from the Preparation of Emission Inventories for Carbon Monoxide and Precursors of Ozone, Volume I*. EPA-450/4-91-016. Research Triangle Park, NC. May 1991.
4. U.S. Environmental Protection Agency. *Recordkeeping Guidance Document for Surface Coating Operations and the Graphic Arts Industry*. EPA-340/1-88-003. Stationary Source Compliance Division. Washington, DC. December 1988.
5. Ron Joseph and Associates, Inc. *Environmental and Coatings Training Program*. Workbook for presentation by Ron Joseph to EPA Region 1. September 2 and 3, 1987.
6. The Bureau of National Affairs, Air Pollution Control. *BNA Policy and Practice Series*. Washington, DC.
7. Strait, R. *et al.* *VOC Control Policy in the United States: An Overview of Programs and Regulations*. Alliance Technologies Corporation. Chapel Hill, NC. December 1991.
8. U.S. Environmental Protection Agency. *Control of Volatile Organic Emissions from Existing Stationary Sources*. Volume 11: Surface Coating of Cans, Coils, Paper, Fabrics, Automobiles and Light-Duty Trucks. EPA-450/2-77-088. Research Triangle Park, NC. 1977.
9. U.S. Environmental Protection Agency. *Pressure Sensitive Tape and Label Surface Coating Industry - Background Information for Proposed Standards*. EPA-450/3-80-003A. Research Triangle Park, NC. 1980.
10. U.S. Environmental Protection Agency. *Final Environmental Impact Statement Pressure Sensitive Tape and Label Surface Coating Industry - Background Information for Promulgated Standards*. EPA-450/3-80-003B. Research Triangle Park, NC. 1983.
11. U.S. Environmental Protection Agency. *Control of Volatile Organic Compound Emissions from Wood Furniture Coating Operations*. Draft CTG. Research Triangle Park, NC. October 1991.
12. U.S. Environmental Protection Agency. *Enforceability Aspects of RACT for Factory Surface Coating of Flat Wood Paneling*. EPA-340/1-80-005. Washington, DC. 1980.



13. U.S. Environmental Protection Agency. *Control of Volatile Organic Emissions from Existing Stationary Sources*. Volume 11: Surface Coating of Flatwood Paneling. EPA-450/2-78-032. Research Triangle Park, NC. 1978.
14. U.S. Environmental Protection Agency. *Compilation of Air Pollutant Emission Factors*. AP-42, Fourth Edition and Supplements. Research Triangle Park, NC. 1985.
15. U.S. Environmental Protection Agency. *Source Assessment: Prioritization of Air Pollution from Industrial Surface Operations*. EPA-650/2-75-019a. Research Triangle Park, NC. 1975.
16. Bridgewater, A.V. and C.J. Mumford. *Water Recycling and Pollution Control Handbook*. Van Nostrand Reinhold Company. 1979.
17. Godish, Thad. *Air Quality*. Director of the Indoor Air Quality Research Laboratory. 1985.
18. U.S. Environmental Protection Agency. *Guideline Series: Control of Volatile Organic Compound Emissions from Industrial Wastewater, Vol. 1*. Preliminary Draft. Office of Air Quality Planning and Standards. Research Triangle Park, NC. April 1989.
19. U.S. Environmental Protection Agency. *VOC Emissions From Petroleum Refinery Wastewater Systems - Background Information for Proposed Standards*. Draft EIS. EPA-450/3-85-001a. Office of Air Quality Planning and Standards. Research Triangle Park, NC. February 1985.
20. U.S. Environmental Protection Agency. *Report to Congress on the Discharge of Hazardous Wastes to Publicly Owned Treatment Works*. EPA/530-SW-86-004. February 1986.
21. Rittman, Bruce E. and Namkung, Eun. "Estimating Volatile Organic Compound Emissions from Publicly Owned Treatment Works," *Journal of The Water Pollution Control Federation* 59(7):670-678. July 1987.
22. Corsi, Richard L., *et al.* "Emissions of Volatile and Potentially Toxic Organic Compounds from Municipal Wastewater Treatment Plants," Presented at the 80th Annual Meeting of APCA, New York, NY. June 21-26, 1987.
23. Schelf, Peter A., *et al.* "Source Fingerprints for Receptor Modeling of Volatile Organics," *Journal of the Air and Waste Management Association (JAPCA)* 39(4):469-478. April 1989.

24. U.S. Environmental Protection Agency. *Surface Impoundment Modeling System (SIMS) Version 2.0 User's Manual*. Control Technology Center. EPA-450/4-90-019a. Research Triangle Park, NC. 1990.
25. U.S. Environmental Protection Agency. *Hazardous Waste Treatment, Storage, and Disposal Facilities (TSDF) - Air Emissions Models*. Review Draft. Office of Air Quality Planning and Standards. November 1990.
26. *BASTE (Bay Area Sewage Toxics Emissions) User's Guide*. CH2M-Hill. Document No. SF0176/060A.51. May 1990.
27. Pincince, A.B. "Calculating Emissions of Volatile Organic Compounds from Wastewater Treatment Plants," Proceedings of the Winter 1988 Meeting of the New England Water Pollution Control Association. Boston, MA. 1988.
28. Tsivoglou, E.C., and L.A. Neal. "Tracer Measurement of Reaeration, III, Predicting the Reaeration Capacity of Inland Streams," *Journal of Water Pollution Control Federation* 48(12):2669. 1976.
29. Kline, James E., *Paper and Paperboard Manufacturing and Converting Fundamentals*. Miller Freeman Publications, Inc. San Francisco, CA. pp. 29-70. 1982.
30. *Consumption of Pulpwood, Wood Pulp and Other Fibrous Materials in Paper and Paperboard Mills*. American Paper Institute. Table XXII transmitted via fax on May 29, 1992.
31. Smook, G.S., and M.J. Kocurek, ed. *Handbook for Pulp & Paper Technologies*. Joint Textbook Committee of the Paper Industry, Canada. pp. 38-39, 364-367. 1982.
32. U.S. Environmental Protection Agency. "Chemical Wood Pulping," *Compilation of Air Pollutant Emission Factors*. AP-42. Fourth Edition and Supplements, Section 10.1, Research Triangle Park, NC. 1985.
33. Environmental Protection Service, Environment Canada. *State-of-the-Art of the Pulp and Paper Industry and its Environmental Protection Practices*. Report EPS 3-EP-84-2. Environmental Protection Programs Directorate. pp. 60-66. 1984.
34. Personnel communication with R. Sherwood, Pope and Talbot Pulp, Inc., Halsey, Oregon, by B. McMinn, TRC Environmental Corporation. "TRI Emissions of Methyl Chloroform." June 22, 1992.
35. National Council of the Paper Industry for Air and Stream Improvement. *Handbook of Chemical Specific Information for SARA 313 Form R Reporting*. New York, NY.



## SECTION 7.0

### AMBIENT AIR AND STATIONARY SOURCE TEST PROCEDURES

Methyl chloroform (1,1,1-trichloroethane) emissions can be measured from ambient air and stationary sources utilizing the test methods presented below. If applied to stack sampling, the ambient air monitoring methods may require adaptation or modification. Appropriate precautions must be taken to ensure that the capacity of the methodology is not exceeded so that results will be quantitative. Ambient methods which require the use of sorbents are susceptible to sorbent saturation if high concentration levels exist. If this happens, breakthrough will occur, and quantitative analysis will not be possible.

- EPA Method TO-1: Determination of Volatile Organic Compounds in Ambient Air Using Tenax<sup>®</sup> Adsorption and Gas Chromatography/Mass Spectrometry (GC/MS)
- EPA Method TO-2: Determination of Volatile Organic Compounds in Ambient Air by Carbon Molecular Sieve Adsorption and Gas Chromatography/Mass Spectrometry (GC/MS)
- EPA Method TO-14: Determination of Volatile Organic Compounds (VOCs) in Ambient Air Using SUMMA<sup>®</sup> Passivated Canister Sampling and Gas Chromatographic (GC) Analysis
- EPA Method 0030: Volatile Organic Sampling Train (VOST) with EPA Method 5040: Analysis of Sorbent Cartridges from VOST

The following subsections briefly describe the recommended sampling and analytical methods for determining methyl chloroform emissions.

#### 7.1 EPA METHOD TO-1<sup>1</sup>

Ambient air concentrations of methyl chloroform can be measured using EPA Method TO-1 from the *Compendium of Methods for the Determination of Toxic Organic Compounds in Ambient Air*. This method is used to collect and determine volatile nonpolar organics (aromatic hydrocarbons, chlorinated hydrocarbons) that can be captured on Tenax<sup>®</sup> and determined by thermal desorption techniques. The compounds determined by this method have boiling points

in the range of 80° to 200°C (180° to 390°F). Figure 7-1 presents a schematic of the sampling system and Figure 7-2 presents a schematic of typical Tenax<sup>®</sup> cartridge designs.

Ambient air is drawn through the cartridge which contains approximately 1 to 2 grams (0.035 to 0.07 ounces) of Tenax<sup>®</sup>. Methyl chloroform is trapped on the Tenax<sup>®</sup> cartridge which is then capped and sent to the laboratory for analysis utilizing purge-and-trap gas chromatography/mass spectrometry (GC/MS) according to the procedures specified in EPA Method 5040 (see Section 7.5). The recommended GC column is a 50 meter capillary, type SE-30 with an internal diameter of 0.3 mm.

The exact run time, flow rate and volume sampled varies from source to source depending on the expected concentrations and the required detection limit. Typically, 10 to 20 L (0.3 to 0.7 ft<sup>3</sup>) of ambient air are sampled. Analysis should be conducted within 14 days of sample collection.

## 7.2 EPA METHOD TO-2<sup>1</sup>

Ambient air concentrations of methyl chloroform can be measured using EPA Method TO-2 from the *Compendium of Methods for the Determination of Toxic Organic Compounds in Ambient Air*. Compounds which can be determined using this method are nonpolar and highly volatile organics that can be captured on carbon molecular sieve (CMS) and determined by thermal desorption techniques. The compounds to be determined by this method have boiling points in the range of -15° to 120°C (5° to 250°F). Methyl chloroform can be determined using this method.

In summary, ambient air is drawn through a cartridge containing approximately 0.4 grams (0.01 ounces) of CMS adsorbent. Methyl chloroform is captured on the adsorbent while major inorganic compounds pass through. The sample is then capped and sent to the laboratory for analysis.

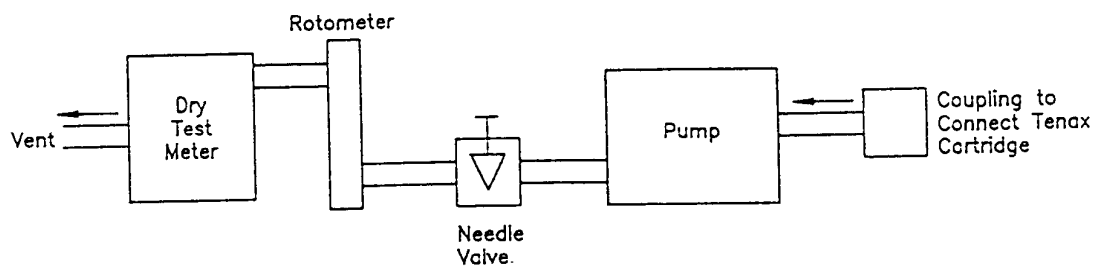
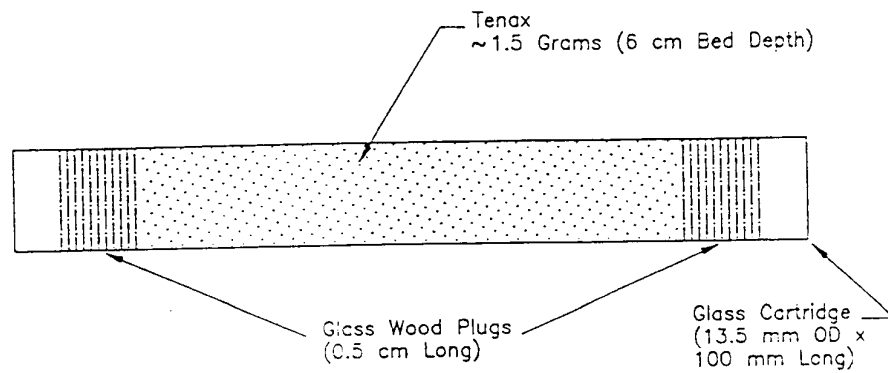
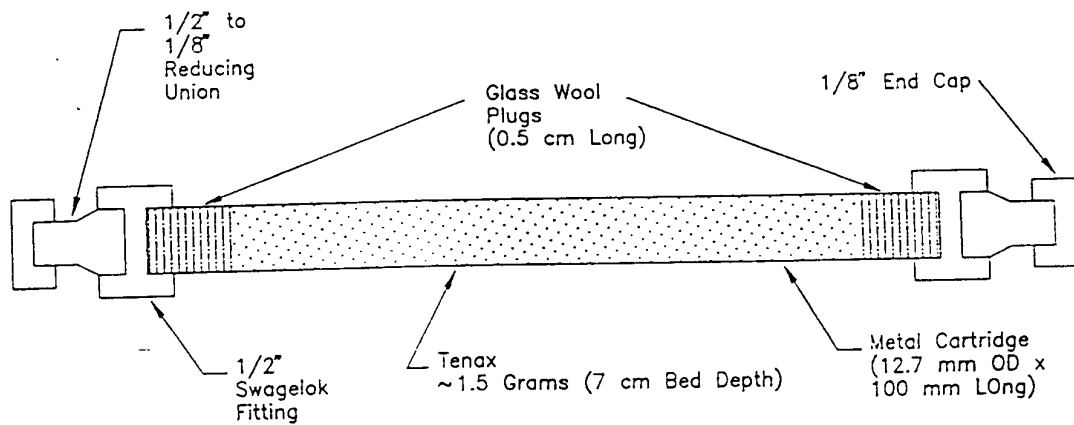

Figure 7-1. EPA Method TO-1 sampling system.<sup>1</sup>



(a) Glass Cartridge



(b) Metal Cartridge

Figure 7-2. Tenax<sup>®</sup> cartridge design.<sup>1</sup>

Prior to analysis, the CMS cartridge is purged with 2 or 3 L (0.07 to 0.1 ft<sup>3</sup>) of pure dry air to remove any moisture. The cartridge is then heated to 350° to 400°C (660° to 750°F) under a helium purge, and the desorbed methyl chloroform is collected in a specially designed cryogenic trap. The collected methyl chloroform is then flash evaporated onto a capillary column (SE-30) and quantified using a GC/MS system.

The exact run time, flow rate and volume sampled varies from source to source depending on the expected concentration and the required detection limit. Typically, Method TO-2 is used when ambient air concentrations are expected to be high. CMS has the ability to adsorb large quantities of organics before breakthrough occurs. Figure 7-1 is representative of both Methods TO-1 and TO-2 sampling systems. Figure 7-3 illustrates a CMS trap.

### 7.3 EPA METHOD TO-14<sup>1</sup>

Ambient air concentrations of methyl chloroform can also be measured using EPA Method TO-14 from the *Compendium of Methods for the Determination of Toxic Organic Compounds in Ambient Air*. This method is based on collection of a whole air sample in SUMMA<sup>®</sup> passivated stainless steel canisters and is used to determine semi-volatile and volatile organic compounds. The compounds are separated by gas chromatography and measured by mass-selective detector or multidetector techniques such as FID, electron capture detection (ECD), and photoionization detection (PID). The recommended column for Method TO-14 is an HP OV-1 capillary with 0.32mm I.D. x 0.88 µm cross-linked methyl silicone coating or equivalent. Samples should be analyzed within 14 days of collection.

This method is applicable to specific semi-volatiles and volatile organic compounds that have been tested and determined to be stable when stored in pressurized and subatmospheric pressure canisters. Methyl chloroform can be successfully measured at the parts per billion by volume (ppbv) level using this method. Figure 7-4 presents a diagram of the canister sampling system.



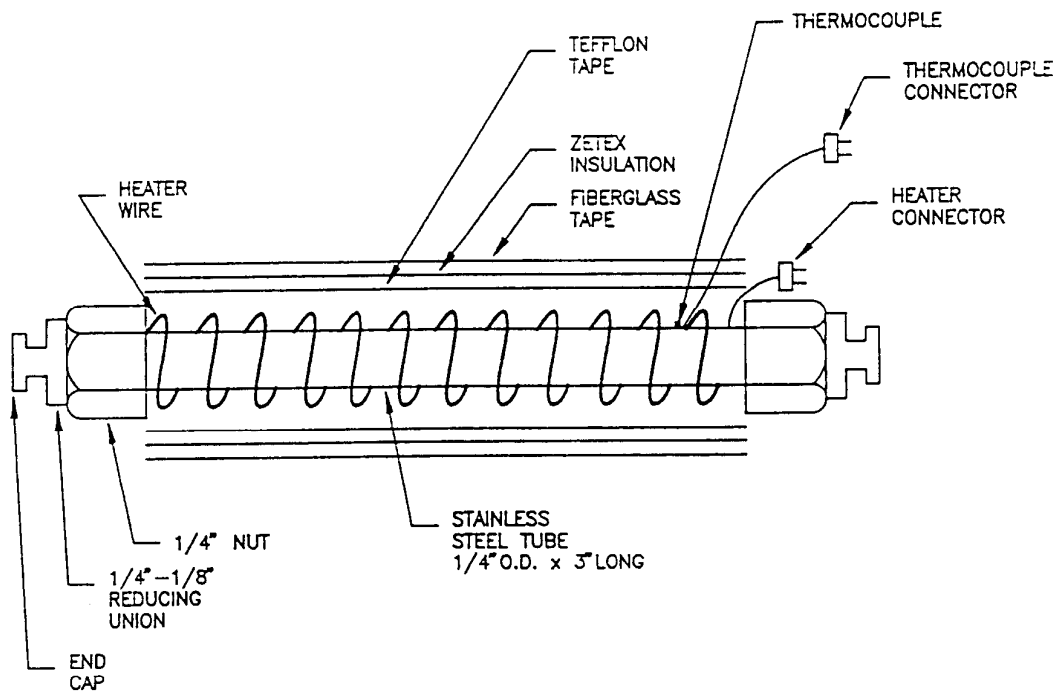

Figure 7-3. Carbon molecular sieve trap (CMS) construction.<sup>1</sup>

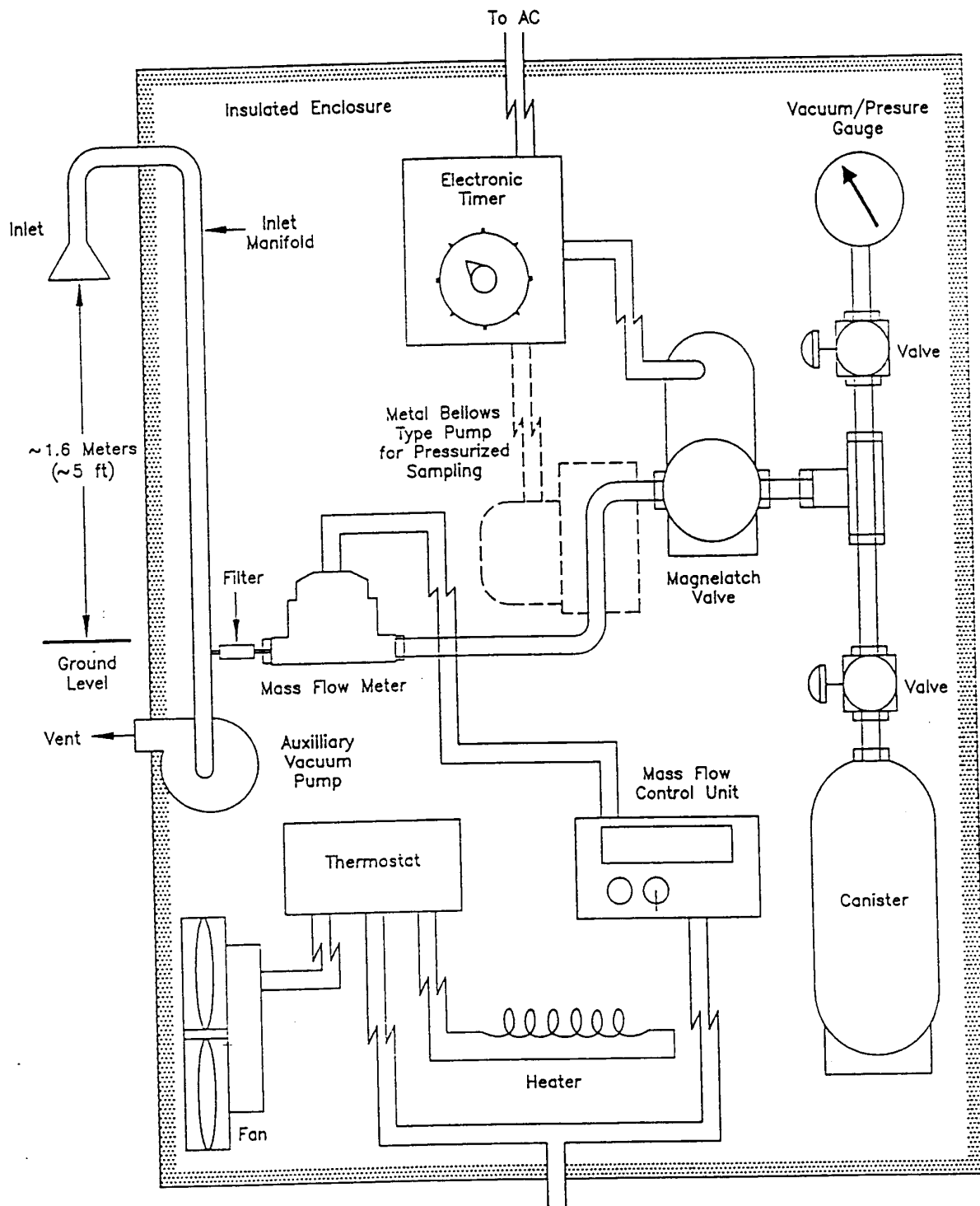

Figure 7-4. Canister sampling system.<sup>1</sup>

#### 7.4 EPA METHOD 0030<sup>2</sup>

The volatile organic sampling train (VOST) from SW-846, (third edition) is designed for the collection of volatile organic compounds from the stack gas effluents of hazardous waste incinerators. The VOST method was designed to collect volatile organics with boiling points in the range of 30° to 100°C (86° to 212°F). Many compounds with boiling points above 100°C (212°F) may also be effectively collected using this method. Methyl chloroform concentrations can be measured using this method. Figure 7-5 presents a schematic of the principle components of the VOST.

In most cases, 20 L (0.7 ft<sup>3</sup>) of effluent stack gas are sampled at an approximate flow rate of 1 L/minute (0.04 ft<sup>3</sup>/min) using a glass-lined heated probe. The gas stream is cooled to 20°C (68°F) by passage through a water-cooled condenser and the volatile organics are collected on a pair of sorbent resin traps. Liquid condensate is collected in the impinger located between the two resin traps. The first resin trap contains about 1.6 g (0.06 ounce) Tenax<sup>®</sup> and the second trap contains about 1 g (0.04 ounce) each of Tenax<sup>®</sup> and petroleum-based charcoal.

The Tenax<sup>®</sup> cartridges are then thermally desorbed and analyzed by purge-and-trap GC/MS along with the condensate catch as specified in EPA Method 5040. Analysis should be conducted within 14 days of sample collection.

#### 7.5 EPA METHOD 5040<sup>2</sup>

The contents of the sorbent cartridges (collected via VOST, EPA Method 0030) are spiked with an internal standard and thermally desorbed for 10 minutes at 80°C (176°F) with organic-free nitrogen or helium gas (at a flow rate of 40 mL/min (2.4 in<sup>3</sup>)), bubbled through 5 mL (0.3 in<sup>3</sup>) of organic-free water, and trapped on an analytical adsorbent trap. After the 10 minute desorption, the analytical adsorbent trap is rapidly heated to 180°C (356°), with the carrier gas flow reversed so that the effluent flow from the analytical trap is directed into the GC/MS. The volatile compounds are separated by temperature-programmed gas chromatography and detected

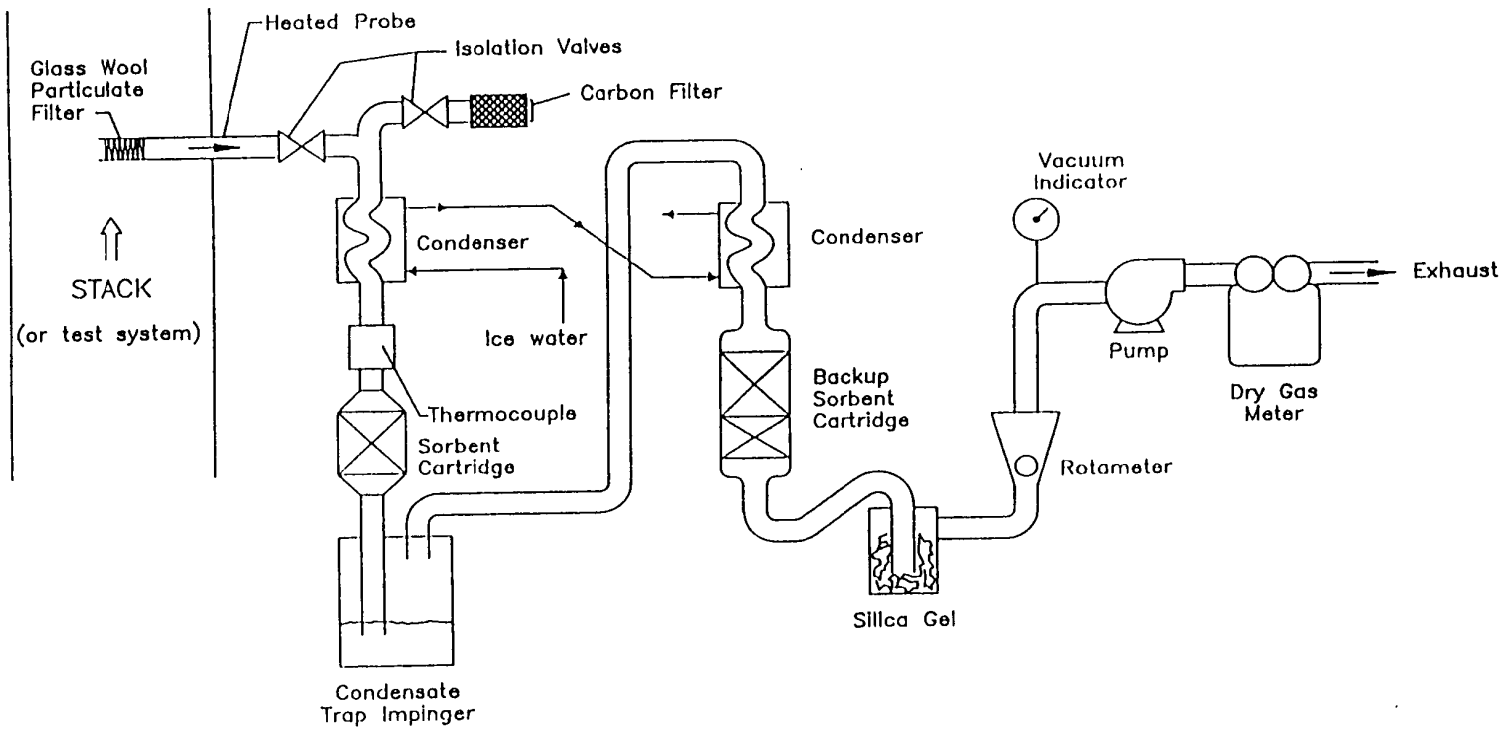

Figure 7-5. Schematic of volatile organic sampling train (VOST).<sup>2</sup>

by low resolution mass spectrometry. The concentrations of the volatile compounds are calculated using the internal standard technique.

EPA Methods 5030 and 8240 may be referenced for specific requirements for the thermal desorption unit, purge-and-trap unit, and GC/MS system. A diagram of the analytical system is presented in Figure 7-6. The Tenax<sup>®</sup> cartridges should be analyzed within 14 days of collection. The desired detection limit of this method is 0.1 ng/L (20 ng per Tenax<sup>®</sup> cartridge).

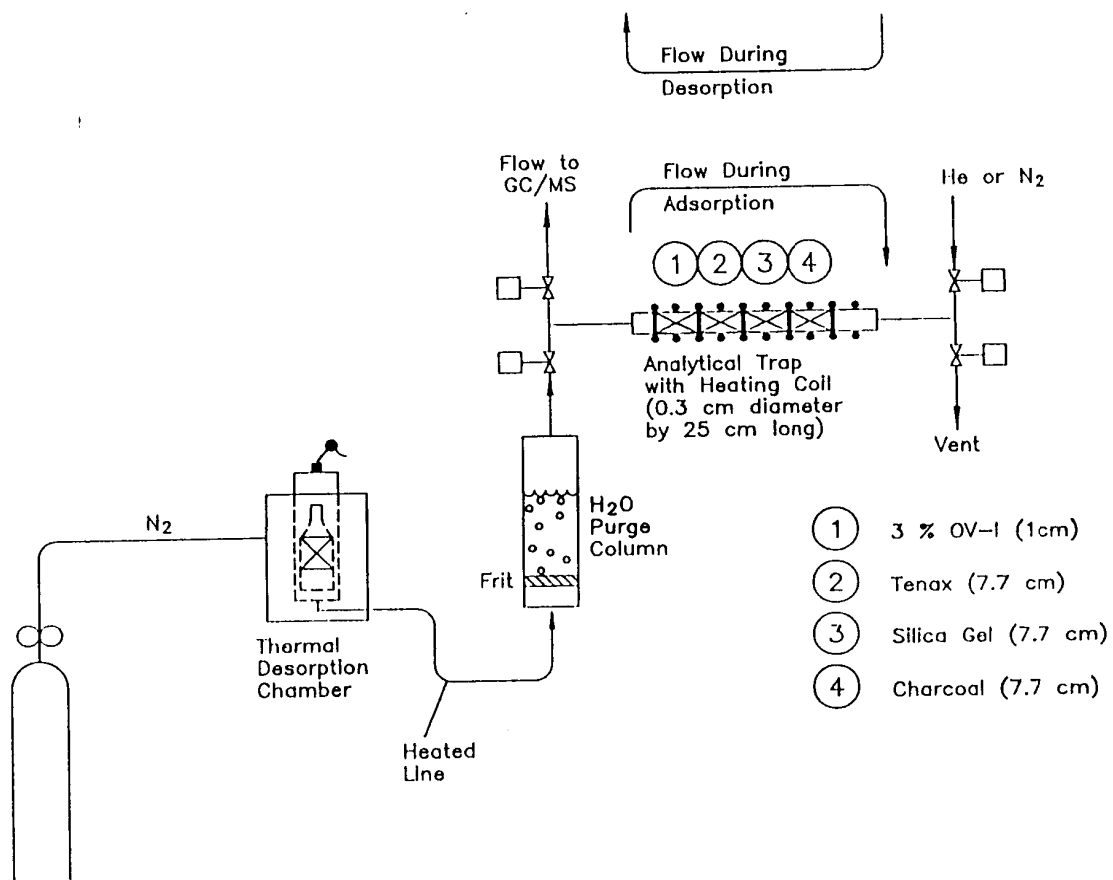

Figure 7-6. Schematic diagram of trap desorption/analysis system.<sup>2</sup>

7.6 REFERENCES FOR SECTION 7.0

1. U.S. Environmental Protection Agency, *Compendium of Methods for the Determination of Toxic Organic Compounds in Ambient Air*. EPA/600/4-89/017. Atmospheric Research and Exposure Assessment Laboratory, Research Triangle Park, NC. June 1988.
2. U.S. Environmental Protection Agency. *Test Methods for Evaluating Solid Waste*, Third Edition, Report No. SW-846. Office of Solid Waste and Emergency Response. Washington, DC. November 1986.

APPENDIX A

POTENTIAL SOURCE CATEGORIES OF METHYL CHLOROFORM EMISSIONS



**TABLE A-1.**  
**POTENTIAL SOURCE CATEGORIES OF**  
**METHYL CHLOROFORM EMISSIONS (continued)**

SIC Code	Source Description
1311	Crude Petroleum and Natural Gas
1321	Natural Gas Liquids
1382	Oil and Gas Exploration
1400	Nonmetallic Minerals, Except Fuels
1475	Phosphate Rock
1499	Miscellaneous Nonmetallic Minerals
2044	Rice Milling
2082	Malt Beverages
2221	Broadwoven fabric mills, manmade
2231	Broadwoven fabric mills, wool
2261	Finishing plants, cotton
2262	Finishing plants, manmade
2281	Yarn spinning mills
2426	Hardwood dimension and flooring mills
2431	Millwork
2434	Wood kitchen cabinets
2435	Hardwood veneer and plywood
2491	Wood Preserving
2493	Reconstituted wood products
2512	Upholstered household furniture
2515	Mattresses and bedsprings
2517	Wood TV and radio cabinets
2519	Household furniture, nec
2531	Public building and related furniture

(continued)

**TABLE A-1.**  
**POTENTIAL SOURCE CATEGORIES OF**  
**METHYL CHLOROFORM EMISSIONS (continued)**

<b>SIC Code</b>	<b>Source Description</b>
2541	Wood partitions and fixtures
2591	Drapery hardware and blinds and shades
2599	Furniture and fixtures, nec
2611	Pulp mills
2653	Corrugated and solid fiber boxes
2655	Fiber cans, drums and similar products
2672	Paper coated and laminated, nec
2674	Bags: uncoated paper and multiwall
2721	Periodicals
2732	Book printing
2752	Commercial printing, lithographic
2754	Commercial printing, gravure
2761	Manifold business forms
2782	Blankbooks and looseleaf binders
2789	Bookbinding and related work
2796	Platemaking services
2800	Chemicals and Allied Products
2812	Alkalies and Chlorine
2813	Industrial gases
2816	Inorganic Pigments
2819	Industrial Organic Chemicals, nec
2821	Plastics materials and resins
2822	Synthetic rubber

(continued)

**TABLE A-1.**  
**POTENTIAL SOURCE CATEGORIES OF**  
**METHYL CHLOROFORM EMISSIONS (continued)**

<b>SIC Code</b>	<b>Source Description</b>
2823	Cellulosic manmade fibers
2824	Organic fibers, noncellulosic
2834	Pharmaceutical preparations
2841	Soap and other detergents
2842	Polishes and sanitation goods
2843	Surface active agents
2844	Toilet preparations
2851	Paints and allied products
2861	Gum and Wood Chemicals
2865	Cyclic crudes and intermediates
2869	Industrial Organic Chemicals, nec
2873	Nitrogenous Fertilizers
2874	Phosphatic Fertilizers
2879	Agricultural chemicals, nec
2892	Explosives
2893	Printing Ink
2899	Chemical preparations, nec
2911	Petroleum Refining
3011	Tires and inner tubes
3052	Rubber and plastics hose and belting
3053	Gaskets, packing and sealing devices
3061	Mechanical rubber goods
3080	Misc. Plastics Products, nec

(continued)

**TABLE A-1.**  
**POTENTIAL SOURCE CATEGORIES OF**  
**METHYL CHLOROFORM EMISSIONS (continued)**

SIC Code	Source Description
3081	Unsupported plastics film and sheet
3082	Unsupported plastics profile shapes
3086	Plastics foam products
3087	Custom compound purchased resins
3089	Plastics products, nec
3211	Flat glass
3229	Pressed and blown glass, nec
3231	Products of purchased glass
3241	Cement, hydraulic
3251	Brick and Structural Clay Tile
3253	Ceramic wall and floor tile
3255	Clay Refractories
3264	Porcelain electrical supplies
3272	Concrete products, nec
3274	Lime
3275	Gypsum Products
3292	Asbestos products
3295	Minerals, ground or treated
3296	Mineral Wool
3299	Nonmetallic mineral products, nec
3312	Blast furnaces and steel mills
3313	Electrometallurgical products
3315	Steel wire and related products

(continued)

**TABLE A-1.**  
**POTENTIAL SOURCE CATEGORIES OF**  
**METHYL CHLOROFORM EMISSIONS (continued)**

SIC Code	Source Description
3317	Steel pipe and tubes
3321	Gray and Ductile Iron Foundries
3325	Steel foundries, nec
3334	Primary Aluminum
3339	Primary Nonferrous Metals, nec
3341	Secondary Nonferrous Metals
3351	Copper rolling and drawing
3353	Aluminum sheet, plate, and foil
3354	Aluminum extruded products
3355	Aluminum rolling and drawing, nec
3363	Aluminum die-castings
3364	Nonferrous die-casting exc. aluminum
3366	Copper foundries
3399	Primary metal products, nec
3411	Metal cans
3412	Metal barrels, drums, and pails
3423	Hand and edge tools, nec
3425	Saw blades and handsaws
3429	Hardware, nec
3431	Metal Sanitary Ware
3433	Heating equipment, except electric
3441	Fabricated structural metal
3443	Fabricated plate work (boiler shops)

(continued)

**TABLE A-1.**  
**POTENTIAL SOURCE CATEGORIES OF**  
**METHYL CHLOROFORM EMISSIONS (continued)**

SIC Code	Source Description
3444	Sheet metalwork
3446	Architectural metal work
3448	Prefabricated metal buildings
3449	Miscellaneous metal work
3451	Screw machine products
3462	Iron and steel forgings
3463	Nonferrous forgings
3465	Automotive stampings
3466	Crowns and closures
3471	Plating and polishing
3482	Small arms ammunition
3483	Ammunition, exc. for small arms, nec
3489	Ordnance and accessories, nec
3491	Industrial valves
3493	Steel springs, except wire
3494	Valves and pipe fittings, nec
3495	Wire springs
3496	Misc. fabricated wire products
3497	Metal foil and leaf
3498	Fabricated pipe and fittings
3511	Turbines and turbine generator sets
3519	Internal combustion engines, nec
3523	Farm machinery and equipment

(continued)

**TABLE A-1.**  
**POTENTIAL SOURCE CATEGORIES OF**  
**METHYL CHLOROFORM EMISSIONS (continued)**

SIC Code	Source Description
3524	Lawn and garden equipment
3531	Construction machinery
3532	Mining machinery
3533	Oil and gas field machinery
3534	Elevators and moving stairways
3535	Conveyors and conveying equipment
3536	Hoists, cranes, and monorails
3537	Industrial trucks and tractors
3541	Machine tools, metal cutting types
3542	Machine tools, metal forming types
3545	Machine tool accessories
3546	Power-driven handtools
3548	Welding apparatus
3549	Metalworking machinery, nec
3553	Woodworking machinery
3554	Paper industries machinery
3555	Printing trades machinery
3556	Food products machinery
3559	Special industry machinery, nec
3561	Pumps and pumping equipment
3563	Air and gas compressors
3564	Blowers and fans
3565	Packaging machinery

(continued)

**TABLE A-1.**  
**POTENTIAL SOURCE CATEGORIES OF**  
**METHYL CHLOROFORM EMISSIONS (continued)**

SIC Code	Source Description
3566	Speed changers, drives, and gears
3569	General industrial machinery, nec
3571	Electronic computers
3572	Computer storage devices
3579	Office machines, nec
3581	Automatic vending machines
3582	Commercial laundry equipment
3589	Service industry machinery, nec
3596	Scales and balances, exc. laboratory
3599	Industrial machinery, nec
3613	Switchgear and switchboard apparatus
3624	Carbon and Graphite Products
3625	Relays and industrial controls
3629	Electrical industrial apparatus, nec
3631	Household cooking equipment
3632	Household refrigerators and freezers
3633	Household laundry equipment
3634	Electric housewares and fans
3635	Household vacuum cleaners
3639	Household appliances, nec
3641	Electric lamps
3643	Current-carrying wiring devices
3644	Noncurrent-carrying wiring devices

(continued)



**TABLE A-1.**  
**POTENTIAL SOURCE CATEGORIES OF**  
**METHYL CHLOROFORM EMISSIONS (continued)**

SIC Code	Source Description
3645	Residential lighting fixtures
3646	Commercial lighting fixtures
3647	Vehicular lighting equipment
3648	Lighting equipment, nec
3651	Household audio and video equipment
3661	Telephone and telegraph apparatus
3669	Communications equipment, nec
3672	Printed circuit boards
3675	Electronic capacitors
3676	Electronic resistors
3677	Electronic coils and transformers
3678	Electronic connectors
3679	Electronic components, nec
3691	Storage batteries
3694	Engine electrical equipment
3695	Magnetic and optical recording media
3699	Electrical equipment and supplies, nec
3711	Motor vehicles and car bodies
3715	Truck trailers
3716	Motor homes
3724	Aircraft engines and engine parts
3728	Aircraft parts and equipment, nec
3731	Ship building and repairing

(continued)

**TABLE A-1.**  
**POTENTIAL SOURCE CATEGORIES OF**  
**METHYL CHLOROFORM EMISSIONS (continued)**

SIC Code	Source Description
3732	Boat building and repairing
3743	Railroad equipment
3751	Motorcycles, bicycles, and parts
3761	Guided missiles and space vehicles
3764	Space propulsion units and parts
3769	Space vehicle equipment, nec
3792	Travel trailers and campers
3795	Tanks and tank components
3799	Transportation equipment, nec
3812	Search and navigation equipment
3821	Laboratory apparatus and furniture
3823	Process control instruments
3824	Fluid meters and counting devices
3825	Instruments to measure electricity
3826	Analytical instruments
3827	Optical instruments and lenses
3829	Measuring and controlling devices, nec
3841	Surgical and medical instruments
3842	Surgical appliances and supplies
3861	Photographic equipment and supplies
3873	Watches, clocks, watchcases and parts
3900	Miscellaneous Manufacturing Industries
3914	Silverware and plated ware

(continued)

**TABLE A-1.**  
**POTENTIAL SOURCE CATEGORIES OF**  
**METHYL CHLOROFORM EMISSIONS (continued)**

SIC Code	Source Description
3931	Musical instruments
3944	Games, toys, and children's vehicles
3949	Sporting and athletic goods, nec
3951	Pens and mechanical pencils
3952	Lead pencils and art goods
3953	Marking devices
3961	Costume jewelry
3993	Signs and advertising specialties
3995	Burial caskets
3996	Hard surface floor coverings, nec
4111	Local and suburban transit
4226	Special warehousing and storage, nec
4491	Marine Cargo Handling
4499	Water transportation services, nec
4512	Air transportation, scheduled
4581	Airports, flying fields, and services
4741	Rental of railroad cars
4789	Transportation services, nec
4911	Electric Services
4925	Gas production and/or distribution
4939	Combination utilities, nec
4952	Sewerage Systems
4953	Refuse systems

(continued)

**TABLE A-1.**  
**POTENTIAL SOURCE CATEGORIES OF**  
**METHYL CHLOROFORM EMISSIONS (continued)**

SIC Code	Source Description
5021	Furniture
5032	Brick, stone, and related materials
5085	Industrial Supplies
5113	Industrial and personal service paper
5153	Grain and field beans
5169	Chemicals and allied products, nec
5171	Petroleum bulk stations and terminals
5172	Petroleum products, nec
5191	Farm supplies
5198	Paints, varnishes, and supplies
5231	Paint, glass, and wallpaper stores
5541	Gasoline service stations
5712	Furniture stores
6512	Nonresidential building operators
7532	Top and body repair and paint shops
7538	General automotive repair shops
7629	Electrical repair shops, nec
7641	Reupholstery and furniture repair
7694	Armature rewinding shops
7699	Repair services, nec
8211	Elementary and secondary schools
8221	Colleges and universities
8299	Schools and educational services, nec

(continued)

**TABLE A-1.  
POTENTIAL SOURCE CATEGORIES OF  
METHYL CHLOROFORM EMISSIONS (continued)**

SIC Code	Source Description
8331	Job training and related services
9199	General government, nec
9224	Fire Protection
9511	Air, water, and solid waste management
9711	National security
9999	Nonclassifiable establishments

NEC = not elsewhere classified

Source:

Toxic Chemical Release Inventory (TRI), 1987-1990. On-line access through the databases. National Library of Medicine, Bethesda, MD.

*Crosswalk/Air Toxic Emission Factor Database Management System, Version 1.2.* U.S. Environmental Protection Agency, Research Triangle Park, NC. October 1991.

*Volatile Organic Compound (VOC) Particulate Matter (PM) Speciation Database Management System, Version 1.4.* Research Triangle Park, NC. October 1991.

**APPENDIX B**

**LISTS OF PAINT, INK, AND PRINTING FACILITIES WITH ANNUAL SALES  
GREATER THAN \$1 MILLION**

**TABLE B-1.**  
**PAINT AND ALLIED PRODUCTS FACILITIES (SIC 2851) WITH**  
**ANNUAL SALES GREATER THAN \$1 MILLION (continued)**

Name	Address	Sales in \$ Millions
Aervoe-Pacific Co. Inc.	PO Box 485, Gardnerville NV 89410	11
AExcel Corp.	7373 Production Dr, Mentor OH 44060	20
Agri-Blend Inc.	PO Box 957, Rowlett TX 75088	1*
Akron Paint & Varnish Inc.	1390 Firestone Parkway, Akron OH 44301	4*
Akzo Coatings Inc. Reliance Universal Inc.	1930 Bishop Ln, Louisville KY 40218	300
Akzo Coatings Inc. Akzo Resins & Vehicles	21625 Oak St, Matteson IL 60443	13
Akzo Coatings Inc.	1600 Watterson Towers, Louisville KY 40218	550*
Allentown Paint Manufacturing Co.	PO Box 597, Allentown PA 18105	4
Also Indus Inc. Morton Paint Co.	Box 6208, Canton OH 44706	3
Ameritone Paint Corp.	PO Box 190, Long Beach CA 90801	40
Ameron Inc. Enmar Finishes Div.	PO Box 9610, Little Rock AR 72219	15
Ameron Inc. Ameron Protective Coatings Div.	201 N Berry St, Brea CA 92621	112
Amsterdam Color Works Inc.	1546 Stillwell Ave, Bronx NY 10461	7
Aspen Paints	1128 SW Spokane St, Seattle WA 98134	4
Atlas Coating Corp.	820 E 140th St, Bronx NY 10454	7*
Automotive Finishes Inc.	6430 Wyoming Ave, Dearborn MI 48126	4
Baker Sealants & Coating	234 Suydam Ave, Jersey City NJ 07304	5
Barrett Varnish Co.	1532 S 50th Ct, Cicero IL 60650	3
Bee Chem Co.	2700 E 170th St, Lansing IL 60438	66
Behr Process Corp.	PO Box 1287, Santa Ana CA 92702	33*
Benjamin Moore & Co.	51 Chestnut Ridge Rd., Montvale NJ 07645	370*
Bennette Paint Manufacturing Co.	PO Box 9088, Hampton VA 23670	5
Best Bros Paint Manufacturing Co.	PO Box 2056, Sinking Spr PA 19608	1
Beverly Manufacturing Co. (Los Angeles)	9118 S Main St, Los Angeles CA 90003	2
Birk Paint Manufacturing Inc.	230 Kearny Ave, Jersey City NJ 07305	2
Blue Ridge Talc Co. Inc.	PO Box 39, Henry VA 24102	9
Brewer Chem Corp.	PO Box 48, Honolulu HI 96810	50
Brod-Dugan Co.	2145 Schuetz Rd, St. Louis MO 63146	15
Bruning Paint Co.	601 S Haven, Baltimore, MD 21224	30
Burkes Paint Co. Inc.	727 S 27th St, Washougal WA 98671	3
Buten Paint & Wallpaper	5000 Ridge Ave, Philadelphia PA 19128	40
Cabot Stains	100 Hale St, Newburyport MA 01950	30
Cal Western Paint Corp.	11748 Slauson Ave, Santa Fe Spr CA 90670	5
Calbar Inc.	2626 N Martha St, Philadelphia PA 19125	4
California Products Corp.	PO Box 569, Cambridge MA 02139	32
Carbit Paint Co.	927 W Blackhawk St, Chicago IL 60622	5

(continued)

**TABLE B-1.  
PAINT AND ALLIED PRODUCTS FACILITIES (SIC 2851) WITH  
ANNUAL SALES GREATER THAN \$1 MILLION (continued)**

Name	Address	Sales in \$ Millions
Carboline Co.	350 Hanley Indus Ct, St. Louis MO 63144	65
Cardinal Color Co.	50-56 1st St, Paterson NJ 07524	7
Cardinal Indus Finish Inc.	1329 Potrero Ave, South El Mon CA 91733	18
Century Chem Co.	5 Lawrence St, Bloomfield NJ 07003	5
Certified Coating Products	2414 S Connor Ave, Los Angeles CA 90040	1
CF Jameson & Co. Inc.	PO Box 197, Bradford MA 01835	1
Charles A Crosbie Labs Inc.	PO Box 3497, Van Nuys CA 91407	1
Chemical Technology Labs Inc.	12150 S Alameda St, Lynwood CA 90262	3
Chemical Coating Corp.	7300 Crider Ave, Pico Rivera CA 90660	3
Ciba-Geigy Corp. Drakenfeld Colors	PO Box 519, Washington PA 15301	28
Clement Coverall Inc.	PO Box 557, Camden NJ 08101	4
CM Athey Paint Co.	1809 Bayard St, Baltimore MD 21230	6
Coatings & Chems Corp.	3067 N Elston Ave, Chicago IL 60618	5
Colonial Refining & Chem Co.	20575 Ctr Ridge Rd, Cleveland OH 44116	3
Columbia Paint Corp.	PO Box 2888, Huntington WV 25728	5
Columbia Paint Co.	PO Box 4569, Spokane WA 99202	17
Colwell Gen Inc.	PO Box 329, Fort Wayne IN 46801	20
Commercial Chem Co. Inc.	PO Box 2126, Santa Ana CA 92707	4
Con-Lux Coatings Inc.	PO Box 847, Edison NJ 08818	25
Cook & Dunn Paint Corp. Pure All Paint Coatings Co.	700 Gotham Ave, Carlstadt NJ 07072	8*
Cook & Dunn Paint Corp.	700 Gotham Parkway, Carlstadt NJ 07072	20
Cook & Dunn Paint Corp. Adelphi Coating	700 Gotham Parkway, Carlstadt NJ 07072	3
Cook Paint & Varnish Co.	PO Box 419389, Kansas City MO 64141	100
Coronado Paint Co. Inc.	PO Box 308, Edgewater FL 32032	28
Cosan Chem Corp.	400 14th St, Carlstadt NJ 07072	10*
Cotter & Co. Gen Paint & Chem Co.	201 Jandus Rd., Cary IL 60013	120
Courtlaulds Coatings USA Inc.	PO Box 1439, Louisville, KY 40201	160*
Cowman & Campbell	PO Box 70328, Seattle WA 98107	3
CP Inc.	PO Box 333, Connerville IN 47331	5
Crest Chem Indus Ltd.	PO Box 85, New Lenox IL 60451	1*
Crosby Coatings Inc.	PO Box 1038, Chico CA 95927	6
CWC Indus Inc.	2686 Lisbon Rd, Cleveland OH 44104	5
Dalys Inc.	3525 Stone Way N, Seattle WA 98103	5
Dampney Co. Inc.	85 Paris St, Everett MA 02149	4

(continued)



**TABLE B-1.  
PAINT AND ALLIED PRODUCTS FACILITIES (SIC 2851) WITH  
ANNUAL SALES GREATER THAN \$1 MILLION (continued)**

Name	Address	Sales in \$ Millions
Daniel Products Co.	400 Claremont Ave, Jersey City NJ 07304	20
Davis Paint Co.	1311 Iron St, Kansas City MO 64116	13
Davlin Paint Co. Inc.	700 Allston Way, Berkely CA 94702	3*
DC Franche & Co.	1401 W Wabansia Ave, Chicago IL 60622	3
De Boom Paint Co.	645 Texas St, San Francisco CA 94107	5
Dean & Barry Co.	296 Marconi Blvd, Columbus OH 43215	15
Decratrend Paints	251 Mason Way, City of Indu CA 91746	17
Deft Inc.	17451 Von Karman Ave, Irvine CA 92714	15
Del Paint Corp.	3105 E Reno St, Oklahoma City OK 73117	4
Delrac Manufacturers of Bisonite Products Co. Inc.	PO Box 764, Tonawanda NY 14151	3*
DeSoto Inc.	PO Box 5030, Des Plaines IL 60017	408
Devoe & Reynolds Co.	PO Box 7600, Louisville KY 40207	120*
Dexter Corp. Dexter Specialty Coatings Div.	1 E Water St, Waukegan IL 60085	80
Diamond Products Co. Inc.	709 S 3rd Ave, Marshalltown IA 50158	18*
DJ Simpson Co.	PO Box 2265, South San Francisco CA 94080	5
Dover Sales Co. Inc.	PO Box 2479, Berkeley CA 94702	3*
Duncan Enterprises	PO Box 7827, Fresno CA 93747	30
Dunn Edwards Corp.	PO Box 30389, Los Angeles CA 90039	150*
Dupli-Color Products Co.	1601 Nicholas Blvd, Elk Grove Vi IL 60007	50
Duralac Inc.	84 Lister Ave. Newark NJ 07105	4
Duron Inc.	10406 Tucker St, Beltsville MD 20705	150
Dye Specialties Inc.	PO Box 1447, Secaucus NJ 07096	8
Egyptian Lacquer Manufacturing	PO Box 4449, Lafayette IN 47903	10
Ellis & Everard (US Holdings) Inc. Prillaman Chem Corp.	PO Box 4024, Martinsville VA 24112	96*
Elpaco Coatings Corp.	PO Box 447, Elkhart IN 46515	8
Emco Finishing Products Inc.	470 Cresent St, Jamestown NY 14701	2
Empire State Varnish Co.	38 Varick St, Brooklyn NY 11222	5
Environmental Coatings Inc.	6450 Hanna Lake SE, Caledonia MI 49316	5
Epoca Co.	5 Lawrence St, Bloomfield NJ 07003	1
Epoxy Coatings Co.	PO Box 1035, Union City CA 94587	1
Evans Paint Inc.	PO Box 4098, Roanoke VA 24015	4*
Everseal Manufacturing Co. Inc.	475 Broad Ave, Ridgefield NJ 07657	12
Fabrionics Inc.	Route 130 S, Camargo IL 61919	13

(continued)

**TABLE B-1.  
PAINT AND ALLIED PRODUCTS FACILITIES (SIC 2851) WITH  
ANNUAL SALES GREATER THAN \$1 MILLION (continued)**

Name	Address	Sales in \$ Millions
Farboil Co.	8200 Fischer Rd, Baltimore MD 21222	11
Farwest Paint Manufacturing Co. Inc.	PO Box 68726, Tukwila WA 98168	3
Federated Paint Manufacturing Co.	1882 S Normal St, Chicago IL 60616	8*
Ferro Corp. Coatings Div.	PO Box 6550, Cleveland OH 44101	73*
Fiber-Resin Corp.	PO Box 4187, Burbank CA 91503	10
Fine Line Paint Corp.	12234 Los Nietos Rd, Santa Fe Spr CA 90670	5
Finishes Unlimited Inc.	PO Box 69, Sugar Grove IL 60554	3
Finnaren & Haley Inc.	2320 Haverford Rd, Ardmore PA 19003	25*
Flecto Co. Inc.	PO Box 12955, Oakland CA 94608	20
Frank W Dunne Co.	1007 41st St, Oakland CA 94608	7
Frazee Indus Inc.	PO Box 2471, San Diego CA 92112	100
Fredericks-Hansen Paint	PO Box 5638, San Bernardino CA 92408	12
Fuller O'Brien Corp.	450 E Grand Ave, South San Francisco CA 94080	140
Gilbert Spruance Co.	Richmond St & Tioga St, Philadelphia PA 19134	10
Given Paint Manufacturing Co. Inc.	111 N Piedras St, El Paso TX 79905	7*
GJ Nikolas & Co. Inc.	2810 Washington Blvd, Bellwood IL 60104	2
Glidden Co. Eastern Region	PO Box 15049, Reading PA 19612	140
Glidden Co. Southwest Region	PO Box 566, Carrollton TX 75011	59
Glidden Co. Resin Div.	1065 Glidden St NW, Atlanta GA 30318	30
Gloss-Flo Corp.	135 Jackson St, Brooklyn NY 11211	4
Glyptal Inc.	305 Eastern Ave, Chelsea MA 02150	5
Gordon Bartels Co.	2600 Harrison Ave, Rockford IL 61108	7
Graham Paint & Varnish Co.	4800 S Richmond St, Chicago IL 60632	10*
Grow Group Inc. US Paint Div.	831 S 21st St, St. Louis MO 63103	30*
Grow Group Inc. Natl Aerosol Products Co.	2193 E 14th St, Los Angeles CA 90021	5
Grow Group Inc.	200 Park Ave, New York NY 10166	413
Guardsman Products Inc.	3033 Orchard Vista Dr, Grand Rapids MI 49501	190
Guardsman Chems Inc.	13535 Monster Rd, Seattle WA 98178	6
H Behlen & Brother Inc.	Route 30 N Perth Rd, Amsterdam NY 12010	10
Hancock Paint & Varnish	109 Accord Dr, Norwell MA 02061	10
Hanna Chem Coatings Inc.	PO Box 147, Columbus OH 43216	25
Harco Chem Coatings Inc.	208 DuPont St, Brooklyn NY 11222	6
Harrison Paint Corp.	PO Box 8470, Canton OH 44711	20
Hartin Paint & Filler	PO Box 116, Carlstadt NJ 07072	3
Hempel Coatings USA	201 Route 17 N, Rutherford NJ 07070	15

(continued)

**TABLE B-1.  
PAINT AND ALLIED PRODUCTS FACILITIES (SIC 2851) WITH  
ANNUAL SALES GREATER THAN \$1 MILLION (continued)**

Name	Address	Sales in \$ Millions
Hentzen Coatings Inc.	6937 W Mill Rd, Milwaukee WI 53218	12
Heresite Protective Coatings Inc.	PO Box 250, Manitowoc WI 54221	15
Hoboken Paint Co. Inc.	40 Indus Rd, Lodi NJ 07644	17
Hoffers Inc.	PO Box 777, Wausau WI 54401	47
Hy-Klas Paints Inc.	1401 S 12th St, Louisville KY 40210	6
Hydrosol Inc.	8407 S 77th Ave, Bridgeview IL 60455	30
ICI Americas Inc. ICI Paints	925 Euclid Ave, Cleveland OH 44115	843
Illinois Bronze Paint Co.	300 E Main St, Lake Zurich IL 60047	25
Indurall Coatings Inc.	PO Box 2371, Birmingham AL 35201	8
Industrial Coatings Intl.	7030 Quad Ave, Baltimore MD 21237	14*
Insilco Corp. Sinclair Paint Co.	6100 S Garfield Ave, Los Angeles CA 90040	100*
International Paint Co. USA Inc.	6001 Antoine, Houston TX 77091	50
International Paint Co. USA Inc. Southwest Div.	PO Box 920762, Houston TX 77292	18
International Coatings Co.	13929 E 166th St, Cerritos CA 90701	5
Irathane Syss Inc.	PO Box 276, Hibbing MN 55746	8*
IVC Indus Coatings Inc.	PO Box 18163, Indianapolis IN 46218	9
J Landau & Co. Inc.	PO Box 135, Carlstadt NJ 07072	4
James B Day & Co.	Day Ln, Carpentersville IL 60110	8
James Bute Co.	PO Box 1819, Houston TX 77251	3*
Jasco Chem Corp.	PO Drawer J, Mountain View CA 94040	7
John L Armitage & Co.	1259 Route 46 E, Parsippany NJ 07054	8*
Johnson Paints Inc.	PO Box 061319, Fort Myers FL 33906	9
Jones Blair Co. Gilman Paint & Wallcovering Div.	PO Box 1257, Chattanooga TN 37401	38
Kalcor Coatings Co.	37721 Stevens, Willoughby OH 44094	6
Kaufman Products Inc.	1326 N Bentalov St, Baltimore MD 21216	1*
Keeler & Long Inc.	PO Box 460, Watertown CT 06795	10
Kelly-Moore Paint Co. Inc. Hurst Div.	301 W Hurst Blvd, Hurst TX 76053	15
Kelly-Moore Paint Co.	987 Commercial St, San Carlos CA 94070	230*
King Fiber Glass Corp. Fiber Resin Supply Div.	366 W Nickerson St, Seattle WA 98119	2
Komac Paint Inc.	1201 Osage St, Denver CO 80204	10
Kop-Coat Co. Inc.	480 Frelinghuysen Ave, Newark NJ 07114	15
Kop-Coat Co. Inc. Pettit Paint Co.	36 Pine St, Rockaway NJ 07866	11
Kurfees Coatings Inc.	201 E Market St, Louisville KY 40202	16

(continued)

**TABLE B-1.  
PAINT AND ALLIED PRODUCTS FACILITIES (SIC 2851) WITH  
ANNUAL SALES GREATER THAN \$1 MILLION (continued)**

Name	Address	Sales in \$ Millions
Kwal-Howells Inc.	PO Box 39-R, Denver CO 80239	23
L & H Paint Products Inc.	PO Box 7311, San Francisco CA 94120	4
Lasting Paints Inc.	PO Box 4428, Baltimore MD 21223	6
Lenmar Inc.	150 S Calverton Rd, Baltimore MD 21223	13
Lilly Chem Products Inc.	PO Box 188, Templeton MA 01468	11
Lilly Industrial Coatings Inc.	733 S West St, Indianapolis, IN 46225	212
Lily Co. Inc.	PO Box 2358, High Point NC 27261	30
Linear Dynamics Inc.	400 Lanidex Plz, Parsippany NJ 07054	30
Lyle Van Patten Co. Inc.	321 W 135th St, Los Angeles CA 90061	3
MA Bruder & Sons Inc.	PO Box 600, Broomall PA 19008	140*
Maas & Waldstein Co.	2121 McCarter Highway, Newark NJ 07104	15
MAB Paints Inc.	630 N 3rd St, Terre Haute IN 47808	32
Magruder Color Co. Inc. Radiant Color Div.	PO Box 4019, Richmond CA 94804	30
Major Paint Co.	4300 W 190th St, Torrance CA 90509	65
Mansfield Paint Co. Inc.	169 W Longview Ave, Mansfield OH 44905	2
Martec Inc.	760 Aloha St, Seattle WA 98109	3
Martin-Senour Co.	101 Prospect Ave, Cleveland OH 44115	44*
Mautz Paint Co.	PO Box 7068, Madison WI 53707	19
McCormick Paint Works Co.	2355 Lewis Ave, Rockville, MD 20851	18*
McWhorter-McCloskey Inc.	5501 E Slauson Ave, Los Angeles CA 90040	5
Mercury Paint Co. Inc.	14300 Schaefer Highway, Detroit MI 48227	18
Mid-States Paint Co.	9315 Watson Indus Park, St. Louis MO 63126	3
Midwest Lacquer Manufacturing Co.	9353 Seymour Ave, Schiller Par IL 60176	5
Midwest Paint Manufacturing Co.	2313 W River Rd N, Minneapolis MN 55411	2
Millmaster Onyx Group Inc. Mantrose-Haeuser Co.	500 Post Rd E, Westport CT 06880	15
Mobile Paint Manufacturing Co.	4775 Hamilton Blvd, Theodore AL 36582	45
Mohawk Finishing Products	Route 30 N, Amsterdam NY 12010	35*
Moline Paint Manufacturing Co.	5400 23rd Ave, Moline IL 61265	17
Moling Paint Manufacturing	5400 23rd Ave, Moline IL 61265	125
Monarch Paint Co.	PO Box 55604, Houston TX 77255	29*
Morton Intl Inc. Norris Paint/TMT	PO Box 2023, Salem OR 97308	5
Muralo Co. Inc.	PO Box 455, Bayonne NJ 07002	42
Muralo Co. Inc. Olympic Paint & Chem Co.	5928 S Garfield Ave, Los Angeles CA 90040	2*
N Siperstein Inc.	415 Montgomery St, Jersey City NJ 07302	40

(continued)

**TABLE B-1.  
PAINT AND ALLIED PRODUCTS FACILITIES (SIC 2851) WITH  
ANNUAL SALES GREATER THAN \$1 MILLION (continued)**

Name	Address	Sales in \$ Millions
National Paint Co. Inc.	3441 E 14th St, Los Angeles CA 90023	3
National Lacquer & Paint Co.	7415 S Green St, Chicago IL 60621	2
Nelson Tech Coatings Inc.	2147 N Tyler Ave, South El Mon CA 91733	2
New York Bronze Powder Co. Inc.	519 Dowd Ave, Elizabeth NJ 07201	30
Niles Chem Paint Co.	PO Box 307, Niles MI 49120	16*
Norton & Son Inc.	148 E 5th St, Bayonne NJ 07002	15*
Nu-Brite Chem Co. Inc. Kyanize Paints	2nd & Boston St, Everett MA 02149	20
O'Brien Corp.	450 E Grand Ave, South San Francisco CA 94080	150*
O'Brien Corp. Powder Coatings Div.	5300 Sunrise Rd, Houston TX 77021	40
O'Brien Corp. Southeast Region	PO Box 864, Brunswick GA 31521	11*
Old Quaker Paint Co.	2209 S Main St, Santa Ana CA 92707	31
Orelite Chem Coatings	62 Woolsey St, Irvington NJ 07111	4
Pacific Coast Lacquer Co. Inc.	3150 E Pico Blvd, Los Angeles CA 90023	3
Palmer Paint Products Inc.	PO Box 1058, Troy MI 48099	7
Pan Chem Corp.	1 Washington Ave, Hawthorne NJ 07506	5
Paragon Paint & Varnish Corp.	5-49 46th Ave, Long Island NY 11101	14*
Parker Paint Manufacturing Co.	PO Box 11047, Tacoma WA 98411	26
Parks Corp.	PO Box 5, Somerset MA 02726	20
Parks Paint & Varnish Co. Inc.	660 Tonnelle Ave, Jersey City NJ 07307	3*
Passonno Paints	500 Broadway, Watervliet NY 12189	10
Pave-Mark Corp.	PO Box 94108, Atlanta GA 30318	20
PavePrep Corp.	141 Central Ave, Westfield NJ 07090	14*
Penn Color Inc.	400 Old Dublin Pike, Doylestown PA 18901	40
Pentagon Chem & Paint Co.	24 Woodward Ave, Ridgewood NY 11385	16*
Perfection Paint & Color Co.	715 E Maryland St, Indianapolis IN 46202	6*
Performance Coatings Inc.	PO Box 1569, Ukiah CA 95482	3
Perry & Derrick Co.	2510 Highland Ave, Cincinnati OH 45212	15
Pervo Paint Co.	6624 Stanford Ave, Los Angeles CA 90001	13
PFI Incorporated-Paints for Industry	921 Santa Fe Springs Rd, Santa Fe Spr CA 90670	2
Pierce & Stevens Corp.	710 Ohio St, Buffalo NY 14203	50
Plasti-Kote Co. Inc.	PO Box 708, Medina OH 44258	50
Plasticolors Inc.	2600 Michigan Ave, Ashtabula OH 44004	17
Plectone Corp. of America	2141 McCarter Highway, Newark NJ 07104	3
PMC Inc. Gen Plastics Div.	55-T La France Ave, Bloomfield NJ 07003	4
Ponderosa Paint Manufacturing Co. Inc.	PO Box 5466, Boise ID 83705	10

(continued)

**TABLE B-1.  
PAINT AND ALLIED PRODUCTS FACILITIES (SIC 2851) WITH  
ANNUAL SALES GREATER THAN \$1 MILLION (continued)**

Name	Address	Sales in \$ Millions
Porter Paint Co.	PO Box 1439, Louisville KY 40201	121
Potter Paint Co. Inc.	PO Box 265, Cambridge Ci IN 47327	2*
PPG Indus Architectual Finishes Inc.	2233 112th Ave NE, Bellevue WA 98004	110*
PPG Indus Inc. Automotive Products Group	PO Box 3510, Troy MI 48007	20*
Pratt & Lambert Inc.	75 Tonawanda St, Buffalo NY 14207	246
Pratt & Lambert Inc. Western Div.	PO Box 668, Marysville CA 95901	10
Premier Coatings Inc.	2250 Arthur Ave, Elk Grove Vi IL 60007	20
Preservative Paint Co. Inc.	5410 Airport Way S, Seattle WA 98108	13
Pro-Line Paint Manufacturing Co. Inc.	2646 Main St, San Diego CA 92113	7*
Proctor Paint & Varnish	38 Wells Ave, Yonkers NY 10701	20
Progress Paint Manufacturing Co.	PO Box 33188, Louisville KY 40232	10
Pruett-Schaffer Chem Co.	PO Box 4350, Pittsburgh PA 15204	4
Pyrolac Corp.	55 Schoon Ave, Hawthorne NJ 07506	4*
Quality Coatings Inc.	1700 N State, Chandler IN 47610	2
Raffi & Swanson Inc.	100 Eames St, Wilmington MA 01887	15
Randolph Products Co.	Park Place E, Carlstadt NJ 07072	9
Red Spot Paint Varnish Co. Red Spot Westland Inc.	550 S Edwin St, Westland MI 48185	15
Red Spot Paint Varnish Co.	PO Box 418, Evansville IN 47703	56
Reliable Coatings Inc.	13108 Euless St, Euless TX 76040	14*
Republic Clear Thru Corp.	211 63rd St, Brooklyn NY 11220	6
Republic Powdered Metals Inc.	PO Box 777, Median OH 44258	15
Riley Bros Inc.	860 Washington Ave, Burlington IA 52601	3
River Valley Coatings Inc.	PO Box 580, Aurora IL 60507	2*
Riverside Labs Inc.	411 Union St, Geneva IL 60134	3*
RJ McGlennon Co. Inc.	198 Utah St, San Francisco CA 94103	3
Roymal Inc.	Route 103, Newport NH 03773	4
RPM Inc.	PO Box 777, Medina OH 44258	380
Rudd Co. Inc.	1630 15th Ave W, Seattle WA 98119	10
Rust-Oleum Corp.	11 Hawthorne Parkway, Vernon Hills IL 60061	89
Rutland Fire Clay Co.	PO Box 340, Rutland VT 05702	2
Sampson Paint Manufacturing Co.	1900 Ellen Rd, Richmond VA 23224	42
Sampson Coatings Inc.	PO Box 6625, Richmond VA 23230	9
Sandstrom Products Co.	218 S High, Port Byron IL 61275	7
Saxon Paint & Home Care Centers Inc. Dreeblan Paint Co.	3729 W 49th St, Chicago IL 60632	15*

(continued)

**TABLE B-1.  
PAINT AND ALLIED PRODUCTS FACILITIES (SIC 2851) WITH  
ANNUAL SALES GREATER THAN \$1 MILLION (continued)**

Name	Address	Sales in \$ Millions
Schalk Chems Inc.	2400 Vauxhall Rd, Union NJ 07083	7
Scott Paint Corp.	5940 Palmer Blvd, Sarasota FL 34232	16*
Seagrave Coatings Corp. Clover Leaf Paint & Varnish	320 Paterson Plank Rd, Carlstadt NJ 07072	14*
Seaside Inc.	PO Box 2809, Long Beach CA 90801	3
Seibert-Oxidermo Inc.	6455 Strong Ave, Detroit MI 48211	11
SEM Products Inc.	120 Sem Ln, Belmont CA 94002	7
Sentry Paint Technologies Inc.	237 Mill St, Darby PA 19023	10
Seymour of Sycamore Inc.	917 Crosby Ave, Sycamore IL 60178	10
Sheboygan Paint Co.	PO Box 417, Sheboygan WI 53082	12
Sheffield Bronze Paint Corp.	17814 S. Waterloo Rd, Cleveland OH 44119	3
Sherwin-Williams Co.	101 Prospect Ave NW, Cleveland OH 44115	2,124
Sherwin-Williams Co. Automotive Div.	101 Prospect Ave NW, Cleveland OH 44115	160
Sherwin-Williams Co. Consumer Div.	101 Prospect Ave NW, Cleveland OH 44115	170*
Sherwin-Williams Co. Oakland	1450 Sherwin Ave, Oakland CA 94608	32*
Sherwin-Williams Co. Chem Coatings Div.	11541 S Champlain Ave, Chicago IL 60628	250
Sigma Coatings Co.	PO Box 816, Harvey LA 70059	15
Smiland Paint Co.	620 Lamar St, Los Angeles CA 90031	10
Snyder Bros Co.	PO Box 760, Toccoa GA 30577	7
Southern Coatings Inc.	PO Box 160, Sumter SC 29151	40
Southwestern Petroleum Corp.	PO Box 961005, Fort Worth TX 76161	26
Spatz Paints Inc.	1439 Hanley Industrial Ct, St. Louis MO 63144	5
Specialty Coating & Chem	7360 Varna Ave, North Hollywood CA 91605	3
Spectra-Tone Paint Corp.	9635 Klingerman St, South El Mon CA 91733	7
Spraylat Corp. Los Angeles	3465 S La Cienega, Los Angeles CA 90016	5
Stanchem Inc.	401 Berlin St, East Berlin CT 06023	10
Standard Detroit Paint Co.	8225 Lyndon Ave, Detroit MI 48238	8
Standard T Chem Co. Inc.	290 E Joe Orr Rd, Chicago Heights IL 60411	14*
Star Finishing Products Inc.	360 Shore Dr, Hinsdale IL 60521	15
Star Bronze Co.	PO Box 2206, Alliance OH 44601	11
STD Coating Corp.	461 Broad Ave, Ridgefield NJ 07657	3
Steelcote Manufacturing Corp.	3418 Gratiot St, St. Louis MO 63103	4
Sterling Twelve Star Paint	PO Box 791, Little Rock AR 72203	15
Sterling-Clark-Lurton	184 Commercial St, Malden MA 02148	9
Stevens Paint Corp.	38 Wells Ave, Yonkers NY 10701	15
Stonhard Inc.	PO Box 308, Maple Shade NJ 08052	62

(continued)

**TABLE B-1.  
PAINT AND ALLIED PRODUCTS FACILITIES (SIC 2851) WITH  
ANNUAL SALES GREATER THAN \$1 MILLION (continued)**

Name	Address	Sales in \$ Millions
Strathmore Products Inc.	1970 W Fayette St, Syracuse NY 13204	6
Sullivan Coatings Inc.	410 N Hart St, Chicago IL 60622	2*
Sunnyside Corp	225 Carpenter Ave, Wheeling IL 60090	14
Superior Varnish & Drier Co.	PO Box 1310, Merchantville NJ 08109	7*
Superior Sealants Inc.	1135 Sylvan SW, Atlanta GA 30310	11*
Supro Corp.	2650 Pomona Blvd, Pomona CA 91768	4
Technical Coatings Laboratory Inc.	PO Box 565, Avon CT 06001	6
Technical Coatings Inc.	PO Box 3337, Austin TX 78764	8
Technical Coatings Co.	1000 Walsh Ave, Santa Clara CA 95050	6
Tenax Finishing Products	390 Adams St, Newark NJ 07114	6*
Tera Lite Inc.	1631 S 10th St, San Jose Ca 95112	3
Testor Corp.	620 Buckbee St, Rockford IL 61106	43*
Thompson & Formby Inc.	825 Crossover Ln, Memphis TN 38117	44*
Ti-Kromatic Paints Inc.	2492 Doswell Ave, St. Paul MN 55108	3
Tnemec Co. Inc.	PO Box 411749, Kansas City MO 64141	50
Touraine Paints Inc.	1760 Revere Beach Parkway, Everett MA 02149	17
Tower Paint Manufacturing	620 W 27th St, Hialeah FL 33010	10
Trail Chem Corp.	9904 Gidley St, El Monte CA 91731	4
Triangle Coatings Inc.	1930 Fairway Dr, San Leandro CA 94577	5
United Paint & Chem Corp.	24671 Telegraph Rd, Southfield MI 48034	11*
United Coatings Inc.	2850 Festival Dr, Kankakee IL 60901	65
United Paint Co.	404 E Mallory, Memphis TN 38109	25
United Gilsonite Labs	PO Box 70, Scranton PA 18501	22*
Universal Paint Corp.	PO Box 1218, La Puente CA 91749	20
Universal Chems & Coatings Inc.	1975 Fox Ln, Elgin IL 60123	10
Universe Paint Co.	PO Box 668, Marysville CA 95901	3*
Valspar Corp. MCI Quality Coatings	6110 Gunn Highway, Tampa FL 33625	12
Valspar Corp. Colony Paints Div.	PO Box 418037, Kansas City MO 64141	15
Valspar Corp.	1101 S 3rd St, Minneapolis MN 55415	527
Valspar Corp. Masury Paint Co.	1401 Severn St, Baltimore MD 21230	8
Vanex Color Inc.	1700 Shawnee St, Mount Vernon IL 62864	4
VJ Dolan & Co. Inc.	1830 N Laramie Ave, Chicago IL 60639	5
Vogel Paint & Wax Inc. Marwin Paints Inc.	2100 N 2nd St, Minneapolis MN 55411	8*
Vogel Paint & Wax Inc.	Industrial Air Park Rd., Orange City IA 51041	100
Voplex Corp. Allerton Chem Div.	763 Linden Ave, Rochester NY 14625	1

(continued)



**TABLE B-1.**  
**PAINT AND ALLIED PRODUCTS FACILITIES (SIC 2851) WITH**  
**ANNUAL SALES GREATER THAN \$1 MILLION (continued)**

Name	Address	Sales in \$ Millions
Waterlox Chem & Coatings Corp.	9808 Meech Ave, Cleveland OH 44105	4
Watson-Standard Co. Jordan Paint Manufacturing Co.	7250 Franklin St, Forest Park IL 60130	4
Watson-Standard Co.	PO Box 11250, Pittsburgh PA 15238	29*
Wattyl Group Precision Paint Group	5275 Peachtree, Atlanta GA 30341	15
WC Richards Co. Inc.	3555 W 123rd St, Blue Island IL 60406	15*
Welco Manufacturing Co. Inc.	1225 Ozark St, North Kansas MO 64116	10
Wellborn Paint Manufacturing Co.	215 Rossmoor Rd SW, Albuquerque NM 87102	15
Western Automotive Finishes	1450 Ave R, Grand Prairi TX 75050	17*
Westfield Coatings Corp.	PO Box 815, Westfield MA 01086	7
Westinghouse Elec Corp. Insulating Materials Div.	Route 993, Manor PA 15665	15
Whittaker Corp. Whittaker Decatur Coatings	PO Box 2238, Decatur AL 35602	12*
William Zinsser & Co.	31 Belmont Dr, Somerset NJ 08873	16
Wiltech Corp.	PO Box 517, Longview WA 98632	2
Wisconsin Protective Coatings Corp.	PO Box 216, Green Bay WI 54305	10
WM Barr & Co. Inc.	PO Box 1879, Memphis TN 38113	95
Yenkin Majestic Paint Corp.	PO Box 369004, Columbus OH 43236	80
Zehrunge Corp	3273 Casitas Ave, Los Angeles CA 90039	2*
Zolatone Process Inc.	3411 E 15th St, Los Angeles CA 90023	6
ZPC Indus Coatings Inc.	120 E Minereal St, Milwaukee WI 53204	2
Zynolyte Products Co.	PO Box 6244, Carson CA 90749	25

\* Indicates an estimated financial figure.

Source: Gale Research, Inc. *Ward's Business Directory of U.S. Private and Public Companies-1991*, Volume 4. Detroit, MI. 1991.

**TABLE B-2.**  
**PRINTING INK MANUFACTURING FACILITIES (SIC 2893) WITH**  
**ANNUAL SALES GREATER THAN \$1 MILLION (continued)**

Name	Address	Sales in \$ Millions
Acme Printing Ink Co. Packaging Inc. Corp.	5001 S Mason Ave, Chicago IL 60638	100
Acme Printing Ink Co.	165 Bond St, Elk Grove Vi IL 60007	140*
AJ Daw Printing Ink Co.	3559 S Greenwood Ave, Los Angeles CA 90040	13
American Inks & Coatings Corp.	PO Box 803, Valley Forge PA 19482	15
Autoroll Machine Corp.	11 River St, Middleton MA 01949	12
BASF Corp. Coatings & Colorants Div.	1255 Broad St, Clifton NJ 07015	105*
Bomark Inc.	601 S 6th Ave, City of Indu CA 91746	3
Borden Inc. Coatings & Graphics Group	630 Glendale - Milford, Cincinnati OH 45215	17*
Braden Sutphin Ink Co.	3650 E 93rd St, Cleveland OH 44105	25
Celia Corp.	320 Union St, Sparta MI 49345	15
Central Ink & Chem	1100 N Harvester Rd, West Chicago IL 60185	9
Colonial Printing Ink Corp	180 E Union Ave, East Rutherford NJ 07073	17
Converters Ink Co.	1301 S Park Ave, Linden NJ 07036	16*
Croda Inks Corp.	7777 N Merrimac, Niles IL 60648	32*
Custom Chem Corp.	30 Paul Kohner Pl, Elmwood Park NJ 07407	40
Del Val Ink & Color Co. Inc.	1301 Taylors Ln, Riverton NJ 08077	5
Excello Color & Chem	1446 W Kinzie St, Chicago IL 60622	84*
Flint Ink Corp.	25111 Glendale Ave, Detroit MI 48234	235
Flint Ink Corp. Capitol Printing Ink	806 Channing Pl NE, Washington DC 20018	23
Flint Ink Corp.	1404 4th St, Berkeley CA 94710	30*
Gans Ink & Supply Co. Inc.	1441 Boyd St, Los Angeles CA 90033	18
Gotham Ink & Color Co. Inc.	5-19 47th Ave, Long Island NY 11101	4
Graphic Color Corp.	750 Arthur Ave, Elk Grove Vi IL 60007	18
Handschy Ink & Chems Inc.	120 25th Ave, Bellwood IL 60104	30
Ink Masters Inc.	2842 S 17th Ave, Broadview IL 60153	3
James River Corp. of Virginia CZ Inks Div.	4150 Carr Ln, St. Louis MO 63119	28
JM Huber Corp. Carbon Div.	9300 Needlepoint Rd, Baytown TX 77521	18*
Kerley Ink Engineers Inc.	2839 19th Ave, Broadview IL 60153	4*
Kohl & Madden Printing Ink Corp.	222 Bridge Plz Sq, Hackensack NJ 07601	45
Lakeland Laboratory Inc. Alfa Ink Div.	655 Washington Ave, Carlstadt NJ 07072	2*
Lakeland Laboratory Inc.	655 Washington Ave, Carlstadt NJ 07072	3
Lawter Intl Inc.	990 Skokie Blvd, Northbrook IL 60062	136
Merit Printing Inc. Co.	1451 S Lorena St, Los Angeles CA 90023	4*

(continued)

**TABLE B-2.**  
**PRINTING INK MANUFACTURING FACILITIES (SIC 2893) WITH**  
**ANNUAL SALES GREATER THAN \$1 MILLION (continued)**

Name	Address	Sales in \$ Millions
Midland Color Co.	651 Bonnie Ln, Elk Grove Vi IL 60007	85
Miller-Cooper Co.	1601 Prospect Ave, Kansas City MO 64127	6
Morrison Printing Ink Co.	4801 W 160th St, Cleveland OH 44135	14*
Naz-Dar Co.	1087 N Northbranch St, Chicago IL 60622	15*
Nor-Cote Intl Inc.	PO Box 668, Crawfordsville IN 47933	5
North American Printing Ink	1524 David Rd, Elgin IL 60123	14
Northern Printing Ink Corp.	8360 10th Ave N, Minneapolis MN 55427	8
Polypore Inc.	4601 S 3rd Ave, Tucson AZ 85714	10
Polytex Color & Chem	820 E 140th St, Bronx NY 10454	3
PPG Indus Inc. PPG Ink Products Co.	1835 Airport Exchange Blvd, Covington KY 41018	15
Rexart Chem Corp.	1183 Westside Ave, Jersey City NJ 07306	6*
Ron Ink Co. Inc.	61 Halstead St, Rochester NY 14610	7
Sicpa Indus of America Inc.	8000 Research Way, Springfield VA 22153	25
Sinclair & Valentine LP	2520 Pilot Knob Rd, St. Paul MN 55120	186
Sun Chem Corp.	PO Box 1302, Fort Lee NJ 07024	1,100
Sun Chem Corp. Gen. Printing Ink Div.	135 W Lake St, Northlake IL 60164	410*
Superior Printing Ink Co. Inc.	70 Bethune St, New York NY 10014	50
United States Printing Ink Corp. Leber Ink Div.	PO Box 88700, Seattle WA 98138	6
United States Printing Ink Corp.	343 Murray Hill Pkwy, East Rutherford NJ 07073	65
Van Son Holland Corp. of America	92 Union St, Mineola NY 11501	42
Vivitone Inc.	110 E 27th St, Paterson NJ 07514	8
Walter W Lawrence	9715 Alpaca St, South El Mon CA 91733	1
Wikoff Color Corp.	PO Box W, Fort Mill SC 29715	45*

\*Indicates an estimated financial figure.

Source: Gale Research, Inc. *Ward's Business Directory of U.S. Private and Public Companies-1991*, Volume 4. Detroit, MI. 1991.

**TABLE B-3.**  
**PRINTING AND PUBLISHING FACILITIES (SIC 27) WITH**  
**ANNUAL SALES GREATER THAN \$1 MILLION (continued)**

Company	Location	Sales (millions)
<b>2711 Newspapers</b>		
Advance Publications Inc.	Staten Island, NY	2,200*
Affiliated Publications Inc.	Boston, MA	542
Chicago Tribune Co.	Chicago, IL	500
Cox Enterprises Inc.	Atlanta, GA	1,970
Dow Jones & Co. Inc.	Washington, DC	1,444
EW Scripps Co.	Wilmington, DE	1,266
Freedom Newspapers Inc.	Irvine, CA	500
Gannett Co. Inc.	Arlington, VA	3,518
Hearst Corp.	New York, NY	1,900*
Ingersoll Publications Co.	Princeton, NJ	1,010*
Knight-Ridder Inc.	Miami, FL	2,268
Media Gen Inc.	Richmond, VA	606
New York Times Co.	New York, NY	1,769
News America Publishing Inc.	New York, NY	3,000
Thomson Newspapers Corp.	Des Plaines, IL	550*
Times Mirro Co.	Los Angeles, CA	3,475
Tribune Co.	Chicago, IL	2,455
<b>2721 Periodicals</b>		
ABC Publishing	New York, NY	310*
Billboard Publications Inc.	New York, NY	100
BPI Communications Inc.	New York, NY	105
Cahners Publishing Co. New York Magazine Div.	New York, NY	102
Chilton Co.	Radnor, PA	150
CMP Publications Inc.	Manhasset, NY	187*
Conde Nast Publications Inc.	New York, NY	280*

(continued)

**TABLE B-3.**  
**PRINTING AND PUBLISHING FACILITIES (SIC 27) WITH**  
**ANNUAL SALES GREATER THAN \$1 MILLION (continued)**

Company	Location	Sales (millions)
Crain Communicating Inc.	Chicago, IL	145
Diamonds Communications Inc.	New York, NY	470*
Edgell Communications Inc.	Cleveland, OH	205
Forbes Inc.	New York, NY	200
International Data Group Inc.	Framingham, MA	500
Meredith Corp.	Des Moines, IA	792
Meredith Corp. Ladies' Home Journal	New York, NY	100
National Enquirer Inc.	Lantana, FL	180
National Geographic Soc.	Washington, DC	425
Newsweek Inc.	New York, NY	256
Official Airline Guides Inc.	Oak Brook, IL	130*
Penthouse Intl. Ltd.	New York, NY	160*
Penton Publishing Inc.	Cleveland, OH	151
Peterson Publishing Co.	Los Angeles, CA	140*
Playboy Enterprises Inc.	Chicago, IL	160
Reader's Digest Assn. Inc.	Pleasantville, NY	1,832
Reed Publishing (USA) Inc. Cahners Publishing Co.	Newton, MA	430
Reed Publishing (USA) Inc.	Newton, MA	600
Rodale Press Inc.	Emmaus, PA	150*
Scholastic Inc.	New York, NY	250*
Simon & Shuster Inc. Bur of Bus Practice	Waterford, CT	100*
Standard & Poor's Corp.	New York, NY	260*
Thompson Corp. Thompson Bus. Info.	Stamford, CT	160*
Time Inc. Magazine Co.	New York, NY	1,500*
Times Mirror Magazines Inc.	New York, NY	470*

(continued)

**TABLE B-3.**  
**PRINTING AND PUBLISHING FACILITIES (SIC 27) WITH**  
**ANNUAL SALES GREATER THAN \$1 MILLION (continued)**

Company	Location	Sales (millions)
Trader Publications Inc.	Clearwater, FL	270*
US News & World Report Inc.	New York, NY	140*
Warren Gorham & Lamont Inc.	New York, NY	130
Whittle Communications Inc.	Knoxville, TN	210*
Ziff Communications Co.	New York, NY	340*
Ziff Communications Co. Zif-Davis Publishing Co.	New York, NY	160*
<b>2731 Book Publishing</b>		
Addison-Wesley Publishing Co.	Reading, MA	120*
Bantam Doubleday Dell Publishing Group Inc.	New York, NY	180*
David C. Cook Publishing Co.	Elgin, IL	100
Encyclopedia Britannica Inc.	Chicago, IL	624
Field Publications	Middletown, CT	100*
Grolier Inc.	Danbury, CT	440*
Harcourt Brace Jovanovich Inc.	Orlando, FL	1,341
Harper Collins Publishers Inc.	New York, NY	450
Houghton Mifflin Co.	Boston, MA	370
Insilco Corp.	Midland, TX	450*
John Wiley & Sons Inc.	New York, NY	282
Lawyers Co-Operative Publishing Co. Inc.	Rochester, NY	150*
Macmillan Inc.	New York, NY	950*
Macmillan Inc. Info Svcs & Instruction	New York, NY	416
MacMillan Intl. Inc.	New York, NY	146*
Macmillan-McGraw-Hill School Publishing Co. School Div.	New York, NY	200

(continued)

**TABLE B-3.**  
**PRINTING AND PUBLISHING FACILITIES (SIC 27) WITH**  
**ANNUAL SALES GREATER THAN \$1 MILLION (continued)**

Company	Location	Sales (millions)
Macmillian-McGraw-Hill School Publishing Co.	Lake Forest, IL	390*
McGraw-Hill Inc. McGraw-Hill Intl Book Group	New York, NY	115
Mosby Year Book Inc.	St. Louis, MO	150
Prentice Hall Inc.	New York, NY	970*
Putnam Publishing Group, Inc.	New York, NY	100
Rand McNally & Co.	Skokie, IL	430*
Random House, Inc.	New York, NY	325
RR Donnelley & Sons Co. Willard Div.	Willard, OH	150
Simon & Schuster Inc.	New York, NY	1,320
South-Western Publishing Co.	Cincinnati, OH	112
Sunday School Bd of the Southern Baptist Convention	Nashville, TN	172
Time-Life Books Inc.	Alexandria, VA	350
West Publishing Co.	St. Paul, MN	450*
Western Publishing Group Inc.	Racine, WI	480
World Book Inc.	Chicago, IL	330*
Zondervan Corp.	Grand Rapids, MI	100*
<b>2732 Book Printing</b>		
Arcata Graphics Co. Arcata Graphics Book Group	Kingsport, TN	170*
Banta Corp.	Menasha, WI	568
Bertelsmann Printing & Mfg. Corp.	Berryville, VA	220*
Brown Printing Co. (Waseca Minnesota)	Waseca, MN	363
Great Lakes Color Printing Corp.	Brentwood, TN	210*
Harper & Row Publishers	New York, NY	450

(continued)

**TABLE B-3.  
PRINTING AND PUBLISHING FACILITIES (SIC 27) WITH  
ANNUAL SALES GREATER THAN \$1 MILLION (continued)**

Company	Location	Sales (millions)
Jostens Inc. Printing & Publishing Div.	Minneapolis, MN	121
RR Donnelley & Sons Co.	Chicago, IL	3,122
<b>2741 Misc Publishing</b>		
Commerce Clearing House Inc.	Riverwoods, IL	678
Donnelley Directory	New York, NY	1,300*
GTE Telephone Operations Inc. GTE Directories Corp.	Dallas-Fort, TX	360*
McGraw-Hill Info. Svcs. Co.	New York, NY	668
NYNEX Info Resources Co.	Middleton, MA	800
RL Polk & Co.	Detroit, MI	280
Simplicity Holdings, Inc.	New York, NY	110*
Simplicity Pattern Co.	New York, NY	101
Southwestern Bell Yellow Pages Inc.	St. Louis, MO	240*
Southwestern Bell Publications Inc.	St. Louis, MO	280*
U.S. West Direct (U.S. West Marketing Resources Group Inc.)	Aurora, CO	160*
Wonderland Music Co. Inc.	Burbank, CA	200*
<b>2752 Commercial Printing-Lithographic</b>		
American Signature Graphics Foote & Davies Div.	Atlanta, GA	195
American Bank Stationary Co.	Baltimore, MD	110*
Avery Intl Corp. Avery Label Co.	Azusa, CA	110*
Graphic Controls Corp.	Buffalo, NY	140
Graphisphere Corp.	Des Plaines, IL	110
HS Crocker Co. Inc.	South San Francisco, CA	140*
Judd's Inc.	Washington, DC	114
NMG Inc.	Los Angeles, CA	105

(continued)



**TABLE B-3.**  
**PRINTING AND PUBLISHING FACILITIES (SIC 27) WITH**  
**ANNUAL SALES GREATER THAN \$1 MILLION (continued)**

Company	Location	Sales (millions)
Perry Printing Corp.	Waterloo, WI	175
Quebecor Printing (USA) Inc.	St. Paul, MN	770
Queens Group Inc.	Long Island, NY	100
Ringler America Inc.	Itasca, IL	700
RR Donnelley & Sons Co. Mattoon Mfg. Div.	Mattoon, IL	110*
RR Donnelley & Sons Co. Lancaster Mfg. Div.	Lancaster, PA	190*
Shea Communications Co.	Louisville, KY	120
Taylor Corp.	Mankato, MN	540*
Treasure Chest Advertising Co. Inc.	Glendora, CA	550*
Valassis Inserts Inc.	Livonia, MI	400*
World Color Press Inc.	Effingham, IL	650
<b>2754 Commercial Printing-Gravure</b>		
All-State Legal Supply Co.	Cranford, NJ	43
Arcata Graphics Co.	Baltimore, MD	500*
Beck Co. (Langhorne Pennsylvania)	W, Langhorne, PA	10
Clark Printing Co. Inc.	North Kansas, MO	14*
ColorArt Inc.	St. Louis, MO	30
Dennison Mfg. Co. IPC Dennison Co.	Rogersville, TN	60
Dinagraphics Inc.	Cincinnati, OH	20
Golden Belt Mfg. Co.	Durham, NC	70
Graphic Ctr. Cos. Inc. Blake Printery	St. San Luis Obi, CA	11
International Label Co.	Clarksville, TN	30
JW Fergusson & Sons	Richmond, VA	34
Maxwell Communications Corp. Atglen	Atglen, PA	50*
McCleery-Cumming Co.	Washington, IA	22

(continued)

**TABLE B-3.**  
**PRINTING AND PUBLISHING FACILITIES (SIC 27) WITH**  
**ANNUAL SALES GREATER THAN \$1 MILLION (continued)**

Company	Location	Sales (millions)
Meredith-Burda Corp.	Des Moines, IA	500
Perry Printing Corp. Norway Div.	Norway, MI	25*
Printing House Inc. (Quincy Florida)	Quincy, FL	24
Ringier America Inc. Corinth Div.	Corinth, MS	80
Sheridan Press	Hanover, PA	15
Southern Gravure Svc. Inc.	Louisville, KY	58*
Stevens Graphics Inc.	Atlanta, GA	150
Technographic Inc. Decotone	Lexington, SC	30
World Color Press Inc. Salem Gravure Div.	Salem, IL	80
<b>2759 Commercial Printing Nec</b>		
Alden Press Inc.	Elk Grove Village, IL	170*
Avery Intl. Corp. Soabar Products Group	Philadelphia, PA	100*
Bowne & Co. Inc.	New York, NY	190
Curtis 1000 Inc.	Atlanta, GA	160*
Data Documents Inc. (Omaha)	Omaha, NE	200
Deluxe Corp.	St. Paul, MN	1,316
Duplex Products Inc.	Sycamore, IL	327
Graphic Indus. Inc.	Atlanta, GA	310
John H. Harland Co.	Atlanta, GA	345
Maxwell Commun Corp.	St. Paul, MN	720*
Meehan-Tooker Inc.	East Rutherford, NJ	110
Quad Graphics Inc.	Pewaukee, WI	380
RR Donnelley & Sons Co. Warsaw Mfg. Div.	Warsaw, IN	160*
Webcraft Technologies Inc.	North Brunswick, NJ	220*
Williamhouse-Regency Inc.	New York, NY	230

(continued)

**TABLE B-3.  
PRINTING AND PUBLISHING FACILITIES (SIC 27) WITH  
ANNUAL SALES GREATER THAN \$1 MILLION (continued)**

Company	Location	Sales (millions)
World Color Press Inc. Spartan Printing Co.	Sparta, IL	100*
<b>2761 Manifold Business Forms</b>		
Allied Paper Inc. Allied-Energy Syss Inc.	Dayton, OH	130*
American Bus Products Inc.	Atlanta, GA	387
Arnold Corp.	Dayton, OH	200
CST Group Inc.	Wheeling, IL	110
Ennis Bus. Forms Inc.	Ennis, TX	130
McGregor Printing Corp.	Washington, DC	125
Moore Corp. Ltd. Moore Bus. Forms & Syss. Div.	Glenview, IL	1,675
New England Bus. Svc. Inc.	Groton, MA	226
Office Electronic Inc.	Itasca, IL	105
Standard Register Co.	Dayton, OH	709
Uarco Inc.	Barrington, IL	520*
Vanier Graphics Corp. (American Bus. Products Inc.)	Santee, CA	133
Wallace Computer Svcs. Inc.	Hillside, IL	429
<b>2771 Greeting Cards</b>		
American Greetings Corp.	Cleveland, OH	1,309
American Greetings Corp. Seasonal Div.	Oscoola, AR	110
Current Inc. (Colorado Springs Colorado)	Colorado Springs, CO	160
Gibson Greetings Inc.	Cincinnati, OH	463
Hallmark Cards Inc.	Kansas City, MO	2,500
Hallmark Cards Inc. Topeka Products	Topeka, KS	120*

\* Indicates an estimated financial figure

Source: Gale Research, Inc. *Ward's Business Directory of U.S. Private and Public Companies-1991*, Volume 4. Detroit, MI. 1991.

**APPENDIX C**

**SUMMARY OF EMISSION FACTORS  
LISTED IN THIS DOCUMENT**

**TABLE C-1.  
SUMMARY OF METHYL CHLOROFORM EMISSION FACTORS**

<b>SIC</b>	<b>SIC Description</b>	<b>SCC</b>	<b>SCC Description</b>	<b>Emission Factor</b>	<b>Quality Rating<sup>a</sup></b>	<b>Reference</b>	<b>Note</b>
2869	Industrial Organic Compounds	301125	Chemical Manufacturing 1,1,1-Trichloroethane	1.2200 lb/ton methyl chloroform produced	U	4-13	Methyl chloroform handling Emissions from loading and unloading of tanks and tank cars
2869	Industrial Organic Compounds	30112528	Chemical Manufacturing 1,1,1-Trichloroethane Distillation Column Vent	0.720 kg/metric ton methyl chloroform produced	E	4-13	Uncontrolled
2869	Industrial Organic Compounds	30112528	Chemical Manufacturing 1,1,1-Trichloroethane Distillation Column Vent	0.003 kg/metric ton methyl chloroform produced	E	4-13	Controlled with incinerator
2869	Industrial Organic Compounds	30112525	Chemical Manufacturing	9.00 kg/metric ton methyl chloroform produced	E	4-13	Heat transfer unit/production by hydrochlorination
2869	Industrial Organic Compounds	30112525	Chemical Manufacturing	0.500 kg/metric ton methyl chloroform produced	E	4-13	Separation unit/production by hydrochlorination

<sup>a</sup>Unratable due to insufficient information.

**TABLE C-2.  
SUMMARY OF VOC EMISSION FACTORS\***

SIC	SIC Description	SCC	SCC Description	Emission Factor	Quality Rating <sup>a</sup>	Reference	Note
2869	Industrial Organic Chemicals	30112529	1,1,1-Trichloroethane Mfg. - Fugitives	0.104 kg/hr/source	U	4-15	Fugitives-Gas/vapor pressure relief seals
2869	Industrial Organic Chemicals	30112529	1,1,1-Trichloroethane Mfg. - Fugitives	0.00083 kg/hr/source	U	4-15	Fugitives-Flanges
2869	Industrial Organic Chemicals	30112529	1,1,1-Trichloroethane Mfg. - Fugitives	0.0017 kg/hr/source	U	4-15	Fugitives-Open ended lines
2869	Industrial Organic Chemicals	30112529	1,1,1-Trichloroethane Mfg. - Fugitives	0.015 kg/hr/source	U	4-15	Fugitives-Sampling connections
2869	Industrial Organic Chemicals	30112529	1,1,1-Trichloroethane Mfg. - Fugitives	0.0056 kg/hr/source	U	4-15	Fugitives-Gas valves
2869	Industrial Organic Chemicals	30112529	1,1,1-Trichloroethane Mfg. - Fugitives	0.0071 kg/hr/source	U	4-15	Fugitives-Light liquid valves
2869	Industrial Organic Chemicals	30112529	1,1,1-Trichloroethane Mfg. - Fugitives	0.00023 kg/hr/source	U	4-15	Fugitives-Heavy liquid valves
2869	Industrial Organic Chemicals	30112529	1,1,1-Trichloroethane Mfg. - Fugitives	0.0494 kg/hr/source	U	4-15	Fugitives-Light liquid pump seals
2869	Industrial Organic Chemicals	30112529	1,1,1-Trichloroethane Mfg. - Fugitives	0.0214 kg/hr/source	U	4-15	Fugitives-Heavy liquid pump seals
2869	Industrial Organic Chemicals	30112529	1,1,1-Trichloroethane Mfg. - Fugitives	0.228 kg/hr/source	U	4-15	Fugitives-Gas/vapor compressor seals

\*Note: To obtain methyl chloroform leak emission factor for each component, multiply VOC emission factor above by the fraction of methyl chloroform in the stream.

<sup>a</sup>Based on engineering judgement.

**TECHNICAL REPORT DATA**  
(Please read Instructions on the reverse before completing)

1. REPORT NO.	2.	3. RECIPIENT'S ACCESSION NO.
4. TITLE AND SUBTITLE Locating And Estimating Air Emissions From Sources Of Methyl Chloroform		5. REPORT DATE October 1993
		6. PERFORMING ORGANIZATION CODE
7. AUTHOR(S)		8. PERFORMING ORGANIZATION REPORT NO.
9. PERFORMING ORGANIZATION NAME AND ADDRESS TRC Environmental Corporation 100 Europa Drive, Suite 150 Chapel Hill, NC 27514		10. PROGRAM ELEMENT NO.
		11. CONTRACT/GRANT NO. 68-D9-0173
12. SPONSORING AGENCY NAME AND ADDRESS U. S. Environmental Protection Agency OAR, OAQPS, TSD, EIB, EFMS (MD-14) Research Triangle Park, NC 27711		13. TYPE OF REPORT AND PERIOD COVERED Final
		14. SPONSORING AGENCY CODE
15. SUPPLEMENTARY NOTES EPA Project Officer: Dennis Beauregard		
16. ABSTRACT To assist groups interested in inventorying air emissions of various potentially toxic substances, EPA is preparing a series of documents such as this to compile available information on sources and emission of these substances. This document deals specifically with Methyl Chloroform. Its intended audience includes federal, State and local air pollution personnel and others interested in locating potential emitters of Methyl Chloroform and in making gross estimates of air emissions therefrom.  This document presents information on(1) the types of sources that may emit Methyl Chloroform, (2) process variations and release points for these sources, and (3) available emissions information indicating the potential for Methyl Chloroform releases into the air from each operation.		
17. KEY WORDS AND DOCUMENT ANALYSIS		
a. DESCRIPTORS	b. IDENTIFIERS/OPEN ENDED TERMS	c. COSATI Field/Group
Methyl Chloroform Air Emissions Sources Locating Air Emissions Sources Toxic Substances Emission Estimation		
18. DISTRIBUTION STATEMENT  Unlimited	19. SECURITY CLASS (This Report) Unclassified	21. NO. OF PAGES 144
	20. SECURITY CLASS (This page) Unclassified	22. PRICE