



CDX CEDRI XML Reporting Instructions

Environmental Protection Agency
Office of Air and Radiation (OAR)

Version 2.1
December 15, 2015

Table of Contents

1	Introduction	7
1.1	Purpose of this Document	7
1.2	How to Upload XML Files in CEDRI.....	8
2	Data Elements.....	15
2.1	WebFIRE Report	15
2.2	Emission Point Information List.....	16
2.3	Emission Point Information	16
2.4	Emission Summary Information List.....	19
2.5	Emission Summary Information	19
2.6	Excess Emissions Information List.....	30
2.7	Excess Emissions Information	31
2.8	CMS Downtime Information List	34
2.9	CMS Downtime Information	34
2.10	Equipment Malfunction Information List	37
2.11	Equipment Malfunction Information.....	37
2.12	Deviation Information List	39
2.13	Deviation Information.....	39
2.14	CEMS Summary List	42
2.15	CEMS Summary.....	42
2.16	Fuel Use During Reporting Period List.....	43
2.17	Fuel Use During Reporting Period	43
2.18	Portland Cement Notifications	46
2.19	Temp Limits Info	47
2.20	Calibrate Thermocouples Info.....	48
2.21	Carbon Injection Info	49
2.22	Combustion System Info.....	49
2.23	Maintenance Plan Info	50
2.24	Information Certification Notification	51
2.25	Additional Information	54
2.26	Rice Reporting Period.....	57
2.27	Rice Engine Information List.....	57
2.28	Rice Engine Information	58
2.29	Rice Non-Emergency Summary	61

2.30	Rice Non-Emergency List	62
2.31	Rice Non-Emergency.....	62
2.32	Rice Voltage Deviation Summary	64
2.33	Rice Voltage Deviation List.....	65
2.34	Rice Voltage Deviation	65
2.35	Rice Emergency Use Summary.....	67
2.36	Rice Emergency Use List	67
2.37	Rice Emergency Use	68
2.38	Rice Deviation Summary	69
2.39	Rice Deviation List.....	70
2.40	Rice Deviation	70
3	Appendix A: Reports Currently Configured for XML Upload	73
4	Appendix B: Terms and Acronyms	74

List of Exhibits

Exhibit 1-1 CEDRI Help Tab.....	7
Exhibit 1-2 CEDRI Help Page	8
Exhibit 1-3 Creating a New Submission Package.....	9
Exhibit 1-4 Filling out Submission Package Data (1/3)	10
Exhibit 1-5 Filling out Submission Package Data (2/3)	10
Exhibit 1-6 Filling Out Submission Package Data (3/3)	10
Exhibit 1-7 Trigger File Upload Dialog.....	11
Exhibit 1-8 Reporting Utilities Templates and Schema	11
Exhibit 1-9 Choose a File to Upload	12
Exhibit 1-10 Uploading an XML File	12
Exhibit 1-11 Upload Successful Dialog Box.....	13
Exhibit 1-12 Validation Error Dialog Box.....	13
Exhibit 1-13 Create / Edit Report Link	14
Exhibit 1-14 Mark Form as Complete	14
Exhibit 2-1 WebFIRE Report XML Element.....	15
Exhibit 2-2 Emission Point Information List XML Element	16
Exhibit 2-3 Emission Point Information XML Element.....	17
Exhibit 2-4 Emission Summary Information List XML Element	19
Exhibit 2-5 Emission Summary Information XML Element (1/3)	20
Exhibit 2-6 Emission Summary Information XML Element (2/3)	27
Exhibit 2-7 Emission Summary Information XML Element (3/3)	30
Exhibit 2-8 Excess Emission Information List XML Element.....	30
Exhibit 2-9 Excess Emissions Information XML Element.....	31
Exhibit 2-10 CMS Downtime Information List XML Element	34
Exhibit 2-11 CMS Downtime Information XML Element.....	35
Exhibit 2-12 Equipment Malfunction Information List XML Element.....	37
Exhibit 2-13 Equipment Malfunction Information XML Element	38
Exhibit 2-14 Deviation Information List XML Element	39
Exhibit 2-15 Deviation Information XML Element	40
Exhibit 2-16 CEMS Summary List XML Element.....	42
Exhibit 2-17 CEMS Summary XML Element	42
Exhibit 2-18 Fuel Use During Reporting Period List XML Element	43
Exhibit 2-19 Fuel Use During Reporting Period XML Element.....	44
Exhibit 2-20 Portland Cement Notifications XML Element	46
Exhibit 2-21 Temp Limits Info XML Element.....	48
Exhibit 2-22 Calibrate Thermocouples Info XML Element	48

Exhibit 2-23 Carbon Injection Info XML Element	49
Exhibit 2-24 Combustion System Info XML Element	50
Exhibit 2-25 Maintenance Plan Info XML Element.....	50
Exhibit 2-26 Information Certification Notification XML Element	52
Exhibit 2-27 Additional Information XML Element.....	55
Exhibit 2-28 Rice Reporting Period XML Element	57
Exhibit 2-29 Rice Engine Information List XML Element.....	58
Exhibit 2-30 Rice Engine Information XML Element	59
Exhibit 2-31 Rice Non-Emergency Summary XML Element	61
Exhibit 2-32 Rice Non-Emergency List XML Element.....	62
Exhibit 2-33 Rice Non-Emergency XML Element	63
Exhibit 2-34 Rice Voltage Deviation Summary XML Element	64
Exhibit 2-35 Rice Voltage Deviation List XML Element.....	65
Exhibit 2-36 Rice Voltage Deviation XML Element	66
Exhibit 2-37 Rice Emergency Use Summary XML Element.....	67
Exhibit 2-38 Rice Emergency Use List XML Element	68
Exhibit 2-39 Rice Emergency Use XML Element.....	68
Exhibit 2-40 Rice Deviation Summary XML Element.....	69
Exhibit 2-41 Rice Deviation List XML Element	70
Exhibit 2-42 Rice Deviation XML Element	71

List of Tables

Table 2-1 Limit Unit Options.....	21
Table 2-2 Compliance Period Options.....	23
Table 2-3 Operating Time Units Auto-Populated Values	24
Table 2-4 Compliance Period Units Auto-Population Values	25
Table 2-5 Excess Emission Time Units Auto-Population Values	33

1 Introduction

The Compliance and Emissions Data Reporting Interface (CEDRI) is the electronic, web-based tool provided by the Environmental Protection Agency's (EPA's) Office of Air and Radiation (OAR) for the electronic submission of source test results, emissions monitoring data, compliance reports, and emissions reports to EPA. The CEDRI tool is available to users through EPA's Central Data Exchange (CDX), a web-based system used for various electronic environmental data submissions to EPA. Under EPA's "E-Reporting" rules, users wishing to submit compliance and emissions reports to EPA must register for access to the CEDRI program service through CDX. More information about CDX is available at <http://www.epa.gov/cdx/>.

1.1 Purpose of this Document

This document is designed to help users create software to automatically generate XML files that may be used to upload data in an Air Emission Report (AER) form generated by the CEDRI application. These XML files can then subsequently be uploaded into CEDRI where they will be validated against the XSD file for the particular Part – Subpart combination of the report. These XSD files can be found external to the CEDRI application at <http://epa.gov/ttn/chief/cedri/index.html>, or within the CEDRI application by clicking on the 'CEDRI Help' tab (see Exhibit 1-1).

Exhibit 1-1 CEDRI Help Tab

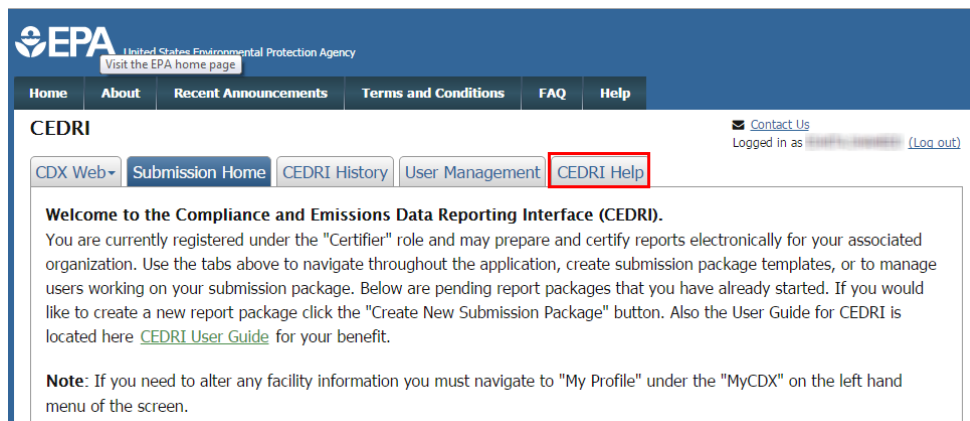

After navigating to the 'CEDRI Help' page, you can find the XML upload Schemas in the 'Reporting Utilities' section of the page (see Exhibit 1-2).

Exhibit 1-2 CEDRI Help Page

Compliance and Emissions Data Reporting Interface (CEDRI) User Guide

This guide describes each screen of the CEDRI application and provides information on how to use the system to submit compliance and emissions reports to comply with federal regulations defined in 40 CFR Part 60 and 63. This guide also contains instructions for registering with CDX as well as setting up organization profiles for their facilities. Click [here](#) to download and print the guide for quick reference.

Reporting Utilities

Use the dropdown below to select which parts/subparts you would like to download Excel upload templates and/or XML upload schemas for.

1 selected

Part / Subpart Name	Available Files
Part 60 Subpart Db	CMS Downtime Summary(.xlsx)(23KB)
	Excess Emissions Summary(.xlsx)(32KB)
	Malfunction Report(.xlsx)(22KB)
	XML Schema(.xsd)(12KB)

It is important to note that this document provides a comprehensive view of all of the elements for every AER form in CEDRI; not all of the elements presented in this document will be necessary for an XML file uploaded to CEDRI. In order to create valid and relevant XML files, it is advised that you use three tools: this document, the respective XSD file(s) for the report(s) of interest, and the actual form on the CEDRI website.

The information contained within an XML document that adheres to one of the CEDRI XSD files will map directly to the form fields in one of CEDRI's AER forms.

1.2 How to Upload XML Files in CEDRI

After generating a valid XML file using the constraints listed in this document, as well as the respective XSD file, you are ready to upload the file to CEDRI. The XML file must be contained within a .zip archive, along with any attachments the file references. Please note that even if your file does not contain any attachments, the lone XML file must be contained within a .zip archive for submission. The steps to uploading an XML file in CEDRI are enumerated below (these steps assume you've already registered for CDX, CEDRI, and have an active Preparer, Certifier, or Delegated Certifier role. If this is not the case, please follow Sections 3.2 – 3.10 in the CEDRI User Guide as necessary to complete your registration. The CEDRI User Guide can be found at <http://epa.gov/ttn/chief/cedri/index.html>):

- 1) Log into CDX.

- 2) Enter the CEDRI Application using a Preparer, Certifier, or Delegated Certifier role.
- 3) At the ‘Submission Home’ page, click the ‘Create New Submission Package’ button (see Exhibit 1-3).

Exhibit 1-3 Creating a New Submission Package

CEDRI [Contact Us](#)
Logged in as GHSUSHE ([Log out](#))

CDX Web- [Submission Home](#) [CEDRI History](#) [User Management](#) [CEDRI Help](#)

Welcome to the Compliance and Emissions Data Reporting Interface (CEDRI).
 You are currently registered under the "Preparer" Role and may prepare reports electronically for your associated facilities. You must have a certifier associated with any facilities before the report can be certified and submitted. Use the tabs above to navigate throughout the application, create submission package templates, or to manage users working on your submission package. Below are pending report packages that you have already started. If you would like to create a new report package click the "Create New Submission Package" button. Also the User Guide for CEDRI is located here [CEDRI User Guide](#) for your benefit.

Note: If you need to alter any facility information you must navigate to "My Profile" under the "MyCDX" on the left hand menu of the screen.

Pending Submissions				
<input type="checkbox"/>	Package Name	Date Created	Facility Name	Status
<input type="checkbox"/>	Test package	2015-12-04 08:52:04.942	CGI FEDERAL	In Progress
<input type="checkbox"/>	CEDRI Test Package	2015-12-03 16:51:29.085	CGI FEDERAL	In Progress
<input type="checkbox"/>	Test Package Notification	2015-12-03 15:06:30.243	CGI FEDERAL	In Progress
<input type="checkbox"/>	RE-SUBMISSION Notification Report (Optional)	2015-12-03 14:49:09.103	CGI FEDERAL	In Progress
<input type="checkbox"/>	Test Package	2015-12-03 14:07:25.942	CGI FEDERAL	Complete

Create New Submission Package
Remove Selected

- 4) Fill out the necessary information for the Submission Package:
 - a) Enter a value for the ‘Package Name’ field, click the ‘To Step 2’ button, select a Facility from the dropdown list, and click the ‘To Step 3’ button (see Exhibit 1-4).

Exhibit 1-4 Filling out Submission Package Data (1/3)

CEDRI Contact Us
Logged in as [redacted] [\(Log out\)](#)

[CDX Web](#) [Submission Home](#) [CEDRI History](#) [User Management](#) [CEDRI Help](#)

You are here: [CEDRI Home](#) > Submission Package

Use the fields below to manage your submission package before it is submitted electronically. Your package name and selected subparts/reports may be modified at any time prior to submittal. Refer to Section 4.3 of the CEDRI User guide located here [CEDRI User Guide](#) for more specific information regarding submission packages.

Note: In step 2, the facilities in the 'Select Facility' dropdown menu are specific to your organization and role. To modify them, you must navigate to 'My Profile' under the 'MyCDX' menu tab at the top of the screen. Once a facility is chosen, the selection is final, although you may revise facility details at any time by selecting the 'Edit Facility Details' button. You may not revise facility information on a re-submission.

The asterisk (*) next to each step indicates that the corresponding step is required and must be completed before advancing to the next step.

Create/Edit Submission Package

1. Package Name:*
Demonstration: XML Upload

2. Select a facility from the dropdown list.*
ENVIRONMENTAL PROTECTION AGENCY

[To Step 4](#)

- b) Select the appropriate subparts from the dropdown menus and click the 'To Step 4' button to apply your selection (see Exhibit 1-5).

Exhibit 1-5 Filling out Submission Package Data (2/3)

3. Select all applicable subparts for which you are required to submit reports.*

[Help](#)

Part 60 subparts:
Select options

Part 63 subparts:
Select options

State or Other Regulation subparts:
Select options

[To Step 4](#)

- c) Expand the accordion fold for one of the Part-Subpart combinations you selected and select the Air Emissions Report from the dropdown menu and click the 'Use Selected Report(s)' button (see Exhibit 1-6).

Exhibit 1-6 Filling Out Submission Package Data (3/3)

Part 60 - Standards of Performance for New Stationary Sources (NSPS) Subpart Da - In Progress

Electric Utility Steam Generating Units

Select options [Use Selected Report\(s\)](#)

Check all Uncheck all

60.49Da(v)(4) ERT Performance Report

60.51Da(d) Air Emissions Report

- 5) Click the 'Upload XML Data' link (see Exhibit 1-7) to trigger the 'File Upload' dialog.

Exhibit 1-7 Trigger File Upload Dialog

Part 60 – Standards of Performance for New Stationary Sources (NSPS) Subpart Da – In Progress

Electric Utility Steam Generating Units

Select Reports Use Selected Report(s)

60.51Da(d) Air Emissions Report

Report Status	In Progress
Status Date	Fri Dec 04 11:10:10 EST 2015
Form ID	
Reporting Utilities	Click here to access templates and schemas

[Create/Edit Form\(s\)](#) [Upload XML Data](#)

- 6) You may also choose to 'Upload XML Data' in order to complete the Air Emissions Report. For sample schemas click 'Click here to access templates and schemas' link. The following pop-up window will provide you the list of available Reporting Utilities (see Exhibit 1-9). The highlighted link 'CEDRI XML Reporting Instructions' will point you to this user guide.

Exhibit 1-8 Reporting Utilities Templates and Schema

Reporting Utilities

Click the links below to download the Excel upload template file or XML schema for this report. Instructions on how to use the Excel upload template files can be found in [Section 4.5.1 of the CEDRI User Guide](#). Instructions on how to use the XML schema to create valid XML upload files can be found in the [CEDRI XML Reporting Instructions](#).

Part / Subpart Name	Available Files
Part 60 Subpart Da	CMS Downtime Summary(.xlsx)(23KB)
	Excess Emissions Summary(.xlsx)(32KB)
	Malfunction Report(.xlsx)(22KB)
	XML Schema(.xsd)(12KB)

Close

- 7) In the 'File Upload' dialog click the 'Choose File' button and select the appropriate ZIP file from your computer's file system (see Exhibit 1-9).

Exhibit 1-9 Choose a File to Upload

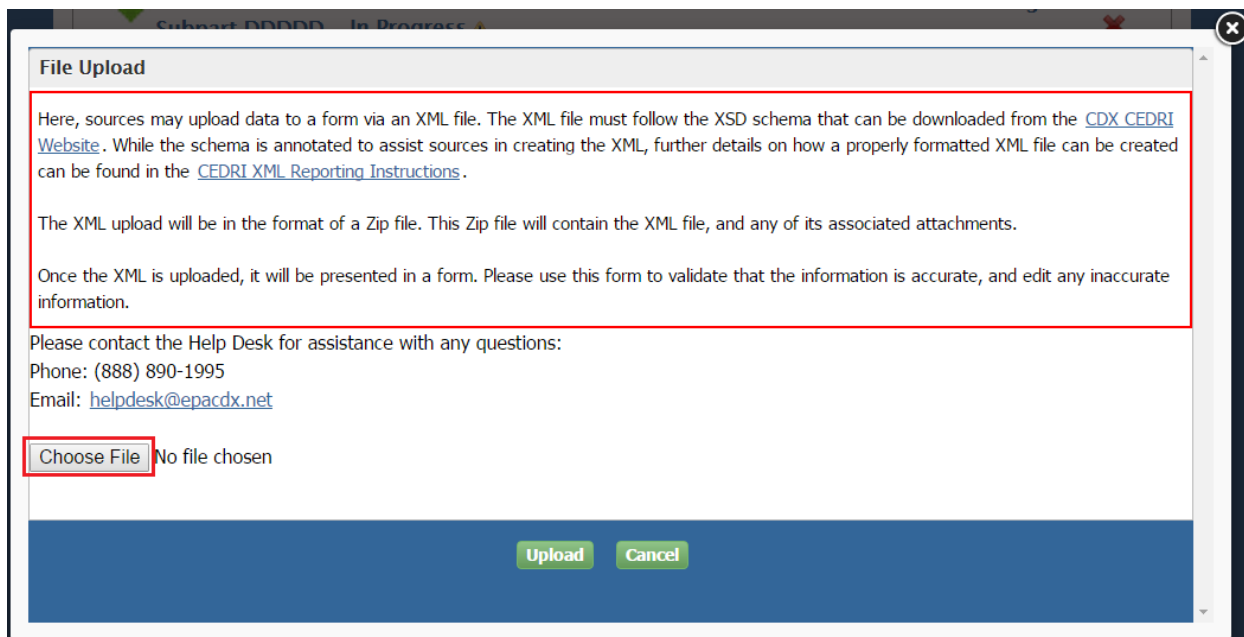

- 8) After you have picked your file, the name of the file will be shown next to the 'Choose File' button (see Exhibit 1-10). Click the 'Upload' button to upload your file, and create the form with the data from the XML. When this button is clicked, CEDRI will validate the contents of your XML file against the appropriate XSD.

Exhibit 1-10 Uploading an XML File

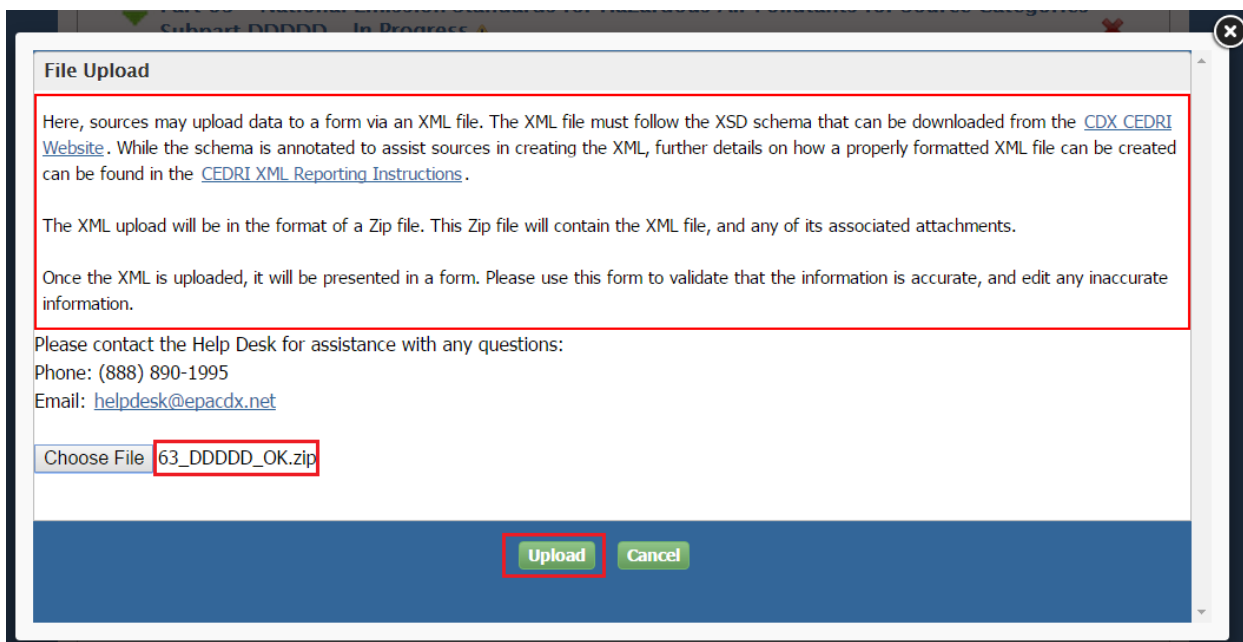

- a) If your XML passes the validation check, the 'Upload Successful' dialog box will be shown reflecting this (see Exhibit 1-11). Click the 'OK' button to continue.

Exhibit 1-11 Upload Successful Dialog Box

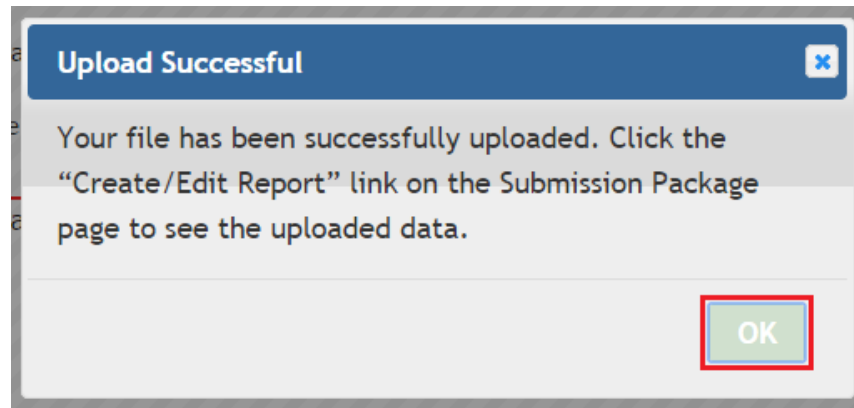

- b) If your XML fails the validation check, the 'Validation Error' dialog box will be shown reflecting this as well (see Exhibit 1-12). The dialog box will detail the errors in the uploaded XML so that you may correct the XML to agree with the applicable XSD. Click the 'OK' button to continue.

Exhibit 1-12 Validation Error Dialog Box

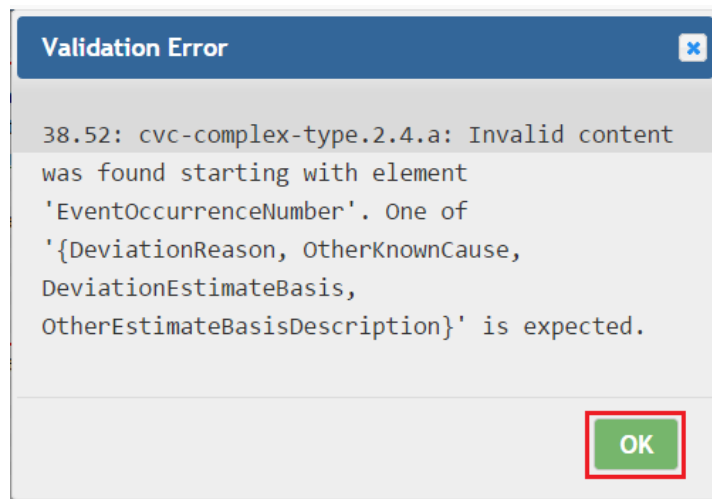

- 9) After a successful XML upload, you must open the form that is now pre-populated with the XML contents, and verify that the data is complete and correct within the form. You can do this by clicking the 'Create/Edit Form(s)' link (see Exhibit 1-13).

Exhibit 1-13 Create / Edit Report Link

Sort By Part Collapse All

Part 60 – Standards of Performance for New Stationary Sources (NSPS) Subpart Da – In Progress

Electric Utility Steam Generating Units

Select Reports Use Selected Report(s)

60.51Da(d) Air Emissions Report	
Report Status	In Progress
Status Date	Sun Dec 06 13:28:10 EST 2015
Form ID	212094
Reporting Utilities	Click here to access templates and schemas
Create/Edit Form(s) Preview Remove	

10) After verifying that all the information in complete and correct within the form, click the ‘Mark as Complete’ button within the form to complete this report (see Exhibit 1-14).

Exhibit 1-14 Mark Form as Complete

EPA United States Environmental Protection Agency

CENTRAL DATA EXCHANGE CDX

Central Data Exchange Contact Us

Additional Information

Describe any changes since last quarter in CMS, process or controls

None.

Please enter any additional information

Please attach any additional information. The file must be in .pdf format.

[Download](#) [Remove](#) [Upload a Different File](#)

If you demonstrate compliance by emission averaging, certify the emission level achieved or the control technology employed is no less stringent than the level or control technology contained in the notification of compliance status in § 63.7545(e)(5)(i). *

Yes
 No
 Not Applicable

[Previous Page](#) [Next Page](#) [Save](#) [Save & Close](#) [Mark as Complete](#)

11) You may complete steps 5-9 for any other AERs within your submission package. Once all reports are completed, follow Section 4.4 in the CEDRI User Guide to submit your package.

Note: A preparer may notify Certifier(s) that a package has been created or is ready for certification by selecting the ‘Notify Certifier(s)’ button at the bottom of the ‘Create/Edit Submission Package’ window. See section 4.3.6 of the CEDRI User Guide for instructions on how to notify Certifiers of a submission package.

2 Data Elements

2.1 WebFIRE Report

WebFIRE Report

Element Name: *WebfireReport*

Element Description: The containing element for the entire report. Holds report metadata, as well as reporting data.

Exhibit 2-1 WebFIRE Report XML Element

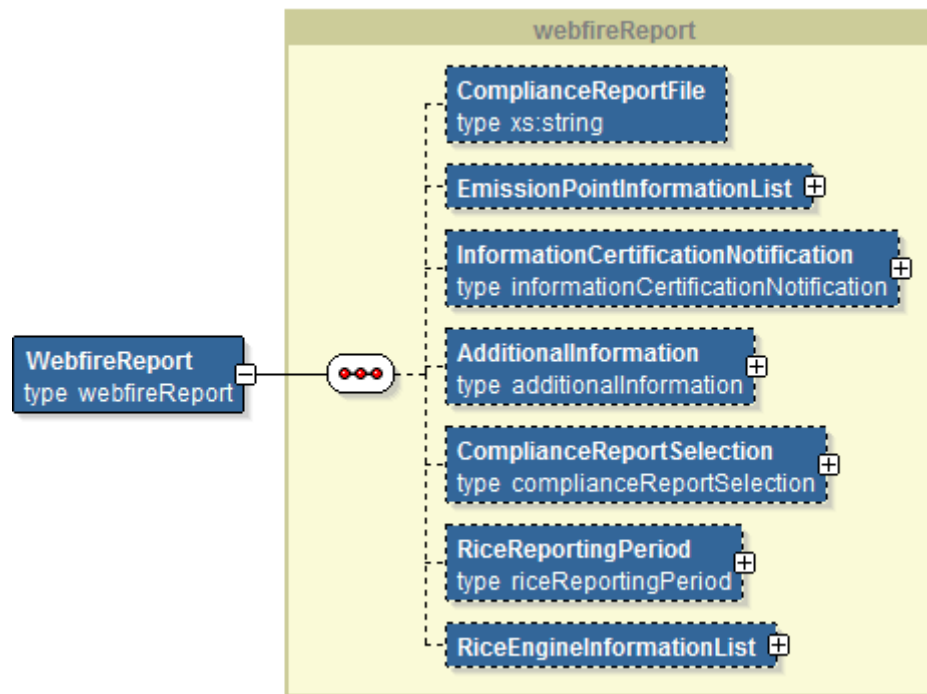

Compliance Report File Upload

Element Name: *ComplianceReportFile*

Element Type: String

Element Description: Name of PDF file that contains applicable 63.7550(c) report(s). Multiple reports must be contained in one PDF.

WebFIRE Report Complex Child Elements

- Emission Point Information List
- Information Certification Information
- Additional Information
- RICE Reporting Period
- RICE Engine Information List

2.2 Emission Point Information List

Emission Point Information List

Element Name: *EmissionPointInformationList*

Element Description: The containing element for Emission Point Information.

Exhibit 2-2 Emission Point Information List XML Element



Emission Point Information List Complex Child Elements

- Emission Point Information

2.3 Emission Point Information

Emission Point Information List

Element Name: *EmissionPointInformation*

Element Description: Containing element for information regarding the emission point.

Exhibit 2-3 Emission Point Information XML Element

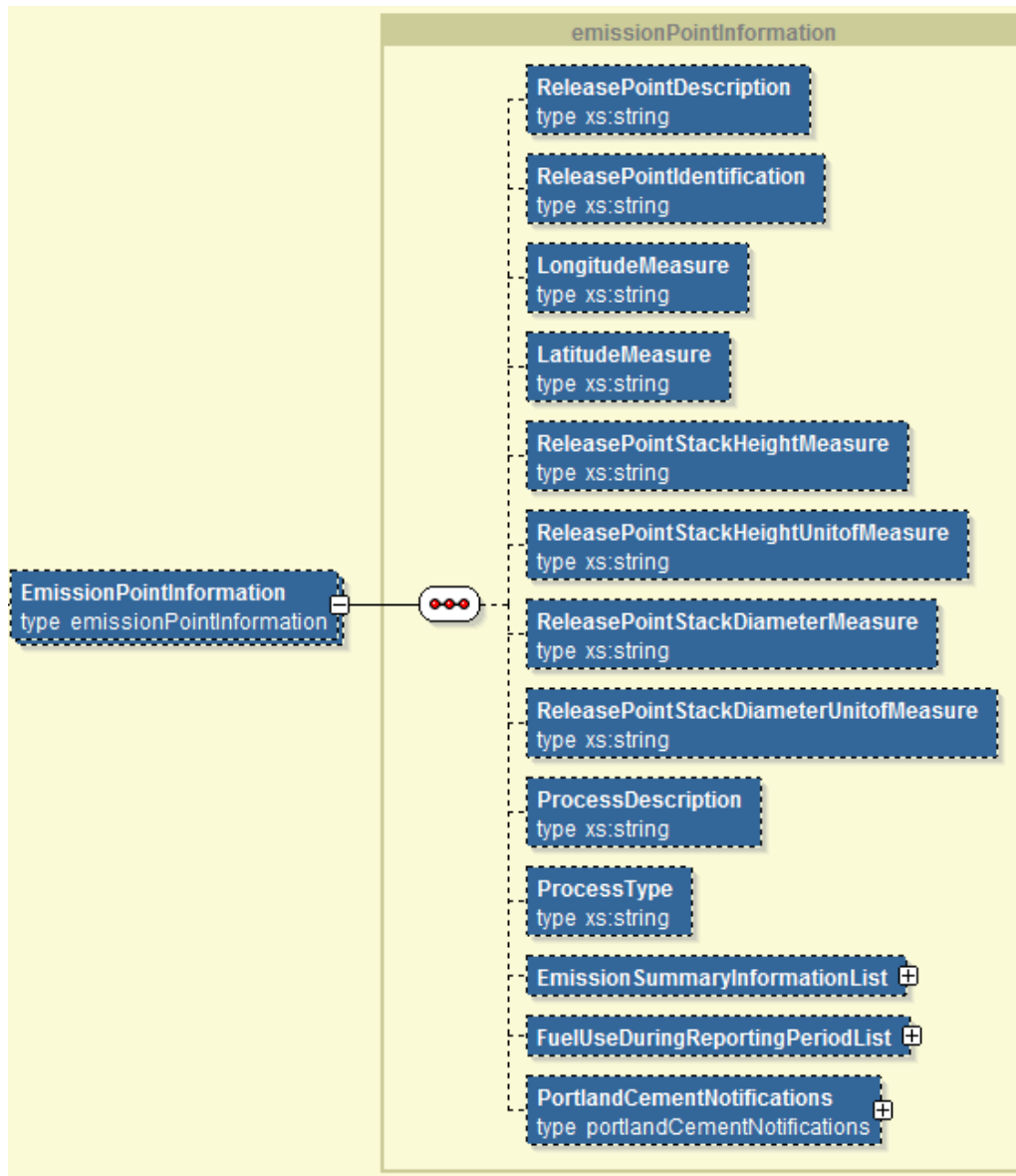

Release Point Description

Element Name: `ReleasePointDescription`

Element Description: A description of the release point (e.g. East Stack).

Release Point Identification

Element Name: `ReleasePointIdentification`

Element Description: The State/Local agency Emission Point ID if applicable.

Longitude Measure

Element Name: *LongitudeMeasure*

Element Description: Longitude measure of the emission point. This value must have 5 decimal places in precision.

Latitude Measure

Element Name: *LatitudeMeasure*

Element Description: Latitude measure of the emission point. This value must have 5 decimal places in precision.

Release Point Stack Height Measure

Element Name: *ReleasePointStackHeightMeasure*

Element Description: The number representing the height of the stack.

Release Point Stack Height Unit of Measure

Element Name: *ReleasePointStackHeightUnitofMeasure*

Element Description: The unit of measure for the stack height.

Release Point Stack Diameter Measure

Element Name: *ReleasePointStackDiameterMeasure*

Element Description: The number representing the diameter of the stack.

Release Point Stack Diameter Unit of Measure

Element Name: *ReleasePointStackDiameterUnitofMeasure*

Element Description: The unit of measure for the stack diameter.

Process Description

Element Name: *ProcessDescription*

Element Description: A description of the process taking place at this emission point (e.g. Wood Burner).

Process Type

Element Name: *ProcessType*

Element Description: The name of the manufacture of the unit.

Emission Point Information Complex Child Elements

- Emission Summary Information List
- Fuel Use During Reporting Period List

- Portland Cement Notifications

2.4 Emission Summary Information List

Emission Summary Information List

Element Name: *EmissionSummaryInformationList*

Element Description: The containing element for Emission Summary Information.

Exhibit 2-4 Emission Summary Information List XML Element

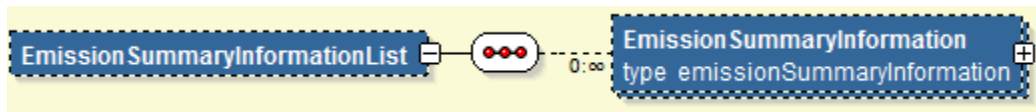

Emission Summary Information List Complex Child Elements

- Emission Summary Information

2.5 Emission Summary Information

Emission Summary Information

Element Name: *EmissionSummaryInformation*

Element Description: The containing element for information regarding the Emissions Summary. This element is repeatable.

Exhibit 2-5 Emission Summary Information XML Element (1/3)

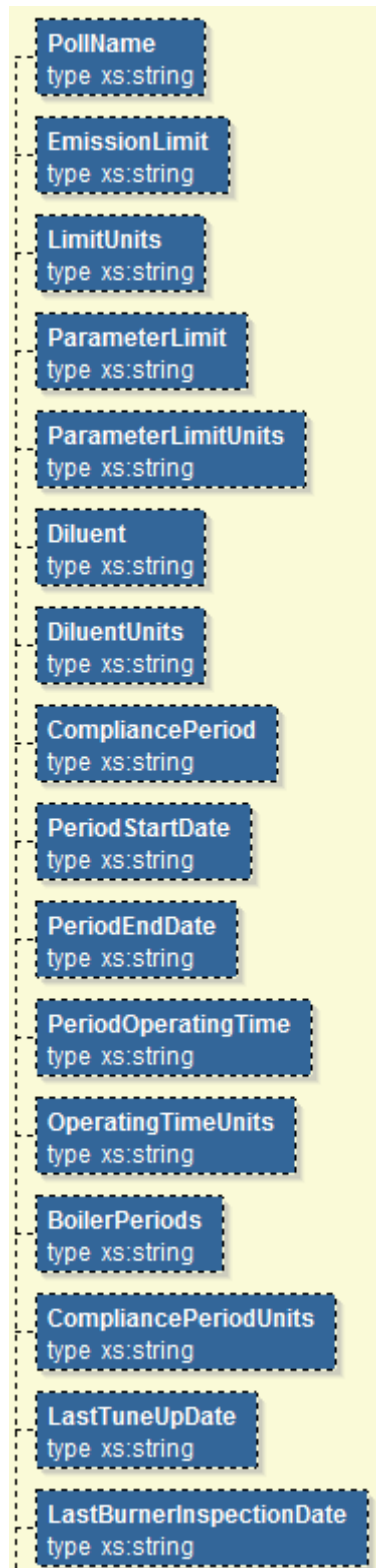

Poll Name

Element Name: PollName

Element Description: The name of the pollutant/parameter. The applicable pollutants for your report can be found in the respective XSD file.

Emission Limit

Element Name: EmissionLimit

Element Description: The number that represents the emission limit.

Limit Units

Element Name: LimitUnits

Element Description: Units for the 'Emission Limit' element. The values available in this field will be dependent upon the value selected for PollName (see Table 2-1).

Table 2-1 Limit Unit Options

PollName	LimitUnits Available Options
CO (630-08-0)	ppb, ppm, grains/dscf, lb/GWh, lb/MMBtu, lb/MWH, lb/Tbtu, lb/ton of product, mg/acm, mg/dscm, ug/acm, ug/dscm
Fuel Moisture*	%
H2S (7783-06-4), HCl (7647-01-0) , HF (7664-39-3), NOx (11104-93-1), TRS (18496-25-8)	ppb, ppm
HAP Metals CEMS	mg/dscm, ug/dscm, grains/dscf, lb/GWh, lb/GWh, lb/MMBtu, lb/MWH, lb/Tbtu, lb/ton of product, ug/acm, mg/ascm
Hg (CEMS) (7439-97-6)	grains/dscf, lb/GWh, lb/MMBtu, lb/MWH, lb/Tbtu, lb/ton of product, mg/ascm, mg/dscm, ug/acm, ug/dscm
Opacity, O2 (7782-44-7), Unit Operating Load	%
PM (CEMS) (1647593)	mg/dscm, ug/dscm
Scrubber Liquid Flow Rate	gal/min
Scrubber pH	n/a
Scrubber Pressure Drop	inches H2O
SO2 (7446-09-5)	ppm, ppb, % reduction
Dry Scrubber Sorbent, Carbon Injection Rate	Kg/hr, liters/hr, kg/Btu
Electrostatic Precipitator Total Secondary Electric Power Output	Volt-amps

PollName	LimitUnits Available Options
PM (CPMS), HCl (CEMS), Hg (CEMS), THC (CEMS), D/F Temperature Monitoring System, Hg Sorbent Trap Monitoring System, Carbon Injection Rate, Activated Carbon Injection Carrier Gas Flow Rate, Activated Carbon Injection Carrier Gas Pressure Drop	Temperature, Activated Carbon Injection Rate

Parameter Limit

Element Name: ParameterLimit

Element Description: The number that represents the Parameter Limit. This is only applicable for pollutants: PM (CPMS), Scrubber pH, Scrubber Liquid Flow Rate, and Scrubber Pressure Drop.

Parameter Limit Units

Element Name: ParameterLimitUnits

Element Description: A string representing the unit value for the ‘Parameter Limit’ element. This is only applicable for pollutants: PM (CPMS), Scrubber pH, Scrubber Liquid Flow Rate, and Scrubber Pressure Drop.

Diluent

Element Name: Diluent

Element Description: The diluent for this pollutant, if applicable.

Diluent Units

Element Name: DiluentUnits

Element Description: Unit of diluent used.

Compliance Period

Element Name: CompliancePeriod

Element Description: The period of recording used during the reporting period. The values available in this field will be dependent upon the Part – Subpart combination of the regulation for which you are submitting, and the value selected for the ‘PollName’ element (see Table 2-2).

Table 2-2 Compliance Period Options

Part – Subpart(s)	PollName	CompliancePeriod Options
60 – Da, Db, Dc	NOx (11104-93-1), TRS (18496-25-8), H2S (7783-06-4), CO (630-08-0), SO2 (7446-09-5), HCl (7647-01-0), HF (7664-39-3), Hg (CEMS) (7439-97-6), Hg (Sorbent Trap Monitoring) (7439-97-6), Fuel Moisture*	Hourly, 4 hrs Period, 6 hrs Period, 12 hrs Period, 24 hrs Period, Daily
	Opacity	Minutes, Hourly, 4 hrs Period, 6 hrs Period, 12 hrs Period, 24 hrs Period, Daily
63 - LLL	PM (CPMS), HCl (CEMS), Hg (CEMS), THC (CEMS), D/F Temperature Monitoring System, Hg Sorbent Trap Monitoring System, Carbon Injection Rate, Activated Carbon Injection Carrier Gas Flow Rate, Activated Carbon Injection Carrier Gas Pressure Drop	30 Operating Day Rolling Avg Periods
63 - DDDDD	CO (630-08-0) Hg (CEMS) (7439-97-6) PM (CPMS) PM (CEMS) (1647593) Scrubber pH Scrubber Liquid Flow Rate Scrubber Pressure Drop Dry Scrubber Sorbent Carbon Injection Rate Electrostatic Precipitator Total Secondary Electric Power Output O2 (7782-44-7) SO2 (7446-09-5)	30 Operating Day Rolling Avg Periods

Part – Subpart(s)	PollName	CompliancePeriod Options
	Unit Operating Load	
	Opacity	Daily

Period Start Date

Element Name: PeriodStartDate

Element Description: The beginning of the reporting period (MM/DD/YYYY).

Period End Date

Element Name: PeriodEndDate

Element Description: The end date of the reporting period (MM/DD/YYYY).

Period Operating Time

Element Name: PeriodOperatingTime

Element Description: The number representing the amount of time this emission point has operated within the Period Start Date and Period End Date.

Operating Time Units

Element Name: OperatingTimeUnits

Element Description: The unit value for the ‘Period Operating Time’ element. This field will be auto-populated, if needed, upon form creation. It is dependent on the value of the ‘PollName’ element. It does not need to be included in an XML upload. See Table 2-3 for details regarding the auto-population of the Operating Time Units field.

Table 2-3 Operating Time Units Auto-Populated Values

PollName	OperatingTimeUnits
CO (630-08-0), Fuel Moisture*, H2S (7783-06-4), HCl (7647-01-0) , HF (7664-39-3), NOx (11104-93-1), TRS (18496-25-8), HAP Metals CEMS, Hg (CEMS) (7439-97-6), O2 (7782-44-7), Unit Operating Load, PM (CEMS) (1647593),	Hours

PollName	OperatingTimeUnits
Scrubber Liquid Flow Rate, Scrubber pH, Scrubber Pressure Drop, SO2 (7446-09-5), Dry Scrubber Sorbent, Carbon Injection Rate, Electrostatic Precipitator Total Secondary Electric Power Output, PM (CPMS), HCl (CEMS), Hg (CEMS), THC (CEMS), D/F Temperature Monitoring System, Hg Sorbent Trap Monitoring System, Carbon Injection Rate, Activated Carbon Injection Carrier Gas Flow Rate, Activated Carbon Injection Carrier Gas Pressure Drop	
Opacity	Minutes

Boiler Periods

Element Name: *BoilerPeriods*

Element Description: Number of Compliance Periods in the reporting period.

CompliancePeriodUnits

Element Name: *CompliancePeriodUnits*

Element Description: Unit value for the ‘Boiler Periods’ element. This field will be auto-populated, if needed, upon form creation. It is dependent on the value of the ‘PollName’ element. It does not need to be included in an XML upload. See Table 2-4 for details regarding the auto-population of the ‘Compliance Period Units’ element.

Table 2-4 Compliance Period Units Auto-Population Values

CompliancePeriod	CompliancePeriodUnits
Minutes	Minutes
Hourly, 4 hrs Period, 6 hrs period, 12 hrs Period, 24 hrs Period	Hours
Daily,	Days

CompliancePeriod	CompliancePeriodUnits
30 Operating Day Rolling Avg Periods, 90 Operating Day Rolling Avg Periods	

Last Tune Up Date

Element Name: LastTuneUpDate

Element Description: The date of the last tune up for a unit subject to 63.10021(e) (if applicable).

Last Burner Inspection Date

Element Name: LastBurnerInspectionDate

Element Description: Most recent date that burner was inspected (if applicable).

Exhibit 2-6 Emission Summary Information XML Element (2/3)

MonitorManufacturer type xs:string
MonitorSerialNumber type xs:string
MonitorModelNumber type xs:string
LastCMSCertificationDate type xs:string
ExcessEmissionSummary type xs:boolean
CMSDowntimeSummary type xs:boolean
MalfunctionReport type xs:boolean
DeviationSummary type xs:boolean
FiveDCMSDowntimeSummary type xs:boolean
FiveDMalfunctionReport type xs:boolean
CMSTotalDowntime type xs:string
CMSPercentDowntime type xs:string
ExcessEmissionsTotalDuration type xs:string
ExcessEmissionsPercentDuration type xs:string
DeviationTotalDuration type xs:string
DeviationPercentDuration type xs:string

Monitor Manufacturer

Element Name: MonitorManufacturer

Element Description: Manufacture for the monitoring device used for the applicable pollutant.

Monitor Serial Number

Element Name: MonitorSerialNumber

Element Description: The serial number for the monitoring device used for the applicable pollutant.

Monitor Model Number

Element Name: MonitorModelNumber

Element Description: The model number for the monitoring device used for the applicable pollutant.

Last CMS Certification Date

Element Name: LastCMSCertificationDate

Element Description: The date of the last CMS Certification for the applicable pollutant.

Excess Emission Summary

Element Name: ExcessEmissionSummary

Element Description: Whether or not there was an occurrence of Excess Emissions to justify an Excess Emissions Report.

CMS Downtime Summary

Element Name: CMSDowntimeSummary

Element Description: Whether or not there was a presence of any instances to justify a CMS Performance Summary.

Malfunction Report

Element Name: MalfunctionReport

Element Description: Whether or not there were any process malfunctions during the reporting period to justify a Malfunction Report.

Deviation Summary

Element Name: DeviationSummary

Element Description: Whether or not there was an occurrence of a deviation from the emissions or operating limit to justify a Deviation Summary.

Five D CMS Downtime Summary

Element Name: FiveDCMSDowntimeSummary

Element Description: Whether or not there was an occurrence of a deviation from continuous monitoring to justify a CMS Performance Summary.

Five D Malfunction Report

Element Name: FiveDMalfunctionReport

Element Description: Whether or not there were any boiler, process heater, associate air pollutant control device, or CMS malfunctions during the reporting period to justify a Malfunction Report.

CMS Total Downtime

Element Name: CMSTotalDowntime

Element Description: This field will be auto-populated, if needed, upon form creation. It does not need to be included in an XML upload.

CMS Percent Downtime

Element Name: CMSPercentDowntime

Element Description: This field will be auto-populated, if needed, upon form creation. It does not need to be included in an XML upload.

Excess Emissions Total Duration

Element Name: ExcessEmissionsTotalDuration

Element Description: This field will be auto-populated, if needed, upon form creation. It does not need to be included in an XML upload.

Excess Emissions Percent Duration

Element Name: ExcessEmissionsPercentDuration

Element Description: This field will be auto-populated, if needed, upon form creation. It does not need to be included in an XML upload.

Deviation Total Duration

Element Name: DeviationTotalDuration

Element Description: This field will be auto-populated, if needed, upon form creation. It does not need to be included in an XML upload.

Deviation Percent Duration

Element Name: *DeviationPercentDuration*

Element Description: This field will be auto-populated, if needed, upon form creation. It does not need to be included in an XML upload.

Exhibit 2-7 Emission Summary Information XML Element (3/3)



Emission Summary Information Complex Child Elements

- Excess Emission Information List
- CMS Downtime Information List
- Equipment Malfunction Information List
- Deviation Information List
- CEMS Summary List

2.6 Excess Emissions Information List

Excess Emission Information List

Element Name: *ExcessEmissionInformationList*

Element Description: The containing element for Excess Emission Information.

Exhibit 2-8 Excess Emission Information List XML Element

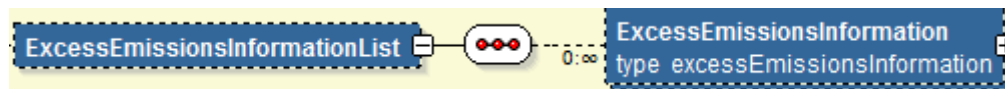

Excess Emissions Information List Complex Child Elements

- Excess Emissions Information

2.7 Excess Emissions Information

Excess Emissions Information

Element Name: *ExcessEmissionInformation*

Element Description: The containing element for information about Excess Emissions. This element is repeatable.

Exhibit 2-9 Excess Emissions Information XML Element

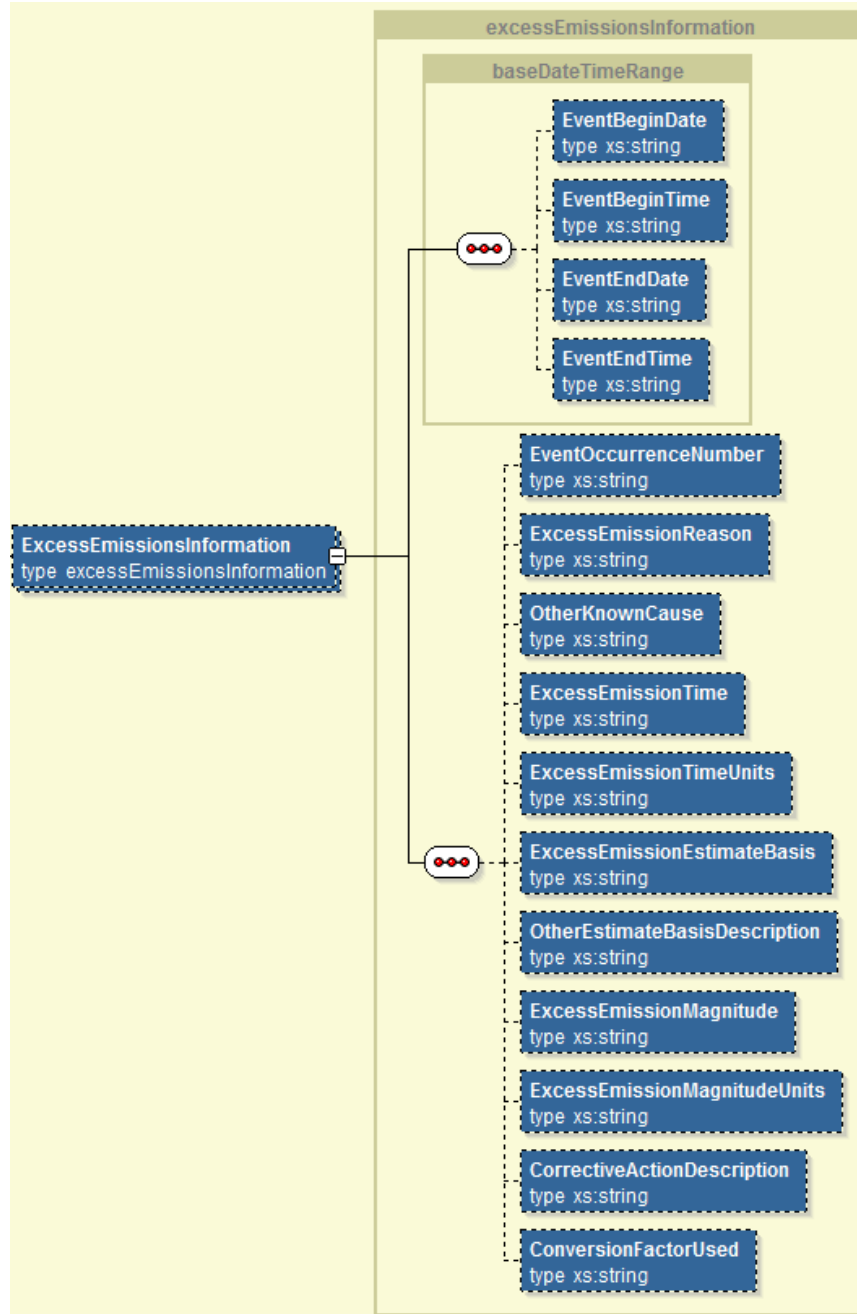

Event Begin Date

Element Name: EventBeginDate

Element Description: Start date of applicable excess emission event.

Event Begin Time

Element Name: EventBeginTime

Element Description: Start time of applicable excess emission event.

Event End Date

Element Name: EventEndDate

Element Description: End date of applicable excess emission event.

Event End Time

Element Name: EventEndTime

Element Description: End time of applicable excess emission event.

Event Occurrence Number

Element Name: EventOccurrenceNumber

Element Description: This field will be auto-populated upon form creation. It does not need to be included in an XML upload.

Excess Emission Reason

Element Name: ExcessEmissionReason

Element Description: Reason why the applicable excess emission event occurred.

Other Known Cause

Element Name: OtherKnownCause

Element Description: If ‘Other known causes’ was selected for the ‘Excess Emission Reason’ element, then this field is required to describe what the known cause for excess emissions was.

Excess Emission Time

Element Name: ExcessEmissionTime

Element Description: The total time elapsed in this occurrence of excess emissions. This field will be auto-populated, if the Excess Emission Time Units field has a value of ‘Hours’ (see Table 2-5 for a list of possible values), upon form creation. It does not need to be included in an XML upload.

Excess Emission Time Units

Element Name: *ExcessEmissionTimeUnits*

Element Description: This field will be auto-populated with the same value as Compliance Period Units, if needed, upon form creation. It does not need to be included in an XML upload. See Table 2-5 for a mapping from the ‘Compliance Period Units’ element to the ‘Excess Emission Time Units’ element.

Table 2-5 Excess Emission Time Units Auto-Population Values

CompliancePeriodUnits	ExcessEmissionTimeUnits
Minutes	Minutes
Hours	Hours
Days	Days

Excess Emission Estimate Basis

Element Name: *ExcessEmissionEstimateBasis*

Element Description: Method used to estimate excess emissions.

Other Estimate Basis Description

Element Name: *OtherEstimateBasisDescription*

Element Description: If ‘Other’ was selected for the ‘Excess Emission Estimate Basis’ element, this field is required and should describe the method used to estimate excess emissions.

Excess Emission Magnitude

Element Name: *ExcessEmissionMagnitude*

Element Description: The value that the measured emissions exceeded the applicable limit.

Excess Emission Magnitude Units

Element Name: *ExcessEmissionMagnitudeUnits*

Element Description: Units that describe the ‘Excess Emission Magnitude’ element. This field’s options are the same as those for the ‘Limit Units’ element, and follow the same rules as shown in Table 2-1.

Corrective Action Description

Element Name: *CorrectiveActionDescription*

Element Description: A description of the corrective action taken to reduce this instance of excess emissions.

Conversion Factor Used

Element Name: *ConversionFactorUsed*

Element Description: The factor used to adjust between different units of measure.

2.8 CMS Downtime Information List

CMS Downtime Information List

Element Name: *CMSDowntimeInformationList*

Element Description: The containing element for CMS Downtime Information.

Exhibit 2-10 CMS Downtime Information List XML Element

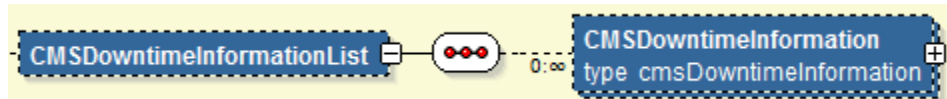

CMS Downtime Information List Complex Child Elements

- CMS Downtime Information

2.9 CMS Downtime Information

CMS Downtime Information

Element Name: *CMSDowntimeInformation*

Element Description: The containing element for information about CMS Downtime. This element is repeatable.

Exhibit 2-11 CMS Downtime Information XML Element

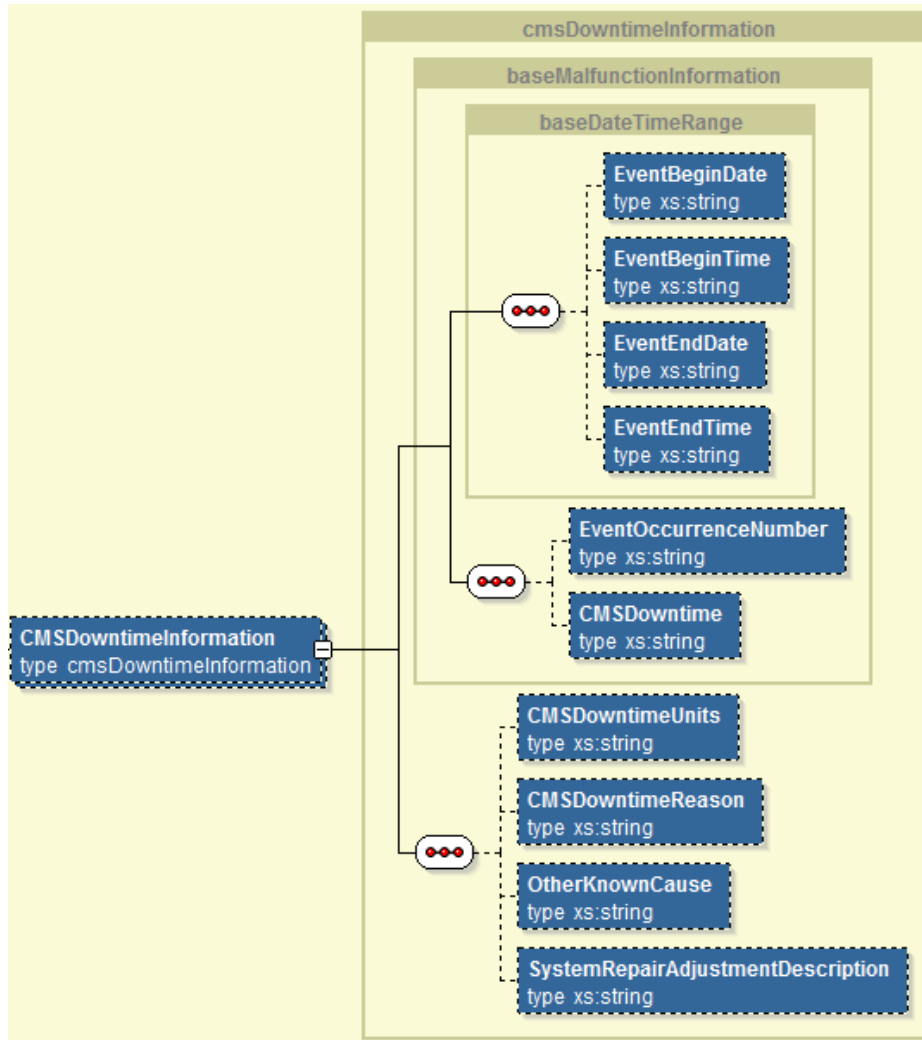

Event Begin Date

Element Name: `EventBeginDate`

Element Description: Start date of applicable CMS downtime event.

Event Begin Time

Element Name: `EventBeginTime`

Element Description: Start time of applicable CMS downtime event.

Event End Date

Element Name: `EventEndDate`

Element Description: End date of applicable CMS downtime event.

Event End Time

Element Name: EventEndTime

Element Description: End time of applicable CMS downtime event.

Event Occurrence Number

Element Name: EventOccurrenceNumber

Element Description: This field will be auto-populated, if needed, upon form creation. It does not need to be included in an XML upload.

CMS Downtime

Element Name: CMSDowntime

Element Description: The total time elapsed in this occurrence of CMS downtime. This field will be auto-populated, if needed, upon form creation. It does not need to be included in an XML upload.

CMS Downtime Units

Element Name: CMSDowntimeUnits

Element Description: The unit value of for the ‘CMS Downtime’ element. This field will be auto-populated with the value ‘Hours’, if needed, upon form creation. It does not need to be included in an XML upload.

CMS Downtime Reason

Element Name: CMSDowntimeReason

Element Description: Reason why applicable CMS downtime event occurred.

Other Known Cause

Element Name: OtherKnownCause

Element Description: Required if ‘Other known causes’ was selected for ‘CMS Downtime Reason’ element.

System Repair Adjustment Description

Element Name: SystemRepairAdjustmentDescription

Element Description: A description of repairs or adjustments done to the system to rectify this CMS downtime event.

2.10 Equipment Malfunction Information List

Equipment Malfunction Information List

Element Name: *EquipmentMalfunctionInformationList*

Element Description: The containing element for Equipment Malfunction Information.

Exhibit 2-12 Equipment Malfunction Information List XML Element

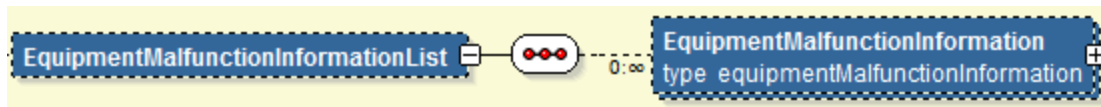

Equipment Malfunction Information List Complex Child Elements

- Equipment Malfunction Information

2.11 Equipment Malfunction Information

Equipment Malfunction Information

Element Name: *EquipmentMalfunctionInformation*

Element Description: The containing element for information about an equipment malfunction. This element is repeatable.

Exhibit 2-13 Equipment Malfunction Information XML Element

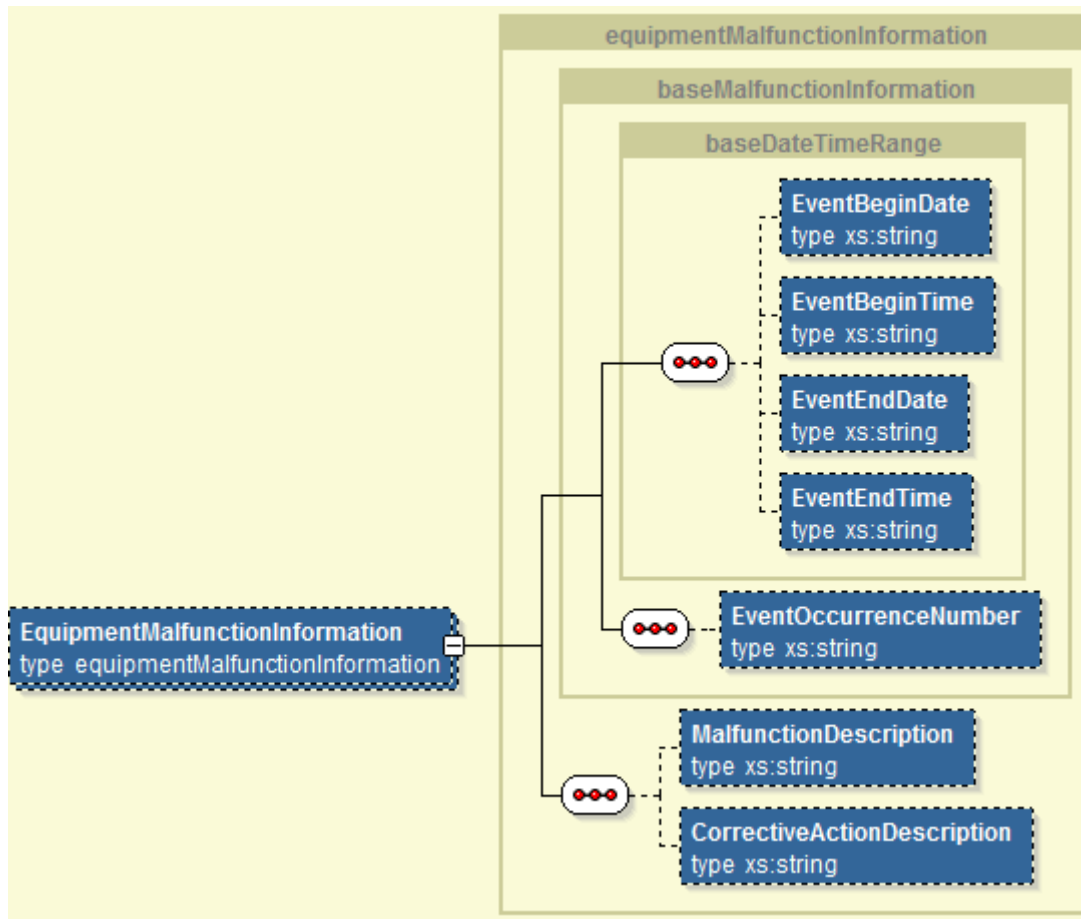

Event Begin Date

Element Name: `EventBeginDate`

Element Description: Start date of applicable equipment malfunction event.

Event Begin Time

Element Name: `EventBeginTime`

Element Description: Start time of applicable equipment malfunction event.

Event End Date

Element Name: `EventEndDate`

Element Description: End date of applicable equipment malfunction event.

Event End Time

Element Name: `EventEndTime`

Element Description: End time of applicable equipment malfunction event.

Event Occurrence Number

Element Name: *EventOccurrenceNumber*

Element Description: This field will be auto-populated, if needed, upon form creation. It does not need to be included in an XML upload.

Malfunction Description

Element Name: *MalfunctionDescription*

Element Description: Details of applicable equipment malfunction event.

Corrective Action Description

Element Name: *CorrectiveActionDescription*

Element Description: Description of the corrective action taken for this malfunction.

2.12 Deviation Information List

Deviation Information List

Element Name: *DeviationInformationList*

Element Description: The containing element for Deviation Information.

Exhibit 2-14 Deviation Information List XML Element

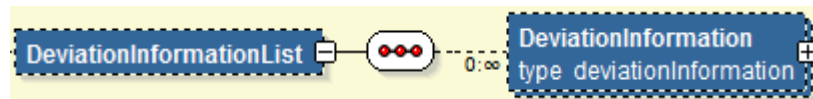

Deviation Information List Complex Child Elements

- Deviation Information

2.13 Deviation Information

Deviation Information

Element Name: *DeviationInformation*

Element Description: The containing element for information about deviations from the emissions or operating limit. This element is repeatable.

Exhibit 2-15 Deviation Information XML Element

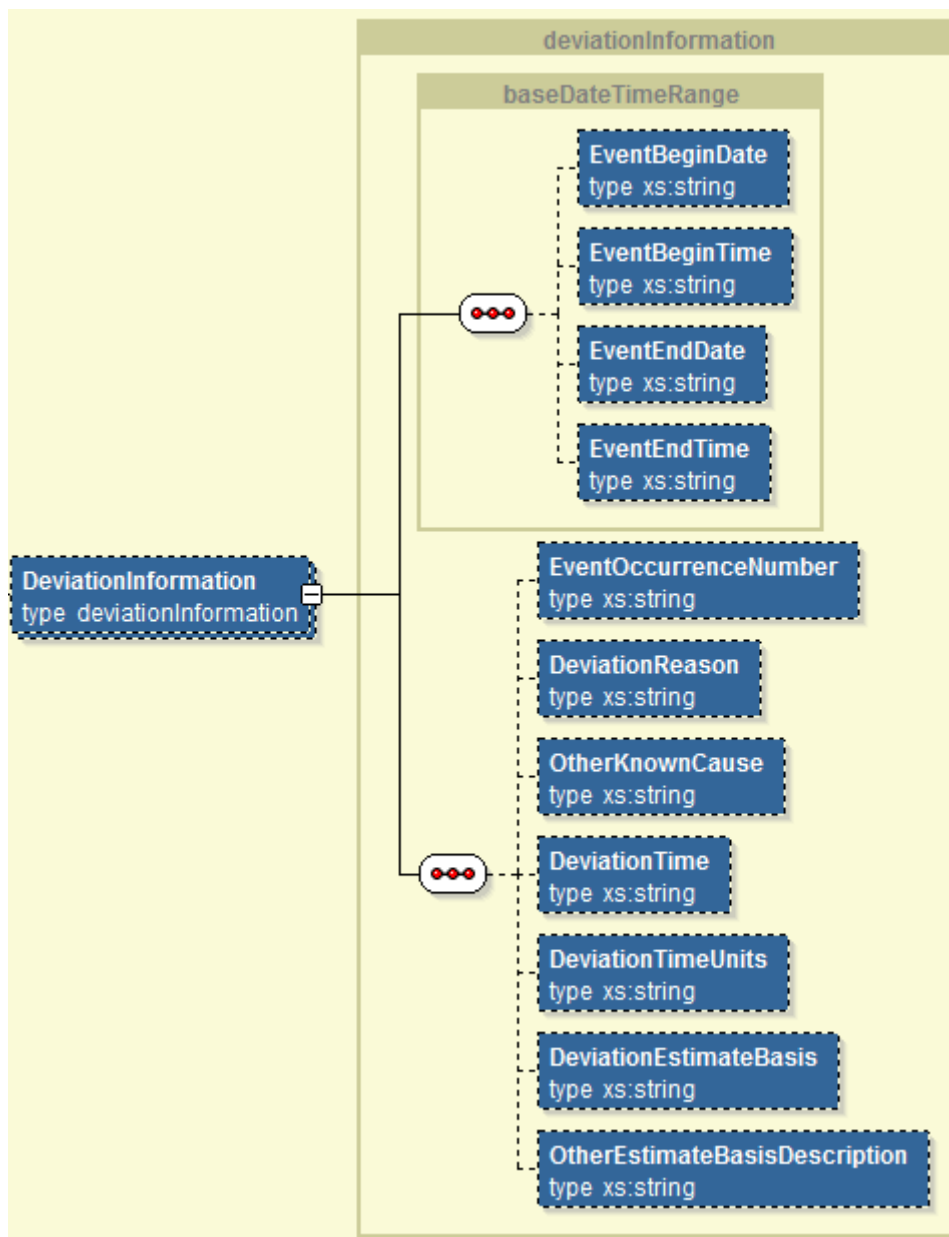

Event Begin Date

Element Name: `EventBeginDate`

Element Description: Start date of applicable deviation event.

Event Begin Time

Element Name: `EventBeginTime`

Element Description: Start time of applicable deviation event.

Event End Date

Element Name: EventEndDate

Element Description: End date of applicable deviation event.

Event End Time

Element Name: EventEndTime

Element Description: End time of applicable deviation event.

Event Occurrence Number

Element Name: EventOccurrenceNumber

Element Description: This field will be auto-populated, if needed, upon form creation. It does not need to be included in an XML upload.

Deviation Reason

Element Name: DeviationReason

Element Description: The reason for deviation from the emissions or operating limit.

Other Known Cause

Element Name: OtherKnownCause

Element Description: If ‘Other known causes’ was selected for the ‘Deviation Reason’ element, then this field is required to describe what the known cause for the deviation was.

Deviation Time

Element Name: DeviationTime

Element Description: This field will be auto-populated, if needed, upon form creation. It does not need to be included in an XML upload.

Deviation Time Units

Element Name: DeviationTimeUnits

Element Description: This field will be auto-populated with the value ‘days’, if needed, upon form creation. It does not need to be included in an XML upload.

Deviation Estimate Basis

Element Name: DeviationEstimateBasis

Element Description: The means by which an estimate of the deviation was made.

Other Estimate Basis Description

Element Name: *OtherEstimateBasisDescription*

Element Description: If 'Other' was selected for the 'Deviation Estimate Basis' element, then this field is required to describe the basis of estimate for the deviation.

2.14 CEMS Summary List

CEMS Summary List

Element Name: *CEMSSummaryList*

Element Description: The containing element for CEMS Summary information.

Exhibit 2-16 CEMS Summary List XML Element

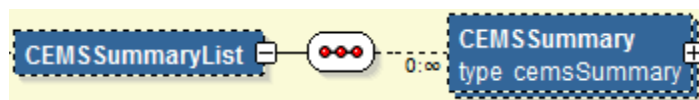

CEMS Summary List Complex Child Elements

- CEMS Summary

2.15 CEMS Summary

CEMS Summary

Element Name: *CEMSSummary*

Element Description: The containing element for information about monitoring system averages. This element is repeatable.

Exhibit 2-17 CEMS Summary XML Element

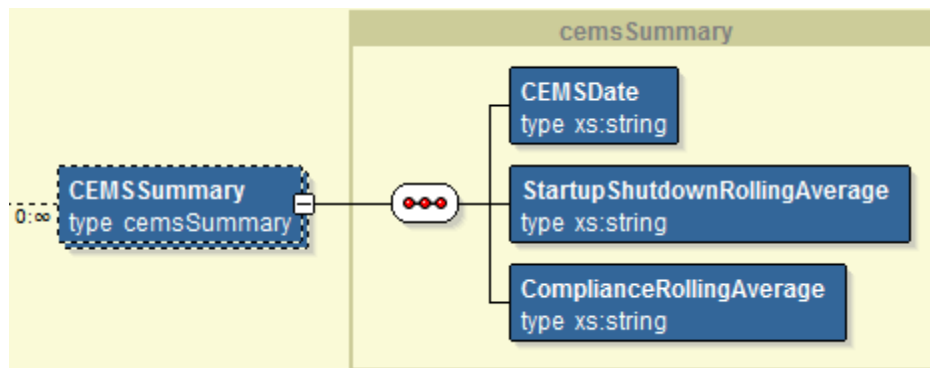

CEMS Date

Element Name: *CEMSDate*

Element Description: Date of monitoring system measurement.

Startup Shutdown Rolling Average

Element Name: *StartupShutdownRollingAverage*

Element Description: The Startup / Shutdown Rolling average for the applicable Emission Monitoring System.

Compliance Rolling Average

Element Name: *ComplianceRollingAverage*

Element Description: The compliance Rolling Average for the applicable Emission Monitoring System.

2.16 Fuel Use During Reporting Period List

Fuel Use During Report Period List

Element Name: *FuelUseDuringReportingPeriodList*

Element Description: The containing element for Fuel Use During Reporting Period.

Exhibit 2-18 Fuel Use During Reporting Period List XML Element

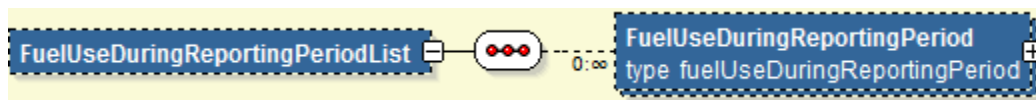

Fuel Use During Report Period List Complex Child Elements

- Fuel Use During Report Period

2.17 Fuel Use During Reporting Period

Fuel Use During Report Period

Element Name: *FuelUseDuringReportingPeriod*

Element Description: The containing element for information on Fuel User During the Reporting Period. This element is repeatable.

Exhibit 2-19 Fuel Use During Reporting Period XML Element

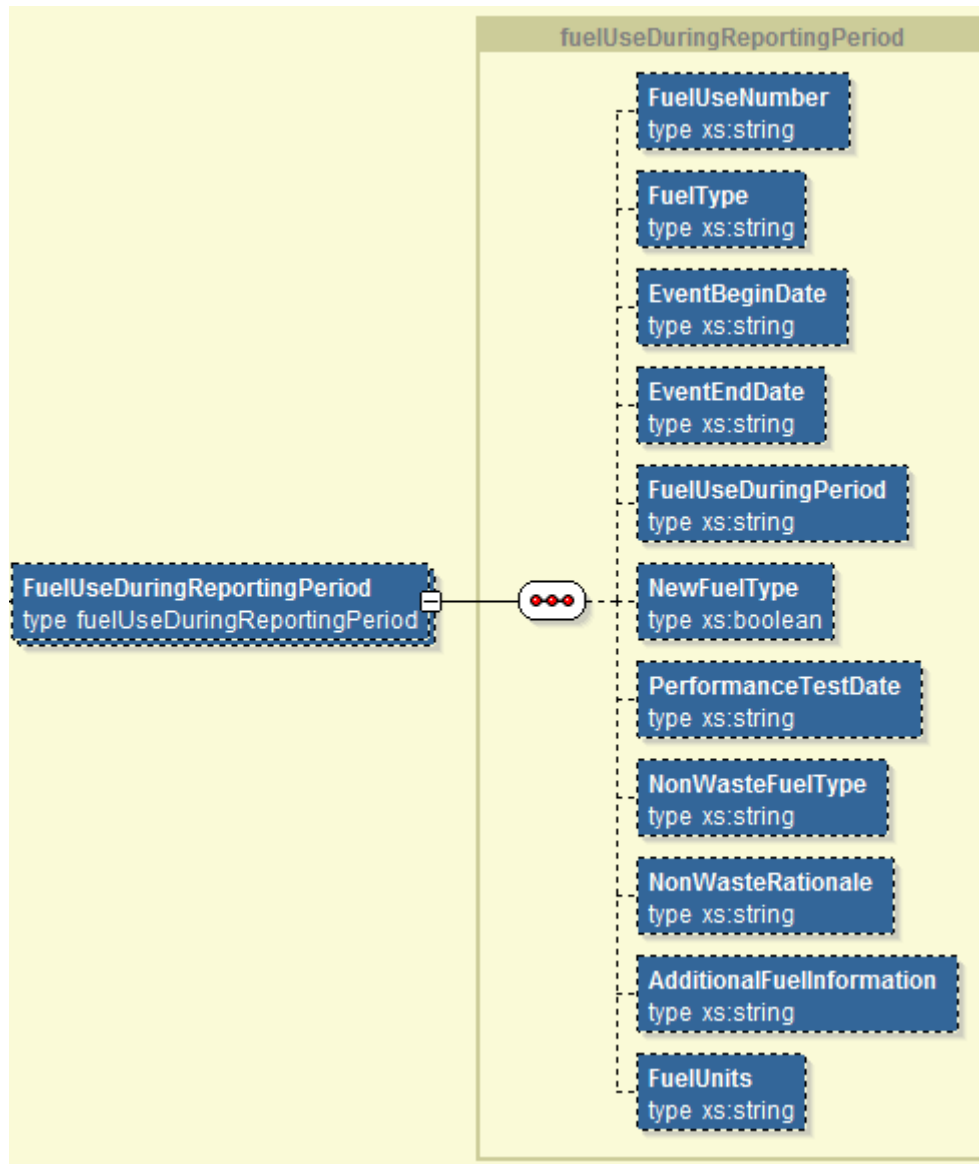

Fuel Use Number

Element Name: `FuelUseNumber`

Element Description: This field will be auto-populated, if needed, upon form creation. It does not need to be included in an XML upload.

Fuel Type

Element Name: `FuelType`

Element Description: Type of fuel used during reporting period.

Event Begin Date

Element Name: EventBeginDate

Element Description: Start date of applicable fuel use.

Event End Date

Element Name: EventEndDate

Element Description: End date of applicable fuel use.

Fuel Use During Period

Element Name: FuelUseDuringPeriod

Element Description: The amount of fuel used during this instance.

Fuel Units

Element Name: FuelUnits

Element Description: The units for the amount of fuel used in this instance.

New Fuel Type

Element Name: NewFuelType

Element Description: Whether or not the fuel is a new type.

Performance Test Date

Element Name: PerformanceTestDate

Element Description: Date of performance test when this fuel was in use.

Non Waste Fuel Type

Element Name: NonWasteFuelType

Element Description: Type of non-waste fuel, or if the fuel is not non-waste fuel.

Non Waste Rationale

Element Name: NonWasteRationale

Element Description: If 'Non EPA determined non-waste' is selected for the 'Non Waste Fuel Type' element, this field is required to describe the basis for concluding the fuel is a non-waste fuel.

Additional Fuel Information

Element Name: AdditionalFuelInformation

Element Description: Any additional information about the fuel that you would like to report.

2.18 Portland Cement Notifications

Portland Cement Notifications

Element Name: *PortlandCementNotifications*

Element Description: The containing element for Portland Cement information.

Exhibit 2-20 Portland Cement Notifications XML Element

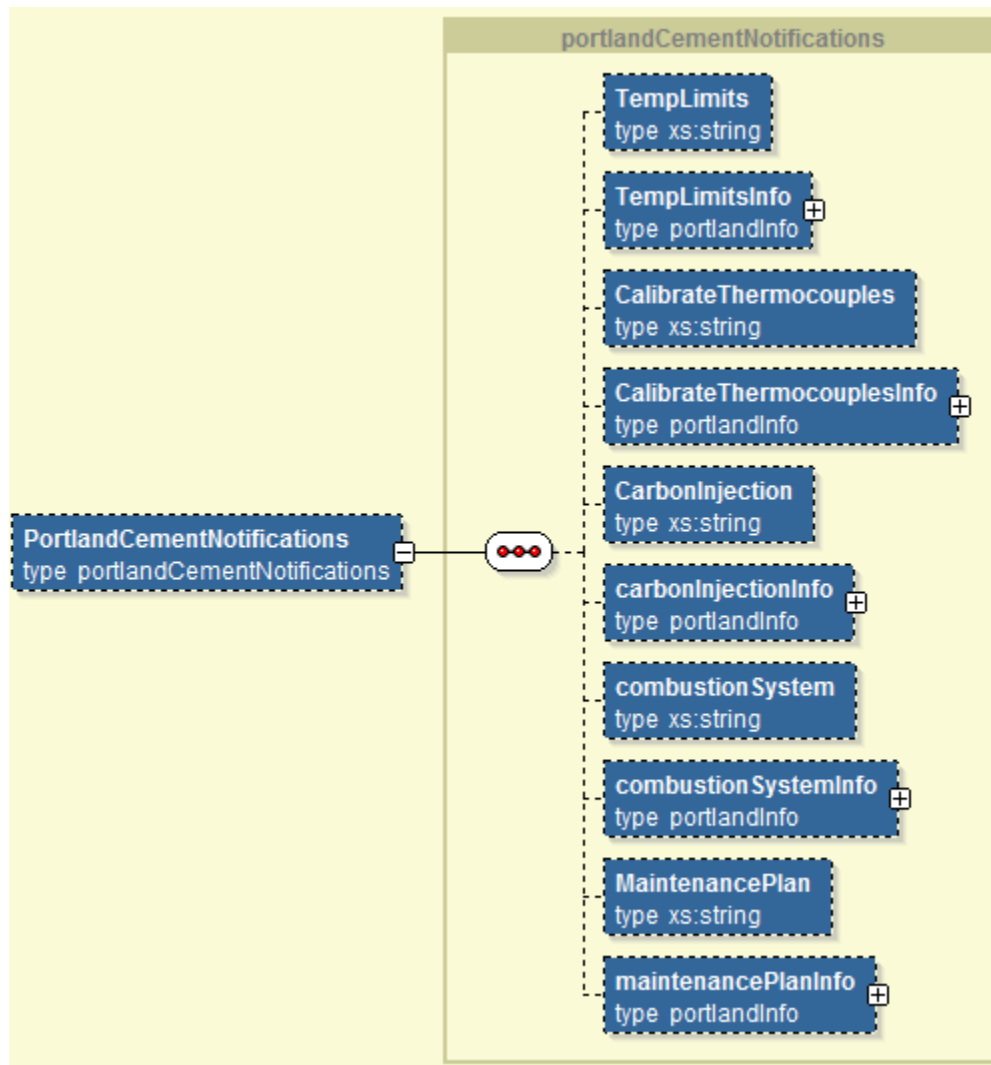

Temp Limits

Element Name: *TempLimits*

Element Description: Whether or not there were any exceedances of maximum control device inlet gas temperature limits specified in §63.1346(a) and (b).

Calibrate Thermocouples

Element Name: CalibrateThermocouples

Element Description: Whether or not there were any failures to calibrate thermocouples and other temperature sensors as required under §63.1350(g)(1)(iii).

Carbon Injection

Element Name: CarbonInjection

Element Description: Whether or not there were any failures to maintain the activated carbon injection rate, and the activated carbon injection carrier gas flow rates or pressure drops, as applicable, as required under §63.1346(c)(2).

Combustion System

Element Name: CombustionSystem

Element Description: Whether or not there were any failures to conduct any combustion system component inspections conducted within the reporting period as required under §63.1347(a)(3).

Maintenance Plan

Element Name: MaintenancePlan

Element Description: Whether or not there were any failures to comply with any provision of the operation and maintenance plan developed in accordance with §63.1347(a).

Portland Cement Notifications Complex Child Elements

- Temp Limits Info
- Calibrate Thermocouples Info
- Carbon Injection Info
- Combustion System Info
- Maintenance Plan Info

2.19 Temp Limits Info

Temp Limits Info

Element Name: TempLimitsInfo

Element Description: Containing element for addition information for the ‘Temp Limits’ element.

Exhibit 2-21 Temp Limits Info XML Element

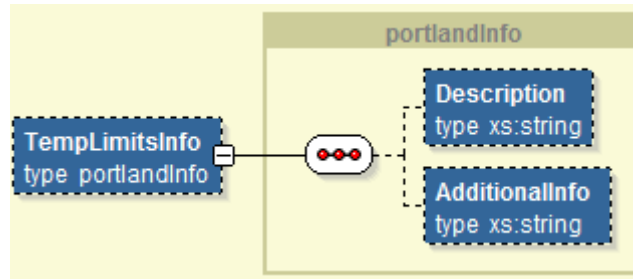

Description

Element Name: *Description*

Element Description: This is required if you answer ‘Yes’ to the ‘Temp Limits’ element. Explain all exceedances of maximum control device inlet.

Additional Info

Element Name: *AdditionalInfo*

Element Description: This is optional if you answer ‘No’ to the ‘Temp Limits’ element. Please list any additional information you would like to provide.

2.20 Calibrate Thermocouples Info

Calibrate Thermocouples Info

Element Name: *CalibrateThermocouplesInfo*

Element Description: Containing element for additional information for the ‘Calibrate Thermocouples’ element.

Exhibit 2-22 Calibrate Thermocouples Info XML Element

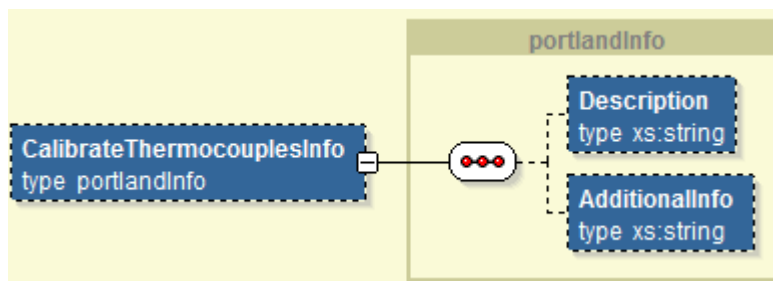

Description

Element Name: *Description*

Element Description: This is required if you answer ‘Yes’ to the ‘Calibrate Thermocouples’ element. Explain all failures to calibrate thermocouples and other temperature sensors.

Additional Info

Element Name: *AdditionalInfo*

Element Description: This is optional if you answer ‘No’ to the ‘Calibrate Thermocouples’ element. Please list any additional information you would like to provide.

2.21 Carbon Injection Info

Carbon Injection Info

Element Name: *carbonInjectionInfo*

Element Description: Containing element for additional information for the ‘Carbon Injection’ element.

Exhibit 2-23 Carbon Injection Info XML Element

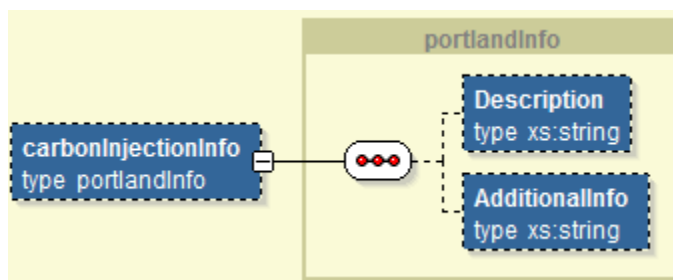

Description

Element Name: *Description*

Element Description: This is required if you answer ‘Yes’ to the ‘Carbon Injection’ element. Explain all failures to maintain the activated carbon injection rate, and the activated carbon injection carrier gas flow rates or pressure drops.

Additional Info

Element Name: *AdditionalInfo*

Element Description: This is optional if you answer ‘No’ to the ‘Carbon Injection’ element. Please list any additional information you would like to provide.

2.22 Combustion System Info

Combustion System Info

Element Name: *combustionSystemInfo*

Element Description: Containing element for additional information for the ‘Combustion System’ element.

Exhibit 2-24 Combustion System Info XML Element

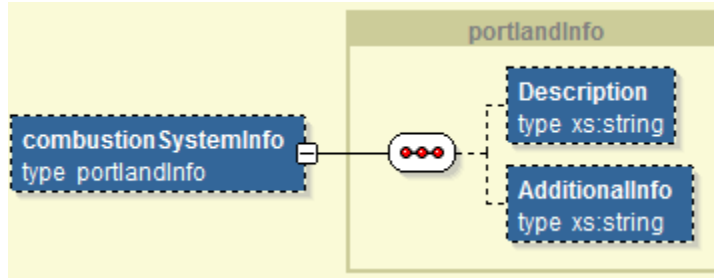

Description

Element Name: Description

Element Description: This is required if you answer ‘Yes’ to the ‘Combustion System’ element. Explain all failures to conduct any combustion system component inspections conducted within the reporting period.

Additional Info

Element Name: AdditionalInfo

Element Description: This is optional if you answer ‘No’ to the ‘Combustion System’ element. Please list any additional information you would like to provide.

2.23 Maintenance Plan Info

Maintenance Plan Info

Element Name: maintenacePlanInfo

Element Description: Containing element for additional information for the ‘Maintenance Plan’ element.

Exhibit 2-25 Maintenance Plan Info XML Element

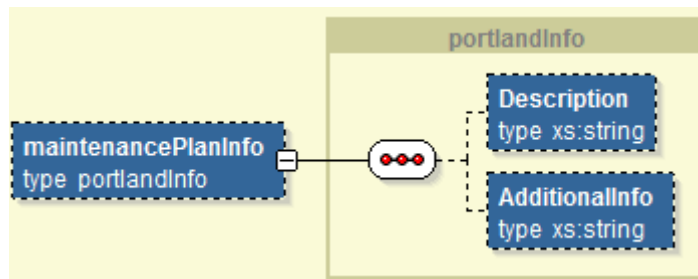

Description

Element Name: Description

Element Description: This is required if you answer ‘Yes’ to the ‘Maintenance Plan’ element. List any and all failures to comply with provisions of the operating and maintenance plan.

Additional Info

Element Name: *AdditionalInfo*

Element Description: This is optional if you answer ‘No’ to the ‘Maintenance Plan’ element. Please list any additional information you would like to provide.

2.24 Information Certification Notification

Information Certification Notification

Element Name: *InformationCertificationNotification*

Element Description: Containing element for information regarding Certification Notifications.

Exhibit 2-26 Information Certification Notification XML Element

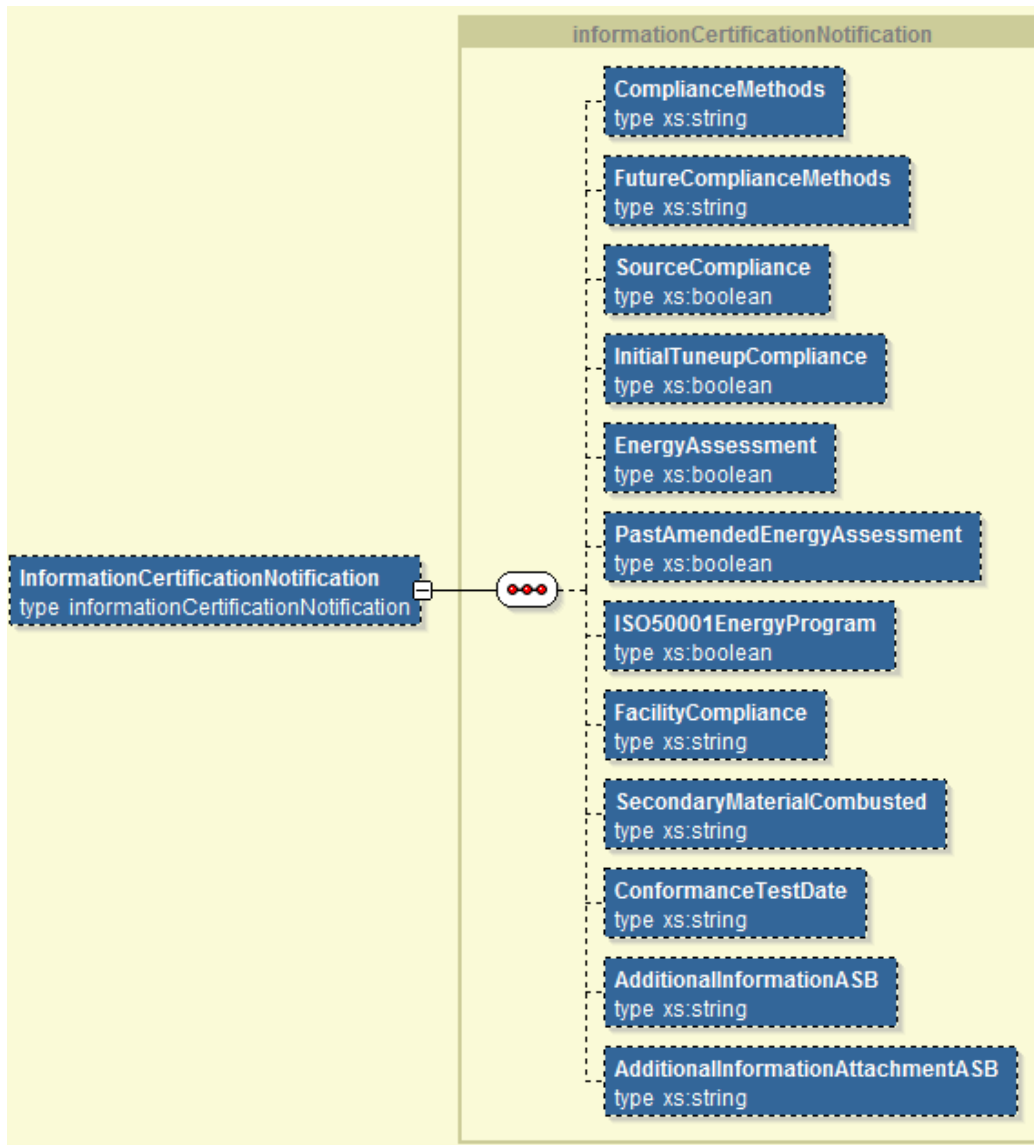

Compliance Methods

Element Name: *ComplianceMethods*

Element Description: The methods that were used to determine compliance.

Future Compliance Methods

Element Name: *FutureComplianceMethods*

Element Description: The methods that will be used for determining continuing compliance, including a description of monitoring and reporting requirements and test methods.

Source Compliance

Element Name: *SourceCompliance*

Element Description: Whether or not the source complied with the relevant standard or other requirements.

Initial Tune up Compliance

Element Name: *InitialTuneupCompliance*

Element Description: Whether or not this facility complies with the requirements in §63.11214 to conduct an initial tune-up of the boiler.

Energy Assessment

Element Name: *EnergyAssessment*

Element Description: Whether or not the facility has had an energy assessment performed according to §63.11214(c).

Past Amended Energy Assessment

Element Name: *PastAmendedEnergyAssessment*

Element Description: This element is required if you answered ‘Yes’ to the ‘Energy Assessment’ element. Whether or not a past or amended energy assessment has been performed on or after January 1, 2008 and by March 21, 2014 to meet the energy assessment requirements in §63.11214(c).

ISO 50001 Energy Program

Element Name: *ISO50001EnergyProgram*

Element Description: This element is required if you answered ‘Yes’ to the ‘Energy Assessment’ element. Whether or not your facility operates under an energy program compatible with ISO 50001 that includes the affected units to meet the energy assessment requirements of §63.11214(c).

Facility Compliance

Element Name: *FacilityCompliance*

Element Description: Whether or not the facility complies with the requirements in §63.11224(f).

Secondary Material Combusted

Element Name: *SecondaryMaterialCombusted*

Element Description: Whether or not no secondary materials that are solid waste were combusted in any affected unit.

Conformance Test Date

Element Name: *ConformanceTestDate*

Element Description: Date of the test showing conformance with the emission standard and operating limits of the subpart (if applicable).

Additional Information ASB

Element Name: *AdditionalInformationASB*

Element Description: Any additional information you wish to include in the report.

Additional Information Attachment ASB

Element Name: *AdditionalInformationAttachmentASB*

Element Description: Attachment of additional information for the report. Must be a PDF.

2.25 Additional Information

Additional Information

Element Name: *AdditionalInformation*

Element Description: Containing element for Additional information for most AER forms.

Exhibit 2-27 Additional Information XML Element

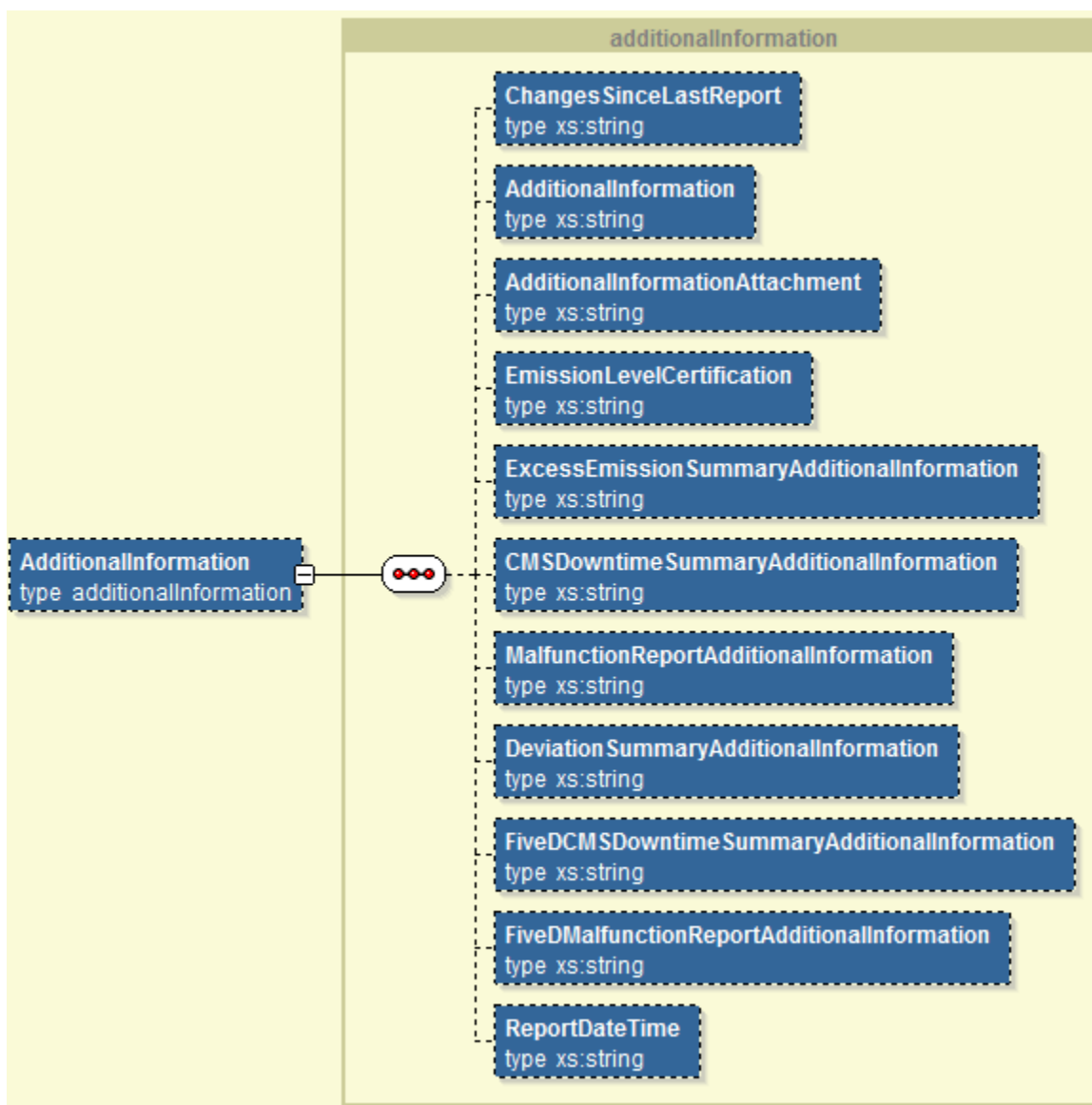

Change Since Last Report

Element Name: `ChangeSinceLastReport`

Element Description: Details on the changes since the last quarter in the CMS, process, or controls.

Additional Information

Element Name: `AdditionalInformation`

Element Description: Describe any additional information to be included in the AER form.

Additional Information Attachment

Element Name: *AdditionalInformationAttachment*

Element Description: Attachments to give further details about applicable additional information. Must be a PDF.

Emission Level Certification

Element Name: *EmissionLevelCertification*

Element Description: Whether or not your facility demonstrates compliance by emission averaging, certify that the emission level achieved or the control technology employed is no less stringent than the level or control technology contained in the notification of compliance status in § 63.7545(e)(5)(i).

Excess Emission Summary Additional Information

Element Name: *ExcessEmissionSummaryAddtionalInformation*

Element Description: Additional information for the excess emission summary if you answered ‘No’ to the ‘Excess Emissions Summary’ element.

CMS Downtime Summary Additional Information

Element Name: *CMSDowntimeSummaryAddtionalInformation*

Element Description: Additional information for the CMS downtime summary if you answered ‘No’ to the ‘CMS Downtime Summary’ element.

Malfunction Report Additional Information

Element Name: *MalfunctionReportAddtionalInformation*

Element Description: Additional information for the malfunction report if you answered ‘No’ to the ‘Malfunction Report’ element.

Deviation Summary Additional Information

Element Name: *DeviationSummaryAddtionalInformation*

Element Description: Additional information for the deviation summary if you answered ‘No’ to the ‘Deviation Summary’ element.

Five D CMS Downtime Summary Additional Information

Element Name: *FiveDCMSDowntimeSummaryAddtionalInformation*

Element Description: Additional information for the CMS downtime summary if you answered ‘No’ to the ‘Five D CMS Downtime Summary’ element.

Five D Malfunction Report Additional Information

Element Name: *FiveDMalfunctionReportAddtionalInformation*

Element Description: Addition information for the malfunction report if you answered ‘No’ to the ‘Five D Malfunction Report’ question.

Report Date Time

Element Name: *ReportDateTime*

Element Description: This field will be auto-populated, upon form creation. It should not be included in an XML upload.

2.26 Rice Reporting Period

Rice Reporting Period

Element Name: *RiceReportingPeriod*

Element Description: Containing element for information about the RICE reporting period.

Exhibit 2-28 Rice Reporting Period XML Element

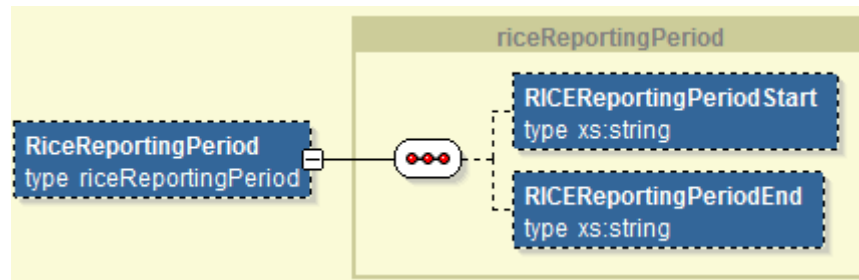

Rice Reporting Period Start

Element Name: *RiceReportingPeriodStart*

Element Description: Start date of RICE reporting period.

Rice Reporting Period End

Element Name: *RiceReportingPeriodEnd*

Element Description: End date of RICE reporting period.

2.27 Rice Engine Information List

Rice Engine Information List

Element Name: *RiceEngineInformationList*

Element Description: Containing element for the RICE Engine Information elements.

Exhibit 2-29 Rice Engine Information List XML Element

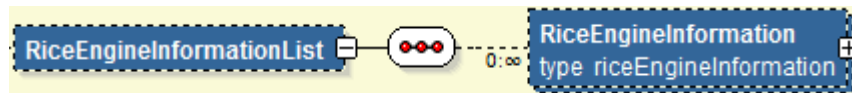

Rice Engine Information List Complex Child Elements

- Rice Engine Information

2.28 Rice Engine Information

Rice Engine Information

Element Name: *RiceEngineInformation*

Element Description: Containing element for information regarding RICE engines. This element is repeatable.

Exhibit 2-30 Rice Engine Information XML Element

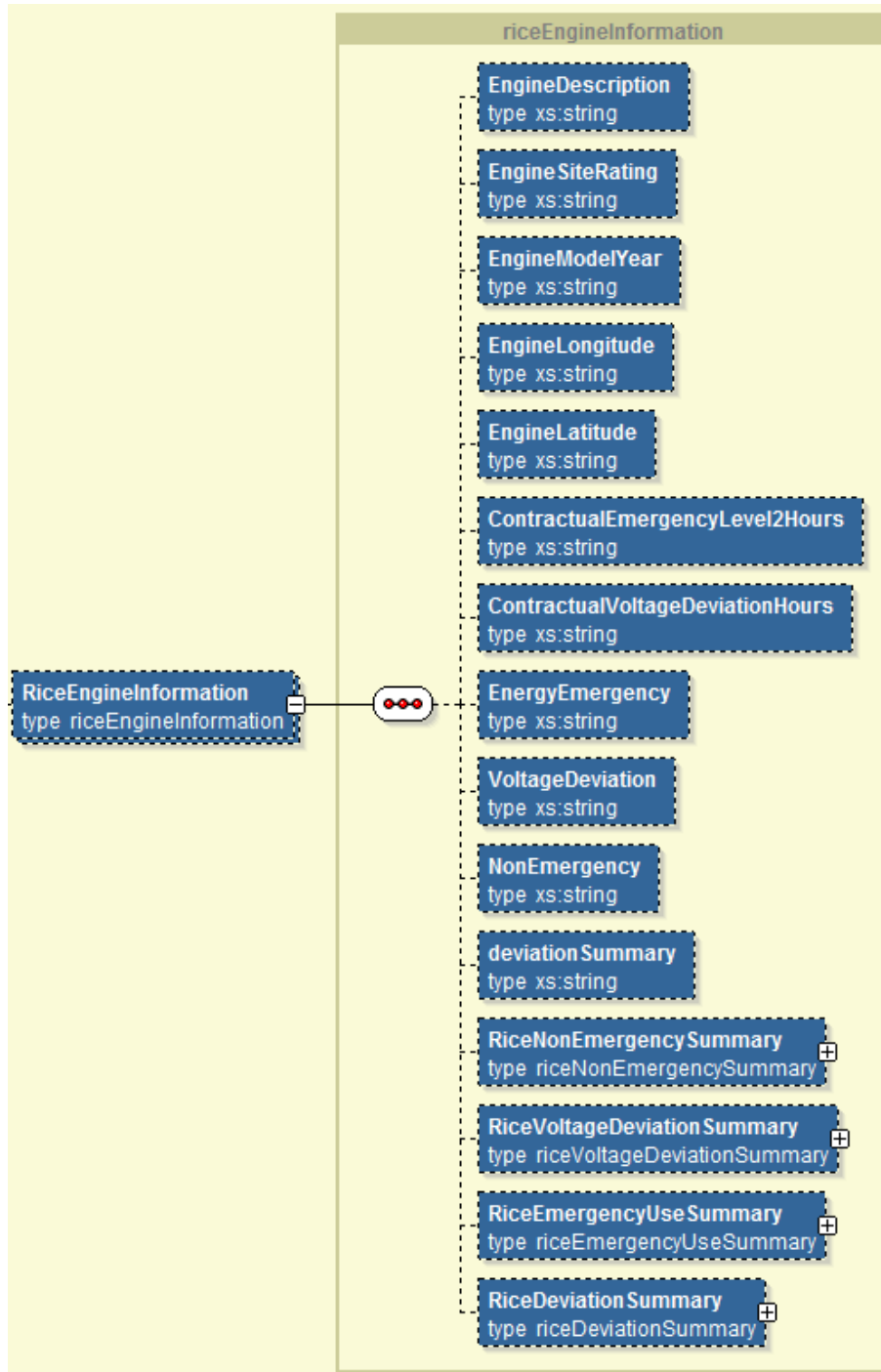

Engine Description

Element Name: `EngineDescription`

Element Description: Description of the applicable engine.

Engine Site Rating

Element Name: EngineSiteRating

Element Description: The manufacture's nameplate brake horsepower rating.

Engine Model Year

Element Name: EngineModelYear

Element Description: Model year of the applicable engine.

Engine Longitude

Element Name: EngineLongitude

Element Description: Longitude of the engine. The value must be at least five decimal places in precision.

Engine Latitude

Element Name: EngineLatitude

Element Description: Latitude of the engine. The value must be a least five decimal places in precision.

Contractual Emergency Level 2 Hours

Element Name: ContractualEmergencyLevel2Hours

Element Description: Hours the engine is contractually obligated to be available for the purpose specified in §63.6640(f)(2)(ii).

Contractual Voltage Deviation Hours

Element Name: ContractualVoltageDeviationHours

Element Description: Hours the engine is contractually obligated to be available for the purpose specified in §63.6640(f)(2)(iii).

Non-Emergency

Element Name: NonEmergency

Element Description: Whether or not the engine was used for the purpose specified in §63.6640(f)(4)(ii): 50 hours per year for non-emergency situations.

Voltage Deviation

Element Name: VoltageDeviation

Element Description: Whether or not the engine was used for the purpose specified in §63.6440(f)(2)(iii): Voltage deviation or frequency of 5% or greater below standard voltage or frequency.

Energy Emergency

Element Name: EnergyEmergency

Element Description: Whether or not the engine was used for the purpose specified in §63.6640(f)(2)(ii): Energy Emergency Level 2.

Deviation Summary

Element Name: deviationSummary

Element Description: Whether or not there were deviations from the fuel requirements in §63.6604.

Rice Engine Information Complex Child Elements

- Rice Non-Emergency Summary
- Rice Voltage Deviation Summary
- Rice Emergency Use Summary
- Rice Deviation Summary

2.29 Rice Non-Emergency Summary

Rice Non-Emergency Summary

Element Name: RiceNonEmergencySummary

Element Description: Containing element for RICE Non-Emergency Summary information.

Exhibit 2-31 Rice Non-Emergency Summary XML Element

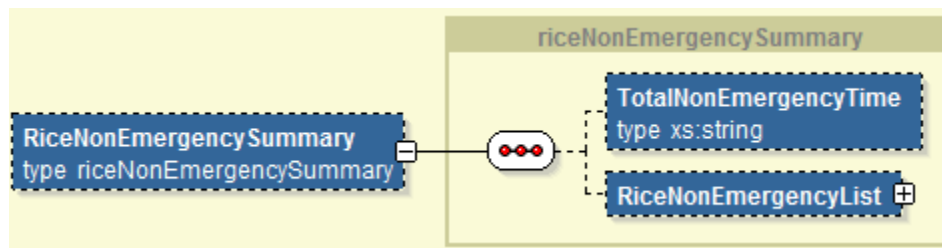

Total Non-Emergency Time

Element Name: TotalNonEmergencyTime

Element Description: Total time that the engine was used for the purpose specified in §63.6640(f)(4)(ii): 50 hours per year for non-emergency situations. This field will be auto-populated, if needed, upon form creation. It does not need to be included in an XML upload.

Rice Non-Emergency Summary Complex Child Elements

- Rice Non-Emergency List

2.30 Rice Non-Emergency List

Rice Non-Emergency List

Element Name: `RiceNonEmergencyList`

Element Description: Containing element for the occurrences the engine was used for the purpose specified in §63.6640(f)(4)(ii): 50 hours per year for non-emergency situations.

Exhibit 2-32 Rice Non-Emergency List XML Element

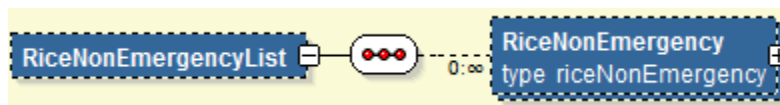

Rice Non-Emergency List Complex Child Elements

- Rice Non-Emergency

2.31 Rice Non-Emergency

Rice Non-Emergency

Element Name: `RiceNonEmergency`

Element Description: Containing element for information regarding the occurrences the engine was used for the purpose specified in §63.6640(f)(4)(ii): 50 hours per year for non-emergency situations. This element is repeatable.

Exhibit 2-33 Rice Non-Emergency XML Element

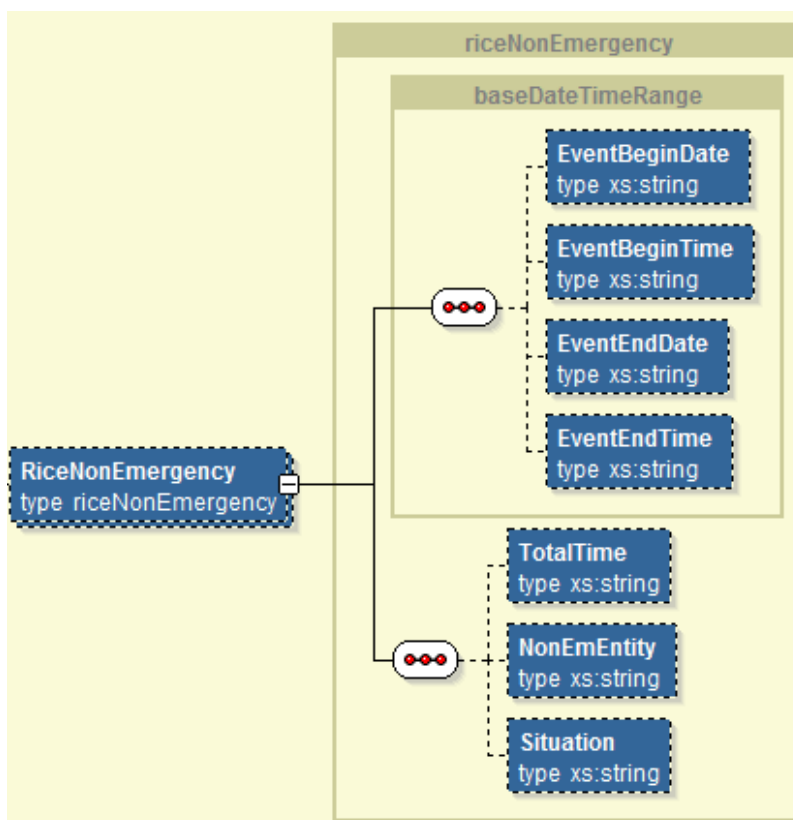

Event Begin Date

Element Name: `EventBeginDate`

Element Description: The beginning date for this occurrence of the engine being used for the purpose specified in §63.6640(f)(4)(ii): 50 hours per year for non-emergency situations.

Event Begin Time

Element Name: `EventBeginTime`

Element Description: The beginning time for this occurrence of the engine being used for the purpose specified in §63.6640(f)(4)(ii): 50 hours per year for non-emergency situations.

Event End Date

Element Name: `EventEndDate`

Element Description: The ending date for this occurrence of the engine being used for the purpose specified in §63.6640(f)(4)(ii): 50 hours per year for non-emergency situations.

Event End Time

Element Name: `EventEndTime`

Element Description: The ending time for this occurrence of the engine being used for the purpose specified in §63.6640(f)(4)(ii): 50 hours per year for non-emergency situations.

Total Time

Element Name: *TotalTime*

Element Description: The total elapsed time (in hours) for this occurrence of the engine being used for the purpose specified in §63.6640(f)(4)(ii): 50 hours per year for non-emergency situations.

Non Em Entity

Element Name: *NonEmEntity*

Element Description: The entity who dispatched the engine to be used for the purpose specified in §63.6640(f)(4)(ii): 50 hours per year for non-emergency situations.

Situation

Element Name: *Situation*

Element Description: The situation that necessitated the dispatch of the engine for the purpose specified in §63.6640(f)(4)(ii): 50 hours per year for non-emergency situations.

2.32 Rice Voltage Deviation Summary

Rice Voltage Deviation Summary

Element Name: *RiceVoltageDeviationSummary*

Element Description: Containing element for RICE Voltage Deviation Summary information.

Exhibit 2-34 Rice Voltage Deviation Summary XML Element

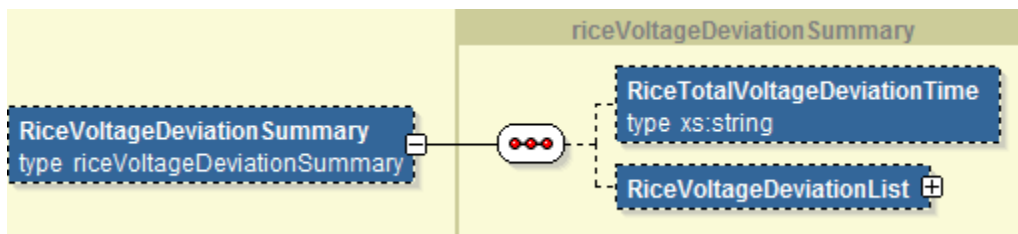

Rice Total Voltage Deviation Time

Element Name: *RiceTotalVoltageDeviationTime*

Element Description: Total time that the engine was used for the purpose specified in §63.6640(f)(2)(iii). This field will be auto-populated, if needed, upon form creation. It does not need to be included in an XML upload. This element is repeatable.

Rice Voltage Deviation Summary Complex Child Elements

- Rice Voltage Deviation List

2.33 Rice Voltage Deviation List

Rice Voltage Deviation List

Element Name: *RiceVoltageDeviationList*

Element Description: Containing element for the occurrences the engine was used for the purpose specified in §63.6640(f)(2)(iii).

Exhibit 2-35 Rice Voltage Deviation List XML Element

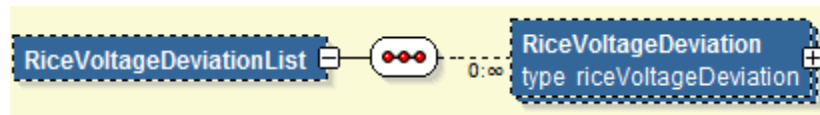

Rice Voltage Deviation List Complex Child Elements

- Rice Voltage Deviation

2.34 Rice Voltage Deviation

Rice Voltage Deviation

Element Name: *RiceVoltageDeviation*

Element Description: Containing element for information regarding the occurrences the engine was used for the purpose specified in §63.6640(f)(2)(iii). This element is repeatable.

Exhibit 2-36 Rice Voltage Deviation XML Element

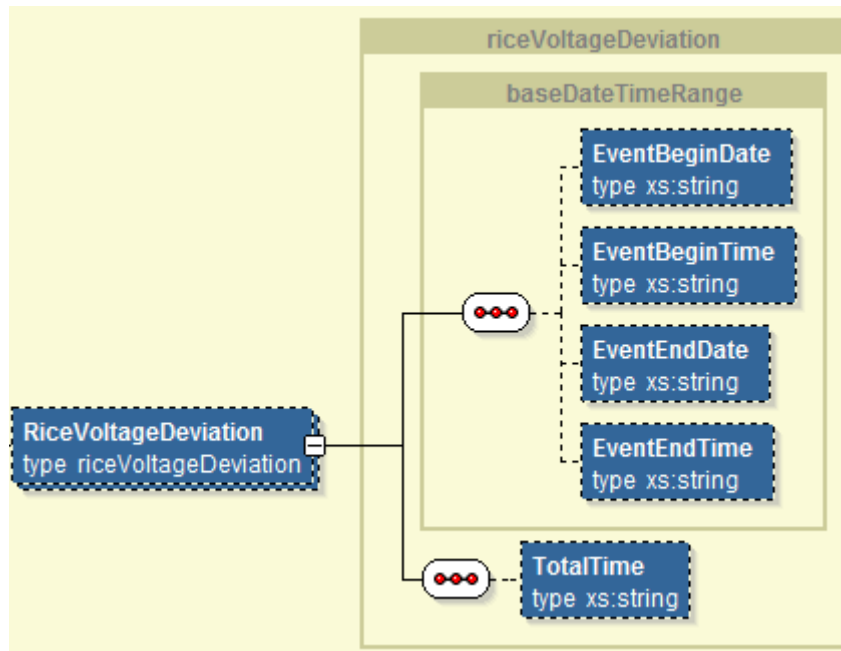

Event Begin Date

Element Name: *EventBeginDate*

Element Description: The beginning date for this occurrence of the engine being used for the purpose specified in §63.6640(f)(2)(iii).

Event Begin Time

Element Name: *EventBeginTime*

Element Description: The beginning time for this occurrence of the engine being used for the purpose specified in §63.6640(f)(2)(iii).

Event End Date

Element Name: *EventEndDate*

Element Description: The ending date for this occurrence of the engine being used for the purpose specified in §63.6640(f)(2)(iii).

Event End Time

Element Name: *EventEndTime*

Element Description: The ending time for this occurrence of the engine being used for the purpose specified in §63.6640(f)(2)(iii).

Total Time

Element Name: *TotalTime*

Element Description: The total elapsed time (in hours) for this occurrence of the engine being used for the purpose specified in §63.6640(f)(2)(iii).

2.35 Rice Emergency Use Summary

Rice Emergency Use Summary

Element Name: *RiceEmergencyUseSummary*

Element Description: Containing element for RICE Emergency Use Summary information.

Exhibit 2-37 Rice Emergency Use Summary XML Element

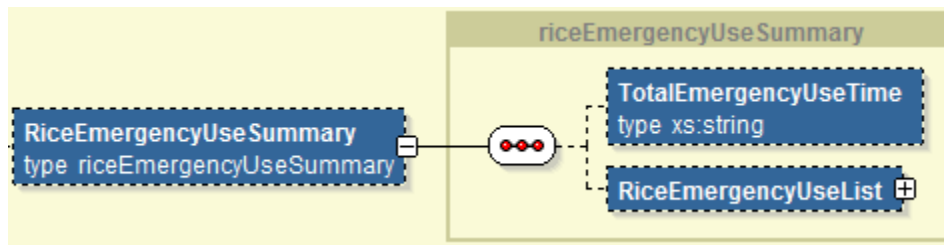

Total Emergency Use Time

Element Name: *TotalEmergencyUseTime*

Element Description: Total time that the engine was used for the purpose specified in §63.6640(f)(2)(ii): Energy Emergency Level 2. This field will be auto-populated, if needed, upon form creation. It does not need to be included in an XML upload.

Rice Emergency Use Summary Complex Child Elements

- Rice Emergency Use List

2.36 Rice Emergency Use List

Rice Emergency Use List

Element Name: *RiceEmergencyUseList*

Element Description: Containing element for occurrences the engine was used for the purpose specified in §63.6640(f)(2)(ii): Energy Emergency Level 2.

Exhibit 2-38 Rice Emergency Use List XML Element

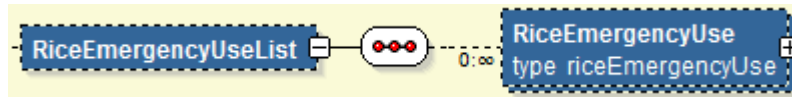

Rice Emergency Use List Complex Child Elements

- Rice Emergency Use

2.37 Rice Emergency Use

Rice Emergency Use

Element Name: *RiceEmergencyUse*

Element Description: Containing element for information regarding occurrences the engine was used for the purpose specified in §63.6640(f)(2)(ii): Energy Emergency Level 2. This element is repeatable.

Exhibit 2-39 Rice Emergency Use XML Element

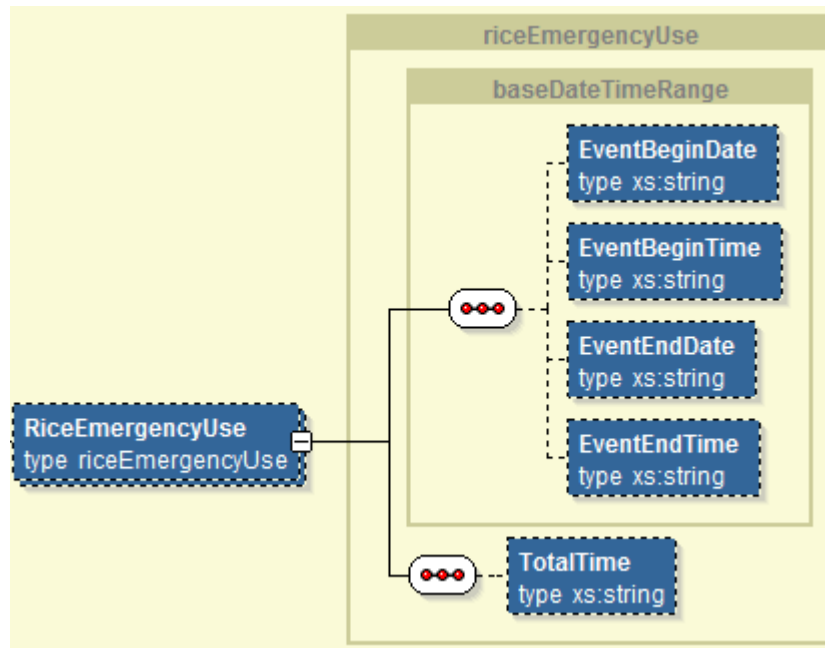

Event Begin Date

Element Name: *EventBeginDate*

Element Description: The beginning date for this occurrence of the engine being used for the purpose specified in §63.6640(f)(2)(ii): Energy Emergency Level 2.

Event Begin Time

Element Name: `EventBeginTime`

Element Description: The beginning time for this occurrence of the engine being used for the purpose specified in §63.6640(f)(2)(ii): Energy Emergency Level 2.

Event End Date

Element Name: `EventEndDate`

Element Description: The ending date for this occurrence of the engine being used for the purpose specified in §63.6640(f)(2)(ii): Energy Emergency Level 2.

Event End Time

Element Name: `EventEndTime`

Element Description: The ending time for this occurrence of the engine being used for the purpose specified in §63.6640(f)(2)(ii): Energy Emergency Level 2.

Total Time

Element Name: `TotalTime`

Element Description: The total elapsed time (in hours) for this occurrence of the engine being used for the purpose specified in §63.6640(f)(2)(ii): Energy Emergency Level 2.

2.38 Rice Deviation Summary

Rice Deviation Summary

Element Name: `RiceDeviationSummary`

Element Description: Containing element for RICE Deviation Summary information.

Exhibit 2-40 Rice Deviation Summary XML Element

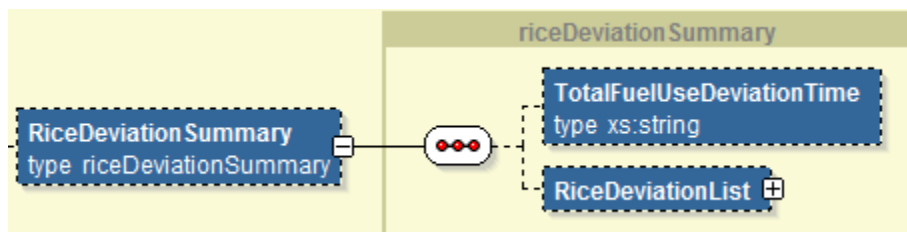

Total Fuel Use Deviation Time

Element Name: *TotalFuelUseDeviationTime*

Element Description: Total time that the engine deviated from fuel use requirements in §63.6604. This field will be auto-populated, if needed, upon form creation. It does not need to be included in an XML upload.

Rice Deviation Summary Complex Child Elements

- Rice Deviation List

2.39 Rice Deviation List

Rice Deviation List

Element Name: *RiceDeviationList*

Element Description: Containing element for occurrences of deviations from fuel use requirements in §63.6604.

Exhibit 2-41 Rice Deviation List XML Element

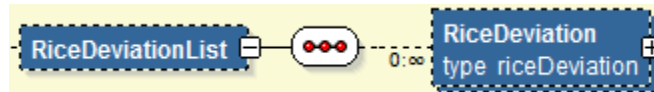

Rice Deviation List Complex Child Elements

- Rice Deviation

2.40 Rice Deviation

Rice Deviation

Element Name: *RiceDeviation*

Element Description: Containing element for information regarding occurrences of deviations from fuel use requirements in §63.6604. This element is repeatable.

Exhibit 2-42 Rice Deviation XML Element

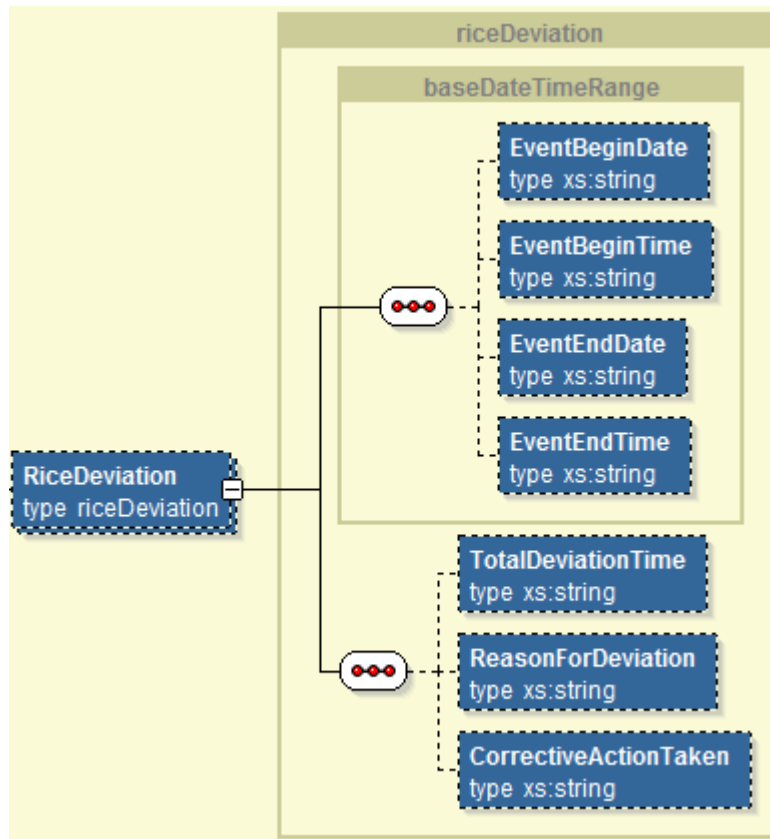

Event Begin Date

Element Name: *EventBeginDate*

Element Description: The beginning date for this occurrence of a deviation from the fuel requirements in §63.6604.

Event Begin Time

Element Name: *EventBeginTime*

Element Description: The beginning time for this occurrence of a deviation from the fuel requirements in §63.6604.

Event End Date

Element Name: *EventEndDate*

Element Description: The ending date for this occurrence a deviation from the fuel requirements in §63.6604.

Event End Time

Element Name: *EventEndTime*

Element Description: The ending time for this occurrence of a deviation from the fuel requirements in §63.6604.

Total Deviation Time

Element Name: *TotalDeviationTime*

Element Description: The total elapsed time (in hours) of this occurrence of deviation from the fuel requirements in §63.6604.

Reason For Deviation

Element Name: *ReasonForDeviation*

Element Description: The reason for this occurrence of deviation from the fuel requirements in §63.6604.

Corrective Action Taken

Element Name: *CorrectiveActionTaken*

Element Description: Action taken to correct this occurrence of deviation from the fuel requirements in §63.6604.

3 Appendix A: Reports Currently Configured for XML Upload

Part	Subpart	Report Types
60 – Standards of Performance for New Stationary Sources	Da - Standards of Performance for Electric Utility Steam Generating Units	Air Emissions Report
	III - Standards of Performance for Stationary Compression Ignition Internal Combustion Engines	Air Emissions Report
	JJJJ - Standards of Performance for Stationary Spark Ignition Internal Combustion Engines	Air Emissions Report
63 - National Emission Standards for Hazardous Air Pollutants For Source Categories	DDDDD - National Emission Standards for Hazardous Air Pollutants for Industrial, Commercial, and Institutional Boilers and Process Heaters	Air Emissions Report
	JJJJJ - National Emission Standards for Hazardous Air Pollutants for Industrial, Commercial, and Institutional Boilers Area Sources	Notification of Compliance Status
	LLL - National Emission Standards for Hazardous Air Pollutants From the Portland Cement Manufacturing Industry	Air Emissions Report
	ZZZZ - National Emissions Standards for Hazardous Air Pollutants for Stationary Reciprocating Internal Combustion Engines	Air Emissions Report

4 Appendix B: Terms and Acronyms

Term / Acronym	Definition
AER	Air Emissions Report
CDX	Central Data Exchange
CEDRI	Compliance and Emissions Data Reporting Interface
Complex Element	An element that contains other elements.
EPA	Environmental Protection Agency
OAR	Office of Air and Radiation
RICE	Reciprocating Internal Combustion Engine
XML	EXtensible Markup Language
XSD	XML Schema Definition