



AR-1411

780 N. Commercial Street  
P.O. Box 330  
Manchester, NH 03105—330

**Linda T. Landis**  
Senior Counsel, Legal Department  
603-634-2700

Linda.Landis@eversource.com

January 27, 2016

**BY EMAIL AND OVERNIGHT FEDERAL EXPRESS DELIVERY**

Mr. Michael Cobb, Environmental Engineer  
U. S. Environmental Protection Agency – Region 1  
Office of Ecosystem Protection  
5 Post Office Square, Suite 100 (OEP06-1)  
Boston, Massachusetts 02109-3912

**Comments of Public Service Company of New Hampshire  
on EPA's Draft National Pollutant Discharge Elimination  
System Permit No. NH 0001473 for Schiller Station**

Dear Mr. Cobb:

Enclosed please find the "Comments of Public Service Company of New Hampshire on Region 1's Draft National Pollutant Discharge Elimination System Permit No. NH 0001473 for Schiller Station."

These comments are being filed by Public Service Company of New Hampshire (d/b/a Eversource Energy) ("PSNH") in accordance with Section 17 of the Fact Sheet dated September 29, 2015, issued by the U.S. Environmental Protection Agency, Region 1, and the Notice of Extension of Public Comment Period, dated October 30, 2015, extending the comment period until January 27, 2016.

PSNH appreciates the opportunity to provide these comments for EPA's consideration and welcomes any follow-up discussion with the agency. We take great pride in our generating stations and the fine environmental records of compliance and initiatives we have established over the course of decades of operation.

Please do not hesitate to call me if you have any questions or concerns.

Yours truly,

A handwritten signature in black ink that reads "Linda T. Landis". The signature is written in a cursive, slightly slanted style.

Linda T. Landis  
Senior Counsel

cc: William H. Smagula, P.E., Vice President Generation – PSNH  
Robert A. Bersak, Esq., Chief Regulatory Counsel  
Mark A. Stein, Esq., EPA  
Spencer M. Taylor, Esq., Balch & Bingham  
R. Bruce Barze, Jr., Esq., Balch & Bingham  
Robert P. Fowler, Esq., Balch & Bingham  
Thomas G. DeLawrence, Esq., Balch & Bingham  
Richard Despina, Station Manager – Schiller Station  
Elizabeth H. Tillotson, Manager – Regulatory and Environmental – PSNH  
Allan G. Palmer, Senior Engineer - PSNH

**Comments of Public Service Company  
of New Hampshire  
(d/b/a Eversource Energy)**

**on**

**Region 1's Draft National Pollutant Discharge  
Elimination System**

**Permit No. NH0001473**

**for**

**Schiller Station**



**Submitted to Region 1 of the U.S. Environmental Protection Agency**

**January 27, 2016**

## EXECUTIVE SUMMARY

The draft National Pollutant Discharge Elimination System (“NPDES”) permit for Public Service Company of New Hampshire’s (d/b/a Eversource Energy) (“PSNH”) Schiller Station, Permit No. NH0001473 (“Draft Permit”), issued by Region 1 of the Environmental Protection Agency (“Region 1”), cannot be issued as proposed.

Although the agency correctly determined that PSNH is entitled to a continuation of its Clean Water Act (“CWA”) § 316(a) variance based on PSNH’s demonstration that Schiller Station’s thermal discharges have not caused any appreciable harm to the balanced indigenous population (“BIP”) of the Piscataqua River, many of the agency’s other determinations in the Draft Permit are unsupported, unfounded, and must be revised. As detailed in the comments that follow, Region 1 was arbitrary and capricious in establishing certain proposed permit limits and requirements for Schiller Station. The Draft Permit as issued fails to comply with the applicable law and regulations. Any final NPDES permit for Schiller Station must address the issues raised in these comments. Specifically:

- Although Region 1 correctly determined that PSNH’s existing § 316(a) variance for its thermal discharges at Schiller Station should be continued, the agency should grant PSNH’s request to increase the effluent temperature limit to 100°F and “Delta-T” limit from 25°F to 30°F.
- Region 1’s determination that the installation of fine-mesh cylindrical wedgewire (“CWW”) screens for the cooling water intake structures (“CWISs”) at Schiller Station is necessary under CWA § 316(b) has no factual basis, lacks legal support, and is thus arbitrary and capricious.
- Region 1’s proposed technologies to address entrainment are arbitrary and capricious and must be revised before the agency issues the permit as final. These technologies are not necessary at Schiller Station for several reasons:
  - (1) Region 1 has not determined, and in fact cannot determine, that the CWISs at Schiller Station cause an adverse environmental impact (“AEI”) to the aquatic ecosystems of the Piscataqua River.
  - (2) The average actual intake flow (“AIF”) of the CWISs is 72.4 million gallons per day (“MGD”), which is well below the 125 MGD AIF compliance threshold U.S. Environmental Protection Agency (“EPA”) established less than two years ago in the final § 316(b) rule. This policy threshold was established by the agency to allow permitting authorities to focus primarily on larger facilities whose water withdrawals are more likely to pose a significant risk of AEI due to entrainment. The final § 316(b) rule presupposes that a facility withdrawing less than 125 MGD AIF presents little or no potential adverse impact to aquatic organisms. Schiller Station is no exception.
  - (3) In fact, entrainment at the facility is *de minimis*. Average water withdrawals from the facility amount to only 0.0018 percent of the peak Piscataqua River

withdrawal zone flow during each tidal cycle. It is therefore not possible for the CWIS operations at Schiller Station to be causing any environmental impact that is adverse to the aquatic ecosystem within the Piscataqua River.

- Given the determination that controls for entrainment are not warranted, the Best Technology Available (“BTA”) for the CWISs at Schiller Station is dictated by considerations of impingement mortality. Modified traveling water screens with an upgraded fish return system constitute BTA for the CWISs at Schiller Station. These technologies have a proven track record of success in reducing impingement mortality, will be comparatively easy to install, and will permit the facility to comply with the final § 316(b) rule within a shorter time period. Plus, they are one of seven “pre-approved” control technologies from which a facility may choose to satisfy the BTA impingement mortality standard.
- If Region 1 erroneously rejects PSNH’s well-reasoned conclusions that technologies for entrainment are not necessary at Schiller Station to satisfy the BTA standard, the agency must allow the company to submit additional analyses that will provide Region 1 at least the minimum amount of information the agency would need to make a reasoned and legally defensible BTA entrainment determination. The final § 316(b) rule requires facilities above the aforementioned 125 MGD AIF compliance threshold to complete analyses of the sort PSNH would seek to submit to Region 1 if the agency rejects the company’s position on the application of entrainment at Schiller Station. If Region 1 continues to require fine-mesh CWW screens at Schiller Station, the agency must allow the company to test the biological effectiveness of CWW screens with slot-widths of 2.0 mm, 3.0 mm, and larger in light of the better understanding of the efficacy of these screens developed in recent years due to quantification of the hydraulic bypass and larval avoidance phenomena. In addition, Region 1’s detailed schedule for the design, permitting, and construction requirements for the installation of the fine-mesh CWW screens at Schiller Station must be significantly revised because it cannot be implemented as proposed.
- A June outage requirement for Unit 5 at Schiller Station is not a regulatory option and in any case not necessary to satisfy the § 316(b) BTA standard. PSNH notified Region 1 of this fact in 2008, which the agency acknowledged in its Fact Sheet to the Draft Permit, but ultimately ignored without explanation. Even if it were possible, it is not economically prudent due to the fact that it would have significant costs for PSNH’s customers due to incremental energy costs, among other reasons.
- Region 1’s best available technology (“BAT”) effluent limitations established pursuant to the agency’s best professional judgment (“BPJ”) authority for nonchemical metal cleaning wastes (“NCMCWs”) generated at Schiller Station are arbitrary and capricious.
- NCMCWs should continue to be classified as a low volume waste in the new final permit for Schiller Station in accordance with industry guidance commonly referred to as the Jordan Memorandum. Region 1 failed to even consider how NCMCWs have been historically addressed at Schiller Station, which is specifically required by EPA’s new

final steam effluent guidelines before a permitting authority may establish BPJ-based effluent limitations for the waste stream.

- Region 1's BAT analysis is arbitrary and capricious, as well. The agency does not possess essential data regarding the makeup of NCMCW discharges at Schiller Station. Furthermore, Region 1 failed to adequately consider the changes in current processes employed at Schiller Station, as well as the costs necessary to achieve these changes, that would be required to comply with new effluent limitations. Without these foundational facts, the agency has no way of knowing whether its proposed effluent limitations are operationally feasible and/or cost-effective. In fact, they are not. NCMCWs should continue to be treated as low volume wastes in the new final permit issued for Schiller Station. Any other determination, without these critical considerations, is arbitrary and capricious.
- Various other requirements within the Draft Permit are arbitrary and capricious and require revision. The entirety of Parts I.B. and I.C. of the Draft Permit should be deleted because Schiller Station already maintains a stormwater pollution prevention plan ("SWPPP") and has obtained coverage under Multi-Sector General Permit ("MSGP") NHR053208 to manage all stormwater discharges related to the facility. Many new effluent limitations and monitoring requirements (including frequency of monitoring) inserted in the Draft Permit also warrant revision because they create an unnecessary administrative burden on PSNH and result in the expenditure of needless dollars with no ultimate improvement to the environment.

Region 1 must consider these comments and amend the proposed permit accordingly. Failure to do so will result in a permit that is arbitrary and capricious and that has no support in the record or basis in law.

**TABLE OF CONTENTS**

I. INTRODUCTION .....1

II. GENERAL BACKGROUND.....4

    A. Public Service Company of New Hampshire .....4

    B. PSNH’s Schiller Station.....5

    C. Piscataqua River.....8

III. CURRENT NPDES PERMIT.....9

IV. LEGAL ISSUES AND STANDARDS OF REVIEW .....9

V. PSNH’s COMMENTS ON THE DRAFT PERMIT .....12

    A. Region 1 Correctly Determined that PSNH’s Existing 316(a) Variance  
    Should be Continued in the Renewed Final Permit .....14

    B. EPA’s § 316(b) BTA Determination is Arbitrary and Capricious.....20

        1. Legal background.....23

        2. Technologies to address entrainment are not necessary at Schiller  
        Station because the existing CWISs at the facility are not causing any  
        AEI to the Piscataqua River .....33

            a. Region 1 cannot impose technologies to further minimize  
            entrainment at Schiller Station without first establishing  
            environmental impact that is adverse to the Piscataqua River.....33

            b. AIF at the facility is well below the 125 MGD compliance  
            threshold set out in the final § 316(b) rule .....36

            c. Entrainment at Schiller Station is *de minimis* .....40

        3. Modified traveling water screens with an upgraded fish return system  
        constitute BTA for the CWISs at Schiller Station .....47

        4. Additional evaluations and data must be provided to Region 1 to  
        adequately evaluate entrainment at Schiller Station if the agency  
        erroneously requires entrainment compliance .....51

            a. Entrainment Characterization Study .....54

            b. Comprehensive Technical Feasibility and Cost Evaluation  
            Study .....55

                a. Benefits Valuation Study .....60

                b. Non-water Quality and Other Environmental Impacts Study.....62

        5. At the very least, Region 1 must permit PSNH to evaluate CWW  
        screens with larger slot-widths to reflect current research and  
        understanding about the effectiveness of those screens.....64

        6. The Draft Permit’s June outage requirement for Unit 5 is arbitrary and  
        capricious .....67

        7. An emergency bypass for the fine-mesh CWW screens is imperative  
        if PSNH is ultimately compelled to install the technology at Schiller  
        Station .....72

8.	The design, permitting, and construction requirements of Region 1’s flawed BTA determination are not reasonable .....	75
C.	Region 1’s Proposed Regulation of Nonchemical Metal Cleaning Wastes is Arbitrary and Capricious and Ignores the Requirements of EPA’s Final NELGs .....	78
1.	Relevant legal background.....	79
2.	NCMCWs have been and should continue to be classified as a low volume waste at Schiller Station in accordance with the Jordan Memorandum.....	85
a.	The historical permitting record at Schiller Station.....	85
b.	As recently as 2013, EPA specifically determined that iron and copper effluent limitations apply at Schiller Station only during boiler chemical cleaning operations .....	89
3.	Region 1’s BAT analysis and administrative record are wholly inadequate even if the agency erroneously refuses to continue to classify NCMCWs as a low volume waste .....	91
a.	Relevant legal background.....	92
a.	Region 1’s definition of “NCMCWs” is vague and seemingly too broad .....	95
b.	There is no NCMCW discharge data in the current administrative record .....	97
c.	Requiring changes in current plant processes to segregate and treat NCMCWs would be difficult, if not impossible.....	101
d.	Use of a combined waste stream formula will not work at Schiller Station.....	104
e.	Region 1 did not even attempt to evaluate the cost of its proposed regulation of NCMCWs .....	106
4.	If Region 1 erroneously elects to impose iron and copper limits on NCMCWs, it should allow PSNH sufficient time to comply .....	110
D.	Miscellaneous Issues with the Draft Permit.....	111
1.	Outfalls 002, 003, and 004.....	111
2.	Outfall 006 .....	112
3.	Outfall 11 .....	114
4.	Outfall 018 .....	116
5.	Outfalls 020 and 021 .....	117
6.	Outfall 023 .....	117
7.	Parts I.B. and I.C. of the Draft Permit .....	117
VI.	CONCLUSION.....	119



## **ABBREVIATIONS AND DEFINITIONS**

<b>AEI</b>	Adverse Environmental Impact
<b>AIF</b>	Actual Intake Flow
<b>APA</b>	Administrative Procedure Act
<b>BAT</b>	Best Available Control Technology
<b>BIP</b>	Balanced, Indigenous Population
<b>BPJ</b>	Best Professional Judgment
<b>BPT</b>	Best Practicable Control Technology
<b>BTA</b>	Best Technology Available
<b>CSO</b>	Capacity Supply Obligation
<b>CFS</b>	Cubic Feet per Second
<b>CWA</b>	Clean Water Act
<b>CWIS</b>	Cooling Water Intake Structure
<b>CWW</b>	Cylindrical Wedgewire
<b>DIF</b>	Design Intake Flow
<b>EAB</b>	Environmental Appeals Board
<b>EPA</b>	U.S. Environmental Protection Agency
<b>EPRI</b>	Electric Power Research Institute
<b>ERG</b>	Eastern Research Group, EPA Contractor
<b>Fact Sheet</b>	U.S. EPA Region 1, Fact Sheet to the Draft National Pollutant Discharge Elimination System Permit to Discharge to Waters of the United States Pursuant to the Clean Water Act, Permit No. NH0001473, PSNH Schiller Station (Sept. 30, 2015)
<b>FCM</b>	Forward Capacity Market
<b>ICR</b>	EPA Information Collection Request
<b>ISO-NE</b>	New England Independent Systems Operator

<b>Jordan Memorandum</b>	Memorandum from J. William Jordan, Chemical Engineer, Permit Assistance & Evaluation Section, Office of Enforcement, EPA Headquarters, to Bruce P. Smith, Biologist, Enforcement Division, EPA Region III (June 17, 1975)
<b>MGD</b>	Million Gallons per Day
<b>MSGP</b>	Multi-Sector General Permit
<b>MSL</b>	Mean Sea Level
<b>MW</b>	Megawatt
<b>NCMCW</b>	Nonchemical Metal Cleaning Waste
<b>NELG</b>	National Effluent Limitations and Guidelines
<b>NPDES</b>	National Pollutant Discharge Elimination System
<b>Proposed 316(b) TDD</b>	Technical Development Document for the Proposed Section 316(b) Phase II Existing Facilities Rule, Dock. ID EPA-HQ-OW-2008-0667-1282, at 7-7 (Mar. 28, 2011)
<b>PSNH</b>	Public Service Company of New Hampshire (d/b/a Eversource Energy)
<b>REC</b>	Renewable Energy Credit
<b>SCR</b>	Selective Catalytic Reduction
<b>SWPPP</b>	Stormwater Pollution Prevention Plan
<b>T&amp;E</b>	Threatened and Endangered Species
<b>TEMA</b>	Tubular Exchanger Manufacturer's Association
<b>TSS</b>	Total Suspended Solids
<b>UWAG</b>	Utility Water Act Group
<b>WWTP</b>	Wastewater Treatment Plant

## **EXHIBITS**

1. January 2016 PSNH Schiller Station Draft NPDES Permit Comments of Enercon Services, Inc. and Normandeau Associates, Inc.
2. February 12, 2010 Evaluation of Alternative Intake Technologies at Indian Point Units 2 & 3, prepared by Enercon Services, Inc.
3. June 17, 1975 Memorandum from J. William Jordan, Chemical Engineer, Permit Assistance & Evaluation Section, Office of Enforcement, EPA Headquarters, to Bruce P. Smith, Biologist, Enforcement Division, EPA Region III.
4. June 22, 1990 Fact Sheet for NPDES Permit No. NH0001473 for Schiller Station.
5. 1990 Response to Comments for NPDES Permit No. NH0001473 for Schiller Station.
6. Relevant excerpts of 1992 Fact Sheet for NPDES Permit No. NH0001465 for Merrimack Station.
7. Relevant excerpts of 2009 Fact Sheet for NPDES Permit No. NH0001465 for Merrimack Station.
8. Relevant excerpts of 1992 Response to Comments for NPDES Permit No. NH0001465 for Merrimack Station.

**Comments of Public Service Company of New Hampshire  
on  
Region 1's Draft National Pollutant Discharge Elimination System Permit  
No. NH0001473 for Schiller Station**

**I. INTRODUCTION**

PSNH submits these comments on the Draft Permit for Schiller Station issued by Region 1.<sup>1</sup> Region 1 correctly determined that the existing § 316(a) variance for the facility should be continued in the new final permit and PSNH commends the agency on this well-reasoned conclusion. Many of the other limits and requirements in the Draft Permit lack factual support in the record or basis in law, however, and must be revised in the final permit issued by the agency. Specifically, Region 1's § 316(b) BTA determination is arbitrary, capricious, and not in accordance with law inasmuch as it requires the installation of CWW screens with a slot-width of no greater than 0.8 mm and a June annual outage for Unit 5. Neither determination is supported by the existing administrative record, nor are the requirements necessary at Schiller Station to satisfy the § 316(b) legal standard.

Fine-mesh CWW screens were chosen as BTA for the CWISs at Schiller Station due to purported entrainment concerns. These concerns are unfounded. Entrainment at Schiller Station is *de minimis* and is not causing any environmental impact within the Piscataqua River that is adverse to the aquatic ecosystem. In fact, Region 1 expressly stated in its Fact Sheet to the Draft Permit that it has found "no evidence" that the CWISs at Schiller Station are impacting the waterbody. Technologies to address entrainment at Schiller Station are also unnecessary because the average 72.4 MGD AIF at the facility is one of the lowest within the industry and is far below the 125 MGD AIF entrainment policy threshold EPA established less than two years ago

---

<sup>1</sup> PSNH supports and adopts the January 2016 PSNH Schiller Station Draft NPDES Permit Comments jointly prepared by Enercon Services, Inc. ("Enercon"), and Normandeau Associates, Inc. ("Normandeau"), attached hereto as Exhibit 1. Hereinafter these comments are referred to as the "2016 Enercon-Normandeau Comments."

to allow the agency to focus on facilities that withdraw larger quantities of water and, thus, have the highest likelihood of causing adverse impacts. Instead, modified traveling water screens with an upgraded fish return system constitute BTA for the CWISs at Schiller Station.

Should Region 1 erroneously reject this well-founded BTA determination, PSNH must be permitted to submit additional entrainment data and analyses before the agency renders its BTA determination. The additional data and analyses would be substantially similar to the information facilities with an average withdrawal volume in excess of 125 MGD AIF are required to submit to their respective permit writers, in accordance with the final § 316(b) rule, to ensure the permit writer can make an informed BTA determination. This additional information would show entrainment controls are not necessary at Schiller Station. And, even if it does not, PSNH should be allowed to test larger slot-width CWW screens than the maximum 0.8 mm slot-width Region 1 has currently prescribed due to additional discoveries in recent years that demonstrate larger slot-width CWW screens are as effective at reducing entrainment as smaller ones in certain ecological environments. Moreover, if PSNH is ultimately required to install CWW screens at Schiller Station, the proposed timeline for the design, permitting, and construction of them must be altered because the current timeframe is unreasonable.

The June outage requirement for Unit 5 must be removed from the final permit because a June outage is not possible and, even if it were, does not make economic sense for PSNH and its customers. If PSNH is ultimately required to install CWW screens at Schiller Station, no accompanying operational measure is warranted to satisfy the § 316(b) BTA standard.

Region 1's proposed regulation of NCMCWs at Schiller Station is arbitrary and capricious, as well. NCMCWs generated by each unit at Schiller Station have historically been, and continue to be, treated as a low volume waste exempted from any iron and copper effluent

limitations in accordance with the Jordan Memorandum. EPA (with assistance from Region 1) recently confirmed this fact as part of the promulgation of the new NELGs. Furthermore, an evaluation of how NCMCWs have previously been addressed at the facility is mandated by this recent rulemaking. Region 1 failed to consider the historical permitting record at Schiller Station before establishing BPJ-based BAT limits for the waste stream, which renders the agency's proposed analysis and corresponding effluent limitations incomplete, arbitrary, capricious, and not in accordance with law.

Region 1's BAT analysis for establishing BPJ-based effluent limitations for NCMCWs at Schiller Station is likewise arbitrary and capricious. The agency has no data of isolated NCMCWs generated at Schiller Station, an analysis of which is fundamental to any legally defensible BAT determination. Region 1's BAT determination is also insufficient because it grossly underestimates the significant costs and/or logistical problems that regulation of NCMCWs in this manner would present at Schiller Station. Section 304(b)(2)(B) of the CWA and EPA's regulations require Region 1 to take these and other factors into consideration when adopting site-specific effluent limitations. A thorough BAT analysis, coupled with a review of the historical permitting record, should lead Region 1 to conclude that the NCMCW waste stream must continue to be classified as a low volume waste in the new final permit for Schiller Station.

Region 1's final NPDES permit for Schiller Station must take into consideration the issues raised in these comments and contain reasonable limits and requirements established through a lawful and proper process based upon substantive facts.

## II. GENERAL BACKGROUND

### A. Public Service Company of New Hampshire

PSNH is a public utility headquartered in Manchester, New Hampshire, and is the largest power company in the State of New Hampshire, with more than 498,000 retail distribution customers served throughout the state in a 5,630-square-mile area that encompasses more than 200 New Hampshire communities. PSNH generates approximately 1,200 megawatts (“MW”) of electricity from three fossil-fueled power plants, nine hydroelectric power plants, and a biomass facility. PSNH’s generation fleet also includes five fossil-fueled combustion turbine “peaking units,” each with nominal 20 MW nameplate generating capacity that contribute to regional reliability and operate only in times of high demand or high prices.<sup>2</sup> Cumulatively, PSNH has invested in excess of \$80 million in environmental initiatives at Schiller Station since 2006, significantly reducing the Station’s environmental footprint. Schiller Station currently meets all state and federal clean air requirements. PSNH has received numerous awards from the EPA and other agencies and organizations for its environmental and public service initiatives.<sup>3</sup>

---

<sup>2</sup> Additionally, PSNH has contracts to purchase renewable power from various privately owned biomass and hydroelectric facilities, as well as New Hampshire’s first commercial-scale wind farm in Lempster, New Hampshire.

<sup>3</sup> For instance, PSNH has received the following: EPA “Environmental Merit Award,” 1996 (recognizing PSNH’s demonstrated commitment and significant contributions to the environment); “New Hampshire Governor’s Award for Pollution Prevention,” 1996 (awarded for installing the SCR at Merrimack Station); U.S. EPA “Certificate of Appreciation,” 1999 (recognizing Merrimack’s NOx emissions reduction project); “Lung Champion Award,” 2003 (awarded by the American Lung Association of New Hampshire); “Secretary of Defense Employer Support Freedom Award,” 2002 (awarded by the U.S. Department of Defense); U.S. Department of Energy Grant For Mercury Reduction Research, 2007; “Breathe New Hampshire Award,” 2008 (recognizing exceptional commitment and support of Breathe New Hampshire); “Edison Electric Institute Common Goals Special Distinction-Environmental Partnerships Award,” (recognizing efforts to collaborate with government agencies and environmental groups to develop an ozone reduction strategy); Northern New England Concrete Promotion Assn.’s “Excellence in Concrete Award,” 2009; “Old Republic Insurance Safety Excellence During Construction,” 2011; “URS Presidents Award” for 1.2M Safe Manhours Worked, 2011; Power Magazine’s “Top Plants - Six Innovative Coal Fired Plants,” 2012 (pertaining to Merrimack Station); The EBC “Outstanding Environmental – Energy Technology Application Achievement Award,” 2013; “The International Green Apple Award for Outstanding Environmental Achievement,” 2013; ASCE-NH 2014 “Civil Engineering Achievement Award,” 2015.

**B. PSNH's Schiller Station**

Schiller Station, located in Portsmouth, New Hampshire, has a total electrical output of approximately 163 MW. It produces enough energy to supply tens of thousands of New Hampshire households. Schiller Station consists of three steam-electric generating units—Units 4, 5, and 6—along with one smaller, light fuel oil-fired peaking combustion turbine. Units 4, 5, and 6 each have a nameplate generating capacity of 48 MW. Units 4 and 6 are equipped with dual fuel boilers capable of firing either pulverized bituminous coal or #6 fuel oil. Unit 4 began operating in 1952. Unit 6 was placed in operation in 1957. Unit 5 began operating in 1955. In 2006, Unit 5 was repowered to burn clean wood chips for its primary fuel and is commonly referred to as the “Northern Wood Power Project.” The conversion has added more than \$380 million to the regional and local economies within the past nine years, as the facility has received greater than 150,000 deliveries of wood chips (weighing approximately 4.6 tons) from local foresters and has sustained 150-200 forestry-related jobs. The project has also earned state, regional, national, and international awards for its innovation and positive impacts to the environment.<sup>4</sup> It is touted as one of the cleanest boilers in New England and to date has generated more than 2.8 billion kilowatt hours of renewable energy to Eversource customers and the regional energy market.

Schiller Station is located on the southwestern bank of the Piscataqua River. The facility withdraws water from the waterbody to cool and condense steam produced in the facility's power production process. Schiller Station utilizes two once-through CWISs with a total design

---

<sup>4</sup> Specifically, the facility has won EPA's Clean Air Excellence Award, the N.H. Governor's Award for Pollution Prevention, the Green International Green Apple Award, the New Hampshire Timberland Owners Association's N.H. Outstanding Forest Industry Award, the Environmental Business Council of New England's Outstanding New Environmental/Energy Technology award, and the National Pollution Prevention Roundtable's Most Valuable Pollution Prevention Award.



intake flow (“DIF”) of 125.8 MGD.<sup>5</sup> One CWIS draws water from an intake tunnel that extends approximately 30 feet offshore from the north bulkhead (“Screen House #1) and provides cooling water to Unit 4. The other CWIS is located within the south bulkhead (“Screen House #2) and provides cooling water to Units 5 and 6.

Screen House #1 withdraws water from a 6.5-foot diameter tunnel located approximately two feet above the river bottom.<sup>6</sup> The river bottom is periodically maintained to preserve the two-foot elevation between the river bottom and the floor of the intake structure. The inlet is a concrete manifold equipped with a coarse bar rack designed to prevent large, submerged debris from entering the intake tunnel. Another fixed screen designed to prevent lobsters from entering the intake has been installed on the offshore intake, as well. To minimize environmental impact, water supplied to the two circulating water pumps that serve Unit 4 is equipped with one traveling water screen—a REX (Chain Belt Company) screen with 3/8-inch square copper wire mesh panels (basket segments). The screen is 5.5-feet wide and 28-feet high, and has 34 basket segments. It is rotated at least twice each day and often more frequently when there is significant debris in the Piscataqua River. A screenwash system consisting of pumps and associated piping and spray nozzles is used to keep the screen clean. The screenwash system uses five overlapping spray nozzles with 40 psi spray pressure to remove any aquatic organisms from the traveling water screen into the fish return trough that runs along the CWIS. The trough then funnels through a 14-inch diameter chute to discharge all aquatic organisms back to the Piscataqua River at an elevation of 4 feet above mean sea level (“MSL”).

---

<sup>5</sup> The average AIF is considerably less.

<sup>6</sup> There are two additional 6.5-foot diameter tunnels connected to Screen House #1 designed to provide cooling water to Unit 3, which is now retired. These two tunnels are not currently utilized by the facility.

Screen House #2 has a total of four circulating water pumps and four traveling water screens. The two pumps located on the north side of Screen House #2 supply cooling water to Unit 5, while the two pumps located on the south side of Screen House #2 supply cooling water to Unit 6. Each set of pumps withdraws water through forebays that are separated by a partition wall and protected by a set of bar racks with 4<sup>3</sup>/<sub>8</sub>-inch by 4-inch grating. The floor of Screen House #2 is at an elevation of 18 feet below MSL, and the deck is at an elevation of 10 feet above MSL. The river bottom elevation is 20 feet below MSL in the vicinity of the intake. Thus, the river bottom grade is approximately 2 feet below the floor of the intake, which provides a vertical barrier to the movement of bottom-oriented fish and shellfish into the CWIS. The river bottom in front of Screen House #2 is covered with rip rap to maintain the floor of the Screen House #2 CWIS at an elevation of 2 feet above the river bottom. The four traveling water screens designed to minimize impingement and entrainment for Screen House #2 are also REX (Chain Belt Company) screens with 3/8-inch square copper wire mesh panels (basket segments). Each screen is 5.5-feet wide and 29-feet high and is equipped with a screenwash system that is substantially similar to the one that services the screen for Screen House #1. The screens are rotated at least twice each day and often more frequently when there is significant debris in the Piscataqua River. The fish and debris return trough runs along the length of Screen House #2 and discharges to the river at an elevation of 8 feet above MSL.

PSNH's existing NPDES permit for Schiller Station allows it to discharge a maximum of 52.2 MGD of non-contact cooling water for Unit 4 into the Piscataqua River, not to exceed a monthly average of 43.5 MGD. Maximum and monthly average flows for non-contact cooling water utilized for Units 5 and 6 are each capped at 50.2 MGD. PSNH's current temperature permit limits are based on Region 1's previous determination that a § 316(a) variance was

warranted. As discussed more fully below, Region 1 correctly determined in this permit renewal proceeding that PSNH has more than adequately demonstrated that continuation of its § 316(a) variance is warranted because no appreciable harm has resulted from past thermal discharges from Schiller Station.

**C. Piscataqua River**

The Piscataqua River is a 13-mile-long tidal estuary formed by the confluence of the Salmon Falls and Cocheco Rivers. It flows southeastward, determining part of the boundary between the states of New Hampshire and Maine, and empties into the Portsmouth Harbor and the Atlantic Ocean. The drainage basin of the river is approximately 1,495 square miles, encompassing the additional watersheds of the Great Works River and five rivers flowing into Great Bay: the Bellamy, Oyster, Lamprey, Squamscott, and Winnicut.

Channel depths within the Piscataqua River range from 42 to 75 feet in the vicinity of Schiller Station. The width at the narrowest point of the River in this same vicinity is approximately 850 feet. The tide in the Piscataqua River is semi-diurnal, with an average period of 12.4 hours. Tidal flushing requires six to 12 tidal cycles (*i.e.*, 3 to 6 days) and tidal mixing forces cause the water column to be vertically well mixed. Flow velocities in the vicinity of Schiller Station range from approximately 4.9 fps during ebb tide and 4.4 fps during flood tide. The peak tidal flows are approximately 117,000 cubic feet per second (“cfs”) and the average freshwater discharge rate is approximately 1570 cfs.

The Piscataqua River is classified as both a water of the United States and as a water of the State of New Hampshire. The New Hampshire Department of Environmental Services (“NHDES”) has designated the Piscataqua River as a Class B water in accordance with New Hampshire water quality standards, which require all surface waters to provide for the protection and propagation of fish, shellfish and wildlife, and for recreation in and on the surface waters,

when feasible.<sup>7</sup> New Hampshire law identifies the designated uses of Class B waters as “[o]f the second highest quality,” and further provides that such waters “shall be considered as being acceptable for fishing, swimming and other recreational purposes and, after adequate treatment, for use as water supplies.”<sup>8</sup>

### **III. CURRENT NPDES PERMIT**

Region 1 issued Schiller Station’s current NPDES permit on September 11, 1990. This permit included a variance for Schiller Station’s thermal discharges because PSNH adequately demonstrated that its thermal discharges have not caused appreciable harm to the BIP of the Piscataqua River. To minimize impingement and entrainment, the 1990 permit established Schiller Station’s existing traveling screens and fish return system as BTA. The 1990 permit, for the most part, also set reasonable limits, including monitoring and reporting requirements, for each of the then-existing outfalls at Schiller Station. In 1995, PSNH timely submitted a complete application for renewal of the 1990 NPDES permit for Schiller Station.<sup>9</sup> The company submitted an updated renewal application in 2010 in response to a CWA Section 308 information request issued by Region 1.<sup>10</sup> The 1990 permit has been administratively continued and remains in effect today.

### **IV. LEGAL ISSUES AND STANDARDS OF REVIEW**

Region 1 correctly determined that both the final regulations promulgated in 2014 setting categorical technology-based requirements under CWA § 316(b) for CWISs at existing facilities and the 2015 effluent limitations guidelines and standards for the steam electric power

---

<sup>7</sup> See N.H. Code Admin. R. Ann. Env-Wq 1703.01.

<sup>8</sup> N.H. Rev. Stat. Ann. § 485-A:8(II) (1998).

<sup>9</sup> See Document AR-044 of Region 1’s compiled administrative record for this Draft Permit, available here: <http://www3.epa.gov/region1/npdes/schillerstation/index.html>. Hereinafter, references to the agency’s administrative record will be cited as “AR-XXX.”

<sup>10</sup> See AR-139.

generating point source category are applicable to, and will be applied in, this permit renewal proceeding.<sup>11</sup> As to the new final § 316(b) rule, Region 1 unequivocally and aptly stated that “[t]hese standards apply to Schiller Station.”<sup>12</sup> The NELGs had not yet been finalized at the time Region 1 issued the Draft Permit on September 30, 2015. Accordingly, Region 1 provided in its Fact Sheet for the Draft Permit that “EPA will apply the [NELGs] to the extent appropriate” “if the [NELGs are] in effect at the time that a new Final Permit is issued to Schiller Station.”<sup>13</sup> The NELGs were promulgated on November 3, 2015, and became effective on January 4, 2016.<sup>14</sup> Region 1 is therefore obligated to apply these uniform, technology-based standards applicable to the steam electric power generating industry. This is true even if Region 1 were in the position to issue the Draft Permit as final one day after the effective date of NELGs because Region 1 may not create alternative, case-by-case effluent and/or technological limitations based on its BPJ when guidelines are in the place that apply to a particular point source. BPJ-based limits are permissible only when no standardized effluent limitations exist. Once categorical limitations are established, the agency’s authority to establish BPJ-based standards ceases to exist.<sup>15</sup> Region

---

<sup>11</sup> See Fact Sheet at 9-10; see also 79 Fed. Reg. 48,300 (Aug. 15, 2014) (National Pollutant Discharge Elimination System—Final Regulations To Establish Requirements for Cooling Water Intake Structures at Existing Facilities and Amend Requirements at Phase I Facilities; Final Rule) (“final § 316(b) rule”); 80 Fed. Reg. 67,838 (Nov. 3, 2015) (Effluent Limitations Guidelines and Standards for the Steam Electric Power Generating Point Source Category) (“NELGs”).

<sup>12</sup> Fact Sheet at 10.

<sup>13</sup> *Id.* at 10 n.1.

<sup>14</sup> See 80 Fed. Reg. at 67,838.

<sup>15</sup> See *NRDC v. EPA*, 822 F.2d 104, 111 (D.C. Cir. 1987) (noting that a state or permit writer may set BPJ based limits only when there is no national standard that has been promulgated for a point-source category); *Citizens Coal Council v. EPA*, 447 F.3d 879, 881 n.11 (6th Cir. 2006) (noting that BPJ applies only when “EPA has not promulgated an applicable guideline”); see also *Riverkeeper v. U.S. E.P.A.*, 358 F.3d 174, 203 (2d Cir. 2004) (“It is, of course, true that once the EPA promulgates applicable standards, regulation of those facilities subject to those standards on a best professional judgment basis must cease”); Letter from Jim Hanlon, Director, Office of Wastewater Management, to Water Division Directors Regions 1-10 (June 7, 2010) (commonly referred to as the “Hanlon Memorandum”) (acknowledging that BPJ-based limits are only to be included in permits “until such time [as the NELGs are] promulgated.”) (emphasis added).

1 acknowledged this reality in its Fact Sheet to the Draft Permit,<sup>16</sup> and PSNH concurs with Region 1's conclusion on this topic.

Region 1's Draft Permit for Schiller Station contains certain key flaws that are not supported by the factual record and have no basis in law. As discussed more extensively below, components of Region 1's Draft Permit are based on the agency's erroneous application of and determinations under the CWA. Specifically, § 316(b) requires EPA to ensure that CWISs are located, designed, and constructed in a way that minimizes impingement and entrainment of biological organisms in the body of water from which cooling water is withdrawn. Additionally, CWA § 304 authorizes EPA to establish case-by-case BAT effluent limitations pursuant to its BPJ only after completing a thorough analysis of a number of specific factors.

In the Draft Permit, Region 1 failed to establish a rational or reasonable basis for its proposed § 316(b) and § 304 permit requirements. Region 1 must consider these and other comments regarding the inadequacy of its Draft Permit and address these inadequacies in the final permit. Region 1's final permit cannot stand if it is found to be "arbitrary, capricious, an abuse of discretion, or otherwise not in accordance with the law."<sup>17</sup> As is made clear by these comments, Region 1's current Draft Permit contains limits and requirements that are arbitrary and capricious, not in accordance with law, and that are not supported by the record. Region 1 simply has not "fully [explained] its course of inquiry, its analysis, and its reasoning."<sup>18</sup>

---

<sup>16</sup> See Fact Sheet at 10.

<sup>17</sup> 5 U.S.C. § 706(2)(A).

<sup>18</sup> See *Reynolds Metals Co. v. EPA*, 760 F.2d 549, 559 (4th Cir. 1985), (quoting *Tanner's Council of Am., Inc. v. Train*, 540 F.2d 1188, 1191 (4th Cir. 1976)).

A court will review Region 1’s factual permit determinations under the Administrative Procedure Act’s (“APA”) arbitrary and capricious standard.<sup>19</sup> The APA requires the reviewing court to “hold unlawful and set aside agency action, findings, and conclusions found to be . . . arbitrary, capricious, an abuse of discretion, or otherwise not in accordance with the law.”<sup>20</sup> An agency decision is arbitrary and capricious if “the agency has relied on factors which Congress has not intended it to consider, entirely failed to consider an important aspect of the problem, offered an explanation of its decision that runs counter to the evidence before the agency, or is so implausible that it could not be ascribed to a difference in view or the product of agency expertise.”<sup>21</sup> Questions of law will be determined by a two-step process established by the U.S. Supreme Court.<sup>22</sup>

## V. PSNH’s COMMENTS ON THE DRAFT PERMIT

PSNH strongly urges Region 1 to reconsider and revise key portions of its Draft Permit for Schiller Station. Region 1 correctly determined the existing § 316(a) variance should be

---

<sup>19</sup> *Pamlico-Tar River Found v. U.S. Army Corps of Eng’rs*, 329 F. Supp. 2d 600, 612 (E.D.N.C. 2004) (“agency action under the CWA is reviewed under the arbitrary and capricious standard”); *c.f.*, *Conservation Law Found v. Fed. Highway Admin.*, 827 F. Supp. 871, 885 (D.R.I. 1993) *aff’d*, 24 F.3d 1465 (1st Cir. 1994) (“under the APA standard, courts reviewing permit Section 404 decisions must determine whether the Corps’ action was ‘arbitrary, capricious, an abuse of discretion, or otherwise not in accordance with law.’” (citing 5 U.S.C. § 706(2)(A); *Hough v. Marsh*, 557 F. Supp. 74, 81 (D.Mass.1982)).

<sup>20</sup> *Alliance to Save the Mattaponi v. U.S. Army Corps of Eng’rs*, 606 F. Supp. 2d 121, 127 (D.D.C. 2009) (citing 5 U.S.C. § 706(2)(A)).

<sup>21</sup> *Id.* (citing *Motor Vehicle Mfrs. Ass’n v. State Farm Mut. Auto. Ins. Co.*, 463 U.S. 29, 43, 103 S. Ct. 2856, 77 L.Ed.2d 443 (1983)).

<sup>22</sup> *See Defenders of Wildlife v. Browner*, 191 F.3d 1159, 1162 (9th Cir. 1999) *opinion amended on denial of reh’g*, 197 F.3d 1035 (9th Cir. 1999)

[T]he Supreme Court devised a two-step process for reviewing an administrative agency’s interpretation of a statute that it administers. . . . Under the first step, we employ ‘traditional tools of statutory construction’ to determine whether Congress has expressed its intent unambiguously on the question before the court. . . . If the intent of Congress is clear, that is the end of the matter; for the court, as well as the agency, must give effect to the unambiguously expressed intent of Congress. If instead Congress has left a gap for the administrative agency to fill, we proceed to step two. At step two, we must uphold the administrative regulation unless it is arbitrary, capricious, or manifestly contrary to statute.

(internal quotations omitted) (citing *Chevron U.S.A. Inc. v. Natural Resources Defense Council, Inc.*, 467 U.S. 837, 842-44 (1984)).

continued in the new final permit for Schiller Station. However, the agency's § 316(b) BTA determination, as well as its decision to establish BPJ-based BAT effluent limits for NCMCWs, are flawed and unsupported by the existing record, rendering them arbitrary and capricious. Modified traveling water screens with an upgraded fish return system are BTA for the CWISs at Schiller Station. Region 1's conclusion that fine-mesh CWW screens are necessary to address entrainment is erroneous, as is the proposed June outage for Unit 5 at the facility. There is no evidence that operation of the CWISs at Schiller Station is having any detrimental or adverse impact on the BIP—a fact with which Region 1 expressly agreed in its Fact Sheet. In fact, entrainment at Schiller Station is *de minimis* based on the relatively small amount of cooling water withdrawn at the facility compared to the rest of the industry and because Schiller Station's cooling water withdrawals constitute a mere 0.0018 percent of the peak Piscataqua River withdrawal zone flow during each tidal cycle.

If Region 1 does not agree with PSNH's proffered § 316(b) technology, the agency must allow the company to submit entrainment data and analyses equivalent to information facilities withdrawing in excess of 125 MGD AIF are required to submit to their respective permit writers, in accordance with the final § 316(b) rule. Then, and only then, would Region 1 possess the minimum amount of information it needs to render a reasoned BTA determination. This additional information would confirm that technologies to address entrainment are not necessary at Schiller Station. Were that somehow not the ultimate result, Region 1 must at the very least allow PSNH to test CWW screens with a slot-width larger than the 0.8 mm Region 1 has prescribed as a maximum potential opening due to discoveries in recent years that demonstrate larger slot-width CWW screens can be just as effective as smaller ones at reducing entrainment in certain ecological environments—like the Piscataqua River.



Subjecting NCMCWs to iron and copper limits at Schiller Station ignores the historical permitting record for the facility and is based on a hollow BAT analysis. NCMCWs at Schiller Station have historically been, and continue to be, treated as a low volume waste exempted from any iron and copper effluent limitations in accordance with the Jordan Memorandum. This was confirmed by EPA (with assistance from Region 1) only a few years ago as part of the promulgation of the new NELGs. Region 1 failed to so much as even consider how NCMCWs have previously been addressed at the facility. Given that such an evaluation is mandated by EPA's final NELGs, the agency's BAT determination and corresponding effluent limitations are incomplete, arbitrary, and capricious.

The agency's actual BAT analysis for establishing BPJ-based effluent limitations for NCMCWs at Schiller Station is also arbitrary and capricious. Region 1 has no data of isolated NCMCWs generated at Schiller Station. Without it, the agency cannot determine whether its proposed regulation of the waste stream is cost-effective. The agency also grossly underestimates the significant costs and/or logistical problems that regulation of NCMCWs in the manner it has proposed would present at Schiller Station. Section 304(b)(2)(B) of the CWA and EPA's regulations require Region 1 to take these and other factors into consideration when adopting site-specific effluent limitations. A thorough BAT analysis, coupled with a review of the historical permitting record, should lead Region 1 to only one conclusion: NCMCWs must continue to be classified as a low volume waste in the new final permit for Schiller Station.

Each of these allegations of error is discussed at length in the comments that follow.

A. **Region 1 Correctly Determined that PSNH's Existing 316(a) Variance Should be Continued in the Renewed Final Permit**

PSNH has made the requisite showing under CWA Section 316(a) that it is entitled to a continuation of its variance from Section 301 standards for its thermal discharges at Schiller

Station. Specifically, PSNH has demonstrated that no appreciable harm has resulted from thermal discharges from Schiller Station through existing Outfalls 001, 002, 003, and 004 and that a BIP exists in the Piscataqua River. Thus, PSNH has demonstrated that the alternative limits it seeks will assure the protection and propagation of the BIP within the waterbody. Region 1 correctly confirmed this determination in its continuation of the existing thermal variance applicable to Schiller Station in the Draft Permit.

Under CWA § 301, because Schiller Station is a discharger of heat, it must satisfy both technology based standards and water quality standards, or obtain a variance from these standards under CWA § 316(a). CWA § 316(a) allows Region 1 to grant a variance from § 301 standards whenever:

the owner or operator . . . can demonstrate . . . that any effluent limitation proposed for the control of the thermal component of any discharge from such source will require effluent limitations more stringent than necessary to assure the protection and propagation of a balanced, indigenous population of shellfish, fish, and wildlife in and on the body of water into which the discharge is made . . . .<sup>23</sup>

If successful in this demonstration, Region 1 may instead impose alternative effluent limitations on thermal discharges “that will assure the protection and propagation of a [BIP] of shellfish, fish, and wildlife in and on that body of water.” BIP is not defined by statute or regulations; however, “balanced, indigenous community” (which the regulations state is synonymous with BIP) is defined as “a biotic community typically characterized by diversity, the capacity to sustain itself through cyclic seasonal changes, presence of necessary food chain species and by a lack of domination by pollution tolerant species. Such a community may include historically non-native species introduced in connection with a program of wildlife management and species

---

<sup>23</sup> 33 U.S.C. § 1326(a).

whose presence or abundance results from substantial, irreversible environmental modifications.”<sup>24</sup>

The Environmental Appeals Board (“EAB”) has summarized the § 316(a) variance determination process as follows:

[R]eading CWA sections 301 and 316(a) together, the statute and regulations in effect establish a three- (and sometimes four-) step framework for obtaining a variance: (1) the Agency must determine what the applicable technology and WQS-based limitations should be for a given permit; (2) the applicant must demonstrate that these otherwise applicable effluent limitations are more stringent than necessary to assure the protection and propagation of the BIP; (3) the applicant must demonstrate that its proposed variance will assure the protection and propagation of the BIP; and (4) in those cases where the applicant meets step 2 but not step 3, the Agency may impose a variance it concludes does assure the protection and propagation of the BIP.<sup>25</sup>

EPA has promulgated regulations describing the factors, criteria, and standards for the establishment of effluent standards issued under a § 316(a) variance.<sup>26</sup> These regulations restate the requirements of § 316(a) and require the applicant to demonstrate that an alternative effluent limitation will “assure the protection and propagation of a balanced, indigenous community . . . .”<sup>27</sup> For existing sources, this demonstration is based on the “absence of prior appreciable harm.”<sup>28</sup>

Existing sources can show that there has been no appreciable harm in one of two ways: (1) by employing a retrospective demonstration showing “that no appreciable harm has resulted from the normal component of the discharge[,] taking into account the interaction of such thermal component with other pollutants and the additive effect of other thermal sources to [the

---

<sup>24</sup> 40 C.F.R. § 125.71(c).

<sup>25</sup> *In re: Dominion Energy Brayton Point, L.L.C.* (Formerly USGen New England, Inc.), 12 E.A.D. 490, 500 (EAB 2006) (“*Brayton Point I*”).

<sup>26</sup> *See* 40 C.F.R. §§ 125.70-73.

<sup>27</sup> *Id.* § 125.73(a).

<sup>28</sup> *Id.* § 125.73(c)(1).

BIP],” or (2) through a prospective demonstration showing that, “despite the occurrence of such previous harm, the desired alternative effluent limitations (or appropriate modification thereof) will nevertheless assure the protection and propagation of [the BIP].<sup>29</sup> PSNH has demonstrated that no appreciable harm has resulted from its prior thermal discharges at Schiller Station through a retrospective analysis.<sup>30</sup>

“Appreciable harm” is not defined in EPA’s regulations. However, EPA has attempted to give some meaning to the term in case law and guidance documents. In a 1974 guidance document for § 316(a), EPA describes “appreciable harm” as damage to the BIP resulting in “a substantial increase” of nuisance or heat tolerant species, a “substantial decrease” in formerly indigenous species, a “substantial” reduction of trophic structure, “reduction of the successful completion of life cycles of indigenous species,” an “unaesthetic appearance, odor or taste of the waters,” and “elimination of an established or potential economic or recreational use of the waters.”<sup>31</sup>

“It is not intended that every change in flora and fauna should be considered appreciable harm,”<sup>32</sup> nor do all levels of impacts to a fish community rise to “appreciable harm.” In fact,

---

<sup>29</sup> See *Brayton Point I*, 12 E.A.D. at 553 (citing 40 C.F.R. §125.73(c)(1)(i)-(ii)).

<sup>30</sup> In such a retrospective analysis, the existing discharger must demonstrate that it has appropriately evaluated the typical indicators of long-term thermal effects and determined that there is no indication of “appreciable” thermal impacts on the BIP attributable to the discharge in question. See *Brayton Point I*, 12 E.A.D. at 553”) (when looking at trends, § 316(a) determination only assigns to station those effects actually caused by station). Because ecosystems are dynamic and “changes occur continually due to natural processes and stresses,” the focus of a retrospective § 316(a) demonstration’s long-term assessment of fish must be on those changes that are reasonably, but definitively, attributable to a particular thermal discharge, not simply on changes alone. *In re Pub. Serv. Co. of Ind., Inc. (Wabash River Generating Station, Cayuga Generating Station)*, 1 E.A.D. 590, 601 (EAB 1979) (“Wabash”).

<sup>31</sup> See EPA, Draft 316(a) Technical Guidance – Thermal Discharges, at 23 (Sept. 30, 1974).

<sup>32</sup> See *id.* Additionally, in *Brayton Point I*, 12 E.A.D. at 565 n.118, the EAB stated that “[w]e note that the word ‘measurable’ is a synonym for ‘appreciable.’ (citing The Doubleday Roget’s Thesaurus in Dictionary Form 31 (Sidney I. Landau & Ronald J. Bogus, eds., 1977)). In response to comments on Brayton Point’s NPDES permit specifically regarding the facility’s § 316(a) variance request, EPA stated that a thermal discharge must cause a significant delay in the recovery of a BIP of fish, shellfish, and wildlife to qualify as appreciable harm. See EPA Responses to Comments at III-8, Public Review of Brayton Point Station, NPDES Permit No. MA0003654 (Oct. 3,

EPA's own guidance plainly states that some level of impact is acceptable.<sup>33</sup> Both the EAB and Region 1 have confirmed this interpretation.<sup>34</sup> In sum, an existing discharger is entitled to a § 316(a) variance if, as noted above, it shows that it has evaluated the typical indicators of long-term thermal effects (*e.g.*, abundance, diversity, community composition) in an appropriate manner, and determined that there is no reasonable indication of thermal impacts attributable to the discharge in question.

By and through the studies and data submissions provided to Region 1 over the years, coupled with field data Region 1 collected on its own volition, PSNH has demonstrated<sup>35</sup> both that: (1) no appreciable harm to the BIP has resulted from thermal discharges from Schiller Station; and (2) continuation of the § 316(a) variance at Schiller Station will continue to assure the protection and propagation of the BIP. The fact that Schiller Station has significantly reduced its actual intake and corresponding discharge flows of non-contact cooling water utilized for Units 4 and 6 in recent years provides an additional margin of safety and further supports the aforementioned conclusions. Region 1 correctly agreed with PSNH's demonstrations and conclusions in the Fact Sheet and Draft Permit:

---

2003) ("Brayton Response to Comments"). Moreover, EPA agreed with the permittee that "even significant adverse effects on a few species do not necessarily require a finding of appreciable harm to the BIP that would preclude a § 316(a) variance . . ." to the extent that the commenter is saying that even significant adverse effects on a few species might not create a 100 percent inviolate requirement that no § 316(a) variance could be issued." *See id.* at III-35; *see also Brayton Point I*, 12 E.A.D. at 574-75 (noting that EPA selected a temperature limitation that "represent[s] an acceptable level of impact but [does] not represent a zero impact temperature") (citing Brayton Response to Comments at III-11); *In re Dominion Energy Brayton Point, LLC*, 13 E.A.D. 407 (EAB 2007) (finding that § 316(a) does not require a "'no effects' standard" to prove no prior appreciable harm).

<sup>33</sup> *See, e.g.*, Draft Interagency 316(a) Technical Guidance Manual & Guide for Thermal Effects Sections of Nuclear Facilities Environmental Impact Statements, at 23 (May 1, 1977) (reductions in macroinvertebrate community diversity and standing crop "may be cause of the denial of a 316(a) waiver" but "applicant can [still otherwise] show that such reductions cause no appreciable harm") (emphasis added).

<sup>34</sup> *See, e.g., Wabash*, 1 E.A.D. at 600-01 (noting that in cases, stability of community as a whole may be more dispositive than level of harm to individual species); *Brayton Point I*, 12 E.A.D. at 574 n.138, 139 (upholding EPA Region 1's analysis that adverse effects are allowable to the extent that they do not interfere with protection and propagation of BIP).

<sup>35</sup> *See, e.g.*, AR-021 to AR-023; AR-038 to AR-043; AR-121.

The width and depth of the river unaffected by the Facility's thermal plume allows sufficient zone of passage for both swimming and drifting organisms. Swimming organisms have a large section of the river available in the event an avoidance response is triggered by the thermal plume. Such avoidance behavior due to elevated temperatures would only occur, if at all, in a very small area within the mixing zone. In EPA's judgment, the thermal discharge represents little or no impediment to fish migration up or down the Piscataqua River. Moreover, EPA concludes that the thermal plume will not degrade fishing opportunities in the vicinity of Schiller Station.

...

Because the Piscataqua River in the area of the station retains a large portion of the river that is unaffected by the thermal plume, adult and juvenile fish species have the opportunity to easily avoid the elevated water temperature long before potential lethality is a consideration, if at all. This avoidance behavior is not judged to adversely affect the fish species.<sup>36</sup>

Region 1's determination is well-supported and should be included in the final permit eventually issued by the agency.

**PSNH's Requests to Increase the Effluent Temperature Limit to 100°F and "Delta-T" Limit from 25°F to 30°F at Schiller Station**

Region 1 proposed in its Fact Sheet to reject PSNH's requests that: (1) the temperature limits in the new final permit be raised to 100°F for cooling water discharges at Schiller Station; and (2) the temperature difference or rise between the withdrawal and discharge of water at the facility be increased from 25°F to 30°F at all times, instead of allowing a 30°F "Delta-T" for only a two-hour period during condenser maintenance for the combined Outfalls 002, 003, and 004.<sup>37</sup> The basis of the agency's rejection is a purported lack of data and analysis submitted by the company demonstrating that the protection and propagation of the BIP will be assured with these different thermal limitations.<sup>38</sup> PSNH respectfully disagrees with this conclusion. The existing record contains sufficient data and analysis regarding the limited impact of the existing

---

<sup>36</sup> Fact Sheet at 64–65.

<sup>37</sup> *Id.* at 69, 77.

<sup>38</sup> *See id.*

thermal plume in the Piscataqua River to support a conclusion that the BIP will continue to be adequately protected even if the Station's thermal discharges increase on rare occasions by 5°F, and/or the Delta-T between the withdrawal and discharge temperatures periodically increases by 5°F. Although PSNH believes the agency already has ample evidence to make this determination, PSNH requests the opportunity to submit additional data or analyses.

PSNH requests that Region 1 revise the Draft Permit to allow PSNH the option to discharge at these requested temperature values on a conditional basis during one or more defined periods of time, subject to PSNH's collection and submission of the necessary data establishing that the protection and propagation of the BIP will be assured with these different thermal limitations. Alternatively, PSNH requests that Region 1: (1) notify PSNH if the agency is willing to allow the company to submit documentation supporting its requests prior to the new permit being issued as final; or (2) include a provision in the final permit that specifically provides PSNH with the option to submit documentation demonstrating that the BIP would continue to be adequately protected if the: (a) thermal discharge limitations applicable Outfalls 002, 003, and 004 at Schiller Station are increased by 5°F; and/or (b) Delta-T between the withdrawal and discharge of water at the facility is increased from 25°F to 30°F at all times; coupled with a statement confirming that Region 1 will timely reopen the final permit to incorporate these new thermal limitations upon determining that PSNH's submission justifies the permit modifications. PSNH is confident that under any of the scenarios its submission will confirm the continued, adequate protection of the BIP.

**B. EPA's § 316(b) BTA Determination is Arbitrary and Capricious**

Region 1's CWA § 316(b) BTA determination is flawed and unsupported. The installation of modified traveling screens with an upgraded fish return system at Schiller Station constitutes BTA and satisfies the requirements of § 316(b). Region 1 erroneously determined

that technologies to address entrainment are necessary at Schiller Station. The agency rendered this conclusion despite not first definitively declaring that the environmental impacts caused by the CWISs at Schiller Station are having any harmful or adverse effects on the BIP within the Piscataqua River—a prerequisite to any reasoned BTA determination rendered pursuant to § 316(b). In fact, Region 1 stated time and again in its Fact Sheet that it has found “no evidence” that operation of the CWISs are causing or having any major effects on the BIP. Thus, Region 1 has proposed saddling the facility with additional technological requirements to supposedly address a problem the agency freely admits does not exist. This is arbitrary and capricious.

Requiring technologies for entrainment at Schiller Station is also at odds with the 125 MGD AIF policy-driven compliance threshold EPA established in the final § 316(b) rule. This threshold was established to allow the agency to focus on the most impactful facilities while not burdening those facilities causing minimal to no impact. The 72.4 MGD AIF at Schiller Station is far below this established 125 MGD AIF threshold. Region 1 has failed to explain why impacts from entrainment are so severe at the facility to justify overriding the dividing line EPA established less than two years ago as part of its national rulemaking. There is no rational justification given that the entrainment impacts at the facility are miniscule. In fact, they are *de minimis*. Schiller Station’s average AIF of 72.4 MGD is one of the lowest within the industry. When this withdrawal volume is considered in conjunction with the source waterbody—the Piscataqua River—it becomes impractical to assert that entrainment caused by the existing CWISs at the facility is anything but *de minimis*. This is because the 72.4 MGD AIF amounts to a mere 0.0018 percent of the peak Piscataqua River withdrawal zone flow during each tidal cycle. The withdrawal of this infinitesimal percentage of overall water cannot be causing any environmental impact that is adverse to the Piscataqua River. Accordingly, installation of



technologies at Schiller Station to address entrainment is unwarranted and Region 1's contrary determination is arbitrary and capricious.

Should Region 1 erroneously persist in requiring technologies to address entrainment at Schiller Station despite the aforementioned arguments, the agency must, at a minimum, first allow PSNH the opportunity to submit additional information the agency must have to render a legally defensive BTA determination. The additional information PSNH should be allowed to submit consists of data that reflects the current understanding of the true efficacy of CWW screens that has been better quantified in more recent years since PSNH submitted information of this kind to the agency, as well as studies and analyses substantially similar to the ones facilities with a withdrawal volume in excess of 125 MGD AIF are required to submit to their respective permit writers under the final § 316(b) rule to ensure the permit writer can make an informed BTA determination. Submission of this information would confirm entrainment controls are not necessary at Schiller Station. If it somehow does not, PSNH should be allowed to test CWW screens with a slot-width larger than the 0.8 mm Region 1 has prescribed as a maximum potential opening.

Further, a June outage for Unit 5 at Schiller Station is not possible and/or prudent. And, if PSNH is ultimately required to install CWW screens at Schiller Station, no accompanying operational measure is warranted to satisfy the § 316(b) BTA standard. PSNH previously communicated to Region 1 that it could not schedule its annual outages at Schiller Station between June and September. The agency acknowledged this reality in its Fact Sheet but then included a June outage requirement for Unit 5 in its BTA determination anyway, without offering any support for its determination. This too is arbitrary and capricious.

Finally, the proposed timeline for the design, permitting, and construction of CWW screens at Schiller Station is unreasonable and must be overhauled. PSNH maintains that such technologies are not needed at the facility. Nonetheless, PSNH has included a workable schedule if the company is ultimately forced to install the technology. Detailed comments with respect to each of these issues are set out below.

### **1. Legal background**

Section 316(b) of the CWA requires the location, design, construction, and capacity of CWISs to reflect BTA in order to protect and minimize adverse environmental impacts to aquatic organisms.<sup>39</sup> Regulation of CWISs under § 316(b) originated in 1972. EPA published its first § 316(b) final rule in 1976<sup>40</sup>; however, this rule was invalidated by the Fourth Circuit in 1977.<sup>41</sup> In place of the defunct rule, EPA published guidance for evaluating the adverse impact of CWISs and the general method for incorporating § 316(b) conditions into NPDES permits.<sup>42</sup> The Draft EPA 316(b) Guidance outlined an approach for collecting information intended to support BPJ determinations made by the permitting authority; however, it did not establish a national technology based BTA standard, as required by the CWA. In fact, EPA decided to forgo any further promulgation of § 316(b) regulations following issuance of this Draft EPA 316(b) Guidance and, instead, decided to rely on individual BPJ determinations.

Over fifteen years passed with no additional standards developed by EPA. Frustrated by this inaction, environmental groups initiated a citizen suit in 1995, demanding that EPA promulgate regulations to reduce impingement and entrainment caused by CWISs. The parties

---

<sup>39</sup> 33 U.S.C. § 1326(b).

<sup>40</sup> See 41 Fed. Reg. 17,387 (April 26, 1976).

<sup>41</sup> *Appalachian Power Co. v. Train*, 566 F.2d 451 (4th Cir. 1977).

<sup>42</sup> See Draft Guidance for Evaluating the Adverse Impact of Cooling Water Intake Structures on the Aquatic Environment: § 316(b) (May 1, 1977) (“Draft EPA 316(b) Guidance”).

entered into a consent decree, with EPA agreeing to promulgate new § 316(b) regulations in accordance with a three-phase schedule.<sup>43</sup>

EPA promulgated Phase II of the regulatory phasing-schedule, which applied to CWISs located at existing power plants with a design capacity of greater than 50 million gallons per day in September 2004.<sup>44</sup> In the 2004 Phase II regulations, EPA called for an overall reduction in impingement of 80 to 95 percent, and an overall reduction in entrainment of organisms by 60 to 90 percent over a baseline value that reflected the level of impingement mortality and entrainment that would occur absent specific controls.<sup>45</sup> Percentile ranges for impingement and entrainment reductions were included in the rule because it did not establish a single technology as BTA. Instead, EPA offered five compliance alternatives for a facility to select and implement to satisfy the BTA standard, such as using existing technologies, selecting additional fish protection technologies (such as screens with fish return systems), and using restoration measures.<sup>46</sup>

Several aspects of EPA's 2004 Phase II regulations were eventually challenged in *Riverkeeper, Inc. v. EPA*, 475 F.3d 83 (2d Cir. 2007) ("*Riverkeeper II*"). Ultimately, the court rejected various provisions of the Phase II rule. In reaching its decision, the court relied on its earlier decision in *Riverkeeper, Inc. v. EPA*, 358 F.3d 174 (2d Cir. 2004) ("*Riverkeeper I*"), a challenge of EPA's 2001 § 316(b) Phase I rule for new facilities, which held that a provision allowing power plants to undertake restoration measures as an alternative to implementing BTA violated the intent of the CWA and was based on an impermissible construction of § 316(b). The

---

<sup>43</sup> See *Cronin v. Browner*, 898 F. Supp. 1052, 1055–56 (S.D.N.Y. 1995); see also *Riverkeeper, Inc. v. Whitman*, 32 Env'tl. L. Rep. 20382, 2001 WL 1505497, at \*1 (S.D.N.Y. Nov. 27, 2001) (discussing the litigation that resulted in the consent order requiring EPA to promulgate three phases of CWIS regulations).

<sup>44</sup> See 69 Fed. Reg. 41,576 (July 9, 2004) ("2004 Phase II regulations").

<sup>45</sup> *Id.* at 41,590.

<sup>46</sup> See *id.* at 41,630.

*Riverkeeper II* court ultimately remanded a significant portion of the regulations back to EPA for further development, including EPA’s use of the “significantly greater” cost-benefit standard to assess the most effective CWIS technology to install at individual plants. On July 9, 2007, however, EPA formally suspended all but one section of the rulemaking, 40 C.F.R. § 125.90(b), which provides, in relevant part, that existing facilities not subject to any other subpart of 40 C.F.R. Part 125 must meet requirements under § 316(b) of the CWA determined by EPA on a case-by-case, BPJ basis.<sup>47</sup>

Despite suspension of the 2004 rulemaking by EPA in 2007, EPA’s use of the “significantly greater” standard in the 2004 rule and its established practice of considering costs and relative benefits in making § 316(b) BTA determinations was heard by the U.S. Supreme Court in *Entergy Corp. v. Riverkeeper Inc.*<sup>48</sup> In its decision, the U.S. Supreme Court confirmed that § 316(b) allows permit writers to consider costs and benefits in determining BTA to minimize adverse environmental impacts. In doing so, the court provided that the term “minimize” within § 316(b) “admits of degree and is not necessarily used to refer exclusively to the ‘greatest possible reduction.’”<sup>49</sup> The *Entergy* Court also referenced EPA’s prior use of a “wholly disproportionate” cost-benefit standard and stated that although that standard may be

---

<sup>47</sup> See 40 C.F.R. § 125.90(b).

<sup>48</sup> 556 U.S. 208 (2009).

<sup>49</sup> *Id.* at 209. Moreover, in speaking about the promulgation of regulations generally, both Justices Scalia and Breyer provided that some consideration of costs and benefits is a part of “rational” and “reasonable” decision making, or at least that imposing enormous costs with very small benefits would be “unreasonable” and “irrational.” *Id.* at 232–33. Justice Scalia further provided that “whether it is ‘reasonable’ to bear a particular cost may well depend on the resulting benefits.” *Id.* at 225–26. A decision imposing “massive costs far in excess of any benefit,” according to Justice Breyer, would conflict with a test of reasonableness. *Id.* at 225–26. Allowing EPA to weigh costs and benefits “prevent[s] results that are absurd or unreasonable in light of extreme disparities between costs and benefits.” *Id.* at 234. According to Justice Breyer, an absolute prohibition of a cost-benefit analysis would bring about “irrational” results, because “it would make no sense to require plants to ‘spend billions to save one more fish or [plankton].’” *Id.* at 233–34. This is “particularly so in an age of limited resources available to deal with grave environmental problems, where too much wasteful expenditure devoted to one problem may well mean considerably fewer resources available to deal effectively with other (perhaps more serious) problems.” *Id.* at 233.

somewhat different than the “significantly greater” standard utilized in the 2004 rule, “there is nothing in the statute that would indicate that the former is a permissible interpretation while the latter is not.”<sup>50</sup> Thus, the Court concluded, use of either cost-benefit standard is acceptable for determining BTA for § 316(b) at existing facilities.<sup>51</sup>

On August 15, 2014, EPA published in the Federal Register its CWA final § 316(b) rule for CWISs.<sup>52</sup> The final rule became effective on October 14, 2014.<sup>53</sup> It applies to existing industrial facilities that withdraw greater than 2 MGD and utilize 25 percent or more of that water exclusively for cooling purposes.<sup>54</sup> The new regulations are codified under 40 C.F.R. Part 125, Subpart J, and establish categorical standards for determining and implementing BTA to minimize impingement and entrainment impacts of CWISs. The final § 316(b) rule modified and combined into a single rulemaking portions of its previous phased CWA § 316(b) rulemakings that had been litigated and remanded following judicial review.<sup>55</sup>

The primary requirements applicable to existing facilities in the final § 316(b) rule include the requirement that any facility with a DIF greater than 2 MGD install one of several

---

<sup>50</sup> *Id.* at 225.

<sup>51</sup> *Id.* at 226. Subsequent to the Supreme Court’s *Entergy* decision, President Obama issued Executive Order 13,563, which specifically mandates the benefits of any “regulation” justify its costs. Exec. Order No. 13,563, 76 Fed. Reg. 3,821 (Jan. 16, 2011) (“Exec. Order 13,563”). “Our regulatory system . . . must be based on the best available science. . . must promote predictability and reduce uncertainty. It must identify and use the best, most innovative, and least burdensome tools for achieving regulatory ends. It must take into account benefits and costs, both quantitative and qualitative.” *Id.* “[E]ach agency must, among other things . . . propose or adopt a regulation only upon a reasoned determination that its benefits justify its costs (recognizing that some benefits and costs are difficult to quantify).” *Id.*

PSNH recognizes that issuance of a draft permit may not be deemed equal to promulgating a regulation. However, § 1(a) of Exec. Order 13,653, by its express terms, applies more broadly to the United States’ “regulatory system” as a whole, which includes regulations, as well as permits issued by agencies pursuant to such regulations. *Id.*

<sup>52</sup> 79 Fed. Reg. 48,300 (Aug. 15, 2014)

<sup>53</sup> *Id.* at 48,358.

<sup>54</sup> *See* 40 C.F.R. § 125.91(a).

<sup>55</sup> *See, e.g.,* 79 Fed. Reg. at 48,328.

approved technologies to reduce fish impingement mortality at its CWIS and the requirement that any existing facility with an AIF over 125 MGD conduct certain studies regarding entrainment of aquatic organisms in the facility's CWIS that will allow the permitting authority to establish BTA standards for entrainment on a site-specific basis.<sup>56</sup> As an existing facility withdrawing less than 125 MGD AIF, Schiller is subject only to the first of these two primary requirements.

For facilities subject to impingement mortality controls, such as Schiller Station, EPA advanced seven "pre-approved" control technologies from which a facility may choose to satisfy the BTA standard.<sup>57</sup> The new regulations also allow facilities to select other technologies upon a demonstration to the permitting authority that the selected technology will perform adequately.<sup>58</sup> The seven impingement control technologies for impingement mortality control set forth in the final § 316(b) rule include:

- (1) operate a closed-cycle recirculating system;
- (2) operate a CWIS with a designed maximum through-screen design intake velocity of 0.5 fps;
- (3) operate a CWIS with actual maximum through-screen design intake velocity of 0.5 fps;
- (4) operate an offshore velocity cap if installed before October 14, 2014;
- (5) operate a modified traveling screen that incorporates certain protective measures as defined by 40 C.F.R. § 125.92(s);
- (6) operate any other combination of technologies, management practices, and operational measures that the permit writer determines is BTA for impingement reduction; and

---

<sup>56</sup> See 40 C.F.R. § 125.94(c); *id.* § 122.21(r)(9)–(12).

<sup>57</sup> See *id.* § 125.94(c).

<sup>58</sup> See *id.* § 125.94(c)(6), (7).

(7) achieve the specified impingement mortality performance standard.<sup>59</sup>

Options 1, 2, and 4 are essentially “pre-approved” technologies the implementation of which would not generally require a demonstration to or approval by the permitting authority. Option 3 requires at least daily monitoring of the actual velocity at the screen in perpetuity, and Option 7 requires biological monitoring in perpetuity at a minimum frequency of monthly to demonstrate compliance with the impingement mortality performance standard.<sup>60</sup> If a facility chooses Options 5 or 6 to comply with the rule, it must undertake an “impingement technology performance optimization study.”<sup>61</sup> That study takes place after the installation of the chosen impingement technology, and therefore following the issuance of a new final NPDES permit (i.e., “post-permit”), and must include two years of at least monthly impingement mortality monitoring and set forth biological data measuring the reduction in impingement mortality achieved by operation of the chosen compliance option, including a demonstration that operation of the compliance option has been optimized to minimize impingement mortality.<sup>62</sup>

For entrainment reduction, the final 316(b) rule establishes regulations requiring the permitting authority to make a site-specific BTA determination—including a possible determination that no entrainment controls at a facility are necessary—after consideration of certain specified factors and based on all available entrainment data for a facility.<sup>63</sup> Specifically, 40 C.F.R. § 125.98(f) states that a permitting authority must consider the following factors in making such a site-specific determination:

---

<sup>59</sup> See *id.* § 125.94(c)(1)–(7).

<sup>60</sup> See *id.* § 125.94(c)(3), (7).

<sup>61</sup> See *id.* § 122.21(r)(6)(i), (ii).

<sup>62</sup> See *id.*

<sup>63</sup> See *id.* § 125.94(d).

- (i) Numbers and types of organisms entrained, including, specifically, the numbers and species (or lowest taxonomic classification possible) of Federally-listed, threatened and endangered species, and designated critical habitat (e.g., prey base);
- (ii) Impact of changes in particulate emissions or other pollutants associated with entrainment technologies;
- (iii) Land availability inasmuch as it relates to the feasibility of entrainment technology;
- (iv) Remaining useful plant life; and
- (v) Quantified and qualitative social benefits and costs of available entrainment technologies when such information on both benefits and costs is of sufficient rigor to make a decision.<sup>64</sup>

In terms of social costs and relative benefits, Region 1 aptly notes in its Fact Sheet that, “[c]onsistent with the *Entergy* decision, . . . [the final § 316(b) rule] call[s] for consideration of relative costs and benefits in determining the BTA for entrainment reduction.”<sup>65</sup> In other words, the “significantly greater than” and “wholly disproportionate” cost-benefit standards remain in effect following promulgation of the final § 316(b) rule. Region 1 recognized that “the regulations also provide that ‘[t]he Director may reject an otherwise available technology as a BTA standard for entrainment if the social costs are not justified by the social benefits.’”<sup>66</sup>

Notably, the quantifiable costs and relative benefits of EPA’s final § 316(b) rule have a ratio of 8.25 to 1 and/or 10.29 to 1, utilizing a 3 percent and 7 percent discount rate, respectively.<sup>67</sup>

The cost of additional technologies that may be required to meet the site-specific BTA for entrainment are not included in this analysis because . . . EPA cannot estimate, with any level of certainty, what site-specific determinations will be made based on the analyses that will be generated as a result of the national BTA standard for entrainment decision-making established [by the final rule].<sup>68</sup>

---

<sup>64</sup> *Id.* § 125.98(f)(2).

<sup>65</sup> Fact Sheet at 83.

<sup>66</sup> *Id.* at 83–84 (quoting 40 C.F.R. § 125.98(f)(4)) (alteration in original).

<sup>67</sup> *See* 79 Fed. Reg. at 48,303–04.

<sup>68</sup> *Id.* at 48,304.



This ratio likewise omits certain categories of benefits generically referred to as “the benefits associated with fish other than commercially and recreationally harvested fish;”<sup>69</sup> although, it is logical to assume that the costs associated with entrainment compliance will exceed these additional benefits even if they were quantified, meaning the aforementioned ratios would almost certainly increase if these two additional categories were quantitatively evaluated by the agency.

In addition to the five aforementioned mandatory factors, the permitting authority may also consider several other factors in reaching a site-specific BTA determination for entrainment, which include:

- (i) Entrainment impacts on the waterbody;
- (ii) Thermal discharge impacts;
- (iii) Credit for reductions in flow associated with the retirement of units occurring within the ten years preceding October 14, 2014;
- (iv) Impacts on the reliability of energy delivery within the immediate area;
- (v) Impacts on water consumption; and
- (vi) Availability of process water, gray water, waste water, reclaimed water, or other waters of appropriate quantity and quality for reuse as cooling water.<sup>70</sup>

The regulations further specify that the weight given to the mandatory factors may vary depending upon the circumstances of an individual facility.<sup>71</sup>

The permitting authority’s consideration of the aforementioned factors in making a BTA determination is to be “based on [a facility’s] submission of certain . . . required information” relating to entrainment impacts at a facility.<sup>72</sup> Specifically, to ensure that the permitting authority has access to the information necessary to make an informed BTA determination about

---

<sup>69</sup> *Id.*

<sup>70</sup> 40 C.F.R. § 125.98(f)(3).

<sup>71</sup> *Id.* § 125.98(f)(2).

<sup>72</sup> *See* 76 Fed. Reg. 22,174, 22,204 (Apr. 20, 2011) (proposed 316(b) Rule).

a facility's site-specific entrainment controls, the final 316(b) rule requires any existing facility with "major cooling water withdrawals"—greater than 125 MGD AIF—to collect the following types of entrainment-related information:<sup>73</sup>

Entrainment Characterization Study. A study of at least two years of entrainment data, identifying and documenting "organisms collected to the lowest taxon possible of all life stages of fish and shellfish that are in the vicinity of the cooling water intake structure(s) and are susceptible to entrainment, including any organisms identified by [EPA], and any species protected under Federal, State, or Tribal law, including threatened and endangered ("T&E") species with a habitat range that includes waters in the vicinity of the cooling water intake structure";

Comprehensive Technical Feasibility and Cost Evaluation Study: A description of the technical feasibility and incremental costs of candidate entrainment control technologies. The study must include an evaluation of the technical feasibility of closed-cycle cooling, fine-mesh screens with a mesh size of 2 mm or smaller, reuse of water or alternate sources of cooling water, and any other entrainment reduction technologies identified by the applicant or requested by the permitting authority;

Benefits Valuation Study: A detailed discussion of the magnitude of water quality benefits, both monetized and non-monetized, of the entrainment mortality reduction technologies evaluated in the Comprehensive Technical Feasibility and Cost Study, including discussion of recent mitigation efforts already completed and how these have affected fish abundance and ecosystem viability in the intake structure's area of influence as well as other benefits to the environment and the community; and

Non-water Quality and Other Environmental Impacts Study: A detailed discussion of the changes in non-water quality factors attributed to technologies and/or operational measures considered.<sup>74</sup>

As EPA explained in the final 316(b) rule, these entrainment study requirements are limited to facilities with actual water withdrawals exceeding 125 MGD because:

---

<sup>73</sup> See 79 Fed. Reg. at 48,309; 40 C.F.R. § 122.21(r)(9); see also EPA, Technical Development Document for the Proposed Section 316(b) Phase II Existing Facilities Rule, Dock. ID EPA-HQ-OW-2008-0667-1282, at 7-7 (Mar. 28, 2011) ("Proposed 316(b) TDD") (noting that "the permit writer would have access to all the information necessary for an informed decision about [a site-specific BTA determination] . . . to reduce entrainment mortality at facilities above 125 MGD AIF" because "the facility's permit application must include information to support such an evaluation").

<sup>74</sup> See 40 C.F.R. § 122.21(r)(9)–(13). Discussion of the changes in non-water quality factors attributed to technologies and/or operational measures considered, include but are not expressly limited to evaluating increases and decreases in energy consumption, thermal discharges, air pollutant emissions, water consumption, noise, safety, grid reliability, and facility reliability.

this threshold will capture 90 percent of the actual flows but will apply only to 30 percent of existing facilities. EPA concluded that this threshold struck the appropriate balance between the goal of capturing the greatest portion of intake flow while minimizing the study requirements for smaller facilities. . . . The selected threshold would significantly limit facility burden at more than two-thirds of the potentially in-scope facilities while focusing the Director on major cooling water withdrawals.<sup>75</sup>

Stated differently, facilities above the 125 AIF threshold comprise approximately 200 billion of the total 222 billion combined AIF gallons, which is why EPA determined in the final § 316(b) rule that it is these larger facilities (i.e., > 125 MGD AIF) that have “the highest likelihood of causing adverse impacts” from entrainment.<sup>76</sup>

Facilities falling below this 125 AIF threshold supposedly are not universally exempt from the entrainment requirements of the final § 316(b) rule, according to EPA. Yet, the agency recognized in its proposed rule that a BTA determination for entrainment at facilities within the 2 MGD DIF to 125 MGD AIF range could very well be “no other technologies beyond impingement control . . . because no other technologies are feasible and/or their benefits do not justify their costs.”<sup>77</sup> Nevertheless, EPA provided permitting authorities the right to “require reasonable information to make informed decisions at the smaller facilities” regarding what entrainment controls, if any, may be necessary to satisfy the BTA standard.<sup>78</sup>

Regarding implementation, 40 C.F.R. § 125.98(g) provides:

In the case of permit proceedings begun prior to October 14, 2014 whenever the Director has determined that the information already submitted by the owner or operator of the facility is sufficient, the Director may proceed with a determination of BTA standards for impingement mortality and entrainment without requiring the owner or operator of the facility to submit the information required in 40 C.F.R. 122.21(r). . . . In making the decision on whether to require

---

<sup>75</sup> EPA Technical Development Document for the Final Section 316(b) Phase II Existing Facilities Rule, Dock. ID EPA-HQ-OW-2008-0667-4138, at 3-8 (May 19, 2014) (“Final 316(b) TDD”).

<sup>76</sup> 79 Fed. Reg. at 48,309.

<sup>77</sup> 76 Fed. Reg. at 22,005.

<sup>78</sup> 79 Fed. Reg. at 48,309.

additional information from the applicant, and what BTA requirements to include in the applicant's permit for impingement mortality and site-specific entrainment, the Director should consider whether any of the information at 40 C.F.R. 122.21(r) is necessary.<sup>79</sup>

Region 1 "has determined that the information already submitted by the Facility is sufficient" and that it does not need any of the additional permit application information described in 40 C.F.R. § 122.21(r) to support its permit decision.<sup>80</sup>

**2. Technologies to address entrainment are not necessary at Schiller Station because the existing CWISs at the facility are not causing any AEI to the Piscataqua River**

PSNH should not be required to implement entrainment controls at Schiller Station because: (1) Region 1 has not determined that the CWISs impose an AEI to the aquatic ecosystems of the Piscataqua River in the vicinity of Schiller Station; (2) AIF at the facility is well below the 125 MGD compliance threshold set out in the final § 316(b) rule; and (3) entrainment at Schiller Station is *de minimis*, given that the facility's actual intake volume is 0.0018 percent of the peak Piscataqua River withdrawal zone flow during a tidal cycle.<sup>81</sup> The proposed technologies set out in the Fact Sheet and Draft Permit to address entrainment are therefore arbitrary and capricious and must be revised before Region 1 issues the permit as final.

**a. Region 1 cannot impose technologies to further minimize entrainment at Schiller Station without first establishing environmental impact that is adverse to the Piscataqua River**

Throughout its Fact Sheet for the Draft Permit, Region 1 provides that any entrainment caused by the operation of the current CWISs at Schiller Station is not causing an impact that is adverse to the aquatic ecosystem of the Piscataqua River. For instance, the agency states:

---

<sup>79</sup> 40 C.F.R. § 125.98(g).

<sup>80</sup> See Fact Sheet at 84.

<sup>81</sup> See 2016 Enercon-Normandeau Comments at 10.

- Region 1 “has no evidence that entrainment and/or impingement losses at Schiller Station are causing or significantly contributing to declines in local populations of the affected species of aquatic organisms or to disruptions in the local community or assemblage of organisms in the Piscataqua River.”<sup>82</sup> “This is not surprising given that Schiller Station’s [maximum designed] withdrawal of 125 MGD is only 0.5% of the tidal prism of the Piscataqua River Estuary (approximately 25,000 MGD).”<sup>83</sup>
- Entrainment at Schiller Station “has not been associated with higher level impacts, such as major effects on local populations of impacted species or the overall community of organisms in the river, or with impacts to endangered species.”<sup>84</sup>

In a conclusory fashion, the agency contradicts the aforementioned statements by providing that it believes the “entrainment and impingement losses from the current operation [at Schiller Station are] adverse environmental impacts.”<sup>85</sup> Yet even this abstract statement is immediately followed by the agency’s acknowledgement that it has been unable to find that impingement and/or entrainment at Schiller Station is negatively impacting the Piscataqua River: “[T]he available information is insufficient to draw conclusions that [impingement and entrainment] losses have caused either a particular reduction in the Great Bay estuary’s populations of the affected species or an imbalance in the overall assemblage of aquatic organisms in the estuary.”<sup>86</sup>

Section 316(b) of the CWA provides: “Any standard established pursuant to [§ 301 or § 306 of the CWA] and applicable to a point source shall require that the location, design, construction, and capacity of cooling water intake structures reflect the best technology available for minimizing adverse environmental impact.”<sup>87</sup> A careful examination of this last phrase is important. What constitutes “adverse environmental impact” has never been conclusively

---

<sup>82</sup> Fact Sheet at 158 (emphasis added).

<sup>83</sup> *Id.*

<sup>84</sup> *Id.* at 157–58.

<sup>85</sup> *Id.* at 97.

<sup>86</sup> *Id.*

<sup>87</sup> 33 U.S.C. § 1326(b) (emphasis added).

defined by Congress, EPA, or the courts. Important in the present context is the term “adverse,” because anyone could argue that just about anything results in an “impact” to the “environment.”

In the absence of a statutory definition, courts “construe a statutory term in accordance with its ordinary or natural meaning”<sup>88</sup> and courts assume that “Congress legislates with knowledge of [this] basic rule[] of statutory construction.”<sup>89</sup> The generally accepted definition of “adverse” is “[p]reventing success or development” and/or “harmful.”<sup>90</sup> Utilizing this definition within the key “adverse environmental impact” phrase, the intent of CWA § 316(b) is made clear: to reasonably require PSNH to install technologies to further minimize entrainment occurring at Schiller Station, Region 1 must first demonstrate that the current entrainment or “environmental impact” caused by the CWISs at Schiller Station is in some way preventing the success or development of (or is “harmful” or “adverse” to) the aquatic ecosystem within the Piscataqua River.<sup>91</sup> This the agency has not done. The above-quoted statements by the agency underscore this fact. Region 1 knows what constitutes environmental impact that is actually adverse to a waterbody justifying the need for additional technological controls:

---

<sup>88</sup> *FDIC v. Meyer*, 510 U.S. 471, 476 (1994) Words that are not terms of art and that are not statutorily defined are customarily given their ordinary meanings, often derived from the dictionary. *Id.*

<sup>89</sup> *McNary v. Haitian Refugee Ctr.*, 498 U.S. 479, 496 (1991).

<sup>90</sup> See Oxford Dictionaries, *Adverse*, [http://www.oxforddictionaries.com/us/definition/american\\_english/adverse](http://www.oxforddictionaries.com/us/definition/american_english/adverse) (last visited January 18, 2016).

<sup>91</sup> EPA’s own discussions in its latest proposed rule for the now final § 316(b) regulations support this interpretation. Specifically, EPA conceded that not all entrainment of eggs and larvae or impingement of fish is “adverse” inasmuch as the proposed rule authorized the permitting authority to may determine that “all life stages” do not include invasive and naturally moribund species (proposed 40 C.F.R § 125.92, 76 Fed. Reg. at 22,281), and insofar as the proposed rule approved the selection of “species of concern” (proposed 40 C.F.R. § 125.98(c), 76 Fed. Reg. at 22,287). Therefore, while reducing the number of nuisance or invasive species must be deemed an “environmental impact,” it is an impact that is beneficial, not “adverse.”

The CWISs at Schiller Station impinge and/or entrain a number of organisms that are or have been considered nuisance or invasive species. The green crab is a prime example. See, e.g., USDA National Invasive Species Information Center, *European Green Crab*, <http://www.invasivespeciesinfo.gov/aquatics/greencrab.shtml> (last modified January 21, 2016) (identifying the green crab as a nuisance and invasive species). PSNH should therefore be credited and not scorned for the positive environmental impacts the CWISs at Schiller Station have on the green crab population within the Piscataqua River.

Entrainment and impingement can kill or injure large numbers of the aforementioned aquatic organisms. In some cases, these losses may contribute to diminished populations of local species of commercial and/or recreational importance, locally important forage species, and/or local threatened or endangered species. As a result, CWISs can have effects across the food web. In effect, CWISs can substantially degrade the quality of aquatic habitat by placing within the ecosystem a significant anthropogenic source of mortality to resident organisms. In addition to considering the direct adverse impacts of CWISs, their effects as cumulative impacts or stressors in conjunction with other existing stressors, including CWISs at multiple facilities, on the affected species should also be considered. Furthermore, losses of particular species could contribute to a decrease in the balance and diversity of the ecosystem's overall assemblage of organisms.<sup>92</sup>

Region 1 has made no statements of this kind regarding the effects of entrainment and/or impingement at Schiller Station on the aquatic ecosystem of the Piscataqua River. Instead, the agency has stated time and again in the Fact Sheet that the CWISs at Schiller Station are not causing any environmental impact that is adverse to the waterbody, or that the data and information it has collected over the years is, at worst, inclusive. More is required for Region 1 to legally impose entrainment technology controls at Schiller Station. In actual fact, no such controls are necessary at Schiller Station because the environmental impact that is occurring at the facility is not adverse to the source waterbody. Region 1's BTA determination imposing entrainment controls at the facility therefore lacks foundation, is arbitrary and capricious, and must be revisited by the agency.

**b. AIF at the facility is well below the 125 MGD compliance threshold set out in the final § 316(b) rule**

Schiller Station should not be subject to entrainment controls at all because its daily AIF falls well below the 125 MGD compliance threshold EPA established in the final § 316(b) rule. EPA's reason for establishing a 125 MGD AIF compliance threshold for entrainment is well founded. EPA found that all of the facilities, like Schiller Station, withdrawing less than this

---

<sup>92</sup> Fact Sheet at 88.

amount, combined, represent only 10 percent of the nationwide potential for AEI from entrainment, despite comprising approximately 70 percent of all facilities potentially subject to the final § 316(b) rule.<sup>93</sup> EPA logically concluded in the final rule that the 125 MGD AIF threshold is therefore “justified on a technical basis” and was selected for the purpose of “focus[ing] on the facilities with the highest intake flows and the highest likelihood of causing adverse impacts . . . .”<sup>94</sup> The final rule recognized that facilities like Schiller Station that withdraw fewer than 125 MGD AIF are far less likely to cause entrainment impacts, and it makes practical sense to allow permitting authorities the discretion to require submission of the entrainment studies to make an informed and legally defensible entrainment determination, which often may be that no entrainment controls are justified at all.<sup>95</sup>

EPA recognized in the preamble to the final § 316(b) rule that it is possible a permitting authority may find it necessary to require entrainment compliance for a facility with an average AIF below 125 MGD.<sup>96</sup> Yet, it is clear that EPA expected this to be the exception and not the norm for such facilities because it went to great lengths to explain that the 125 AIF threshold was created to differentiate between larger facilities whose water withdrawals likely pose a significant risk of AEI due to entrainment from those whose withdrawals do not. Were the final rule and/or the agency to presuppose that facilities withdrawing less than 125 MGD AIF would be subject to the same entrainment requirements as those above that intake threshold, EPA’s establishment of the threshold in the first place would be wholly arbitrary, capricious, and as a practical matter, pointless. Therefore, while exemption from entrainment controls is not

---

<sup>93</sup> 79 Fed. Reg. at 48,309.

<sup>94</sup> *Id.*

<sup>95</sup> *Id.* at 48,309–10.

<sup>96</sup> *Id.* at 48,361 (“not[ing] that facilities below the 125 mgd threshold are not automatically exempt from entrainment requirements”).



“automatic,” the final rule, at a minimum, presupposes that a facility withdrawing less than 125 MGD AIF likely represents little to no impact to aquatic organisms and thus need not specifically be forced to install costly entrainment compliance controls unless the information available to a permitting authority in fact indicates otherwise.

EPA promulgated entrainment control standards in the final rule to “establish[] a detailed specific framework for determining BTA entrainment control requirements,” a critical component of which is requiring that certain information be collected by the facility and submitted to the permitting authority for consideration in making the BTA determination on a site-specific basis.<sup>97</sup> Indeed, EPA requires that entrainment BTA determinations be based upon the specific information provided in a number of specific studies that only facilities withdrawing greater than 125 MGD AIF are required to collect and submit. EPA’s Technical Development Document accompanying the final § 316(b) rule highlights the importance of the permitting authority’s access to these site-specific studies, explaining that the purpose of the requirement is to allow “the permit writer [to] have access to all the information necessary for an informed decision about [a site-specific BTA determination] . . . to reduce entrainment mortality at facilities above 125 MGD AIF.”<sup>98</sup> Thus, the requirement to collect and submit specific information about entrainment impacts is inherently tied to the underlying entrainment BTA requirements.

Exempting a facility from submitting “information necessary for an informed decision” about the appropriateness of entrainment controls, yet purporting to make such a decision in the absence of that “necessary” information, defies logic and defeats the purpose of the entrainment study requirement altogether. Permitting authorities enjoy discretion to request specific

---

<sup>97</sup> *Id.* at 48,330.

<sup>98</sup> Proposed § 316(b) TDD at 7-7 (emphasis added).

entrainment-related information from a facility with an AIF below 125 MGD.<sup>99</sup> Yet, one must presume that such requests are meant to be reserved for facilities that fall just below this threshold because they are causing significant AEI due to high entrainment losses, meaning further study of entrainment AEI is warranted. That is not the case with Schiller Station, however.

Within the context of the national framework for regulating entrainment impacts from CWISs, including its policies of focusing on facilities most likely to cause AEI (i.e., those withdrawing greater than 125 MGD AIF) and ensuring that “informed decisions” regarding BTA determinations are based upon comprehensive, site-specific entrainment studies, Region 1’s entrainment BTA determination for Schiller Station is unfounded. Region 1’s own determination that it has found “no evidence that entrainment and/or impingement losses at Schiller Station are causing or significantly contributing to declines in local populations of the affected species of aquatic organisms or to disruptions in the local community or assemblage of organisms in the Piscataqua River”<sup>100</sup> renders arbitrary and capricious Region 1’s site-specific entrainment BTA determination at Schiller. The fact that the agency issued this incongruent decision without the benefit of any of the information that EPA itself recognizes in the final rule as “necessary to make an informed decision” further highlights the fact that the agency’s proposed BTA determination is the epitome of arbitrary and capricious decision-making.

Despite Schiller Station falling well below EPA’s policy-driven compliance threshold for entrainment, and its blatantly minimal impacts on the Piscataqua River (explained in detail below), Region 1 has chosen to rigidly apply the BTA entrainment standard to Schiller Station while selectively ignoring the evidentiary void in its determination. A rigid, across-the-board

---

<sup>99</sup> 79 Fed. Reg. at 48,309.

<sup>100</sup> Fact Sheet at 158 (emphasis added).

BTA determination is precisely what EPA intended to avoid in promulgating the national § 316(b) standards, particularly as applied to smaller, low-impact facilities:

EPA acknowledges that there may be circumstances where flexibility in the application of the rule may be called for and the rule so provides. . . . [T]he flexibilities contained in the rule for the Director to consider the site-specific characteristics of each intake structure within the national standard provide a useful mechanism for facilities with lower intake flows and low impacts to be considered.<sup>101</sup>

Thus, while EPA intended that its new § 316(b) standards apply consistently and predictably to those facilities presenting the most significant AEIs, it recognized that the rule should be applied flexibly and pragmatically to facilities that present little or no environmental impact. Given Schiller Station's lack of impact on the aquatic environment within the waterbody, EPA's national policies of focusing on the most impactful facilities so as to not burden the minimally impactful facilities, and Region 1's lack of pertinent information upon which it was required to base an entrainment BTA determination, the agency's BTA conclusion for entrainment in the Draft Permit is arbitrary and capricious.

**c. Entrainment at Schiller Station is *de minimis***

Region 1's decision that entrainment controls are required at all is puzzling given the negligible potential impact of Schiller Station's CWISs to the robust Piscataqua River. Even without considering the actual waterbody at issue, the AIF for Schiller Station is slight compared to the industry. The data PSNH submitted to Region 1 in the 2014 Enercon Report shows that Schiller Station withdrew an average of 74 MGD AIF during the three-year period of 2011-13.<sup>102</sup> More recent data developed by Enercon and Normandeau shows even less withdrawal (72.4

---

<sup>101</sup> 79 Fed. Reg. at 48,309 (emphasis added).

<sup>102</sup> AR-227 at 21.

MGD AIF) over the span of August 2012 to August 2015.<sup>103</sup> These numbers put Schiller Station near the bottom of the spectrum of all facilities within the industry, which Enercon and Normandeau exhibit in detail in their comments to the Draft Permit.<sup>104</sup> Specifically, even if Schiller Station withdrew water at or near its DIF of 125.8 MGD, the facility would still be within the bottom 23 percent of the nationwide average DIF for once-through cooling water intakes.<sup>105</sup> The fact that Schiller Station's AIF is drastically reduced compared to its DIF, whereas data for the rest of the industry shows little difference between facilities' DIFs and average AIFs, further suggests that the facility's water withdrawals and corresponding entrainment is negligible and/or *de minimis*.<sup>106</sup>

With respect to the Piscataqua River, Region 1's own conclusion that Schiller Station withdraws only 0.5 percent of the waterbody's total flow actually overstates the potential impact.<sup>107</sup> In reality, the CWISs at the facility have the design capability to withdraw less than 0.003 percent of the river's total volume and have actually withdrawn more modest volumes of water over the past three years that constitute a mere 0.0018 percent of the peak Piscataqua River withdrawal zone flow during each tidal cycle.<sup>108</sup> Given these miniscule numbers, Schiller Station's actual impact on surrounding aquatic organisms can be nothing beyond *de minimis*.

---

<sup>103</sup> 2016 Enercon-Normandeau Comments at 21.

<sup>104</sup> *See id.* at 21-25.

<sup>105</sup> *Id.* at 23.

<sup>106</sup> *See id.* at 24-25. In fact, Region 1 discusses entrainment impacts only in terms of estimates of the "worst case," with Schiller Station operating at or near the DIF for the CWISs. *See* Fact Sheet at 92-97. This means that the numbers set out in the Fact Sheet are estimates of the maximum number of organisms that could have been impinged and entrained if all three units at Schiller Station had operated year-round at full flow, rather than the number that actually were or are reasonably expected to be impinged and entrained under historical operating conditions. Over the last three years, the capacity factors for Units 4 and 6 at Schiller Station have been around 20 percent and the capacity factor for Unit 5 has been around 85 percent. These operational realities mean considerably fewer organisms have been impinged or entrained than the numbers Region 1 has presented in its Fact Sheet. Region 1's failure to acknowledge these impingement and entrainment decreases is arbitrary and capricious.

<sup>107</sup> *See id.* at 158.

<sup>108</sup> 2016 Enercon-Normandeau Comments at 10.

Notably, PSNH's *de minimis* assertion based on the percentage of water withdrawn by the CWISs at Schiller Station compared to the overall flows of the Piscataqua River is consistent with the specific example EPA included in its final § 316(b) rule for illustrating when impingement impacts from a CWIS governed by the rule are negligible and therefore warrant no further regulation by the agency. EPA specifically provided:

EPA acknowledges that there may be circumstances where flexibility in the application of the rule may be called for and the rule so provides. For example, some low flow facilities that withdraw a small proportion of the mean annual flow of a river may warrant special consideration by the Director. As an illustration, if a facility withdraws less than 50 mgd AIF, withdraws less than 5 percent of mean annual flow of the river on which it is located (if on a river or stream), and is not co-located with other facilities with CWISs such that it contributes to a larger share of mean annual flow, the Director may determine that the facility is a candidate for consideration under the de minimis provisions contained at § 125.94(c)(11). In the case of facilities on lakes and reservoirs, co-location would be better determined by multiple CWIS facilities on the same waterbody, rather than distance.

In either case, the flexibilities contained in the rule for the Director to consider the site-specific characteristics of each intake structure within the national standard provide a useful mechanism for facilities with lower intake flows and low impacts to be considered.<sup>109</sup>

The AIF at Schiller Station is slightly higher than the 50 MGD included in EPA's example. Yet, the percentage of water withdrawn by the facility (0.0018 percent) is significantly lower than the five percent discussed by the agency. EPA expressly provides in the excerpt above that its discussion is merely illustrative and does not establish concrete thresholds above which no facility may qualify for the exemption. Therefore, it is safe to assume that EPA would have no

---

<sup>109</sup> 79 Fed. Reg. at 48,309 (emphasis added). The fact that EPA primarily discusses the *de minimis* standard in the context of a river or stream does not mean its application is so limited. EPA's discussion is meant to be illustrative and it makes perfect sense that the agency would address the *de minimis* standard in the context of a river or stream given that the majority of CWISs subject to the final § 316(b) rule are located along waterbodies of this kind. The agency's subsequent discussion of lakes and reservoirs within this excerpt supports this conclusion. Moreover, EPA concludes its discussion by expressly providing that "the flexibilities contained in the rule for the Director to consider the site-specific characteristics of each intake structure within the national standard provide a useful mechanism for facilities with lower intake flows and low impacts to be considered." *Id.* (emphasis added). This confirms EPA intended for the *de minimis* exception to be available to every facility that may potentially qualify—including PSNH's Schiller Station.

issue considering application of the *de minimis* exception at a facility with a slightly higher AIF that is more than counterbalanced by a comparatively low percentage of the overall waterbody withdrawn, or vice versa. It is the infinitesimal percentage of overall water withdrawn from the Piscataqua River that places the CWIS operations at Schiller Station in proper perspective and clearly demonstrates that the impacts to the source waterbody, if any, are *de minimis* and warrant no further technologies to address entrainment. Region 1's contrary conclusion that such a negligible impact from entrainment is somehow "adverse"—and thus warranting BTA control—is unsupported by the record and thus arbitrary and capricious.

Further, Region 1 is inconsistent throughout the Fact Sheet in how it evaluates historical entrainment impacts at Schiller Station and the expected performance of various compliance options to further reduce the already *de minimis* levels of entrainment occurring at the facility. The agency relies upon absolute numbers of fish and macrocrustacean eggs and larvae at certain points in the Fact Sheet,<sup>110</sup> equivalent adult numbers at others,<sup>111</sup> and also improperly compares the numbers of fish and macrocrustaceans from different life stages in other portions of the Fact Sheet.<sup>112</sup> Region 1's inconsistencies in this regard are arbitrary and capricious, conflict with the established practice of EPA and the scientific community of utilizing adult equivalency numbers to properly estimate actual impacts to fish populations and, in turn, evaluate the costs and true

---

<sup>110</sup> See, e.g., Fact Sheet at 150–53 (utilizing absolute entrainment loss values in Tables 10-A and 10-B without addressing the difference in life stage value or the benefit of returned eggs and larvae to the Piscataqua River).

<sup>111</sup> See, e.g., *id.* at 110 (relying upon equivalent adult calculations in Table 9-A to assess efficacy of CWW screens).

<sup>112</sup> See, e.g., *id.* at 134 (utilizing numbers in Table 9-C that include organisms from different life stages in the different months and, therefore, cannot reasonably and fairly be compared without converting these numbers to equivalent adults).

relative benefits of the various BTA compliance options,<sup>113</sup> and therefore undercut the agency's ultimate entrainment conclusions for Schiller Station.

Region 1 attempts to justify its uneven analysis of Schiller Station's entrainment impacts by criticizing the equivalency method for supposedly omitting the value fish and ichthyoplankton have in providing a food source to many species within the ecosystem:

Adult equivalent analyses may be useful when trying to place the loss terms of fish and macrocrustacean eggs and larvae into the context of grown fish and in order to combine entrainment and impingement losses into a single metric. When looking at the efficiencies of any control technologies, however, EPA believes that the actual numbers of eggs and larvae saved or lost provides the more appropriate metric. Eggs and larvae have their own inherent ecological value as important components of the food web. This value is ignored or hidden if losses are only considered in terms of adult equivalents.<sup>114</sup>

Notably, Region 1 cites to no authority to support its "belief." Even if it had, the agency's critiques are unfounded here. The equivalency method Normandeau utilized in its analysis does not omit the value entrained ichthyoplankton and impinged fish may have in providing a food source to many species within the ecosystem. This is true even if 100 percent mortality is assumed for impingement and entrainment<sup>115</sup> because the dead and moribund organisms are discharged back to the source waterbody where they can be consumed by predators or recycled as nutrients. Thus, the biomass and organic carbon of organisms impinged and entrained is not lost to the system and will continue to play a role in the estuarine ecology.

---

<sup>113</sup> See, e.g., 69 Fed. Reg. 41,576, 41,586 (July 9, 2004) (providing that "expressing impingement mortality and entrainment losses as [adult] equivalents is an accepted method for converting losses of all life stages into individuals of an equivalent age and provides a standard metric for comparing losses among species, years, and facilities").

<sup>114</sup> Fact Sheet at 137; see also *id.* at 115 ("EPA considers adult equivalents, but also focuses on absolute loss numbers of eggs and larvae when making control decisions. Basing decisions solely on adult equivalents would ignore the valuable ecological role eggs and larvae play in the food chain."); *id.* at 134 ("EPA makes control decisions based on consideration of the absolute numbers of eggs and larvae lost, not necessarily solely on adult equivalents. Basing decisions solely on adult equivalents would ignore the valuable ecological role that eggs and larvae play in the food chain.").

<sup>115</sup> PSNH assumes 100 percent mortality for the sake of argument. In fact, some entrainment survival is likely at Schiller Station given, among other reasons, that a number of species entrained are hardier species.

PSNH can only assume Region 1 has chosen to use comparatively high numbers of entrained early-life organisms to rationalize its environmental impact assertions and corresponding BTA determinations. There can be no other reasonable justification for why the agency elects to use these inflated numbers when doing so does not provide a true depiction of what AEI, if any, is actually occurring in a given waterbody. In fact, utilizing absolute numbers skews the evaluation the contribution of different life stages of organisms have on the impacts to a source waterbody, if any.<sup>116</sup> This is especially true for organisms within the Piscataqua River given that such a small fraction of the overall waterbody is withdrawn by operations at Schiller Station and because most of the species at issue exhibit either “periodic” or “opportunistic” life history traits, as explained in the 2016 Enercon-Normandeau Comments as follows:

From an ecological perspective, periodic species are characterized by high fecundity (i.e., they spawn a large number of eggs), relatively large size, and long life spans during which females may spawn many times. Winter Flounder is an example of a periodic species entrained at the Station. Opportunistic species entrained at the Station are characterized by small body size, short life spans, and the ability to disperse offspring widely throughout the environment. Green Crab is an example of an opportunistic species entrained at the Station. Periodic and opportunistic traits are advantageous to fish or macrocrustacean species that live in unstable or unpredictable environments, such as the north temperate waters of the Gulf of Maine and the Piscataqua River / Great Bay estuary, which experience significant seasonal and between-year variation in environmental conditions (e.g., temperature, storm events, etc.). It is also likely that the opportunistic life history of Green Crabs enabled them to successfully establish abundant populations in Gulf of Maine waters and in the Piscataqua River as an invasive species. The reproductive strategies of these organisms living in these unstable environmental conditions, including the very large numbers of eggs produced, ensure that sufficient offspring will survive to sustain the populations from year-to-year, even in unpredictable environments.<sup>117</sup>

Figure 2-1 in the 2016 Enercon-Normandeau Comments depicts the survivorship curve of the Winter Flounder and puts the above-referenced comments in proper context by demonstrating

---

<sup>116</sup> See 2016 Enercon-Normandeau Comments, at 15-16.

<sup>117</sup> *Id.* at 13-14 (citations omitted).



that a miniscule number of eggs and larvae of organisms subject to entrainment at Schiller Station would survive to adulthood even in the absence of the facility’s CWISs:

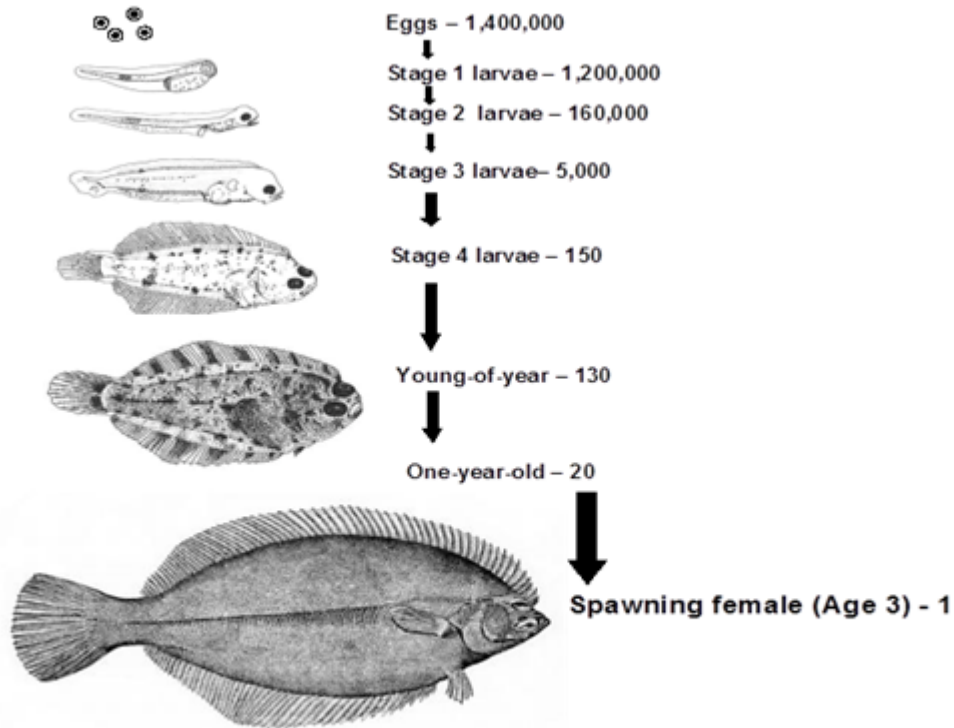

Figure 2-1: Example illustrating the decline in abundance of Winter Flounder life stages from spawning to adulthood based on published life history parameters<sup>3</sup>.

Only one out of 1.4 million Winter Flounder eggs is likely to survive in waters similar to the Piscataqua River to become a three-year-old spawning fish—one.<sup>118</sup> Moreover, nearly 99 percent of the eggs die of natural causes within 60 days following spawning. Remarkably, fecundities of other abundant fish and macrocrustacean taxa typically entrained by CWISs at Schiller Station are roughly equivalent to the Winter Flounder and/or are comparatively higher than the median taxa. Furthermore, like the Winter Flounder, early life stages of these other abundant fish and macrocrustacean taxa typically entrained by the facility’s CWISs also

<sup>118</sup> *Id.* at 15.

experience high levels of natural mortality.<sup>119</sup> Enercon and Normandeau aptly provide that it is because of the “exponential decrease in numbers of fish due to natural mortality” that EPA and the scientific community provide “estimates of the life stages of both fish and macrocrustaceans entrained . . . as both absolute numbers and their equivalent adults” because “counts of total numbers entrained reveal nothing meaningful about the potential adverse impact of . . . CWISs on the relevant adult populations.”<sup>120</sup> “The correct and biologically equitable way for [Region 1] to compare the benefits of different technologies or operational measures that act selectively on the different life stages of fish and macrocrustaceans entrained at [Schiller] Station (such as screening technologies) is by making these comparisons using the equivalent adult values provided in a revised fact sheet.”<sup>121</sup>

Inconsistently comparing numbers of different life stages of organisms is not technically and/or biologically correct and skews Region 1’s overall analysis of the benefits each compliance option will actually provide. Utilizing equivalency analyses permits the agency to know what truly may be gained by reducing entrainment and allows informed judgments about whether it is worth the adverse impacts of the various alternatives. And, in the present context, adult equivalency numbers put biological losses from operation of Schiller Station’s CWISs into proper perspective and demonstrate that such operations result in no environmental impact that is adverse to the aquatic environment of the Piscataqua River.

### **3. Modified traveling water screens with an upgraded fish return system constitute BTA for the CWISs at Schiller Station**

Establishing BTA for impingement mortality is what remains following the conclusion that analyses and a BTA determination for entrainment are not required and/or necessary for

---

<sup>119</sup> *Id.* at 16.

<sup>120</sup> *See id.* at 15-16.

<sup>121</sup> *Id.* at 16.

Schiller Station, for the reasons explained above. It is PSNH's sole decision as to which of the seven pre-approved impingement technology compliance options set out in 40 C.F.R. § 125.94(c) it will install and operate at Schiller Station.<sup>122</sup> Region 1 did not consult with PSNH regarding which of the seven prescribed compliance options the company would utilize at Schiller Station to comply with the impingement mortality standard. Instead, the agency unilaterally determined fine-mesh CWW screens with a design through-screen velocity of 0.5 fps or less would satisfy § 125.94(c)(2) without the benefit of any input from PSNH.<sup>123</sup> Region 1's impingement mortality compliance determination runs counter to the intent of the final § 316(b) rule and is therefore arbitrary and capricious.

Instead of fine-mesh CWW screens, PSNH's choice for compliance with the impingement mortality standards set out in 40 C.F.R. Part 125 would be to install modified traveling water screens and upgraded fish handling systems for its CWISs at Schiller Station. To fulfill this compliance option, PSNH must install and operate infrastructure that Region 1 determines meets the following definition:

*Modified traveling screen* means a traveling water screen that incorporates measures protective of fish and shellfish, including but not limited to: Screens with collection buckets or equivalent mechanisms designed to minimize turbulence to aquatic life; addition of a guard rail or barrier to prevent loss of fish from the collection system; replacement of screen panel materials with smooth woven mesh, drilled mesh, molded mesh, or similar materials that protect fish

---

<sup>122</sup> 40 C.F.R. § 125.94(c)(1)–(7); *see also* 40 C.F.R. § 122.21(r)(6) (providing that an owner or operator must identify its chosen method of compliance with the impingement mortality standard in its permit application); 79 Fed. Reg. at 48,325 (expressly stating that the decision of which impingement mortality compliance option will be employed is a choice for the facility, by providing “EPA modified the rule language so as to state clearly that a facility with multiple intakes must decide whether it will adopt a single compliance strategy for impingement mortality for the entire facility or adopt an intake-specific compliance strategy at each cooling water intake. Thus, facilities may select different compliance strategies for different intakes, providing flexibility at facilities with multiple intakes. Regardless of which impingement compliance approach a facility chooses . . . .”) (emphasis added).

<sup>123</sup> Fact Sheet at 166–67. The October 2008 Enercon-Normandeau Report and October 2014 Enercon Report evaluate the feasibility of a number of impingement mortality compliance standards. *See generally* AR-140; AR-227. However, neither report offers PSNH's preferred compliance method in light of the tenets of EPA's final § 316(b) rule. *See id.*

from descaling and other abrasive injury; continuous or near-continuous rotation of screens and operation of fish collection equipment to ensure any impinged organisms are recovered as soon as practical; a low pressure wash or gentle vacuum to remove fish prior to any high pressure spray to remove debris from the screens; and a fish handling and return system with sufficient water flow to return the fish directly to the source water in a manner that does not promote predation or re-impingement of the fish, or require a large vertical drop. The Director may approve of fish being returned to water sources other than the original source water, taking into account any recommendations from the Services with respect to endangered or threatened species. Examples of *modified traveling screens* include, but are not limited to: Modified Ristroph screens with a fish handling and return system, dual flow screens with smooth mesh, and rotary screens with fish returns or vacuum returns.<sup>124</sup>

To ensure this compliance measure is optimized to minimize impingement mortality, PSNH intends to complete the site-specific impingement technology performance optimization study described in 40 C.F.R. § 122.21(r)(6)(i), which includes two years of biological sampling.<sup>125</sup>

PSNH has chosen this impingement compliance method because it involves a relatively quick and straightforward modification to the existing CWISs at Schiller Station that will permit the facility to comply with the final § 316(b) rule within a shorter time period compared to the installation of fine-mesh CWW screens.<sup>126</sup> This is because the CWISs for Units 4, 5, and 6 at Schiller Station currently utilize traveling water screens and a fish handling return system, meaning a retrofit to install the new modified screens and upgrade the existing fish handling systems will not require extensive reconfiguration, design planning, and/or require PSNH to obtain regulatory permits, all of which would have been necessary for installing fine-mesh CWW screens. In addition, pilot testing will not be required prior to the installation of the chosen technologies. Operation and maintenance costs for the modified screens are not expected to be substantially higher than the costs PSNH annually incurs with its existing traveling screens, as

---

<sup>124</sup> 40 C.F.R. § 125.92(s)(emphasis in original).

<sup>125</sup> See 40 C.F.R. § 122.21(r)(6)(i).

<sup>126</sup> This shorter compliance period means greater environmental improvements will be realized at Schiller Station at an earlier date.

well, and the chosen technological option provides an additional advantage inasmuch as employees at Schiller Station are already familiar with the operation and maintenance of screens of this kind.

PSNH has chosen to install modified traveling screens with upgraded fish handling systems at Schiller Station also because the pre-approved compliance option has an established track record of success within the industry. EPA's Technical Development Document from the final § 316(b) rule accurately captures this reality:

Modified traveling screens with fish handling systems are among the oldest technologies developed specifically to address impingement and have been widely deployed and studied throughout the United States. Because so many existing facilities already use conventional traveling screens, modified traveling screens are broadly applicable and may not require significant changes to the CWIS to achieve high levels of performance. A successful installation is generally independent of factors such as waterbody type, climate zone, age, fuel type, or intake flow. In other words, a facility that has previously used a conventional traveling screen (nearly all facilities, operating under a wide variety of conditions) should also be able to employ a modified traveling screen.

Compared with other impingement design and construction technologies used as retrofit options, modified traveling screens are relatively easy to install and operate. Changes to the screens themselves are relatively straightforward and, in all but the most unique instances, do not require substantial modification or expansion of the screen houses and can be completed during normal maintenance outages without affecting the facility's generating schedule. Likewise, because this technology does not alter the cooling water flow per se, the facility's generating output is unaffected; no energy penalty is incurred save for the small increase in electrical usage due to continual or more frequent screen rotation.<sup>127</sup>

While fine-mesh CWW screens may be technologically feasible for impingement mortality at Schiller Station, unknowns concerning fouling, clogging, icing, and the corresponding need for emergency bypass (all of which are explained in detail below) substantially increases the operational risks associated with deploying this technological option

---

<sup>127</sup> Final 316(b) TDD at 6-31 to 6-32 (emphasis in original).

in an estuarine environment.<sup>128</sup> These unknowns are discussed more fully below and in Appendix 2 of the 2016 Enercon-Normandeau Comments, along with an examination of the fact that fine-mesh CWW screens have not been installed at any facility located along an estuary that is ecologically similar to the lower Piscataqua River.<sup>129</sup>

Although no explanations for a chosen impingement mortality compliance method are required by the final § 316(b) rule, the aforementioned analyses provide ample justification for PSNH's determination to install modified traveling screens with upgraded fish handling systems at Schiller Station. PSNH respectfully requests that Region 1 revise the final permit accordingly to reflect the company's chosen impingement mortality compliance method.

**4. Additional evaluations and data must be provided to Region 1 to adequately evaluate entrainment at Schiller Station if the agency erroneously requires entrainment compliance**

For the reasons set out above, technological installations to address entrainment at Schiller Station are unwarranted and the installation of modified traveling water screens and upgraded fish handling systems for the CWISs at the facility constitute BTA for CWA § 316(b). Should Region 1 improperly reject these well-reasoned conclusions, the agency must allow PSNH to submit additional analyses that will provide Region 1 at least the minimum amount of information the agency would need to make a reasoned and legally defensible BTA entrainment determination. The final § 316(b) rule requires as much: "BTA standards for entrainment . . . must reflect the [permitting authority's] determination of the maximum reduction in entrainment warranted after consideration of the relevant factors as specified in § 125.98."<sup>130</sup> PSNH has not

---

<sup>128</sup> The fact that CWW screens are located offshore and underwater further compounds these issues and makes identifying and troubleshooting them much more difficult compared to the configuration of the existing intakes at Schiller Station.

<sup>129</sup> See 2016 Enercon-Normandeau Comments at Appx. 2.

<sup>130</sup> See 40 C.F.R. § 125.94(d); see also 79 Fed. Reg. at 48,330 ("While site-specific permit requirements are not new, what is different about this approach from the current requirement for permits to include 316(b) conditions

previously submitted to Region 1 a number of fundamental analyses the agency would need to adequately assess the factors set out in § 125.98 and make a rational BTA determination for entrainment at Schiller Station. These analyses have not previously been completed because Region 1 has not requested them and because they are not mandated by the final § 316(b) rule for facilities with actual intake flows equivalent to those at Schiller Station.<sup>131</sup> Without these essential analyses, Region 1 cannot possibly render a reasonable and rational BTA determination for entrainment. The agency's contrary assertion "that the information already submitted by the Facility is sufficient"<sup>132</sup> to support its permit decision is therefore arbitrary and capricious.

As outlined in the Legal Background section above, the final § 316(b) rule requires operators with CWISs to submit an array of information with their NPDES permit application.<sup>133</sup> Some application requirements apply to "all existing facilities" while others apply only to existing facilities that withdraw greater than 125 MGD AIF of water for cooling purposes.<sup>134</sup> Information that is crucial to rendering an informed decision on entrainment compliance is made applicable to only existing facilities that withdraw greater than 125 MGD AIF of water for cooling purposes, including an Entrainment Characterization Study, Comprehensive Technical Feasibility and Cost Evaluation Study, a Benefits Valuation Study, and a Non-water Quality and

---

is that for the first time, EPA is establishing a detailed specific framework for determining BTA entrainment control requirements. Thus, the rule identifies what information must be submitted in the permit application, prescribes procedures that the Director must follow in decision making and factors that must be considered in determining what entrainment controls and associated requirements are BTA on a site-specific basis.").

<sup>131</sup> 40 C.F.R. § 122.21(r)(1)(ii)(C) provides Region 1 discretionary authority to compel PSNH to submit any additional information the agency determines is necessary for determining permit conditions and requirements. *See id.* § 122.21(r)(1)(ii)(C); *id.* § 125.98(i). Region 1 has made no such requests of PSNH for this permit renewal proceeding.

<sup>132</sup> Fact Sheet at 84.

<sup>133</sup> *See generally* 40 C.F.R. § 122.21(r).

<sup>134</sup> *See, e.g., id.* § 122.21(r)(1)(ii)(A), (B).

Other Environmental Impacts Study.<sup>135</sup> With an average AIF at Schiller Station of 72.4 MGD over the past three years, PSNH was not required to complete and/or submit any of these entrainment analyses with its permit application and Region 1 has not requested these materials in order to properly evaluate entrainment at the facility. The agency should request entrainment analyses of this kind prior to issuing the Draft Permit as final.

It makes practical sense for Region 1 to demand the submission of the entrainment studies required by EPA's final § 316(b) rule—or studies that are substantially equivalent—in order to make a reasoned and legally defensible entrainment determination for Schiller Station. To proceed otherwise defies logic in light of EPA's discussion of the basis of its 125 MGD AIF threshold in the final rule. In that rulemaking, EPA expressly acknowledged that mandating the submission of specific entrainment studies from only those facilities with an AIF exceeding 125 MGD would ensure that 90 percent of the total overall flows for the facilities subject to the final rule<sup>136</sup> with “the highest likelihood of causing adverse impacts” from entrainment<sup>137</sup> would be addressed. Recall this 90 percent of flows is distributed across only 30 percent of the total number of existing facilities subject to the final § 316 rule.<sup>138</sup> This leaves only 10 percent of the remaining overall flows spread across the remaining 70 percent of facilities that are subject to the final § 316 rule. PSNH's Schiller Station is one of the facilities included in this 70 percent.

Given this background, Region 1 arguably needs as much if not more specific and/or detailed information regarding entrainment at Schiller Station because the agency's maximum potential reduction in entrainment impacts is diminutive compared to the maximum potential at

---

<sup>135</sup> See *id.* § 122.21(r)(9)–(12).

<sup>136</sup> Final 316(b) TDD at 3-8.

<sup>137</sup> 79 Fed. Reg. at 48,309.

<sup>138</sup> Final 316(b) TDD at 3-8 (providing that the 125 MGD AIF “threshold will capture 90 percent of the actual flows but will apply only to 30 percent of existing facilities”).



facilities with an average AIF of 125 MGD or more—where impacts due to entrainment may more rationally be assumed and corresponding, meaningful reductions in entrainment can therefore be expected. Providing less entrainment-related information to the agency than is required for facilities with an average AIF of 125 MGD or more means Region 1 is forced to make an arguably more difficult and precise determination regarding entrainment compliance with a fraction of the information it will have at its disposal for larger-flow facilities already presumed to have a significant impact due to entrainment. This perverse reality in this permit renewal proceeding cannot be what EPA intended when it crafted the final § 316(b) rule.<sup>139</sup>

The information pertaining to entrainment PSNH has previously submitted to Region 1 does not serve as an adequate surrogate for the Entrainment Characterization Study, Comprehensive Technical Feasibility and Cost Evaluation Study, a Benefits Valuation Study, and a Non-water Quality and Other Environmental Impacts Study facilities with an average AIF of 125 MGD or more are required to submit pursuant to the final § 316(b) rule.<sup>140</sup> PSNH should be permitted to submit analyses of this kind if Region 1 remains determined to require additional technological controls at Schiller Station to address entrainment. These analyses are imperative for the agency to sufficiently evaluate all of the mandatory BTA factors set out in 40 C.F.R. § 125.98(f). Without them, Region 1 cannot and has not rendered a BTA determination that can withstand judicial scrutiny.

**a. Entrainment Characterization Study**

An Entrainment Characterization Study, outlined in 40 C.F.R. § 122.21(r)(9), requires at least two years of entrainment data, identifying and documenting “organisms collected to the

---

<sup>139</sup> In fact, it is not and this analysis further supports PSNH’s primary argument that requiring technological upgrades at the facility due to entrainment is not necessary given that Schiller Station has an average AIF far below 125 MGD and because entrainment at Schiller Station is *de minimis* and results in no environmental impact that is adverse to the aquatic ecosystem of the Piscataqua River.

<sup>140</sup> See 40 C.F.R. § 122.21(r)(9)–(12).

lowest taxon possible of all life stages of fish and shellfish that are in the vicinity of the cooling water intake structure(s) and are susceptible to entrainment . . . .”<sup>141</sup> PSNH did submit an impingement and entrainment report performed by Normandeau from August 2006 through September 2007.<sup>142</sup> And, while this report may provide certain information that must be included in the Entrainment Characterization Study prescribed by the rule, it does not include data and analyses from a two-year minimum data collection period that offers the increased likelihood of revealing seasonal variation and/or anomalies that may go undiscovered in smaller data sets. Before Region 1 makes its final BTA determination, PSNH should be allowed to submit additional information that captures at least the minimum two years of entrainment data required by the final § 316(b) rule for facilities with an average AIF of greater than 125 MGD.

**b. Comprehensive Technical Feasibility and Cost Evaluation Study**

A high-level analysis of the technological feasibility of various entrainment and impingement technologies was included in the October 2008 Enercon-Normandeau Report<sup>143</sup> PSNH submitted in response to Region 1’s CWA § 308 information request and contains some rudimentary information that corresponds with certain data requirements of the Comprehensive Technical Feasibility and Cost Evaluation Study outlined in the final § 316(b) rule.<sup>144</sup> The budgetary estimates provided in the October 2008 Enercon-Normandeau Report simply are not detailed enough to comply with the requirements set out in 40 C.F.R. § 122.21(r)(10), however, and therefore cannot be utilized in a cost evaluation study. And, even if this 2008 information could be deemed sufficient, which it is not, it at a minimum must be updated to: (1) provide more

---

<sup>141</sup> See *id.* § 122.21(r)(9).

<sup>142</sup> See AR-136.

<sup>143</sup> See AR-140.

<sup>144</sup> See 40 C.F.R. § 122.21(r)(10).

detailed and current cost and schedule estimates for all potentially viable entrainment technologies; (2) ensure any new entrainment technologies that have been developed in the intervening eight years are evaluated and included; and (3) include discussions of the performance of these entrainment technologies that reflect all of the relevant information the industry has learned over the past eight years about the biological and operational efficacy of them.<sup>145</sup> Moreover, submission of the Comprehensive Technical Feasibility and Cost Evaluation Study, or a comparable analysis, would allow Region 1 to assess the amount of time it would take PSNH to implement each of the potentially viable technologies and permit the agency to determine whether the varying implementation timeframes should be considered as part of the BTA determination. This analysis is lacking in Region 1's current BTA determination.

A great deal has in fact been learned about the efficacy of CWW screens in the years that have passed since the submission of the October 2008 Enercon-Normandeau Report. This 2008 report presented reductions in entrainment mortality for CWW screens of various slot widths as a function of physical exclusion alone.<sup>146</sup> In the intervening years, additional research of CWW screens has revealed that at least two additional mechanisms play a key role in achieving entrainment mortality reductions with the technology: hydraulic bypass and larval avoidance.<sup>147</sup> Enercon and Normandeau provide an in-depth discussion of these phenomena in their comments

---

<sup>145</sup> The estimates for CWW screens included in the 2014 Enercon Report are likewise immaterial because they outlined costs for 9.5 mm slot-width screens chosen to minimize impingement at the facility, only capture the cost of major items, and do not take into account any contingencies or other allowances. *See* AR-227 at 38–39 (Region 1 has been provided unredacted versions of the cost estimates included on these pages). The cost to install CWW screens with slot-widths less than 9.5 mm would be greater. *See* 2016 Enercon-Normandeau Report at 31.

<sup>146</sup> *See* AR-140 at 85.

<sup>147</sup> These mechanisms had been mentioned in scientific literature prior to 2008. Sufficient testing had not yet been performed on the phenomena, however, meaning the scientific community was unable to quantify the extent of the role hydraulic bypass and larval avoidance contributed to the efficacy of CWW screens at the time Enercon and Normandeau provided their joint report to PSNH in 2008.

to this Draft Permit.<sup>148</sup> A review of those comments reveals that the data presented in the October 2008 Enercon-Normandeau Report is outdated, underestimates the overall effectiveness of CWW technology, and perhaps overestimates or inflates the role of exclusion (i.e., slot-width) in the overall efficacy of the CWW screens.

As to hydraulic bypass, the Electric Power Research Institute provides:

Previous studies have shown that the following conditions are important for preventing or reducing entrainment and impingement associated with wedgewire screens (EPRI 1999): (1) a sufficiently small slot size to physically block passage of the smallest life stages to be protected; (2) low through-slot velocity (i.e., the water velocity between the wedgewire slots) to minimize the hydraulic zone of influence in which passive or weak swimming organisms can become entrained; and (3) an adequate ambient velocity (i.e., “sweeping” velocity) passing across a screen to carry organisms and debris along and away from the screen. When all of these factors exist, it is expected that the biological effectiveness of wedgewire screens will be high. However, large reductions in entrainment and impingement may occur when sub-sets of these conditions exist. For example, low through-slot velocities and high approach velocities may reduce entrainment and impingement to acceptable levels, even when aquatic organisms are physically capable of passing through slots.<sup>149</sup>

This ratio of a sweeping velocity to the through-slot velocity plays a significant role in the effectiveness of CWW screens in a given waterbody. The faster the sweeping velocity, the more

---

<sup>148</sup> See 2016 Enercon-Normandeau Comments at 19-20, Appx. 2 & 3. These phenomena have been discussed and analyzed at length in the ongoing NPDES permit proceeding for the Indian Point Energy Center, as well. A February 12, 2010 report (attached hereto as Exhibit 2) prepared by Enercon, with assistance from a number of biologists including Normandeau, presents data that accounts for entrainment reductions due to hydraulic bypass and larval avoidance and reveals that the difference in the percent reduction in impingement and entrainment losses among CWW screens with slot-widths ranging in size from 1.0 to 9.0 mm is essentially negligible. See Exhibit 2 at 62 (Table 4.4). Attachment 6 to this February 12, 2010 report outlines the underlying data, research, modeling, and analyses employed to generate the information set out in Table 4.4.

PSNH has been unable to locate a copy of Attachment 6 to the report through publicly available resources despite knowledge or at least belief that the complete February 12, 2010 report was at one time available to the public via the Internet. Nevertheless, PSNH respectfully requests that Attachment 6 to the February 12, 2010 report be included in the Administrative Record for the Schiller Station NPDES permit renewal proceeding.

The relevant studies and modeling outlined in this February 12, 2010 report pertaining to the Indian Point Energy Center were updated in 2011, according to Normandeau. See 2016 Enercon-Normandeau Comments at Appx. 3, pp.4-5. These updated analyses are not publicly available, however, and PSNH was not able to otherwise obtain a copy of them. See *id.* The company will submit them to the agency for consideration if a copy becomes available at a later date.

<sup>149</sup> EPRI Technical Report 1010112, Field Evaluation of Wedgewire Screens for Protecting Early Life Stages of Fish at Cooling Water Intakes Structures at 1-1 (May 2005).

it is likely that inertia will simply carry otherwise entrainable organisms right past CWW screens—irrespective of the slot-width of the screens—without issue. Correctly aligning the slot openings of the screens relative to the sweeping flow direction(s) can also have a major impact on the amount of aquatic organisms that become entrained versus those that are simply carried right past the CWW screens due to hydraulic bypass.<sup>150</sup>

The sweeping velocity of the Piscataqua River is one of the fastest in the northeastern United States within the vicinity of Schiller Station.<sup>151</sup> This means the effectiveness of any CWW screens installed at the facility may very well be less of a function of the slot-width of the screens and instead more dependent upon correctly aligning the openings in the screens within the waterbody to take advantage of the hydraulic bypass that will occur due to the swift currents.<sup>152</sup> Information provided to Region 1 in the October 2008 Enercon-Normandeau Report does not account for this now-known reality for evaluating the effectiveness of CWW screens. This 2008 information is therefore outdated and cannot be relied upon to support a BTA determination.

Larval avoidance is a phenomenon unique to CWW screens due to their contrasting design and geometry compared to conventional CWISs. It stems from the understanding that fish larva are capable of swimming fast in short bursts.<sup>153</sup> CWW screens have a relatively small “zone of hydraulic influence,” the scope of which varies depending upon the length of the screen, the through-slot velocity and the sweeping flow. This zone has an inverse relationship

---

<sup>150</sup> See 2016 Enercon-Normandeau Comments at 20.

<sup>151</sup> See US Army Corps of Engineers, Portsmouth Harbor and Piscataqua River Navigation Project, <http://www.nae.usace.army.mil/Missions/CivilWorks/Navigation/NewHampshire/Portsmouth.aspx>. (last visited Jan. 26, 2016) (“The swift currents of the Piscataqua River make Portsmouth Harbor one of the fastest flowing commercial port waterways in the northeastern United States.”).

<sup>152</sup> See 2016 Enercon-Normandeau Comments at 20-21.

<sup>153</sup> See *id.* at Appx. 2, pp. 2-5.

with sweeping flow, meaning as the sweeping flow increases, the zone of hydraulic influence will decrease.<sup>154</sup> Within the zone of hydraulic influence, flow streamlines curve inward as the cooling water enters the screens making organisms more susceptible to entrainment.<sup>155</sup> Outside of this zone, sweeping flows allow aquatic organisms to carry past the CWW screens unimpeded.<sup>156</sup> A single short and fast swimming burst is all fish larva often need to escape the zone of hydraulic influence and avoid becoming entrained by the CWW screens.

As mentioned above, the sweeping velocity of the Piscataqua River is incredibly fast within the vicinity of Schiller Station, meaning a thorough explanation and evaluation of larval avoidance is necessary to properly evaluate the effectiveness of any CWW screens installed at the facility. Like hydraulic bypass, the larval avoidance phenomenon demonstrates yet again that the efficacy of CWW screens is less of a function of the slot-width of the screens and instead more dependent upon other factors unique to the waterbody at issue, including the swiftness of its currents. The information provided to Region 1 in the October 2008 Enercon-Normandeau Report does not account for this ecological discovery that, for the reasons articulated above, will impact the evaluation of the effectiveness of CWW screens. The information included in this 2008 report is therefore outdated and cannot be relied upon by Region 1 to support a BTA determination.

The aforementioned discussions clearly demonstrate that PSNH should be permitted to submit a detailed analysis comparable to the Comprehensive Technical Feasibility and Cost Evaluation Study delineated in the final § 316(b) rule prior to Region 1 rendering its final BTA determination for the facility. Enercon and Normandeau have done a commendable job within

---

<sup>154</sup> *See id.* at 3.

<sup>155</sup> *See id.*

<sup>156</sup> *See id.*

the time allotted for comments to the Draft Permit of collecting and discussing some of the key information Region 1 must evaluate as part of a reasoned BTA determination. More is available and/or could be generated, however. Thus, while PSNH contends technologies to address entrainment at Schiller Station are unwarranted, Region 1 must allow PSNH to submit a detailed analysis comparable to the Comprehensive Technical Feasibility and Cost Evaluation Study so the agency can adequately assess the mandatory factors set out in 40 C.F.R. § 125.98(f) if it continues to believe such compliance controls may be necessary at the facility.

**a. Benefits Valuation Study**

40 C.F.R. § 125.98(f)(4) provides:

If all technologies considered have social costs not justified by the social benefits, or have unacceptable adverse impacts that cannot be mitigated, the Director may determine that no additional control requirements are necessary beyond what the facility is already doing. The Director may reject an otherwise available technology as a BTA standard for entrainment if the social costs are not justified by the social benefits.<sup>157</sup>

Region 1 did not generate a quantitative evaluation of the benefits yield expected if fine-mesh CWW screens are implemented at Schiller Station.<sup>158</sup> Instead, the agency prepared only a high-level qualitative evaluation of the social benefits and utilized the costs of potentially feasible entrainment technologies set out in the October 2008 Enercon-Normandeau Report. This analysis would be feeble, at best, were it based on current and more detailed information; but it is rendered wholly ineffectual by the fact that it relies upon cost estimates that are both out of date

---

<sup>157</sup> See 40 C.F.R. § 125.98(f)(4).

<sup>158</sup> See, e.g., Fact Sheet at 160–61 (“EPA did not attempt to develop a monetized estimate of the full benefits that would accrue to society from the above-discussed impingement mortality and entrainment reductions from the preferred BTA – such as by undertaking a stated preference study or a benefits transfer analysis to estimate non-use benefits for this case – because EPA decided that doing so would be prohibitively difficult, time-consuming and expensive for this permit. No such complete monetized estimate is readily available and it would take many months and substantial cost to attempt to develop such an estimate.”) (footnotes and citations omitted).

and too generalized and benefits analyses so generic that they lack the requisite “rigor” to allow the agency to make an informed determination of BTA at Schiller Station.<sup>159</sup>

PSNH has had no opportunity to submit analyses quantifying the precise social costs and relative benefits of any entrainment technology that could feasibly be installed at Schiller Station. Had it known Region 1 intended to seek to impose technologies at Schiller Station due to entrainment impacts, the company would have commenced such analyses months ago, including but not limited to perhaps the Benefits Valuation Study described in 40 C.F.R. § 122.21(r)(11).<sup>160</sup> The reality is, for the reasons presented above regarding the established 125 MGD AIF threshold, PSNH, Enercon, and Normandeau did not believe entrainment at Schiller Station would be heavily scrutinized by the agency and Region 1 never communicated its intent to do so to anyone within the company.

Once the Draft Permit was issued, PSNH attempted to formulate a benefits valuation study to enable the company to “[q]uantif[y] . . . social benefits and costs of available entrainment technologies” with “sufficient rigor”<sup>161</sup> within the time allotted for comments to the Draft Permit. The ultimate goal of this benefits valuation study PSNH commenced is to determine if any entrainment controls are in fact warranted. PSNH was unfortunately not able to complete its analysis within the time allotted for comments.<sup>162</sup>

PSNH’s other comments to the BTA determinations set out in the Draft Permit should cause Region 1 to revisit its proposed technological requirements for the CWISs at Schiller Station. Should the agency not do so, however, PSNH respectfully requests additional time to

---

<sup>159</sup> See 40 C.F.R. § 125.98(f)(2)(v).

<sup>160</sup> See *id.* § 122.21(r)(11).

<sup>161</sup> *Id.* § 125.98(f)(2)(v).

<sup>162</sup> This is not surprising given that Region 1 acknowledges in its Fact Sheet that developing a benefits study of this kind “would take many months and substantial cost” to develop. Fact Sheet at 161.



develop and complete the benefits valuation study it has commenced and provide it to Region 1 in a timely manner. PSNH should be afforded this opportunity before Region 1 makes its final BTA determination, given that most if not all other operators within the industry subject to the final § 316(b) rule will be compelled, or at least have adequate time and the option, to submit an analysis of this kind so that the threshold question of whether technological controls for entrainment are necessary at their respective facilities may be answered in accordance with the tenets of the final rule.

**b. Non-water Quality and Other Environmental Impacts Study**

Nothing remotely comparable to the Non-water Quality and Other Environmental Impacts Study described in 40 C.F.R. § 122.21(r)(12) has been completed and submitted to Region 1 by PSNH.<sup>163</sup> Studies of this kind typically are generated only after the above-referenced Comprehensive Technical Feasibility and Cost Evaluation Study has been performed. The Non-water Quality and Other Environmental Impacts Study evaluates an array of potential impacts associated with technologies deemed potentially viable following the technological and cost evaluation study, including but not limited to issues of energy consumption, air pollutant emissions, noise, safety, grid and facility reliability, and consumptive water use.<sup>164</sup> Evaluation of these concerns puts § 316(b) technological options being considered into proper perspective by quantifying the totality of environmental impacts expected if ultimately implemented at a given facility.

The entirety of Region 1's evaluation of the non-water quality impacts associated with the installation of fine-mesh CWW screens at Schiller Station consists of the following

---

<sup>163</sup> See 40 C.F.R. § 122.21(r)(12).

<sup>164</sup> See *id.*

conclusory statement: “EPA does not expect any impacts in energy consumption, water quantities in the affected water bodies, air emissions, noise, and visual impacts with these technologies.”<sup>165</sup> More is required to satisfy the tenets of the final § 316(b) rule, meaning Region 1’s superficial statements are arbitrary and capricious and do not provide adequate support for the agency’s ultimate BTA determination. Prior to rendering its final BTA determination, Region 1 should permit PSNH to submit an evaluation of these non-water quality impacts so the agency can adequately evaluate and explain this mandatory aspect of its BTA analysis.

\* \* \* \* \*

The status of Region 1’s current justification for fine-mesh CWW screens at Schiller Station to address entrainment impacts is summed up best in the 2016 Enercon-Normandeau Comments: “[Region 1’s] BTA determination is both uninformed (based on inadequate information) and misinformed (based on outdated information).”<sup>166</sup> More is needed to enable the agency to develop and support a BTA determination that can withstand judicial scrutiny. PSNH therefore respectfully requests that Region 1 permit the company to submit additional analyses that “will provide the [agency] with adequate information for decision making” if the agency remains steadfast in its position that entrainment controls may be warranted at Schiller Station following review of these and other comments submitted regarding the Draft Permit.<sup>167</sup>

---

<sup>165</sup> Fact Sheet at 164.

<sup>166</sup> 2016 Enercon-Normandeau Comments at 19 (emphasis in original).

<sup>167</sup> 79 Fed. Reg. at 48,348.

**5. At the very least, Region 1 must permit PSNH to evaluate CWW screens with larger slot-widths to reflect current research and understanding about the effectiveness of those screens**

The comments set out herein demonstrate technologies to address entrainment are not warranted at Schiller Station. Should Region 1 erroneously disagree, it must allow PSNH to test screens for the CWW system with a larger slot-width than 0.8 mm. Specifically, the company requests the right to also test the biological effectiveness of CWW screens with slot-widths of 2.0 mm, 3.0 mm, and above. There is no drawback to the agency permitting PSNH to do so. The company will still complete all pilot testing within the time frame it would need to complete testing of screens of 0.8 mm or less. Furthermore, allowing this additional testing will provide PSNH and the agency valuable data regarding the efficacy of a larger array of smaller-sized slot-width CWW screens in an estuarine environment, including but not limited to learning whether these larger slot-width screens are equally if not more effective than their finer-mesh counterparts in a waterbody with swift sweeping flows due to the newly discovered hydraulic bypass and larval avoidance phenomena.<sup>168</sup>

---

<sup>168</sup> The results from the Indian Point analysis included in Exhibit 2 provide proof that it is possible for larger size slot-widths to be equally effective at reducing entrainment.

Notably, Enercon never stated in its 2008 report that a “mesh size no greater than 1.0 mm is necessary to effectively screen most fish eggs and larvae,” as Region 1 asserts in its Fact Sheet. *See* Fact Sheet at 107 (citing AR-140 at 80); *see also id.* at 114 (Region 1 “agrees with PSNH that a slot size of 0.6 mm to 0.8 mm will likely be needed to maximize entrainment reductions at Schiller Station”). 1.0 mm slot-width screens were simply the largest ones evaluated as part of that report. And, the discovery in recent years of how hydraulic bypass and larval avoidance impact the efficacy of CWW screens mean it is reasonable to assume screens with slot-widths greater than 1.0 mm may be equally effective at reducing entrainment. Region 1’s repeated statements regarding the efficacy of CWW screens with slot-widths of 1.0 mm or less are therefore inaccurate and based on outdated information.

Distinctly, PSNH takes issue with the values set out in Tables 10-A and 10-B within the Fact Sheet that purport to represent the estimated impingement and entrainment reductions, respectively, that would occur at Schiller Station depending upon the technology installed for the CWISs. *See* Fact Sheet at 151, 153. Region 1 provides that some of the values contained in Table 10-A, and presumably in Table 10-B, came from P. Colarusso at EPA via email correspondence with Ms. Sharon DeMeo dated July 18, 2014. *See* Fact Sheet at 151. One of the spreadsheets supposedly transmitted with this July 18, 2014 email correspondence is included in the Administrative Record for the permit in “.pdf” format. *See* AR-244. However, the actual email correspondence and any other attachments to it are not. The spreadsheet is impossible to decipher (especially as a static “.pdf” document) without any context or knowledge regarding the methodologies employed by P. Colarusso or others at EPA to generate the

Currently, there is a dearth of information regarding the effectiveness of finer-mesh CWW screens in coastal and brackish water ecosystem—like the Piscataqua River—subject to extremely aggressive marine life fouling.<sup>169</sup> And, PSNH, Enercon, Normandeau, and others have serious concerns that CWW screens with a slot-width of 0.8 mm or less in the Piscataqua River will experience frequent and potentially catastrophic biofouling, debris fouling, clogging, and frazil ice issues that could impact the reliability of Schiller Station.

Concerns regarding biofouling and clogging associated with CWW screens are not limited to Schiller Station. EPA and EPRI have expressed industry-wide concerns regarding biofouling issues with CWW systems with small slot-widths. Specifically, in its Technical Development Document that accompanied the 2006 Effluent Guidelines Program Plan, EPA provided:

The Agency is not aware of any fine-mesh wedgewire screens that have been installed at power plants with high intake flows (>100 MGD). However, they have been used at some power plants with lower intake flow requirements (25-50 MGD) that would be comparable to a large power plant with a closed-cycle cooling system. With the exception of Logan, the Agency has not identified any full-scale performance data for these systems. They would be even more susceptible to clogging than wide-mesh wedgewire screens (especially in marine environments). It is unclear whether this simply would necessitate more intensive maintenance or preclude their day-to-day use at many sites. Their successful application at Logan and Cope and the historic test data from Florida, Maryland, and Delaware at least suggests promise for addressing both fish impingement and entrainment of eggs and larvae. However, based on the fine-mesh screen experience at Big Bend Units 3 and 4, it is clear that frequent maintenance would be required.<sup>170</sup>

EPRI has also noted these issues:

---

values. PSNH therefore is unable to verify the veracity of the values included in AR-244 and/or Tables 10-A and 10-B and therefore objects to the use of them by Region 1 to make BTA determinations for Schiller Station.

<sup>169</sup> See generally 2016 Enercon-Normandeau Comments at Appx. 2.

<sup>170</sup> EPA Technical Development Document for the Final Regulations Addressing Cooling Water Intake Structures for New Facilities at 5-7 (Nov. 2001) (emphasis added).

Several full-scale CWIS applications of cylindrical wedge-wire continue to perform satisfactorily. However, these applications employ coarse bar spacings (10 mm). Therefore, other than the existence of encouraging data from small-scale laboratory and pilot field facilities, there is still little information on the use for this technology for protecting early life stages. The potential use of 0.5- to 2.0-mm bar spacing to protect early life stages of fish (particularly eggs and early larvae) has not been evaluated at a CWIS. Therefore, larger-scale pilot studies are needed to identify the full biological potential of these screens. Also, there is a need for further research into biofouling control before the potential applicability of wedge-wire screens can be fully assessed. Biofouling, particularly on internal surfaces that are not readily accessible, remains a concern with both large and small slot sizes. Results of small-scale field studies conducted primarily in the 1970's and 1980's have shown that substantial fouling can occur over time in all types of water.<sup>171</sup>

Barnacles and numerous species of mollusks can rapidly colonize on numerous functional parts of CWW systems. When they do, the passage of cooling water flow is impeded and cleaning and operation of the intake screening equipment itself may be interrupted.<sup>172</sup> Some mesh openings actually become blocked, thereby restricting the flow of water through the screen and increasing the velocity through the unblocked portions of the screen. Less open screen area also results in a higher pressure drop through the screens, which can impair the performance of a facility's circulating water pumps and reduce fish protection.<sup>173</sup>

The slot-width of the CWW screens is a key variable in the potential risk of biofouling at a facility.<sup>174</sup> This is so because biofouling organisms first attach to a solid piece of screen and, as the organisms grow, the thickness of the biolayer decreases the open portion of the screen. A screen with a greater percentage of solid wire (i.e., one with smaller percent open area) thus will provide space for a greater number of organisms to attach themselves, meaning the resulting

---

<sup>171</sup> 2016 Enercon-Normandeau Comments at Appx. 2, pp. 10-11 (quoting EPRI Technical Report 1010112, "Field Evaluation of Wedgewire Screens for Protecting Early Life Stages of Fish at Cooling Water Intakes." (May 2005)).

<sup>172</sup> 2016 Enercon-Normandeau Comments at Appx. 2, p. 3.

<sup>173</sup> *Id.* at Appx. 2, p. 6.

<sup>174</sup> *Id.* at Appx. 2, p. 11.

biolayer will obstruct the open area of the screen at a faster rate.<sup>175</sup> Biofouling organisms can also bridge the gap between solid portions of the screen to block flow completely. In marine environments, testing of traveling water screens has revealed that the hydraulic performance of larger mesh screens (about 2 mm x 70 mm) compared to smaller mesh screens (about 1 mm x 15 mm) is better due to decreased ability of the dominant amphipods to bridge the larger openings and restrict flow in the larger mesh screens.<sup>176</sup>

At Schiller Station, the presence of calcareous algae in the brackish water of the Piscataqua River presents a significant biofouling concern. Calcareous algae are encrusting algae that can coat inert surfaces. They colonize clean, hard substrates and then attract an entire biofouling community including macroscopic algae, barnacles, and mussels.<sup>177</sup> Different CWW screen materials (e.g. metal alloys) have been used to successfully limit biofouling. However, it is not currently known whether any materials could be used to limit the growth of algae on CWW screens at Schiller Station, especially screens with a slot-width of 0.8 mm or less.

#### **6. The Draft Permit's June outage requirement for Unit 5 is arbitrary and capricious**

Scheduling an annual outage in June for Unit 5 is not feasible. PSNH previously communicated this fact to Region 1 and the agency expressly acknowledged it in its Fact Sheet.<sup>178</sup> Including such a requirement as part of the § 316(b) BTA determination at Schiller Station is therefore arbitrary and capricious, especially since Region 1 does not even dispute the fact that “power pool demands preclude scheduled outages during peak seasons (i.e. high use

---

<sup>175</sup> *Id.* (citing Fedorenko, A.Y. Guidelines for minimizing entrainment and impingement of aquatic organisms at marine intakes in British Columbia. Canadian Manuscript Report of Fisheries and Aquatic Sciences. No. 2098 (1991)).

<sup>176</sup> *See id.*

<sup>177</sup> *Id.* at Appx. 2, p. 3.

<sup>178</sup> *See* AR-140 at 100–01; Fact Sheet at 133.

winter and summer months[]].”<sup>179</sup> Even if it were possible, such a requirement is not necessary given the aforementioned comments, which clearly establish that the installation of modified traveling water screens with upgraded fish return systems satisfies the CWA § 316(b) BTA requirements for the CWISs at Schiller Station. Proposing to require a June annual outage is also not economical and/or cost effective inasmuch as it will cost PSNH’s customers thousands of dollars due to incremental energy costs and may not lead to any net environmental benefit given that Region 1 failed to even consider, much less evaluate, the fact that replacement power will need to be provided to the grid and may very well be provided by a facility with a rate of impingement and/or entrainment that far exceeds that of Schiller Station.

Unit 5 at Schiller Station was repowered to a biomass unit in 2006. Since this conversion, the unit has been in operation nearly all the time, which means that it operates at or near full capacity, year-round. The only periods during which it typically will not operate are during times when the unit is on an annual, planned maintenance outage or a forced outage attributable to some mechanical and/or operational issue. The annual planned outage for Unit 5 at Schiller Station takes place each year during the month of April. This outage period was not chosen at random. Instead, the outage is scheduled during this month to coincide with the expected reduction in available clean wood-chip fuel due to what is commonly referred to as “mud season” within the region.

Recall that PSNH obtains the overwhelming majority of its wood for fuel from sources within 50 miles of Schiller Station. This is economically prudent for the company and has the additional benefit of sustaining 150-200 local, forestry-related jobs. It is therefore critical that a controlled and managed procurement plan be maintained at all times during the year to assure

---

<sup>179</sup> Fact Sheet at 133.

that the approximate 500,000 tons of wood required can be timely and economically delivered to the facility since Unit 5 is totally dependent on freshly-forested green wood chips for the fuel supply. Mud season occurs in April when spring thaws begin causing subsurface land to thaw and become soft due to the melted ice in the soil. This natural, annual process creates incredibly soft conditions. These conditions preclude trucks, chippers, and other heavy forest clearing equipment from safe and reliable access to forest floors. Due to these realities, the entire area from which wood is procured within the region is subject to logging restrictions, posted road load limits, and inaccessibility to certain work areas during the mud season. Significant damage to forestry lands that can occur and be extreme is avoided due to the aforementioned access limitations. Precluded access also prevents equipment from continually becoming stuck with resultant uneconomic harvesting and unsafe condition risks. Without the established strategy of bringing Unit 5 offline in April to coincide with the mud season and corresponding reductions in wood chip availability within the region, the unit would be in high risk of running out of fuel, causing PSNH's customers to lose possibly tens of thousands of Renewable Energy Certificate ("REC") revenue dollars each and every day.<sup>180</sup>

Even setting aside the April mud season issues, an annual June outage for Unit 5 is not possible because the timing of annual overhauls must be scheduled and approved by the New England Independent Systems Operator ("ISO-NE") to avoid exposure to potential penalties and the organization has historically been very reluctant to approve in advance any planned outages between June and September because this timeframe is the expected high summer peak demand period. Specifically, to comply with the requirements of its Operating Procedure No. 5, ISO-NE typically denies any request for a planned outage within this window of time of high energy

---

<sup>180</sup> An annual outage in June, coupled with an inability to work in April due to the mud season, could also place greater economic hardship on local wood suppliers that depend upon the operation of Unit 5 at Schiller Station to buoy consumer demand.



demand to ensure capacity and operating reserve requirements will be met under expected and/or worst-case scenarios. ISO-NE will entertain requests for “short term” outages approximately two weeks in advance of the requested outage just before and during the annual June to September window. This is due to the fact that the load forecast upon which ISO-NE relies to make outage determinations is more realistic and can better reflect and/or anticipate what capacity and reserve requirements will be needed 14 days in advance, as opposed to months and/or years in advance.

Annually relying upon approval for a short term outage two weeks before the actual outage will take place is not an acceptable or economic method for PSNH to plan for work to be completed during the outage. The company would be unable to schedule and/or secure critically skilled and capable vendors, materials, and man-power within that two-week timeframe and could not make arrangements for the work beyond this two-week lead time due to the fact that it would not yet know whether a short term outage would actually occur until it is approved by ISO-NE.

Furthermore, if a generator like PSNH attempted to schedule an outage between June and September without first obtaining ISO-NE approval, the generator would be at risk of incurring extremely high penalties should a “shortage event” occur. Shortage events occur on the ISO-NE system due to operating constraints which result in a shortage of operating reserves for thirty minutes or more, and there is a much higher likelihood of shortage events occurring during this calendar period. For instance, the current minimum penalty when a unit is unavailable during a “shortage event” is five percent of its “annualized” monthly capacity revenue, with increasing penalties for events that last longer than five hours. For Unit 5 at Schiller Station, the Capacity Supply Obligation (“CSO”)—which is the amount of energy the unit is obligated to be able to

provide, the ability for which it is paid on a monthly basis—is 43.1 MW or 43,100 KW. Assuming a rate of \$3.434/KW-month, the current “annualized” monthly capacity revenue for Unit 5 is \$1.8 million.<sup>181</sup> Therefore, the minimum penalty for each “shortage event” that occurred during a full outage at Schiller Station that was not approved by ISO-NE would be \$90,000.<sup>182</sup> PSNH’s customers would ultimately carry the financial burden of these penalties.

The “Pay-for-performance” program (a new paradigm of revised FCM rules) is also set to begin in June 2018. The implementation of this program means the introduction of “scarcity events,” which will replace the aforementioned “shortage events” and associated penalties. The fines associated with penalties that occur during these “scarcity events” are more severe and PSNH’s exposure to potential penalties would therefore be greater if the company were to annually schedule a June outage at Unit 5 during a peak period. Based on a historical review of ISO-NE provided data from October, 2006 thru September, 2015 a scarcity event is more than three times as likely to occur in June as it is in April. A “scarcity event” is defined similar to a “shortage event” in that it represents a shortage of operating reserves, but the thirty-minute minimum becomes a five-minute minimum, meaning scarcity events will occur with greater regularity, as well. Based on the same historical review of ISO-NE data from October, 2006 thru September, 2015 scarcity events would have occurred 189 times, compared to 64 times for shortage events. Under the new “pay-for-performance” program, units will need to be online or providing reserves, rather than simply being available, in order to avoid penalties. The penalty rate for those units not online or providing reserves during a scarcity event will be \$2,000/MWH. So, for a 3-hour “scarcity event” that occurs on a peak day when Unit 5 at

---

<sup>181</sup> 43,100 KW x \$3.434/KW-month x 12 = \$1.8 million.

<sup>182</sup> \$1.8 million x 5% = \$90,000. This penalty or take-back of CSO revenues is justified because a unit does not meet its “obligation.”

Schiller Station is not available due to an unapproved outage, PSNH would be subject to a \$258,600 penalty. The \$2,000/MWH penalty rate increases to \$3,500/MWH in 2021.

And, the likely financial impacts do not end there. Energy market prices have historically been higher in June as compared to April because customer usage and therefore energy prices are higher. It is because of this higher demand that ISO-NE will not provide advance approval within this summer timeframe (June to September). For every \$1/MWh that the cost of energy is higher in June than in April, PSNH's customers would lose the benefit of \$1,000 per day in revenue by moving its existing annual April outage to June (43.1 MW x 24 Hrs. x \$1/MWh). Thus, if the energy market cost averages \$5/MWh per day higher in June for a typical 21-day outage, PSNH's customers would lose over \$100,000 in cost benefit (43.1 MW x 24 Hrs. x 21 Days x \$5/MWh).

**7. An emergency bypass for the fine-mesh CWW screens is imperative if PSNH is ultimately compelled to install the technology at Schiller Station**

On page 115 of the Fact Sheet, Region 1 expresses its doubt regarding the need for an emergency bypass mechanism for the fine-mesh CWW screens it seeks to impose upon Schiller Station but “welcomes comment and more information on this design feature.”<sup>183</sup> For the reasons articulated above, the installation of fine-mesh CWW screens at Schiller Station is unwarranted. Should Region 1 erroneously disagree with PSNH on this issue, the company must be allowed to install and operate as necessary an emergency bypass mechanism in the event of a significant blockage or damage to the fine-mesh CWW screens installed at Schiller Station. A bypass feature of this kind is consistent with sound engineering practices and, when put in use, would protect and prevent harm to valuable infrastructure at the facility by providing the

---

<sup>183</sup> Fact Sheet at 115.

necessary flow of water to cool plant processes, which sustains on-line operations and reduces risks of large equipment thermal transients, incremental wear and damage, and other adverse conditions.<sup>184</sup> Conversely, eliminating the bypass feature would result in added direct costs and reduced reliability at Schiller Station—both of which negatively impact customer benefits—because the aforementioned conditions would occur more frequently than if a bypass feature were installed for the CWW technology.<sup>185</sup>

Enercon and Normandeau have outlined additional bases for why an emergency bypass mechanism for fine-mesh CWW screens would be necessary at Schiller Station:

The primary reason that the bypass system was included is to ensure that a continuous supply of cooling water is always available to the Station. The expected frequency of a clogging event is unknown until a pilot study is conducted, and clogging of the CWWs would serve to reduce the water level within the screen houses. At a certain point, the pumps would become damaged due to air intrusion and vortex formation unless the pumps were tripped or another source of water was made available (i.e., the bypass system). The tripping of the pumps would result in the tripping of the Station. This would result in lost generating capacity for the Station and loss of cooling to equipment within the plant. As discussed in Appendix 2, bypass systems are common and have been installed at other power plants to ensure operational reliability. The continuous supply of cooling water helps maintain power generation, but is also critical for maintaining the safety and reliability of plant equipment, as will be discussed below.

In addition to loss of cooling to the condenser for power generation, as discussed in the 2008 Response there are other pumps and systems that support equipment cooling for the Station. Unit 4 contains one salt water cooling pump, which provides water to the salt water heat exchangers. For Units 5 and 6, the circulating water pumps provide water to the salt water heat exchangers, which provide

---

<sup>184</sup> Installation of a bypass feature is also prudent due to the greater likelihood of damage or destruction to any CWW screens installed for Schiller Station compared to other CWA § 316(b) technological options due to the fact that the CWW screens would be installed offshore within the volatile Piscataqua River.

Notably, emergency bypass features have been implemented at the Oak Creek Power Plant in Milwaukee, Wisconsin, and the IBM facility in Poughkeepsie, New York, due to these and other concerns. *See* 2016 Enercon-Normandeau Comments at 7, 9.

<sup>185</sup> The Unit 5 boiler has a fluidized bed type design which, when cycled on load or cycled off line, has a propensity to incur incremental fouling. More load fluctuations and/or forced outages necessarily means the boiler will need to be brought offline more frequently to clean plugged equipment. Thermal transients due to load drops and off-line cycling create this pluggage, which when bad enough, can cause an expansive, 5-6 day forced outage.

equipment cooling to the plant. The interruption of cooling water to these systems would create a sudden loss of cooling, which in turn could create a transient or thermal shock to the salt water heat exchangers.

The Tubular Exchanger Manufacturer's Association (TEMA) is the governing authority on heat exchanger design and construction in the industry. The "Standards of the Tubular Exchanger Manufacturers Association" (TEMA Standards) are utilized throughout the industry as a guide to size, design, operate, and maintain heat exchangers. Paragraph E-3 titled "Operation of Heat Exchangers" provides guidelines for operating heat exchangers in a way that ensures safety and reliability. Paragraph E-3.23 states "Exchangers normally should not be subjected to abrupt temperature fluctuations." Paragraph E-4 is titled "Maintenance of Heat Exchangers" and provides guidelines for maintaining acceptable operation of the heat exchangers. Paragraph E-4.1 states that "neglect in keeping the tubes clean may result in complete stoppage of flow through some tubes which could cause severe thermal strains, leaking tube joints, or structural damage to other components." While clogging of the heat exchangers is not of concern with regard to the bypass system, the resulting thermal strain and/or thermal shock that may occur due to abrupt interruption of flow may result in similar consequences. Therefore, given that the salt water heat exchangers were not originally designed for regular/frequent transients, they should be avoided and a continuous supply of cooling water should be made available to the salt water heat exchangers. If CWWs were to be installed at the Station, the most effective way to ensure a continuous supply of cooling water would be to install a bypass system as described in the 2014 report.<sup>186</sup>

An inability to bypass clogged and/or damaged fine-mesh CWW screens at Schiller Station will have a sizeable economic impact on PSNH and its customers, as well. Unit 5 at Schiller Station qualifies to sell RECs in Massachusetts, Connecticut, Rhode Island, and New Hampshire due to its biomass fuel, boiler design and very low emissions profile. These markets provide a revenue stream to PSNH and, in turn, its customers. One REC is created whenever one megawatt hour of energy is generated. Thus, reductions in energy production due to load drops or outages cause additional loss of this very valuable revenue stream.

---

<sup>186</sup> See 2016 Enercon-Normandeau Comments at 32-33 (references omitted).

**8. The design, permitting, and construction requirements of Region 1's flawed BTA determination are not reasonable**

CWW screens are not needed at Schiller Station for the reasons articulated in these comments. A schedule for their installation at the facility like the one Region 1 sets out in the Fact Sheet is therefore not necessary. If Region 1 erroneously includes such a requirement in the final permit for the facility, however, the schedule for the design, permitting, and construction of fine-mesh CWW screens at Schiller Station must also be revised.<sup>187</sup>

The proposed schedule set out in the Fact Sheet includes the following key deadlines:

Pilot testing: Complete within 12 months of the effective date of the final permit.

Permits and approvals: Commence the process of obtaining necessary permits and approvals within four (4) months of the completion of pilot testing and complete submission of all necessary permit applications and notices within eight (8) months from the commencement of the permitting process.

Construction contract: Execute an engineering, procurement, and construction agreement with a contractor within 12 months of completion of the pilot testing.

Site preparation: Complete within nine (9) months after obtaining all necessary permits and approvals.

Commissioning of fine-mesh CWW screens: Complete installation, operational modifications, testing, startup, and commissioning of the technology for the CWISs of Units 4, 5, and 6 within 20 months of obtaining all necessary permits and approvals.<sup>188</sup>

PSNH takes issue with these proposed deadlines. Region 1's attempt to require PSNH to enter into any construction contract exceeds the scope of the agency's authority under the CWA and is illegal per se. The site preparation deadline is likewise improper. At most, Region 1 may set a deadline by which the company must have the CWIS technology in operation. How PSNH elects to ensure it will meet that deadline is left entirely to its discretion and the agency's attempt to insert itself in the managerial and/or operational functions of the company is inappropriate.

---

<sup>187</sup> See Fact Sheet at 170–71.

<sup>188</sup> See *id.*

Separately, PSNH cannot and will not enter into any construction contract prior to obtaining all of the permits and approvals it will need to install the CWW screens at Schiller Station. It would be imprudent to do otherwise given the possibility that PSNH may ultimately not be able to obtain all of the necessary regulatory authorizations. Therefore, this deadline—if not deleted for the reasons articulated above—should be tied to the date on which PSNH obtains the necessary permits and approvals it needs to commence construction.

Other deadlines Region 1 has proposed are patently unreasonable or are tied to or triggered by events or occurrences that should be adjusted. The following is a schedule and timeline that is sensible and would be reasonable if PSNH is ultimately forced to install the entrainment technology at Schiller Station:

<u>EVENT</u>	<u>TIME</u> <sup>189</sup>
<u>Permit Issuance</u>	0 mo
<u>Engineering for Pilot Testing</u> : Time to consider design of system to be utilized for pilot testing and to select the equipment required.	1 mo
<u>Procurement for Pilot Testing</u> : Time necessary to actually obtain and install the equipment required for the pilot testing.	5 mo
<u>Pilot Testing</u> : A complete 12-month time period within which to conduct the pilot testing of the parameters Region 1 has set out in its Fact Sheet.	18 mo
<u>Data Analysis</u> : Time to collect and analyze data generated from the pilot testing and develop conclusions based on said data.	20 mo
<u>Pilot Test Report</u> : Time to generate and provide written report of findings to Region 1.	21 mo

---

<sup>189</sup> The time deadlines included refer to the number of months that will have elapsed following the date the NPDES permit for Schiller Station is issued as final (including exhaustion of any administrative and/or judicial proceedings that result in a stay of some or all of the conditions of the permit).

<u>Other Data Collection:</u> Time to collection additional data Region 1 has delineated in the Fact Sheet, including but not limited to topographic and bathymetric surveys, geotechnical exploration, and other design and marine construction variables	22 mo
<u>Final Design Submission:</u> Time to generate and provide a final design for the CWW screens at Schiller Station based on all data collected.	24 mo

These are the only dates Region 1 can definitively establish in the final permit for Schiller Station. The remainder of the deadlines must be tied to or triggered by Region 1’s approval of the final design for the CWW screens at Schiller Station and the date on which PSNH obtains all of the necessary permits and approvals to construct the technology at the facility. Thus, the remainder of the schedule should be set out in the following manner:

<b><u>EVENT</u></b>	<b><u>TIME</u></b>
<u>Permits and approvals:</u> Complete submission of all necessary permit applications and notices required to install the CWW screens at Schiller Station.	8 mo after Region 1 approves final design
<u>Commissioning of fine-mesh CWW screens:</u> Complete installation, operational modifications, testing, startup, and commissioning of the technology for the CWISs of Units 4, 5, and 6	20 mo after obtaining all necessary permits and approvals

The schedule PSNH has set out above is well-reasoned and includes the minimum amount of time the company would need to properly test, design, and install the new technology at Schiller Station. Thus, if Region 1 requires PSNH to install fine-mesh CWW screens at Schiller Station, the agency must substantially revise its proposed compliance schedule and craft one that is reasonable and will offer PSNH sufficient time to comply with the permit requirement.



C. **Region 1's Proposed Regulation of Nonchemical Metal Cleaning Wastes is Arbitrary and Capricious and Ignores the Requirements of EPA's Final NELGs**

Each unit at Schiller Station has historically, and continues to, treat NCMCWs as a low volume waste exempted from any iron and copper effluent limitations. This is true despite the fact that iron and copper limits apply to the outfall through which this wastewater discharges (Outfall 016: WWTP #2) in the current NPDES permit for the facility. As explained in detail below, the iron and copper effluent limitations applicable to Outfall 016 exist solely to detect chemical metal cleaning wastewater that is also routed to WWTP #2 due to the fact that such wastewaters may be retained within the treatment system for extended periods after the chemical cleaning is completed. NCMCWs should continue to be classified as a low volume waste in the new final permit for Schiller Station. Indeed, this continued classification is mandatory based on the historical permitting record for the facility, as well as the contents of Region 1's administrative record for this permit renewal proceeding.

Classifying and treating NCMCWs as a low volume waste exempt from any iron and copper effluent limitations, as Schiller Station does, is standard practice for most of the industry and is also consistent with long-standing EPA guidance set forth in what is commonly referred to as the "Jordan Memorandum."<sup>190</sup> Region 1 fails to reference the Jordan Memorandum even once in its 212-page Fact Sheet for the Draft Permit. Given that EPA (with input and assistance from Region 1) specifically determined only a few years ago that the Jordan Memorandum applies to NCMCWs generated at Schiller Station makes Region 1's failure to even mention the Jordan Memorandum in its Fact Sheet for the Draft Permit even more suspect. Region 1 has seemingly overlooked or chosen to ignore the aforementioned determination from the latest ELG

---

<sup>190</sup> See Memorandum from J. William Jordan, Chemical Engineer, Permit Assistance & Evaluation Section, Office of Enforcement, EPA Headquarters, to Bruce P. Smith, Biologist, Enforcement Division, EPA Region III (June 17, 1975) ("Jordan Memorandum"). A copy of the Jordan Memorandum is attached hereto as Exhibit 3.

rulemaking in this permit renewal proceeding. By doing so, Region 1 has ostensibly simplified its ultimate objective of saddling NCMCW discharges with iron and copper effluent limitations at the facility in the new final permit. This failure to adequately consider the historical permitting record at Schiller Station is arbitrary, capricious, and at odds with EPA's directives set out in the final NELGs.

Region 1's BAT analysis for determining iron and copper effluent limitations for NCMCWs in the Draft Permit is arbitrary and capricious, as well. Upon information and belief, the agency has no data of isolated NCMCW discharges generated at Schiller Station that would allow it to competently complete the required BAT determination. There is certainly no such data in the administrative record Region 1 has compiled for the Draft Permit. Moreover, EPA just recently declined to establish NCMCW effluent limitations for the entire industry due, at least in part, to the fact there has never been defensible data on the constituents found in NCMCW discharges that are representative of the industry or on the cost industry would incur if more stringent effluent limitations were established for this waste stream. Region 1's BAT analysis is further flawed inasmuch as it inadequately evaluates and grossly underestimates the significant costs and/or logistical problems that regulation of NCMCWs in this manner would present at Schiller Station. Section 304(b)(2)(B) of the CWA and EPA's own regulations require Region 1 to take these and other factors into consideration when adopting site-specific effluent limitations. Each of these issues is discussed in detail below.

### **1. Relevant legal background**

The effluent guidelines and standards for the steam electric industry are set out in 40 C.F.R. Part 423. They were promulgated in 1974, revised in 1982, and reasserted by the agency

on November 3, 2015.<sup>191</sup> They contain BPT limits for the generically referenced “metal cleaning wastes,” BAT and NSPS limits for “chemical metal cleaning wastes,” and include a holding place for future BAT limits on NCMCWs. This “holding place” remains even after the promulgation of EPA’s latest NELGs on November 3, 2015, within which the agency once again elected to “reserve” BAT for NCMCWs due to the fact that the agency:

does not have sufficient information on the extent to which discharges of non-chemical metal cleaning wastes occur, . . . the ways that industry manages their non-chemical metal cleaning wastes[,] . . . [the] potential best available technologies or best available demonstrated control technologies, or the potential costs to industry to comply with any new requirements.<sup>192</sup>

The term “metal cleaning waste” is defined as “any wastewater resulting from cleaning [with or without chemical cleaning compounds] any metal process equipment including, but not limited to, boiler tube cleaning, boiler fireside cleaning, and air preheater cleaning.”<sup>193</sup> “Chemical metal cleaning waste” is defined as “any wastewater resulting from the cleaning of any metal process equipment with chemical compounds, including, but not limited to, boiler tube cleaning.”<sup>194</sup> “Nonchemical metal cleaning waste” is not expressly defined in the regulations despite the fact that the term is used in 40 C.F.R. § 423.13(f). Nevertheless, the agency has repeatedly attempted to establish a working definition of NCMCWs based on a comparison of the two aforementioned terms defined in 40 C.F.R. Part 423: “any wastewater resulting from the cleaning of metal process equipment without using chemical cleaning compounds of any metal process equipment.”<sup>195</sup>

---

<sup>191</sup> See 39 Fed. Reg. 36,186 (Oct. 8, 1974), amended 40 Fed. Reg. 23,987 (June 4, 1975); 47 Fed. Reg. 52,290 (Nov. 19, 1982), amended 48 Fed. Reg. 31,403 (July 8, 1983); 80 Fed. Reg. 67,838 (Nov. 3, 2015).

<sup>192</sup> 80 Fed. Reg. at 67,863.

<sup>193</sup> 40 C.F.R. § 423.11(d). (brackets included in original).

<sup>194</sup> *Id.* § 423.11(c).

<sup>195</sup> See, e.g., Fact Sheet at 37.

The BPT limits for the generically defined “metal cleaning wastes” include iron and copper limits (1.0 mg/L) and TSS and oil and grease limits.<sup>196</sup> BAT limitations for “chemical metal cleaning wastes” are the same as the BPT iron and copper limits for “metal cleaning wastes” (i.e., 1.0 mg/L).<sup>197</sup> As mentioned above, there are no current BAT requirements for NCMCWs due to a lack of data regarding this waste stream.<sup>198</sup>

Impacting the application of these effluent limitations to the various “metal cleaning” waste streams generated by facilities within the industry is a June 17, 1975 document commonly referred to as the “Jordan Memorandum.”<sup>199</sup> EPA used the Jordan Memorandum to clarify the limits for “metal cleaning wastes” applied only to chemical cleaning wastes, explaining that use of the term “metal cleaning wastes” in 40 C.F.R. Part 423 actually meant chemical cleaning wastes and does not include NCMCWs.<sup>200</sup> The memorandum was issued by Bill Jordan of the Permit Assistance & Evaluation Division of EPA Headquarters to Bruce P. Smith of Region 3’s Enforcement Division in response to a May 21, 1975 letter from Mr. Smith, noting “some confusion as to what actually constitutes metal cleaning wastes” within the industry.<sup>201</sup> Mr. Smith specifically provided that he was “inclined to agree with . . . companies” that:

effluent streams that result exclusively from water washing of ash found on boiler fireside, air preheater, etc. should be considered in the low volume or ash transport waste categories while effluent streams resulting from cleaning processes involving chemical

---

<sup>196</sup> See 40 C.F.R. § 423.12(b)(5).

<sup>197</sup> See *id.* § 423.13(e).

<sup>198</sup> See *id.* § 423.13(f).

<sup>199</sup> See generally Jordan Memorandum.

<sup>200</sup> *Id.* at 3.

<sup>201</sup> See Letter from Bruce P. Smith, Delmarva-D.C. Section, EPA Region III, to Mr. Bill Jordan, EPA Headquarters (May 21, 1975) at 5.

solution (acid cleaning of boilers) should be considered in the metal cleaning waste source category.<sup>202</sup>

However, because of the perceived “ambigu[ity]” on this issue, Mr. Smith expressly requested that EPA Headquarters provide clarification as to what constitutes NCMCWs. Mr. Smith specifically suggested that “Headquarters should distinguish the type of cleaning that generates metal cleaning wastes and the type of cleaning that generates low volume waste.”<sup>203</sup>

The Jordan Memorandum explicitly addresses Mr. Smith’s concerns. In it, Bill Jordan explains that NCMCWs constitute “low volume” wastes and are therefore not subject to effluent limitations for total copper and total iron in metal cleaning waste. Further, the Jordan Memorandum specifies that “[a]ll water washing operations are ‘low volume’ while any discharge from an operation involving chemical cleaning should be included in the metal cleaning category.”<sup>204</sup>

Due to the Jordan Memorandum, iron and copper limits for “metal cleaning wastes” (meaning chemical metal cleaning wastes) were often included in permits within the industry between 1975 and 1980. At the same time, nonchemical metal cleaning wastes were classified as low volume wastes and not mentioned by name in many permits. This was to be expected, since “low volume waste” is a residual category for wastewater from all sources that do not have specific limitations.<sup>205</sup>

In proposed amendments to Part 423 published in 1980, EPA recognized that it “adopted a policy” as to the classification and treatment of NCMCWs by and through the Jordan

---

<sup>202</sup> *Id.*

<sup>203</sup> *Id.* (emphasis added).

<sup>204</sup> Jordan Memorandum at 1.

<sup>205</sup> *See* 40 C.F.R. § 423.11(b)).

Memorandum.<sup>206</sup> And, this “policy” from the Jordan Memorandum was reaffirmed in EPA’s final 1982 NELGs.<sup>207</sup> While EPA originally proposed in 1980 to reject the Jordan Memorandum for facilities that had previously relied upon it by adopting a new definition that purportedly “[made] clear that the ‘metal cleaning waste’ definition” was meant to include NCMCWs,<sup>208</sup> the agency ultimately succumbed to its equitable concerns regarding the Jordan Memorandum in the 1982 final rule, recognizing that “many dischargers may have relied on [the Jordan Memorandum] guidance.” Thus, EPA determined that “until the Agency promulgates new limitations and standards, the previous guidance policy may continue to be applied in those cases in which it was applied in the past.”<sup>209</sup>

EPA likewise abstained once again from establishing BAT effluent limitations for NCMCWs in this 1982 rulemaking, acknowledging both that the data the agency had collected pertaining to NCMCWs “were too limited to make a final decision” and that it had not sufficiently examined either “the available data on waste characteristics of non-chemical metal cleaning wastes [or] the costs and economic impacts of controlling them.”<sup>210</sup> Thus, the Jordan Memorandum remained in effect for facilities that had relied on it following EPA’s 1982 rulemaking.<sup>211</sup>

---

<sup>206</sup> See 45 Fed. Reg. 68,328, 68,333 (Oct. 14, 1980) (noting that “EPA adopted a policy” in the Jordan Memorandum).

<sup>207</sup> 47 Fed. Reg. 52,290 (Nov. 19, 1982).

<sup>208</sup> 45 Fed. Reg. at 68,333. The definition of “metal cleaning wastes” was ultimately revised in EPA’s final 1982 regulations. See 47 Fed. Reg. at 52,305.

<sup>209</sup> 47 Fed. Reg. at 52,297.

<sup>210</sup> *Id.*

<sup>211</sup> See EPA’s “Draft Advanced NPDES Permit Writer’s Course, Module 1, Power Plant Permitting – re Steam Electric Power Generating Effluent Limitation Guidelines & Standards” at B-21 (June 1995) (accurately summarizing EPA’s position following its 1982 rulemaking: “BPT requirements remain applicable to metal cleaning wastes, unless waived prior to November 19, 1982 under guidance of the Jordan Memorandum, and the Permit Issuing Authority agrees to continue it”); EPA, “High Capacity Fossil Fuel Fired Plant Operator Training Program Student Handbook,” EPA-453/B-94-056 (September 1994), <http://nepis.epa.gov/Exe/ZyPURL.cgi?Dockey=>

The latest NELGs do nothing to change how NCMCWs are regulated at facilities within the industry. In its 2013 proposed rule, EPA set out yet again to establish BAT requirements for NCMCWs equal to previously established BPT limitations for “metal cleaning wastes”<sup>212</sup> while preserving the status quo for those facilities historically authorized to discharge NCMCWs as a low volume waste.<sup>213</sup> In the final NELGs, the agency preserved the status quo for those facilities that rely upon the Jordan Memorandum to discharge NCMCWs as a low volume waste. However, EPA elected to not establish BAT requirements for NCMCWs due to flawed and imprecise data.<sup>214</sup> The agency did, however, establish how NCMCWs are to be regulated within the industry going forward:

By reserving limitations and standards for non-chemical metal cleaning waste in the final rule, the permitting authority must establish such requirements based on BPJ for any steam electric power plant discharged non-chemical metal cleaning wastes. As part of this determination, EPA expects that the permitting authority would examine the historical permitting record for the particular plant to determine how discharges of non-chemical metal cleaning waste had been permitted in the past, including whether such discharges had been treated as low volume waste sources or metal cleaning waste.<sup>215</sup>

And, in its Response to Comments document, the agency provided that “[b]y not revising the [NCMCW] effluent limitations and standards and not revising the definitions, the final rule will not result in changes to industry operations for the specified wastestream[.]”<sup>216</sup> The only reasonable interpretation of the above-referenced statements from the agency’s final rulemaking is that NCMCWs will continue to be classified as a low volume waste if they have been

---

2000HF7P.txt at 27-3 (“Since non-chemical metal cleaning is not currently specifically regulated, it is classified under low volume wastes.”).

<sup>212</sup> 78 Fed. Reg. 34,432, (June 7, 2013).

<sup>213</sup> See, e.g., *id.* at 34,436 n.1, 34,465.

<sup>214</sup> See 80 Fed. Reg. at 67,863.

<sup>215</sup> *Id.* (emphasis added).

<sup>216</sup> Effluent Limitations Guidelines and Standards for the Steam Electric Power Generating Point Source Category: EPA’s Response to Public Comments, Part 4 of 10 at 4-324 (Sept. 2015) (emphasis added).

historically. This has been recognized as the generally accepted practice for the last 30+ years by all relevant parties (permit writers, regulated community, interested third parties, etc.), with the assistance of the Jordan Memorandum. Any other interpretation by Region 1 is arbitrary and capricious.

**2. NCMCWs have been and should continue to be classified as a low volume waste at Schiller Station in accordance with the Jordan Memorandum**

**a. The historical permitting record at Schiller Station**

Each unit at Schiller Station has, and continues to, treat NCMCWs as a low volume waste exempted from the iron and copper effluent limitations in the current NPDES permit for the facility.<sup>217</sup> This is the case despite the fact that NCMCWs are not expressly referenced anywhere in Permit No. NH0001473, its associated Fact Sheet, and/or in Region 1's Response to Comments documentation issued contemporaneously with the current permit.<sup>218</sup> Instead, NCMCWs at Schiller Station are subsumed in the category of low volume wastes, in accordance with applicable regulations and the principles of the Jordan Memorandum.

Handling NCMCWs in this manner is consistent with long-standing practice within the industry. Indeed, it applies to each of PSNH's three fossil fuel-fired steam electric generating facilities: Merrimack, Newington and Schiller Stations. Specifically, permit writers have historically provided "authorization" to discharge NCMCWs without copper or iron limitations implicitly, by omitting any reference to such effluent limitations for NCMCWs and declining explicitly to move NCWCW to the "metal cleaning category" contra the Jordan Memorandum. Because EPA's guidance from the Jordan Memorandum was the default rule, silence towards

---

<sup>217</sup> See AR-002.

<sup>218</sup> The Fact Sheet and Response to Comments documents associated with the 1990 permit for Schiller Station are attached hereto as Exhibits 4 and 5, respectively.



NCMCWs indicated that such wastewater should be treated as a “low volume waste.” The clarity of the distinction made between low volume wastes and chemical cleaning wastes in that memorandum (“[a]ll water washing operations are ‘low volume’ while any discharge from an operation involving chemical cleaning [is] metal cleaning”) obviated the need for permit writers to continually reference NCMCWs in their NPDES permits.

Moreover, facilities’ current NPDES permits most often rely upon previous ones and do not contain any express discussion on the handling of NCMCWs. In some cases, decades have passed since permitting authorities have actively considered the regulation of NCMCWs in light of the Jordan Memorandum. This is a direct consequence of EPA having “reserved” time and again these regulations for future rulemakings. EPA acknowledged this reality in its latest final ELGs.<sup>219</sup>

The relevant analysis for Permit No. NH0001473 for Schiller Station centers on a single outfall that has been given two designations: one for normal operations at the plant (Outfall 016) and the other for operations during the time period when chemical waste from cleaning the boiler tubes enters the process waste treatment plant (Outfall 017). Consistent with EPA’s 1982 regulations, Permit No. NH0001473 includes iron and copper discharge limitations with daily monitoring for discharges from the wastewater treatment plant (“WWTP”) during chemical cleaning operations. Iron and copper discharge limitations with weekly monitoring requirements also exist for discharges from the WWTP during normal operations at the plant. The Fact Sheet and Response to Comments documents for this permit do not mention why these limits were made applicable to Outfall 016. Instead, one may look to documentation pertaining to the

---

<sup>219</sup> See, e.g., 80 Fed. Reg. at 67,863 (providing that “the Agency has learned that plants refer to the same [NCMCW] operation using different terminology; some classify non-chemical metal cleaning waste as such, while others classify it as low volume waste sources. . . . EPA does not know the nomenclature each plant use[s] . . . , so it . . . does not have sufficient information on the extent to which discharges of non-chemical metal cleaning wastes occur, or on the ways that industry manages their non-chemical metal cleaning wastes).

renewed NPDES permit for PSNH’s Merrimack Station—a permit issued in 1992, approximately two years after the current permit for Schiller Station—to understand that Region 1 did not include iron and copper effluent limitations on Outfall 016 at Schiller Station due to the discharges of NCMCWs through that outfall during normal plant operations.<sup>220</sup>

Specifically, the Fact Sheet for the 1992 Merrimack Station Permit No. NH0001465 provides that iron and copper limits and monitoring requirements are included for discharges during normal operations solely to protect against the “possibility that copper [and iron]<sup>221</sup> retained in the pond may be released at times other than chemical cleaning periods.”<sup>222</sup> Such limits are not meant to, and accordingly do not, apply to any NCMCWs that are also channeled

---

<sup>220</sup> The 1992 Fact Sheet for the 1992 Merrimack Station NPDES permit is attached hereto as Exhibit 6.

<sup>221</sup> The Fact Sheet associated with PSNH’s existing NPDES permit for Merrimack Station explains that numeric copper limitations have been placed on discharges from the ash settling pond during normal operations to address the possibility that copper entering the pond following chemical metal cleaning operations may be released at other times. (*See* Ex. 6 at 5). And, even copper was discussed in the Fact Sheet for Merrimack Station only because there was debate regarding whether Region 1 needed to develop a water quality-based effluent limitation for the constituent. The expressed reasoning for regulating copper at Merrimack Station must apply to the numeric iron limitations applicable to that outfall during normal operations. It would be inconsistent to place numeric iron limits in an NPDES permit to regulate NCMCW discharges and not place such limits on copper discharges – or vice versa. The Fact Sheet substantiates this conclusion. Nowhere in the discussion of the numeric iron discharge limitations are NCMCWs mentioned. Instead, only chemical metal cleaning wastes, as well as the prevalent background concentration of iron in the Merrimack River, are discussed. In fact, the Fact Sheet identifies these sources as the only two from which iron discharges may originate: “EPA concludes that iron (whether from intake water or chemical cleaning operations) in the slag pond discharge . . .” (Ex. 6 at 5) (emphasis added). Consequently, the only rational conclusion is that numeric iron limitations were included in Permit No. NH0001465 to address the possibility that iron entering the pond following chemical metal cleaning operations may be released at other times.

This fact is also confirmed by the initial Fact Sheet drafted by Region 1 in 2009 (attached hereto as Exhibit 7) as a part of the NPDES permit renewal for PSNH’s Merrimack Station, which was eventually issued for public notice and comment in September 2011. This permit renewal has not yet been finalized. With respect to the 1.0 mg/L total recoverable iron limitation included in PSNH’s existing permit, Region 1 provided that “[i]t is surmised the 1.0 mg/L iron limit for Outfall 003A is to limit any iron discharged from WWTP No. 1 to the Slag Settling Pond when treating metal cleaning wastes.” (Ex. 7 at 6). In other words, as explained above, a numeric iron limitation was only included for Outfall 003A (i.e. normal operations), to enable PSNH and Region 1 to detect if and/or when residual iron concentrations originating from chemical metal cleaning wastes are discharged during normal operations. These limits were not imposed to regulate NCMCWs.

<sup>222</sup> (Ex. 6 at 5).

to the ash settling pond. This fact is confirmed by Region 1's synopsis of Comment 8 to Permit No. NH0001465<sup>223</sup> and the agency's corresponding response:

#### COMMENT 8

The permittee requests that the total copper discharge limit at Outfall 003A be eliminated, since the ELGs regulate copper discharges for chemical cleaning operations only, and not for routine-low volume discharges from ash settling ponds, for example.

#### RESPONSE 8

The ELGs do not establish copper limitations on low volume wastes, ash pile runoff, or storm water runoff (components of the ash pond discharge, Outfall 003A). The maximum total copper limitation of 0.2 mg/l is being maintained in accordance with the anti-backsliding provision of 40 CFR 122.44(1). It is to be noted that this discharge has shown an average total copper concentration of 0.0015 mg/l in the past two years.<sup>224</sup>

Like Merrimack Station, iron and copper effluent limitations are included in Permit No. NH0001473 for Schiller Station solely to: (1) safeguard that detectable concentrations of iron and copper are not being discharged at times other than chemical cleaning operations; and (2) confirm that metals are not present in any unexpected waste stream during normal operations.<sup>225</sup> There can be no other reasonable interpretation as to the application of these discharge limitations given that approximately two years after Region 1 issued the current permit for Schiller Station the agency acknowledged in Comment 8 to Merrimack Station's Permit No. NH0001465 that the writers of PSNH's permits understood the ELG-based discharge limitations for copper and iron apply only to chemical metal cleaning operations.<sup>226</sup>

---

<sup>223</sup> The 1992 Response to Comments document issued contemporaneously with the 1992 NPDES Permit for to Merrimack Station is attached hereto as Exhibit 8.

<sup>224</sup> (Ex. 8 at 4) (emphases added).

<sup>225</sup> (See Ex. 6 at 5).

<sup>226</sup> (See Ex. 8 at 4).

The fact that Permit No. NH0001473 requires only weekly monitoring for iron and copper during normal operations further supports the fact that the numeric limits do not apply to discharges of NCMCWs. If these limits did apply, monitoring likely would be required at least once per discharge—if not more frequently—as Schiller Station typically generates some form of NCMCWs (as Region 1 attempts to define the waste stream in the Fact Sheet) more often than once per week.<sup>227</sup> A weekly sampling frequency clearly illustrates that the monitoring is a prophylactic measure and is in no way linked to the management of NCMCWs.

**b. As recently as 2013, EPA specifically determined that iron and copper effluent limitations apply at Schiller Station only during boiler chemical cleaning operations**

As part of its rulemaking process for the now-final NELGs, EPA hired Eastern Research Group, Inc. (“ERG”) as its agent to evaluate information received by the agency in response to Part E of its 2010 Information Collection Request (“ICR”). Part E of the 2010 ICR asked questions regarding, and sought production of documents specific to, how different waste streams (including NCMCWs) are handled at various facilities. EPA issued the 2010 ICR to pre-selected sources in each EPA region, with only a subset of those pre-selected facilities required to complete Part E of the ICR. Notably, EPA did not require PSNH to complete Part E of the ICR for Schiller Station. Yet somehow an evaluation of how NCMCWs are handled at Schiller Station was included in ERG’s determinations document.<sup>228</sup>

---

<sup>227</sup> See Fact Sheet at 37 (defining NCMCWs as “any wastewater resulting from the cleaning of metal process equipment without using chemical cleaning compounds”); see also EPA Technical Development Document for the Effluent Limitations Guidelines and Standards for the Steam Electric Power Generating Point Source Category, EPA-821-R-15-007 at 4-38 (Sept. 2015) (“The frequency of metal cleaning activities can vary depending on the type of cleaning operation and individual plant practices. Some operations occur as often as several times a day . . .”).

<sup>228</sup> See Attachment 1 to ERG’s Pollutants of Concern Methodology Memorandum, EPA-HQ-OW-2009-0819-2188 (Mar. 13, 2013) (“Permit Review Information” spreadsheet).

Upon information and belief, Schiller Station was selected “at random” by Region 1 after EPA sought additional information from the various Regions to supplement the agency’s record regarding how NCMCWs are handled at representative facilities. How or why Schiller Station was ultimately included in ERG’s ultimate analysis is not important, however. What is important is the agency’s ultimate conclusion regarding the treatment of NCMCWs at the facility. As to Schiller Station, ERG ultimately concluded that “ELG-based Cu and Fe limits apply to [WWTP #2] ‘during boiler chemical cleaning operations only.’”<sup>229</sup> This conclusion, which was purportedly rendered after receipt of input from Region 1, necessarily means that iron and copper effluent limitations do not apply to NCMCW discharges at Schiller Station and therefore supports the comments and conclusions set out in the preceding subpart of these comments.

This 2013 EPA determination, coupled with the documented historical permitting practice for Schiller Station, prove that NCMCWs have been and continue to be treated as a low volume waste not subject to iron and copper effluent limitations. The equitable considerations that caused EPA to refrain from eliminating reliance upon the Jordan Memorandum in its 1982 rulemaking for facilities that have relied upon the guidance policy in the past<sup>230</sup> therefore are applicable to Schiller Station. This historical permitting record must be evaluated and considered in the determination of how NCMCWs will be regulated prospectively at the facility. The new NELGs mandate this assessment.<sup>231</sup> In fact, as mentioned earlier in these comments, EPA went so far as to state in its Response to Comments for the NELGs that no changes to

---

<sup>229</sup> *Id.* (emphasis added).

<sup>230</sup> 47 Fed. Reg. at 52,297.

<sup>231</sup> *See* 80 Fed. Reg. at 67,863.

historical operations at a facility will result from the final rule given that the agency elected to not revise the effluent limitations and/or definitions pertaining to the NCMCW waste stream.<sup>232</sup>

Region 1's failure to even consider, much less evaluate, the historical permitting record for Schiller Station is arbitrary, capricious, and violates a tenet of the NELGs. A thorough review of this record demonstrates that NCMCWs are classified as a low volume waste at Schiller Station and therefore should continue to be classified as such, in accordance with the new NELGs.

**3. Region 1's BAT analysis and administrative record are wholly inadequate even if the agency erroneously refuses to continue to classify NCMCWs as a low volume waste**

NCMCWs at Schiller Station should continue to be treated as low volume wastes. Even if Region 1 erroneously rejects this regulatory course of action, the agency is authorized to establish effluent limitations for this waste stream only after it completes a thorough BAT analysis utilizing its BPJ.<sup>233</sup> The BAT analysis set out in the Fact Sheet for the Draft Permit is deficient and will not pass judicial scrutiny. Indeed, none of the information necessary to complete a defensible BPJ-based BAT analysis is to be found in the administrative record.

Region 1 lacks essential data regarding the makeup of NCMCW discharges at Schiller Station necessary to identify the constituents of concern in the waste stream, much less the quantities of each. Furthermore, Region 1 has failed to adequately consider the changes in current processes employed at Schiller Station, as well as the costs necessary to achieve these changes, that would be required to comply with new effluent limitations applicable to this waste

---

<sup>232</sup> See Effluent Limitations Guidelines and Standards for the Steam Electric Power Generating Point Source Category: EPA's Response to Public Comments, Part 4 of 10 at 4-324 (Sept. 2015).

<sup>233</sup> See 80 Fed. Reg. at 67,863.

stream. Thus, the agency has no way of knowing whether its proposed effluent limitations are reasonable and/or cost-effective.

Because the agency's current BPJ-based BAT determination is wholly inadequate, arbitrary, and capricious, Region 1 cannot legally impose iron and copper effluent limitations on NCMCW discharges at Schiller Station.

**a. Relevant legal background**

To conduct a legally-defensible BAT analysis in accordance with Section 304 of the CWA, EPA must first identify "available" technologies by "survey[ing] the practicable or available pollution-control technology for an industry and assess[ing] its effectiveness."<sup>234</sup> Once identified, EPA must evaluate the following factors for each technology to determine which constitutes BAT: the age of equipment and facilities involved; the process employed; the engineering aspects of the application of various types of control techniques; process changes; the cost of achieving such effluent reduction; and non-water quality environmental impacts (including energy requirements).<sup>235</sup> EPA also must consider "the appropriate technology for the category or class of point sources of which the applicant is a member, based upon all available information" and "[a]ny unique factors relating to the applicant."<sup>236</sup> No one factor is determinative; instead, EPA must balance all of the factors in determining BAT.

EPA's analysis of the BAT factors and its determination that the corresponding effluent limitations are economically and technologically achievable must be reasonable.<sup>237</sup> EPA ultimately bears the burden of demonstrating a reasonable basis for its conclusions that the

---

<sup>234</sup> *Nat'l Wildlife Fed'n v. EPA*, 286 F.3d 554, 561 (D.C. Cir. 2002) (quoting *E.I. du Pont de Nemours & Co. v. Train*, 430 U.S. 112, 131 (1977)).

<sup>235</sup> 40 C.F.R. § 125.3(d)(3) (i) – (vi).

<sup>236</sup> 40 C.F.R. §§ 125.3(c)(2)(i)–(ii); 125.3(d)(3); 33 U.S.C. § 1311(b)(2)(A).

<sup>237</sup> *BP Exploration & Oil v. EPA*, 66 F.3d 784, 794 (6th Cir. 1996).

chosen effluent limitations are achievable and a failure to do so renders the limitations arbitrary, capricious, and “not the result of reasoned decisionmaking.”<sup>238</sup> Effluent limitations simply will not pass muster if they are “based on a flawed, inaccurate, or misapplied study.”<sup>239</sup> Likewise, a failure to evaluate any one of the aforementioned BAT factors,<sup>240</sup> and/or demonstrate the effectiveness of the chosen BAT,<sup>241</sup> automatically renders EPA’s BPJ-based effluent limitations arbitrary and capricious.

Cost of the technology and retrofit is especially important. Indeed, the CWA specifically recognizes that BAT must be economically achievable,<sup>242</sup> and requires the “cost of achieving such effluent reduction”<sup>243</sup> to be similarly evaluated.<sup>244</sup> Therefore, the cost determination is two-fold: cost must be considered in the six-factor BAT analysis, and the resulting effluent limitations must be economically achievable.<sup>245</sup> It makes sense that cost is such an important factor in the BAT analysis because “at some point extremely costly more refined treatment will have a *de minimis* effect on the receiving waters.”<sup>246</sup> Thus, EPA is authorized to “balance

---

<sup>238</sup> *Ass’n of Pac. Fisheries v. EPA*, 615 F.2d 794, 820 (9th Cir. 1980); *Chem. Mfr’s Ass’n v. EPA*, 885 F.2d 253, 265 (5th Cir. 1989); *Reynolds*, 760 F.2d at 559.

<sup>239</sup> *Texas Oil & Gas Ass’n v. EPA*, 161 F.3d 923, 935 (5th Cir. 1998).

<sup>240</sup> See, e.g., *Texas Oil & Gas Ass’n v. EPA*, 161 F.3d 923, 934–35 (5th Cir. 1998) (noting that a failure to consider the age of the equipment and the facilities involved when determining BAT would constitute an abuse of discretion); *Am. Iron & Steel Inst. v. EPA*, 526 F.2d 1027, 1048 (3d Cir. 1975) (remanding effluent limits because EPA did not consider the age of the facilities involved and the impact that age would have on the cost and feasibility of retrofitting older facilities).

<sup>241</sup> *Ass’n of Pac. Fisheries*, 615 F.2d at 819; *Chem. Mfr’s Ass’n*, 885 F.2d at 265.

<sup>242</sup> 33 U.S.C. § 1311(b)(2)(A)(i).

<sup>243</sup> 40 C.F.R. § 125.3(d)(3).

<sup>244</sup> See *Texas Oil & Gas Ass’n* 161 F.3d at 934 (noting cost refers to a consideration of the cost of the technology itself).

<sup>245</sup> See *Ass’n of Pacific Fisheries*, 615 F.2d at 819-20 (finding that EPA’s failure to adequately consider the cost of land acquisition in the determination of whether a technology is an achievable technology is an example of unreasonable decision-making).

<sup>246</sup> *Id.* at 818; see also *Am. Petroleum Inst. v. EPA*, 787 F.2d 965, 972 (5th Cir. 1986) (providing that “EPA would disserve its mandate were it to tilt at windmills by imposing BAT limitations which removed *de minimis* amounts of polluting agents from our Nation’s waters, while imposing possibly disabling costs upon the regulated



factors such as cost against effluent reduction benefits” and, courts have upheld EPA’s decision to reject a technology based on high economic impacts that might otherwise have been the most effective pollution control technology.<sup>247</sup>

EPA has repeatedly contended it need not conduct a cost-benefit analysis as part of its BAT determination. Even if EPA’s assertion is correct—which PSNH does not concede<sup>248</sup>—this does not mean that cost is not important in the BAT analysis and the establishment of effluent limitations. EPA must implicitly consider the costs of the technology and the corresponding benefits received from the technology because of the duty to consider all of the factors in the BAT analysis. Additionally, the final BAT effluent limitations that are established must be economically achievable for the source.<sup>249</sup> In fact, the BPJ analysis requires a further step: the chosen technology must also be appropriate for point sources like the point source subject to the BPJ, based on all available information.<sup>250</sup> “All available information” certainly includes the costs of implementing the proposed BAT at similar facilities. Furthermore, EPA cannot solely rely on the fact that a facility or the public can “afford” a treatment technology as a basis for

---

industry.”) (citing *Alabama Power Co. v. Costle*, 636 F.2d 323 (D.C. Cir. 1979) and *Appalachian Power Co. v. Train*, 545 F.2d 1351 (4th Cir. 1976)).

<sup>247</sup> See e.g., *BP Exploration*, 66 F.3d at 796. (rejecting a technology as BAT, in part, because of the cost of the technology).

<sup>248</sup> Importantly, neither does the Supreme Court or the President. Specifically, in *Entergy Corp. v. Riverkeeper, Inc.*, 556 U.S. 208 (2009), the Court responded to Petitioner’s argument that a “cost –benefit analysis is precluded under the [BAT] test” by stating that “[i]t is not obvious to us that [this] proposition is correct, but we need not pursue that point, [since we assuredly agree with other points].” *Id.* at 221-22. Likewise, the requirements of the President’s Executive Order 13,563 mandate such a cost-benefit consideration on significant regulatory matters. See 76 Fed. Reg. 3821 (Jan. 16, 2011) (providing, in relevant part that “[o]ur regulatory system . . . must be based on the best available science. . . must promote predictability and reduce uncertainty. It must identify and use the best, most innovative, and least burdensome tools for achieving regulatory ends. It must take into account benefits and costs, both quantitative and qualitative” and that “each agency must, among other things: (1) propose or adopt a regulation only upon a reasoned determination that its benefits justify its costs (recognizing that some benefits and costs are difficult to quantify)”).

<sup>249</sup> *Texas Oil & Gas Ass’n*, 161 F.3d at 934.

<sup>250</sup> 40 C.F.R. § 125.3(c)(2).

determining whether it is cost-effective.<sup>251</sup> The cost-benefit evaluation must be more than pretextual.

Once EPA determines BAT on a case-by-case basis based on its BPJ, EPA takes the technology standards established under the factors described above and applies that BAT to create actual effluent discharge limitations under Section 304 of the CWA. It is through the creation of these effluent limitations that EPA imposes technology-based treatment requirements into permits.<sup>252</sup>

a. **Region 1’s definition of “NCMCWs” is vague and seemingly too broad**

Region 1 attempts to define “non-chemical metal cleaning waste” in its Fact Sheet as “any wastewater resulting from the cleaning of metal process equipment without using chemical cleaning compounds.”<sup>253</sup> This definition lacks clarity and is overboard. For instance, must an operator be intending to actually clean a given piece of metal process equipment for the water that comes in contact with it to constitute NCMCWs? If so, is water that incidentally contacts metal process equipment still considered a low volume waste? Interjecting subjective intent into the definition of NCMCWs is problematic and will create unnecessary confusion for PSNH and personnel at the facility. And, what all is included in the definition of “metal process equipment?” Will water intended to clean an electrical junction box associated with operation of the CWISs or water from an intake screen backwash constitute NCMCWs—requiring

---

<sup>251</sup> If this were the case, EPA would be able to forego rigorous analyses of what technology is necessary for a particular site, and just rely on whether the owner of that facility is a Fortune 100, 500, or 1000 company ostensibly with deep pockets. *See In re Pub. Serv. Co. of New Hampshire (Seabrook Station, Units 1 and 2)*, Case No. 76-7, 1 E.A.D. 332, 1977 WL 22370, at \*7 (EAB 1977) (“Seabrook”).

<sup>252</sup> *See* 40 C.F.R. § 125.3(c). EPA does not require the permittee to use this exact technology, and instead the permittee may use whatever technology it desires as long as the technology can achieve the effluent limits. *See, e.g., Nat’l Wildlife*, 286 F.3d at 561. However, application of EPA’s chosen technology is generally the only way to achieve the effluent limitations.

<sup>253</sup> Fact Sheet at 37.

segregation and isolated chemical precipitation treatment? Without clarity on these issues, it is not possible for PSNH to know what process changes and/or retrofits will be required to comply with the new permit.

In crafting this bloated definition of NCMCWs, Region 1 has ignored EPA's historical management of this waste stream and disregarded the instructive list of pieces of metal process equipment specifically referenced in the definition of "metal cleaning wastes" to serve as a guide for determining the scope of regulation for metal cleaning wastes (chemical and nonchemical) at a given facility. "Metal cleaning wastes" were first defined in the 1974 ELGs as "any cleaning compounds, rinse waters, or any other waterborne residues derived from cleaning any metal process equipment including, but not limited to, boiler tube cleaning, boiler fireside cleaning and air preheater cleaning."<sup>254</sup> For decades, EPA focused on developing data limited to chemical boiler cleaning wastes and NMCMWs associated with water washing of ash on boiler firesides and air preheaters. This makes perfect sense, given that these pieces of metal process equipment are specifically referenced in EPA's definition for the waste stream. This list was presumably included in the definition for a reason. Although it is not exclusive, inclusion of a representative list such as this one should be interpreted to clarify that the agency never intended for all water that comes in contact with any metal process equipment to be interpreted as metal cleaning waste. To do so renders the representative list of metal process equipment included in the "metal cleaning waste" definition semantic and meaningless.

Only recently, as a part of the 2015 ELGs, did EPA attempt to better ascertain the potential breadth of the metal cleaning waste stream and gather corresponding additional data beyond water washing of ash on boiler firesides and air preheaters. And, this effort proved

---

<sup>254</sup> 39 Fed. Reg. 36,186, 36,205 (Oct. 8, 1974).

fruitless, as the agency itself provided that “plants refer to the same [NMCW] operation using different terminology” and that results of EPA’s data collection efforts are “skewed” and insufficient.<sup>255</sup> Region 1 has not concerned itself with understanding the wastewater management issues that will arise at Schiller Station by the expansive definition of NMCWs advanced in the Draft Permit. Nor has the agency heeded the specific list of metal process equipment included in the definition of “metal cleaning wastes” and attempted to extrapolate a reasonable list of additional metal process equipment that may be included in the definition of NMCWs at Schiller Station. Instead, Region 1 has elected to adopt a definition of NMCWs that is seemingly all-inclusive. This interpretation is not supported by the administrative record and cannot pass muster without additional analysis or discussion of the costs (including infrastructure needs) and expected pollutant reductions associated with such an expansive definition. In actual fact, expanding the meaning of “NMCWs” to water washing of process equipment other than gas-side ash removal will be expensive and of limited environmental benefit, especially if comingling is prohibited and iron and copper limits imposed. Any definition of NMCWs should therefore be restricted to the gas-side removal of ash without chemicals. A suitable definition of “NMCWs” would be “any wastewater from the cleaning of ash from gas-side process equipment from the boiler to the stack without chemical cleaning compounds, including boiler fireside cleaning and air preheater cleaning.”

**b. There is no NMCW discharge data in the current administrative record**

Central to any BPJ-based BAT determination is a keen understanding of the waste stream to be regulated. Knowledge of both the kind and quantity of constituents found within that waste stream is fundamental inasmuch as it provides the only foundation upon which to assess the costs

---

<sup>255</sup> See 80 Fed. Reg. at 67,863.

and economic achievability of any proposed regulation of the wastewater. Region 1 lacked the necessary information regarding NCMCWs generated at Schiller Station. This is so regardless of the precise definition of the waste stream advanced by the agency. Specifically, a review of the administrative record for this permit renewal proceeding reveals Region 1 does not possess any data analyzing isolated discharges of NCMCWs at Schiller Station. Instead, what Region 1 does possess is limited data of constituents discharged through Outfall 016, in accordance with the terms and conditions of the current permit.<sup>256</sup> NCMCWs comprise only a small, relatively infrequent, and varying fraction of the total volume of wastewater discharged through this internal outfall. It is therefore improper for Region 1 to attempt to rely upon this data as representative of constituents found in isolated NCMCW discharges at Schiller Station.<sup>257</sup>

The reality is that currently there is no data analyzing isolated NCMCWs generated at Schiller Station due to the fact that PSNH historically has relied upon the Jordan Memorandum and commingled this waste stream with other low volume waste streams periodically generated at the facility. PSNH never needed to analyze this isolated waste stream due to this longstanding practice; nor has Region 1 ever requested any analyses of isolated NCMCWs over the 50+ year life of this facility. This is true despite the agency's inexplicable attempt to alter the regulatory requirements applicable to this waste stream in this permit renewal proceeding. This data is indispensable in establishing reasoned BPJ-based BAT effluent limitations. The agency's current BAT analysis is therefore necessarily arbitrary, capricious, and "not the result of

---

<sup>256</sup> See AR-044, AR-139, AR-142, & AR-214 to AR-220.

<sup>257</sup> Reliance upon data and/or facts pertaining to chemical metal cleaning wastes discharged through Outfall 017 at Schiller Station as representative of NCMCW discharges is also not acceptable, as chemical metal cleaning wastes are much more complex and warrant individual management because they are more difficult, and take significantly more time, to effectively treat before they may be properly discharged.

reasoned decisionmaking” given it ultimately is Region 1’s burden to demonstrate a reasonable basis for its conclusions that its chosen effluent limitations are achievable.<sup>258</sup>

Collecting a representative sample of NCMCWs at Schiller Station could prove difficult, if not impossible, due to the current configuration and operation of the facility. Region 1’s supposition in the Fact Sheet that PSNH can prospectively either:

- (1) eliminate or divert all other low volume waste streams whenever NCMCWs are being generated and treated; or
- (2) divert isolated NCMCWs to another treatment process before commingling it with other low volume waste streams,<sup>259</sup>

simply does not reflect reality given wastewater treatment at the facility was designed to centrally treat all wastewaters, meaning commingled treatment of NCMCWs with other low volume wastes is unavoidable.

Region 1 has not, and indeed cannot, adequately evaluate the requisite BAT factors and establish BPJ-based effluent limitations for NCMCW discharges at Schiller Station without representative data of isolated NCMCWs generated at the facility. Its attempt to do so in this permit renewal proceeding is arbitrary, capricious, and a violation of the CWA and EPA’s implementing regulations.

Although not mentioned in the Fact Sheet or the administrative record, it likewise would be improper, arbitrary, and capricious for Region 1 to attempt to rely upon any NCMCW data compiled by EPA for use in formulating its NELGs for the industry. This is prohibited when

---

<sup>258</sup> See, e.g., *Ass’n of Pac. Fisheries*, 615 F.2d at 820.

<sup>259</sup> Fact Sheet at 36.

generating site-specific effluent limitations utilizing BPJ.<sup>260</sup> Furthermore, even if reliance on industry data were acceptable, the data EPA has collected over the years is of limited or no utility. EPA admits as much in its latest NELGs:

EPA based [its 2013 NCMCWs BAT] proposal on EPA's understanding, from industry survey responses, that most steam electric power plants manage their chemical and non-chemical metal cleaning wastes in the same manner. Since then, based in part on public comments submitted by industry groups, the Agency has learned that plants refer to the same operation using different terminology; some classify non-chemical metal cleaning waste as such, while others classify it as low volume waste sources. Because the survey responses reflect each plant's individual nomenclature, the survey results for non-chemical metal cleaning wastes are skewed. Furthermore, EPA does not know the nomenclature each plant used in responding to the survey, so it has no way to adjust the results to account for this. Consequently, EPA does not have sufficient information on the extent to which discharges of non-chemical metal cleaning wastes occur, or on the ways that industry manages their non-chemical metal cleaning wastes. Moreover, EPA also does not have information on potential best available technologies or best available demonstrated control technologies, or the potential costs to industry to comply with any new requirements. Due to incomplete data, some public commenters urged EPA not to establish BAT limitations for non-chemical metal cleaning wastes in this final rule. Ultimately, EPA decided that it does not have enough information on a national basis to establish [BAT] requirements for non-chemical metal cleaning wastes. The final rule, therefore, continues to "reserve" [BAT] for non-chemical metal cleaning wastes, as the previously promulgated regulations did.<sup>261</sup>

Data from the agency's 1974 and 1982 rulemakings is also unsuitable. There was no representative or verified data of isolated NCMCW discharges in the record of the 1974 ELG rules. And, the agency's 1982 record contained only limited data on fireside washes that, if anything, demonstrated applying iron and copper limits to NCMCWs is unnecessary and would

---

<sup>260</sup> See, e.g., EPA NPDES Permit Writers' Manual, EPA-833-K-10-001 (Sept. 2010) at 5-44 to -48 (listing a facility's NPDES application form and discharge monitoring reports as sources of permissible information about constituents found in a given waste stream and further providing that without such data, "[t]he permit writer might need to establish a monitoring-only requirement in the current NPDES permit to identify pollutants of concern and potential case-by-case limitations for the subsequent NPDES permit renewal.").

<sup>261</sup> See 80 Fed. Reg. at 67,863; see also Effluent Limitations Guidelines and Standards for the Steam Electric Power Generating Point Source Category: EPA's Response to Public Comments, Part 7 of 10 at 7-179 (Sept. 2015) (providing that "[b]ecause EPA lacks solid baseline information about what the current practices are, which is the foundation for assessing costs and economic achievability, as well as the other factors required to be assessed for BAT the final rule continues to reserve [BAT] for non-chemical metal cleaning wastes, as the previously promulgated regulations did.").

be extremely expensive, and ultimately led EPA to conclude the available “data were too limited to make a final decision” in that rulemaking initiative.<sup>262</sup>

These collective realities compel the conclusion that Region 1 lacks sufficient data on the waste characteristics of NCMCWs to adequately assess the feasibility and costs of controlling the waste stream at Schiller Station by and through the imposition of new BPJ-based effluent limitations. Its attempt to do so in the Draft Permit despite the lack of this imperative data is arbitrary and capricious. Indeed, despite the fact that the agency refused to set BAT effluent limitations in the NELGs due to incomplete data and information, Region 1 is attempting here to impose BPJ-based limitations with no data. This too is arbitrary and capricious.

c. **Requiring changes in current plant processes to segregate and treat NCMCWs would be difficult, if not impossible**

Current infrastructure and processes employed at Schiller Station would need to be extensively overhauled to attempt to segregate and treat NCMCWs from other low volume wastes, as Region 1 has proposed in the Draft Permit. Even then, complete segregation from other low volume waste streams prior to treatment may not be possible. Region 1 attempts to gloss over these operational realities by baldly asserting PSNH can either eliminate or divert all other low volume waste streams whenever NCMCWs are being generated and treated or divert isolated NCMCWs to another treatment process before commingling the waste stream with other low volume waste streams.<sup>263</sup> These abstract statements ignore that Schiller Station was specifically designed to handle and treat smaller and less infrequent waste streams, like NCMCWs, in a centralized manner for the sake of efficiency. Attempting to overhaul this

---

<sup>262</sup> See 47 Fed. Reg. at 52,297.

<sup>263</sup> See Fact Sheet at 36.



decades-long practice does not take place by the push of a button or a change in operational procedure.

As currently proposed, any wash water that comes in contact with any “metal process equipment” constitutes NCMCWs, according to Region 1’s broad definition.<sup>264</sup> At Schiller Station, this includes all wash water utilized to pressure wash boilers, air heaters, precipitators, and stacks, among other associated process equipment. Within the industry, the primary treatment system for wastewaters of this kind is designed to operate in a centralized manner, i.e., to mix streams and manage them together in order to be efficient.<sup>265</sup> Schiller Station is no different.

For instance, wastewaters from boiler blowdown, demineralizer regenerations, and floor drains (collectively considered low volume wastes) are commingled at Schiller Station, both out of necessity and by design. Even during other shorter outages, Schiller Station’s floor drains are routinely exposed to fireside wastewater or some other nonchemical metal cleaning operation, *e.g.*, condenser and heat exchanger cleanings. Therefore, the floor drain system routinely transfers a combination of low volume wastes and NCMCWs from Schiller Station to the treatment facility.

A mandate to manage NCMCWs separately is not currently possible at Schiller Station since the wastewater treatment facilities were designed to centrally treat all wastewaters. Such wash waters necessarily end up in floor drains, where they are unavoidably combined with other low volume wastes. Furthermore, even if possible, segregation of NCMCWs from other low

---

<sup>264</sup> See Fact Sheet at 37.

<sup>265</sup> See, *e.g.*, EPA Technical Development Document for the Effluent Limitations Guidelines and Standards for the Steam Electric Power Generating Point Source Category, EPA-821-R-15-007 (Sept. 2015), at 8-19 (“The vast majority of plants combine some of their legacy wastewater with each other and with other waste streams, including . . . metal cleaning wastes, and low volume waste sources in surface impoundments.”).

volume waste streams would be labor intensive (e.g., construction of isolated berms or other temporary containment structures so that wash water could be contained and held for treatment) and likely lead to upsets and/or recurring operational issues.

Further complicating matters is that the infrastructure retrofits necessary to isolate NCMCWs, as Region 1 has proposed, are generally very expensive and, once installed, necessarily preclude other technologies from occupying the same space, meaning facilities have limited space in which to achieve the maximum environmental benefit from control technologies. The relative infrequency of nonchemical metal cleaning operations at Schiller Station, the comparatively low concentrations of constituents of concern believed present in the NCMCWs, the fact the metals in the waste stream settle out easily, and the substantial volume of water generated during a unit wash down (at least under Region 1's expansive definition of what constitutes NCMCWs) that would need to somehow be isolated and retained, lead to only one reasonable conclusion: the investment in retrofit technology for the isolated treatment of NCMCWs cannot be justified given all other environmental regulatory initiatives requiring retrofits that compete for the same space within the facility.

Managing NCMCWs in the manner Region 1 has proposed in the Draft Permit will likely require the addition of a second storage facility at Schiller Station. Unless a facility has a substantial existing footprint with copious amounts of unused real estate, which Schiller Station does not, the most likely option to fit a storage facility would be to reclaim a section of an existing treatment system to construct new basins. This is a costly proposition and would impact the effectiveness of treatment currently provided by reducing retention time in existing treatment systems.

Separately, Region 1 is forthright that its initiative to isolate NCMCWs from other low volume wastes is to avoid the purported dilution of the concentration of certain constituents that occurs when these streams are commingled. Remarkably, even under the regulatory scheme proposed in the Fact Sheet to the Draft Permit, there is no practical way to regulate dilution. Region 1 has no means of knowing or predicting how much water a permittee will need to use to clean its equipment and facilities to a satisfactory level, nor does Region 1 have a right to regulate such cleaning. Commingling of waste streams is about providing an efficient, centralized method of treatment in accordance with the facility's original design and has nothing to do with secretly diluting wastewater.

**d. Use of a combined waste stream formula will not work at Schiller Station**

Region 1 advances the development of a combined waste stream formula as one potential mechanism for handling and treating NCMCWs in the manner it has proposed in the Draft Permit.<sup>266</sup> The agency asserts that electing to comply with the proposed permit limitations utilizing this approach could be less expensive than making engineering modifications at the facility.<sup>267</sup> In reality, use of a combined waste stream for the effective treatment of NCMCWs at Schiller Station is not practical and would likely result in the use and waste of thousands of dollars of chemical treatments not ultimately necessary to comply with the proposed iron and copper effluent limitations.

To establish effluent limitations for NCMCWs based on a combined waste stream formula, Region 1 states that it will need “a comprehensive list of all non-chemical metal cleaning, low volume and stormwater waste streams that currently commingle at WWTP #2.

---

<sup>266</sup> See Fact Sheet at 36.

<sup>267</sup> See Fact Sheet at 41.

This list must include the total volume, frequency and concentrations of iron and copper for each wastewater stream.<sup>268</sup> It is in providing the respective total volumes, frequencies, and concentrations of iron and copper for NCMCWs and each of current waste streams commingled with NCMCWs that best illustrates the impracticalities associated with this treatment theory. No two volumes of NCMCWs are the same for equipment water washes at Schiller Station or anywhere in the industry. EPA recognized this as part of its 2015 ELGs rulemaking: “Additionally, some waste streams have significant variations in flow, such as metal cleaning wastes.”<sup>269</sup> The volumes of boiler blowdown, demineralizer regenerations, floor drains, and other low volume wastes currently commingled with NCMCWs at Schiller Station likewise fluctuate a great deal.

The frequencies at which these various commingled waste streams are generated vary significantly, as well. Employing Region 1’s overly-broad definition of NCMCWs, some form of this waste stream may be generated hourly or daily most days and may be continuous for extended periods of time during a planned outage. Frequencies of boiler blowdown, demineralizer regenerations, floor drains, and other commingled low volume wastes often times vary a great deal depending upon plant operations and other factors, as well.

Concentrations of iron and copper attributable to each waste stream are likewise impossible to predict or estimate with any degree of certainty and would be further compounded by intake credit issues.<sup>270</sup> While the discharge monitoring reports for the facility demonstrate that concentrations of iron and copper from these combined low volume waste streams have

---

<sup>268</sup> Fact Sheet at 36 n.7 (emphasis added).

<sup>269</sup> 80 Fed. Reg. at 67,855.

<sup>270</sup> See 40 C.F.R. § 122.45(g) (providing that technology-based effluent limitations shall be adjusted to reflect credit for pollutants in the discharger’s intake water under certain conditions).

never so much as approached the effluent limitations applicable at Schiller Station,<sup>271</sup> PSNH currently has no way of knowing what amount of iron and copper limits are attributable to each isolated low volume waste stream. Moreover, given the aforementioned variables, PSNH has serious doubts that the concentrations of iron and copper within these isolated low volume waste streams remain consistent. Instead, it is more likely that the amount of iron and copper in, for instance, NCMCWs and wastewater entering floor drains fluctuate a great deal depending upon plant and/or personnel operations.

Due to the aforementioned myriad of variables and unknowns, establishing a preset formula to effectively treat NCMCWs at Schiller Station and ensure compliance with the proposed iron and copper effluent limitations utilizing the combined waste stream theory is not possible. Attempting to rely upon a formula such as this would cause PSNH to either over-treat the combined waste stream with excessive amounts of chemicals to precipitate out the iron and copper constituents at a significant annual cost to the company and its customers or, conversely, subject PSNH to frequent and repeated exceedances of the proposed effluent limitations due to the great degree of variability in the makeup of the combined waste stream. Neither scenario is a sensible one. The combined waste stream formula approach should therefore be disregarded as impractical for the regulation of NCMCWs at Schiller Station.

e. **Region 1 did not even attempt to evaluate the cost of its proposed regulation of NCMCWs**

“Modest” and “relatively insignificant”—these are the two terms used within the four-sentence analysis that comprises the entirety of Region 1’s discussion of the anticipated costs to

---

<sup>271</sup> Again, these effluent limitations are made applicable only to ensure iron and copper constituents are not being discharged at times other than chemical cleaning operations and to confirm that metals are not present in any unexpected waste stream during normal operations.

comply with the regulatory requirements applicable to NCMCWs set out in the Draft Permit.<sup>272</sup> The agency's attempt to convert its cost-effectiveness analysis into a cursory "affordability" determination is impermissible, wholly inadequate, and legally insufficient.<sup>273</sup> Region 1 failed to even estimate in its Fact Sheet or in the administrative record the actual monetary amount required for PSNH to comply with its anticipated regulation of NCMCWs under any of its proposed scenarios.<sup>274</sup> It is the agency's burden to demonstrate a reasonable basis for its conclusions that the chosen effluent limitations are achievable. More is required than its speculative and conclusory analysis here.<sup>275</sup>

PSNH has never undertaken to estimate the costs associated with attempting to isolate NCMCWs at Schiller Station. Indeed, there has never been a reason to do so given the longstanding classification of this waste stream as a low volume waste, in accordance with the

---

<sup>272</sup> See Fact Sheet at 40-41.

<sup>273</sup> See *Seabrook*, 1977 WL 22370, at \*7.

<sup>274</sup> Again, Region 1 cannot attempt to rely upon any data or information EPA has collected or generated as part of its recent NELGs rulemaking because the agency has stated time and again that the data pertaining to NCMCWs it has collected is insufficient and does not accurately reflect how this waste stream is handled within the industry:

At the time of the final rule, EPA acknowledges not having sufficient information to perform a nationwide BAT evaluation for non-chemical metal cleaning wastes. Information such as:

- identification of potential treatment systems that represent BAT for non-chemical metal cleaning wastes;
- cost information for BAT technologies;
- wastewater characterization data for untreated non-chemical metal cleaning wastes; and
- treatment system performance data for the treatment of non-chemical metal cleaning wastes.

Effluent Limitations Guidelines and Standards for the Steam Electric Power Generating Point Source Category: EPA's Response to Public Comments, Part 7 of 10 at 7-393 (Sept. 2015).

<sup>275</sup> See *Ass'n of Pac. Fisheries v. EPA*, 615 F.2d at 820 (finding that a failure to explain and justify a BAT determination renders the resulting effluent limitations arbitrary, capricious, and "not the result of reasoned decisionmaking"); see also Effluent Limitations Guidelines and Standards for the Steam Electric Power Generating Point Source Category: EPA's Response to Public Comments, Part 7 of 10 at 7-179 (Sept. 2015) (providing that "the CWA requires EPA to make a reasonable assessment of costs. Without a baseline of what is the status quo, it is difficult to make a reasonable assessment of the cost of additional controls").

Jordan Memorandum. Even without the benefit of a detailed analysis, PSNH can offer the following comments that adequately demonstrate that the costs required to attempt to reconfigure the facility to separately manage NCMCWs would be more than “modest” or “relatively insignificant” and, in fact, would be substantial enough to grossly outweigh whatever benefits Region 1 expects to arise from the isolation of this waste stream.

Ensuring that NCMCWs would never be commingled with boiler blowdown, demineralizer regenerations, floor drains, and other low volume wastes at Schiller Station could likely require the design and installation of a collection system, supporting pumps and pipes, lined basin, and chemical precipitation treatment system capable of capturing and transporting the maximum quantity of NCMCW produced during a three-day outage and processing NCMCWs within a 30 day period. The estimated capital costs for modifications of this kind at facilities within the industry can range from a few to in excess of \$32 million.<sup>276</sup> And, annual operation and maintenance costs would also likely be substantial.

The table below, submitted by UWAG in its comments to EPA’s 2013 proposed rule for the NELGs, itemizes costs actually incurred at a facility that installed necessary infrastructure to isolate and achieve the 1.0 mg/L copper and iron limits for NCMCW discharges:

---

<sup>276</sup> These monetary figures were compiled by and through a review of public comments submitted by the industry in response to EPA’s 2013 proposed rulemaking for the now final NELGs. *See* Docket EPA–HQ–OW–2009–0819, available at <http://www.epa.gov/eg/steam-electric-power-generating-effluent-guidelines-2015-final-rule> and [www.regulations.gov](http://www.regulations.gov).

<b>Equipment/Product/Task</b>	<b>Cost</b>
Internal & External Engineering Cost	\$ 475,235
Exiting Tank Retrofits & Refurbishment - Clarifier Tank & Clean Effluent Tank (Chemical Clean Tank)	\$ 1,148,568
Collection Package Civil - Collect Trenches and Wash Sump Construction; Neutralization Basin Closure	\$ 1,615,712
Material & Equipment Purchases - Pump Sumps (Qty-4); Sludge Recycle Pumps (Qty-2) Sludge Disposal Pumps (Qty-2); Clarifier Conversion Internals; Rake Drive Reaction Tank	\$ 2,568,508
Electrical & Control & Instrumentation Install VFDs (Qty-8); MCCs; AllenBradley PLC w/HMI; Remote I/O; Chemical Skids (Qty-2); Instrumentation (All); Cable; Conduits; Lighting	\$ 1,022,971
Mechanical Install Installation of Interconnecting Piping; Supports; Reaction Tank, Clarifier Tank-Walkways-Rake-Truss	\$ 1,735,273
Reaction Tank Foundation - Concrete and Steel Supports	\$ 222,204
Metal Wash Startup Support/Training	\$ 5,394
Metal Wash Startup Support/Training	\$ 2,343
<b>Total of Current Expenditures</b>	<b>\$ 8,796,208</b>
<b>Additional Planned Improvements</b>	<b>\$ 350,000</b>
<b>Planned Total Expenditures</b>	<b>\$ 9,145,208</b>

Like Schiller Station, the facility has three generating units and its operator installed a metal cleaning wastewater collection system on each unit with piping to direct the wastewater to a common treatment system. Solids generated in the system are sent to the facility's existing solid waste processing system. The treated effluent is sampled to demonstrate compliance before being piped to and mixed with the facility's low volume wastewater collection/treatment system



for discharge. Importantly, some of the infrastructure needed for this project was already available at the facility and only needed to be re-purposed or required repairs or modification. Had the operator not been able to reuse this equipment, use the existing solid waste processing system, and use covered areas for equipment that needed to be indoors, the capital expenditures would have been much greater.

The aforementioned comments demonstrate Region 1's current assessment of costs necessary to isolate and treat NCMCWs at Schiller Station is grossly inadequate. The CWA and EPA's own regulations require a more rigorous analysis that, at a minimum, includes competently comparing the anticipated benefits and the relative cost of achieving those benefits before imposing BPJ-based effluent limitations in a permit. Had the agency undertaken such an analysis, it would have been apparent that the costs associated with regulating NCMCWs in this manner grossly outweigh whatever benefits Region 1 expects to yield by its proposed changes to the permit for the facility.

Collectively, these comments, the administrative record, and a reasoned evaluation of the factors that must be considered in a BAT analysis, demonstrate that Region 1 cannot impose iron and copper effluent limitations on NCMCW discharges at Schiller Station and that the agency's current BPJ-based BAT determination is wholly inadequate, arbitrary, and capricious and must be revisited prior to issuing the Draft Permit as final.

**4. If Region 1 erroneously elects to impose iron and copper limits on NCMCWs, it should allow PSNH sufficient time to comply**

The Draft Permit purportedly would require PSNH to comply with the proposed iron and copper limits for the NCMCW stream on the effective date of the final permit. This is based on Region 1's incorrect assumption that the new effluent limits will not require changes to the infrastructure and treatment systems at Schiller Station in order to efficiently comply with these

new limitations. In truth, and due to the reasons articulate above, PSNH would have to extensively modify pipes, sumps, and treatment systems so as to collect isolated NCMCW discharges and treat them by chemical precipitation for iron and copper. The facility would also likely have to perform extensive excavation of existing sumps and piping and install new pipes and treatment tanks. This work in isolation could take two years or more to complete and could be even further complicated or prolonged due to any approvals and/or permits that may be required, as well as by other EPA rulemakings that may cause a need for other significant modifications at the facility in the foreseeable future, such as EPA’s ozone National Ambient Air Quality Standards revisions and possibly others.

\* \* \* \* \*

For the reasons stated above, Region 1 must not—and indeed cannot based on the current permitting record—impose iron and copper effluent limitations on NCMCW discharges at Schiller Station and should allow such wastewaters to continue to be classified as a low volume waste stream and commingled with other similar low volume waste streams.

**D. Miscellaneous Issues with the Draft Permit**

In addition to Region 1’s arbitrary and capricious determinations with regard to CWA § 316(b) and NCMCWs, the agency has included other terms in the Draft Permit that PSNH requests be reconsidered and revised before a final permit is issued. The revisions of these permit terms (discussed in order by outfall or permit part) are proposed to provide Schiller Station with a more manageable permit that continues to protect water quality to the maximum extent reasonably practicable.

**1. Outfalls 002, 003, and 004**

PSNH respectfully requests that the currently allotted two-hour period during which the temperature difference or rise between the withdrawal and discharge of water at the facility may

be increased from 25°F to 30°F to conduct condenser maintenance be increased to a period of three hours. PSNH is hopeful Region 1 will provide the company the opportunity to demonstrate that this “Delta-T” temperature can be increased from 25°F to 30°F at all times without causing any appreciable harm to the BIP of the Piscataqua River. Until that time, however, PSNH requires a three-hour window of time to allow personnel adequate time to clean and maintain the condensers.

## **2. Outfall 006**

PSNH requests that the monitoring conditions applicable to this outfall remain unchanged from the existing permit and the proposed pH discharge limitation be omitted. Region 1 expressly states in its Fact Sheet that discharges through this outfall are “rare.”<sup>277</sup> In actual fact, PSNH has utilized this outfall only one time within the past five years and, in that instance, the discharge would have complied with the pH limits proposed in the Draft Permit.<sup>278</sup> Moreover, the entire volume of the discharge on this occasion was approximately 200 gallons, which is infinitesimal compared to the size and volume of the Piscataqua River. Specific measures have been implemented in recent years at Schiller Station to reduce the number of discharges through this outfall, including but not limited to the installation of instrumentation to limit deaerator overflows and the repiping of the Unit 6 blowdown tank to the wastewater treatment system. These measures have proven effective at eliminating the emergency conditions that cause boiler water to flow through this outfall, which is evidenced by the fact that it has been used only once within the past five years compared to the 22 times it had been utilized in the preceding 20 years of the current permit term.

---

<sup>277</sup> Fact Sheet at 26.

<sup>278</sup> See EPA Enforcement and Compliance History Online Database, available at <http://echo.epa.gov/effluent-charts#NH0001473> (last visited Jan. 26, 2016) (listing a pH value of 6.9 SU through Outfall 006 on January 25, 2011).

PSNH expects that the pH of wastewater discharged through Outfall 006 would only occasionally exceed the maximum 8.0 SU limit proposed in the Draft Permit, but Region 1 proposes that if compliance is not maintained PSNH would be “required to route this wastewater to the on-site WWTP for pH neutralization.”<sup>279</sup> The modifications required to reroute the network of boiler and turbine piping would be costly and the expenditures would far exceed any environmental benefit the treatment of such a small volume of wastewater would yield.

In the end, the infrequent use of the outfall, the comparatively tiny volume of wastewater discharged through the outfall on the isolated occasions when it is used, coupled with the high costs associated with treating this rare and sporadic waste stream, all point to a reasonable and practical solution that the pH effluent limitations set out in the Draft Permit should be omitted. PSNH has successfully reduced the frequency of use from a few times a year to roughly once per permit cycle. At the very least, PSNH requests a continuation of the pH monitoring requirement in the final permit for this outfall, allowing Region 1 to revisit the need for numeric limitations in the next permit cycle. If it is determined that the outfall has been used to discharge wastewater with undesirable pH levels with sufficient regularity, then the imposition of numeric effluent limitations can be justified at that time based on this additional data.

PSNH also requests the Total Suspended Solids (“TSS”) and oil and grease effluent limitations, as well as the Nitrogen monitoring requirements, proposed for this outfall be deleted as unnecessary. Boiler condensate is the only waste stream that is discharged through this outfall with any regularity and it will not contain TSS or oil and grease in any quantity that will even approach the limits proposed in the Draft Permit.<sup>280</sup> The same is true for the Nitrogen

---

<sup>279</sup> Fact Sheet at 26.

<sup>280</sup> Indeed, PSNH disclosed TSS and oil and grease values in its permit application of <10mg/L and <5mg/L, respectively.

monitoring proposed in the Draft Permit. Representative historical monitoring of this outfall reveals that these constituents have not been discharged through this outfall in appreciable quantities.<sup>281</sup> Imposing the aforementioned limitations and/or monitoring requirements on the outfall create unnecessary administrative burdens that result in pointless expenditures by PSNH. PSNH requests this monitoring be omitted from the final permit given the extremely rare conditions that are necessary to cause a release, the relatively clean water involved (treated boiler water), and the very small volumes of water discharged.

### **3. Outfall 11**

Language in the Draft Permit for this outfall currently provides that “[t]he combined discharge of the 3 individual pipes shall be considered a representative sampling point.”<sup>282</sup> The three individual pipes are not always discharging at the same time, however. This language should therefore be revised to make clear that it is a single composite sample of all discharging pipes at the time of collection that is required and will be considered representative of the sampling point.

pH monitoring should only be required quarterly instead of the monthly interval proposed in the Draft Permit. The quarterly interval would be consistent with the requirements applicable to Outfall 018, through which storm water is similarly discharged. A monthly monitoring requirement creates an unnecessary administrative burden on the company and results in the expenditure of needless dollars with no ultimate improvement to the environment.

The imposition of TSS monitoring at this outfall is unwarranted. Region 1 notes that oil and grease effluent limitations exist in the current NPDES permit for Schiller Station but the

---

<sup>281</sup> Again, PSNH disclosed in its permit application the following concentrations of nitrogen-related constituents: nitrate-nitrite (<0.05 mg/L), total organic nitrogen (<5 mg/L), and ammonia (0.9 mg/L).

<sup>282</sup> Draft Permit at 6.

agency does not explain why that is the case. Instead, simply because such limitations exist in the 1990 permit, the agency makes the analytical leap that low volume wastes must be routed through this outfall. Whether flows from heater condensate drains constitute a low volume waste is an open question given that it does not fall squarely within the regulatory definition<sup>283</sup> and because Region 1 did not even attempt to discuss or reason why such a waste stream should or does constitute a low volume waste subject to the TSS effluent limitations. Effluent with material concentrations of TSS is not typically discharged through this outfall.<sup>284</sup> The TSS effluent limitation is therefore not needed and its inclusion in the Draft Permit creates an unnecessary administrative burden on the company and results in the expenditure of needless dollars with no potential overall improvement to the environment.

The Polynuclear Aromatic Hydrocarbons (“PAH”) effluent monitoring requirements applicable to this outfall are also unwarranted. There is no history of these constituents being discharged at Schiller Station. And, Region 1 should have requested limited sampling for these PAHs in advance of issuing the Draft Permit if the agency thought they were a potential concern. Waiting to raise this issue in the context of a new NPDES permit for the facility is cumbersome and creates an ongoing 5+ year monitoring obligation that could have potentially been dismissed if addressed in a different manner. Region 1 does provide that the frequency of monitoring for these PAHs can be reduced if the first two years of data collection reveals no such discharges exist. This proffered reduction in monitoring is insufficient, however. If PAHs are not present in the discharges at Schiller Station, PSNH should not be required to continue to monitor for them for the duration of the permit term.

---

<sup>283</sup> See 40 C.F.R. § 423.11(b).

<sup>284</sup> PSNH disclosed TSS concentrations in its permit application of <10mg/L.

The Nitrogen monitoring requirements proposed for this outfall should likewise be omitted for the reasons articulated above in the discussion pertaining to Outfall 006.

#### **4. Outfall 018**

The TSS and PAH issues outlined for Outfall 011 apply equally to Outfall 018. With respect to TSS, Region 1 again notes that oil and grease effluent limitations exist in the current NPDES permit for Schiller Station as part of its justification as to why TSS limits should also be required. This time, however, Region 1 states that it has employed its BPJ to determine that the commingled discharge of heater condensate drips that passes through an oil/water separator “is similar to a low volume waste.”<sup>285</sup> Region 1 offers no explanation or reasoning for this BPJ determination which renders it arbitrary and capricious. Perhaps worse, however, the agency does not actually classify the waste stream as a low volume waste. Instead, it only states that it is “similar.” Being similar does not mean the waste stream is a low volume waste and should be subjected to the limitations applicable to that categorical effluent discharge. Region 1’s actions in this regard are arbitrary and capricious and the TSS limits proposed for Outfall 018 should be removed in the final permit.

PAHs monitoring should not be required for Outfall 018 for the reasons articulated in the discussion of Outfall 011. If they are ultimately required, however, PSNH should be allowed to discontinue monitoring for them if data indicates the constituents are not present in effluent discharged through this outfall.

The Nitrogen monitoring requirements proposed for this outfall should be omitted for the same reasons articulated above in the discussion pertaining to Outfall 006.

---

<sup>285</sup> See Fact Sheet at 42.

## **5. Outfalls 020 and 021**

Footnote 2 applicable to these outfalls provides in relevant part that “[a]ll solid materials removed from the screens shall be disposed of via land disposal.”<sup>286</sup> This is not practicable. The removal and return of these solid materials, including leaves, twigs, debris, etc., from the screens to the source waterbody via the fish return trough is automatic after the materials are removed by the spray wash process. It is simply impractical to dedicate personnel at Schiller Station to hand-pick all solid material collected on the screens and dispose of it through some other means and there is no ultimate benefit to the environment in requiring PSNH to do so. At the very least, the condition should be limited to the removal of all solid wastes (e.g., paper and plastic) while an operator is attending to the screenwash and/or “to the extent practicable” or some equivalent language should be added to the end of the above-quoted sentence to permit PSNH the ability to demonstrate why the failure to remove solid material at some point during the permit term was justified under the circumstances.

## **6. Outfall 023**

pH monitoring for an asphalt parking lot drain should only be required quarterly instead of the monthly interval proposed in the Draft Permit. The quarterly interval would be consistent with the requirements applicable to Outfall 018, through which storm water is similarly discharged. A monthly monitoring requirement creates an unnecessary administrative burden on the company and results in the expenditure of needless dollars with no ultimate improvement to the environment.

## **7. Parts I.B. and I.C. of the Draft Permit**

Parts I.B. and I.C. of the Draft Permit should be deleted because Schiller Station already maintains a SWPPP and has obtained coverage under MSGP NHR053208 to manage all

---

<sup>286</sup> Draft Permit at 13.



stormwater discharges related to the facility. Any additions Region 1 therefore wishes to impose at Schiller Station should be implemented by and through that MSGP. The following is a list of notable differences between the requirements of the MSGP and those proposed in the Draft Permit that PSNH has identified:

- Part B.3.: Proposes collection of compliance samples within the first 15 minutes of discharge, which is more stringent than the current 30-minute window provided in the MSGP.
- Part B.6.: Requires enhanced BMPs related to nitrogen when nitrogen is not even listed as a benchmark pollutant for the steam electric power generating point source category. Region 1 has not provided any basis for why it believes discharges from Schiller Station contain significant nitrogen loadings. In fact, they do not. At most, nitrogen could be added to the facility's SWPPP monitoring program to demonstrate nitrogen loading from Schiller Station is immaterial. Were this monitoring information somehow to demonstrate a reasonable potential for the discharges to worsen the impairment, PSNH could then implement best management practices specific to nitrogen.
- Part B.6.a.: Addresses "new development and redevelopment" without defining precisely the meaning of this phrase or what it might encompass.
- Part B.7.a.ii.: Addresses regulation of catchments with "high nitrogen loading" but does not define what precise loading would or should be considered a "high" loading.
- Part B.9: In discussing how to obtain a waiver from the proposed nitrogen regulation requirements, the Draft Permit provides that PSNH must be able to demonstrate that "its discharge does not contain a measurable amount of nitrogen by characterizing its discharge using EPA approved lab methods." This burden of proof would be impossible to satisfy. Even tap water contains a level of nitrogen that is "measurable" utilizing current EPA laboratory methods. If not ultimately deleted, PSNH requests that this provision be revised to establish a reasonable threshold for exclusion from this arduous program. The proposed method of ultimately demonstrating a lack of nitrogen loading is too onerous, as well. Region 1 discusses a two to three year study comprised of up to 30 composite stormwater samples at multiple outfalls as necessary to provide an adequate demonstration. This would be unreasonably time-consuming and costly. Instead, a series of grab samples collected throughout the year during various-sized storm events and from each season would provide a confident, representative qualification of the relative presence/absence of nitrogen within stormwater

discharging from an outfall. Region 1 should revise this provision accordingly if it does not ultimately delete Parts B. and C. from the final permit.<sup>287</sup>

For the reasons stated herein, Parts I.B. and I.C. should be deleted from the final permit.

## **VI. CONCLUSION**

Region 1's Draft Permit must be revised based on the comments set out herein. The agency correctly determined PSNH is entitled to a continuation of its § 316(a) variance for the thermal discharges at Schiller Station. Region 1's § 316(b) BTA determination and BPJ-based BAT limitations for NCMCWs are arbitrary and capricious and require substantial revision prior to issuing the permit as final, however. The June outage requirement for Unit 5 must be removed from the final permit because it is not possible and, even if it were, it does not make economic sense for PSNH and its customers. Modified traveling water screens with an upgraded fish return system constitute BTA for the CWISs at Schiller Station. Entrainment at the facility is *de minimis*, falls far below the average 125 MGD AIF threshold EPA recently established, and is not causing any environmental impact that is adverse to the aquatic ecosystem of the Piscataqua River (a conclusion with which Region 1 agrees). Installation of fine-mesh CWW screens at Schiller Station to address entrainment is therefore unwarranted.

Were Region 1 to improperly reject PSNH's well-founded BTA conclusions, the agency, prior to making its BTA determination, must allow PSNH to submit additional entrainment data and analyses similar to the information facilities with an average withdrawal volume in excess of 125 MGD AIF are required to submit pursuant to the final § 316(b) rule. This additional information would confirm technologies to address entrainment are not needed at Schiller Station. If that somehow is not the case, Region 1 should allow PSNH to test larger slot-width

---

<sup>287</sup> Region 1 does not require what would amount to monthly flow-weighted composite sampling when demonstrating compliance with the sector-specific water quality benchmarks contained within the MSGP. This approach is therefore not appropriate for demonstrating applicability with a non-numeric, chemical-specific BMP.

CWW screens than the 0.8 mm maximum slot-width currently proposed in the Draft Permit. Recent studies compel this authorization and there is no drawback in the agency permitting PSNH to do so. Finally, the proposed timeline for the design, permitting, and construction of the CWW screens at Schiller Station must be revised if the company is ultimately required to install this CWIS technology. The current schedule is unworkable.

The imposition of iron and copper limits to discharges of NCMCWs at Schiller Station is arbitrary and capricious, as well. This waste stream has historically been, and continues to be, treated as a low volume waste exempted from any iron and copper effluent limitations in accordance with the Jordan Memorandum. EPA (with assistance from Region 1) recently confirmed this fact as part of the promulgation of the new NELGs. Region 1 did not even consider the historical permitting record at Schiller Station before establishing BPJ-based BAT limits for the waste stream. This fact alone compels a conclusion that the agency's proposed effluent limitations are arbitrary and capricious and based on an incomplete analysis.

The agency's actual BAT analysis for establishing BPJ-based effluent limitations for NCMCWs at Schiller Station is likewise arbitrary and capricious. Region 1 does not have any data on the makeup of NCMCWs. Thus, it does not and cannot know what, if any, environmental benefit its proposed regulation of NCMCWs will yield. The BAT determination is also insufficient due to the agency's cursory analysis of the costs and implementation issues regulation of NCMCWs in this manner would present at the facility. A thorough evaluation of these and the other factors mandatory to a legally-defensible BAT analysis, along with a review of the historical permitting record, would result in a conclusion that NCMCWs must continue to be classified as a low volume waste and the new final permit must be revised accordingly.

For all of the reasons set out herein, PSNH respectfully urges Region 1 to reconsider what is reasonably necessary for Schiller Station to comply with the CWA, and to amend the Draft Permit accordingly.

# Exhibit 1

**PSNH SCHILLER STATION DRAFT NPDES PERMIT COMMENTS**

**PSNH SCHILLER STATION  
PORTSMOUTH, NEW HAMPSHIRE**



**Prepared for:  
PUBLIC SERVICE COMPANY OF NEW HAMPSHIRE  
D.B.A. EVERSOURCE ENERGY**

**780 North Commercial Street  
Manchester, NH 03101**

**January 2016**

**Prepared by:  
Enercon Services, Inc.  
*and*  
Normandeau Associates, Inc.**



**PROJECT REPORT  
REVISION STATUS SHEET**

NO. PSNH011-REPT-001

REV. 0

PAGE 2 of 43

**PROJECT REPORT REVISION STATUS**

<b><u>REVISION</u></b>	<b><u>DATE</u></b>	<b><u>DESCRIPTION</u></b>
0		Initial Issue

**PAGE REVISION STATUS**

<b><u>PAGE NO.</u></b>	<b><u>REVISION</u></b>	<b><u>PAGE NO.</u></b>	<b><u>REVISION</u></b>
Initial Issue			

**APPENDIX REVISION STATUS**

<b><u>APPENDIX NO.</u></b>	<b><u>PAGE NO.</u></b>	<b><u>REVISION NO.</u></b>	<b><u>APPENDIX NO.</u></b>	<b><u>PAGE NO.</u></b>	<b><u>REVISION NO.</u></b>
Initial Issue					

## Table of Contents

1	Executive Summary.....	6
2	Introduction .....	8
	2.1 Background.....	8
3	Adverse Environmental Impact.....	10
	3.1 Cooling Water Intake Structure (CWIS) Operations.....	10
	3.2 Thermal Discharge Comparison .....	11
	3.3 Proposed New Thermal Limits .....	11
	3.4 Equivalent Adults.....	13
	3.5 EPA Conclusion.....	16
4	Determining BTA for Entrainment at Existing Facilities.....	18
	4.1 EPA’s Proposed BTA Determination for Entrainment Reductions.....	19
	4.2 Actual Intake Flow (AIF).....	21
	4.3 Benefits Valuation Study Requirements .....	25
	4.4 Conclusion .....	29
5	Historic Wedgewire Screen Information.....	30
	5.1 Installation Cost .....	30
	5.2 Scheduling Considerations.....	34
	5.3 Conclusion .....	34
6	Impingement Technology Selection.....	35
	6.1 Compliance Options.....	35
	6.2 Schiller Technology Selection .....	40
7	References .....	42





**PSNH SCHILLER STATION  
DRAFT NPDES PERMIT  
COMMENTS**

NO. PSNH011-REPT-001

REV. 0

PAGE 4 of 43

**List of Appendices**

Appendix 1: Specific Comments	10 pages
Appendix 2: Survey of Existing Cylindrical Wedgewire Screen Installations in Estuarine Environments	12 pages
Appendix 3: Potential Entrainment Reduction for Cylindrical Wedgewire Intake Screens at Schiller Station, Incorporating a Length-Based Wedgewire Avoidance Model	32 pages
Appendix 4: Memorandum Summarizing the Differences Between the Wedgewire Screen Designs from the 2008 Report and 2014 Report	7 Pages

### List of Figures

Figure 3-1: Example illustrating the decline in abundance of Winter Flounder life stages from spawning to adulthood based on published life history parameters. ....	15
Figure 4-1: Plot of cumulative AIF in MGD (Ref. 7.6).....	23
Figure 4-2: Electric generators with multiple CWISs (Ref. 7.6) .....	24
Figure 4-3: Existing facilities and flow addressed by various flow thresholds (Ref. 7.6).....	25

## 1 Executive Summary

ENERCON and Normandeau have reviewed the draft National Pollutant Discharge Elimination System (NPDES) permit and corresponding draft fact sheet for Public Service of New Hampshire's (PSNH's) Schiller Station (the "Station"), and this report identifies and corrects conditions in the draft NPDES permit and/or draft fact sheet that appear to be based on mistaken facts or misinterpretation of information provided by the Station to the United States Environmental Protection Agency (EPA) in the previous Clean Water Act §308 Responses. Sections 3 through 6 of this report discuss fundamental concerns with the existing draft NPDES permit and draft fact sheet, while the Appendices provide additional detailed information.

Based on the comments provided in this report, an entrainment technology at the Station is not warranted for the following reasons.

- The EPA has not established that the water withdrawal of the Station's CWIS under actual intake flow (AIF) or design intake flow (DIF) is sufficient to cause adverse environmental impact (AEI) to the fish and shellfish of the Piscataqua River and Great Bay source water body. Specifically, the EPA:
  - Does not appear to have considered how trivial the Station's withdrawal of cooling water is compared to the source water body at DIF (0.0032 percent) or AIF (0.0018 percent) as discussed in Section 3.1.
  - Routinely states in the draft fact sheet that existing data does not support the conclusion that there is an impact to local populations of aquatic organisms in the Piscataqua River as discussed in Section 3.5.
  - Confounds comparisons of entrainment reduction technologies by differentially relying on absolute entrainment abundance numbers or their equivalent adult losses at either DIF or AIF.
- The Station's DIF of 125.8 million gallons per day (MGD) does not constitute a large use of water as compared to the average DIF of 555 MGD for electric generators surveyed by EPA throughout the nation as discussed in Section 4.2.
- The Station's AIF of 72.4 MGD is essentially negligible in relation to all facilities in the United States with cooling water intake structures (CWISs). Therefore, the EPA's decision to impose entrainment controls on the Station is inconsistent with the justification given for use of the 125 MGD AIF threshold in the EPA's own Technical Development Document as discussed in Section 4.2.

- EPA has made the best technology available (BTA) determination without using all of the required information. Since the Rule does not require facilities with AIFs less than or equal to 125 MGD to submit any of the information specified in §122.21 (r)(9), (10), or (11) discussed later in this report, no updated entrainment-related information that could be used by the Director to determine BTA was provided to the EPA at the time that the 2014 Report (Ref. 7.3) was submitted. If EPA wishes to impose entrainment controls on the Station, at minimum the BTA determination shall use all of the supporting information as required by the rule, including a cost-benefit analysis.
- The limited set of information that EPA used in its evaluation of a site-specific BTA for entrainment is outdated and did not reflect the level of detail required by the Section 316(b) Rule. This is discussed further in Section 5.

Because the Station should not be required to install an entrainment technology under the Rule, the Station should focus solely on the selection of one of the seven pre-approved options to comply with the impingement mortality standard as permitted by the Rule. There is an abundance of experience associated with the operation, maintenance, and installation of modified traveling water screens and fish handling and return systems (FHRs). Since modified traveling screens are a proven technology, there is no pilot study required. This would allow the Station to be in compliance with the BTA standard for impingement mortality more quickly. Therefore, the modified traveling screens option (Option #5, see Section 6.1 for an explanation of the Options) is believed to offer the most practical and timely approach to impingement compliance for the Station.

## 2 Introduction

Public Service of New Hampshire's (PSNH's) Schiller Station (the "Station") in Portsmouth, New Hampshire, received a draft NPDES permit (Permit NH0001473) from the EPA on September 30, 2015. When final, this draft NPDES permit will supersede the permit for the Station issued on September 11, 1990. This draft NPDES permit and accompanying draft fact sheet were based in part on information supplied by the Station at the request of the EPA. The purpose of this report is to identify and correct conditions in the draft NPDES permit and/or draft fact sheet that appear to be based on mistaken facts or misinterpretation of some of the information provided by PSNH to the EPA.

### 2.1 Background

On October 31, 2007, the EPA issued an information request letter to PSNH under Section 308 of the CWA (2007 §308 Letter) regarding the Station's compliance with CWA §316(b) ("the Rule"), 33 U.S.C. §1326(b). In this 2007 §308 Letter, the EPA requested certain technology and operational information from PSNH to support the EPA's development of the new NPDES permit for the Station. In October 2008, PSNH submitted a response (2008 Response; Ref. 7.1) to this 2007 §308 Letter, prepared jointly by Enercon Services, Inc. (ENERCON) and Normandeau Associates, Inc. (Normandeau). The 2008 Response evaluated the engineering feasibility of certain CWIS technologies and operational measures, as specified by EPA, that generally would be expected to reduce impingement<sup>1</sup> and/or entrainment<sup>2</sup> abundance and mortality at the Station. Impingement and entrainment abundance and mortality studies were performed by Normandeau at the Station from September 2006 through September 2007 at the request of the EPA in a December 30, 2004 §308 Letter. These studies were performed according to standard operating procedures and a quality control/quality assurance plan reviewed and approved by the EPA prior to the onset of sampling. The results of these studies were provided to the EPA in a biological report dated April 2008 (2008 Biological Report; Ref. 7.8). The impingement and entrainment data presented in the 2008 Biological Report were used to prepare Attachment 6 of the 2008 Response.

Subsequent to the 2008 Response, the EPA issued follow-up §308 information requests in further support of their NPDES permit development for the Station, and PSNH responded as requested. PSNH submitted a response to one of the follow-up information requests by EPA

---

<sup>1</sup> Any life stage of fish or shellfish being entrapped on the outer part of an intake structure or against a screening device during periods of intake water withdrawal.

<sup>2</sup> Any life stage of fish or shellfish in the intake water flow entering and passing through the CWISs of a size that would be retained on a sieve with a maximum opening dimension of 0.56 inches

in August 2013 (2013 Response; Ref. 7.2) that was prepared by ENERCON. Given the regulatory and technological changes in the time since the 2008 Response was issued, and given the operational changes at the Station, ENERCON and Normandeau jointly prepared a supplement to the original 2008 Response in October 2014 (2014 Report; Ref. 7.3) for consideration by the EPA when issuing the draft NPDES permit and draft fact sheet. This document provided an updated wedgewire screen design, including evaluation of wide-slot wedgewire screens and other impingement-reducing technologies. Because the actual intake flow rate (AIF) at the Station was less than 125 MGD, the 2014 Response provided updated information solely related to the evaluation of impingement-reducing technologies in accordance with the provisions of the Rule issued in final form by the EPA on August 15, 2014 and effective on October 14, 2014.

Following receipt of the 2014 Report, the EPA issued the draft NPDES permit and accompanying draft fact sheet to the Station on September 30, 2015. The draft NPDES permit and draft fact sheet originally had a public comment period ending November 28, 2015, but this comment period was extended to January 27, 2015 after PSNH was granted a 60-day extension by the EPA.

ENERCON and Normandeau have reviewed the draft NPDES permit and corresponding draft fact sheet, and this report identifies and corrects conditions in the draft NPDES permit and/or draft fact sheet that appear to be based on mistaken facts or misinterpretation of some of the information provided by PSNH to the EPA in the various §308 Responses described above. Sections 3 through 6 of this report discuss fundamental concerns with the existing draft NPDES permit and draft fact sheet. Appendix 1 provides specific, or line-by-line identification of issues found within the permit and/or fact sheet. Appendix 2 and 3 provide detailed operational and biological performance information, respectively, on cylindrical wedgewire screens (CWWS). And finally, Appendix 4 provides a detailed comparison between the 2008 and 2014 CWWS designs and cost estimates.

### 3 Adverse Environmental Impact

#### 3.1 Cooling Water Intake Structure (CWIS) Operations

The EPA has not established that the water withdrawal of the Station's CWIS under either the AIF or design intake flow (DIF) is a cause of adverse environmental impact (AEI) to the fish and shellfish of the Piscataqua River and Great Bay source water body. The portion of source water body flow withdrawn into the Station's three operating units (Units 4, 5 and 6) combined at maximum DIF is *de minimis*, even under a worst-case assumption of a 1:1 withdrawal ratio for life stages of fish and shellfish exposed to entrainment and impingement at the CWISs.

As described in the 2008 Response (Ref. 7.1), in the vicinity of Schiller Station (within a 0.5 mile radius), the center river channel depths range from 42 feet to 75 feet below mean low water (MLW) with a median depth (as defined by area) of 18 feet. The lower Piscataqua River has maximum sweeping flow velocities of approximately 4.9 feet per second (fps) during ebb tide and 4.4 fps during flood tide. The peak tidal flow is approximately 117,000 cubic feet per second (cfs) and the average freshwater discharge rate is approximately 1570 cfs (Ref. 7.9). The tidal currents in the vicinity of the Station have an average 12.42 hour tidal cycle (period) of ebb and flow (Ref. 7.9).

For one tidal cycle, the intake volume based on the maximum DIF of 194 cfs (87,290 gpm, Units 4, 5, and 6 combined) is calculated to be approximately 8,700,000 ft<sup>3</sup>. The tidal excursion is estimated to be approximately 196,000 feet centered on the Station, when calculated based on the maximum flow velocity of 4.4 fps and a 12.42 hour tidal period. Therefore, the volume of Piscataqua River source water passing by the Station's CWISs during one tidal cycle and exposed to withdrawal is 272,000,000,000 ft<sup>3</sup>. The Station's intake volume based on design flow for all three units comprises just three one-thousandths of a percent (0.0032 percent) of the volume of source water exposed to withdrawal during one tidal excursion, and there are nearly two tidal excursions per day (Ref. 7.1).

As described in the 2014 Report (Ref. 7.3), and updated in Section 4.2 of this report, the AIF for the Station from the three most recent years of available intake flow data (27 August 2012 through 26 August 2015, Units 4, 5, and 6 combined) is 112 cfs (50,300 gpm). Therefore, AIF is 1.7 times lower than the DIF, and proportionately would reduce the already *de minimis* withdrawal by the Station's CWIS to just 0.0018 percent of the peak Piscataqua River withdrawal zone flow during each tidal cycle. The EPA should consider how trivial the Station's withdrawal of cooling water is compared to the source water body, either conservatively at DIF, or realistically at AIF. Given these percentages, the Station's CWISs could not cause an AEI with respect to entrainment of the exposed life stages of fish and

shellfish found in the Piscataqua River and Great Bay source water body. Moreover, given the insignificant percentage of water withdrawn by the Station from the lower Piscataqua River, there is no justification for completing a detailed evaluation of entrainment technologies, let alone implementation of such a technology.

### 3.2 Thermal Discharge Comparison

In the draft permit fact sheet, the EPA provides the following basis for their conclusion that the thermal plume is unlikely to have caused appreciable harm to the balanced indigenous populations (BIP) of fish and shellfish in the past and is unlikely to do so in the future under the current discharge limits as required by the Rule.

*[T]he modest size of the mixing zone and thermal plume as a whole compared with the unaffected area of the Piscataqua River is a factor. For many fish species, avoidance temperatures are triggered well before the fish is exposed to potentially lethal temperature values. Because the Piscataqua River in the area of the station retains a large portion of the river that is unaffected by the thermal plume, adult and juvenile fish species have the opportunity to easily avoid the elevated water temperature long before potential lethality is a consideration, if at all. This avoidance behavior is not judged to adversely affect the fish species. (Pg. 65; draft fact sheet)*

ENERCON and Normandeau agree with the EPA’s evaluation and conclusion regarding the §316(a) thermal discharge as quoted above. The same massive amount of water continually flowing by the Station’s CWISs that prevents AEI also provides sufficient dilution of the Station’s thermal discharge into the Piscataqua River source water body to avoid appreciable harm to the BIP. In addition, the reduction in AIF by a factor of 1.7 compared to the Station’s DIF further demonstrates that reductions in harm to the BIP have been achieved by the Station’s operations in recent years. The logic presented by the EPA in the quote above from the draft fact sheet is corroborated by the withdrawal calculations presented in Section 3.1 and, therefore, is equally supportive of a finding of no harm to the BIP at the Station.

### 3.3 Proposed New Thermal Limits

The Station requested that the EPA consider an increase from 95°F to 100°F in the allowable maximum temperature for their non-contact cooling water discharged from the combined outfalls 002 (Unit 4), 003 (Unit 5), and 006 (Unit 6) in a renewed NPDES permit. In the draft NPDES renewal permit and draft fact sheet, the EPA denied this request, primarily because “PSNH has not made an adequate demonstration, or really any demonstration at all, that the protection and propagation of the BIP will be assured with discharges at that level” (Pg. 69; draft fact sheet). Although the EPA readily admitted that under the current permit



“Schiller Station’s thermal discharge plume is relatively modest in scope, even under worst case summer conditions,” (Pg. 63; draft fact sheet) it also concluded that, “raising the discharge temperature would increase the amount of heat discharged to the river and would change the scope of the thermal discharge plume to some unknown extent” (Pg. 69; draft fact sheet). Accordingly, the expected impact to the discharge plume temperature and dimensions that would result from an increased maximum discharge temperature is required for the EPA to consider modifying the NPDES permit to accommodate the requested increase.

The Station also requested increasing the allowable temperature rise between the intake and discharge (Delta-T) from the present 25°F to 30°F at all times, instead of the present discharge limitation that was continued in the draft permit and fact sheet within which a 30°F Delta-T is only allowed for a two-hour period during condenser maintenance for the combined outfalls 002 (Unit 4), 003 (Unit 5), and 006 (Unit 6). Therefore, it is desired by the Station to have a new permit condition added to a revised draft NPDES permit that allows an evaluation of these two newly proposed thermal discharge limitations for the EPA’s consideration. If the results of the proposed evaluation reveals that one or both of these discharge limitations provide a *de minimis* increase in the expected temperatures at the current boundaries of the existing “mixing” zone for the combined outfalls 002, 003, and 004, which is presently stated in the draft NPDES permit as 200 feet in any direction from the point of discharge where the receiving waters must not exceed 84°F, then the Station should be allowed the operational flexibility afforded by the new thermal limitations in a revised draft NPDES permit.

In cases where new discharge limits are proposed, or where no actual plume monitoring data are available for existing discharge limits and the facility is not conditionally permitted to operate under such limits to allow for collection of such data, the standard method acceptable for “quantifying” a discharge plume as conforming to mixing zone limits is by mathematical modeling, often using the EPA-supported Cornell Mixing Zone Model (CORMIX). Where the existing plume has been defined by actual monitoring, as is the case for the Station (via the August 31, 2010 study and data submitted to EPA in response to a May 4, 2010 §308 Letter), a better and more reliable method of plume definition is by “mass-balance” modeling using the actual monitoring and discharge data obtained during “critical” conditions (i.e., summer, neap tide). With this mass-balance method, the mixing and dilution characteristics in the form of dilution factors are determined for the existing discharge under pre-defined critical conditions. Then, the discharge characteristics (e.g., flow, temperature, chemistry) for the proposed discharge conditions are input into the model, and the resulting change in temperature/pollutant concentrations at the previous monitored locations are calculated using a mass-balance approach.

Determining that the proposed new thermal plume limits for the Station conform to the existing mixing zone criteria will require three tasks. First, the expected changes in discharge plume temperatures and dimensions must be predicted. Second, a demonstration of protection of the BIP under the proposed conditions will have to be made based on the predicted changes in plume temperatures. Lastly, the calculations must show that the increase pollutant load (in this case heat) complies with New Hampshire (NH) antidegradation rules, which for most pollutants would require calculations showing that the increased pollutant (heat) loading would not constitute more than 20 percent of the remaining assimilative capacity for that pollutant. However, since NH has no numerical criteria for temperature (heat), the state Water Quality Standards provide that “where a potential water quality impairment is associated with a thermal discharge, the antidegradation provisions shall ensure that the requirements of section §316(a) of the CWA are met” (Ref. 7.28). Demonstration of the *de minimis* nature of the proposed new temperature limits with respect to the existing mixing zone for the Station is expected to demonstrate protection of the BIP, and therefore comply with NH’s antidegradation rules.

### 3.4 Equivalent Adults

The EPA’s draft fact sheet inconsistently relies on either absolute numbers of fish and macrocrustacean eggs and larvae, or their equivalent adult numbers when comparing the magnitude of entrainment and the performance of various technologies or operational measures to reduce entrainment at the Station. Examples of these inconsistencies are presented in detail on a line-by-line basis in Appendix 1 of this report, and described in general in the text below. Comparing numbers or counts of different life stages of fish or macrocrustaceans entrained is not technically or biologically correct and contradicts the EPA’s own use of age equivalents for cost, benefit, and technology evaluations. EPA should make all inferences about the magnitude of entrainment impacts and comparisons among entrainment reduction technologies, if needed, using equivalent adult numbers or production forgone biomass.

High early life stage mortality of many aquatic species of a size susceptible to entrainment does not necessarily equate to an AEI on these species. This is particularly true for the fish and macrocrustaceans exposed to entrainment at the Station, because 1) such a small fraction of the Piscataqua River source water body is withdrawn (see Section 3.1 above) and 2) these species typically exhibit either “periodic” or “opportunistic” life history traits (Ref. 7.22). From an ecological perspective, periodic species are characterized by high fecundity (i.e., they spawn a large number of eggs), relatively large size, and long life spans during which females may spawn many times. Winter Flounder is an example of a periodic species entrained at the Station (Ref. 7.23). Opportunistic species entrained at the Station are

characterized by small body size, short life spans, and the ability to disperse offspring widely throughout the environment (Ref. 7.22). Green Crab is an example of an opportunistic species entrained at the Station (Ref. 7.29). Periodic and opportunistic traits are advantageous to fish or macrocrustacean species that live in unstable or unpredictable environments, such as the north temperate waters of the Gulf of Maine and the Piscataqua River / Great Bay estuary, which experience significant seasonal and between-year variation in environmental conditions (e.g., temperature, storm events, etc.) (Ref. 7.25). It is also likely that the opportunistic life history of Green Crabs enabled them to successfully establish abundant populations in Gulf of Maine waters and in the Piscataqua River as an invasive species. The reproductive strategies of these organisms living in these unstable environmental conditions, including the very large numbers of eggs produced, ensure that sufficient offspring will survive to sustain the populations from year-to-year, even in unpredictable environments.

Entrainment losses expressed as the number of each species and life stage consist mainly of losses of early life stages, particularly of eggs and larvae of fish and macrocrustaceans (Ref. 7.8). However, as illustrated by the example for Winter Flounder provided in Figure 2-1 and described below, only a small fraction of the entrained eggs and larvae would survive to adulthood, even if the Station's CWISs did not operate.

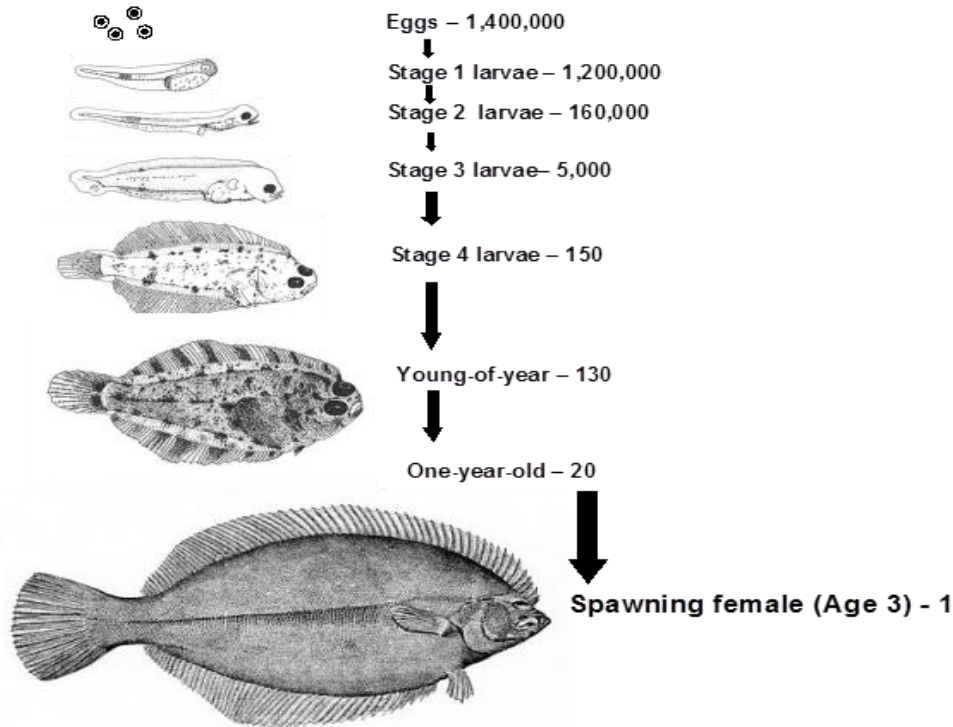

Figure 3-1: Example illustrating the decline in abundance of Winter Flounder life stages from spawning to adulthood based on published life history parameters<sup>3</sup>.

Figure 3-1 illustrates a classic survivorship curve for Winter Flounder, and this relationship has a similar shaped curve (with different slopes) for other fish and macrocrustacean species in the Piscataqua River source water body. In this example for Winter Flounder (Figure 3-1), early life stage survival estimates developed by Saila et al. (Ref. 7.23) for Seabrook Station in nearby coastal NH reveal that nearly 99 percent of Winter Flounder eggs die from natural causes within 60 days following spawning. Only about 20 out of every 1.4 million Winter Flounder eggs are likely to survive to become one-year-old fish (Figure 2-1, Ref. 7.26, and Ref. 7.27). Similarly, just one (1) out of every 1.4 million eggs is likely to survive to reach three years of age, the median age at which female Winter Flounder first become sexually mature in the Gulf of Maine and in the Piscataqua River (Ref. 7.24). The exponential decrease in numbers of fish due to natural mortality is why the 2008 Biological Report (Ref. 7.8) and Attachment 6 of the 2008 Response (Ref. 7.1) provided estimates of the life stages of both fish and macrocrustaceans entrained at the Station as both absolute numbers and their equivalent adults. As illustrated in the Winter Flounder example above, about 1.4 million eggs entrained are the equivalent of one three-year-old adult first available in the source

<sup>3</sup> Out of every 1,400,000 eggs spawned, on average, only one will survive to become an adult (Age 3) female Winter Flounder. All but 20 Winter Flounder will die from natural causes before they reach Age 1.

water body to spawn. Because of these survivorship curves, nearly all of the eggs and larvae entrained at the Station's CWISs would have died due to "natural" causes if the Station was not operating, and their numbers represent such a minor contribution of production from fecund females. Therefore, counts of total numbers entrained reveal nothing meaningful about the potential adverse impact of the Station's CWISs on the relevant adult populations. The EPA has confused the discussions of entrainment impacts by inconsistently referring to either absolute numbers or equivalent adults when evaluating both adverse impacts of the Station's CWISs and the effectiveness of technologies to reduce entrainment.

As discussed in the 2008 Biological Report, fecundities of other abundant fish and macrocrustacean taxa entrained at the Station's CWISs are also high, and early life stages of these taxa also experience high levels of natural mortality. The correct and biologically equitable way for the EPA to compare the benefits of different technologies or operational measures that act selectively on the different life stages of fish and macrocrustaceans entrained at the Station (such as screening technologies) is by making these comparisons using the equivalent adult values provided in a revised fact sheet.

### 3.5 EPA Conclusion

Throughout the draft fact sheet, the EPA notes in several paragraphs that the Station's CWIS does not exhibit an AEI to local populations of fish and shellfish or disrupt the local estuarine community of the Piscataqua River. Although EPA's conclusion is correct, they made this determination without acknowledging the miniscule fraction amount of the total volume of the Piscataqua River withdrawn by the Station during each tidal cycle (0.0032 percent at DIF or 0.0018 percent at AIF). The paragraphs quoted from the draft fact sheet below should be clarified based on the information provided in Sections 3.1 and 3.2 above to consistently support a finding of no AEI to local populations of fish and shellfish of the Piscataqua River and great Bay estuarine system in a revised fact sheet.

*Schiller Station entrains and impinges large numbers of fish and macrocrustacean eggs, larvae, juveniles and adults. EPA considers these entrainment and impingement losses from the current operation to be adverse environmental impacts. Under CWA § 316(b), the design, construction, location and capacity of the Facility's CWISs must reflect the BTA for minimizing these adverse environmental impacts. At the same time, the available information is insufficient to draw conclusions that these losses have caused either a particular reduction in the Great Bay estuary's populations of the affected species or an imbalance in the overall assemblage of aquatic organisms in the estuary. (Pg. 97; draft fact sheet)*

*EPA reaches this conclusion in light of the moderate size of Schiller Station's water withdrawal and its relatively small withdrawal relative to the flow in the Piscataqua River. In addition, EPA's judgment is influenced by the fact that while the Facility's entrainment of eggs and larvae is significant, it has not been associated with higher level impacts, such as major effects on local populations of impacted species or the overall community of organisms in the river, or with impacts to endangered species. In addition, Schiller Station's Units 4 and 6 have been operating at a relatively low capacity factors in recent years and this trend is currently expected to continue (although such trends can change over time). (Pg. 157; draft fact sheet)*

*At the same time, it should also be understood that, as mentioned above, EPA has no evidence that entrainment and/or impingement losses at Schiller Station are causing or significantly contributing to declines in local populations of the affected species of aquatic organisms or to disruptions in the local community or assemblage of organisms in the Piscataqua River. This is not surprising given that Schiller Station's withdrawal of 125 MGD is only 0.5% of the tidal prism of the Piscataqua River Estuary (approximately 25,000 MGD). (Pg. 158; draft fact sheet)*

The EPA is clear that impingement mortality should be reduced at the Station based on the seven prescriptive choices for BTA to reduce AEI specified by the Rule as issued in final form by the EPA on August 15, 2014 and effective on October 14, 2014. However, the EPA also routinely states in the draft fact sheet that existing data does not support the conclusion that there is an impact to local populations of aquatic organisms in the Piscataqua River. Without such evidence, there is no basis for the EPA to require additional CWIS technologies or operational measures for entrainment reductions at the Station. Requiring entrainment controls in the absence of demonstrated AEI is contrary to the CWA and the 316(b) Rule.

## 4 Determining BTA for Entrainment at Existing Facilities

As was discussed in the 2014 Report (Ref. 7.3), and as updated in Section 4.2 of this report, Schiller Station has an AIF that is significantly less than 125 MGD. According to the Rule, the Station is not required to submit entrainment-related information to EPA unless specifically directed to do so. Presumably, this exercise would occur when a facility withdraws slightly less than 125 MGD, but causes significant adverse environmental impact due to a high entrainment abundance. Because of the Rule requirements, the Station's 2014 Response was primarily focused on impingement-reducing technologies, and the available information about entrainment at the Station is primarily limited to the 2008 Response and 2008 Biological Report. The draft permit requirement to install an entrainment-reducing technology is not warranted under the Rule unless it can be shown that the Station causes significant AEI due to a high entrainment losses of equivalent adults. As discussed in Section 3 (above), this is not the case for the Station.

Therefore, EPA's decision to impose entrainment controls on the Station appears arbitrary and not based on the available information. In addition to requiring implementation of an entrainment-reducing technology, EPA did not follow the correct process for evaluating and imposing entrainment controls on an existing facility. Determination of entrainment-related BTA for an existing facility (such as the Station) requires the Director to consider relevant information submitted by the owner or operator of the facility. Much of this information has not been provided by PSNH to EPA because, at the time of the 2014 Report (Ref. 7.3), it was not apparent from the requirements of the Rule that submittal of information related to entrainment was required. This information submittal process is outlined below.

Subsection 125.94(d) of the 316(b) Rule, "BTA standards for entrainment for existing facilities," states "the Director must establish BTA standards for entrainment for each intake on a site-specific basis. These standards must reflect the Director's determination of the maximum reduction in entrainment warranted after consideration of the relevant factors as specified in §125.98."

"Site-specific entrainment requirements," §125.98(f), states "the Director must establish site-specific requirements for entrainment after reviewing the information submitted under 40 CFR 122.21(r) and §125.95," while §125.98(2)(v), further states that "quantified and qualitative social benefits and costs of available entrainment technologies when such information on both benefits and costs is of sufficient rigor to make a decision," should also be considered in the determination of BTA.

"Application requirements for facilities with cooling water intake structures," §122.21 (r), Part 1(ii), "Existing facilities," is further broken down into Subparts A through H, but only Subparts A, B, and C are relevant to this discussion. Subsection 122.21 (r)(ii)(A) "All existing

facilities,” states “the owner or operator of an existing facility defined at 40 CFR 125.92(k) must submit to the Director for review the information required under paragraphs (r)(2) and (3) of this section and applicable provisions of paragraphs (r)(4), (5), (6), (7), and (8) of this section,” where (r)(7) documents any previous entrainment performance studies conducted at the facility or obtained from other facilities, as discussed in the 2014 Report (Ref. 7.3). Next, Subsection 122.21 (r)(ii)(B), “Existing facilities greater than 125 MGD AIF,” states “in addition, the owner or operator of an existing facility that withdraws greater than 125 MGD AIF, as defined at 40 CFR 125.92 (a), of water for cooling purposes must also submit to the Director for review the information required under paragraphs (r)(9), (10), (11), (12), and (13) of this section,” where (r)(9), (10), and (11) use entrainment characterization data collected at the facility to assess technical feasibility, cost, and benefits of candidate entrainment technologies.

Finally, §122.21 (r)(ii)(C), “Additional information,” states “the owner or operator of an existing facility must also submit such additional information as the Director determines is necessary pursuant to 40 CFR 125.98(i).” Subsection 125.98(i) requires “numbers and types of organisms entrained, including, specifically, the numbers and species (or lowest taxonomic classification possible) of Federally-listed, threatened and endangered species, and designated critical habitat (e.g., prey base).”

Based on the Rule requirements and the Station’s AIF of less than 125 MGD, this information was not provided to EPA for their use in determining whether entrainment controls are warranted, and if so, which is the most appropriate. Regardless of this, however, the draft permit contains a BTA determination by EPA and requires installation of rigorous entrainment controls. In addition to not using quantified and qualitative social benefits and costs of available entrainment technologies to make a determination of BTA, EPA has utilized information that is not relevant to today’s understanding of CWWS effectiveness and operation. Therefore, EPA’s BTA determination is both *uninformed* (based on inadequate information) and *misinformed* (based on outdated information).

#### **4.1 EPA’s Proposed BTA Determination for Entrainment Reductions**

Cylindrical wedgewire screens with a slot size no greater than 0.8 mm were specified by the EPA in the fact sheet to represent BTA for minimizing entrainment impacts at the Station. In addition to not considering quantified social benefits, this determination is based on dated information contained in the 2008 Response (Ref. 7.1), which analyzed entrainment mortality reductions due to the function of CWWSs as physical exclusion (i.e., screening) devices alone. Subsequent research has been conducted since 2008 that demonstrates the effectiveness of CWWSs as a function of other important entrainment reduction mechanisms including hydraulic bypass and larval avoidance swimming behavior that may account for



much of the reduction performance of CWWSs if they are properly aligned when installed in a high-current area like the Piscataqua River near the Station's CWIS. At the time of the 2008 Response (Ref. 7.1), these phenomena were observed in the scientific literature, but testing had not yet been performed to allow a more thorough and quantitative estimate of CWWS effectiveness. Therefore, the CWWS effectiveness numbers presented in the 2008 Response (Ref. 7.1) reflect the conservative underestimate of effectiveness based on exclusion alone. This has the effect of significantly underestimating the effectiveness of larger slot width CWWSs.

Reference 7.4 states that CWWS effectiveness is a function of a combination of at least three major factors, only one of which is the slot size.

*Previous studies have shown that the following conditions are important for preventing or reducing entrainment and impingement associated with wedgewire screens: (1) a sufficiently small slot size to physically block passage of the smallest life stages to be protected; (2) low through-slot velocity (i.e., the water velocity between the wedgewire slots) to minimize the hydraulic zone of influence in which passive or weak swimming organisms can become entrained; and (3) an adequate ambient velocity (i.e., "sweeping" velocity) passing across a screen to carry organisms and debris along and away from the screen. When all of these factors exist, it is expected that the biological effectiveness of wedgewire screens will be high. However, large reductions in entrainment and impingement may occur when sub-sets of these conditions exist. For example, low through-slot velocities and high approach velocities may reduce entrainment and impingement to acceptable levels, even when aquatic organisms are physically capable of passing through slots. (Pg. 1-1; Ref. 7.4)*

The CWWS effectiveness numbers presented to EPA in the 2008 Response (Ref. 7.1) only accounted for physical exclusion, or Item (1) in the quotation above. The latter two parameters were not accounted for quantitatively as this information was not available at the time. Additionally, as discussed in Appendix 3, active avoidance by larvae has been shown to reduce entrainment in wedgewire screen laboratory studies.

The alignment of the slot openings relative to sweeping flow direction and the ratio of ambient (or sweeping) velocity to through-slot velocity both contribute significantly to what is known as hydraulic bypass, where the inertia of the sweeping flow simply carries the entrainable organisms past the screen. Hydraulic bypass is most effective when there are high sweeping current velocities relative to the through-slot velocity. This is especially the case at the Station, as this portion of the Piscataqua River is one of the fastest flowing commercial port waterways in the northeastern United States (Ref. 7.5). Given this special characteristic of the source waterbody, CWWS effectiveness in this location may be less of a function of slot

size than in a typical installation. However, this is not captured in the effectiveness numbers submitted in the 2008 Response.

EPA's requirement for CWWS installation at the Station as BTA for entrainment reduction is misinformed based on outdated effectiveness data. EPA should consider updated operational and biological performance characteristics of CWWSs as provided in Appendix 2 and Appendix 3, respectively. In addition, because the slot size may contribute less to overall effectiveness as compared to a typical installation, EPA should consider a range between fine-mesh and coarse-mesh screens that will maximize the reliability of the screens. CWWSs with smaller slot sizes would have a higher likelihood of fouling, clogging, and icing. During such an event, the screens would be bypassed, and the CWIS would withdraw water in a manner similar to current operation. Therefore, a higher "true" effectiveness may be realized if a larger slot size is selected that would not result in clogging, and subsequent bypass.

#### **4.2 Actual Intake Flow (AIF)**

AIF is defined by §125.92 of the Rule as, "the average volume of water withdrawn on an annual basis by CWISs over the past three years. After October 14, 2019, actual intake flow means the average volume of water withdrawn on an annual basis by the CWISs over the previous five years..."

The AIF is a function of the CWIS capacity, as well as operational measures and frequency of operation. The three-year AIF (i.e., 2011-2013) presented in the 2014 Report (Ref. 7.3) was approximately 74 MGD. Since the Rule does not require facilities with AIFs less than or equal 125 MGD to submit any of the information specified in §122.21 (r)(9), (10), or (11) discussed above, no updated entrainment-related information that could be used by the Director to determine BTA was submitted, and the available information about entrainment at the Station is primarily limited to the 2008 Response and 2008 Biological Report. The Station, instead, provided updated information related to impingement compliance as required by the Rule. Given that the AIF provided in the 2014 Report (Ref. 7.3) is now outdated, an updated AIF is calculated here.

The Station's AIF from August 27, 2012, through August 26, 2015, was calculated to be approximately 72.4 MGD. This is well below the 125 MGD threshold required by the Rule, as well as the AIF reported in the 2014 Report (Ref. 7.3). In addition, this places the Station at the low end of the spectrum of power generation facilities. The EPA's own Technical Development Document for the Rule states the following with regard to the 125 MGD AIF threshold for entrainment technology evaluation (Ref. 7.6).

*Adverse environmental impacts from entrainment result from actual water withdrawals, and not the maximum designed level of withdrawal. Further, using*

*actual flow might encourage some facilities to adopt operational practices to reduce their flows to avoid collecting supplemental data and submitting the additional entrainment characterization study. Furthermore, any facility that has DIF greater than 2 mgd is required to submit basic information that will allow the Director to verify its determination of whether it meets the 125-mgd AIF threshold.*

*EPA has selected a threshold of 125-mgd AIF for submission of the Entrainment Characterization Study (as well as studies described at 40 CFR 122.21(r)((7) and (10)-(13)) because this threshold will capture 90 percent of the actual flows but will apply only to 30 percent of existing facilities. EPA concluded that this threshold struck the appropriate balance between the goal of capturing the greatest portion of intake flow while minimizing the study requirements for smaller facilities. Exhibit 3-3 presents a plot of cumulative AIF for facilities with AIF sorted from low to high with a marker illustrating the location of the largest facility that would fall below a threshold of 125 mgd. While there is no obvious break point or change in slope at this particular data point, it is a reasonable approximation of where the curve begins to flatten out. The selected threshold would significantly limit facility burden at more than two-thirds of the potentially in-scope facilities while focusing the Director on major cooling water withdrawals. (Pg. 3-8; Ref. 7.6)*

The figure of interest (Figure 4-1) is provided below. This figure shows that the vast majority of water used by existing facilities in the United States is withdrawn by the biggest users. The horizontal axis shows a listing in facilities in increasing order, and the cumulative AIF (total water withdrawn by all facilities up to that point) is displayed on the vertical axis.

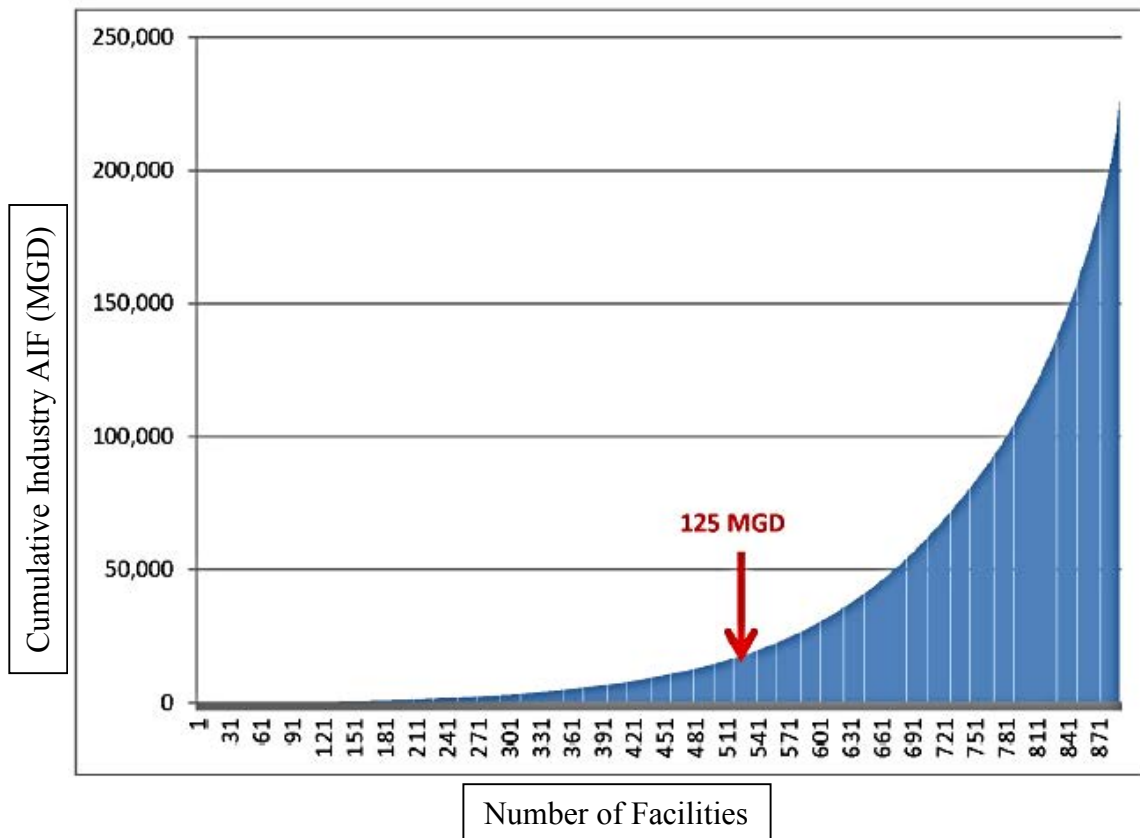

Figure 4-1: Plot of cumulative AIF in MGD (Ref. 7.6)

Therefore, EPA appears to have concluded that the 125 MGD AIF threshold for submittal of entrainment-related information was a policy decision to achieve the greatest nationwide entrainment reduction at the lowest cost to the industry. By this logic, EPA focuses on the largest users of water and limits the burden on smaller facilities.

In Exhibit 4-5 of Reference 7.6, EPA states that the average DIF for electric generators is 555 MGD. The DIF for the Station is 125.8 MGD as stated in the 2014 Report (Ref. 7.3), which is only 23 percent of the nationwide average DIF for once-through cooling water intakes. Therefore, given this information, the Station does not constitute a large user of water and should not be subject to the burden of entrainment controls.

Because Schiller Station has two screen houses, it falls under the category of facilities containing multiple CWISs. Exhibit 4-15 of Reference 7.6 contains a survey of electric generating facilities with multiple CWISs and the resulting distribution of DIFs as a function of cooling system design.

<b>CWS type</b>	<b>Flow range</b>	<b>Number of facilities</b>
Once-through only	< 50 mgd	7
Once-through only	50-250 mgd	35
Once-through only	> 250 mgd	150
Closed-cycle + once-through	< 50 mgd	0
Closed-cycle + once-through	50-250 mgd	2
Closed-cycle + once-through	> 250 mgd	5

*Source: Survey Data from Detailed and Short Technical Industry Questionnaire: (DCN 4-0016F-CBI).*

Figure 4-2: Electric generators with multiple CWISs (Ref. 7.6)

As shown from Figure 4-2 above, the Station falls into the category of 35 facilities with a once-through cooling system and a DIF between 50 – 250 MGD. Given that there are 150 facilities out of a total of 199 facilities with DIFs greater than 250 MGD, Schiller Station is a small water user relative to the electric generating industry average developed by EPA for stations with multiple CWISs.

Finally, Exhibit 5-15 in EPA’s Technical Development Document (Ref. 7.6) shows the percentage of existing facilities that would be encompassed by various DIF thresholds for required entrainment compliance evaluation. The industry data in general shows little difference between AIF and DIF, even though AIF is slightly more than half the DIF at the Station. The upper line in Figure 4-3 shows the percentage of facilities that would be required to supply entrainment information under the Rule for various flow thresholds. Additionally, the bottom lines in Figure 4-3 show the percentage of total cumulative AIF/DIF that would be exempt from (not subject to) said threshold. Presumably, Exhibit 5-15 as shown in Figure 4-3 was used by EPA to determine an appropriate cut-off for facilities that are required to submit the additional entrainment-related information required by the Rule to aid in determination of a site-specific BTA for entrainment.

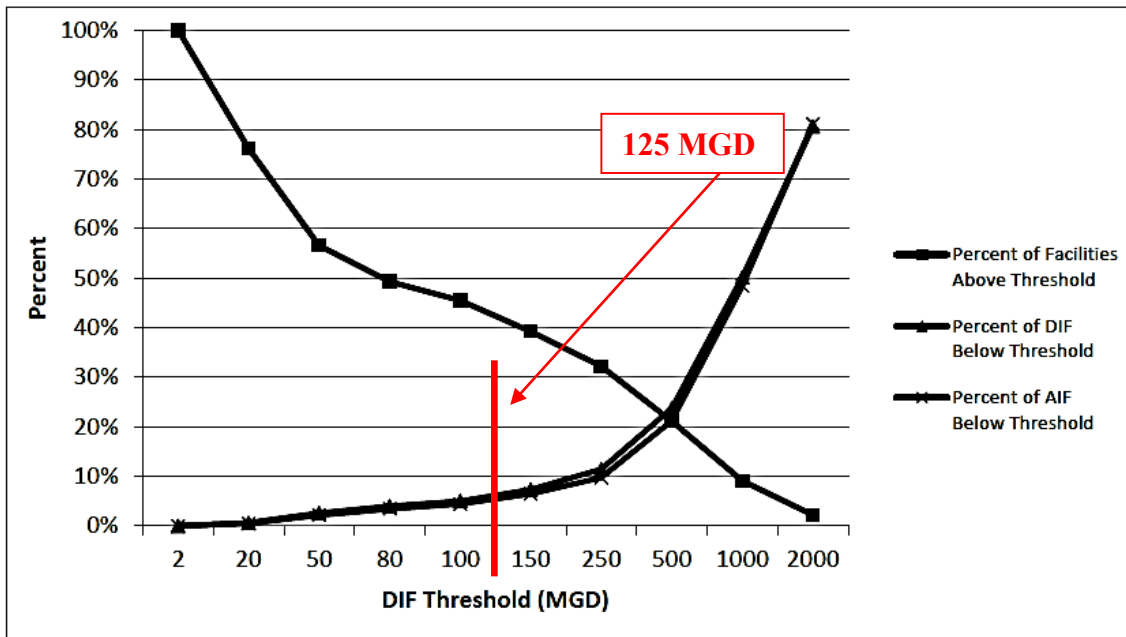

Figure 4-3: Existing facilities and flow addressed by various flow thresholds (Ref. 7.6)

Figure 4-3 illustrates that approximately 42 percent (from visual inspection) of facilities considered by EPA would be subject to the information requirements of a 125 MGD DIF threshold. Additionally, Figure 4-3 also illustrates that such a threshold would capture all but approximately 6 – 7 percent (from visual inspection) of the total industry AIF and DIF. Put differently, such a threshold would capture 93 – 94 percent of all industry AIF and DIF. From Figure 4-3, it appears that EPA’s logic to establish a 125 MGD AIF threshold is to encourage facilities to utilize operational measures to reduce intake flow (Reference 7.6). The 125 MGD threshold represents a policy decision by EPA to produce the greatest entrainment reduction in a way that affects less than half of the industry.

In this context, the Station’s AIF of 72.4 MGD is essentially negligible in relation to the remainder of the industry. The decision by EPA to impose additional entrainment controls on the Station in the draft permit is not warranted and is inconsistent with the justification given for use of the 125 MGD AIF threshold in the Technical Development Document as discussed above.

### 4.3 Benefits Valuation Study Requirements

Subsection 122.21 (r)(11) of the 316(b) Rule states the following:

*The owner or operator of an existing facility that withdraws greater than 125 MGD AIF must develop for submission to the Director an evaluation of the*

*benefits of the candidate entrainment reduction technologies and operational measures evaluated in paragraph (r)(10) of this section including using the Entrainment Characterization Study completed in paragraph (r)(9) of this section. Each category of benefits must be described narratively, and when possible, benefits should be quantified in physical or biological units and monetized using appropriate economic valuation methods. The benefits valuation study must include, but is not limited to, the following elements:*

*(i) Incremental changes in the numbers of individual fish and shellfish lost due to impingement mortality and entrainment as defined in 40 CFR 125.92, for all life stages of each exposed species;*

*(ii) Description of basis for any estimates of changes in the stock sizes or harvest levels of commercial and recreational fish or shellfish species or forage fish species;*

*(iii) Description of basis for any monetized values assigned to changes in the stock size or harvest levels of commercial and recreational fish or shellfish species, forage fish, and to any other ecosystem or non use benefits;*

*(iv) A discussion of mitigation efforts completed prior to October 14, 2014 including how long they have been in effect and how effective they have been;*

*(v) Discussion, with quantification and monetization, where possible, of any other benefits expected to accrue to the environment and local communities, including but not limited to improvements for mammals, birds, and other organisms and aquatic habitats;*

*(vi) Discussion, with quantification and monetization, where possible, of any benefits expected to result from any reductions in thermal discharges from entrainment technologies.*

No such valuation study for entrainment compliance has been conducted by the Station for several reasons.

**1) An entrainment characterization study as defined by §122.21 (r)(9) of the Rule has not been performed because the Station's AIF was below 125 MGD and it was not required.** As discussed in the 2008 Response (Ref. 7.1), Normandeau performed entrainment and impingement studies from August 2006 through September 2007. While the data collected and analyses performed therein fulfill many of the requirements of §122.21 (r)(9)(i), (ii), and (iii) for entrainment, the study did not meet the 2-year minimum data collection period. Thus, there is not sufficient entrainment characterization information to use as input to a benefits valuation study.

**2) A comprehensive technical feasibility and cost evaluation study per §122.21 (r)(10) has not been completed because the Station's AIF was below 125 MGD and it was not required.** While the 2008 Response evaluated technologically feasible entrainment (and impingement) technologies at that time, a supplement or addendum, not unlike the 2014 Report (Ref. 7.3), would need to be provided at a minimum. The 2014 Report provided technological and biological updates to previously evaluated impingement technologies to aid in the determination of BTA for impingement at the Station. This would also need to be done for previously evaluated entrainment technologies to ensure 1) any new entrainment technologies post-2008 are evaluated, 2) previously conducted analyses are updated to reflect current biological and operational performance information (e.g., CWWS effectiveness due to exclusion, hydraulic bypass, and larval avoidance), and 3) detailed cost and schedule estimates for all candidate entrainment technologies are provided. With respect to technology costs, the budgetary estimates provided in the 2008 Response do not reflect the level of detail delineated in §122.21 (r)(10), and as such, are not appropriate for use in a cost evaluation study as-is. Thus, there is not sufficient information relating to technological feasibility or cost to use as input to a benefits valuation study. Additionally, the technical feasibility and cost study would allow for creation of an implementation schedule for each technology to assess whether the implementation timeframe warrants consideration as part of BTA. Because the technical feasibility and cost evaluation study has not been performed, this information cannot be utilized as part of the BTA determination by EPA.

**3) Because the comprehensive technical feasibility and cost evaluation study has not been completed, the non-water quality environmental and other impacts assessment required by §122.21 (r)(12) has not yet been performed because the Station's AIF was below 125 MGD and it was not required.**

Once the technical feasibility and cost evaluation study has been performed, PSNH is required to submit a detailed discussion of the changes in non-water quality environmental factors attributed to the technologies and/or operational measures considered. Examples of information that may be evaluated include energy consumption, air pollutant emissions and their health and environmental impacts, noise, safety concerns, grid and facility reliability, and consumptive water use, among other items. This information is required to help ascertain the environmental impacts that certain technologies and/or operational measures would have outside of the CWA. To date, this information has not been provided to EPA, for the same reasons as stated above. As of the 2014 Report, PSNH was not aware that it would be subject to the entrainment information submittal requirements of the Rule since the Station's AIF is well below 125 MGD. As of this time, EPA's BTA determination is based on an incomplete set of information, including lack of a non-water quality environmental impacts assessment.



**4) Because an entrainment characterization study as defined by §122.21 (r)(9) and a comprehensive technical feasibility and cost evaluation study as defined by §122.21 (r)(10) have not been completed, a benefits valuation study defined by §122.21 (r)(11) cannot be performed at this time.**

The fact sheet provided with the draft permit for the Station states the following regarding a benefits valuation study.

*Yet, attempting to develop a monetized estimate of such ecological and non-use values is even more challenging than addressing recreational use values. In both cases, specialized expertise in natural resource economics and modeling would be needed that EPA Region 1 does not have on staff to apply on a permit-by-permit basis. It could take many months or even years to develop this type of complete monetized benefits estimate, and it could cost hundreds of thousands of dollars or more in contractor support. EPA does not have such resources to apply to this permit.*

*Moreover, in EPA's view, it would be unreasonable to spend those kinds of public resources, even if they could be found, in this case. This decision involves a permit for only a single, relatively small facility, Schiller Station, and Units 4 and 6 at the plant have been operating less and less in recent years. Moreover, as stated above, Schiller Station withdraws only a very small portion of the tidal flux of the Piscataqua River. (Pg. 161; draft fact sheet)*

EPA states that the resources are not available for EPA to conduct the formalized benefits analysis to determine the BTA for entrainment for the Station. EPA states that Schiller Station is a small facility and therefore does not justify the use of such a large amount of resources. However, EPA then requires the Station to install rigorous and costly entrainment controls in the draft permit without the justification of the benefits analysis. The purpose of providing the benefits analysis to EPA is so that an informed decision can be made regarding the BTA for entrainment. Because the Station's AIF is less than 125 MGD, the Station has not yet provided this study nor developed the inputs, such as a conceptual design and cost estimate, to complete the study. However, a formalized benefits study should be allowed to be submitted by PSNH in accordance with the 316(b) Rule before a BTA determination is made for entrainment.

**5) The Station's AIF is not greater than 125 MGD per Section 4.2. Thus, in accordance with the Rule, the Station did not believe it was required to submit these items.**

In lieu of having a formalized benefits valuation study to aid in the determination of BTA, the EPA (in the fact sheet) performed high level qualitative and quantitative evaluations to compare the candidate entrainment technologies discussed in the 2008 Response (Ref. 7.1). In addition, the sources of information used by EPA in this high level analysis are out of date

and no longer represent the current understanding of CWWS performance. It also does not contain quantified and qualitative social benefits and costs of available entrainment technologies of sufficient rigor to make an informed determination of BTA as required per §125.98(2)(v). Therefore, if the EPA is going to make a site-specific determination of BTA for entrainment, the Station should be allowed to submit the benefits-related information delineated above, as well as that contained in §122.21 (r)(9) and (r)(10). The timeframe for submitting comments on the draft permit does not allow for a formalized benefits study to be performed. However, this study should be performed as required by the Rule.

#### **4.4 Conclusion**

EPA did not follow the correct process for evaluating and imposing entrainment controls on an existing facility. Determination of entrainment-related BTA for an existing facility (such as the Station) requires the Director to consider relevant information submitted by the owner or operator of the facility. Much of this information has not been provided by PSNH to EPA because, at the time of the 2014 Report (Ref. 7.3), it was not apparent from the requirements of the Rule that submittal of information related to entrainment was required. Additionally, the limited set of information that the EPA did possess at the time of the draft permit issuance was outdated and historic, as shown in Section 5 below.

## 5 Historic Wedgewire Screen Information

EPA considered several entrainment-reducing technologies and/or operational measures in the permit and fact sheet, ultimately relying on a qualitative assessment to determine that CWWSs with a slot size of 0.8 mm were the BTA for the Station. The flaws in this determination have been discussed earlier in this report and will not be repeated here. EPA has specified that a slot size of 0.8 mm be used, for which a design and cost estimate that meet the requirements of §122.21(r)(10) have not been performed. Therefore, the cost to implement this technology is unknown. Additionally, as discussed in the previous sections, the benefits provided by this technology were also not accurately depicted by EPA at the time of the determination, given the issues associated with using the 2008 effectiveness numbers.

The 2014 report (Ref. 7.3) provided a new design for wide-slot wedgewire screens. These screens have a slot size of 9.5 mm and are intended to meet the BTA standard for impingement mortality by being designed for a through-screen velocity of 0.5 fps or less. The design utilizes half-screens due to the shallow water depths in front of the intake structure, and ties into the existing intakes in a way that will allow for plant operation to continue in the event of a screen blockage event. While not applicable to the requirements of the draft permit, the 2014 report design represents the only CWWS design information that is of sufficient detail to use as part of a BTA determination. Therefore, information related to this design is presented below. Additionally, the information developed in response to the 2008 EPA request to provide “the engineering aspects or considerations pertinent to considering the possible application of...” technologies is not appropriate for use in a BTA determination by EPA (Ref. 7.30).

### 5.1 Installation Cost

The 2014 report contains a Class 5 cost estimate in accordance with ASTM E2516-11. Attachment 1 of the report contains cost estimates for both the barrier net and wedgewire screen technologies. The cost estimates are created based on the expected materials, equipment, and labor required to construct and implement the technology. Attachment 1 contains a line-by-line estimate of each of the major items that constitute the estimate. Given the level of design, only major cost items are captured, and the remaining items are covered by a project contingency or other allowances. The recommended construction budget for the wide-slot wedgewire screens was \$5,690,000<sup>4</sup> including permitting. Additionally, an

---

<sup>4</sup> As discussed in Appendices 2 and 3, a slot size of 2 mm or greater is recommended based on available industry operating experience and expected performance of the CWWSs. The cost presented here is based on a design performed in 2014 for 9.5 mm slot size CWWSs, which were predicated on the Station having to address the BTA

engineering budget of \$460,000 was recommended. It is reasonable to assume that the costs can be divided evenly between the three operational units: with one-third of the total cost attributed to Unit 4, Unit 5, and Unit 6.

This cost estimate is representative of the CWWS design presented in the 2014 report. CWWS equipment costs at slot sizes smaller than 9.5 mm would be expected to be greater, and certain aspects of the design may also change (e.g., CWWS diameter, length, etc.). Therefore, the cost figure presented above does not meet the requirements of §122.21 (r)(10) for any slot size other than 9.5 mm. The cost estimate could be used as an order-of-magnitude estimate for discussion purposes only with the understanding that it includes a large degree of uncertainty. As discussed further in Appendix 2, available operating experience suggests that slot sizes of 2 mm or above have the best likelihood for demonstrating acceptable performance, while testing has shown that biofouling or blockage may potentially be a concern at smaller slot sizes. Additionally, as discussed in Appendix 3, a properly engineered CWWS system with a 2 mm slot size or greater can achieve performance comparable to that of a 0.8 mm slot size. Therefore, based on the industry experience and knowledge base, in addition to the expected performance, a slot size of 2 mm or greater is recommended. A new design would be required to determine a cost estimate that meets the requirements of §122.21 (r)(10) for a 2 mm or greater slot size.

In the event that blockage of the screens were to occur, due to either biofouling, debris accumulation, frazil ice, or other reasons, a bypass system would be required for Schiller Station to withdraw water from Piscataqua River to maintain cooling in the plant. Given that the debris accumulation, biofouling, and frazil ice characteristics and frequency of occurrence are unknown at Schiller Station, such a bypass system is prudent from an engineering perspective and would allow for increased reliability of the Station.

In the 2014 design, for Unit 4 the screen array connects directly to the northern-most offshore intake in front of Screen House #1, which was formerly utilized by Unit 3. A cross-tie is present within Screen House #1 that would allow the water drawn from the wedgewire screens to be delivered to the Unit 4 circulating water pumps. The retired Unit 3 intake is utilized so that the existing operational Unit 4 intake is available for emergency situations in

---

standard for impingement only based on its AIF of less than 125 MGD. A design for 2 mm slot sizes has not been performed; therefore, there is no cost estimate available for 2 mm CWWSs that meets the requirements of §122.21 (r)(10) to aid in a site-specific BTA determination for entrainment. It is expected that the costs would increase for smaller slot sizes; however, the extent to which this would occur is not known with currently available information and would require further design effort. If detailed design of a 2 mm slot size CWWS system were to commence, a further review of associated and/or related equipment would be undertaken to determine the necessity for equipment replacement. It is possible that other equipment associated with the cooling water intake structure would need to be replaced commensurate with the expected equipment lifespan of the newly constructed CWWSs. This would increase the total cost for PSNH above what is provided.

which the screens become blocked. During this scenario, the normally-lowered Unit 4 stop log would be raised, and flow would pass through the existing Unit 4 offshore intake through the traveling water screens, similar to current operation.

For Units 5 and 6, the 2014 design included a plenum in front of Screen House #2 to collect water from the four wedgewire screens (two for each Unit). From the plenum, the water would enter the Unit 5 and 6 intakes similar to current operations, with the bar racks connecting the screen house to the plenum. In an emergency situation where the screens became blocked, the design of the plenum includes two emergency sluice gates on the front (i.e., river facing) side. These gates would be opened, allowing water to be drawn into the plenum directly. From here, water would pass through the bar racks and traveling screens in Screen House #2, similar to current operation.

Because operation of the bypass system would revert each of the Units to an intake configuration that is similar to that which is currently installed, entrainment would occur similar to current operation. Therefore, if a slot size is specified such that frequent clogging occurs, the overall entrainment may be higher than that which would occur for larger slot sizes.

In the fact sheet, EPA has challenged the necessity of the bypass system. The primary reason that the bypass system was included is to ensure that a continuous supply of cooling water is always available to the Station. The expected frequency of a clogging event is unknown until a pilot study is conducted, and clogging of the CWWs would serve to reduce the water level within the screen houses. At a certain point, the pumps would become damaged due to air intrusion and vortex formation unless the pumps were tripped or another source of water was made available (i.e., the bypass system). The tripping of the pumps would result in the tripping of the Station. This would result in lost generating capacity for the Station and loss of cooling to equipment within the plant. As discussed in Appendix 2, bypass systems are common and have been installed at other power plants to ensure operational reliability. The continuous supply of cooling water helps maintain power generation, but is also critical for maintaining the safety and reliability of plant equipment, as will be discussed below.

In addition to loss of cooling to the condenser for power generation, as discussed in the 2008 Response (Ref. 7.1) there are other pumps and systems that support equipment cooling for the Station. Unit 4 contains one salt water cooling pump, which provides water to the salt water heat exchangers. For Units 5 and 6, the circulating water pumps provide water to the salt water heat exchangers, which provide equipment cooling to the plant. The interruption of cooling water to these systems would create a sudden loss of cooling, which in turn could create a transient or thermal shock to the salt water heat exchangers.

The Tubular Exchanger Manufacturer’s Association (TEMA) is the governing authority on heat exchanger design and construction in the industry. The “Standards of the Tubular Exchanger Manufacturers Association” (TEMA Standards) (Ref. 7.18) are utilized throughout the industry as a guide to size, design, operate, and maintain heat exchangers. Paragraph E-3 titled “Operation of Heat Exchangers” provides guidelines for operating heat exchangers in a way that ensures safety and reliability. Paragraph E-3.23 states “Exchangers normally should not be subjected to abrupt temperature fluctuations.” Paragraph E-4 is titled “Maintenance of Heat Exchangers” and provides guidelines for maintaining acceptable operation of the heat exchangers. Paragraph E-4.1 states that “neglect in keeping the tubes clean may result in complete stoppage of flow through some tubes which could cause severe thermal strains, leaking tube joints, or structural damage to other components.” While clogging of the heat exchangers is not of concern with regard to the bypass system, the resulting thermal strain and/or thermal shock that may occur due to abrupt interruption of flow may result in similar consequences (Ref. 7.18). Therefore, given that the salt water heat exchangers were not originally designed for regular/frequent transients, they should be avoided and a continuous supply of cooling water should be made available to the salt water heat exchangers. If CWWSs were to be installed at the Station, the most effective way to ensure a continuous supply of cooling water would be to install a bypass system as described in the 2014 report (Ref. 7.3).

In October 2008 report, ENERCON responded to a §308 information request letter from EPA to describe “the engineering aspects or considerations pertinent to considering the possible application” of a wide array of technologies at the Station (Ref. 7.30). In response to this request, ENERCON provided a screening-level evaluation of a wide range of impingement- and entrainment-reducing technologies, including: conversion to closed-cycle cooling using both seawater and gray water, a variety of screening technologies, renovation of the Unit 3 intake, continuous operation of traveling water screens, upgraded fish handling and return systems, new circulating water pump motors with variable frequency drives (VFDs), two-speed circulating water pump motors, acoustic fish deterrence systems, and the shifting of plant outages to different parts of the year. Given the scope of the request, the level of design and engineering evaluation dedicated to each technology is less than that which would occur in subsequent reports that focused on a smaller set of specific technologies. Therefore, the CWWS cost figures provided in the 2008 report do not meet the requirements of §122.21 (r)(10) as further design effort would be needed to create a design similar to that which was created in 2014 for the 9.5 mm slot size CWWSs.

## 5.2 Scheduling Considerations

As discussed in Section 4.3, construction schedules for each of the entrainment technologies discussed for Schiller Station have not been created to date. This is because a comprehensive technology and cost evaluation study has not been performed. Therefore, any estimate of schedule or project duration is based solely on engineering judgment and prior experience, rather than any site-specific design work that has been performed for Schiller Station. To this end, projects similar to installation of CWWs at Schiller Station would generally be expected to last approximately two years. Therefore, based on engineering judgment alone, a two-year total engineer/permit/construct (EPC) duration should be assumed for preliminary purposes. This duration does not include pilot testing, which would also be required.

Given the typical structure of an EPC project, it is not unreasonable to expect that engineering and permitting would generally occur over the first half of the total project duration, while construction would generally occur over the second half of the total project duration.

As stated previously, construction schedules and timelines have not been created for any technology to date. Therefore, it is not yet possible to adequately resolve technical issues such as whether or not an outage will be required to implement a technology. Therefore, for conservatism it is reasonable to assume that no additional outage would be required beyond the typical maintenance outages.

## 5.3 Conclusion

This section presented historic CWW information as a part of previous reports that were developed. The information contained in this Section is not directly applicable, since the 2014 report considered a 9.5 mm slot size and the 2008 report only provided very high-level information. It is recommended that PSNH be allowed to submit information pursuant to the Section 316(b) Rule requirements. To achieve this, it is recommended that a design be performed for a CWW system having a slot size of 2 mm or greater (based on Appendices 2 and 3) so that a more accurate estimate of cost that meets the requirements of §122.21 (r)(10) can be created.

## 6 Impingement Technology Selection

Fine mesh CWWSs have been determined by the EPA in the Station's draft fact sheet to represent the BTA for minimizing impingement impacts at the Station. In accordance with the Rule, §125.94(c) allows an owner or operator of an existing facility to comply with the BTA standard for impingement mortality using one of seven compliance options. With regard to facilities with multiple separate intakes, the Rule preamble states the following to clarify how the standard may apply to such a facility.

*EPA received some comments questioning whether specific provisions apply to the entire facility or to individual intakes. To clarify this issue, EPA modified the rule language so as to state clearly that a facility with multiple intakes must decide whether it will adopt a single compliance strategy for impingement mortality for the entire facility or adopt an intake-specific compliance strategy at each cooling water intake. Thus, facilities may select different compliance strategies for different intakes, providing flexibility at facilities with multiple intakes.*

From the excerpt above, the Rule allows for a facility to determine whether it will choose one compliance strategy for the entire facility or choose separate compliance strategies for each intake. Therefore, Schiller Station could choose to pursue different impingement compliance strategies for Screen House #1 (Unit 4) and Screen House #2 (Units 5 and 6), or choose a common compliance strategy. In either case, the Rule preamble is clear that the decision rests with the owner of the facility as to how compliance with the BTA standard for impingement mortality will be achieved. Therefore, at minimum EPA should have consulted with the Station before specifying how to meet the impingement mortality standard (via the selection of one of the seven options). The site's decision would then be identified in the submittal of information related to §122.21(r)(6) as required by the Rule.

### 6.1 Compliance Options

Existing power generating facilities that are designed to withdraw greater than 2 MGD of water from waters of the United States, and that use at least 25 percent of this water exclusively for cooling purposes, are subject to the BTA standard for impingement mortality. Compliance with the BTA standard for impingement mortality may be achieved using any one of seven options delineated in the Rule, as described below. Note that the following text includes a summary of the Rule requirements, but the Rule itself should be consulted for the detailed requirements and exact language.



### 6.1.1 Option #1 – Closed-Cycle Cooling

The first compliance strategy as defined in §125.94(c)(1) is to operate a closed-cycle recirculating system as defined in §125.92. This is essentially a pre-approved technology requiring no demonstration, or only a minimal demonstration, that the flow reduction and control measures function as EPA envisions. Submittal of the information delineated in §122.21(r)(2) through (r)(6) and §122.21(r)(8) is required as a part of the permit application process. The monitoring required must include measuring cooling water withdrawals, make-up water flows, and blowdown flows. The facility is required to monitor actual intake flows (the average volume of water withdrawn on an annual basis) and cycles of concentration to allow the Director to determine that make-up and blowdown flows have been minimized. Biological compliance monitoring is not required.

As discussed in the 2008 Response, a closed-cycle cooling configuration using mechanical draft cooling towers was determined to be feasible from an engineering perspective at Schiller Station (Ref. 7.1). The initial and ongoing costs are significantly higher than that of other technologies and operational measures considered for reduction in impingement mortality. Therefore, based on these impacts, the relative cost of this technology, and Schiller Station's operational profile, conversion of Schiller Station to closed-cycle cooling is not considered a practical compliance strategy.

### 6.1.2 Option #2 – Design Intake Velocity

The second compliance strategy as defined in §125.94(c)(2) is to operate a CWIS that has a maximum through-screen design intake velocity of 0.5 fps. This is a pre-approved technology requiring no demonstration, or only a minimal demonstration, that the flow reduction and control measures function as EPA envisions. Submittal of the information delineated in §122.21(r)(2) through (r)(6) and §122.21(r)(8) is required as a part of the permit application process. The facility must submit information demonstrating that the maximum design intake velocity passing through the screens cannot exceed 0.5 fps. This maximum water velocity must be achieved during all conditions, including periods of minimum water source elevations and during periods of maximum head loss across the screens. Biological compliance monitoring is not required.

Compliance under Option #2 would require Schiller Station to operate an intake such that the design intake through-screen velocity does not exceed 0.5 fps at any time. This could be accomplished in a number of ways, some of which are more practical than others. The 2014 Report to EPA determined that the best way to meet the BTA standard for impingement using design intake velocity would be to install a barrier net or to install wedgewire screens (Ref. 7.3). The 2014 Report also noted debris loading may cause

increase in the through-slot velocity for CWWS above the 0.5 fps threshold, and the potential exists for emergency bypass in the event of significant blockage, during which the 0.5 fps velocity requirement would not be met. The barrier net could be constructed in a way such that the design intake flow attributed to the plant produced a theoretical velocity (as defined in the Rule) that is less than 0.5 fps. However, practically speaking, the ambient velocity of the Piscataqua River would produce a much faster velocity passing through the portions of the net that are perpendicular to the current.

### **6.1.3 Option #3 – Actual Intake Velocity**

The third compliance strategy as defined in §125.94(c)(3) is to operate a CWIS that has a maximum through-screen intake velocity of 0.5 fps. The facility must submit information to the Director that demonstrates that the maximum intake velocity as water passes perpendicularly through the screen does not exceed 0.5 fps. Submittal of the information delineated in §122.21(r)(2) through (r)(6) and §122.21(r)(8) is required as a part of the permit application process. This method is similar to Option #2 (*design* velocity) except that the intake's maximum design velocity can exceed 0.5 fps as long as the intake is operated in a manner such that the actual, measured velocity does not. One example given in the Rule is a facility that was originally designed with an intake velocity of 1.0 fps, but has achieved an actual intake velocity 0.5 fps by retiring a portion of the plant. Monitoring of the velocity at the screen face or immediately adjacent to the screen face (not the approach velocity) must be conducted daily, or a calculation must be performed demonstrating this. Additionally, the facility may be granted permission to exceed the low velocity compliance alternative for brief periods of time, such as during backwashing or back-flushing. Biological compliance monitoring is not required.

Given that Units 3 and 4 share the same intake (Screen House #1), and that Unit 3 was retired in 1991, this is an option that may be available for Unit 4 as discussed in the 2008 Response. This modification would result in an estimated actual intake velocity of 0.46 fps in Screen House #1 at MLW, satisfying the criteria. However, compliance under this scenario is only possible for Unit 4, because Units 5 and 6 currently utilize all of the available intake bays in Screen House #2 and the through-slot velocity is above 0.5 fps.

### **6.1.4 Option #4 – Offshore Velocity Cap**

The fourth compliance strategy as defined in 125.94(c)(4) is to operate an offshore velocity cap as defined in §125.92 that is installed before the effective date of the Rule. This is a pre-approved technology requiring no demonstration, or only a minimal demonstration, that the control measures function as EPA envisions. Submittal of the information delineated in §122.21(r)(2) through (r)(6) and §122.21(r)(8) is required as a part of the

permit application process. The velocity cap must be located a minimum of 800 feet offshore, and must contain devices such as bar racks to exclude marine animals. Additionally, the velocity cap must be designed to change the direction of the water withdrawn from vertical to horizontal, and intake flow must be monitored daily. Biological compliance monitoring is not required. Note this this compliance option only applies to facilities that already use a velocity cap. If facilities choose to construct a velocity cap at an offshore location after the effective date of the Rule, they would be utilizing compliance Options #6 or #7 below.

As discussed in the 2008 Response, Unit 4 uses an offshore bulkhead intake with bar racks, and Units 5 and 6 use a conventional shoreline intake. Compliance under this scenario would have required Schiller Station to have an offshore velocity cap that meets the definition in the Rule (located a minimum of 800 ft offshore) before the effective date of the Rule. Because Schiller Station does not currently have an offshore velocity cap that meets the definition, compliance under this scenario is not possible.

### **6.1.5 Option #5 – Modified Traveling Water Screen**

The fifth compliance strategy as defined in §125.94(c)(5) is to operate a modified traveling screen that the Director determines meets the definition at §125.92(s) and that the Director determines is the BTA for impingement reduction. The definition requires those features of a traveling water screen that provide an appropriate level of fish protection including:

- Collection buckets that minimize turbulence;
- Guard rails or barriers to prevent loss of fish from the collection system;
- Smooth or soft screen panel materials that protect fish from descaling;
- Continuous or near-continuous rotation of screens and operation of collection equipment to recover impinged fish as soon as practical;
- Low-pressure wash or vacuum to remove collected organisms from the screen; and
- A fish handling and return system (FHRS) with sufficient water flow to return fish directly to the source waterbody in a manner that does not promote re-impingement of the fish, or a large vertical drop.

For this option, the facility is required to submit a site-specific impingement technology performance optimization study that includes two years of biological sampling. The study must demonstrate that the operation of the modified traveling screens has been optimized to minimize impingement mortality. EPA notes in the Rule that modified traveling screens include, but are not limited to modified Ristroph screens with a FHRS, dual flow screens

with smooth mesh, and rotary screens with fish returns or vacuum returns. Submittal of the information delineated in §122.21(r)(2) through (r)(6), §122.21(r)(6)(i), and §122.21(r)(8) is required as a part of the permit application process.

Compliance under Option #5 would require installation of modified traveling water screens and a FHRS that meets the definition as described above. Modified coarse-mesh Ristroph screens with a modified FHRS is a candidate technology for compliance under this scenario, and represents a relatively quick and straightforward modification to the plant. These are proven technologies for which there is a lot of industry experience.

### **6.1.6 Option #6 – System of Technologies**

The sixth compliance strategy as defined in §125.94(c)(6) is to operate any systems of technologies, best management practices, and/or operational measures that the Director determines is the BTA for impingement reduction. This option allows the facility to choose the technologies, practices, and operational measures that it believes will meet the impingement mortality standard. The facility is required to submit a site-specific impingement study including two years of biological data collection demonstrating that the operation of the system of technologies, operational measures and best management practices has been optimized to minimize impingement mortality. The estimated reductions in impingement must be based on comparison of the system to a once-through cooling system with a traveling screen whose point of withdrawal from the surface of the water is located at the shoreline of the source waterbody. Submittal of the information delineated in §122.21(r)(2) through (r)(6), §122.21(r)(6)(ii), and §122.21(r)(8) is required as a part of the permit application process. The 2014 Report contains a discussion on potential methods by which compliance under this strategy may be achieved (Ref. 7.3).

### **6.1.7 Option #7 – Achieve the Specified Impingement Mortality Standard**

The seventh compliance strategy as defined in §125.94(c)(8) is to achieve the specified impingement mortality standard. This option requires that the facility achieve a 12-month impingement mortality performance of all life stages of fish and shellfish of no more than 24 percent mortality, including latent mortality, for all non-fragile species. The Rule contains specific requirements relating to how impingement shall be calculated. Compliance may be demonstrated for either the entire facility or for each individual CWIS. Submittal of the information delineated in §122.21(r)(2) through (r)(6), and §122.21(r)(8) is required as a part of the permit application process. The 2014 Report contains a discussion on potential methods by which compliance under this strategy may be achieved (Ref. 7.3).

## 6.2 Schiller Technology Selection

As discussed in Section 6 above, the 316(b) Rule is clear in that existing facilities are required to choose which of the seven compliance options they select for compliance with the BTA standard for impingement technology. The draft permit specifies that Schiller Station shall install fine mesh CWWSs for impingement compliance, which is not in keeping with the intent of the Rule. While PSNH agrees that CWWSs would meet the impingement mortality standard if designed to a through-slot velocity of 0.5 fps, it does not agree that CWWSs, or any other impingement reducing technology, shall be mandated by the EPA. To that end, the Station should be allowed to choose whatever option they prefer and provide the necessary supporting documentation in accordance with the Rule.

Based on the compliance option discussions above and the additional details found in the 2008 Response and 2014 Report, Option #5 is believed to offer the most practical and timely approach to impingement compliance for the Station.

### 6.2.1 Operating Experience

The selection of modified traveling screens (e.g., Ristroph screens) with a FHRS at the Station is largely based on the large amount of positive operating experience (i.e., ease of installation and operation, wide use, etc.) surrounding the technology as discussed in the EPA's Technical Development Document (Ref. 7.6):

*Modified traveling screens with fish handling systems are among the oldest technologies developed specifically to address impingement and have been widely deployed and studied throughout the United States. Because so many existing facilities already use conventional traveling screens, modified traveling screens are broadly applicable and may not require significant changes to the CWIS to achieve high levels of performance. A successful installation is generally independent of factors such as waterbody type, climate zone, age, fuel type, or intake flow. In other words, a facility that has previously used a conventional traveling screen (nearly all facilities, operating under a wide variety of conditions) should also be able to employ a modified traveling screen.*

*Compared with other impingement design and construction technologies used as retrofit options, modified traveling screens are relatively easy to install and operate. Changes to the screens themselves are relatively straightforward and, in all but the most unique instances, do not require substantial modification or expansion of the screen houses and can be completed during normal maintenance outages without affecting the facility's generating schedule. Likewise, because this technology does not alter the cooling water flow per se, the facility's generating output is unaffected; no energy penalty is incurred save*

*for the small increase in electrical usage due to continual or more frequent screen rotation. (Pg. 6-31 and 6-32; Ref. 7.6)*

Per the 2008 Response, Units 4, 5, and 6 currently use traveling water screens with FHRSS for impingement control. Therefore, the Station is already familiar with the operation and maintenance of these technologies, which would presumably allow for a more streamlined upgrade process in the future, rather than re-configuring the intake structure to allow for connection with CWWSs. Moreover, the 2008 Response concluded that retrofitting the existing traveling screens at the Station with modified traveling screens and state-of-the-art FHRSS for increased effectiveness in reducing impingement mortality was not only feasible, but would not be expected to have appreciably higher maintenance costs than the existing traveling screens.

While fine mesh CWWSs were also evaluated in the 2008 Response and deemed a feasible (entrainment) technology for implementation at the Station, potential fouling, clogging, icing, and the need for emergency bypass increases the operational risk associated with this technology as discussed in Section 4.1. Appendix 2 also provides additional details on CWWS biological fouling concerns and discusses how there are no CWWS installations on any estuary ecologically similar to the lower Piscataqua River in the relative vicinity of the Station. There is not a large body of operating experience surrounding CWWSs like there is for modified traveling screens and FHRSSs.

### **6.2.2 Implementation Schedule**

The installation of modified traveling screens with a FHRS would bring the Station into compliance faster given a shorter implementation duration as compared to CWWSs. This is primarily due to a lack of site-specific pilot testing, which would occur for one year at the Station for CWWSs under the draft permit. Pilot testing would allow the Station to evaluate the performance of the system, material selection, and various slot sizes to ensure the most optimized and effective CWWS system is actually implemented. Such additional measures would not be required for a proven technology.

Given the large amount of industry experience surrounding the use of modified traveling water screen technologies (as discussed above), such pre-implementation testing is not required. Because both technologies have the potential to meet the BTA standard for impingement mortality, the use of modified traveling screens would allow for sooner implementation, and thus compliance with the BTA standard.

## 7 References

- 7.1 Enercon Services, Inc. in consultation with Normandeau Associates, Inc., "Response to United States Environmental Protection Agency CWA §308 Letter," PSNH Schiller Station Report. October 2008.
- 7.2 Enercon Services, Inc., "Response to United States Environmental Protection Agency's Information Request for NPDES Permit Re-issuance," PSNH Schiller Station Report. August 2013.
- 7.3 Enercon Services, Inc. in consultation with Normandeau Associates, Inc., "Response Supplement to United States Environmental Protection Agency CWA §308 Letter," PSNH Schiller Station Report. October 2014.
- 7.4 EPRI Technical Report 1010112, "Field Evaluation of Wedgewire Screens for Protecting Early Life Stages of Fish at Cooling Water Intakes." May 2005.
- 7.5 United States Army Corps of Engineers, "Portsmouth Harbor and Piscataqua River Navigation Project."  
<http://www.nae.usace.army.mil/Missions/CivilWorks/Navigation/NewHampshire/Portsmouth.outh.aspx>. Accessed December 16, 2015.
- 7.6 Technical Development Document for the Final Section 316(b) Existing Facilities Rule. EPA-821-R-14-002. May 2014.
- 7.7 American Society of Heating, Refrigerating, and Air-Conditioning Engineers (ASHRAE) Systems and Equipment Handbook, 2008.
- 7.8 Normandeau Associates, Inc., Entrainment and Impingement Studies Performed at Schiller Generating Station from September 2006 through September 2007, April 2008.
- 7.9 Normandeau Associates, Inc., Newington Station 316 Demonstration, Volume II, 316(b) Demonstration, 1979.
- 7.10 Padilla, R., et al., A Pilot Study on the Bio-fouling Resistance of 304 and 316 Stainless Steels and Copper Nickel Metal, July 2005.
- 7.11 Telecom Between Cuong H. Dinh and John Palmer Regarding CWW Screen Operating Experience. November 2, 2009.
- 7.12 United States Environmental Protection Agency. Section 316(b) TDD Chapter 5 for New Facilities.
- 7.13 Telecom Between Cuong H. Dinh and Mike Idiagbor Regarding CWW Screen Operating Screen Experience. October 29, 2009.
- 7.14 New York State Department of Environmental Conservation, "ENB Region 2 Completed Applications 10/22/2014." [http://www.dec.ny.gov/enb/20141022\\_reg2.html](http://www.dec.ny.gov/enb/20141022_reg2.html). Accessed December 16, 2015.
- 7.15 Email from Mark Watson to John Chiulli, Johnson Screens, Dated September 18, 2012.
- 7.16 Fedorenko, A.Y. Guidelines for minimizing entrainment and impingement of aquatic organisms at marine intakes in British Columbia. Canadian Manuscript Report of Fisheries and Aquatic Sciences. No. 2098. 1991.
- 7.17 Taft, E.P. Fish Protection Technologies: A Status Report. Environmental Science and Policy. Vol. 3, Supplement 1. pp. 349-359. 2000.
- 7.18 Standards of the Tubular Exchanger Manufacturers Association. 8th Edition, 1999.

- 7.19 “Cylindrical Wedgewire Screen Installation [redacted] Charles Point OE Meeting.” May 4, 2011.
- 7.20 “Cylindrical Wedgewire Screen Installation [redacted] Charles Point OE Meeting.” May 5, 2011.
- 7.21 Telecom Between Cuong H. Dinh and David Lee Regarding CWW Screen Operating Experience. November 19, 2009.
- 7.22 Winemiller, K. O., and K. A. Rose. 1992. Patterns of life-history diversification in North American fishes: implications for population regulation. *Canadian Journal of Fisheries and Aquatic Sciences* 49:2196-2218.
- 7.23 Salia, S.B., E.Lorda, J.D. Miller, R.Sher, and W.H. Howell. 1997. Equivalent adult estimates for losses of fish eggs, larvae and juveniles at Seabrook Station with use of fuzzy logic to represent parametric uncertainty. *North American Journal of Fisheries Management*. 17: 811-825.
- 7.24 Collette, B.B. and G. Klein-MacPhee. 2002. *Bigelow and Schroeder’s Fishes of the Gulf of Maine*, 3rd edition. Smithsonian Institution Press, Washington DC.
- 7.25 Short, F.T. 1992 (ed.) *The Ecology of Great Bay Estuary. New Hampshire and Maine. An Estuarine Profile and Bibliography*. NOAA – coastal Ocean Program Publication. 222 pages.
- 7.26 Barnthouse, L.W. 2005. Parameter development for equivalent adult and production foregone models. EPRI Report 1008832. June 2005.
- 7.27 Electric Power Research Institute (EPRI) 2012. Fish life history parameter values for equivalent adult and production foregone models: comprehensive update. EPRI Report 1023103. April 2012.
- 7.28 New Hampshire Code of Administrative Rules, Env-Wq 1700 Surface Water Quality Regulations, P.33, Env-Wq 1708.01(e).  
<http://des.nh.gov/organization/commissioner/legal/rules/documents/env-wq1700.pdf>. Accessed January 5, 2016.
- 7.29 Berrill, M. 1982. The life cycle of Green Crab *Carcinus maenas* at the northern end of its range. *J. Crust. Biol.* 2:31-39.
- 7.30 Letter from Stephen S. Perkins to John M. MacDonald, “Supplemental Information Request to Section 308 of the Clean Water Act to Supercede Previous Letter dated December 30, 2004 for Schiller Station NPDES Permit Reissuance – [NPDES Permit No: NH0001474].” Dated October 31, 2007.



**Appendix 1: Specific Comments**

This Appendix contains a list of specific comments stemming from ENERCON and Normandeau's respective reviews of the draft fact sheet and draft NPDES permit for Schiller Station. This appendix is first organized by document; that is, fact sheet- or permit-only comments. Document-specific comments are then further organized into categories (e.g., State Water Quality Standards). Finally, each category contains one or more comments relating to that particular category with references to specific sections, page numbers, paragraphs, etc. of the fact sheet or permit. Some comments may also include direct excerpts from these locations, which will be denoted using italics.

## Fact Sheet

### Use of DIF and AIF

1. The EPA appears to be inconsistent in how it presents design and actual intake flow rates for Schiller Station as shown below:
  - Page 18: *"The two CWISs have a combined total maximum design intake flow of 150 million gallons per day (MGD)."*
  - Page 80: *"Given Schiller Station's intake flow of 125 MGD, the facility was expected to be covered by the Phase II Rule."*
  - Page 93: *"In addition, to be more conservative, EPA's presentation of Schiller Station entrainment losses reflect the plant design flow of 124.4 MGD..."*
  - Page 104: *"Schiller Station's once-through cooling system is designed to withdraw up to 125.7 MGD of water from the Piscataqua River."*
  - Page 112: *"At Schiller Station, the intake flow of 125 MGD is relatively small as compared to the river width and depth, and an adequately sized wedgewire screen installation is not likely to interfere with other uses of the river."*

Per Table 1 of the 2014 Report, the Station's DIF is 125.8 MGD, and AIF was 73.7 MGD. These parameters are updated in Section 4.2 of this report. It is requested that EPA consistently reference the basis for the flow numbers they cite and include DIF or AIF whenever flow rates are discussed.

### State Water Quality (WQ) Standards

2. Page 85: *"(i) More stringent standards. The Director must establish more stringent requirements as best technology available for minimizing adverse environmental impact if the Director determines that compliance with the applicable requirements of this section would not meet the requirements of applicable State or Tribal law, including compliance with applicable water quality standards (including designated uses, criteria, and antidegradation requirements)."*

New Hampshire has no Water Quality standards for 316(b)-related issues that call for EPA to select more stringent standards than the Federal CWA 316(b) regulations.

### CWWSs

3. Page 107: *“According to PSNH, a mesh size of no greater than 1.0 mm is necessary to effectively screen most fish eggs and larvae. Enercon, 2008, p. 80.”*

This was not stated directly by ENERCON/Normandeau. The 2008 Response evaluated slot sizes from 0.6 mm up to 1.0 mm given the understanding (at that time) that their entrainment reduction performance was considered primarily as a mechanical filter functioning to physically exclude eggs and larvae if their limiting dimensions were larger than the slot width. EPA should examine the considerable new evidence obtained since 2008 and presented in this report and modify their evaluation of CWWS according to these new facts, which support effective performance at slot widths greater than 1.0 mm.

4. Page 110: *“According to PSNH, this option would include two Johnson Screens Model T-78HC half-screens with a slot width of 3/8 inches (9.5 mm) for Screen House #1 (the Unit 4 intake) and three of the same screens for Screen House #2 (Units 5 and 6 intakes).”*

The wedgewire screens for Units 5 and 6 were specified as larger diameter screens than the Unit 4 screens (84 in.).

5. Page 111: *“Finally, the biological efficacy of wide-slot wedgewire screens was not evaluated in Enercon, 2014 since, according to Enercon, “biological efficacy is not required under the final § 316(b) regulations.” Enercon, 2014, p. 48.”*

ENERCON did not state that biological efficacy was not required, the report states that evaluation and monitoring of screen efficacy would not be required as it would meet the 0.5 fps design intake velocity criteria. This is consistent with the 316(b) rule for meeting the BTA standard for impingement mortality.

6. Page 111: *“Further, dredging would not likely be necessary with wedgewire screens because the screen cylinders are commonly located off the river bottom mounted on a central intake pipe as shown in the figure below (shown with an active airburst system for removing small debris and silt from the screens) (TDD, 2014, p. 6-22).”*

Dredging would be required for the construction phase. Maintenance dredging would potentially be required depending on how much margin is provided above and beyond the required half-screen diameter between the river bed and the bottom of the screen. Given the shallow water depth at times for this site, it may be difficult to obtain ample margin in this location; thus, periodic maintenance dredging would also be expected.

7. Page 114: *“As a result, EPA rejects PSNH’s 2014 proposal of wide-slot wedgewire screens (9.5 mm), as presented in the Enercon, 2014 report, as a possible BTA for reducing entrainment mortality at Schiller Station because such screens would be of limited value for reducing entrainment.”*

The 9.5 mm wedgewire screens were not proposed as BTA for entrainment, they were proposed to comply with the BTA standard for impingement only. This was based on the understanding at the time that only impingement would be considered in the technology evaluation since the Station had an AIF of less than 125 MGD.

8. Page 116, Table 9-B shows that 1.0 mm wedgewire screens have an effectiveness of 11.5 percent as compared to the rest of the screen sizes that have >80 percent effectiveness.

11.5 percent is based on the understanding at the time the 2008 Response was prepared that the entrainment reduction performance of narrow slot WWS was based primarily on the screens functioning to physically exclude eggs and larvae if their limiting dimensions were larger than the slot width. As stated above, larger slot sizes will have higher effectiveness when considering other mechanisms such as hydraulic bypass and behavioral avoidance of actively swimming larvae as documented in Appendix 3 of this report.

9. EPA does not appear to have a basis in stating that the fine mesh wedgewire screens will not simply convert entrainment into impingement. EPA states that they have no information to assess what happens to the eggs and larvae once they come into contact with the screens. At the top of Page 117, EPA states that due to the passing currents, they would expect fish eggs to be swept off if they contact the outer surface of the CWW screen because the sweeping flows run along the length of the cylinder, and not perpendicular to the screen mesh as is typical for standard traveling screens. EPA’s unsubstantiated expectations are insufficient. The agency must confirm that requiring the costly CWWS at Schiller Station will provide sufficient net benefit.

#### Impingement and Entrainment Impacts

10. Page 91, Section 8.2.1, first paragraph. The description of entrainment studies is incorrect. Nets were not hung outside of Screen House #2 to collect entrainment abundance samples. Section 2.1 of the methods of the 2008 Biological Report clearly state “Entrainment samples were collected through a 0.300 mm mesh plankton net suspended in a barrel sampler located outside of the Schiller Station Screen House #2 (Figure 2-2). Entrainment samples were collected from a 4-inch raw-water tap drawing un-chlorinated ambient cooling water at low pressure (about 15 psi) from a common service water feed line that taps into both the Unit 5 and Unit 6 circulating water pumps on the condenser side of the pumps.”

However, a pump and net rig suspended in a tank in the water was used for control sample collection of source water body entrainment survival studies once monthly. It appears that EPA has confused the two different types of entrainment studies and the methods used, which are clearly explained in the methods section of the 2008 Biological Report.

11. Page 92, first paragraph: *“Impingement losses were calculated using design flow, because this represents a worst-case impact analysis.”*

Impingement losses were also shown in Attachment 6 of the 2008 Response at full DIF (125.8 MGD, units 4, 5, and 6 combined) and at all 5% reductions in intake flow from DIF EPA selectively uses the highest abundance numbers for impingement based on design flows as part of their determination for BTA, when current and foreseeable future AIF is 72.4 MGD and is considerably lower than DIF (Section 4.2 of this report).

12. Page 92, fourth paragraph. Sampling was performed before condenser passage in the 2006-2007 entrainment characterization study because the requirements of the now suspended Phase II Rule (July 2004) specified that the 316(b) regulations governed cooling water intake structures, not condenser passage and thermal discharge.
13. Page 93, second paragraph. The EPA states they accept previously provided survival and collection efficiency data for impingement of fish and shellfish at the Station, but they don't consistently use that data as presented in the 2008 Biological Report. Furthermore, the final §316(b) regulations allow exclusion of fragile species, which constitute about 20 percent of the Station's total annual impingement abundance and about 10 percent of the impingement survival abundance, and these organisms do not seem to have been excluded in the impingement mortality evaluations of Schiller Station performed by EPA. Finally, Green Crab (*Carcinus maenas*) should not be considered in any impingement or entrainment calculations or evaluation of the performance of technologies or operational measures to reduce entrainment or impingement due to their status as an invasive species.
14. Pages 93 and 94, Table 8-A and 8-B of the draft fact sheet. The entrainment of fish (Table 8A) and macrocrustaceans (Table 8B) losses reported in these tables do not match the corresponding values presented in the 2008 Biological Report (Normandeau 2008). It is unclear what CWIS flows the abundance data presented in Tables 8A and 8B are based on. Table 3-8 and 3-13 of the 2008 Biological Report (Normandeau 2008) shows total annual entrainment abundance of fish (Table 3-8) and their adult equivalents (Table 3-13) for fish based on AIF during the 2006-2007 study at Units 4, 5 and 6 combined of Schiller Station as 145,554,178 total individuals among all species and life stages (Table 3-8), and 673,725 equivalent adults (Table 3-13). Similarly, for macrocrustaceans based on AIF during the 2006-2007 study at Units 4, 5 and 6 combined of Schiller Station, Table 3-10 of the 2008 Biological Report shows total annual macrocrustacean

entrainment abundance as 1,305,064,062, and their equivalent adult entrainment abundance as 145,685 (Table 3-15).

#### Use of Equivalent Adult and Absolute Numbers

15. Page 95 and 96, Table 8-C and 8-D. Losses for impingement abundance values for fish and macrocrustaceans are not based on adult or age equivalents, and do not remove fragile species as specified by the §316(b) regulations. Furthermore, the values found in these tables do not match the 2008 Biological Report report for design or actual flows.
16. Page 115, third paragraph and Footnote 35: *“PSNH’s consultants estimated the number of eggs and larvae that would be excluded by wedgewire screens with different slot sizes (see Table 9-A above). However, these values are based on adult equivalents.<sup>35</sup> EPA considers adult equivalents, but also focuses on absolute loss numbers of eggs and larvae when making control decisions. Basing decisions solely on adult equivalents would ignore the valuable ecological role eggs and larvae play in the food chain.”*

*“<sup>35</sup> An adult equivalents analysis estimates the number of adult fish of a certain age that a particular number of eggs and larvae would produce based on certain assumptions about the normal development and survival of the early life stages of each species.”*

The EPA supports the use of absolute loss numbers citing the valuable ecological role eggs and larvae play in the food chain. However, the eggs and larvae entrained by the Station are not consumed by the Station, but are returned to the Piscataqua River where their biomass and organic carbon will continue to play a role in the estuarine ecology. The EPA does not assess the benefit these returned eggs and larvae have to the food web, but instead utilizes absolute numbers and not their equivalent adult values which misrepresent the contribution of different life stages to their assessment of impact the Station has on the Piscataqua River. As discussed in the Section 3.4 of the report above, impact evaluations and comparisons of technologies for reducing entrainment or impingement that act differentially on different life stages of organisms should all be based on equivalent adults.

Moreover, in assessing the use of wedgewire screens, the EPA relies on the equivalent adult calculations provided in Table 9-A of the draft fact sheet. Use of equivalent adult information is necessary as entrained organisms in different life stages are assigned different values in a benefits valuation study. In Tables 10-A and 10-B included later in the draft fact sheet, the EPA utilizes absolute loss values without addressing the difference in life stage value or the benefit of returned eggs and larvae to the Piscataqua River. Therefore, the conclusions reached by the EPA based on the use of absolute numbers solely need to be revisited to address these inconsistencies.

17. Page 134, Table 9-C. The comparisons being made as part of this table cannot be properly performed without using equivalent adults, due to different life stages present in the different months.

#### Representative Important Species (RIS)

18. Page 57, Table 6-C. EPA's 1977 draft guidance document describes the following rationale for selecting representative important species (RIS): (1) it is not possible to study in great detail every species at a site; there is not enough time, money, or expertise; (2) since all species cannot be studied in detail, some smaller number will have to be chosen; (3) the species of concern are those casually related to power plant impacts; (4) some species will be economically important in their own right (e.g., commercial or sport fishes or nuisance species) and thus "important"; (5) some species, termed "representative", will be particularly vulnerable or sensitive to power plant impacts or have sensitivities of most other species and, if protected, will reasonably assure protection of other species at the site; (6) wide-ranging species at the extremes of their ranges would generally not be considered acceptable as "particularly vulnerable" or "sensitive" representative species, but they could be considered as "important"; (7) often, all organisms that might be considered "important" or "representative" cannot be studied in detail, and a smaller list (e.g., greater than one but less than 15) may have to be selected as the "representative and important" list; (8) often, but not always, the most useful list would include mostly sensitive fish, shellfish, or other species of direct use to man or for structure or functioning in the ecosystem; and (9) officially listed "threatened or endangered species" are automatically "important".

The list of 11 fish species and one macrocrustacean (American Lobster) identified by EPA in Table 6-C on Page 57 of the draft fact sheet contains too many fish species with duplicate life histories to be consistent with the rationale provided above. For example, EPA's Table 6C includes three clupeid fish species (Alewife, Blueback Herring and Atlantic Herring), and the two anadromous fish species (Alewife and Blueback Herring) are virtually indistinguishable by anglers, commercial fisherman, and fishing and harvest regulations, and these two "river herring" also share similar phylogeny with Atlantic Herring. To be consistent with EPA's rationale for selecting RIS, we recommended that the following seven RIS be considered for Schiller Station as candidate RIS: Cunner, Rainbow Smelt, Atlantic Mackerel, Winter Flounder, Atlantic Sturgeon, Atlantic Herring, and American Lobster. Essential Fish Habitat (EFH) species can be addressed separately, but that EFH classification does not automatically make them RIS.

### Outfall Requirements

19. Page 20, Outfalls 002, 003, and 004: *“PSNH has requested that the temperature limits be increased from 95°F/25°C to 100°F/30°C.”* This statement is also found on Page 77.

All listed temperature values should be in units of Fahrenheit, not Celsius.

20. Page 21, Internal Outfall 016: *“Based on the historical compliance record, PSNH requests the monitoring frequency for oil and grease, total suspended solids, iron and copper for Outfall 016 be reduced to monthly.”*

Iron and copper limits no longer apply to Outfall 016 per Section 6.3.7 and 6.3.8.

21. Page 29, Rain pH: *“Based upon historical compliance, PSNH requests the monitoring frequency at this outfall be reduced to quarterly. EPA has granted this request, as reflected in the draft permit.”*

Page 20-21, Outfall 011: *“Rainfall pH is also recorded to compare to effluent readings. Based upon historical compliance, PSNH requests the monitoring frequency be reduced to quarterly and the pH sampling be reduced to a single grab from any of the three pipes.”*

The monitoring frequency of rain pH per Page 6 of the Permit (Note 1) currently states, *“Rainfall pH shall be monitored when the discharge is monitored and shall be reported as an attachment to the monthly DMR.”* However, the discharge limitations and monitoring requirements (DLMR) table on Page 5 of the Permit indicates that not all effluents are to be monitored quarterly. Thus, additional clarification needs to be added to the Fact Sheet and/or the Permit as to when rain pH for Outfall 011 should be monitored.

### Pollutant Descriptions

22. Page 195, Effluent Characteristic table: This table lists “Total Residual Chlorine” as a pollutant, while all similar tables found in the body of the Fact Sheet and Permit list “Total Residual Oxidants”. Revise for consistency.
23. Page 208: Same comment as above. Also, there is additional discussion below the table about total residual chlorine. This is inconsistent with similar discussions found in the Fact Sheet about the discharging of total residual oxidants. Revise for consistency.

### Financial Feasibility

24. Page 157: *“Closed-cycle cooling is an entrainment mortality reduction option open to Schiller Station. It is both technically and financially feasible.”* Financially feasible is not defined by the EPA in this document.



### Estimating BTA Costs

25. Page 149: Cost figures should be presented in 2015 dollars.

### Fish Return Conduits

26. Page 104, Section d, second paragraph: There is no basis for stating that re-impingement of fish is likely to occur at Screen house #2.

### Editorial

27. The following are editorial / formatting comments found throughout the document:

- There is extra space between the Section 6.3.4 heading and the preceding paragraph.
- Page 59, Striped Bass: Both of the parenthetical citations in this paragraph have periods before and after the parenthesis. The period before the parenthesis can be removed.
- Page 60, Atlantic Cod: “*Adapted for bottom feeding, they inhabit rocky bottoms but may occasional feel on herring in the water column.*”
  - Change to “...but may occasionally feed on herring...”
- Page 61, American Lobster: See Comment a. above regarding one parenthetical citation in this paragraph.
- Page 93: “*Entrainment losses of ichthyoplankton peaked in July, with a much smaller peak in the winter (January-March) (Figure 8-1).*”
  - Figure 8-1 shows peaking of ichthyoplankton in June, not July. Update throughout to reflect peaking in June.
- Page 170: “*The Draft Permit includes the following compliance schedule at Part I.A.14.b:*”
  - I.A.14.b should be I.A.13.b.
- Page 210, Heavy Metals: This paragraph talks about the discharge of non-chemical metal cleaning waste into Outfall 016A.
  - Outfall 016A should be Outfall 017 per Section 6.3.7 and 6.3.8.
- Figure 6-2 on Page 52 should be presented as delta T above ambient in three planes (i.e., near-surface, mid, and near-bottom) to better align with the fact sheet text and permit limits.

**Permit**

Outfall Requirements

1. Page 5: *“The effluent from 3 individual pipes combine to create the culverted outfall.”*

A similar statement is needed in the paragraph preceding the DLMR table for Outfall 018 found on Page 11 of the Permit.

**Appendix 2: Survey of Existing Cylindrical Wedgewire Screen Installations in Estuarine Environments**

## Table of Contents

1	Introduction and Scope .....	3
2	Schiller Station (Piscataqua River, NH) .....	5
3	Notable Estuarine CWWs Installations .....	7
	3.1 Westchester Wheelabrator (Hudson River, NY) .....	7
	3.2 IBM Facility (Hudson River, NY) .....	7
	3.3 Brooklyn Navy Yard Cogeneration Facility (Brooklyn, NY) .....	8
4	Other Notable CWWs Installations and Biofouling Issues.....	9
	4.1 Oak Creek Power Plant (We Energies, Milwaukee, WI).....	9
	4.2 Biofouling Issues Demonstrated by Field Testing at Other Stations.....	9
	4.3 Biofouling Issues Related to Percent Open Area of CWW Screens.....	11
5	Conclusions .....	12

## 1 Introduction and Scope

The 2008 Response and 2014 Report identified the deployment of CWWSs in front of the Station's CWISs as one potential technology option that could satisfy CWA Section 316(b). The 2008 Response investigated impingement and entrainment, while the 2014 Report investigated impingement only. The 2008 Response and 2014 Report also concluded that a site-specific study would be required to determine the appropriate wedgewire screen material and slot size to ensure that the screens would be able to withstand the aggressive marine environment without becoming clogged (Ref. 7.1, 7.3). Given that the 2014 CWA Section 316(b) Rule did not require submittal of entrainment-related information for facilities with an AIF rate of less than 125 MGD, Schiller Station was not evaluating entrainment technologies at the time that the draft NPDES permit was received from the EPA. The 2014 Report to EPA (Ref. 7.3) contained a preliminary design for wide-slot wedgewire screens, in addition to several other technologies to address impingement only. Therefore, no pilot study or testing has been performed for wedgewire screens as of this time. In addition, the EPA did not have all of the required information to evaluate CWWSs at Schiller Station because PSNH did not believe it was required to submit information related to entrainment technologies. Without such information, the conclusions derived by the EPA concerning the implementation of narrow slot CWWSs for entrainment reduction are uninformed.

As noted in the 2008 Response (Ref. 7.1), intake structures built along coastal and brackish water ecosystems are subject to extremely aggressive marine life fouling that can quickly and catastrophically impact cooling water screening systems. Specifically, barnacles and numerous species of mollusks could rapidly colonize screening baskets, bars, grates, and meshes, thus impeding the passage of cooling water flow and interfering with the cleaning and operation of the intake screening equipment itself. Moreover, Schiller Station is situated on a brackish water estuary – the lower Piscataqua River estuary – that contains calcareous algae. According to Normandeau, calcareous algae are encrusting algae that coat inert surfaces with cement-like deposits. They are considered primary colonizers in the northwestern Atlantic in that they colonize clean, hard substrates and then attract an entire biofouling community, including macroscopic algae, barnacles, and mussels.

Therefore, in advance of undertaking a site-specific CWWS pilot study at Schiller Station, ENERCON first performed an extensive survey of the estuaries in the relative vicinity of the Station (i.e., in Maine, New Hampshire, Massachusetts, Connecticut, and New York) to obtain and evaluate available information regarding biofouling of CWWSs in an ecologically similar estuarine environment. Based on this initial survey and input from Normandeau, ENERCON determined that there are no CWWS installations on any estuary ecologically similar to the lower Piscataqua River in the relative vicinity of the Station. That is, the type of comparable operational data that would best enable PSNH to determine what measures to use to avoid biofouling at the

Station is not available. ENERCON next identified and evaluated existing CWWS installations currently operating in other estuarine environments in the eastern United States (i.e., in states south of Connecticut), in order to gather additional information that could assist in the design of a site-specific CWWS pilot study at the Station. Analysis of this kind should have been considered by EPA in determining a site-specific BTA for Schiller Station, as fine-mesh wedgewire screens are not in widespread use in these types of environments. This is especially true for CWW screens with a slot size of 0.8 mm, which has been mandated by the EPA.

## 2 Schiller Station (Piscataqua River, NH)

Schiller Station is located in Portsmouth, New Hampshire on the southwestern bank of the Piscataqua River, which forms the boundary between coastal New Hampshire and Maine, and is part of the Great Bay Estuary system (see Figure 2-1). The lower Piscataqua River covers approximately 9.5 square miles, and has a high water volume of  $4.6 \times 10^9$  cubic feet ( $\text{ft}^3$ ) with a tidal prism (i.e., the volume of water that is drawn into the bay from the ocean through the inlet during flood tide) of  $0.8 \times 10^9$   $\text{ft}^3$ . In the vicinity of Schiller Station (within a 0.5 mile radius), the median depth of the river (as defined by area) is 18 ft below MLW; however, the center river channel depths (i.e., the maximum depths) range from 42 ft to 75 ft below MLW. Also, within the lower Piscataqua River, the river has maximum sweeping flow velocities of approximately 4.9 feet per second (fps) during ebb tide and 4.4 fps during flood tide. The peak tidal flows are approximately 117,000 cubic feet per second (cfs) and the average freshwater discharge rate is approximately 1570 cfs (Ref. 7.9).

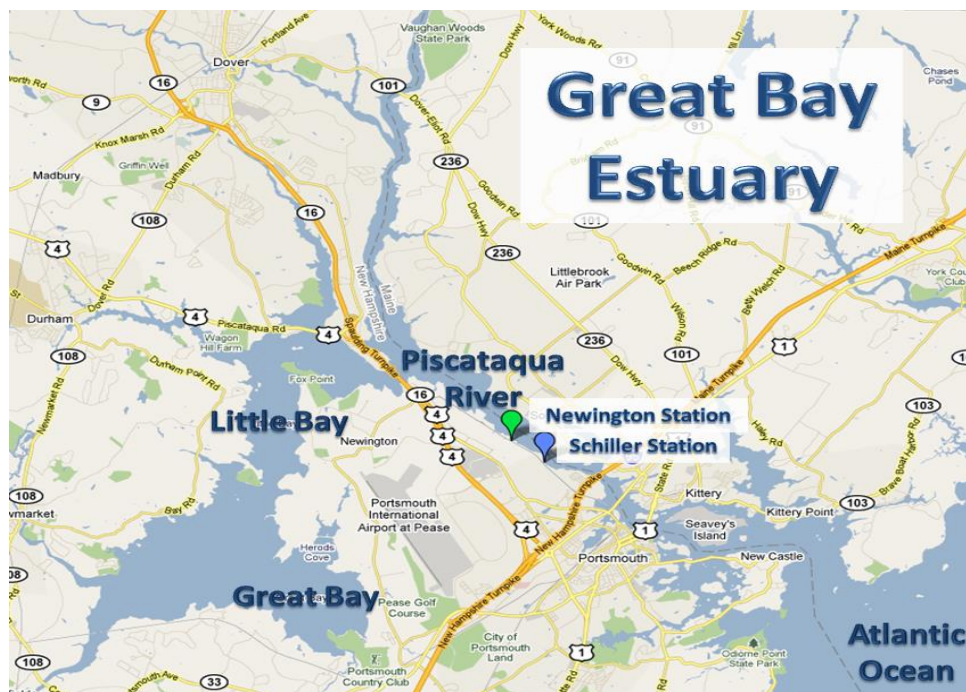

Figure 2-1: Location of Schiller Station on the Piscataqua River

Schiller Station Units 4, 5, and 6 withdraw once-through cooling water from the Piscataqua River via two separate CWISs located on the river. Unit 4 draws water from an intake tunnel that extends approximately 30 ft offshore from the north bulkhead (Screen House #1) and was originally designed to supply water to Unit 3 and Unit 4. The CWIS for Units 5 and 6 is located within the south bulkhead (Screen House #2). The total design flow drawn through the intake at

Schiller Station is 87,290 gpm (29,290 gpm for Unit 4; 29,000 gpm for Unit 5; 29,000 gpm for Unit 6).

Biofouling and clogging is a significant issue of concern for the long term performance of CWWs (Ref. 7.10). As discussed in the 2008 Response (Ref. 7.1), as aquatic organisms and plants grow on such screens, some mesh openings could become blocked, thereby restricting the flow of water through the screen and increasing the velocity through the unblocked portions of the screen. In addition, less open area would result in a higher pressure drop through the screens, which could impair the performance of the Station's circulating water pumps and reduce fish protection.

At Schiller Station, biofouling concerns exist due to existence of calcareous algae in the brackish water of the Piscataqua River. Calcareous algae are encrusting algae that can coat inert surfaces. They are considered primary colonizers in the northwestern Atlantic in that they colonize clean, hard substrates and then attract an entire biofouling community including macroscopic algae, barnacles, and mussels. Although different CWW materials have been successfully used to limit biofouling (e.g., copper-nickel alloy to protect against zebra mussels), it is unknown at this time whether or not these materials could successfully limit the growth of the algae on CWW screens at Schiller Station, especially screens with small slot sizes (currently, copper-nickel alloy is used for the 3/8-inch square traveling water screen mesh).



### 3 Notable Estuarine CWWS Installations

As discussed in Sections 1 and 2, biofouling concerns exist at Schiller Station, especially due to the presence of calcareous algae in the estuary. Although none of the facilities discussed below are located on a waterbody that is sufficiently ecologically similar to the lower Piscataqua River estuary (based on input from Normandeau), each facility uses CWWSs to draw water from an estuary. In addition, these facilities demonstrate a range of flow rates (approximately 38,000 gpm to approximately 60,000 gpm) and CWWS slot sizes (2 mm to 3.2 mm). For example, Westchester Wheelabrator is a waste-to-energy facility that uses 2.0 mm CWWSs in a once-through cooling system, while the IBM facility utilizes 3.2 mm CWWSs to provide cooling water for the facility's HVAC chillers.

#### 3.1 Westchester Wheelabrator (Hudson River, NY)

The Westchester Wheelabrator, formerly known as Charles Point Resource Recovery Facility or Westchester RESCO, is located on the eastern shoreline of the Hudson River. Westchester is a waste-to-energy facility that produces approximately 60 MWe and utilizes a once-through cooling system with a flow rate of approximately 38,000 gpm (55 MGD). The cooling water intake utilizes 2.0 mm CWWSs (Ref. 7.6) installed in the 1980's to draw water at an offshore distance of approximately 800 ft. There are four (4) 54 inch diameter CWWSs constructed of a copper-nickel alloy situated in a 2 x 2 array on T-stands approximately at a nominal depth of 22 ft to the screen centerline. According to discussions with engineers at the site, the CWWSs at the site operate year round and utilize an airburst system that discharges twice daily via timers. A dive team is dispatched annually to visually inspect the screens. If there are local areas of debris buildup identified during the inspection dive, the divers will remove the debris. Flow reductions due to frazil ice were reported to occur during periods of extreme cold temperatures combined with low river water levels. These events were reported to occur every 2-3 years, and flow through the CWWSs is quickly restored without incident by using the airburst system. Significant debris was found to have accumulated during a March 2011 inspection (Ref. 7.19). In addition, debris was observed to have poked a hole in the screen mesh at some point, and a cone-end hatch was found to be open (Ref. 7.20). No other operational issues were reported (Ref. 7.13).

#### 3.2 IBM Facility (Hudson River, NY)

Two 0.125-inch (approximately 3.2 mm) slot CWWSs are installed at the IBM facility in Poughkeepsie, NY and provide Hudson River water for the facility's HVAC chillers. The screens at the IBM facility have a maximum intake flow rate of approximately 60,000 gpm. According to the Facility Engineer, the stainless steel screens were installed in the early-

1980s, operate year round, and equipped with an airburst system that discharges hourly. The CWW screens were removed and inspected in 2004 for potential damage caused by impacts from ice floes. Minor dents and a small quantity of zebra mussels were identified, although the screens were returned to service without rework. Flow through the screens is maintained using the airburst system. No significant fouling issues were reported, although icing reportedly occurs during winter months. To ensure operational reliability, the design include a bypass system, by which the original traveling water screens can be used to provide flow in the event of screen blockage (Ref. 7.11).

### **3.3 Brooklyn Navy Yard Cogeneration Facility (Brooklyn, NY)**

The 286 MWe combined cycle cogeneration plant is located on the Brooklyn, NY shore of the East River, adjacent to the Brooklyn Navy Yard Basin in the section of the East River known as Wallabout Bay. The facility uses water withdrawn from the Brooklyn Navy Yard basin for once-through cooling. The cooling water intake structure consists of an intake building at the shoreline, four cylindrical 2.0 mm slot wedgewire screens projecting from the bulkhead, and a protective grating surrounding the screens. From there, cooling water flow is provided by up to three circulating water pumps in the intake building (Ref. 7.14).

## 4 Other Notable CWWS Installations and Biofouling Issues

### 4.1 Oak Creek Power Plant (We Energies, Milwaukee, WI)

Oak Creek Power Plant in Milwaukee, Wisconsin is located on Lake Michigan (a freshwater lake) and operates the largest installation of CWWSs. It has four operating units online that generate a total of 1135 MWe. The Oak Creek CWWS system includes an offshore intake system situated approximately 6000 to 7000 ft from the shoreline at a depth of approximately 43 ft. According to Oak Creek, the CWWS became operational in January 2009 and is designed to operate year round. The offshore intake system uses twenty-four (24) 8 ft diameter CWWSs with a slot size of approximately 9.5 mm to filter a flow rate of 1,560,000 gpm (2,246 MGD). The system at Oak Creek was designed to provide a through-screen velocity at or below 0.5 fps and was oversized by approximately 16 percent (3 additional screens) to provide margin against fouling.

Johnson Screens, a leading CWWS manufacturer, supplied Oak Creek's CWWSs. The entire screen assemblies are manufactured from copper-nickel alloy. The screens are mounted to four manifolds; six screens per manifold. The manifolds are connected to drop tunnels that discharge into a single transmission tunnel that flows towards the shoreline into the plant's wetwell. The transmission tunnel was bored into the bedrock and has a total length of 9200 ft. Cooling water from the wetwell is subsequently pumped to the condenser of each Unit. The design includes a bypass system to ensure water can be provided to the plant in the event of screen blockage (Ref. 7.21).

Due to the distance of the offshore intake to the facility, Oak Creek's CWWS system is not equipped with an airburst system; however, fouling of the screens is not a significant concern based on the characteristics of the source waterbody (i.e., Lake Michigan). These wedgewire screens experienced failure of sub-components within the screen due to hydrostatic pressure buildup of 10-12 times the design amount because of ice buildup on some of the screens (Ref. 7.15, 7.21).

### 4.2 Biofouling Issues Demonstrated by Field Testing at Other Stations

Site-specific testing of fine mesh (0.5 – 1.0 mm) CWWSs has exhibited fouling issues as discussed below. The State of Maryland conducted testing in 1982 and 1983 of 1.0, 2.0, and 3.0 mm CWWSs at the Chalk Point Generating Station, which withdraws water from the Patuxent River in Maryland. The 1.0 mm CWWSs were found to reduce entrainment by 80 percent; however, some biofouling and clogging was observed during the tests.

In addition, in the late 1970s, Delmarva Power and Light conducted field testing of fine mesh CWWSs for the proposed 1540 MW Summit Power Plant. Summit Power Plant was to be

located south of the Chesapeake and Delaware Canal (the canal connects the waters of the Delaware River with those of the Chesapeake Bay and the Port of Baltimore) in New Castle County, Delaware, but was later cancelled. Field testing in the brackish water of the proposed intake canal required the screens to be removed and cleaned as often as once every three weeks (Ref. 7.6).

The biofouling issues demonstrated by field testing are emphasized in EPA's Technical Development Document:

*The Agency is not aware of any fine-mesh wedgewire screens that have been installed at power plants with high intake flows (>100 MGD). However, they have been used at some power plants with lower intake flow requirements (25-50 MGD) that would be comparable to a large power plant with a closed-cycle cooling system. With the exception of Logan, the Agency has not identified any full-scale performance data for these systems. They would be even more susceptible to clogging than wide-mesh wedgewire screens (especially in marine environments). It is unclear whether this simply would necessitate more intensive maintenance or preclude their day-to-day use at many sites. Their successful application at Logan and Cope and the historic test data from Florida, Maryland, and Delaware at least suggests promise for addressing both fish impingement and entrainment of eggs and larvae. However, based on the fine-mesh screen experience at Big Bend Units 3 and 4, it is clear that frequent maintenance would be required. Therefore, relatively deep water sufficient to accommodate the large number of screen units, would preferably be close to shore (i.e., be readily accessible). Manual cleaning needs might be reduced or eliminated through use of an automated flushing (e.g., microburst) system. [Ref. 7.12]*

The Electric Power Research Institute (EPRI) has also noted these issues:

*Several full-scale CWIS applications of cylindrical wedge-wire continue to perform satisfactorily. However, these applications employ coarse bar spacings (10 mm). Therefore, other than the existence of encouraging data from small-scale laboratory and pilot field facilities, there is still little information on the use for this technology for protecting early life stages. The potential use of 0.5- to 2.0-mm bar spacing to protect early life stages of fish (particularly eggs and early larvae) has not been evaluated at a CWIS. Therefore, larger-scale pilot studies are needed to identify the full biological potential of these screens. Also, there is a need for further research into biofouling control before the potential applicability of wedge-wire screens can be fully assessed. Biofouling, particularly on internal surfaces that are not readily accessible, remains a concern with both large and small slot sizes. Results of small-scale field studies conducted primarily in the 1970's and 1980's have shown that substantial fouling can occur over time in all types of water. A concern that has arisen in fresh water environments since the last wedge-wire studies were conducted is the zebra*

*mussel. Assuming that biofouling can be controlled, the only environment in which use of cylindrical wedge-wire screens may not be practicable is one without an ambient cross-current to carry passive organisms and backflushed debris away. [Ref. 7.4]*

### 4.3 Biofouling Issues Related to Percent Open Area of CWW Screens

As discussed in Section 4.2, the empirical results of in-situ studies show that biofouling can be expected to increase as slot size decreases. From an engineering perspective, this trend is consistent with the physical configuration of fine mesh screens. According to Johnson Screens, the dimensions of the wire used in CWWs vary with screen diameter and material rather than slot size (i.e., screens of the same diameter and wire material would utilize the same size wire for all slot widths). Therefore, the percent open area would be much smaller for fine mesh CWWs, as shown in Table 4.1.

Table 4.1: Typical Percent Open Area of CWWs by Slot Size

	1.0 mm	2.0 mm
#63 Wire <i>Standard Intakes</i>	39.62%	56.75%
#69 Wire <i>Large-Diameter (≥ 7 ft) Intakes</i> <i>Z-Alloy Intakes</i>	35.67%	52.58%
#93 Wire <i>Large-Diameter (≥ 7 ft) Intakes</i> <i>Z-Alloy Intakes</i>	30.67%	46.94%

Dimensions provided by Johnson Screens

Percent open area is an important parameter affecting the risk of biofouling. Biofouling organisms first attach to a solid piece of screen. As the organisms grow, the thickness of the biolayer decreases the open portion of the screen. Therefore, a screen with a greater percentage of solid wire (i.e., smaller percent open area) will provide space for a greater number of organisms to attach themselves; the resulting biolayer will obstruct the percent open area of the screen at a faster rate (Ref. 7.16). In addition, biofouling organisms will bridge the gap between solid portions of the screen to block flow completely. Testing of traveling water screens in marine environments has shown better hydraulic performance for the larger mesh screens (about 2 mm x 70 mm) compared to the smaller mesh screens (about 1 mm x 15 mm), due to reduced ability of the dominant amphipods to bridge the larger openings and restrict flow in the larger mesh screens (Ref. 7.16).

## 5 Conclusions

Biofouling and icing concerns have been documented historically for fine-mesh screens and warrant additional consideration in their selection as BTA. At Westchester Wheelabrator (2 mm) flow reductions were reported to occur every 2-3 years due to frazil ice, and several accumulations of debris were reported; however, flow through the CWWs was able to be restored using the airburst system. No significant biofouling issues were reported by any of the facilities discussed in Section 3 above; however, as noted, none of the discussed facilities were located in an area with environmental conditions identical to Schiller Station. Biofouling has been shown to be a concern for fine-mesh screens in the 0.5 – 1 mm range. Therefore, the potential for biofouling or icing should be considered further in selection of BTA for entrainment, including potentially increasing the slot size.

To address potential biofouling concerns, consideration of CWWs with small slot dimensions for CWIS application should include prototype scale studies to determine potential biological effectiveness and identify the ability to control clogging and fouling in a way that does not impact station operation. As discussed in Sections 3 and 4, there is no industry experience or operational data to determine what measures to use to avoid extensive biofouling at Schiller Station. As a result, it is important any site-specific test give particular attention to biofouling. In addition, it is shown that smaller slot sizes provide a greater chance for biofouling issues.

Given the site-specific conditions at Schiller Station, and given that there is no similar experience in the industry, the slot size should be determined based on a pilot testing, with preference given towards the slot sizes that do not experience biofouling or icing issues. The smallest slot size may not be the most effective technology for reducing entrainment if the operational reliability is poor, and frequent bypass is required.

The 0.8 mm slot size required in the permit does not have sufficient basis with the currently available information. Available operating experience suggests that slot sizes of 2 mm or above have the best likelihood for demonstrating acceptable performance, while testing has shown that biofouling may potentially be a concern at smaller slot sizes. Therefore, based on the industry experience and knowledge base, a slot size of 2 mm or greater is recommended.



# Appendix 3

## Potential Entrainment Reduction for Cylindrical Wedgewire Intake Screens at Schiller Station, Incorporating a Length- Based Wedgewire Avoidance Model

**Prepared For:**  
Public Service Company of New Hampshire  
D.B.A. Eversource Energy  
780 North Commercial Street  
Manchester, New Hampshire 03105

**Submitted On:**  
January 2016

**Prepared By:**  
Normandeau Associates, Inc.  
25 Nashua Road  
Bedford, NH 03110

[www.normandeau.com](http://www.normandeau.com)

## Table of Contents

	Page
<b>1 INTRODUCTION .....</b>	<b>1</b>
<b>2 APPLICABILITY OF FISH AVOIDANCE BEHAVIOUR TO COOLING WATER INTAKE STRUCTURES .....</b>	<b>2</b>
<b>3 EVIDENCE OF LARVAL AVOIDANCE.....</b>	<b>3</b>
3.1 LABORATORY STUDIES .....	3
3.2 FIELD EXPERIMENTS.....	5
3.3 PERFORMANCE OF FULL-SCALE CYLINDRICAL WEDGEWIRE SCREENS .....	9
<b>4 LENGTH-BASED AVOIDANCE MODEL .....</b>	<b>10</b>
4.1 VARIABLE DEFINITIONS.....	10
4.2 ESTIMATION OF WEDGEWIRE AVOIDANCE FACTORS.....	11
<b>5 APPLICATION TO SCHILLER STATION.....</b>	<b>15</b>
5.1 APPROACH .....	15
5.2 RESULTS .....	17
<b>6 DISCUSSION .....</b>	<b>18</b>
6.1 EQUIVALENT ADULT LOSSES .....	18
6.2 CWW SCREEN PERFORMANCE .....	18
<b>7 REFERENCES .....</b>	<b>19</b>



## List of Figures

	Page
Figure 1. Effectiveness of Wedgewire Screen orientation (reproduced from EPRI 2003).....	23
Figure 2. Observed and predicted proportion of Bay Anchovy larvae entrained based on the greatest body depth (GBD) measurements for a 2 mm slot width cylindrical wedgewire screen. ....	23
Figure 3. Observed wedgewire avoidance factors by length, species, and slot width, with a generalized relationship between larval length and wedgewire avoidance factor. ....	24

## List of Tables

	Page
Table 1. Data used to fit a generalized curve for estimating wedgewire avoidance as a function of length (plotted in Figure 1). .....	25
Table 2. Physical exclusion factors used in the Schiller Station wedgewire screen entrainment reduction analysis, by taxon, life stage, and slot width. ....	26
Table 3. Schiller Station monthly and annual estimates of fish entrainment abundance and equivalent adult losses calculated from 2006-2007 entrainment densities by fish species and life stage and applied to actual intake flows (AIF) from 27 August 2012 through 26 August 2015 for cylindrical wedgewire intake screens of various slot widths, under the most conservative assumption of no active avoidance of the screens by fish larvae (i.e., Equation 1). ....	27
Table 4. Schiller Station monthly and annual estimates of fish entrainment abundance and equivalent adult losses calculated from 2006-2007 entrainment densities by fish species and life stage and applied to actual intake flows (AIF) from 27 August 2012 through 26 August 2015 for cylindrical wedgewire intake screens of various slot widths, under a moderately conservative assumption of active avoidance of the screens by 30% of the fish larvae (i.e., Equation 3 with $P_a = 0.3$ ). ....	29
Table 5. Schiller Station monthly and annual estimates of fish entrainment abundance and equivalent adult losses calculated from 2006-2007 entrainment densities by fish species and life stage and applies to actual intake flows (AIF) from 27 August 2012 through 26 August 2015 for cylindrical wedgewire intake screens of various slot widths, under the realistic assumption that avoidance of the screens by fish larvae increases as the larvae grow longer (i.e., Equation 7).....	31

## 1 Introduction

---

Public Service of New Hampshire's (PSNH's) Schiller Station in Portsmouth, New Hampshire, received a draft National Pollutant Discharge Elimination System (NPDES) permit (Permit NH0001473) from the United States Environmental Protection Agency (EPA) on September 30, 2015. When final, this draft NPDES permit will supersede the permit for the Station issued on September 11, 1990. This draft NPDES permit and accompanying draft fact sheet were based in part on information supplied by the Station at the request of the EPA. On October 31, 2007, the EPA issued an information request letter to Public Service of New Hampshire (PSNH) under Section 308 of the Clean Water Act (CWA) (2007 §308 Letter) regarding Schiller Station's compliance with CWA §316(b) ("the Rule"), 33 U.S.C. §1326(b). In this 2007 §308 Letter, the EPA requested certain technology and operational information from PSNH to support the EPA's development of the new NPDES permit for the Station. In October 2008, PSNH submitted a response (2008 Response) to this 2007 §308 Letter, prepared jointly by Enercon Services, Inc. (ENERCON) and Normandeau Associates, Inc. (Normandeau). The 2008 Response evaluated the engineering feasibility of certain cooling water intake structure (CWIS) technologies and operational measures that would be generally expected to reduce impingement and/or entrainment at the Station. Impingement and entrainment abundance and mortality studies were performed by Normandeau at the Station from September 2006 through September 2007 at the request of the EPA in a December 30, 2004 §308 Letter. These studies were performed according to a reviewed and approved (by the EPA) study plan, and the results were provided to the EPA in a biological report dated April 2008 (2008 Biological Report). The impingement and entrainment data presented in the 2008 Biological Report were used to prepare Attachment 6 of the 2008 Response.

Based on EPA's narrative and rationale specified in the draft fact sheet and draft NPDES permit for Schiller Station, it appears that EPA relied primarily on the 2008 Response, and specifically the information in Attachment 6 of the 2008 Response, to prescribe narrow-slot cylindrical wedgewire (CWW) screens as condition 13.a.1 of the draft NPDES permit. Although the analysis presented in Attachment 6 of the 2008 Response revealed that the alternative technology of narrow-slot CWW intake screens had the potential to substantially reduce entrainment of fish eggs and larvae of Schiller Station, particularly at slot widths less than 1.0 mm, substantial new information has become available in the nearly seven years since the 2008 Response was written that should be considered by EPA in their evaluation of narrow slot CWW screens requirements for Schiller Station.

In Attachment 6 of the 2008 Response, the estimated reduction in the numbers of ichthyoplankton entrained, in terms of the equivalent numbers lost to the adult fish community, ranged from 73% at a slot width of 1.0 mm to 99% at a slot width of 0.6 mm, compared to entrainment through the existing 9.5 mm (3/8 inch) mesh intake screens. Those Attachment 6 estimates were calculated solely on the basis of newly installed CWW screens operating throughout the year and functioning solely by physical exclusion to reduce entrainment by preventing the entrainment of organisms that are too large to fit through the narrow slots of the CWW screens. Attachment 6 of the 2008 Response also alluded to a second way that CWW screens can reduce entrainment and impingement: "the cylindrical

shape of the screen makes it easier for the fish to swim away before they become impinged". The contribution of active avoidance of CWW screens by the fish was not, however, factored into the entrainment reduction estimates presented in Attachment 6 of the 2008 Response.

The substantial new information developed since Attachment 6 of the 2008 Response was prepared reveals the entrainment reduction performance of narrow slot CWW screens is based on more than just physical exclusion of entrained organisms too large to fit through the narrow slot widths. The purpose of this Appendix 3 evaluation is to present this substantial new information to EPA for consideration if entrainment reductions are required in a revised NPDES permit and fact sheet for Schiller Station. In this Appendix 3 we review and describe the published and publically available evidence that, under certain installation and operational configurations available at Schiller Station, the entrainment reduction performance of narrow slot CWW screens is a function not just of physical exclusion, but is improved by hydraulic bypass and active larval swimming avoidance by larvae.

In Section 2.0, the possibility that fish as small as post yolk-sac larvae can avoid CWW screens is explored conceptually with respect to what is known about the swimming capability of fish larvae, in the context of the scale and geometry of power plant intake screens. In Section 3.0, the laboratory and field evidence for larval avoidance of wedgewire screening is reviewed. In Section 4.0, a quantitative relationship of increasing avoidance with increasing larval size is presented, supported by published and publically presented data. In Section 5.0, a simple length-based avoidance relationship is applied to the Schiller data to revise the previously presented estimates of the entrainment impact reduction potential of CWW screens.

## 2 Applicability of Fish Avoidance Behaviour to Cooling Water Intake Structures

---

The concept that fish larvae cannot avoid power plant intakes applies primarily to conventional intake structures. It is a matter of scale and geometry. Compared to the physical dimensions of an intake bay at a typical power generating facility, a fish larva is miniscule. Although the burst swimming speed of a fish larva might be faster than the speed of the current flowing through the intake bay toward the screen, the larva's average swimming speed over time (averaging the motionless periods and the occasional bursts) will almost certainly be slower than the intake current. A single burst of swimming, even several bursts, will not move a larva very far in relation to a space the size of a typical power plant intake forebay. By the time a larva has been transported by the intake flow close enough to a screen to evoke evasive swimming behavior it is too late to avoid entrainment. The escape distance is impossibly far for such a small organism with such limited swimming powers. Therefore, for a conventional intake with vertical traveling screens recessed within a forebay, the chance of a fish larvae escaping by swimming to the side of the intake bay or swimming upcurrent away from the screen is essentially nil.

CWW screens, however, have a fundamentally different geometry from that of conventional intake screens, particularly with respect to intake currents. If a CWW screen is installed in a sweeping current with the slots of the wedgewire screen material aligned radially along the circumference of each cylinder (Figure 1, right image), and thus are perpendicular to the

long axis of the cylinder, and because the typical installation of a T-type of CWW screen is with the long axis parallel to the ambient current of the source water body, the escape distance for a fish larva encountering a CWW screen is much shorter than in a conventional intake bay (Figure 1, right image). Immediately surrounding the sides of a CWW screen there is a “withdrawal zone” or “zone of hydraulic influence,” within which the flow streamlines curve inward where the cooling water enters the screen (EPRI 2003; 2012). Outside of that withdrawal zone, the ambient current or sweeping flow moves past the CWW screen unimpeded. A fish larva only needs to swim far enough away from the CWW screen’s surface to enter the bypass flow outside of the withdrawal zone and into the ambient sweeping flow to be transport beyond the CWW screen and avoid entrainment. The thickness of the withdrawal zone depends on the length of the CWW screen and the relative velocities of the through-slot (“intake”) flow and the ambient (“sweeping”) flow (EPRI 2003). As the sweeping flow increases in relation to the intake flow, the thickness of the withdrawal zone decreases. Schiller Station is located in the Piscataqua River, which has renowned strong tidal currents peaking at a maximum sweeping velocity of 4.9 feet per second (fps) during ebb tide and 4.4 fps during flood tide. Therefore, sweeping flows at Schiller Station are likely to minimize the thickness of an installed CWW screen’s withdrawal zones, and allow hydraulic bypass and behavioral avoidance to contribute significantly to the entrainment reduction performance of installed CWW screens compared to physical exclusion.

## 3 Evidence of Larval Avoidance

---

### 3.1 Laboratory Studies

In a laboratory flume, (Hanson *et al.* 1977) tested the entrainment of Striped Bass larvae through a 1.0-mm slot width CWW screen, 12 inches in diameter and 24 inches long. Hatchery-reared larvae from four days old (5.2 mm TL) to 19-20 days old (7.8-9.2 mm TL) were tested at slot velocities up to 0.5 ft/s. Test larvae were released inside a mesh enclosure surrounding the screen under static conditions (no flume flow). Avoidance behavior was observed in all experiments. Despite their resistance behavior to entrainment, all were eventually entrained. A high percentage was usually entrained in the first minute, but 100% entrainment was not reached in some tests until about 10-20 min. Resistant behavior was generally poor at the lowest slot velocities and increased to fair at 0.5 ft/s. Larvae would often be passively entrained unless they contacted the screen. When larger larvae (10-33 days old, 8.0-17.0 mm TL) were tested at slot velocities from 0.5 to 1.5 ft/s, resistance improved and entrainment decreased. Frequent but temporary impingements of the larger larvae were observed. This study demonstrated that under the unfavorable condition of being corralled near the screen inside a mesh enclosure without the benefit of a sweeping flow, the larvae still exhibited avoidance behavior for varying intervals of time before eventually succumbing to entrainment.

Heuer and Tomljanovich (1978) conducted laboratory tests in a flume with a portion of the flow withdrawn through vertically-positioned or horizontally-positioned flat wedgewire screen panels. The study compared 0.5, 1.0, and 2.0 mm slot widths at three through-slot velocities (7.6, 15.2, and 22.9 cm/s) and four “bypass” (flume) velocities (7.6, 15.2, 30.5, and 61.0 cm/s). Ichthyoplankton species tested were Striped Bass, Largemouth Bass,

Smallmouth Bass, Bluegill, Walleye, Channel Catfish, and Muskellunge. About 100-200 larvae were released in each trial, uniformly distributed throughout the cross-section of the flume and counts were made of the larvae entrained and those recovered downstream. Proportions of larvae entrained were significantly lower than the proportion of the flow entrained, demonstrating active avoidance by the larvae. In addition to statistically verifying the existence of avoidance behavior, the thorough experimental design provides useful quantitative data for relating the degree of avoidance to the various experimental factors (data which are analyzed further in Section 4.2 below).

Hanson (1981) reported the results of additional flume tests using Striped Bass and Yellow Perch larvae with the 1-mm CWW screen, this time mostly under dynamic conditions (with flow through the flume and without enclosures). Test larvae were released midstream, 1.2 m upstream of the screen. The 12-inch diameter CWW screen was oriented with its axis perpendicular to the flow. Some larvae sought the bottom or scattered throughout the water column, thus escaping the screen's withdrawal zone before the flow reached the screen. Among the larvae that did remain within the screen's withdrawal zone, some were passively entrained while others quickly swam away after coming within 6 mm of the screen. About half of the Striped Bass larvae that came into contact with the screen successfully escaped.

Another flume study tested entrainment and impingement of larval Striped Bass, Winter Flounder, White Sucker, Rainbow Smelt, Yellow Perch, Common Carp, and Bluegill on 1-foot-diameter, 44-inch-long CWW screens with 0.5, 1.0, and 2.0 mm slot widths, oriented both perpendicular and parallel to the flume flow, at flume speeds of 0.08, 0.15 and 0.30 m/s and slot velocities of 0.15 and 0.30 m/s (EPRI 2003). Test organisms were released from a tube upstream of and close to the screen at its centerline, so all of the larvae were presumed to have been released within the screen's withdrawal zone (vulnerable to entrainment or impingement). When 7-mm larvae (Striped Bass) were exposed to a 1-mm slot width CWW screen oriented parallel to the flume flow (i.e., slots perpendicular to flume flow) and withdrawing water at a slot velocity of 0.15 m/s, only 27% were entrained at a flume velocity of 0.15 m/s and only 15% were entrained at a flume velocity of 0.30 m/s (EPRI 2003). However, most Striped Bass larvae that size are narrow enough to fit through a 1-mm wide opening (Hardy 1978). When 8.3-mm Striped Bass larvae were tested with a 2-mm slot width and 0.15 m/s slot velocity (again with the slot openings perpendicular to the flume flow), the entrainment rates were 61% at 0.15 m/s flume velocity and 46% at 0.30 m/s flume velocity (EPRI 2003), even though at that length nearly 100% larvae are narrow enough to fit through a 2-mm wide opening (Hardy 1978). Overall, the entrainment rates in the EPRI 2003 study were consistently lower than the proportion of larvae that were small enough to fit through the CWW screen slot openings, providing further evidence that larvae are capable of avoiding entrainment through CWW screens (and provided additional data contributing to the analysis in Section 4.2 below).

Normandeau, under contract to Entergy's Indian Point Energy Center, performed extensive and intensive laboratory testing of CWW screens during 2010 and 2011. The reports and performance models prepared for these studies are presently involved in litigation over State Pollutant Discharge Elimination System (SPDES) permit renewal for cooling water withdrawal at the Indian Point Generating Stations (Units 2 and 3) in the Hudson River estuary in New York. Due to the sensitivity of this active litigation, we were unable to

secure permission to apply these latest entrainment reduction performance models to Schiller Station to functionally evaluate the effectiveness of narrow slot CWW screens if installed there. However, a substantial amount of these research findings are available for consideration of narrow slot CWW screen performance at Schiller Station from several public presentations made to EPA Region 1 in New York, New York (Mattson et al. October 2010a), EPA headquarters in Washington, DC (Mattson et al. December 2010b), to the Electric Power Research Institute (EPRI) (Mattson et al. 2015) and Electric Utilities Consultants, Inc. (EUCI) (Mattson et al. 2014a), and before peer audiences at American Fisheries Society (AFS) symposia (Mattson et al. 2011, 2014b).

During the 2010 and 2011 laboratory studies (Mattson et al. 2015), 12-inch and 18-inch diameter CWW screens with slot widths of 2, 3, 6, and 9 mm were tested at flume velocities of 0.25, 0.50, 1.0, 1.5 and 2.0 feet per second (“fps”), with through-slot velocities of 0.25 and 0.50 fps for a total of 24 combinations of slot width, flume velocity, and through-slot velocity representing a total of 4,647 individual tests and more than 450,000 eggs and larvae tested. All CWW screens tested were oriented with the long axis of the cylinder parallel to the flume flow direction and the slots perpendicular to the flume flow. Tests were conducted by releasing neutrally buoyant beads, live and anesthetized larvae Zebrafish eggs, White Sucker eggs, and the larvae of Atlantic Tomcod, Striped Bass, White Sucker, and Striped Bass x White Bass hybrids at a location immediately upstream and exposed to withdrawal in the intake flow of the test screen. The number of the test subjects carried past the screen, entrained through the screen, or excluded and retained on the screen was recorded. Tests were done with both live and dead larvae, and under ambient daylight and ambient nighttime conditions. Length (mm total length) and body depth (mm) were recorded so that performance could be related to fish size. Non-linear models were developed to explain the fate of eggs, larvae or test beads based on the probability of not being entrained due to avoidance as a function of fish length, or being excluded based on the greatest body depth of the fish tested. Non-linear regression fits of these models were developed for each set of test conditions, and then generalized to describe CWW screen performance in general. Non-entrainment due to avoidance was typically higher for the smaller slot sizes of CWW screens tested, and was higher at higher ratios of flume velocity to through-slot velocity. Physical exclusion (applicable to 2 mm and 3 mm slot widths) was higher for the same body depth for dead larvae than for live larvae, likely because live larvae orient themselves with their head into the flow and therefore do not meet the CWW screen face crosswise to the slots. For live larvae, exclusion was reduced as through-slot velocity increased on 2 mm screens, but very little exclusion occurred on 3 mm or larger CWW screens because the limiting dimensions of larvae tested were typically less than 3 mm.

### 3.2 Field Experiments

Browne *et al.* (1981) conducted field tests of 1-mm and 2-mm CWW screens, 30 inches in diameter, mounted perpendicular to the flow in the intake canal of Oyster Creek Nuclear Generating Station in southern New Jersey. Densities of Bay Anchovy larvae entrained through the 1-mm CWW screen were 61% lower than densities entrained through an unscreened control orifice, a difference that was statistically significant. Bay Anchovy averaging 4.2 mm and ranging up to 8.3 mm, as observed in the control samples by Browne *et al.* (1981), have a body depth of less than 1 mm (Jones *et al.* 1978; Mattson et al. 2011). Since the Bay Anchovy were small enough to be entrained through the 1-mm CWW screen,

the 61% reduction in density entrained by that screen would seem to support the laboratory studies indicating larval avoidance of CWW screens. However, entrained densities of most of the other dominant larval taxa collected in the Oyster Creek study, as well as densities of Bay Anchovy larvae entrained through the 2-mm CWW screen, were not consistently lower than densities sampled through the control orifice. Therefore, although the authors considered the results to demonstrate that CWW screens were a “promising intake screening concept,” their results were not overwhelmingly convincing, perhaps because the CWW screens were installed perpendicular and not parallel to the intake canal flow. They did, however, describe encouraging visual observations showing that impingement was very limited and many fish (including 20-25 mm larvae) and invertebrates swam or hovered near the screens without being impinged.

Otto *et al.* (1981) conducted a field test of a 0.9 m diameter, 1-mm slot width CWW screen positioned 1 m above the bottom in 6 m depth of a side channel of the Mississippi River near Savannah, Illinois. The slots were perpendicular to the flow (the axis of the cylindrical screen was parallel to the flow), there were deflection cones on the ends of the screen, and the through-slot velocity design flow was 12 cm/s. Ambient densities were sampled with fixed and towed nets near the test module at a similar depth. Common Carp, Emerald Shiner, and Freshwater Drum were very abundant; clupeids (presumably mostly Gizzard Shad but possibly some Skipjack Herring *Alosa chrysochloris*) and crappies were abundant. Entrained densities of four of the five dominant taxa of larvae (all but crappies) were much lower than ambient densities. Larvae larger than about 7 or 8 mm that consistently occurred in the ambient samples were rare or absent in the entrainment samples. For example, the clupeid larvae entrained were all  $\leq 7.9$  mm, compared to larvae in both kinds of net samples, which caught a few larvae in the 8-15 mm range. Since most 8-12 mm clupeid larvae are  $< 1$  mm in their greatest body depth (Jones *et al.*), which would allow them to fit through the 1-mm slots in the screen, the absence of larvae  $\geq 8$  mm in the CWW screen entrainment samples is a probable indication that the ability of larvae to avoid being entrained improves as they grow longer than 8 mm. Otto *et al.* (1981) attributed the apparent effectiveness of the 1-mm CWW screen in reducing larval entrainment to active avoidance of the larvae, because (1) most larvae were too small to be physically excluded by the screen and (2) entrainment reductions became greater with increasing size and therefore improved swimming ability.

Zeitoun *et al.* (1981) conducted a field study comparing samples pumped through 9.5-mm and 2.0-mm CWW screens at  $\leq 0.5$  ft/s through-slot velocity, unscreened pumped control samples, and net tows at a similar depth (2.3 m) in southeastern Lake Michigan. The 2.0-mm CWW screen was 0.36 m long and 0.46 m in diameter; the 9.5-mm CWW screen was 0.30 m long and 0.38 m in diameter. The dominant larval taxa were Rainbow Smelt, Alewife, Yellow Perch, and cyprinids (other than Carp and Goldfish). Densities were not significantly different among the two screen slot widths and the unscreened pipe, all of which were about an order of magnitude lower than in net samples. The 90% reduction in entrainment densities (compared to the net samples) was attributed by Zeitoun *et al.* (1981) to larval avoidance of the screens. They emphasized that mathematical predictions of entrainment reductions based solely on physical exclusion by narrow slot CWW screens would grossly underestimate the reduction performance. The entrainment reductions reported by Zeitoun *et al.* (1981) were from a site less favorable than the Schiller Station site,



because their sampling was conducted without benefit of a sweeping flow, in contrast to the strong tidal flows in the Piscataqua River.

Weisberg *et al.* (1987) conducted a nighttime field study in the intake canal of Chalk Point Steam Electric Station on the Patuxent River in Maryland, a tributary of Chesapeake Bay, comparing pumped samples through 1.0-mm, 2.0-mm, and 3.0-mm CWW screens at 1 m depth, pumped control samples through an unscreened opening, and oblique bongo net tows at surface, 1 m and 2 m depths. The CWW screens tested were 76 cm in diameter, oriented perpendicular to the flow, with through-slot velocities averaging 13 cm/s and 20 cm/s in the two study years. Bay Anchovy and Naked Goby were the dominant larvae collected. Bay anchovy densities for larvae  $\geq 5$  mm were highest in the nets and lower for all three screens than in the unscreened samples. No significant difference was found among the three slot widths in mean densities entrained. No density reduction was shown for larvae  $\leq 4$  mm. Screen effectiveness was attributed both to physical exclusion and escapement of “ichthyoplankton with sufficient swimming ability” into the sweeping flow (i.e., larval avoidance). Avoidance was especially well demonstrated by entrainment reduction of the 5-mm size class of larvae on the 3-mm CWW screen, with respect to the fact that “fish as long as 20 mm are narrow enough to fit through this screen” (Weisberg *et al.* 1987). This study provided data for a wider range of sizes than earlier studies, demonstrating that entrainment reductions were greater for the larger size classes and could not be explained solely by limiting body dimension measurements, an indication of increasing avoidance with improving swimming capability (Weisberg *et al.* 1987). Data from the Weisberg *et al.* (1987) study were also used in the analysis in Section 4.2 below.

Using greatest body depth measurements from 17,091 Bay Anchovy larvae (Mattson *et al.* 2011) it was determined that all larvae less than 12.5 mm total length had limiting body dimensions small enough to pass through a 2 mm CWW screen (Figure 2). Therefore, 100% of Bay Anchovy larvae 12.5 mm or less in total length would be expected to be entrained through a 2 mm CWW screen. However, examining the Bay Anchovy data from Weisberg *et al.* (1987) revealed that actual entrainment of Bay Anchovy larvae through a 2.0 mm CWW screen decreased as larval length increased from 4 mm to 12.5 mm total length (Figure 2). Specifically, the observed entrainment of Bay Anchovy through a 2 mm CWW screen was just 49% for 6 mm larvae, 25% for 9 mm larvae, and 17% for 12.5 mm larvae when all of these larvae had limiting body dimensions small enough to be entrained (Figure 2).

Another field study compared CWW screens with 0.5 mm and 1.0 mm slot widths and through-slot velocities of 0.15 m/s and 0.30 m/s in an estuarine site in Narragansett Bay, Rhode Island, and in a freshwater site on the Portage River near its entrance into Lake Erie in Ohio (EPRI 2005). The 1.0-mm test screen was 30 cm in diameter and 36 cm long; the 0.5-mm screen was about one-third larger. Densities entrained through the barge-mounted CWW screens were compared to densities entrained through a control port covered with 9.5 mm mesh. Ambient densities were also monitored by net samples collected near the sampling barge. The dominant estuarine larvae were Grubby, Sand Lance, and Winter Flounder and the dominant freshwater larvae were clupeids (Gizzard Shad, possibly including some Alewife). This study was extended the following year using the same sampling design and methods in a southern Chesapeake Bay estuarine site, where the dominant larvae were Naked Goby, Bay Anchovy, Skilletfish, Striped Blenny, and Northern

Pipefish (EPRI 2006). Entrained densities were significantly lower than control densities for many of the combinations of species, size class, slot width, and slot velocity. Entrainment reduction tended to increase with decreasing slot velocity and with increasing ambient velocity (sweeping flow), which is consistent with the supposition that larval avoidance is improved as the size of the CWW screen's withdrawal zone decreases in thickness.

For all species analyzed by EPRI (2005, 2006), entrainment reduction tended to increase with larval length. This trend could be explained largely by physical exclusion, with fewer larvae fitting through the slots as the larvae grow larger. Alternatively, decreasing entrainment with increasing length could be attributed to increasing avoidance capability as the larvae grow larger. The 0.5-mm screen results give no indication whether avoidance contributed to the observed entrainment reductions, because even if there were no avoidance, the slot width was narrow enough to physically exclude most larvae. For some of the 1.0-mm screen results, however, physical exclusion was inadequate to explain significant reductions in densities entrained. Densities of Naked Goby in the 4-mm length class that were entrained through the 1.0-mm screen at a 0.15 m/s slot velocity were 69.7% lower than the control densities, even though all larvae in that length class were well under 1 mm in maximum head width. Densities of Naked Goby in the  $\leq 3$ -mm length class that were entrained through the 1.0-mm screen at a 0.30 m/s slot velocity were 36.9% lower than the control densities, even though the maximum head width for that length class is only about 0.4 mm. Densities of Skilletfish in the  $\leq 3$ -mm length class that were entrained through the 1.0-mm screen at a 0.15 m/s slot velocity were 63.2% lower than the control densities, even though the maximum head width for that length class is only about 0.6 mm. Densities of Striped Blenny in all length classes combined that were entrained through the 1.0-mm screen at a 0.30 m/s slot velocity were 48.2% lower than the control densities, even though all larvae in that length class were well under 1 mm in maximum head width (most head widths were  $< 0.7$  mm). In all those cases, the differences between test and control densities were statistically significant. The entrainment reductions could not be explained by physical exclusion because the larvae were thinner than the slot width of the CWW screen. Therefore, these results clearly demonstrate larval avoidance.

Results of the Indian Point laboratory tests (Mattson 2010a, 2010b, 2011) were validated in field studies performed in the Hudson River from a test barge moored at the Indian Point cooling water intake structure (Mattson et al. 2014a, 2014b, 2015). Sampling was conducted four days per week (96 hours continuously) from mid-April through September of 2011 with a 2 mm CWW screen deployed 35 feet below the surface of the Indian Point Station intake structure. This test screen was installed with the long axis of the cylinder parallel to the predominant tidal current direction of flow and the slot openings perpendicular to the tidal flow direction. A total of 1,104 pairs of two-hour samples representing an average of 185 m<sup>3</sup> each were collected by pumping simultaneously through the test CWW screen and a control port during each sampling week. Five minute tucker trawl tows (n=816) were also collected (mean volume = 284 m<sup>3</sup>) as an additional set of control sample, and all samples were filtered through a 300 micron mesh net. A total of 31 fish taxa (primarily Striped Bass, Bay Anchovy, and White Perch) and 275,245 ichthyoplankton individuals were collected, representing eggs, yolk sac larvae, post yolk sac larvae (83%), and juvenile fish. Ichthyoplankton larvae were also observed to avoid entrainment through the control port and the Tucker trawl samples provided the best ambient control. Overall, the number of

fish entrained at Indian Point Station was estimated to be reduced by 78% using 2 mm slot width CWW screens even though most of the larvae were small enough to be entrained through the 2 mm slot width of the test CWW screen. These Indian Point Station field tests also confirmed laboratory observations that CWW screen performance to reduce entrainment abundance is a function of hydraulic bypass (sweeping flows), avoidance swimming behavior of larvae, and physical exclusion of eggs and larvae with limiting dimensions greater than the slot width. Entrainment reductions were observed to increase with increasing sweeping flow, and larval avoidance increased as larval length increased.

### 3.3 Performance of Full-Scale Cylindrical Wedgewire Screens

Lab and field studies demonstrating the potential of narrow slot CWW screens to reduce entrainment have relied on small-scale test screens. There is very little information on the entrainment reduction performance of CWW screens in full-scale applications. The Westchester RESCO facility on the east bank of the Hudson River in Peekskill, New York, withdraws 55 million gallons per day (“MGD”) of cooling water through eight 1.4-m-long CWW screens with a slot width of 2.0 mm (EA 1986). A year-long sampling program there quantified and characterized the ichthyoplankton entrained, but that study lacked a direct comparison with ambient ichthyoplankton, so the entrainment reduction performance of those screens was not measured.

Logan Generating Plant in New Jersey withdraws 7.3 MGD of make-up water for closed cycle cooling from the Delaware River through two 1-mm-slot-width CWW screens at a through-slot velocity of 0.5 ft/s. Densities entrained (sampled by pumps) were only about 10% of the densities in nearfield samples (sampled by net tows) during the Striped Bass larval season (Ehrler and Raifsnider 2000). However, in studies that used both net tows and pumped samples to estimate ambient density, larval density estimated from nearby net tows was commonly several times higher than larval density in samples pumped through an unscreened (or coarsely screened) “control” opening (Browne *et al.* 1981, Otto *et al.* 1981, Zeitoun *et al.* 1981, and Weisberg *et al.* 1987, EPRI 2005, EPRI 2006). This difference in sampling gears, as well as the spatial and temporal separation of the nearfield and entrainment samples in the study by Ehrler and Raifsnider (2000), precludes a meaningful estimation of CWW screen performance from their data.

The Brooklyn Navy Yard Cogeneration plant withdraws between 55-94 MGD of cooling water from the tidal lower East River in New York through four bulkhead-mounted CWW screens with a slot width of 2 mm (EA 1998). Entrained ichthyoplankton were sampled during April-August 1997, but no ambient sampling was conducted to determine the entrainment reduction performance of the CWW screens. The entrainment reduction was further evaluated at Brooklyn Navy Yard in a 2010 study that demonstrated a 77.3% reduction of ichthyoplankton entrainment when compared to a full flow regulatory baseline. These entrainment reductions were attributed primarily to flow reductions, intake location and water withdrawal depth (Normandeau 2011).

At Eddystone Generating Station in Pennsylvania, Units 1 and 2 withdraw cooling water from the Delaware River estuary through eight CWW screens with a slot width of 0.25-inch (6.35 mm), an effective length of 12 feet (overall length of 20 feet), and a design slot velocity of 0.4 ft/s (Veritas *et al.* 2008). The adjacent Units 3 and 4 at the same facility withdraw cooling water through conventional 9.5 mm (3/8-inch) mesh traveling screens. An

entrainment study conducted during April 2005-March 2006 determined entrained densities at Units 1 and 2 and simultaneous densities at Units 3 and 4. That comparison provides direct evidence of the entrainment reduction performance of full scale CWW screens. Larvae of Tessellated Darter (32%), American Shad (13%), Cyprinidae (9%), Striped Bass (9%), White Perch (7%), *Morone* sp. (55), and American Eel (5%) were the predominant fish taxa observed in the entrainment samples, with the peak period of entrainment abundance occurring from early May through mid-July (Table 2-5 in Veritas *et al.* 2008). The 6.35 mm slot width CWW screens installed and operated at Units 1 and 2 of Eddystone Generating Station were estimated to reduce total annual entrainment of fish eggs and larvae combined by 60% from baseline, with a 95% confidence interval of 48 to 71% (Table 5.2, Veritas *et al.* 2008). In 374 paired entrainment samples over a full year at Eddystone, the mean density of larvae entrained through wedgewire screens at Units 1 and 2 was 82% lower than the mean density of larvae entrained simultaneously through conventional 9.5 mm (3/8-inch) mesh screens at Units 3 and 4. These results from Eddystone demonstrate that a high percentage of larvae can avoid entrainment through full-scale CWW screens operating under field conditions, even for slots as wide as 6.35 mm.

## 4 Length-Based Avoidance Model

---

### 4.1 Variable Definitions

As reviewed above (Sections 2.0 and 3.0), published laboratory and field research reveals that the effectiveness of CWW screens at reducing entrainment is a result of three distinct processes. One process is the physical exclusion of eggs and larvae by withdrawing cooling water through openings that are too small for the ichthyoplankton to pass through. This process can be represented by a “physical exclusion factor,” which represents the proportion of the organisms that would have been entrained through the existing screens that are excluded from a facility’s cooling water by a finer mesh alternative. The purpose of the physical exclusion factor is to enable estimation of the reduced number that would be entrained through a fine-mesh alternative technology:

$$E_f = (E) (1 - P_e) \quad \text{(Equation 1)}$$

where  $E_f$  = number entrained through fine-mesh intake screens,  
 $E$  = number entrained through existing intake screens, and  
 $P_e$  = proportion of the currently entrained organisms that would be excluded by a finer mesh alternative screening technology (physical exclusion factor).

The physical exclusion factor is based conservatively on the smallest dimension of eggs and larva, which determines the smallest opening that the larva can fit through. This limiting dimension was determined from measurements of greatest body depth from the literature and used to estimate  $P_e$  values for the dominant species entrained at Schiller Station. Those values were presented in Table 6-19 of Attachment 6 of the 2008 Response and solely used to describe the performance of CWW screens in that 2008 Response.

The second process enabling CWW screens to reduce entrainment is the ability of larvae to actively avoid being entrained by CWW screens. The third process is that eggs or larvae get

swept off by hydraulic bypass. Hydraulic bypass has the result of improving the entrainment reduction performance of narrow slot CWW screens if the screens are installed with the long axis of the cylinder parallel to the predominant current direction of flow and the slot openings perpendicular to the flow direction (Mattson 2010a, 2010b, 2011), as described in Section 2.0 (above, Figure 1) and supported by the field studies reviewed in Section 3.0 (above). This combined process is represented by a “wedgewire avoidance factor” in the models described below, because hydraulic bypass and active swimming avoidance are difficult to distinguish experimentally and have essentially the same outcome, which is not becoming entrained. Avoidance or bypass results from larvae moving out of the withdrawal zone of the CWW screens, thus escaping into the ambient water current (the “sweeping flow”). The purpose of the wedgewire avoidance factor is to be used together with the physical exclusion factor to enable estimation of the reduced number that would be entrained through CWW screens:

$$E_w = ( E ) ( 1-P_a ) ( 1-P_e ) \quad \text{(Equation 2)}$$

where  $E_w$  = number entrained through wedgewire screens,  
 $E$  = number entrained through existing intake screens,  
 $P_a$  = proportion avoiding entrainment (wedgewire avoidance factor), and  
 $P_e$  = proportion excluded (physical exclusion factor).

The following narrative describes the rationale, assumptions, data, and procedures used to estimate the wedgewire avoidance factors for application to the Schiller Station entrainment estimates for the technological alternative of CWW intake screens.

#### 4.2 Estimation of Wedgewire Avoidance Factors

As discussed above in Section 2.0 and Section 3.0, a wide variety of studies performed by many investigators have demonstrated that fish larvae possess the ability to swim and to use their swimming ability to evade predators, sampling gears, and, at least in under certain circumstances, intake screens. Of particular relevance here, Heuer and Tomljanovich (1978) found that the proportions of larvae entrained through flat wedgewire screen panels in a laboratory flume were much lower than the proportions of flow entrained, indicating that larvae small enough to be entrained are capable of detecting and avoiding wedgewire screens (Heuer and Tomljanovich 1978). To avoid entrainment, larvae need only to swim far enough to move out of the flow entrained through the screen and into the sweeping flow that bypasses the screen.

If active avoidance and physical exclusion are two distinct factors contributing collectively to entrainment reduction, their combined effect can be expressed by the following generalization for wedgewire screens:

$$P_E = ( 1-P_a ) ( 1-P_e ) \quad \text{(Equation 3)}$$

where  $P_E$  = proportion of larvae within the withdrawal zone that are entrained,  
 $P_a$  = proportion of larvae within the withdrawal zone that avoid entrainment,  
and

$P_e$  = proportion of larvae within the withdrawal zone that do not avoid entrainment but are physically excluded.

In field and lab tests of wedgewire screens, only  $P_E$  (the combined effect of  $P_a$  and  $P_e$ ) can be directly observed. The component of entrainment reduction due to larval avoidance can be estimated by solving Equation 3 for the wedgewire avoidance factor  $P_a$  and applying the rearranged equation to experimentally observed values of  $P_E$  and estimates of the physical exclusion factor  $P_e$ :

$$P_a = 1 - [ ( P_E / ( 1-P_e ) ) ] \quad \text{(Equation 4)}$$

where  $P_a$  = proportion of larvae within the withdrawal zone that avoid entrainment,  
 $P_E$  = proportion of larvae within the withdrawal zone that are entrained, and  
 $P_e$  = proportion of larvae within the withdrawal zone that do not avoid entrainment but are physically excluded.

The flume study by Heuer and Tomljanovich (1978) compared larval entrainment through wedgewire panels for many combinations of species, slot width, panel orientation, through-slot velocity, and sweeping velocity. For each test, a wedgewire panel was mounted flush with either the bottom or side of the flume, withdrawing water perpendicular to the direction of flow in the flume. In the absence of physical exclusion or active avoidance (or attraction), the expected proportion of larvae not drawn through the wedgewire panel (the proportion “bypassed”) was the same as the proportion of the flume’s flow that was bypassed. The assumption inherent in this expected proportion of larvae bypassed is that in the absence of a behavioral response (such as avoidance), larvae act as neutrally buoyant particles and are passively transported by the flow of the water either into or past the wedgewire panels in the flume. The expected proportion of larvae bypassed was compared to the observed proportion of larvae that actually were bypassed. The larvae in these experiments were distributed uniformly throughout the cross-section of the flume (both within the withdrawal zone and within the flow that bypassed the screen panel), which can be accounted for by inserting another term into Equation 3:

$$P_E = ( 1-P_b ) ( 1-P_a ) ( 1-P_e ) \quad \text{(Equation 5)}$$

where  $P_E$  = proportion of larvae within the entire flume that were entrained,  
 $P_b$  = proportion of the flume’ s flow that bypassed the screen panel,  
 $P_a$  = proportion of larvae within the withdrawal zone that avoided entrainment, and  
 $P_e$  = proportion of larvae within the withdrawal zone that did not avoid entrainment but were physically excluded.

Solving for  $P_a$  to estimate the wedgewire avoidance factor from the Heuer and Tomljanovich (1978) flume tests,

$$P_a = 1 - \{ P_E / [ ( 1-P_b ) ( 1-P_e ) ] \} \quad \text{(Equation 6)}$$

where  $P_a$  = proportion of larvae within the withdrawal zone that avoided entrainment,

- $P_E$  = proportion of larvae within the entire flume that were entrained (observed by the experimenters),
- $P_b$  = proportion of the flume's flow that bypassed the screen panel (determined by the experimenters from measurements of the flow in the flume and the flow withdrawn through the wedgewire panel), and
- $P_e$  = proportion of larvae within the withdrawal zone that did not avoid entrainment but were physically excluded.

Estimates of  $P_a$  were calculated by Equation 6 from selected data values in Heuer and Tomljanovich (1978) to represent a system that could be applicable to Schiller Station. The data chosen for this analysis were those for slot widths of 1.0 and 2.0 mm, a slot velocity of 0.15 m/s, and flume velocities of 0.15 and 0.30 m/s from the tests on Striped Bass larvae (Tables 1 and 2 in Heuer and Tomljanovich 1978). Striped Bass is the species most extensively tested by Heuer and Tomljanovich (1978), providing the best comparison among the factors tested. Other species were not tested under as many different conditions, and many were not as suitable in terms of size (Bluegill were too big to be entrained), health (Walleye were in poor condition), behavior (Channel Catfish were strongly demersal), or number of test organisms available. Although Striped Bass are not entrained at Schiller Station, their compact body morphology makes them a good representative of pelagic larvae such as Grubby, Atlantic Mackerel, Cunner, Hakes, and Fourbeard Rockling, which are entrained at Schiller Station, (2008 Biological Report, Normandeau 2008). Estimates of  $P_e$  (which are needed to estimate  $P_a$ ) are available for 1-mm length classes of striped bass larvae from 2 mm to 70 mm (Normandeau 2010), based on the extensive data set of 12,710 measurements of body depths and lengths of entrained Striped Bass larvae (Normandeau 1987).

Striped Bass were tested by Heuer and Tomljanovich (1978) in two series of trials, one in April (lengths averaging 5.6 mm) and one in June (lengths averaging 5.9 mm). For larvae exposed to panels with slots 1 mm wide, the wedgewire avoidance factor ( $P_a$ ) averaged 0.309 in April tests and 0.483 in June tests for a slot velocity of 0.15 m/s and flume velocities of 0.15 m/s and 0.30 m/s. For Striped Bass larvae exposed to panels with slots 2 mm wide,  $P_a$  averaged 0.412 in April tests and 0.755 in June tests at those velocities. Each of these values was the mean of  $P_a$  for four trials, where a trial was the average of three replicate releases of about 100-200 larvae each. The overall averages by slot width for the April and June tests combined (average length 5.75 mm) were  $P_a=0.396$  for 1-mm screening and  $P_a=0.583$  for 2-mm screening.

Additional data for estimating  $P_a$  are available from the EPRI study (2003). Some of those tests were conducted with the CWW test screen oriented with its axis perpendicular to the flow in the test flume. Little avoidance and sometimes high extrusion rates were observed in the perpendicular screen tests, so that orientation would not be appropriate for CWW screens in a cooling water intake application and those results were not considered in estimating  $P_a$  for Schiller Station. There was little or no avoidance at 0.30 m/s slot velocity, so a slot velocity that high would not be appropriate for cooling water intake screens and those results were also excluded from the  $P_a$  estimation for Schiller Station. Tests at 0.08 m/s flume velocity were excluded as being too low to be representative of the tidal currents at the Schiller Station site. Tests at a slot width of 0.5 mm were excluded because that slot

width is too narrow to be practical for Schiller Station. The EPRI (2003) data selected for estimating  $P_a$  for Schiller Station were for a parallel screen orientation, 0.15 m/s slot velocity, 0.15 and 0.30 m/s flume velocities, and 1.0 and 2.0 mm slot widths.

Species tested under all those conditions were Striped Bass and Winter Flounder (EPRI 2003). Although Winter Flounder are entrained at Schiller Station, they only accounted for 0.28% of the ichthyoplankton collected in a year-long entrainment sampling program (2008 Biological Report, Normandeau 2008). Furthermore, limiting dimension (head width or body depth) data available for estimating  $P_a$  for Winter Flounder are very limited. Striped Bass, on the other hand, have an extensive data set of body depths available (Normandeau 1987) for estimating the physical exclusion factor  $P_e$ , which is needed to estimate the wedgewire avoidance factor  $P_a$  from flume experiments. Striped Bass also have a morphology that makes them a good surrogate for winter flounder and other species with a compact larval body form entrained at Schiller Station. Therefore, the Striped Bass data from EPRI (2003) were selected for estimating  $P_a$  for Schiller Station. Since the test organisms in that study were released close to the screen at its centerline and all presumed to be within the screen's withdrawal zone, Equation 4 above was the one applicable to these data. Based on those data from EPRI (2003), the mean  $P_a$  for 7.0-mm Striped Bass larvae and 1.0-mm slot width screens was 0.706 and the mean  $P_a$  for 8.3-mm Striped Bass larvae and 2.0-mm slot width screens was 0.464.

Considered together, the results of Heuer and Tomljanovich (1978) and EPRI (2003) for Striped Bass on 1.0 and 2.0-mm wedgewire screens suggest a fairly consistent avoidance factor, with no indication of differences due to slot width. The size range of the Striped Bass larvae tested in these two studies was, however, too narrow to determine whether avoidance behavior increases with the size of the larvae.

Observations over a wider range of lengths for other species were obtained in the study by Weisberg *et al.* (1987), in which Bay Anchovy was a dominant species collected. Although Bay Anchovy are not entrained at Schiller Station, they are an excellent representative of a species with the elongate body shape characteristic of American Sand Lance, Rock Gunnel, Rainbow Smelt, and Atlantic Herring, which are all entrained at Schiller Station (2008 Biological Report, Normandeau 2008). No exclusion was demonstrated for eggs or larvae  $\leq 4$  mm, but densities of Bay Anchovy larvae  $\geq 5$  mm were lower for all three screens than for the unscreened samples. Mean densities entrained appeared to decrease with decreasing slot width, although this pattern was not statistically significant. Within the four larger size ranges (5-7, 8-10, 11-14, and  $\geq 15$  mm), entrained densities were significantly lower than open port densities for 15 of the 20 combinations of size group, sampling year, and slot width (Figure 2). Mean annual Bay Anchovy densities in Table 1 of Weisberg *et al.* (1987) provided the data used to estimate  $P_a$  for Schiller Station. Because of unequal sample volumes and numbers of samples in the two years of the study, as well as zero catches for some size groups and slot widths, the densities from the two years were first averaged together, weighted by total sampling volume. Next, the proportion entrained for each size group and slot width ( $P_E$ ) was calculated as the ratio of entrained density to open port density to enable estimating  $P_a$  by Equation 4, using values of  $P_e$  for Bay Anchovy (Normandeau 2010), which were based on 17,091 measurements of Bay Anchovy specimens (Normandeau 1987). Negative values for  $P_a$  in the  $\leq 4$  mm length class for all three slot widths were



interpreted as artifacts of low catches and set to zero, resulting in the following wedgewire avoidance factors for Bay Anchovy larvae estimated from the data of Weisberg *et al.* (1987):

	1.0-mm screen	2.0-mm screen	3.0-mm screen
≤4 mm larvae	0.000	0.000	0.000
5-7 mm larvae	0.427	0.512	0.438
8-10 mm larvae	0.860	0.747	0.662
11-14 mm larvae	1.000	0.832	0.769
≥15 mm larvae	0.874	0.793	0.839

The above estimates of wedgewire avoidance are based on a wide range of sizes for Bay Anchovy and a limited size range for Striped Bass. To evaluate the best approach to estimate factors for other species, the estimates for Striped Bass and Bay Anchovy were compared within their common size range.  $P_a$  estimates for Striped Bass were 0.396 and 0.583 at 5.75 mm and 0.706 at 7.0 mm, compared to Bay Anchovy estimates of 0.427, 0.512, and 0.438 in the 5-7 mm length range. The good agreement among values for these two species, in spite of their different body shapes, supports using a single value (or set of values) of  $P_a$  for all species in the Schiller Station analysis. The  $P_a$  estimates for bay anchovy, the only species tested over a wide range of sizes, increase consistently with increasing size. This is consistent with the biology of fish larvae, which improve in swimming capability as they grow (Section 2.1 above). Based on the similarity in avoidance between Striped Bass and Bay Anchovy of a comparable size, the increase in avoidance demonstrated by Bay Anchovy as they grow, and the similarity in avoidance among different slot widths tested, the 19 values summarized in Table 1 were used to fit a generalized exponential equation for estimating wedgewire avoidance as a function of length, applicable to all species in the Schiller Station analysis (illustrated in Figure 3):

$$P_a = 1 - e^{[-0.275(L - 4)]} \quad \text{(Equation 7)}$$

where  $P_a$  = proportion of larvae within the withdrawal zone that avoid entrainment,  
 $e$  = base of natural logarithms (2.71828),  
 $L$  = total length (mm).

Equation 7 applies when length ≥4 mm (when length <4 mm,  $P_a$  is defined as zero).

## 5 Application to Schiller Station

### 5.1 Approach

The previous estimates of the potential for CWW screens to reduce the entrainment impact of Schiller Station on the adult fish community were summarized in Table 6.3 in the 2008 Response and detailed in Tables 6-22 through 6-24 in Attachment 6 of the 2008 Response. Those estimates were calculated under the most conservative assumption that CWW screens

would reduce entrainment solely because of physical exclusion by the narrow slots of the screens. This supplementary analysis extends the CWW screen evaluation to include the added effect of the wedgewire avoidance factor (defined in Section 4.1 above), thus providing a more realistic estimate of the expected entrainment reduction performance of narrow slot CWW screens if installed at Schiller Station and operated throughout the year than was used by EPA in the draft NPDES permit and draft fact sheet. Adding the wedgewire avoidance factor to a model to determine the effectiveness of narrow slot CWW screens at Schiller Station accounts for the realistically greater entrainment reductions than possible from a model based on physical exclusion alone, as was done in Attachment 6 of the 2008 Response. To model that possibility, the length-based wedgewire avoidance factor described in Section 4.0 (Equation 7 above) was applied to the same Schiller Station entrainment data that were previously analyzed in Attachment 6 of the 2008 Response to provide a more realistic estimate of CWW screen performance.

All entrainment estimates represent the combined totals for the same nine fish taxa included in the fine-mesh exclusion analysis in Tables 6-19 through 6-24 in Attachment 6 of the 2008 Response: American Sand Lance, Atlantic Herring, Atlantic Mackerel, Cunner, Fourbeard Rockling, Grubby, Rainbow Smelt, Rock Gunnel, and *Urophycis* Hakes (Red Hake and White Hake). Those taxa represent 95.5% of the total ichthyoplankton entrainment at Schiller Station (2008 Biological Report, Normandeau 2008). The range of slot widths evaluated was extended by adding 2.0 mm and 3.0 mm to the four slot widths previously evaluated in Attachment 6 of the 2008 Response (0.6 mm, 0.69 mm, 0.8 mm and 1.0 mm). The wedgewire avoidance factor was assumed not to vary among slot widths  $\leq 3$  mm, based on the lack of evidence for variation among slot widths in that range in the data of Heuer and Tomljanovich (1978), Weisberg *et al.* (1987), and EPRI (2003).

The physical exclusion factor  $P_e$  for eggs was based on the reported range for egg diameter for each species;  $P_e$  for larval stages was based on the approximate body depth corresponding to the minimum reported length for each stage within each species (Table 2). Because each larval stage was represented by its minimum length, many of the larvae exposed to the CWW screens would actually be larger, making the resulting estimates of entrainment reduction due to exclusion conservatively low.

All CWW screen performance estimates were calculated using the actual intake flows (AIF) from the three most recent years of Schiller Station flow data (27 August 2012 through 26 August 2015) to align with the original weekly entrainment density data obtained from the 2006 and 2007 study (Normandeau 2008). CWW screen reduction performance was compared to the 2012-2015 AIF annual total entrainment abundance (or the equivalent adult losses at AIF) three different ways, to show a full range of CWW screen avoidance assumptions and the sensitivity of the outcome to these assumptions: (1) the previously presented most conservative assumption of no avoidance, where  $P_a=0$ , (2) a moderately conservative assumption of limited avoidance, where  $P_a$  was set to a constant value of 0.3, and (3) the fully developed length-based avoidance model described in Section 4.2, where  $P_a$  is a function of larval length. CWW screens are assumed to be installed in a sweeping current with the slots of the wedgewire screen material aligned radially along the circumference of each cylinder (Figure 1, right image), and thus are perpendicular to the long axis of the cylinder.

### 5.2 Results

The potential biological benefit of installing CWW screens at Schiller Station was estimated based on both physical exclusion (Equation 1) and based on both physical exclusion and larval avoidance (Equation 7) by comparing estimated entrainment and impingement losses to a baseline representing losses with the existing intake screens. For the most conservative assumption (Equation 1, no larval avoidance), the estimated reduction in the numbers of fish entrained ranged from zero at a slot width of 2.0 mm or 3.0 mm to 97% at a slot width of 0.6 mm (Table 3). When the projected entrainment losses were expressed as the estimated numbers that would ultimately be lost to the adult population (i.e., expressed as the equivalent adult losses at age of first maturity), reductions from baseline ranged from 0% for a slot width of 2.0 mm to 3.0 mm to >99% for a slot width of 0.6 mm based on physical exclusion alone (Table 3). Therefore, on common terms (equivalent adult numbers), the effectiveness of CWW screens resulting entirely from physical exclusion compared to a full flow baseline were estimated to improve substantially from 0% at a slot width of 2.0 mm or 3.0 mm to 92% at a slot width of 1.0 mm. This large improvement in predicted performance between 1.0 mm and 2.0 mm slot width CWW screens was solely because almost no ichthyoplankton entrained at Schiller Station during the 2006-2007 study (2008 Biological Report, Normandeau 2008) would be physically excluded by a 2.0-mm slot width but most would be excluded by a 1.0-mm slot width.

For a moderately conservative assumption that 30% of larvae would avoid being entrained through CWW screens (an assumption that discounts the role of avoidance behavior), the estimated reduction in the numbers entrained among the range of CWW screen slot widths examined ranged from 15% at a slot width of 2.0 mm or 3.0 mm to 98% at a slot width of 0.6 mm (Table 4). The estimated reduction from the 2012-2015 AIF in the numbers that would be lost to the adult population ranged from 30% for a slot width of 2.0 mm or 3.0 mm to >99% for a slot width of 0.6 mm (Table 4). A slot width of 1.0 mm was estimated to reduce the equivalent adult losses by 94% compared to the current AIF (Table 4).

If the realistic ability of larvae to avoid being entrained through CWW screens as they grow larger (as documented in numerous laboratory and field studies reviewed in Sections 2.0 and 3.0 above, and mathematically described by Equation 7 that was developed in Section 4.2 above) was applied to full-scale CWW screens installed at Schiller Station intakes 1 and 2 and operated year-round, the reduction in the numbers entrained were estimated to range from 26% at a slot width of 2.0 mm or 3.0 mm to >99% at a slot width of 0.6 mm (Table 5). Based on CWW screens reducing entrainment through both physical exclusion and larval avoidance swimming (Equation 7), the estimated reduction from the baseline in the numbers that would be lost to the equivalent adult population ranged from 78% for a slot width of 2.0 mm or 3.0 mm to >99% for a slot width of 0.6 mm (Table 5). A slot width of 1.0 mm was estimated to reduce the equivalent adult losses by 95% due to the combination of physical exclusion and the wedgewire avoidance factor compared to the current AIF (Table 4).

## 6 Discussion

---

### 6.1 Equivalent Adult Losses

The derivation of annual CWW screen performance using both raw counts of fish eggs and larvae, and their equivalents, presents different results for the performance metrics as described in the Tables 3, 4 and 5 of Results Section 5.2 above. However, only the results based on equivalent adult numbers provide a consistent and biologically meaningful way to interpret counts of fish eggs, larvae, and juveniles entrained at power plants (Salia et al. 1977). Equivalent adult values derive from a straightforward application of the “life table” concept described in population biology textbooks (e.g., Andrewartha and Birch 1954, Barnthouse 2005, EPRI 2012). A life table is a list that provides, for any given age or life stage of organisms in a population, the fraction of organisms expected to survive from birth (or spawning, in the case of fish) to that given age or stage. The values in the life table is used to calculate the fraction of organisms alive at some stage after birth (or spawning) that would be expected to survive to some later stage. For example, the life table can be used to calculate the fraction of post yolk-sac larvae expected to survive to become juvenile fish, or the fraction of one-year-old fish expected to survive to become 3-year-old “adult” fish. The equivalent adult numbers use survival from published life tables to adjust the number of fish entrained at different stages (i.e., eggs, yolk sac larvae, post-yolk sac larvae, juveniles) or ages to the number that would have been expected to survive to some common future age – typically to either an age of 1 year or to the age at which female fish become sexually mature (i.e., adult). The correct and biologically equitable way for the EPA to compare the performance of different slot width CWW screens if installed and operated at Schiller Station as presented in this Appendix 3 is by using the entrainment reductions presented as equivalent adult values provided in Tables 3, 4 and 5.

### 6.2 CWW Screen Performance

The numerous published laboratory and field studies of flat wedgewire panels and CWW screens reviewed in Sections 2.0 and 3.0 above have proven beyond a reasonable doubt (backed by statistical testing) that larval avoidance actually occurs. The length-based avoidance curve developed in Section 4.2 (Equation 7 and Figure 3) that was used to revise the Schiller Station entrainment reduction estimates for the alternative technology of CWW screens (Section 5.0 and Table 5) was developed from laboratory tests of fish larvae representing species of similar sizes and body forms as those exposed to entrainment at Schiller Station. Those laboratory tests (Section 2.0), and supporting field studies (Section 3.0) studied small-scale (12 inches in diameter by 44 inches long), narrow slot, CWW screens of the same proportions and orientation as larger screens that could be installed at Schiller Station. One important conclusion from the analysis of the laboratory data was that the slot width of a narrow-slot CWW screen did not have a significant influence on avoidance for the range of slot widths tested. For example, no difference was calculated (Equation 7) for the effectiveness of 2.0 mm or 3.0 mm CWW screens at Schiller Station (both 78% reductions in equivalent adults, Table 5). Furthermore, the difference in effectiveness between 1.0 mm CWW screens and 2.0 or 3.0 mm slot width CWW screens installed and operated year round at Schiller Station was estimated as 95% vs. 78%, respectively for equivalent adult losses (Table 5). This conclusion is supported by the narrow scatter of actual experimental

observations about the predicted curve. The correlation coefficient was high ( $R^2 = 0.872$ ), and larval length was the predominant factor influencing the curve (Figure 3). However, only a narrow range of slot widths for CWW screens was tested (0.6 mm to 3.0 mm). It is not clear from the available laboratory studies whether this avoidance curve would apply to CWW screens with slots wider than 3 mm, although the results from the full scale testing of 6.35 mm CWW screens at Eddystone (Section 3.3 above) suggest similar performance when installed in strong sweeping flows with the slots of the wedgewire screen material aligned radially along the circumference of each cylinder.

In regard to physical exclusion by narrow CWW screen slots, larvae with greatest body depths thinner than the screen's slot width could potentially fail to pass through the slots if they are not oriented "head on" in the through-slot flow. For example, they could be impinged sideways across the slots. This would cause an underestimate of entrainment reduction because the physical exclusion equation we developed (Equation 1) conservatively assumes all eggs and larvae encounter the slot width of a CWW screen and would be physically excluded based on the narrowest limiting dimension (i.e., greatest body depth). The consequence of this conservative assumption may more likely affect physical exclusion for fine-mesh traveling screens than for CWW screens with the long axis of the cylinder aligned parallel to the sweeping flow because of the traveling screens have square openings and the mesh is aligned perpendicular to the intake flow, but could also be a factor for CWW screens depending on the consistency of the sweeping flow direction. There is another factor, however, that could cause an underestimate of entrainment reduction estimates, and that is "extrusion." Extrusion occurs when the force of the intake flow forces an organism through a screen opening that is narrower than the smallest dimension of the organism (its width or depth). Extrusion could happen if an organism were compressed or distorted by the force of the water. However, engineering designs that minimize the through slot velocity and maximize the ratio between through-slot and sweeping velocities would likely overcome the possibility of extrusion and facilitate larval avoidance and hydraulic bypass compared to physical exclusion when optimizing the entrainment reduction performance of CWW screens at larger slot widths (2.0 or 3.0 mm) than those prescribed by EPA in Schiller Station's draft NPDES permit and draft fact sheet (0.6 mm to 0.8 mm).

The substantial new information developed since the 2008 Response reveals that performance of CWW screens should be considered more than just physical exclusion of entrained organisms that are too large to fit through narrow slot widths. The entrainment reduction performance of CWW screens is also a function of hydraulic bypass and active larval swimming avoidance by larvae.

The following engineering considerations would maximize the entrainment reduction performance of larger (i.e., 2 mm or greater) slot width CWW screens if installed and operated year-round at Schiller Station's CWISs:

- Aligning long axis of the CWW screens parallel to the predominant sweeping currents;
- Aligning the slots perpendicular to the sweeping flow direction; and
- Engineering design to ensure a high sweeping flow to slot flow ratio.

## 7 References

---

- Andrewartha, H. G., and L. C. Birch. 1954. *The Distribution and Abundance of Animals*. University of Chicago Press, Chicago. IL. 782 p.
- Barnthouse, L.W. 2005. Parameter development for equivalent adult and production foregone models. EPRI Report 1008832. June 2005.
- Browne, M.E., L.B. Glover, D.W. Moore, and D.W. Ballengee. 1981. In-situ biological and engineering evaluation of fine-mesh profile-wire cylinders as powerplant intake screens. Pages 36-46 in Dorn, P.B., and J.T. Larson (eds.), Proceedings of the workshop on advanced intake technology, San Diego, California, April 1981.
- EA (EA Science and Technology). 1986. Results of entrainment and impingement monitoring studies at the Westchester RESCO facility, Peekskill, New York. Prepared for Westchester RESCO.
- EA (EA Engineering, Science, and Technology). 1998. Brooklyn Navy Yard Cogeneration Facility 1997 ichthyoplankton entrainment monitoring study. Prepared for Brooklyn Navy Yard Cogeneration Facility, L.P./Palmark.
- Ehrler, C., and C. Raifsnider. 2000. Evaluation of the effectiveness of intake wedgewire screens. *Envir. Sci. & Policy* 3:S361-S368.
- Enterline, C.L., Chase, B.C., Carloni, J.M. and Mills, K.E., 2012. A Regional Conservation Plan for Anadromous Rainbow Smelt in the U.S. Gulf of Maine. Submitted as part of: A Multi-State Collaborative to Develop & Implement a Conservation Program for Three Anadromous Finfish Species of Concern in the Gulf of Maine, NOAA Species of Concern Grant Program Award #NA06NMF4720249A.
- EPRI (Electric Power Research Institute). 2003. Laboratory evaluation of wedgewire screens for protecting early life stages of fish at cooling water intakes. Report 1005339.
- EPRI (Electric Power Research Institute). 2005. Field evaluation of wedgewire screens for protecting early life stages of fish at cooling water intakes. Report 1010112.
- EPRI (Electric Power Research Institute). 2006. Field evaluation of wedgewire screens for protecting early life stages of fish at cooling water intake structures. Chesapeake Bay studies. Report 1012542.
- EPRI (Electric Power Research Institute) 2012. Fish life history parameter values for equivalent adult and production foregone models: comprehensive update. EPRI Report 1023103. April 2012.
- Hanson, B.N. 1981. Studies of larval Striped Bass (*Morone saxatilis*) and Yellow Perch (*Perca flavescens*) exposed to a 1 mm slot profile-wire screen model intake. Pages 22-35 in Dorn, P.B., and J.T. Larson (eds.), Proceedings of the workshop on advanced intake technology, San Diego, California, April 1981.

- Hanson, B.N., W.H. Bason, B.E. Beitz, and K.E. Charles. 1977. A practical intake screen which substantially reduces the entrainment and impingement of early life stages of fish. Pages 393-407 in L.D. Jensen (ed), Fourth national workshop on entrainment and impingement. E.A. Communications, Melville, N.Y.
- Hardy, J.D, Jr. 1978. Development of fishes of the Mid-Atlantic Bight. An atlas of egg, larval and juvenile stages. Volume 3. Aphredoderidae through Rachycentridae. U.S. Fish Wildl. Serv. 394 p.
- Heuer, J.H., and D.A. Tomljanovich. 1978. A study on the protection of fish larvae at water intakes using wedge-wire screening. TVA Tech. Note B26. 60 p.
- Jones, P.W., F.D. Martin, and J.D. Hardy, Jr. 1978. Development of fishes of the Mid-Atlantic Bight. An atlas of egg, larval and juvenile stages. Volume 1. Acipenseridae through Ictaluridae. U.S. Fish Wildl. Serv. 366 p.
- Mattson, M. T. October 2010a. Cylindrical Wedgewire Screen (WWS) Effectiveness at Indian Point. PowerPoint Presentation to USEPA Region 1 in New York, NY. Prepared for Indian Point Energy Center, Buchanan, NY.
- Mattson, M. T. December 2010b. Cylindrical Wedgewire Screen (WWS) Effectiveness at Indian Point. PowerPoint Presentation to USEPA Headquarters in Washington, DC. Prepared for Indian Point Energy Center, Buchanan, NY.
- Mattson, M. T., P. Lindsay, J. Young, and J. Black. 2011. Larval Avoidance Enhances the Entrainment Reduction Performance of Cylindrical Wedgewire Screens. PowerPoint Presentation to the American Fisheries Society (AFS) Section 316(b) Symposium, Seattle, WA, August 2011. Prepared for Indian Point Energy Center, Buchanan, NY.
- Mattson, M. T., P. Lindsay, J. Young, D. Heimbuch, and L. Barnthouse. 2014a. Performance of 2-mm Slot Wedgewire Screens for Reducing Entrainment at Indian Point Station. PowerPoint Presentation to the Electric Utilities Consultants, Inc. (ECUI) Section 316(b) Symposium, Providence, RI, October 2014. Prepared for Indian Point Energy Center, Buchanan, NY.
- Mattson, M. T., P. Lindsay, J. Young, D. Heimbuch, and L. Barnthouse. 2014b. In-River Performance of a 2-mm Slot Wedgewire Screen for Reducing Entrainment at Indian Point Station. PowerPoint Presentation to the American Fisheries Society (AFS) Section 316(b) Symposium, Quebec City, Quebec, Canada, August 2014. Prepared for Indian Point Energy Center, Buchanan, NY.
- Normandeau (Normandeau Associates, Inc.). 2015. Performance of 2-mm Slot Wedgewire Screens for Reducing Entrainment at Indian Point Station. PowerPoint Presentation to the Electric Power Research Institute (EPRI) Section 316(b) Symposium, Charlotte, NC, November 2015. Prepared for Indian Point Energy Center, Buchanan, NY.
- Normandeau (Normandeau Associates, Inc.). 1987. Indian Point Generating Station entrainment abundance program 1986 annual report. Prepared for Consolidated Edison Company of New York, Inc., and New York Power Authority.

- Normandeau (Normandeau Associates, Inc.). 2008. Entrainment and impingement studies performed at Schiller Generating Station from September 2006 through September 2007. Prepared for Public Service of New Hampshire.
- Normandeau (Normandeau Associates, Inc.). 2010. Biological evaluation of intake screen alternatives to reduce impingement and entrainment losses at Indian Point Energy Center. Appendix B of Attachment 6 in Enercon Services, Inc. 2010. Evaluation of alternative intake technologies at Indian Point Units 2 & 3. Prepared for Entergy Nuclear Indian Point 2, LLC and Entergy Nuclear Indian Point 3, LLC.
- Otto, R.G., T.I. Hiebert, and V.R. Kranz. 1981. The effectiveness of a remote profile-wire screen intake module in reducing the entrainment of fish eggs and larvae. Pages 47-56 in Dorn, P.B., and J.T. Larson (eds.), Proceedings of the workshop on advanced intake technology, San Diego, California, April 1981.
- PSNH (Public Service Company of New Hampshire). 2008. Response to United States Environmental Protection Agency CWP §308 letter, PSNH Schiller Station, Portsmouth, New Hampshire. Prepared for PSNH by Enercon Services, Inc. in consultation with Normandeau Associates, Inc. October 2008.
- Saila, S. B., E.Lorda, J. D. Miller, R. A. and W. H. Howell. 1977. Equivalent adult estimates for losses of fish eggs, larvae, and juveniles at Seabrook Station with use of fuzzy logic to represent parametric uncertainty. *North American Journal of Fisheries Management* 27:811-825.
- Veritas *et al.* (Veritas Economic Consulting, Normandeau Associates Inc., and ARCADIS). 2008. Development of annual current and baseline impingement mortality and entrainment estimates. Eddystone Generating Station. Eddystone, PA. Prepared for Excelon Generation Company, LLC.
- Weisberg, S.B., W.H. Burton, F. Jacobs, and E.A. Ross. 1987. Reductions in ichthyoplankton entrainment with fine-mesh, wedge-wire screens. *N. Amer. J. Fish. Manag.* 7:386-393.
- Zeitoun, I.H., J.A. Gulvas, and D.B. Roarabaugh. 1981. Effectiveness of fine mesh cylindrical wedge-wire screens in reducing entrainment of Lake Michigan ichthyoplankton. *Can. J. Fish. Aquat. Sci.* 38:120-125.
- Normandeau (Normandeau Associates, Inc.). 2011. 2010 Brooklyn Navy Yard Cogeneration Entrainment Characterization Study. Prepared for Olympus Power Operations, Inc. April 2011.



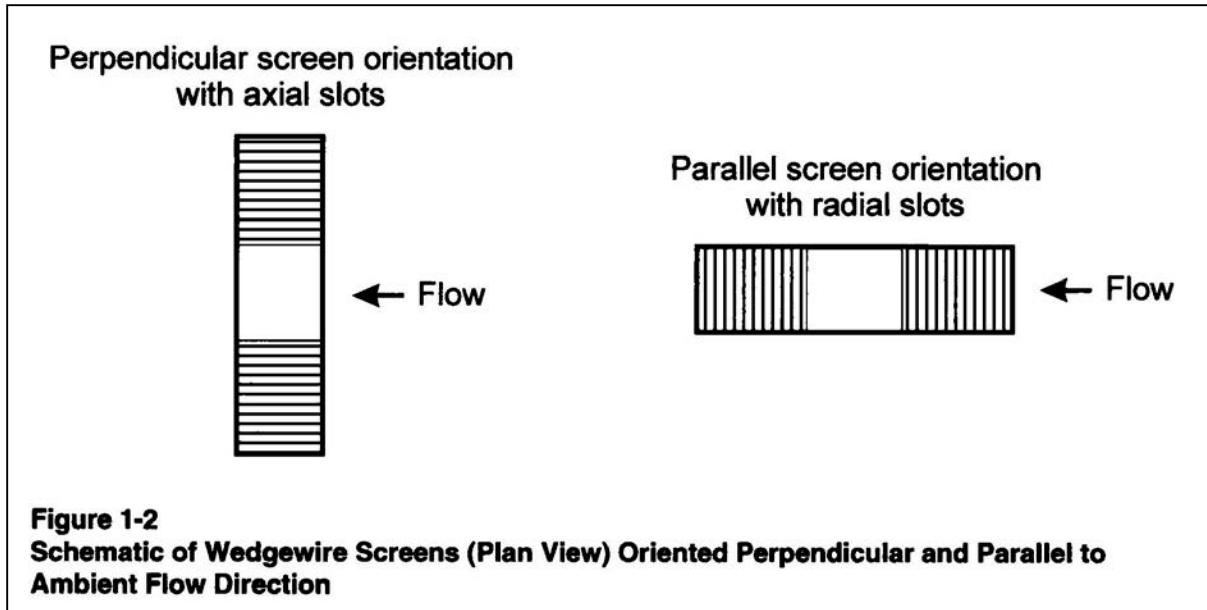

Figure 1. Effectiveness of Wedgewire Screen orientation (reproduced from EPRI 2003).

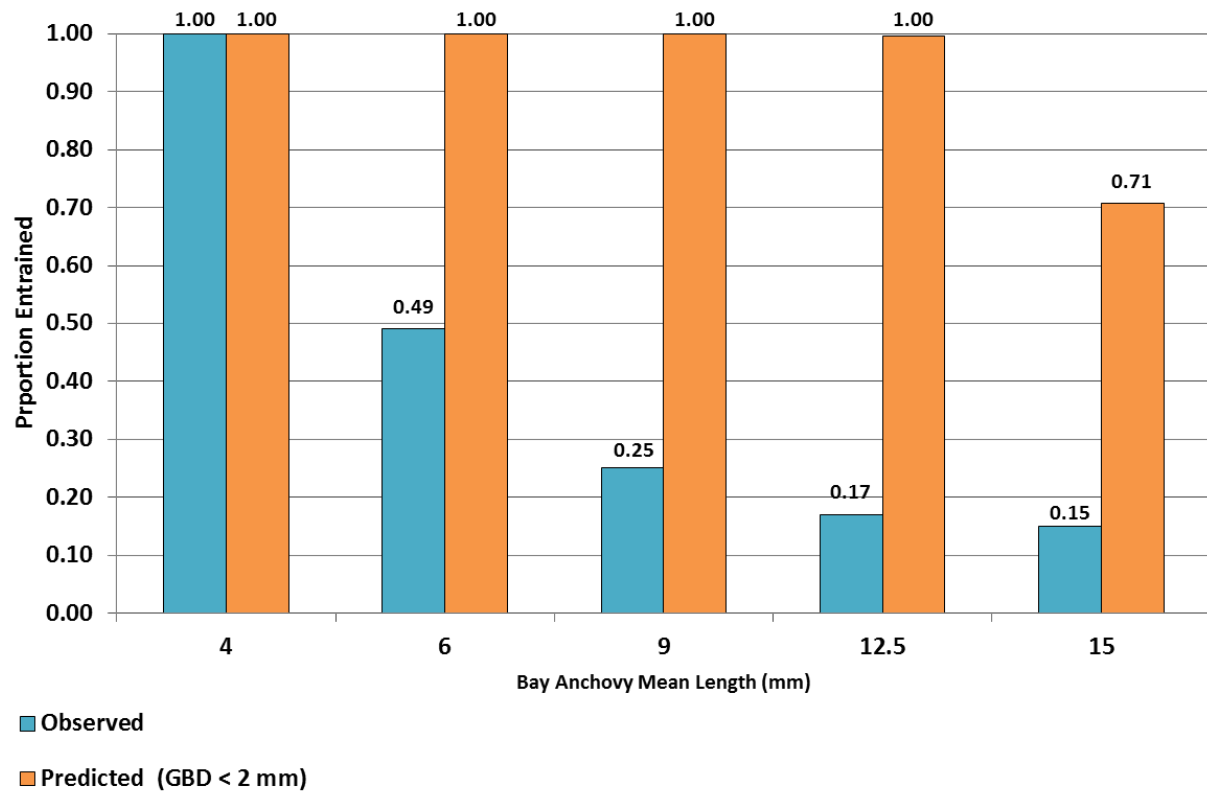

Figure 2. Observed and predicted proportion of Bay Anchovy larvae entrained based on the greatest body depth (GBD) measurements for a 2 mm slot width cylindrical wedgewire screen.

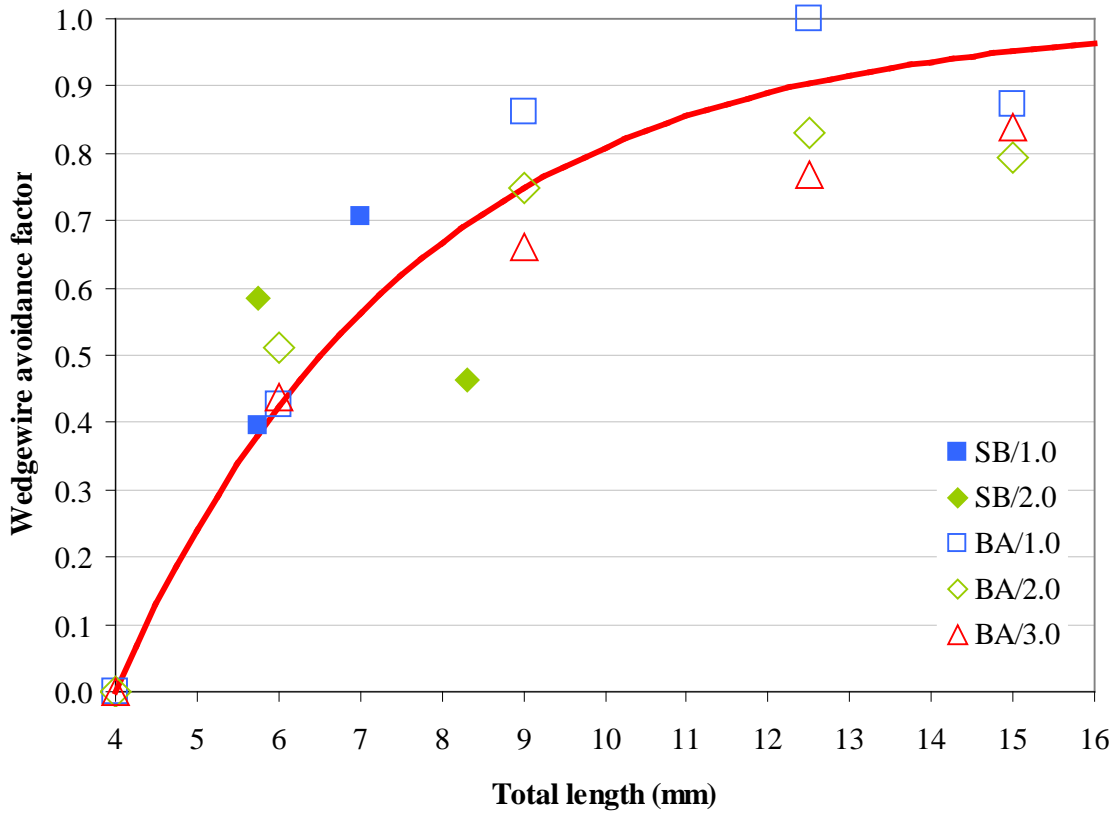

Figure 3. Observed wedgewire avoidance factors by length, species, and slot width, with a generalized relationship between larval length and wedgewire avoidance factor.

Symbols show the data points used to derive the generalized curve  $P_a = 1 - e^{-0.275(L-4)}$  (refer to Table 1 for details); SB=Striped Bass, BA=Bay Anchovy, labels indicate the wedgewire slot width in millimeters.

Table 1. Data used to fit a generalized curve for estimating wedgewire avoidance as a function of length (plotted in Figure 1).

Reference	Species	Slot width (mm)	Total length (mm)	Wedgewire avoidance factor ( $P_a$ )
Weisberg <i>et al.</i> (1987)	Bay Anchovy	1	4	0.000
Weisberg <i>et al.</i> (1987)	Bay Anchovy	2	4	0.000
Weisberg <i>et al.</i> (1987)	Bay Anchovy	3	4	0.000
Heuer and Tomljanovich (1978)	Striped Bass	1	5.75	0.396
Heuer and Tomljanovich (1978)	Striped Bass	2	5.75	0.583
Weisberg <i>et al.</i> (1987)	Bay Anchovy	1	6	0.427
Weisberg <i>et al.</i> (1987)	Bay Anchovy	2	6	0.512
Weisberg <i>et al.</i> (1987)	Bay Anchovy	3	6	0.438
EPRI (2003)	Striped Bass	1	7.0	0.706
EPRI (2003)	Striped Bass	2	8.3	0.464
Weisberg <i>et al.</i> (1987)	Bay Anchovy	1	9	0.860
Weisberg <i>et al.</i> (1987)	Bay Anchovy	2	9	0.747
Weisberg <i>et al.</i> (1987)	Bay Anchovy	3	9	0.662
Weisberg <i>et al.</i> (1987)	Bay Anchovy	1	12.5	1.000
Weisberg <i>et al.</i> (1987)	Bay Anchovy	2	12.5	0.832
Weisberg <i>et al.</i> (1987)	Bay Anchovy	3	12.5	0.769
Weisberg <i>et al.</i> (1987)	Bay Anchovy	1	15	0.874
Weisberg <i>et al.</i> (1987)	Bay Anchovy	2	15	0.793
Weisberg <i>et al.</i> (1987)	Bay Anchovy	3	15	0.839

Length ranges are represented by the midpoints of the ranges, 4 mm was used to represent the  $\leq 4$  mm category, and 15 mm was used to represent the  $\geq 15$  mm category

Table 2. Physical exclusion factors used in the Schiller Station wedgewire screen entrainment reduction analysis, by taxon, life stage, and slot width.

Taxon	Stage	Size (mm)	Physical exclusion factor (P <sub>e</sub> ) by slot width in millimeters					
			0.6	0.69	0.8	1.0	2.0	3.0
American Sand Lance	YSL	0.5	0.0	0.0	0.0	0.0	0.0	0.0
	PYSL	0.6	1.0	0.0	0.0	0.0	0.0	0.0
Atlantic Herring	PYSL	0.9	1.0	1.0	1.0	0.0	0.0	0.0
Atlantic Mackerel	Eggs	1.0-1.3	1.0	1.0	1.0	1.0	0.0	0.0
	PYSL	1.2	1.0	1.0	1.0	1.0	0.0	0.0
Cunner	Eggs	0.8-1.0	1.0	1.0	1.0	0.0	0.0	0.0
	PYSL	0.8	1.0	1.0	1.0	0.0	0.0	0.0
	YOY	1.3	1.0	1.0	1.0	1.0	0.0	0.0
Fourbeard Rockling	Eggs	0.7-1.0	1.0	1.0	0.7	0.0	0.0	0.0
	YSL	0.4	0.0	0.0	0.0	0.0	0.0	0.0
	PYSL	0.9	1.0	1.0	1.0	0.0	0.0	0.0
Grubby	YSL	1.0	1.0	1.0	1.0	1.0	0.0	0.0
	PYSL	1.4	1.0	1.0	1.0	1.0	0.0	0.0
Rainbow Smelt	YSL	0.5	0.0	0.0	0.0	0.0	0.0	0.0
	PYSL	0.7	1.0	1.0	0.0	0.0	0.0	0.0
Rock Gunnel	YSL	1.1	1.0	1.0	1.0	1.0	0.0	0.0
	PYSL	1.3	1.0	1.0	1.0	1.0	0.0	0.0
<i>Urophycis hakes</i>	Eggs	0.7-0.8	1.0	1.0	0.0	0.0	0.0	0.0

YSL=yolk-sac larvae, PYSL=post yolk-sac larvae, YOY=young-of-the-year

Sizes are from Table 6-19 of Attachment 6 of the 2008 Response, representing the limiting dimensions of the organisms (diameter for eggs and greatest body depth for larvae). Range in diameter is shown for eggs; smallest size is shown within each larval stage.

**Table 3. Schiller Station monthly and annual estimates of fish entrainment abundance and equivalent adult losses calculated from 2006-2007 entrainment densities by fish species and life stage and applied to actual intake flows (AIF) from 27 August 2012 through 26 August 2015 for cylindrical wedgewire intake screens of various slot widths, under the most conservative assumption of no active avoidance of the screens by fish larvae (i.e., Equation 1).**

Avoidance assumption: P <sub>a</sub> = 0 (i.e., no avoidance)		2012 2015 AIF	Wedgewire screen slot width					
			0.6 mm	0.69 mm	0.8 mm	1.0 mm	2.0 mm	3.0 mm
<b>Estimated number entrained</b>	January	4,568,218	1,371,434	2,293,344	2,293,344	2,676,449	4,568,218	4,568,218
	February	9,461,768	567,534	6,691,875	6,691,875	6,723,651	9,461,768	9,461,768
	March	5,723,129	9,471	2,541,657	2,541,657	2,560,844	5,723,129	5,723,129
	April	1,118,233	8,128	176,874	181,209	263,713	1,118,233	1,118,233
	May	7,632,599	20,050	25,060	1,190,245	6,717,883	7,632,599	7,632,599
	June	17,976,861	0	0	178,736	16,922,625	17,976,861	17,976,861
	July	13,650,666	4,699	4,699	209,279	13,576,597	13,650,666	13,650,666
	August	9,798,204	2,394	2,394	584,478	9,784,003	9,798,204	9,798,204
	September	204,569	925	925	23,522	195,697	204,569	204,569
	October	19,046	0	0	1,846	19,046	19,046	19,046
	November	589,335	0	0	0	589,335	589,335	589,335
	December	260,824	0	0	0	260,824	260,824	260,824
	<b>Annual</b>	<b>71,003,453</b>	<b>1,984,635</b>	<b>11,736,828</b>	<b>13,896,192</b>	<b>60,290,666</b>	<b>71,003,453</b>	<b>71,003,453</b>
	<b>% reduction</b>	<b>0%</b>	<b>97%</b>	<b>83%</b>	<b>80%</b>	<b>15%</b>	<b>0%</b>	<b>0%</b>

(continued)

Table 3. (Continued)

Avoidance assumption: P <sub>a</sub> = 0 (i.e., no avoidance)		2012 2015 AIF	Wedgewire screen slot width					
			0.6 mm	0.69 mm	0.8 mm	1.0 mm	2.0 mm	3.0 mm
<b>Estimated number of equivalent adult losses</b>	January	87,234	779	1,861	1,861	2,344	87,234	87,234
	February	122,322	322	5,429	5,429	5,469	122,322	122,322
	March	144,906	5	2,062	2,062	2,082	144,906	144,906
	April	30,315	35	187	192	248	30,315	30,315
	May	6,272	87	129	4,157	5,974	6,272	6,272
	June	2,030	0	0	583	2,027	2,030	2,030
	July	4,820	37	53	113	4,820	4,820	4,820
	August	9,770	19	27	91	7,680	9,770	9,770
	September	1,509	7	10	16	203	1,509	1,509
	October	23	0	0	2	23	23	23
	November	744	0	0	0	744	744	744
	December	329	0	0	0	329	329	329
	<b>Annual</b>	<b>410,274</b>	<b>1,292</b>	<b>9,758</b>	<b>14,506</b>	<b>31,944</b>	<b>410,274</b>	<b>410,274</b>
	<b>% reduction</b>	<b>0%</b>	<b>&gt;99%</b>	<b>98%</b>	<b>96%</b>	<b>92%</b>	<b>0%</b>	<b>0%</b>

All estimates represent current actual intake flows from 27 August 2012 through 26 August 2015.

Estimates are the total numbers for the following fish taxa, which represented 95% of entrainment abundance at Schiller Station during the 2006-2007 study: American Sand Lance, Atlantic Herring, Atlantic Mackerel, Cunner, Fourbeard Rockling, Grubby, Rainbow Smelt, Rock Gunnel, and Hakes (*Urophycis* sp.).

Equivalent Adult losses updated from Normandeau 2008 for Cunner and Rainbow Smelt life stage mortality statistics using EPRI 2012 and Enterline et al. 2012, respectively.

Table 4. Schiller Station monthly and annual estimates of fish entrainment abundance and equivalent adult losses calculated from 2006-2007 entrainment densities by fish species and life stage and applied to actual intake flows (AIF) from 27 August 2012 through 26 August 2015 for cylindrical wedgewire intake screens of various slot widths, under a moderately conservative assumption of active avoidance of the screens by 30% of the fish larvae (i.e., Equation 3 with  $P_a = 0.3$ ).

Avoidance assumption: $P_a = 0.3$		2012 AIF	Wedgewire screen slot width					
			0.6 mm	0.69 mm	0.8 mm	1.0 mm	2.0 mm	3.0 mm
<b>Estimated number entrained</b>	January	4,568,218	960,004	1,605,341	1,605,341	1,873,514	3,197,753	3,197,753
	February	9,461,768	397,274	4,684,313	4,684,313	4,706,556	6,623,238	6,623,238
	March	5,723,129	6,630	1,779,160	1,779,160	1,793,778	4,007,378	4,007,378
	April	1,118,233	5,689	123,812	128,147	200,409	798,574	798,574
	May	7,632,599	14,035	17,542	1,019,450	6,547,087	7,456,756	7,456,756
	June	17,976,861	0	0	153,931	16,897,820	17,952,057	17,952,057
	July	13,650,666	3,289	3,289	207,869	11,956,283	12,029,100	12,029,100
	August	9,798,204	1,676	1,676	583,760	7,191,454	7,201,394	7,201,394
	September	204,569	647	647	23,245	156,140	162,351	162,351
	October	19,046	0	0	1,846	15,178	15,178	15,178
	November	589,335	0	0	0	412,535	412,535	412,535
	December	260,824	0	0	0	182,577	182,577	182,577
	<b>Annual</b>	<b>71,003,453</b>	<b>1,389,244</b>	<b>8,215,779</b>	<b>10,187,061</b>	<b>51,933,331</b>	<b>60,038,889</b>	<b>60,038,889</b>
	<b>% reduction</b>	0%	98%	88%	86%	27%	15%	15%

(continued)

Table 4. (Continued)

Avoidance assumption: $P_a = 0.3$		2012 2015 AIF	Wedgewire screen slot width					
			0.6 mm	0.69 mm	0.8 mm	1.0 mm	2.0 mm	3.0 mm
<b>Estimated number of equivalent adult losses</b>	January	87,234	146	1,302	1,302	1,641	61,064	61,064
	February	122,322	57	3,800	3,800	3,828	85,625	85,625
	March	144,906	2	1,443	1,443	1,457	101,434	101,434
	April	30,315	25	131	136	179	21,226	21,226
	May	6,272	76	90	3,103	4,920	5,129	5,129
	June	2,030	0	0	429	1,873	1,876	1,876
	July	4,820	19	37	97	3,616	3,616	3,616
	August	9,770	10	19	83	5,449	6,912	6,912
	September	1,509	5	7	13	149	1,063	1,063
	October	23	0	0	2	18	18	18
	November	744	0	0	0	521	521	521
	December	329	0	0	0	231	231	231
	<b>Annual</b>	<b>410,274</b>	<b>339</b>	<b>6,830</b>	<b>10,409</b>	<b>23,881</b>	<b>288,714</b>	<b>288,714</b>
	<b>% reduction</b>	<b>0%</b>	<b>&gt;99%</b>	<b>98%</b>	<b>97%</b>	<b>94%</b>	<b>30%</b>	<b>30%</b>

All estimates represent current actual intake flows from 27 August 2012 through 26 August 2015.

Estimates are the total numbers for the following fish taxa, which represented 95% of entrainment abundance at Schiller Station during the 2006-2007 study: American Sand Lance, Atlantic Herring, Atlantic Mackerel, Cunner, Fourbeard Rockling, Grubby, Rainbow Smelt, Rock Gunnel, and Hakes (*Urophycis* sp.).

Equivalent Adult losses updated from Normandeau 2008 for Cunner and Rainbow Smelt life stage mortality statistics using EPRI 2012 and Enterline et al. 2012, respectively.



**Table 5. Schiller Station monthly and annual estimates of fish entrainment abundance and equivalent adult losses calculated from 2006-2007 entrainment densities by fish species and life stage and applies to actual intake flows (AIF) from 27 August 2012 through 26 August 2015 for cylindrical wedgewire intake screens of various slot widths, under the realistic assumption that avoidance of the screens by fish larvae increases as the larvae grow longer (i.e., Equation 7).**

Avoidance assumption: $P_a$ function of length	2012 2015 AIF	Wedgewire screen slot width						
		0.6 mm	0.69 mm	0.8 mm	1.0 mm	2.0 mm	3.0 mm	
<b>Estimated number entrained</b>	January	4,568,218	1,080,764	1,807,279	1,807,279	1,828,108	2,486,604	2,486,604
	February	9,461,768	336,424	3,966,823	3,966,823	3,968,186	4,718,024	4,718,024
	March	5,723,129	2,218	595,248	595,248	599,859	1,189,315	1,189,315
	April	1,118,233	5,455	31,008	35,343	85,173	373,167	373,167
	May	7,632,599	4,192	5,042	739,756	6,267,393	7,174,766	7,174,766
	June	17,976,861	0	0	126,523	16,870,412	17,924,649	17,924,649
	July	13,650,666	4,497	4,497	209,077	12,064,463	12,138,047	12,138,047
	August	9,798,204	2,303	2,303	584,388	5,987,098	5,994,858	5,994,858
	September	204,569	925	925	23,522	108,210	110,664	110,664
	October	19,046	0	0	1,846	11,145	11,145	11,145
	November	589,335	0	0	0	49,448	49,448	49,448
	December	260,824	0	0	0	19,995	19,995	19,995
	<b>Annual</b>	<b>71,003,453</b>	<b>1,436,778</b>	<b>6,413,124</b>	<b>8,089,804</b>	<b>47,859,491</b>	<b>52,190,683</b>	<b>52,190,683</b>
	<b>% reduction</b>	0%	98%	91%	89%	33%	26%	26%

(continued)

Table 5. (Continued)

Avoidance assumption: $P_a$ function of length	2012 2015 AIF	Wedgewire screen slot width						
		0.6 mm	0.69 mm	0.8 mm	1.0 mm	2.0 mm	3.0 mm	
<b>Estimated number of equivalent adult losses</b>	January	87,234	877	1,466	1,466	1,493	22,889	22,889
	February	122,322	273	3,218	3,218	3,220	25,827	25,827
	March	144,906	2	483	483	484	17,516	17,516
	April	30,315	34	55	59	74	6,187	6,187
	May	6,272	26	27	1,378	3,195	3,364	3,364
	June	2,030	0	0	258	1,703	1,705	1,705
	July	4,820	50	50	111	4,013	4,013	4,013
	August	9,770	26	26	90	5,679	6,821	6,821
	September	1,509	10	10	16	160	521	521
	October	23	0	0	2	13	13	13
	November	744	0	0	0	62	62	62
	December	329	0	0	0	25	25	25
	<b>Annual</b>	<b>410,274</b>	<b>1,298</b>	<b>5,335</b>	<b>7,081</b>	<b>20,120</b>	<b>88,943</b>	<b>88,943</b>
	<b>% reduction</b>	0%	>99%	99%	98%	95%	78%	78%

All estimates represent current actual intake flows from 27 August 2012 through 26 August 2015.

Estimates are the total numbers for the following fish taxa, which represented 95% of entrainment abundance at Schiller Station during the 2006-2007 study: American Sand Lance, Atlantic Herring, Atlantic Mackerel, Cunner, Fourbeard Rockling, Grubby, Rainbow Smelt, Rock Gunnel, and Hakes (*Urophycis* sp.).

Equivalent Adult losses updated from Normandeau 2008 for Cunner and Rainbow Smelt life stage mortality statistics using EPRI 2012 and Enterline et al. 2012, respectively.

	<b>APPENDIX 4</b>	NO. PSNH011-REPT-001
		REV. 0
		PAGE 1 of 7

## Memo

Date: January 27, 2016  
Subject: Memorandum Summarizing the Differences Between the Wedgewire Screen Designs from the 2008 Report and 2014 Report

### Introduction

The purpose of this memorandum is to document the differences between the wedgewire screen designs and costs presented in the October 2008 report titled “Response to United States Environmental Protection Agency CWA §308 Letter”, and in the October 2014 report titled “Engineering Response Supplement to United States Environmental Protection Agency §308 Letter” provided to Public Service of New Hampshire by ENERCON Services, Inc. and Normandeau Associates, Inc. The 2008 report responded to a general request from EPA which states in regard to the installation of screening technologies:

4. *Please describe engineering aspects or considerations pertinent to considering the possible application of the following technologies at Schiller Station:*
  - ...
  - b. *CWIS screening systems or barrier technology that will minimize entrainment, impingement, and impingement mortality. Each analysis must include a discussion of the major components that would need to be added, and the major modifications to the facility that would need to be undertaken, to retrofit Schiller Station with this technology.*
    - ...
    5. *For each of the technologies evaluated under Item No. 4 above, please provide:*
      - ...
      - g. *An estimate of the cost for installing and operating each of these technologies.*

Given the scope of the request, a very high-level, preliminary assessment was conducted for numerous technologies. Given the regulatory and technological changes in the time since the 2008 Response was issued, and given the operational changes at the Station, ENERCON and Normandeau jointly prepared a supplement to the original 2008 Response in October 2014 (2014 Report) for consideration by the EPA when issuing the draft NPDES permit and draft fact sheet. Given the requirements of the Rule, the 2014 report provided a conceptual

	<b>APPENDIX 4</b>	NO. PSNH011-REPT-001
		REV. 0
		PAGE 2 of 7

design for several impingement-reducing technologies. Because the 2014 report evaluated a more narrow scope of technologies and because the requirements of the 316(b) Rule are more detailed than the generic request by EPA in 2007, a higher level of project definition and detail was attained in the evaluations.

### 2008 Report

In the October 2008 report, ENERCON responded to a §308 information request letter from EPA regarding the upcoming NPDES permit renewal. In response to the request by EPA to provide engineering aspects or considerations concerning several potential technologies, ENERCON provided a high-level assessment of a wide range of potential impingement- and entrainment-reducing technologies. Given the scope of the request by EPA, the level of design and engineering evaluation dedicated to each technology is significantly less than that which would occur in subsequent reports that focused on a smaller set of specific technologies, or a more specific request by EPA.

Given the proposed requirements of the Phase II 316(b) Rule for existing facilities at that time, the report evaluates impingement and entrainment-reducing technologies and operational measures. Under Section 6.2, “Alternate Technologies that Reduce Entrainment,” the report discusses the use of narrow-slot cylindrical wedgewire screens to reduce both impingement and entrainment. Because of the analytical tools available at the time of the report, the wedgewire screens were modelled as exclusion devices only. The only means of entrainment reduction that was captured in the analysis was that due to the slot sizes being small enough to physically block, or exclude the entrainable organisms. As a result, only the smallest slot sizes were investigated, including 1, 0.8, 0.69, and 0.6 mm slot sizes. The design through-screen velocity was selected to be 0.5 feet per second (fps) to reduce the impingement mortality. The number of screens were determined from the screen size and slot size / percent open area necessary to achieve the 0.5 fps through-screen velocity given the design intake flow rate of each Unit. Table 6.1 in the 2008 report presents the required number of screens, screen dimensions, and maximum through-slot velocity for each of the slot sizes evaluated.

Attachment 2 of the 2008 report contains a conceptual layout drawing for wedgewire screens at Schiller Station. This conceptual drawing was created for discussion purposes only, and does not contain detailed information given the scope of EPA’s request. Items such as design loads, soil bearing pressures, bedrock depths, and hydrodynamic loads were not considered in creation of the drawing and are not reflected in the sizing or costing of the structures. In support of creating a comparison between the technologies, a high-level budgetary cost estimate was prepared for each of the technologies. Given the scope of EPA’s request, these cost estimates were budgetary in nature and did not contain the level of detail or rigor necessary to meet the requirements of the comprehensive technical feasibility

and cost evaluation study required by §122.21(r)(10). However, they were created for discussion purposes to compare the various technologies and operational measures.

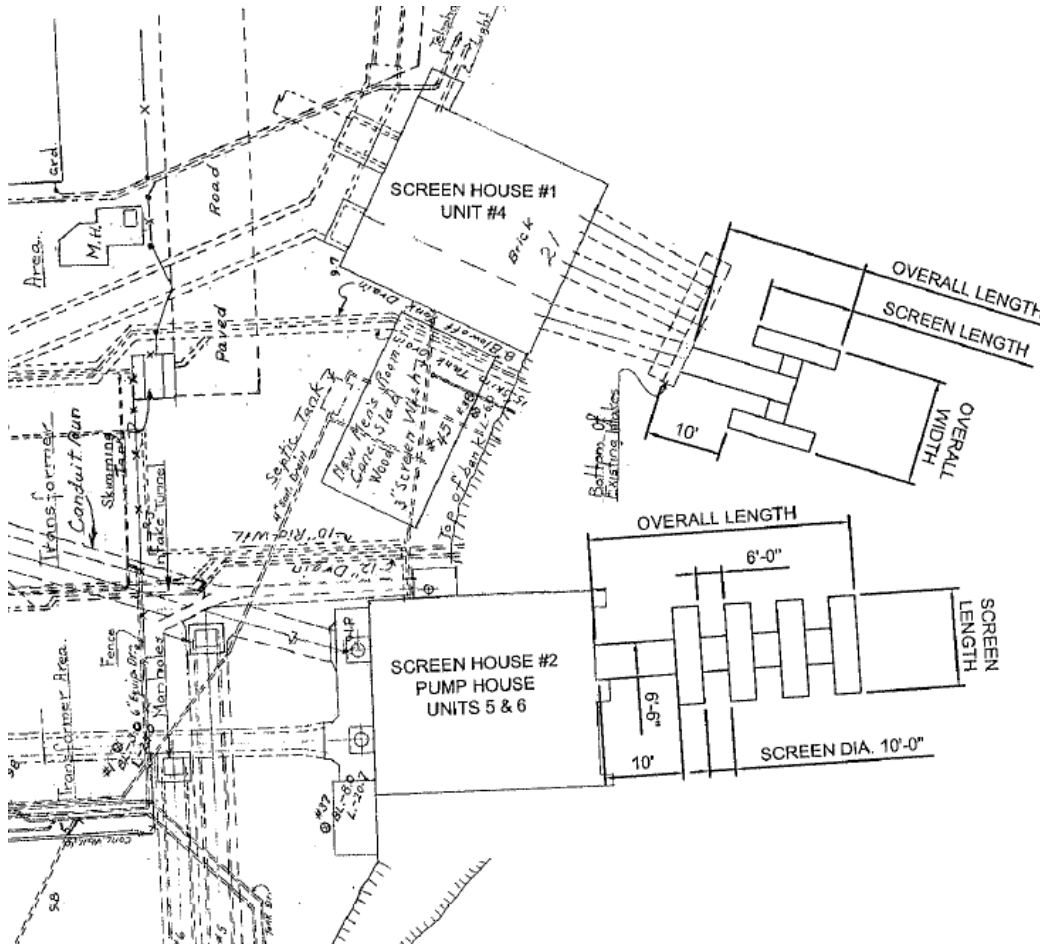

Figure 1: Conceptual drawing from 2008 report

From the 2008 report, the least expensive wedgewire screen option was the design with the 1 mm (i.e., largest) slot size. The implementation cost for this technology was estimated in the 2008 Response to be \$2,476,700. This figure includes \$641,000 in engineering costs and \$1,128,000 in construction costs. The remainder is a \$442,300 recommended minimum contingency, and an estimated \$265,400 for corporate overhead. All of the above figures are in 2008 US Dollars.

The total implementation cost for CWWs as evaluated in the 2008 report is likely conservatively low for several reasons. Firstly, this figure represents a high-level budgetary

	<b>APPENDIX 4</b>	NO. PSNH011-REPT-001
		REV. 0
		PAGE 4 of 7

estimate only. A preliminary design was not performed in creation of the 2008 Response cost estimate; as the level of project definition increases, the number of “unknowns” decreases, and more items can be captured in a cost estimate. Any plant-specific conditions that would require certain design features would not be captured. Therefore, in general, costs tend to increase as the level of project definition increases. As a result, a preliminary design of 1 mm CWWSs for Schiller Station in support of a Class 5 ASTM E2516-11 cost estimate would be expected to exceed the figure shown above. Secondly, the cost estimate above did not consider permitting costs, which would escalate the cost further.

#### 2014 Report

Due to the regulatory and technological changes that occurred following the issuance of the 2008 report, ENERCON and Normandeau issued a supplement to the 2008 report, which provided updates to necessary information contained in the 2008 report. For the purposes of this memorandum, this will be referred to as the “2014 report.” The intention of this submittal was to provide information to EPA that was commensurate in level of detail to that of the requirements of the newly promulgated 316(b) Rule.

The 2014 report evaluated changes in the regulatory environment since the 2008 response, most significantly the issuance of the CWA Section 316(b) Rule on August 15, 2014. For facilities that are designed to withdraw greater than 2 million gallons per day (MGD) and use at least 25 percent of it for cooling purposes, the Rule contains seven different compliance alternatives for meeting the BTA standard for impingement mortality. The report discusses each of these seven alternatives, and describes ways in which the Station could come into compliance. Additionally, the Rule requires facilities with an actual intake flow (AIF) of 125 MGD or greater to submit additional information to the Director so that a BTA for entrainment mortality can be determined on a case-by-case basis. The report shows that the AIF for Schiller Station over the 2011-2013 time period was approximately 73 MGD. Therefore, the 2014 report did not consider Schiller Station to be subject to the additional submittal requirements for entrainment, and evaluated impingement-reducing technologies and operational measures only.

In support of meeting the BTA standard for impingement mortality, ENERCON provided preliminary designs and Class 5 ASTM E2516-11 cost estimates for two impingement-reducing technologies, wide-slot wedgewire screens and barrier nets. The barrier net technology is relatively unproven as an impingement technology, and operating experience from existing installations has shown that frequent inspections are required to monitor for breaks and tears in the net, in addition to net blockage. Due to the high water velocities present at Schiller Station, it is anticipated that frequent repairs would be needed.

	<b>APPENDIX 4</b>	NO. PSNH011-REPT-001
		REV. 0
		PAGE 5 of 7

The 2014 report provided a new design for wide-slot wedgewire screens, meaning that the screens have a slot size of 9.5 mm and are intended to meet the BTA standard for impingement mortality by being designed for a through-screen velocity of 0.5 fps or less. The design utilizes half-screens due to the shallow water depths in front of the intake structure, and ties into the existing intakes in a way that will allow for plant operation to continue in the event of a screen blockage event. The half-screens were also used because the shallow bedrock characteristics of the site would make underwater buried pipe construction more difficult. The half-screens allow for the piping to be installed on-grade, simplifying the construction process. These design details were not apparent during the high-level assessment performed in 2008.

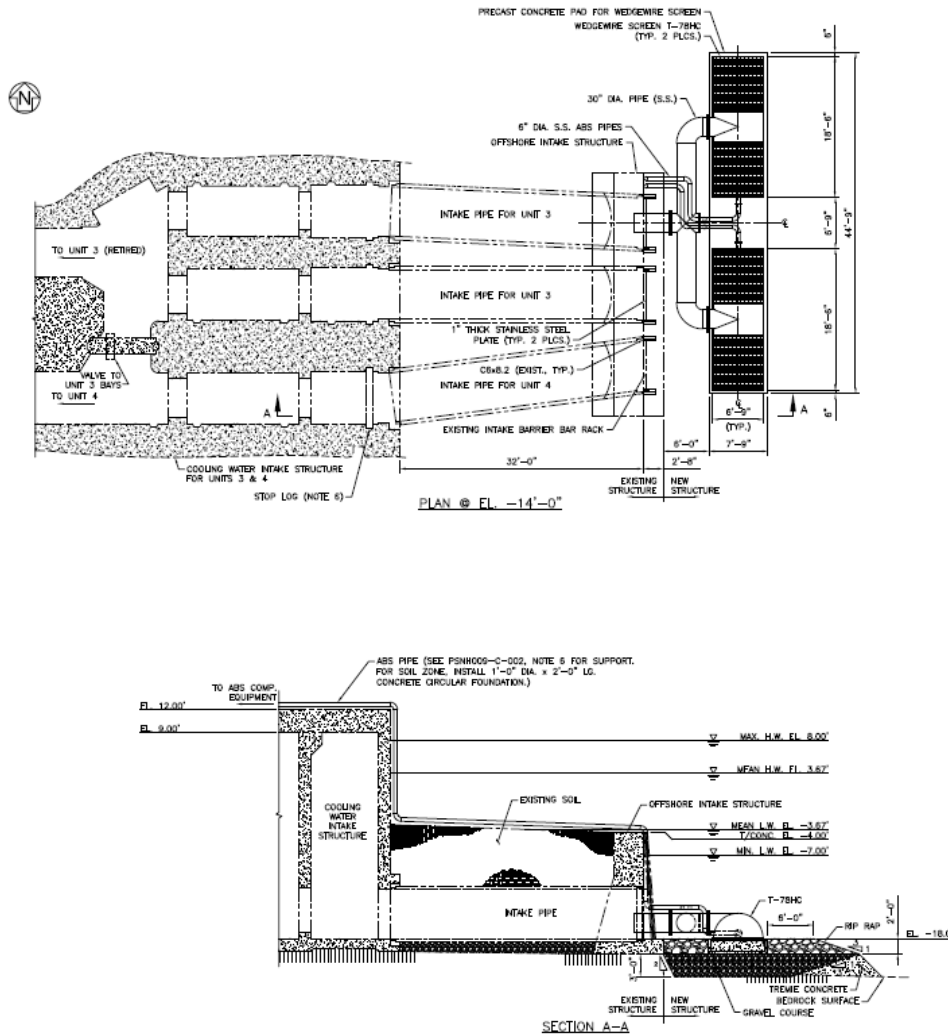

Figure 2: Conceptual drawing of Unit 4 CWWSs from 2014 report

For Unit 4, the screen array connects directly to the northern-most offshore intake in front of Screen House #1, which was formerly utilized by Unit 3. A cross-tie is present within Screen House #1 that would allow the water drawn from the wedgewire screens to be delivered to the Unit 4 circulating water pumps. The retired Unit 3 intake is utilized so that the existing operational Unit 4 intake is available for emergency situations in which the screens become blocked. During this scenario, the normally-lowered Unit 4 stop log would be raised, and flow would pass through the existing Unit 4 offshore intake through the traveling water screens, similar to current operation. The screen system was designed with



	<b>APPENDIX 4</b>	NO. PSNH011-REPT-001
		REV. 0
		PAGE 7 of 7

the intent of maintaining a head loss of 1 ft-H<sub>2</sub>O or less, which would require the system to be slightly oversized, having a design through-screen velocity of 0.33 fps at clean conditions. This was deemed to provide a reasonable margin from an engineering perspective given the concerns regarding screen blockage and icing, and given the Rule requirements to maintain 0.5 fps under all scenarios to comply with the BTA standard for impingement mortality.

For Units 5 and 6, a plenum would be constructed in front of Screen House #2 to collect water from the four wedgewire screens (two for each Unit). From the plenum, the water would enter the Unit 5 and 6 intakes similar to current operations, with the bar racks connecting the screen house to the plenum. In an emergency situation where the screens became blocked, the design of the plenum includes two emergency sluice gates on the front (i.e., river facing) side. These gates would be opened, allowing water to be drawn into the plenum directly. From here, water would pass through the bar racks and traveling screens in Screen House #2, similar to current operation. Similar to Unit 4, the system was designed to maintain a head loss of 1 ft-H<sub>2</sub>O or less, which would require the system to be slightly oversized, with a design through-screen velocity at 0.37 fps at clean conditions. Again, this was deemed to provide a reasonable margin given the concerns regarding screen blockage and icing, and given the Rule requirements to maintain 0.5 fps under all scenarios to comply with the BTA standard for impingement mortality. All of this detailed information in the preceding paragraphs goes well beyond the level of design conducted in support of the 2008 report; therefore, these items are reflected only in the 2014 design. For example, maintaining a head loss of 1 ft-H<sub>2</sub>O and the need to oversize the system is an item that would not have been addressed by the high-level assessment provided in 2008.

The 2014 report contains a Class 5 cost estimate in accordance with ASTM E2516-11. Attachment 1 of the report contains cost estimates for both the barrier net and wedgewire screen technologies. The cost estimates are created based on the expected materials, equipment, and labor required to construct and implement the technology. Attachment 1 of the 2014 report contains a line-by-line estimate of each of the major items that constitute the estimate. Given the level of design, only major cost items are captured, and the remaining items are covered by a project contingency or other allowances. The recommended construction budget for the wide-slot wedgewire screens was \$5,690,000 including permitting. Additionally, an engineering budget of \$460,000 was recommended. The additional design detail contained in the 2014 report allowed for a more accurate cost estimate relative to that which is contained in the 2008 report. For comparison purposes, the 2008 cost estimate was comprised of ten (10) separate items summed together, while the 2014 cost estimate was comprised of fifty (50) separate items.

# Exhibit 2

# EVALUATION OF ALTERNATIVE INTAKE TECHNOLOGIES AT INDIAN POINT UNITS 2 & 3



Prepared for Entergy Nuclear Indian Point 2, LLC, and Entergy  
Nuclear Indian Point 3, LLC

Prepared by:



Enercon Services, Inc.  
500 TownPark Lane, Suite 275  
Kennesaw, GA 30144

February 12, 2010

TABLE OF CONTENTS

Attachments .....	iii
Executive Summary .....	iv
1 Background and Introduction .....	1
1.1 Purpose of this Evaluation.....	1
1.2 Scope and Design Objectives.....	1
2 IPEC Stations and Cooling Systems Description .....	2
2.1 IPEC Units 2 and 3 Overview .....	2
2.2 Description of Plant Processes .....	2
2.2.1 Nuclear Steam Supply System Operations .....	2
2.2.2 Condenser Operation .....	3
2.2.3 Effluent Treatment Operation .....	4
2.3 Source Waterbody .....	5
2.3.1 Source Waterbody Description .....	5
2.3.2 Hydraulic Zone of Influence .....	6
2.3.3 Intake Volume Calculation .....	6
2.4 CWIS Description .....	7
2.4.1 Physical Description, Location and Depth of CWIS .....	7
2.4.1.1 Current Traveling Water (Ristroph) Screens.....	9
2.4.1.2 Fish Handling and Return System.....	11
2.4.2 CWIS Flow Description.....	13
2.4.2.1 Pump Descriptions.....	13
2.4.2.2 Design Intake Capacity.....	16
2.4.2.3 Flow Reductions from Baseline .....	17
2.4.2.4 Through-Screen Velocity .....	19
2.4.2.5 Seasonal Changes in CWIS Operation .....	21
2.4.3 Biocide Treatment.....	21
2.5 Discharge System.....	21
2.6 Cooling System Equipment.....	23
2.7 License Status.....	24
3 Existing CWIS Technologies and Operational Measures that Affect I&E.....	25
3.1 Description of Existing CWIS Technologies and Current Operational Measures that Affect I&E .....	25
3.1.1 Existing Traveling Water Screens .....	25
3.1.2 Existing Fish Handling and Return System .....	26
3.1.3 Flow Reductions .....	27
3.1.3.1 Dual/Variable Speed Pumps.....	27
3.1.3.2 Historic Flow Reductions .....	27
3.1.3.3 Outage Schedule.....	29
3.2 Percent Reductions in I&E from Baseline for Existing CWIS Technologies and Current Operational Measures .....	29
4 I&E Reduction Technologies.....	30
4.1 Upgrade of the Existing Fish Handling and Return Systems.....	30
4.2 Traveling Water Screens .....	31

4.2.1	Alternative Ristroph Screens .....	32
4.2.2	Dual Flow Traveling Water Screens.....	35
4.2.3	Angled Traveling Screens.....	39
4.2.4	WIP Screens.....	43
4.2.5	MultiDisc® Screens.....	48
4.3	Passive Intake Systems.....	51
4.3.1	Cylindrical Wedgewire Screens.....	51
4.3.2	Perforated Pipe Inlets.....	63
4.3.3	Porous Dikes/Leaky Dams.....	65
4.4	Barrier Technologies.....	68
4.4.1	Aquatic Filter Barriers .....	68
4.4.2	Fish Barrier Nets.....	76
4.4.3	Behavioral Barriers .....	79
4.4.3.1	Light Guidance System .....	80
4.4.3.2	Acoustic Deterrents .....	81
4.4.3.3	Air Bubble Curtains.....	82
4.4.3.4	Electrical Barriers.....	84
4.4.4	Louver System .....	86
4.5	Alternate Intake Location.....	88
4.6	Flow Reduction .....	90
4.6.1	Dual/Variable Speed Pumps .....	91
4.6.1.1	Flow Reduction Parameters/Methodology .....	91
4.6.1.2	Flow Reduction Impacts.....	93
4.6.1.3	Effects of Further Operational Flow Reductions.....	97
4.6.1.4	Conversion of Unit 2 to Variable Speed Pumps.....	98
4.6.2	Use of Recycled Wastewater as Cooling Water .....	99
4.6.3	Outage Timing .....	101
4.6.4	Radial Wells.....	102
4.7	Alternative Heat Rejection and Recirculation.....	105
4.7.1	Evaporative Ponds .....	105
4.7.2	Spray Ponds .....	107
4.7.3	Cooling Canals.....	108
4.7.4	In-River Heat Exchangers.....	110
5	Conclusions.....	113
6	References.....	119

**Attachments**

Attachment 1 – Major Components; Vendor Data and References

Attachment 2 – Post-Modification Site Renderings and Conceptual Drawings

Attachment 3 – Evaluation of VSP Performance

Attachment 4 – Capital Costs Assessments

Attachment 5 – Figures

Attachment 6 – Biological Assessment

Attachment 7 – Recycled Wastewater Cooling

### Executive Summary

Entergy Nuclear Indian Point 2, LLC, and Entergy Nuclear Indian Point 3, LLC (collectively, Entergy) have submitted a timely and complete renewal application for a State Pollutant Discharge Elimination System (SPDES) permit (SPDES Permit NY0004472) for Indian Point Energy Center (IPEC) nuclear powered electric generation stations 2 and 3 (individually, Unit 2 and Unit 3, respectively, and collectively, the Stations). The New York State Department of Environmental Conservation staff (NYSDEC) has proposed modifications in the Stations' draft SPDES permit, including possible construction and operation of cooling towers in a closed-loop cooling configuration (NYSDEC Proposed Project). Consideration of closed-loop cooling is subject to certain feasibility and alternative technologies assessments, as directed by the NYSDEC Assistant Commissioner's August 13, 2008 Interim Decision (Interim Decision). Accordingly, the NYSDEC may revisit its proposed modifications to the draft SPDES permit for the Stations and change them pursuant to Entergy's feasibility and alternative technologies assessments.<sup>1</sup>

As part of the alternative technologies assessment, Entergy retained Enercon Services, Inc. (ENERCON) to determine whether an alternative technology exists that "will minimize adverse environmental impact to a level equivalent to that which can be achieved by closed-loop cooling" (see the Interim Decision). In order to obtain reliable aquatic information associated with the existing intake technologies at each Unit, closed-loop cooling, and each alternative technology evaluated, ENERCON relied on aquatic and biological information, including comprehensive entrainment and impingement data, from biological experts Lawrence W. Barnhouse of LWB Environmental Services, Inc., Douglas G. Heimbuch of AKRF, Inc., Mark T. Mattson of Normandeau Associates, Inc., and John R. Young of ASA Analysis & Communication, Inc. (collectively, the Biological Experts).

This Report identifies and evaluates potential alternative technologies to closed-loop cooling, focusing on: (1) technological or engineering feasibility; (2) comparative effectiveness in terms of impingement and entrainment losses (I&E) (based on an evaluation prepared by the Biological Experts, Attachment 6); and (3) estimated cost, based on a detailed, site-specific conceptual design.

Cylindrical wedgewire screens (CWW) are technologically feasible at the Stations. This technology also shows great promise in reducing I&E, based on extensive technical work performed by Alden Laboratories in 2003, 2004 and 2005, as analyzed by the Biological Experts. In addition, CWW screens have been implemented at a facility with a total intake flow rate comparable to the total intake flow rate at the Stations. Specifically, Oak Creek Power Plant in Milwaukee, Wisconsin operates the current largest installation of cylindrical wedgewire screens, which includes an offshore intake system that filters a flow rate of 1,560,000 gallons per minute (gpm) at a through-screen velocity of 0.5 feet per second (fps) with a 16% margin. The CWW system at Oak Creek became operational in January 2009 and is designed to operate year round. This new information provided ENERCON with recent valuable data to evaluate CWW at the IPEC Stations.

---

<sup>1</sup>The Interim Decision provides that NYSDEC must evaluate Entergy's alternative technology assessment and commence a proceeding to modify the draft SPDES permit if it determines that the proposed alternative technology may be substituted for the NYSDEC Proposed Project (i.e., closed-loop cooling).

Several conceptual CWW screening array designs, each fitting within the Stations' exclusionary zone, were created. Although the United States Environmental Protection Agency (EPA) typically recommends cylindrical wedgewire through-slot velocities at or below 0.5 feet per second (fps), NYSDEC has indicated interest in through-slot velocities at or below 0.25 fps. As such, separate conceptual cylindrical wedgewire screen systems were designed to provide a maximum through-slot velocity of at or below both 0.5 fps and 0.25 fps.

Cylindrical wedgewire screens are expected to achieve biological benefits (i.e., reductions in I&E) comparable to those that could be achieved by the NYSDEC Proposed Project. Specifically, operation of cylindrical wedgewire screens with a mesh size of 2.0 mm and through-slot velocity at or below 0.5 fps has the potential to reduce equivalent age 1 (EA1)<sup>2</sup> impingement and entrainment losses from the regulatory baseline<sup>3</sup> by as much as approximately 99.9% and 89.8%, respectively. In addition, the Biological Experts provided an evaluation of the cumulative reductions in I&E over the expected lifetimes of Unit 2 and Unit 3 associated with cylindrical wedgewire screens, as compared to closed-loop cooling. This analysis accounted for a current proposal based on cylindrical wedgewire screen studies to install this technology at Unit 2 by 2013 and Unit 3 by 2015.<sup>4</sup> Closed-loop cooling, by contrast, would not be complete until 2029 based on a schedule derived by ENERCON, with input from counsel and Spectra Energy Transmission, LLC (owner of the Algonquin Gas Transmission Pipeline, which would require relocation in order to construct a closed-loop cooling tower at Unit 3).<sup>5</sup> Based on this evaluation, the estimated cumulative total reduction in EA1 I&E for cylindrical wedgewire screens (98% and 87% for EA1 impingement and entrainment losses, respectively) would be greater than the estimated cumulative total reduction in EA1 I&E for closed-loop cooling (86% and 50% for EA1 impingement and entrainment losses, respectively).

Nonetheless, while promising, before a specific CWW array can be located and operated at the Stations, site-specific analyses would be required to determine the optimal location and slot width for reducing entrainment, with particular focus on the slot width at which fouling (i.e., the accumulation of matter on the screens) would not be a concern to Station operations.

Other alternative technologies were evaluated, but were not recommended due to site-specific issues. As detailed in this Report, for instance, due to nuclear-safety issues, the use of aquatic filter barriers or other technologies that could potentially block the service water intake at each Unit (e.g., fish barrier nets, porous dikes) are not considered as primary alternatives. Several technologies (e.g., spray ponds, evaporative ponds, cooling canals, radial wells) were identified as infeasible due to lack of available land area. The use of coarse or fine mesh traveling water screens of a different mesh size than currently employed at the Stations would not be expected to

---

<sup>2</sup> As noted in Attachment 6, natural mortality of early life stages of fish (i.e., eggs and larvae) is very high. Conversion to equivalent age-1 fish allows I&E that occur at different life stages to be combined into a single metric that weights the losses according to the number that could, on average, have survived to age 1.

<sup>3</sup> As noted in Attachment 6, the regulatory baseline is a regulatory construct that employs certain operation and survival assumptions. This baseline has been used by NYSDEC in SPDES permit proceedings for other New York power plants.

<sup>4</sup> ENERCON has reviewed the proposed schedule described in the biological cumulative analysis (Attachment 6); a detailed schedule for implementation of cylindrical wedgewire screens at the Stations would be created during the detailed design phase.

<sup>5</sup> Engineering Feasibility and Costs of Conversion of Indian Point Units 2 and 3 to a Closed-Loop Condenser Cooling Water Configuration, Enercon Services, Inc., 2010



significantly reduce I&E beyond the existing screening systems. Several technologies (e.g., behavioral barriers) have been studied previously and identified as ineffective at the Stations and would require further evaluation to determine their site-specific technological feasibility.

Upgrades to the existing fish return systems were not recommended because the Stations' existing traveling water screens and fish return systems are considered state-of-the-art for impingement reduction.

## **1 Background and Introduction**

Entergy retained ENERCON to work in conjunction with the Biological Experts to determine whether an alternative intake technology exists that will achieve reductions in I&E comparable to that of the NYSDEC Proposed Project. In order to obtain I&E information associated with the existing intake technologies at each Unit, the NYSDEC Proposed Project, and each alternative technology evaluated, ENERCON relied on aquatic and biological information, including comprehensive entrainment and impingement data, provided by the Biological Experts. This evaluation is pursuant to the Interim Decision, which provides that if Entergy proposes an alternative technology that reduces I&E to a level comparable to the NYSDEC Proposed Project, NYSDEC must commence a proceeding to modify the draft SPDES permit.

### **1.1 Purpose of this Evaluation**

This Report evaluates the technological feasibility, comparative I&E reductions, and estimated costs of several alternative technologies. The Stations' existing technologies and operational measures are also evaluated to provide a comparative basis for assessing alternative technologies.

### **1.2 Scope and Design Objectives**

This Report provides the following:

- In Sections 2 and 3, a detailed description of the operation and features of the existing cooling water intake structures (CWISs) at the Stations, intake flow characteristics, and recent, planned maintenance of the CWISs. These Sections also include an evaluation of the existing technologies and operational measures implemented at the Stations to reduce I&E.
- In Section 4, an evaluation of several alternative technologies.
- In Section 5, relevant conclusions.

## 2 IPEC Stations and Cooling Systems Description

### 2.1 IPEC Units 2 and 3 Overview

Entergy owns and operates Unit 2 and Unit 3, both located in Buchanan, New York on the east bank of the Hudson River. The primary activity of each Unit is the generation of electric power. Entergy Nuclear Indian Point 2, LLC also owns IPEC Unit 1, but it was removed from service in October 1974. Thus, this Report focuses on Units 2 and 3.

Unit 2 and Unit 3 are Westinghouse Pressurized Water Reactors (PWRs) that produce steam for direct use in steam turbines in order to generate electricity. Unit 2 began commercial operation in August 1974 and currently generates electricity at a rated capacity of approximately 1078 MWe [Ref. 6.60]. Unit 3 began commercial operation in August 1976 and currently generates electricity at a rated capacity of approximately 1080 MWe [Ref. 6.64]. The CWISs provide cooling water to absorb waste heat rejected by the Stations. According to 40 CFR §125.93, a CWIS is defined as “the total physical structure and any associated constructed waterways used to withdraw cooling water from waters of the U.S. The cooling water intake structure extends from the point at which water is withdrawn from the surface water source up to, and including, the intake pumps.” Unit 2 and Unit 3 were designed, constructed, and licensed, and are operated, to withdraw cooling water from the Hudson River via two shoreline once-through CWISs. According to 40 CFR Part 125, §125.93, cooling water is defined as “...water used for contact or non-contact cooling, including water used for equipment cooling, evaporative cooling tower makeup, and dilution of effluent heat content.”

### 2.2 Description of Plant Processes

#### 2.2.1 Nuclear Steam Supply System Operations

PWRs are designed to produce electrical energy. Thermal energy is produced by the reactor and transferred to steam. The thermal energy in the steam is converted (via a turbine driven generator) to electrical energy. At Unit 2 and Unit 3, the exhaust steam is converted into water after leaving the turbine and returned to the steam generators as heated feedwater with dissolved and suspended solids removed. There are two major systems used by a PWR to convert the thermal energy of the fuel into electrical energy. The primary system transfers heat from the primary water to the steam generator, while the secondary system transfers the steam formed in the steam generator to the turbine generator. The expanded steam exhausted by the turbine generator is condensed into water by the flow of circulating water through the condenser tubes [Ref. 6.120].

The primary system is also called the Reactor Coolant System (RCS) and consists of four similar heat transfer loops connected in parallel to the reactor vessel. Each loop contains a reactor coolant circulation pump and a steam generator. The RCS also includes a pressurizer, a pressurizer relief tank, the associated piping, and the instrumentation necessary for operational control. The RCS transfers the thermal energy generated in the core to the steam generators where steam is generated to drive the turbine generator. The RCS also provides a boundary for containing the reactor coolant under operating

temperature and pressure conditions, and confines radiological materials. Demineralized water in the reactor coolant loops is maintained under high pressure to prevent the water from boiling. The pressurizer uses electrical heaters and water sprays to maintain water pressure in the reactor coolant loops [Ref. 6.64].

The secondary system is often called the Steam and Power Conversion System (SPCS). The SPCS is designed to remove heat from the reactor coolant in the steam generators, produce steam for use in the turbine-generators, condense the turbine exhaust steam into water, and return the condensed water to the steam generators as feedwater. The major components of this system include the tube side of the steam generators, the turbine-generator, condensers, feedwater pumps, the associated piping, and the instrumentation necessary for operational controls. Feedwater enters the steam generators where it is converted into a steam-water mixture. After a steam swirl vane assembly separates the steam from the water particles, the steam rises through additional separators, which further reduce its moisture content. The saturated steam is then passed through the turbine-generators. Each Unit has a tandem compound turbine comprised of one high pressure turbine and three low pressure turbines that rotate at 1800 rpm. The saturated steam is first passed through the high pressure turbine then through the low pressure turbines. From the low pressure turbines, the steam is exhausted into the condensers where it is condensed and de-aerated, and then returned to the cycle as feedwater to the steam generators [Ref 6.120].

A simplified schematic of a typical PWR plant is shown in Figure 2.1.

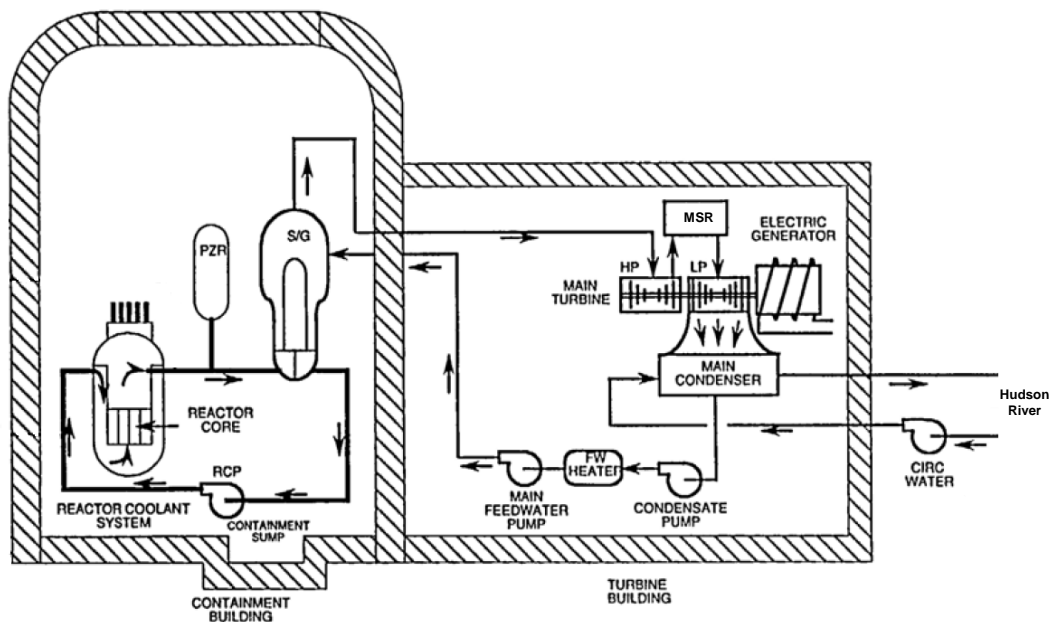

**Figure 2.1 Basic Arrangement of a PWR**

### 2.2.2 Condenser Operation

The objective of the main condenser is to serve as a heat sink (i.e., a mechanism for heat removal) for turbine exhaust steam, turbine bypass steam, steam generator bypass steam,

and other flow [Ref. 6.120]. As such, cooling provided by the condenser is necessary to provide condensed steam (i.e., feedwater) for the steam generators.

Although the Unit 2 and Unit 3 main condensers are not identical, they are similar in that they are of the single pass, divided water box, de-aerating type. Each consists of three shells, one for each low pressure turbine cylinder, and is located directly beneath the low pressure cylinders of the main turbine. The location of the condensers below the low-pressure turbines is indicative of their function, whereby the cooling water of the CW system condenses the steam exhausted from the turbine, which is then returned to the steam generators as feedwater.

Hudson River water is the heat sink for the main condenser and its supported systems. The condenser hotwells are designed for 4-minute storage and are longitudinally divided to facilitate the detection of condenser tube leakages [Ref. 6.60; Ref. 6.64].

Each of the Unit 2 and Unit 3 condensers are rated at the following design parameters [Ref 6.42]:

	<u>Unit 2</u>	<u>Unit 3</u>
Steam condensed	$2.415 \times 10^6$ lbm/hr	$2.453 \times 10^6$ lbm/hr
Heat removed	$2.32 \times 10^9$ BTU/hr	$2.33 \times 10^9$ BTU/hr
Absolute pressure	2.05 in-Hg	2.04 in-Hg
Surface area	315,700 ft <sup>2</sup>	286,125 ft <sup>2</sup>

### 2.2.3 Effluent Treatment Operation

IPEC Unit 2 and Unit 3 have similar systems to process liquid radiological waste (radwaste). Liquid radwaste generated throughout Unit 2 is collected by the waste disposal system (WDS) liquid waste holdup tank (LWHT). The effluent in the LWHT is transferred to the Unit 1 Waste Collection System (WCS), which is comprised of four 75,000 gallon tanks. The effluent from these tanks is sluiced to demineralizer vessels where it is processed using activated charcoal and anion, cation, and macro-reticular resins. The distillate produced by the demineralizer vessels is collected in two distillate tanks. One distillate tank is filled while the other distillate tank is sampled and discharged. When a distillate tank is ready for discharge, it is isolated and sampled to determine the allowable release rate. If the distillate is suitable for release, it is discharged to the Hudson River (via the Unit 1 discharge tunnel). If the contents of the distillate tank are not suitable for release, they are returned to the waste collection tanks for additional processing [Ref. 6.60].

Liquid radwaste generated throughout Unit 3 is stored in three waste holdup tanks. Waste Holdup Tank 31 has a capacity of 24,500 gallons and Waste Holdup Tanks 32 and 33 each have a capacity of 62,000 gallons. If the liquid waste is suitable for discharge from the waste holdup tanks, it can be pumped to one of the two monitor tanks of the Chemical and Volume Control System. When one monitor tank is filled, it is isolated and the effluent is re-circulated and sampled for radiological and chemical analysis while the second tank is in service. If the contents of the monitor tank are suitable for discharge, the effluent is pumped to the Unit 3 SW discharge; otherwise the effluent is returned to the waste holdup tanks for additional processing. Water from the waste holdup tanks can also be pumped

into the demineralization system, which consists of a series of pressure vessels containing activated charcoal and anion, cation, and macro-reticular resins. Effluent processed by the demineralization system is pumped to the Chemical and Volume Control System monitor tanks where it is discharged through the SW discharge or returned to the waste holdup tanks for additional processing [Ref. 6.64].

Unit 2 and Unit 3 have identical systems used to process gaseous waste. Gaseous effluent generated by each Unit discharges to the respective waste gas compressor suction header, where each header flows into one of four gas decay tanks. Any moisture present in the waste gas compressor suction headers is drained to drain tanks that discharge to the WDSs. Gaseous effluent held in the decay tanks can either be returned to the Chemical and Volume Control System holdup tanks, or discharged to the atmosphere if the gases are suitable for release. Discharged gases are released from vents at a controlled rate and, in addition to the effects of normal dispersion, accounting for air turbulence created in the wake of the containment buildings [Ref. 6.60; Ref. 6.64].

## 2.3 Source Waterbody

### 2.3.1 Source Waterbody Description

The lower Hudson River, the source waterbody and heat sink for Unit 2 and Unit 3, is a 152-mile-long tidal estuary extending from the New York Harbor to the Federal Dam at Troy. In the vicinity of IPEC, the Hudson River is approximately 4500 ft wide and 40 ft deep on average, with depths reaching over 60 ft below mean sea level (MSL) just offshore [Ref. 6.82]. The depth directly adjacent to the CWIS is currently dredged to 27 ft below MSL.

The Hudson River in the vicinity of IPEC is subject to a substantial tidal influence and salt water intrusion. All of the lower Hudson River (i.e., from the Federal Dam at Troy to the New York Bay) is tidal, and tidal amplitudes at the Federal Dam average 4.7 ft [Ref. 6.8; Ref. 6.24]. Haverstraw Bay, the location of the closest station to IPEC for which the National Oceanic and Atmospheric Administration (NOAA) publishes data, has a tidal range of 3.23 ft [Ref. 6.81]. There are two flood and two ebb tides within a 24.8-hour interval (i.e., flow past IPEC changes direction by being pushed upstream by salt water tides and pushed downstream by freshwater inflow in a regular tidal rhythm every 12.4 hours), referred to as a “semidiurnal pattern” [Ref. 6.4]. Flow past IPEC during peak tidal flow is approximately 80 million gallons per minute (gpm) [Ref. 6.64]. On average, only 10% of the total lower Hudson River flow is made up by freshwater inflows [Ref. 6.116]. The net downstream flows due to freshwater inflow have been reported to be in excess of 11,670,000 gpm 20% of the time and 1,795,000 gpm 98% of the time [Ref. 6.64]. IPEC is located within the area of the River generally considered brackish, although at certain times in the spring, water in the vicinity of IPEC could be considered fresh due to heavy spring runoff [Ref. 6.24].

The Hudson River can be divided into four salinity zones based on average annual salinities. The mid-estuary section, where IPEC is located, is generally the oligohaline zone (0.5 – 5 parts per thousand salinity). The northern perimeter of this zone marks the

seasonal inland (northernmost) extent of brackish water in the Hudson River. The limits of this zone vary based on the amount of freshwater inflow [Ref. 6.24].

### 2.3.2 Hydraulic Zone of Influence

Several hydrological studies have investigated the Unit 2 and Unit 3 CWISs [Ref. 6.4; Ref. 6.5; Ref. 6.71]. The hydraulic zone of influence establishes where the source of water entering the intake originates, which enables a quantification of the affected volume of the source water body. The combined maximum intake rate calculated for Unit 2 and Unit 3 is approximately 1,762,000 gpm, or just 2.2% of the 80,000,000 gpm average tidal flow rate of the Hudson River [Ref. 6.60]. As shown in Section 2.4.2.3.2, Table 2.1, the average historic combined flow rates for the Stations from 2001 to 2008 is approximately 1,390,000 gpm (2001.2 MGD), and, therefore, makes up only 1.7% of the 80,000,000 gpm average tidal flow rate of the Hudson River.

La Salle Hydraulic Laboratory created a scaled, physical hydraulic model to study Hudson River Flows around the IPEC Stations' CWISs in 1976 [Ref. 6.95]. Water from both downstream and upstream of the Stations supplies the CWIS. The zone supplying water downstream of the Stations was estimated to be 300-350 ft wide. During ebb tide, the study concluded that all water comes to the intakes from a narrow 200-250 ft wide zone upstream of the Stations along the east shore.

Current measurement data collected offshore of IPEC during three tidal cycles showed a maximum flood velocity of 1.5 fps and maximum ebb velocity of 3.3 fps. Based on these maxima, the average flood velocity is 1.0 fps, and the average ebb velocity is 2.1 fps [Ref. 6.11]. The Unit 2 and Unit 3 CWISs have an intake water approach velocity of approximately 1.0 fps at full flow and approximately 0.6 fps at reduced flow [Ref. 6.24].

### 2.3.3 Intake Volume Calculation

In order to characterize the Stations' water use through the CWISs in terms of Hudson River flow, the total design intake volume over one tidal cycle of ebb and flow can be expressed as a percentage of the volume of water column that passes through the area centered about the CWIS opening (4500 ft across, average 40 ft deep). Under 40 CFR §125.83, the tidal excursion is defined as "the horizontal distance along the estuary or tidal river that a particle moves during one tidal cycle of ebb and flow." As noted, the tidal currents in the vicinity of IPEC have an average 12.4 hour tidal cycle of ebb and flow. The maximum tidal excursion for both Units, calculated to be approximately 94,000 ft, is a function of the maximum flow velocity of 3.3 fps [Ref. 6.11] and the tidal period [Ref. 6.114]. Therefore, the volume of Hudson River water flow defined by one tidal excursion at mean low water (MLW) is approximately  $1.26 \times 10^{11}$  gallons for each Unit. The intake volume of Unit 2 over one tidal cycle is approximately  $6.59 \times 10^8$  gallons based on the maximum design cooling water flow of 886,000 gpm (Section 2.4.2.2). For Unit 3 the intake volume over one tidal cycle is approximately  $6.52 \times 10^8$  gallons based on the maximum design cooling water flow of 876,000 gpm (Section 2.4.2.2). As such, the Unit 2 and Unit 3 intake volumes ( $6.59 \times 10^8$  and  $6.52 \times 10^8$  gallons, respectively) each only make up approximately 0.52% of the volume of Hudson River water flow defined by one tidal excursion ( $1.26 \times 10^{11}$  gallons). Note that this percentage of the volume of Hudson River

water flow defined by one tidal excursion is not the same as the percentage of the average tidal flow rate of the Hudson River discussed in Section 2.3.2.

## **2.4 CWIS Description**

As noted in Section 2.1, the Stations have once-through CWISs. Screens are typically placed within the CWISs to filter the source waterbody. After passing through the screens, water is pumped out of the intake structure and delivered through piping systems to the main steam condensers (circulating water systems) and to both the essential and non-essential service water headers for cooling purposes. Each Unit has a separate CWIS that houses the circulating water pumps and the service water pumps that are required to provide adequate and reliable flow to the circulating water and service water systems. In addition, several additional technologies are utilized at each CWIS for the purpose of reducing I&E. As further discussed in Section 3, the Stations' existing traveling water screens (TWSs) and fish return systems are considered state-of-the-art for impingement reduction.

### **2.4.1 Physical Description, Location and Depth of CWIS**

The Stations' CWISs are located approximately 700 ft apart along the shore of the Hudson River.

#### Unit 2

The Unit 2 CWIS is a shoreline intake structure. In contrast to Unit 3 (discussed below), the Unit 2 above-deck mechanical equipment is not covered by a screen house structure. Figures 5-1 and 5-2 of Attachment 5 show plan and section views of the Unit 2 CWIS.

Concrete wing walls form the north and south ends of the Unit 2 CWIS. The inlet to the Unit 2 CWIS is a concrete manifold partitioned into seven independent intake water channels (screenwells). The channels are separated by three foot thick concrete walls. Six of the channels provide River water to the circulating water (CW) pumps. The purpose of the CW pumps is to provide cooling water to the circulating water system. Each CW channel is 13 feet (ft) 4 inches wide and 42 ft high from the back wall to approximately 11 ft from the entrance. After that point, the channels expand outward to a width of almost 15 ft at the entrance. [Ref. 6.48; Ref. 6.49] The center channel is partitioned into two sections and provides River water to the service water (SW) pumps. The purpose of the SW pumps is to provide cooling water to the service water system. Each SW section is 10 ft wide and 42 ft high [Ref. 6.48; Ref. 6.49]. Gated openings are provided between the SW sections and the adjacent CW channels to allow SW flow to be delivered through the CW TWSs [Ref. 6.59].

The opening to the CWIS has a height of 26 ft and is completely submerged at 1 ft below MSL. The lowest portion of the CWIS is located at an approximate elevation of 27 ft below MSL and the concrete deck is at an elevation of 15 ft above MSL [Ref. 6.49]. A debris wall is located at the entrance to the Unit 2 CWIS. The bottom of the debris wall extends to 1 ft below MSL and is designed to restrict floating materials at or just below the surface from entering the CWIS [Ref. 6.62].

Each of the seven Unit 2 intake channels has a coarse bar rack installed to retain pieces of debris larger than 3 inches. The bar racks are constructed of ½ inch by 3 inch bars spaced



3½ inches apart. The bars are mounted vertically (narrow side toward the flow), running the full height of the intake structure [Ref. 6.62]. Large debris that accumulates in front of the bar racks is manually removed by divers.

Unit 2 has eight Ristroph-type TWSs to remove fish from the intake flow and return them to the Hudson River. Unit 2 has one TWS for each CW intake channel and one for each SW intake section, located between the bar racks and CW pumps. The Stations' TWSs consist of a continuous series of wire mesh panels and curved fish handling buckets attached to frames and attached to two matched strands of roller chains. These panels and buckets are commonly referred to as Ristroph Screens. The TWSs service the six CW pumps (CW pumps 21 through 26) and the six SW pumps (SW pumps 21 through 26). The TWSs, discussed in more detail in Section 2.4.1.1, are specifically designed to remove fish using low pressure spray wash nozzles and return them via fish return troughs that have a smooth finish designed to minimize fish abrasion [Ref. 6.41]. Residual debris larger than ½ by ¼ inch is removed using separate high pressure spray wash nozzles and separate debris troughs.

Stop log gates (i.e., barriers that, when deployed, block flow through an intake channel) are provided for the six CW channels and two SW channel sections and are designed to allow inspection and maintenance of the intake channels. Each stop log gate consists of two steel sections. Guide channels in the intake structure walls facilitate the installation and removal of the stop log gates. Chains attached to the stop log gates assist with installation and removal. When installed, the stop log gates isolate the water intake channel from the Hudson River, allowing de-watering for inspection and maintenance purposes under dry conditions. Each CW channel has a single stop log gate located between the TWS and its associated CW pump. Each of the two SW sections has two stop log gates. The SW stop log gates are located between the TWSs and their associated bar racks and between the TWSs and SW pumps.

During periods of high River water temperature when cooling water demands are the greatest, Unit 2 uses up to 16,000 gpm of supplemental River water from the Unit 1 CWIS. The Unit 1 intake structure consists of a concrete bulkhead divided into four intake channels. Each intake channel is 11 ft 2 inches wide and 26 ft high. The two CW pumps (CW 1 and CW 2) for Unit 1 are no longer in service.<sup>6</sup> Two SW intake channels are located within the Unit 1 CWIS, north and south of the CW pump bays. Each SW intake bay houses a River Water (RW) service pump (Pumps 11 and 12) and two TWS pumps (TWS Pumps 11 through 14). One RW pump is active and the other is a standby, such that only one ever operates. River water is supplied to Unit 2 by RW pumps 11 and 12 through a 10 inch pipe.

### Unit 3

The Unit 3 CWIS is also a shoreline intake structure. The screen house for Unit 3 covers the Unit 3 CWIS with a steel-framed structure enclosed with metal panels. Figures 5-3 and 5-4 of Attachment 5 show plan and section views of the Unit 3 CWIS.

---

<sup>6</sup> For informational purposes, Unit 1 was shut down on October 31, 1974 and currently is managed in safe storage condition (SAFSTOR) prior to final decommissioning.

Concrete wing walls form the north and south ends of the Unit 3 CWIS. The Unit 3 CWIS consists of seven intake channels. The channels are served by a common plenum that is 12 ft wide and 120 ft long. Nine bar racks, the bottom of which are located 1 ft below MSL, form the north, south, and west walls of the plenum. Seven of the bar racks are at the west wall with a single bar rack at the north and south ends of the plenum. The opening of each water intake channel is located 12 ft behind the western bar racks. Each CW channel is 13 ft 4 inches wide and 42 ft high. The center channel is partitioned into two sections and provides River water to the SW pumps. Each SW section is 10 ft wide and 42 ft high. Gated openings are provided between the SW sections and the adjacent CW channels to allow SW flow to be delivered through the CW TWSs. These gated openings are normally kept closed [Ref. 6.62].

The opening to the Unit 3 CWIS has a height of 26 ft and is completely submerged at 1 ft below MSL. The lowest portion of the CWIS is located at an approximate elevation of 27 ft below MSL and the concrete deck is at an elevation of 15 ft above MSL. A debris wall is located at the entrance to the Unit 3 CWIS. The bottom of the debris wall extends to 1 ft below MSL and is designed to restrict floating materials at or just below the surface from entering the CWIS.

Each of the seven intake channels has a bar rack installed to retain pieces of debris larger than 3 inches. The bar racks are constructed of  $\frac{1}{2}$  inch by 3 inch bars that are set  $3\frac{1}{2}$  inches apart. The bars are mounted vertically (narrow side toward the flow), running the full height of the intake structure. A PVC-coated wire mesh screen is attached to the River side of the bar racks and extends from 3 ft above MSL to 4 ft below MSL. This screen mesh prevents smaller floating debris from entering further into the intake and clogging the debris and fish return troughs [Ref. 6.62]. Large debris that accumulates in front of the bar racks is manually removed by divers.

Eight Ristroph-type TWSs, one for each CW channel and one each for the SW intake sections, are located downstream of the bar racks. The TWSs service the six CW pumps (CW pumps 31 through 36) and the six SW pumps (SW pumps 31 thru 36). The TWSs, discussed in more detail in Section 2.4.1.1, are specifically designed to remove any fish using low pressure spray wash nozzles and return them to the River via fish return troughs that have a smooth finish designed to minimize fish abrasion. In addition, debris larger than  $\frac{1}{2}$  by  $\frac{1}{4}$  inch is removed using separate high pressure spray wash nozzles and separate debris troughs. Unit 3's stop log gates are similar to those at Unit 2.

#### **2.4.1.1 Current Traveling Water (Ristroph) Screens**

The CWISs at Units 2 and 3 have modified vertical Ristroph-type traveling water screens. These screens were installed following a collaborative research effort among the former owners of the Stations and the Hudson River Fisherman's Association (HRFA), now Riverkeeper, Inc. (Riverkeeper), directed by Dr. Ian Fletcher, then-consultant for the HRFA. The effectiveness of the existing Ristroph-type TWS screens at reducing impingement losses (as compared to angled or traditional traveling screens<sup>7</sup>) is documented in Flow Dynamics and Fish Recovery Experiments: Water Intake Systems

---

<sup>7</sup> These screen types are discussed in more detail in Section 4.2.

(Fletcher Article) [Ref. 6.33]. Dr. Fletcher concluded that Station improvements, beyond the Ristroph-type TWSs installed, were unlikely to significantly reduce impingement losses. Therefore, the existing screens at the Stations are state-of-the-art in terms of minimizing impingement [Ref. 6.33]. In addition, the Fletcher Article [Ref. 6.33] indicates that the NYSDEC adopted the performance of these screens as the State's best technology available for reducing impingement.

The Stations' existing TWS assemblies in the CW intake channels are 13 ft 4 inches wide and 46 ft high. The heights are measured from the center of the head shaft to the center of the tail shaft. The TWSs in the SW intake sections are 8 ft 9 inches wide (north sections) or 7 ft 2 inches wide (south sections) and are each 46 ft high. Each screen is installed in a channel with the screening surface oriented perpendicular to the water flow with each screen including 52 basket segments. The chain rotates over head and foot sprockets, carrying the panels down into the water and around the foot sprockets, then back up through the water and over the head sprockets.

Water passes first through the ascending and then the descending screen baskets, which are constructed of stainless steel 14-gauge oblong-shaped mesh and are framed in a 316L stainless steel structure [Ref. 6.41]. The basket mesh has a ¼-inch wide by ½-inch tall spacing with a total open area of 70.6% [Ref. 6.41; Ref. 6.94]. As discussed further in Section 2.4.2.4, the through-screen velocity for the Unit 2 and Unit 3 CW traveling water screens is 1.61 fps at MLW.

The Ristroph-type TWSs at the Stations are automatically-cleaned screening devices specifically designed to gently remove aquatic species from a channel of flowing water. The ascending basket is located on the western side of the screen facing the CWIS opening and collects fish as it passes up through the water. Aquatic species are collected in the buckets that form the lower (trailing) edge of the mesh frame. A high pressure spray (80-100 psi), specifically designed to avoid the contents of the fish handling buckets, is used to remove any debris impinged on the basket mesh into the front debris trough [Ref. 6.41]. As the baskets rotate around the head sprocket, the contents of the buckets descend on the incline of the mesh panel where three low pressure sprays (10-15 psi) are used to direct impinged fish into the fish return trough [Ref. 6.41]. The baskets continue to descend towards an additional high pressure spray (80-100 psi) that removes any remaining debris into the rear debris trough. As the baskets continue to revolve towards the foot sprocket, any fish and debris that were not originally washed off the screens may be washed off in the flow of water. This fish and debris is considered to be 'carryover' and could potentially enter the CW pump intake.

The TWSs ordinarily operate continuously at 2.5 feet per minute (fpm). The TWSs operate at 10 fpm when a high differential pressure is detected across the screens, indicating a large buildup of debris, until that buildup is cleared. Electric radiant heating elements, installed in the driving head of the TWSs, are energized when the temperature is below 35°F to prevent ice from forming.

Figure 2.2 shows a schematic of the Station's TWS configuration.

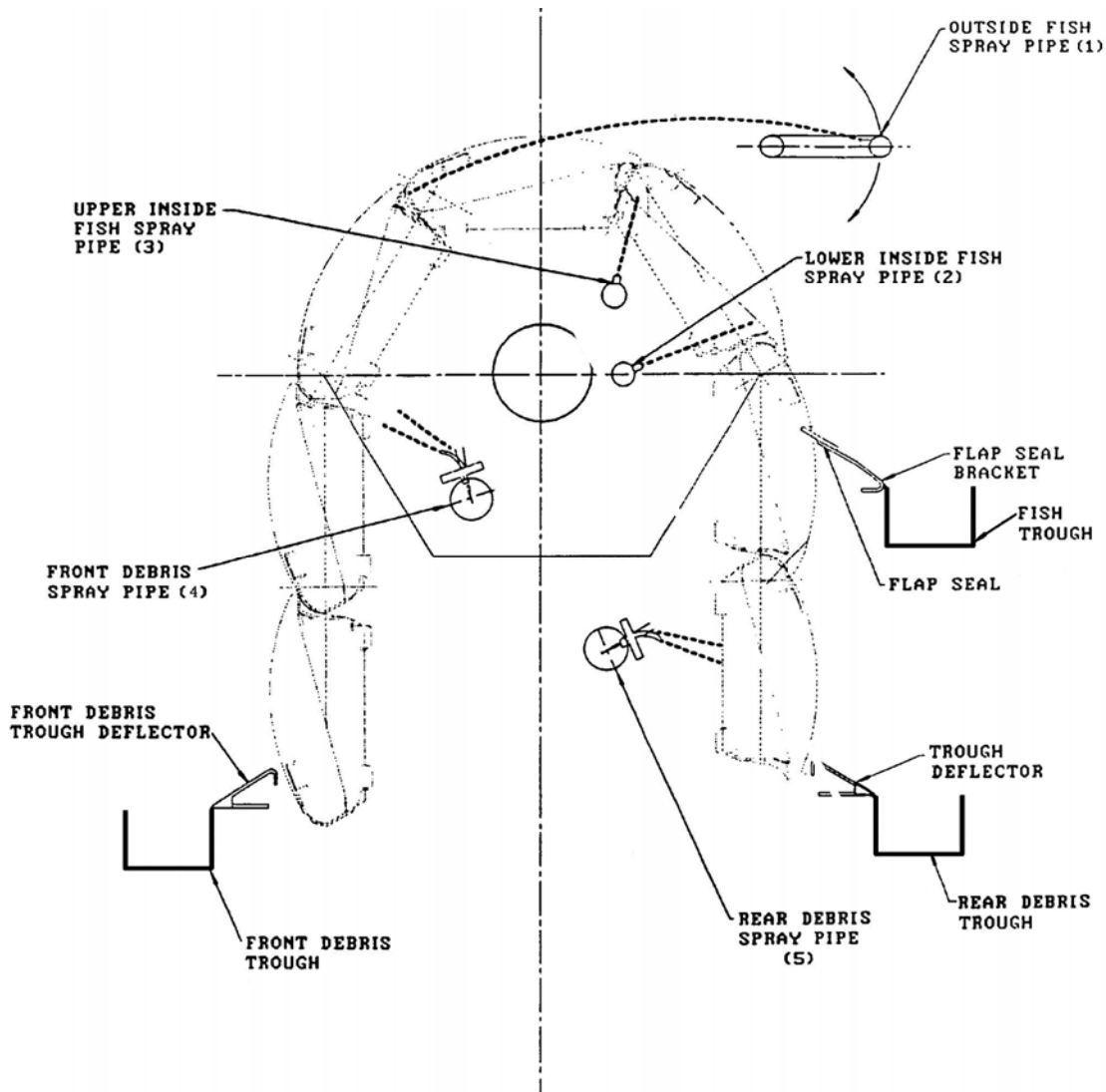

**Figure 2.2 TWS Operation**

### 2.4.1.2 Fish Handling and Return System

The fish handling and return systems at the Stations consist of a series of low pressure water sprays used to transfer fish to fish return troughs that return those fish to the Hudson River. Residual debris is removed via separate high pressure water sprays and debris return troughs. Prior to the installation of each Unit's fish return systems, extensive studies were conducted, and prototype fish return system models were designed. The design and testing of the fish return systems were conducted under the oversight of Dr. Ian Fletcher, consultant for Riverkeeper's predecessor, between 1989 and 1992, with the objective of maximizing fish survival and minimizing reimpingement [Ref. 6.9; Ref. 6.111]. As discussed in Section 2.4.1.1, Dr. Fletcher concluded that Station improvements, beyond the installed Ristroph-type TWSs, were unlikely to significantly reduce impingement losses. Therefore, the existing screens at the Stations are state-of-the-art in terms of minimizing impingement [Ref. 6.33].

The mesh panels and buckets of the traveling water screens are lifted out of the flow and above the operating floor where low pressure and high pressure water spray is directed outward through the mesh to remove impinged fish and debris, respectively. As shown in Figure 2.2, each TWS has three low pressure spray nozzles (10-15 psi) (labeled as fish spray pipes) and two high pressure spray nozzles (80-100 psi) (labeled as debris spray pipes). The fish and debris handling systems consist of three different trough systems. The fish return troughs are located on the east side of the traveling screens. The main (rear) debris troughs are on the east side of the traveling screens below the fish return troughs. The auxiliary (front) debris troughs are located on the west side of the traveling screens [Ref. 6.54]. The locations and elevations of the fish return and debris return troughs correspond with the sequence of high pressure and low pressure spray used to direct fish and debris from the mesh panels.

The Unit 2 and Unit 3 TWSs have separate fish return systems. Both of these intakes have rectangular fish return troughs with clear widths of 36 inches and depths of 12 inches. Unit 2 has one fish return trough for TWSs 21 and 23 and another fish return trough for TWSs 24 and 26. Separate fish return troughs are provided for these adjoining TWS to avoid interferences with the SW TWS screens. Bends and vertical offsets are located south of TWS 21 and north of TWS 26 and transition the fish return troughs into below deck sluices (i.e., slides or chutes) that are approximately 20 inches wide and 12 inches deep. The fish return sluices merge north of the Unit 2 TWSs and transition into a 14-inch diameter fish return pipe that extends 185 ft into the Hudson River, north of the intake structure, at a depth of approximately 34 ft below MSL.

The Unit 3 fish return trough slopes downward between TWSs 31 through 36. South of TWS 31, the fish return trough transitions into a fish return sluice that has identical dimensions. This sluice is located above the concrete deck and runs approximately 113 ft south before transitioning through a 20 ft section into a 10-inch fish return pipe. The fish return pipe runs approximately 148 ft prior to discharging at the northwest corner of the discharge canal at a depth of approximately 10 ft below MSL.

The fish return troughs and sluices are fabricated from ½-inch thick fiberglass. The troughs are designed to maintain a design water depth of approximately 2 inches and a design water velocity between 2-5 fps. The fish return troughs are covered with removable covers or grates in areas where personnel may travel.

Both the main and auxiliary debris troughs are rectangular and have an inner width of 22 inches and an inner depth of 9 inches. The debris troughs are also fabricated from fiberglass and merge prior to transitioning through rounded elbow sections that discharge into the combined debris flume. The combined debris flume travels along the west side of each CWIS and is rectangular with a constant width of 24 inches and varying depths up to 36 inches, with bends ranging from 12 degrees to 45 degrees [Ref. 6.56]. The debris troughs and flume are constructed of fiberglass. South of the Unit 3 CWIS, the combined debris flume transitions into a 14-inch diameter debris pipe that discharges into the discharge canal approximately 217 ft south of the flume at a depth of 6 ft 3 inches below MSL.

## 2.4.2 CWIS Flow Description

As detailed in Section 2.4.1, two primary CWISs supply the Stations with cooling water; one CWIS supplies cooling water to Unit 2, and the other CWIS supplies cooling water to Unit 3. Additional flow from the Unit 1 RW pump can be used to supplement the Unit 2 SW System. There are two distinct cooling water flow values: the baseline flow rate (i.e., maximum design intake capacity) and the average actual intake flow rate. The baseline flow rate, or maximum design intake capacity, is used to design all CWIS screening technologies, and represents the maximum flow value. Baseline flow (maximum design intake flow) means the cooling water design flow values and consists of the following: (1) the condenser cooling water flow through the circulating water pumps, and (2) the service water flow that serves an equipment cooling function. Baseline flow equates to the value assigned, during the cooling water intake structure design, to the expected total volume of water likely to be withdrawn from a source waterbody for cooling purposes, consistent with 40 CFR §125.93 and both as reflected in and consistent with the Updated Final Safety Analysis Report (UFSAR) for each Unit [Ref. 6.60; Ref. 6.64]. The average actual flow rate is the average historical amount of flow entering the CWIS. The average actual flow rate is smaller than the design flow rate, due to lesser flows resulting from outages and periods of reduced cooling demands allowing flow reductions through the use of the dual and variable speed pumps at Units 2 and Unit 3, respectively. Cooling water flow diagrams for the Station's CW and SW systems are shown in Figures 5-5 through 5-8 of Attachment 5. Screenwash water (i.e., water supplied to the screenwash pumps) is not included in the baseline flow rate or the average actual flow rate.

### 2.4.2.1 Pump Descriptions

#### 2.4.2.1.1 Cooling Water Pumps

##### Unit 2

The following sets of pumps supply cooling water to Unit 2:

- The Unit 2 dual speed CW pumps supply once-through cooling water for the CW system from the Unit 2 CWIS. Each of the six CW pumps has a maximum design intake capacity of 140,000 gpm, combining for a total of 840,000 gpm. As shown in Figure 5-5 of Attachment 5, the CW pumps supply Unit 2 Condensers 21, 22, and 23.
- The Unit 2 SW pumps supply River water from the Unit 2 CWIS as a cooling medium to those systems or components requiring heat removal during normal or abnormal plant conditions. The Unit 2 SW pumps also provide screenwash water to TWSs #27 and #28 located in the SW intake channel sections. As shown in Figure 5-6 of Attachment 5, the SW system consists of two supply headers, essential and non-essential, each provided with River water by three SW pumps. The essential header supplies the components requiring cooling during a station blackout or loss of coolant accident. Each of the six SW pumps has a maximum design intake capacity of 5000 gpm, combining for a total of 30,000 gpm.

- The Unit 1 RW pump can supply additional cooling River water from the Unit 1 CWIS to the non-essential Unit 2 SW header. One RW pump has a maximum design intake capacity of 16,000 gpm. The second RW pump is a standby pump and is not included as part of the baseline flow because it does not add to the intake capacity.

### **Pump Specifications**

#### Dual Speed Circulating Water Pumps (6)

- Allis Chalmers Model 96 x 84 YDDVRM
- Each pump is a dual speed pump rated for 140,000 gpm at 21 ft total dynamic head (TDH) when running at 254 revolutions per minute (rpm), and 84,000 gpm at 15 ft TDH when running at 187 rpm. Each pump is driven by a vertical solid shaft squirrel cage induction motor rated for 1000/400 hp at 254/187 rpm, 6600 volts, three phase, 60 Hertz. Dual speed operation is achieved via two sets of motor windings.

#### Service Water Pumps (6)

- Johnston Pump Company Model 18EC-2 Stage
- Each pump is rated for 5000 gpm at 212 ft TDH and driven by a motor rated for 350 hp at 1800 rpm, 480 volts, three phase, 60 Hertz.

#### River Water Pumps (2)

- Allis Chalmers
- The pump is rated for 16,000 gpm and driven by a motor rated for 500 hp at 600 rpm, 440 volts.

### Unit 3

The following sets of pumps supply cooling water to Unit 3:

- The Unit 3 variable speed CW pumps supply once-through cooling water for the CW system from the Unit 3 CWIS. Each of the six CW pumps has a maximum design intake capacity of 140,000 gpm, combining for a total of 840,000 gpm. As shown in Figure 5-7 of Attachment 5, the CW pumps supply Unit 3 Condensers 31, 32, and 33.
- The Unit 3 SW pumps supply River water from the Unit 3 CWIS as a cooling medium to those systems or components requiring heat removal during normal or abnormal plant conditions. As shown in Figure 5-8 of Attachment 5, the service water system consists of two supply headers, essential and non-essential, each provided with River water by three SW pumps. The essential header supplies the components requiring cooling during a station blackout or loss of coolant accident. Each of the six SW pumps has a maximum design intake capacity of 6000 gpm, combining for a total of 36,000 gpm. Three SW backup pumps are available at Unit 3 and each can supply 5000 gpm. The SW backup pumps take

suction from the Unit 2 discharge tunnel and provide flow to the essential and non-essential nuclear services headers.

### **Pump Specifications**

#### Variable Speed Circulating Water Pumps (6)

- Allis Chalmers Model 102 x 84 YDDVRM
- Each pump is driven by a variable speed drive and is rated for 140,000 gpm at 29 ft TDH when running at 360 rpm and 84,000 gpm at 19.5 ft TDH when running at 250 rpm. Each pump is driven by a vertical solid shaft squirrel cage induction motor rated as 1250 hp at 250 rpm, 6900 volts, three phase, 60 Hertz.

#### Service Water Pumps (6)

- Ingersoll-Rand Model 26 APK-1
- Each pump is rated for 6000 gpm at 195 ft TDH. Each pump is driven by a motor rated as 350 hp at 1785 rpm, 480 volts, three phase, 60 Hertz.

#### Backup Service Water Pumps (3)

- Layne & Bowler Pump Company – Specification #4756-9321-05-238-22
- Each pump is rated for 5000 gpm at 220 ft of total dynamic head. Each pump is driven by a Westinghouse motor rated as 350 hp at 1770 rpm, 440 volts, three phase, 60 Hertz.

### **2.4.2.1.2 Screenwash Water Pumps**

#### Unit 2

The following sets of pumps supply screenwash water for Unit 2:

- The Unit 2 CW screenwash system is provided with River water by screenwash pumps located in the Unit 1 intake structure. Each of these 4 screenwash pumps is rated at 2000 gpm, combining for a total of 8000 gpm.
- The Unit 2 SW pumps normally provide screenwash water for the TWSs in the SW channel sections via the SW non-essential header. TWSs #27 and #28 are each provided with up to 164 gpm.

### **Pump Specifications**

#### Screenwash Pumps (4)

- Goulds Pumps Model VIT-CF
- Each pump is rated for 2000 gpm at 234 ft of total dynamic head. Each pump is driven by a motor rated as 150 hp at 1780 rpm, 480 volts, three phase, 60 Hertz.

#### Unit 3

The following sets of pumps supply screenwash water for Unit 3:



- The Unit 3 screenwash pumps take suction from CW intake channels #34, #35, and #36 downstream of the traveling water screens. Each of the 3 screenwash pumps is rated for 3200 gpm, combining for a total of 9600 gpm.

### **Pump Specifications**

#### Circulating Water Screenwash Pumps (3)

- Ingersoll-Rand Model 24 APK-1
- Each pump is rated for 3200 gpm at 250 ft of total dynamic head. Each pump is driven by a motor rated as 250 hp at 1785 rpm, 460 volts, three phase, 60 Hertz.

### **2.4.2.2 Design Intake Capacity**

NYSDEC regulations do not define water sources subject to 6 NYCRR §704.5. However, the United States Environmental Protection Agency (EPA) defines cooling water as "...water used for contact or non-contact cooling, including water used for equipment cooling, evaporative cooling tower makeup, and dilution of effluent heat content." (See 69 Fed. Reg. 41576, 41684, July 9, 2004; 40 CFR Part 125, §125.93). Screenwash water (i.e., the water supplied to the screenwash pumps) is not regulated by EPA and is included here for informational purposes only. Consistent with EPA regulations, in this Report the baseline flow of the Stations is comprised of the cooling water design intake capacities.

#### **Cooling Water Design Intake Capacity**

##### Unit 2

Under normal power generating operation, the Unit 2 SW pumps and the CW pumps can draw in 870,000 gpm of cooling water from the Unit 2 CWIS. The Unit 1 RW pumps can draw in 16,000 gpm of cooling water to supplement the Unit 2 SW System. Unit 2 has a maximum design intake capacity for cooling water as follows:

##### Cooling Water Design Intake Capacity (886,000 gpm)

- Up to 840,000 gpm from the Unit 2 CW pumps is used as non-contact cooling water<sup>8</sup> in the condenser [Ref. 6.60, Section 10.2.4].
- Up to 30,000 gpm from the Unit 2 SW pumps is used as non-contact cooling water for the essential and non-essential heating loads<sup>9</sup> [Ref. 6.60, Section 9.6.1].
- Up to 16,000 gpm from the Unit 1 RW pump is used as non-contact cooling water for the Unit 2 non-essential SW heating loads [Ref. 6.57].

Unit 2 accounts for approximately 50.3% of the total cooling water design intake capacity for the Stations.

<sup>8</sup> Non-Contact Cooling Water is water used to reduce temperature which does not come in direct contact with any raw material, intermediate product, a waste product or finished product.

<sup>9</sup> The essential loads are those which must be supplied with cooling water immediately in the event of a blackout and/or loss of coolant accident. The cooling water for these loads is supplied by the nuclear SW header. The non-essential loads are those which are supplied with cooling water from the conventional SW header.

### Unit 3

Under normal power generating operation, the SW pumps and the CW pumps can draw in 876,000 gpm of water from the Unit 3 CWIS. Unit 3 has a maximum design intake capacity for cooling water as follows:

#### Cooling Water Design Intake Capacity (876,000 gpm)

- Up to 840,000 gpm from the Unit 3 CW pumps is used as non-contact cooling water in the condenser [Ref. 6.64, Section 10.2.4].
- Up to 36,000 gpm from the Unit 3 SW pumps is used as non-contact cooling water for the essential and non-essential heating loads [Ref. 6.64, Section 9.6.1]. Backup service water pumps are standby pumps and are not included because they do not add to the intake capacity.

Unit 3 accounts for approximately 49.7% of the total cooling water design intake capacity for the Stations.

### **Screenwash Water Design Intake Capacity**

#### Unit 2

The Unit 2 traveling water screens (TWSs #27 and #28) can use screenwash water from the discharge of the Unit 2 SW pumps. Water from screen wash pumps #21 through #24 located in the Unit 1 CWIS is also used to supply screenwash water to Unit 2. Unit 2 has a design intake capacity for screenwash water as follows:

#### Screenwash Water Design Intake Capacity (8328 gpm)

- Up to 328 gpm (164 gpm per screen) can be supplied to traveling water screens #27 and #28 during regular operation from the discharge of the Unit 2 SW pumps.
- Up to 8000 gpm (4 pumps at 2000 gpm) from the screen wash pumps in the Unit 1 CWIS can be supplied to the TWSs servicing the CW channels. This flow can also be used as a backup source of wash water to TWSs #27 and #28.

#### Unit 3

The Unit 3 screenwash pumps can draw in screenwash water from the Unit 3 CWIS. Unit 3 has a design intake capacity for screenwash water as follows:

#### Screenwash Water Design Intake Capacity (9600 gpm)

- Up to 9600 gpm (3 pumps at 3200 gpm) is supplied to the screenwash pumps during regular operation. The screenwash pumps take suction from circulating water intake channels #34 thru #36 following the traveling water screens.

### **2.4.2.3 Flow Reductions from Baseline**

It is generally assumed that a direct linear (1:1) relationship exists between flow reduction and the number of fish entrained or impinged. Periods of reduced power at each Unit contribute to reduced intake flow as well as use of the Stations' existing dual/variable speed pumps. When scheduled, these flow reductions represent a reduction

in the baseline flow and are, therefore, considered to be an operational measure to reduce I&E.

### 2.4.2.3.1 Maintenance & Refueling Outages

At the Stations, maintenance and refueling outages (i.e., scheduled outages) are currently scheduled to occur approximately every 24 months for each Unit, and are anticipated to last approximately 25 days. Scheduled outages are staggered so that both Units are not offline at the same time. When a Unit is offline, some CW and SW would still be present after shutdown and prior to startup. Adequate SW flow must also be provided when the Unit is offline in order to maintain essential cooling of nuclear safety-related systems, including the containment cooling and recirculation systems, component cooling systems, instrument air cooling systems, radiation monitoring cooling systems, and, emergency diesel generator cooling systems. Therefore, even during outages some flow is drawn through the CWISs for CW and SW system cooling needs.

### 2.4.2.3.2 Historic Operational Intake Flow Rate

Outages and periods of reduced power decrease the actual amount of flow entering the CWIS. When scheduled, these flow reductions represent a reduction in the baseline flow and, therefore, are considered to be an operational measure to reduce I&E.

The Stations supplied eight years (2001-2008) of measured intake flow data for Units 2 and 3, in millions of gallons per day (MGD); the Unit 2 data includes CW, SW, and Unit 1 RW flow, and the Unit 3 data includes CW and SW flow. Table 2.1 shows the monthly and annual average historic flows for the Stations. The average annual historic (2001-2008) intake flow rate<sup>10</sup> for Unit 2<sup>11</sup> is 1102.2 MGD, which represents a 13.6% reduction in flow from the baseline flow value of 1275.8 MGD. For Unit 3, the annual average historic intake flow rate is 899.0 MGD, which represents a 28.7% reduction in flow from the baseline flow value of 1261.4 MGD.

**Table 2.1 Average Historic Flow Rates (2001-2008)  
in Millions of Gallons per Day (MGD)**

Month	Unit 2	Unit 3
January	1001.1	600.1
February	924.1	583.2
March	908.4	500.9
April	940.5	614.8
May	1107.5	899.6
June	1243.6	1199.1

<sup>10</sup> The average annual historic (2001-2008) intake flow rate is a weighted average determined using the number of days in each month with respect to the number of days in one year.

<sup>11</sup> All Unit 1 RW flow is considered to be Unit 2 historic operational SW flow.

Month	Unit 2	Unit 3
July	1248.7	1227.1
August	1252.3	1217.4
September	1253.2	1234.8
October	1209.1	1170.1
November	1007.8	806.5
December	1115.3	715.2
Average Annual	1102.2	899.0

The differences in Unit 2 and Unit 3 flow rates can be attributed to several factors. First, the SW capacity at Unit 2 (SW is 30,000 gpm and RW is 16,000 gpm) is greater than the SW capacity at Unit 3 (36,000 gpm). In addition, the condensers and low pressure turbines at each Unit have different designs, efficiencies, and operational requirements that necessitate substantially different flow requirements. Furthermore, Unit 2 has more issues with debris loading than Unit 3, requiring more flow to clean the systems.

#### 2.4.2.4 Through-Screen Velocity

According to 40 CFR §125.94, if a facility reduces the through-screen velocity to at or below 0.5 fps, it is “deemed to have met the impingement mortality performance standards”. Based on the maximum design intake capacity through each CWIS (cooling water and screenwash water) and a mean low water (MLW) elevation (i.e., 1.0 ft below MSL), the through-screen velocity can be approximated by using the following equation and inputs [Ref. 6.94]:

$$\text{Through-Screen Velocity} = Q / (\text{BW} * \text{LW} * \text{POA} * \text{K})$$

where

Q is the flow rate in gpm

BW is the screen width in feet

LW is the depth at MLW in feet (26.0 ft<sup>12</sup>)

POA is the “percent open area” of the screen basket

K is a conversion factor based on screen type (396 for through flow screens)

<sup>12</sup> LW depth is the difference between MLW elevation (-1.0 ft MSL) and the elevation of the bottom of the CWIS (-27.0 ft).

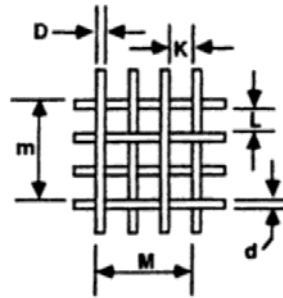

POA for rectangular-mesh screens can be approximated by using the following equation and inputs [Ref. 6.94]:

$$\text{Percent Open Area} = ((K*L)/(K+D)(L+d))*100$$

where

K is the width of the opening (inches)

L is the length of the opening (inches)

D is the warp wire<sup>13</sup> diameter (inches)

d is the shute wire<sup>14</sup> diameter (inches)

### Unit 2

The maximum design intake capacity for the CW system at Unit 2 is approximately 140,000 gpm per channel. The six traveling water screens for the CW channels in the Unit 2 CWIS have a screen width of 12 ft and a depth of 26 ft at MLW. The percent open area is 70.55% based on a warp wire diameter and shute wire diameter of 0.064 inches (14-gauge wire) and mesh opening size of ½ × ¼-inches. Based on these inputs, the through-screen velocity for the CW traveling water screens is 1.61 fps at MLW.

The maximum design intake capacity for the SW system at Unit 2 is approximately 30,000 gpm. The two traveling water screens for the SW channel sections have a screen width of 5 ft 11 inches and a depth of 26 ft at MLW. The percent open area is 70.55%. Based on these inputs, the through-screen velocity for the Unit 2 SW traveling water screens is 0.35 fps at MLW.

### Unit 3

The maximum design intake capacity for CW intake channels #31 through #33 is approximately 140,000 gpm. The maximum design intake capacity for the CW intake channels #34 through #36 is approximately 143,200 gpm (one CW pump and one screenwash pump in each channel). The six traveling water screens for the CW channels in the Unit 3 CWIS have a screen width of 12 ft and a depth of 26 ft at MLW. The percent open area is 70.55%. The through-screen velocity for the traveling water screens in CW channels #34 through #36 is 1.64 fps at MLW. Traveling water screens #31 through #33 have a through-screen velocity of 1.61 fps at MLW.

<sup>13</sup> Warp wire runs the length of the mesh.

<sup>14</sup> Shute wire runs the width of the mesh.

The maximum design intake capacity for the SW system at Unit 3 is approximately 36,000 gpm. The two traveling water screens for the SW channel sections have a screen width of 5 ft 11 inches and a depth of 26 ft at MLW. The percent open area is 70.55%. Based on these inputs, the through-screen velocity for the Unit 3 SW traveling water screens is 0.42 fps at MLW.

#### **2.4.2.5 Seasonal Changes in CWIS Operation**

Unit 2 and Unit 3 have dual speed pumps and variable speed pumps, respectively, that allow the volume of River water withdrawn to be reduced when colder River water temperatures are available. The Stations use best reasonable efforts to operate the Unit 2 and Unit 3 dual/variable speed pumps so as to keep the volume of River water withdrawn at the minimum required for efficient operation, considering ambient River water temperature, plant operating status, and the need to meet SPDES permit conditions [Ref. 6.86; Ref. 6.89].

Also, the conventional, non-essential service water header for Unit 2 can be supplied with supplemental River water from the Unit 1 River Water service header during periods of high River water temperature. This is known as three-header operation, and is the preferred operating mode when the River water temperature is greater than 65°F [Ref. 6.58] (i.e., during periods of high River water temperature, additional flow is required to satisfy the heat rejection requirements of the SW system).

#### **2.4.3 Biocide Treatment**

The CW and SW systems for Unit 2 and Unit 3 are protected from marine growth (micro-fouling) and mussels (macro-fouling) with biofouling control. The biofouling control is implemented by the application of sodium hypochlorite through injection headers and diffusers located in the River water intake channels behind the traveling water screens and before the CW and SW pumps. All of the positive displacement pumps are operated manually and take suction from sodium hypochlorite storage tanks.

In accordance with the SPDES permit [Ref. 6.86], the SW systems may be chlorinated continuously, while chlorination of the CW systems is limited to two hours per unit per day and a total of nine hours per week. In addition, chlorination of the CW systems must be performed during the day, and the CW systems for the two units cannot be chlorinated simultaneously. The chlorination systems are removed from service when the average River water temperature is below 40°F or if the onsite chemistry and engineering departments determine that there is no benefit from continued chlorination.

### **2.5 Discharge System**

The CW Systems provide once-through cooling water to the condensers, and the SW Systems supply cooling water to various nuclear components and conventional components (e.g., Emergency Diesel Generators, Closed Cooling Water Heat Exchangers, etc.). The water from each system is discharged back to the Hudson River through a common discharge canal. As discussed in Unit 3 UFSAR, the Hudson River has been designated as the Ultimate Heat Sink (i.e., the source of cooling water provided to dissipate reactor decay heat and essential cooling system heat loads after reactor shutdown) because it is capable of supplying a reliable, long-

term source of cooling water [Ref. 6.64]. As such, the River provides a nuclear safety function.

### Unit 2

Water for the CW System passes from the Unit 2 CWIS through the condenser and is then discharged via six 96" outside diameter (OD) pipes into a 20 ft wide discharge tunnel, approximately 150 ft long running NE to SW. Water for the SW system is also discharged into the Unit 2 discharge tunnel. From the Unit 2 condenser outlet, the discharge tunnel turns and travels approximately 60 ft SE to NW to an adjustable weir. The outfall from the weir discharges into the common discharge canal for Units 1, 2, and 3 [Ref. 6.50; Ref. 6.51].

### Unit 3

Water for the CW System passes from the Unit 3 CWIS through the condenser and is then discharged via six 96" OD pipes into a 20 ft wide discharge tunnel, approximately 140 ft long running NE to SW. Water for the SW system is also discharged into the Unit 3 discharge tunnel. From the Unit 3 condenser outlet, the discharge tunnel turns and travels approximately 60 ft SE to NW to an adjustable weir. The outfall from the weir discharges into a 100 ft long channel prior to joining the common discharge canal for Units 1, 2, and 3 [Ref. 6.52; Ref. 6.53].

### Common Discharge Canal

The common discharge canal for Units 1, 2 and 3 runs northeast to southwest for approximately 700 ft underneath and alongside the Unit 1 and Unit 3 turbine buildings, respectively [Ref. 6.43; Ref. 6.44; Ref. 6.53]. This portion of the discharge canal is approximately 36 ft wide. The common discharge canal turns towards the River after reaching the Unit 3 discharge tunnel inlet, running NE to SW for approximately 260 ft [Ref. 6.45; Ref. 6.53]. The common discharge canal runs approximately 240 ft along the River bank prior to reaching the 255 ft wide common outfall (i.e., Outfall 001) [Ref. 6.45; Ref. 6.86].

The outfall is comprised of twelve sub-surface diffuser ports (4 ft tall by 15 ft wide spaced 21 ft apart, center to center) which are located 12 ft beneath the water surface (at MLW) along the west wall of the discharge canal. Two of the twelve discharge ports have fixed gates that are normally closed and ten have adjustable gates that are mechanically aligned to maintain a differential head of 1.75 ft across the outfall structure. These gates are used to assure the minimum discharge velocity of 10 fps required for adequate mixing of the discharge water with Hudson River water [Ref. 6.63]. The first port is approximately 600 ft south of the Unit 3 intake structure [Ref. 6.24]. The separation between the intake and the discharge is designed to minimize recirculation of warmed discharge effluent. Discharge temperatures are limited in accordance with the SPDES Permit [Ref. 6.64].

The outfall structure and relevant land are leased to Entergy by the New York State Energy Research and Development Authority (NYSERDA). This lease is dated July 1, 1971 and is subject to renewal on March 31, 2017 [Ref. 6.92].

## 2.6 Cooling System Equipment

Table 2.2 describes the significant installation, maintenance, and replacement dates for equipment and components used in the Stations' cooling systems.

**Table 2.2 History of Key CWIS Components at Unit 2 and Unit 3**

Equipment	Originally Installed	Date and Description of Component Replacement
<b>Unit 2</b>		
Bar Racks	1974	Original still in place.
Service Water Sluice Gates	1974	1985, Replaced the original pneumatically operated sluice gates installed between the service water and circulating water bays in the intake structure due to corrosion.
Traveling Screens	1974	1983, Installed fine mesh screens in the intake structure at the inlet to the service water pump bays. 1984, Installed spray wash piping that is used to clean the fine screens. 1985, Installed Ristroph Screen in screen well 26 for survival testing. 1991, Installed Ristroph Screens. 2007, Replaced traveling water screen 25.
Fish Return System	1997	Original still in place.
Screen Wash Pumps	1974	1991, Replaced with four Goulds Pumps Model VIT-CF.
Service Water Pumps 21 through 26	1974	1998, Replaced Layne & Bowler and Aurora service water pumps with pumps manufactured by Johnston Pumps Company. Previous pumps required frequent maintenance. Existing motors were reused. 2006, Replaced motor in SWP 25.
Hypochlorite Injection Pumps	1974	1986, Install two diffusers to continuously chlorinate service water bays. 1993, Installed saran lined piping connected to diffusers located in stop log frames for TWSs 27 and 28. Two chlorine monitors and two zebra mussel monitors were also installed at this time. 2003, Installed two 5000 gallon hypochlorite storage tanks.
Circulating Water Pumps 21 through 26	1974	1985, Installed Allis Chalmers dual speed circulating water pumps. 1986, Installed 2 metering pumps and piping. 1990, Installed 3 metering pumps. 2001, Replaced SSW Hypochlorite piping. 2003, Replaced CWP 26 Motor and expansion joint. 2004, Replaced CWP 22 Motor rotating element.
<b>Unit 3</b>		
Bar Racks	1976	1992, Replaced upper bar racks. 1996, Installed wire mesh above the racks to keep out floating debris. 2009, Replaced upper and lower bar racks.
Service Water Sluice Gates	1976	Original still in place.



**Table 2.2 History of Key CWIS Components at Unit 2 and Unit 3**

Equipment	Originally Installed	Date and Description of Component Replacement
Traveling Screens	1976	1986, Installed traveling water screen to provide redundancy in the event of a blocked screen. 1988, Replaced traveling water screen 37 and piping providing screenwash water to this screen due to severe deterioration. 1989, Replaced traveling water screen 36. 1994, Installed Ristroph Screens.
Fish Return System	1994	Original still in place.
Screen Wash Pumps	1976	1994, Replaced with Ingersoll Rand 24 APK-1 pumps.
Service Water Pumps 31 through 36	1976	1988, Replaced existing Layne and Bowler pumps with Ingersoll Rand single stage pumps to prevent suction of debris from bottom of Intake Structure and minimize vibration. Fiberglass baffling added in front of new pumps to prevent hydraulic interactions between the pumps. Ingersoll Rand 26 APK-1 pumps are rated for 6000 gpm at 195 ft of total dynamic head.
Service Water Pumps 37 through 39	1976	1994, Permanent installation of chlorination nipple, valves, and cap.
Hypochlorite Injection Pumps	1976	1995, Replace existing storage tank with an 1800 gallon tank manufactured by Composites USA, Inc. Replacement tank is insulated with moisture resistant insulation. 1998, Replaced continuous chlorination pumps 31 and 32. 2008, Replaced hypochlorite storage tank.
Circulating Water Pumps 31 through 36	1976	1989, Allis Chalmers variable speed circulating water pumps installed. 1986, Installed 2 metering pumps and piping. 1990, Installed 3 metering pumps. 2001, Replaced SSW Hypochlorite piping. 2003, Replaced CWP 32.

Note that the traveling water screens and other CWIS equipment routinely undergo preventative maintenance and periodic refurbishments that are not accounted for here.

## 2.7 License Status

Applications were submitted to the NRC to renew the respective Unit 2 and Unit 3 operating licenses for an additional 20 years under 10 CFR Part 54 on April 30, 2007. For Unit 2 and Unit 3, the requested renewals would extend the license expiration dates to midnight September 28, 2033, and midnight December 12, 2035, respectively [Ref. 6.24].

### **3 Existing CWIS Technologies and Operational Measures that Affect I&E**

This section describes existing Station intake technologies. The Stations also employ operational measures that can affect I&E. EPA has defined a uniform baseline configuration (40 CFR §125.93) designed to ensure consistent decision-making among different facilities as follows:

...the cooling water system has been designed as a once-through system; the opening of the cooling water intake structure is located at, and the face of the standard 3/8-inch mesh traveling screen is oriented parallel to, the shoreline near the surface of the source waterbody; and the baseline practices, procedures, and structural configuration are those that your facility would maintain in the absence of any structural or operational controls, including flow or velocity reductions, implemented in whole or in part for the purposes of reducing impingement mortality and entrainment.

New York has adopted this baseline definition and endorsed full design flow on 365 days per year as baseline flow [Ref. 6.91]. This section discusses the following existing CWIS technologies and operational measures, previously described in Section 2.4, that differ from the EPA baseline and reduce I&E at the Stations:

- Modified Ristroph-type traveling water screens
- Fish handling and return systems
- Low pressure screenwash systems
- Flow reductions due to dual/variable speed pump operation
- Flow reductions due to maintenance outages

In addition to these existing CWIS technologies and operational measures, Units 2 and 3 also have cooling system designs (i.e., low temperature rise across condensers, rapid transit through cooling system, return of water near point of withdrawal) that permit entrainment survival, as discussed in Attachment 6. Based on the fish survival data provided for the existing Unit 2 and Unit 3 CWISs in Attachment 6, IPEC's existing CWIS technologies and operational measures produce quantifiable reductions from the regulatory baseline I&E, as shown in Section 3.2. Assessments of the qualitative features of each component of the existing CWIS are provided in Section 3.1.

#### **3.1 Description of Existing CWIS Technologies and Current Operational Measures that Affect I&E**

##### **3.1.1 Existing Traveling Water Screens**

As described in Section 2.4.1, the CWISs at Units 2 and 3 have modified vertical Ristroph-type traveling water screens which were installed pursuant to the Hudson River Settlement Agreement [Ref. 6.40]. These screens were installed following a collaborative research effort among the former owners of the Stations and Riverkeeper's predecessor and directed by Dr. Ian Fletcher, then-consultant for Riverkeeper's predecessor. Dr. Fletcher concluded that improvements beyond the screens installed at the Stations were unlikely to

significantly reduce impingement losses and, therefore, the existing screens at the Stations represent the state-of-the-art in terms of minimizing adverse impacts for impingement [Ref. 6.33]. As discussed in Section 2.4.1.1, the traveling water screens at each Unit have the following features:

- Low approach and through-screen velocities – Low through-screen and approach velocities increase the likelihood that fish may escape the intake flow and therefore reduce the potential for impingement [Ref. 6.94]. Refer to Section 2.4.2.4 for a thorough discussion of these velocities.
- Continuous operation – The modified traveling screens are rotated continuously. If accumulation of fish and/or debris on the screens occurs, the same amount of water must pass through a smaller available open area, thus increasing both the through-screen velocity and the differential head loss. As the head losses and velocities increase, it is more likely that fish cannot escape the screen area and become impinged [Ref. 6.94]. Impingement is less likely to occur when the available screen open area is maintained by the continuous removal of fish and/or debris from the screens.
- Flow deflector lip on fish bucket – The curved lip at the leading edge of the fish bucket is designed to minimize vortex stresses on fish inside the buckets. The lip eliminates turbulent flow in the interior of the buckets, allowing fish to maintain a stable, upright position [Ref. 6.35]. Water is also retained by the curved lip, maintaining sufficient water volume for fish in the bucket.
- Spray washes – As noted in Section 2.4.1.2, the screens encounter a series of spray washes in the operating rotation. First, high-pressure sprays remove debris from the screens; spray deflectors prevent disturbance to fish in the fish bucket from these sprays. Then, low-pressure sprays aid in freeing fish from the surfaces of the overturning screen panels by gently spraying water through the screen mesh. Due to the gentle nature of the flow, the low-pressure sprays lose effectiveness when debris covers the screen; the high-pressure sprays must wash off debris first, to ensure effective fish recovery [Ref. 6.35]. Finally, another series of high-pressure screens washes off any remaining debris before the screens rotate back to the intake flow. This final wash reduces ‘carryover’ debris that could potentially enter the pump intakes and assists in maintaining the available open area, which reduces the potential for impingement.
- Smooth screen mesh – The  $\frac{1}{2} \times \frac{1}{4}$ -inch clear opening slot mesh on the screen basket panels is smooth to minimize abrasion to fish transferred into the fish return sluices [Ref. 6.8].

Each of these features contributes to the reductions in impingement losses detailed in Section 3.2. Alternative screening technologies to further reduce I&E are discussed in Section 4.2.

### **3.1.2 Existing Fish Handling and Return System**

Extensive studies, conducted under the oversight of NYSDEC staff and the predecessor to Riverkeeper (HRFA), were performed over several years at the Stations prior to the design and implementation of the current fish return systems. The fish collected in the fish

buckets attached to the traveling water screens are returned to the Hudson River by the fish handling and return system. The low-pressure sprays facilitate the transfer of fish to the fish collection sluices, which deliver fish to return pipes. The Unit 2 return pipe discharges into the Hudson River north of the Stations' CWISs, and the Unit 3 return pipe discharges at the northwest corner of the Stations' combined discharge canal. The discharge locations of the fish return pipes were selected after conducting dye and fish release studies to find locations that would minimize reimpingement [Ref. 6.8]. The design and testing of the fish return systems were conducted under the oversight of HRFA (i.e., Riverkeeper's predecessor) expert, Dr. Ian Fletcher, between 1989 and 1992, with the objective of maximizing fish survival and minimizing reimpingement [Ref. 6.9; Ref. 6.111]. The current fish return systems at Unit 2 and Unit 3 incorporate several features that improve fish survival:

- Removable covers or grates over fish troughs [Ref. 6.54; Ref. 6.55].
- Design water depth maintained at approximately 2 inches [Ref. 6.61].
- Design trough water velocity between 2-5 fps [Ref. 6.9].
- Selection of return pipe discharge locations designed to prevent returned fish from immediately reentering the intake structure [Ref. 6.8].

The fish handling and return systems at IPEC are considered state-of-the-art, and upgrades to the current fish return systems would not be expected to provide appreciable biological benefits.

### **3.1.3 Flow Reductions**

Certain flow reduction strategies offer potential I&E reduction opportunities. The Stations' dual/variable speed pumps allow intake flow to be minimized based on operating requirements. In addition, periods of reduced power at each Unit also contribute to reduced intake flow.

#### **3.1.3.1 Dual/Variable Speed Pumps**

As described in Section 2.4.2.1, Unit 2 is equipped with dual speed CW pumps, and Unit 3 is equipped with variable speed CW pumps. The pumps can be used to minimize the volume of River water drawn through the CWISs, thus minimizing I&E [Ref. 6.89]. Required flow rates are dependent upon intake water temperature, and typically allow reduced flow from late October until early May, not accounting for scheduled outages [Ref. 6.24]. In addition to the ambient River water temperature, flow rates are influenced by plant operating status and SPDES permit conditions.

#### **3.1.3.2 Historic Flow Reductions**

The monthly baseline flows (in millions of gallons per day), and the average monthly historic operational flow provided by the Stations, are shown in Table 3.1 and Table 3.2 below, along with the corresponding flow reduction percentages. As discussed in Section 2.4.2.3.2, the Unit 2 historic flows include CW, SW, and Unit 1 RW flow, and the Unit 3 historic flows include CW and SW flow. Historical data for Station operation and

associated flows for the past eight years (2001-2008) indicate an average historic operational flow reduction of 13.6% for Unit 2 and 28.7% for Unit 3.

Note that, as discussed in Section 2.4.2.3.2, several factors contribute to the differences in Unit 2 and Unit 3 flow rates. First, the SW capacity at Unit 2 (46,000 gpm; Unit 2 SW and Unit 1 RW) is greater than the SW capacity at Unit 3 (36,000 gpm). In addition, the condensers and low pressure turbines at each Unit have different designs, efficiencies, and operational requirements that necessitate substantially different flow requirements. Furthermore, more flow is required to clean the Unit 2 systems due to more debris issues at Unit 2 than at Unit 3.

**Table 3.1 Unit 2 Monthly Flow Reduction from Baseline**

Month	Baseline Flow (MGD)	Historic Operating Flow (MGD)	Average Flow Reduction
January	1275.8	1001.1	21.5%
February	1275.8	924.1	27.6%
March	1275.8	908.4	28.8%
April	1275.8	940.5	26.3%
May	1275.8	1107.5	13.2%
June	1275.8	1243.6	2.5%
July	1275.8	1248.7	2.1%
August	1275.8	1252.3	1.8%
September	1275.8	1253.2	1.8%
October	1275.8	1209.1	5.2%
November	1275.8	1007.8	21.0%
December	1275.8	1115.3	12.6%
Average Annual	1275.8	1102.2	13.6%

**Table 3.2 Unit 3 Monthly Flow Reduction from Baseline**

Month	Baseline Flow (MGD)	Historic Operating Flow (MGD)	Average Flow Reduction
January	1261.4	600.1	52.4%
February	1261.4	583.2	53.8%
March	1261.4	500.9	60.3%
April	1261.4	614.8	51.3%
May	1261.4	899.6	28.7%
June	1261.4	1199.1	4.9%
July	1261.4	1227.1	2.7%
August	1261.4	1217.4	3.5%
September	1261.4	1234.8	2.1%
October	1261.4	1170.1	7.2%
November	1261.4	806.5	36.1%

**Table 3.2 Unit 3 Monthly Flow Reduction from Baseline**

Month	Baseline Flow (MGD)	Historic Operating Flow (MGD)	Average Flow Reduction
December	1261.4	715.2	43.3%
Average Annual	1261.4	899.0	28.7%

### 3.1.3.3 Outage Schedule

As discussed in Section 2.4.2.3, periods of reduced power decrease the actual intake flow entering the Station’s CWISs. This flow reduction represents a reduction from the baseline flow and, where quantifiable and reasonably expected, is considered to be an operational measure to reduce I&E. Outages are scheduled, where reasonably practicable, in a manner sensitive to entrainment considerations, typically during the late spring entrainment period, with the result that only one Unit is operating during that approximately 25 day outage period each year [Ref. 6.24].

## 3.2 Percent Reductions in I&E from Baseline for Existing CWIS Technologies and Current Operational Measures

Based on the data provided in Attachment 6, the Stations’ existing CWIS technologies and operational measures produce quantifiable I&E reductions from the regulatory baseline. As noted in Attachment 6, the regulatory baseline is a regulatory construct that employs certain operation and survival assumptions. This baseline has been used by NYSDEC in SPDES permit proceedings for other New York power plants. The reductions in I&E at the Stations are characterized in terms of equivalent age 1 (EA1) fish rather than as total losses summed over all life stages (as noted in Attachment 6, there are different life stages of fish). The EA1 metric weights losses of different life stages according to their expected survival rates. For example, if only 10% of eggs for a particular species would be expected to die before hatching, then entraining a single larva is equivalent to entraining 10 eggs. If 0.1% of larvae would be expected to survive to become one-year-old fish, then entraining 1000 larvae or 10,000 eggs would be equivalent to removing a single one-year-old fish from the population. Using the EA1 metric to compare technology alternatives ensures that the comparisons weight all life stages equally according to their potential future contributions to the population (see Attachment 6 for further discussion). As shown in Tables 10 and 11 of Attachment 6, Appendix A, the existing CWIS technologies and operational measures at the Stations reduce EA1 entrainment by approximately 33.8%, and reduce EA1 impingement by approximately 80.2% compared to the regulatory baseline. According to Attachment 6, the NYSDEC Proposed Project would reduce EA1 entrainment losses by approximately 96.3 to 97.6% and EA1 impingement losses by approximately 98.9 to 99.3% compared to the regulatory baseline. However, NYSDEC has identified a range of acceptable technology performance, measured in reduced entrainment (more than 60% reduction) and impingement (more than 80% reduction), for other existing New York power stations [Ref. 6.87]. Therefore, consistent with the Stations’ existing technology being considered state-of-the-art for impingement, impingement is limited to NYSDEC acceptable levels. For this reason, this Report primarily focuses on entrainment reductions.

## 4 I&E Reduction Technologies

This section reviews potential alternative technologies and operational measures for reducing I&E associated with the Stations from the regulatory baseline. The evaluation focuses on engineering, biological, and cost factors consistent with the Interim Decision. The engineering factors include technological feasibility and reliability, proven installation at comparable facilities, and nuclear safety concerns, where relevant. If installation of the alternative technology is feasible based on the engineering factors, the evaluation estimates the associated reductions in I&E from the regulatory baseline, as provided in Attachment 6. Technologically feasible means that a particular technology likely can be implemented at comparable steam-electric generating stations and, as qualified, at the Stations to reduce I&E without implicating nuclear safety considerations.

For certain alternative technologies, very preliminary capital and operational costs are estimated using conceptual models appropriate at this stage of the analysis (see Attachment 4). However, costs are likely understated due to unknown site-specific conditions. For this reason, a Recommended Minimum Contingency of 30% was added to all cost estimates [Ref. 6.25; Ref. 6.113]. A typical cost multiplier of 30% was employed to capture both corporate overheads and the cost of carrying the associated funding (i.e., a Corporate Overheads and Work In Progress Cost). In addition, the preliminary estimates provided in this Report do not account for several complicating factors, including radiological contamination, zoning restrictions and archeological considerations in place at IPEC.

Potential modifications to the CWIS for a nuclear facility, such as IPEC, where each Unit's CWIS combines the circulating water and service water intakes, are complicated by the fact that service water flow is related to nuclear safety, and must be available at all times (i.e., for normal operations, shutdown, and projected accident conditions). Therefore, any potential technology that could introduce new failure modes into the service water systems, or that could interfere with maintaining the service water supply, implicates nuclear safety concerns and, therefore, would require further evaluation.

Technological feasibility may be qualified if the technology is unprecedented (i.e., not demonstrated at any comparable facility). In addition, as discussed in Section 3.2 and Section 4.1, the Stations' existing technology is considered state-of-the-art for impingement; this Report primarily focuses on entrainment reductions. As such, technologies that would not provide substantial reductions in entrainment are not considered as viable alternatives to the current intake technologies at the Stations.

### 4.1 Upgrade of the Existing Fish Handling and Return Systems

As discussed below, no improvements to the existing fish handling and return systems are necessary. The main objective of any fish return system is to return impinged fish to the water body with minimal stress. As discussed in Section 3.1.2, fish return designs vary to accommodate the size and type of fish being transported. The Unit 2 and Unit 3 TWSs at the Stations have separate fish return systems that are described in Section 2.4.1.2.

As part of the Hudson River Settlement Agreement, consultation and mutual concurrence among interested environmental parties, including Riverkeeper (then known as the Hudson

River Fisherman's Association), was required for the design of the fish return systems [Ref. 6.9]. Therefore, prior to the installation of the Stations' fish return systems, extensive studies were conducted, and prototype fish return system models were designed. The design and testing of the fish return systems were conducted under the oversight of Dr. Ian Fletcher, biologist for the Hudson River Fishermen's Association (the predecessor to Riverkeeper), between 1989 and 1992 [Ref. 6.9; Ref. 6.111]. Offshore dye studies were conducted to determine the best location for the fish return pipe discharges to limit recirculation, and live fish release studies were performed to determine the optimum discharge depths for the fish return pipes. Design models of the Unit 2 and Unit 3 fish return systems were installed at a nearby quarry and tested. The results of these tests indicated that the full systems would not impose injuries to the test species (white perch, striped bass, golden shiner, and alewife) under expected operating conditions [Ref. 6.9].

Per Siemens Water Technologies (Siemens), an industry leader in the design of fish return systems and traveling water screens, the fish return systems at Units 2 and 3 are considered to be state-of-the-art. Furthermore, Siemens does not recommend any upgrades to the fish return systems that would improve survivability rates (see Attachment 1, Section 1). As discussed in Section 2.4.1.1, in the Fletcher Article [Ref. 6.33], Dr. Fletcher concluded that improvements beyond the screens installed at the Stations were unlikely to significantly reduce impingement losses [Ref. 6.33]. In addition, the Fletcher Article [Ref. 6.33] indicates that the NYSDEC adopted the performance of these screens as the State's best technology available for reducing impingement.

### Conclusions

The Stations' fish return systems at Units 2 and 3 are considered to be state-of-the-art, and Siemens does not recommend any upgrades that would improve survivability rates (see Attachment 1, Section 1). Based on the previous studies performed under the oversight of Dr. Ian Fletcher, the (relative) recent vintage of the fish return systems, and Siemens' review, upgrades to the current fish return systems are not expected to provide appreciable impingement benefits. The system does not impact entrainment.

## **4.2 Traveling Water Screens**

Traveling water screens can be designed with coarse mesh ( $> 2.0$  mm) or fine mesh openings ( $\leq 2.0$  mm) [Ref. 6.115]. Generally, entrainment decreases with smaller mesh sizes, as fine mesh screens impinge organisms that are typically entrained through coarse mesh screens. However, as discussed in Attachment 6, mortality from impingement can offset entrainment reductions, depending on species and life stage of the fish being impinged instead of entrained. Smaller mesh sizes also increase the possibility of significant fouling and heavy debris loading on the screening panels. Mortality of early life stage organisms impinged on fine mesh screens can increase due to stresses caused by the resultant higher debris loads, increased through-screen velocities, and increased pressure differentials.

In certain circumstances, traveling screens, such as through flow, dual flow, and center flow screens, can be fitted with fine mesh screen material. Where entrainment is a seasonal occurrence, existing traveling water screens can be retrofitted with interchangeable fine mesh panels or fine mesh inserts laid over and fastened to the permanent coarse mesh screens for



seasonal operating requirements (e.g., a facility could replace the coarse mesh or install fine mesh inserts during the entrainment season to reduce the entrainment of eggs) [Ref. 6.115].

The following sections evaluate alternative screening technologies to the existing coarse mesh Ristroph screens. A mesh opening size of 2.0 mm was selected for the conceptual designs of fine mesh screening systems to provide a consistent comparison between technologies. This opening size was chosen as it is the smallest opening size that would likely provide reliable flow and avoid screen failures due to excessive debris loading and/or fouling. The biological information provided in Attachment 6 determines the potential reductions in EA1 I&E from the regulatory baseline for select opening sizes (i.e., 9.0, 6.0, 3.0, 2.0, 1.5, and 1.0 mm).

#### 4.2.1 Alternative Ristroph Screens

Alternative Ristroph screens (i.e., Ristroph screens with different mesh opening sizes than the mesh opening size of the existing Ristroph-type TWSs) are not considered as viable alternatives to the current screening systems at the Stations. As shown in Attachment 6, the use of alternative Ristroph screens (coarse or fine mesh) would not be expected to provide substantial reductions in EA1 I&E from the existing TWSs and fish return systems, because the maximum possible reduction in EA1 entrainment losses achievable by fine mesh Ristroph screens (34.9%) is only 1.1% more than the current reduction in EA1 entrainment losses (33.8%), as shown in Section 3.2. Moreover, significant civil/structural modifications would be required to install fine mesh Ristroph screens at the Stations.

The primary concern with fine mesh screens is that they can impinge early organism life stages that are entrained through coarse mesh screens. Depending on species and life stage, mortality from impingement can exceed entrainment mortality. In order for fine mesh screens to reduce entrainment losses, impingement survival of target species previously entrained must be substantially greater than entrainment survival through the circulating water system. In addition, smaller mesh sizes (i.e., < 2.0 mm) would create significant opportunity for fouling and heavy debris loading of the screen panels with a corresponding effect on survival. A study of 0.5 mm fine mesh TWSs installed at the Prairie Island Nuclear Generating Plant, located on the Mississippi River in Red Wing, Minnesota, concluded that debris volume had a significant effect on survival with mortality of all early life stages between 95 - 100% during high debris loads [Ref. 6.32]. Where debris loading is persistent, survival can be significantly impacted.

The Consolidated Edison Company of New York (ConEd, predecessor of Entergy) commissioned reviews of previous fine mesh studies, surveys of existing fine mesh applications, and model flume trials of a fine mesh Ristroph screen between 1990 and 1991 [Ref. 6.34; Ref. 6.32]. A field study of a fine mesh Ristroph screen installed at Unit 1 concluded that there is no net gain when mortalities of entrained organisms are no greater than the mortalities imposed on the same organisms by impingement on fine mesh screens [Ref. 6.31]. In 1994, Dr. Ian Fletcher concluded that mesh sizes smaller than 3 mm could not be safely recommended due to operational/reliability issues with the fine mesh panels including tears, punctures, and detachment from the screen frames [Ref. 6.32].

Brunswick Nuclear Plant (BNP), which receives cooling water from the Cape Fear River near Southport, North Carolina, utilizes 1.0 mm fine mesh panels that are placed on top of

the permanent 9.5 mm (3/8 inch) TWS panels during periods of high entrainment to filter a maximum cooling water intake capacity of 1,328,000 gpm [Ref. 6.7; Ref. 6.115]. An 84% reduction in entrainment (compared to the permanent screen systems) was reported at BNP following the installation of the fine mesh inserts [Ref. 6.115]. Although EPA references the BNP as a successful application of fine mesh screens [Ref. 6.115], application of these screens at BNP has been limited. As stated in the BNP 2000 Environmental Monitoring Report [Ref. 6.6], “[d]uring periods of high vulnerability resulting from extreme lunar tides or increased sediment and debris loading, the [National Pollutant Discharge Elimination System] NPDES permit allows for removal of a portion of the fine-mesh screens to prevent plant scrams. High vulnerability conditions existed for most of the year.” Impingement survival of organisms that formally would have been entrained was not determined.

Although seasonal deployment of fine mesh inserts on top of the coarse mesh TWS panels during periods of high entrainment could provide entrainment reductions at some facilities, fine mesh screens inserted on permanent coarse mesh screens can increase flow resistance or head loss. For a 1.0 mm mesh panel installed over a  $\frac{3}{8}$  inch coarse metal panel, the head loss at a through-screen velocity of 1.0 fps increases by a factor of 3.8. For a 0.5 mm mesh on  $\frac{3}{8}$  inch coarse metal panel, the head loss at a through-screen velocity of 1.0 fps increases by a factor of 4.8 [Ref. 6.34]. Increases in head loss across the screening panels present numerous mechanical and biological issues. The primary mechanical concern is that the rate of debris plugging or blinding of the screening mesh is increased dramatically due to the increased pressure differentials combined with the smaller sizes of debris impinged by fine mesh screens [Ref. 6.27]. Increased pressure differentials can cause smaller impinged organisms to be damaged by extrusion (i.e., the organisms are compressed and forced through the screening mesh). The increased debris loads also add weight to the TWS panels causing premature wear and failure of bearings, chains, and sprockets. Permanently installed fine mesh screens typically experience tearing of the mesh material from the panel frames caused by metal fatigue due to the flexing of the panels during their ascent and descent in the water column [Ref. 6.34]. These mechanical issues contribute to substantial increases in maintenance requirements and repair/replacement costs. In addition, due to the increased pressure differentials, increased vortexing in the Ristroph buckets can occur, causing stresses on impinged fish resulting in mortality [Ref. 6.27].

According to 40 CFR §125.94, if a facility reduces the through-screen velocity to at or below 0.5 fps, it is “deemed to have met the impingement mortality performance standards”. In order to maintain existing head loss across the screen and provide a through-screen velocity at or below 0.5 fps, the size of the CWISs would need to be expanded to accommodate fine mesh Ristroph screens. A much larger fine mesh screen area would be required to provide the same total open area as a coarse mesh screen. Four 2.0 mm fine mesh traveling water screens would be required per intake channel to filter the required flow and provide a through-screen velocity at or below 0.5 fps.

Attachment 2, Figures 2-1 through 2-3 depict a conceptual design for 2.0 mm fine mesh Ristroph screens at Units 2 and 3. The conceptual designs would require expansion of the existing intake structures to form new forebays. Each forebay would be dedicated to an existing CW intake channel and would house four 2.0 mm fine mesh TWSs near its face. Each 2.0 mm fine mesh TWS channel would be equipped with new bar racks and stop logs

providing large debris removal and isolation of the fine mesh TWSs for repair or maintenance. The expanded intake for fine mesh TWSs shown in Attachment 2 would not affect the existing operation of the SW intake channels, and would include a new or modified fish return system that would be required for removal of organisms and debris from the TWSs. As shown, significant civil/structural modifications would be required to install fine mesh TWSs at the Stations.

#### Maintenance

The maintenance activities required for 2.0 mm fine mesh Ristroph screens would be similar to the current maintenance operations associated with the existing coarse mesh Ristroph screens, but maintenance frequency would likely increase. Due to the larger debris loads retained by fine mesh screens, however, wear on mechanical components would be expected to be greater, thus requiring a higher frequency of maintenance and replacement compared to the existing TWSs. As such, the overall maintenance costs and time would be expected to increase significantly for fine mesh Ristroph screens compared to the current coarse mesh Ristroph screens due to the increased debris loads and larger number of Ristroph screens required. At a minimum, maintenance costs required for fine mesh TWSs would be at least 4 times the costs required to maintain the existing coarse mesh TWSs.

Because fine mesh screens are more susceptible to biofouling than coarse mesh screens, it is likely that a sodium hypochlorite system would be required to periodically dispense sodium hypochlorite in front of any fine mesh Ristroph screens to provide biofouling control. Any addition of sodium hypochlorite to the CW systems would need to be evaluated for potential impacts to the SPDES permit [Ref. 6.86].

#### Cost

The total estimated capital cost for Unit 2 and Unit 3 for the installation of the 2.0 mm fine mesh Ristroph screens, as shown in Attachment 2 Figures 2-1 through 2-3, would be approximately \$373 million (see Attachment 4).

The construction activities associated with expanding the existing Unit 2 and Unit 3 intake structures and the installation of 2.0 mm fine mesh Ristroph screens would take approximately six to nine months per Unit. As discussed in Section 2.4.2.3.1, refueling outages are anticipated to last approximately 25 days. Assuming that the construction activities could be scheduled to coincide with a routine maintenance outage for each Unit, there would be approximately five to eight months of lost generating capacity per Unit during the implementation of the evaluated 2.0 mm fine mesh Ristroph screens. As discussed in Section 2.1, the Stations currently generate electricity at a rated capacity of approximately 1078 MWe and 1080 MWe for Units 2 and 3, respectively. A five to eight month construction outage would result in a loss of approximately 3.9 million to 6.3 million MW-hrs per Unit. If construction activities could not be scheduled to coincide with a routine maintenance outage, the costs due to construction outages would increase.

#### I&E Discussion

Attachment 6 (Tables 17 and 23 of Appendix A) provides the reductions from the regulatory baseline in EA1 losses averaged among species and years that could be

achieved using 9.0, 6.0, 3.0, 2.0, 1.5, and 1.0 mm Ristroph screens accounting for the Stations' survival rates (Attachment 6) and average historic flow reductions (Section 2.4.2.3.2). A summary of the information included in Attachment 6 is shown in Table 4.1.

**Table 4.1 Potential Percent Reduction of Annual EA1 I&E Losses due to Modified Ristroph Screens in Each Month**

Month	EA1 Entrainment Loss Reduction						EA1 Impingement Loss Reduction
	9.0 mm	6.0 mm	3.0 mm	2.0 mm	1.5 mm	1.0 mm	
January	0.0%	0.0%	0.0%	0.0%	0.0%	0.0%	8.7%
February	0.0%	0.0%	0.0%	0.0%	0.0%	0.0%	9.6%
March	0.0%	0.0%	0.0%	0.0%	0.0%	0.0%	12.0%
April	0.3%	0.4%	0.4%	0.4%	0.4%	0.4%	6.6%
May	5.9%	6.1%	6.2%	6.1%	5.9%	4.8%	7.4%
June	13.6%	14.3%	14.1%	12.8%	11.0%	8.7%	8.5%
July	5.8%	6.4%	7.0%	7.0%	6.9%	6.9%	4.0%
August	3.4%	4.1%	4.8%	4.8%	4.8%	4.8%	4.2%
September	1.3%	1.3%	1.5%	1.5%	1.5%	1.5%	4.4%
October	1.2%	1.1%	1.0%	1.0%	1.0%	1.0%	3.8%
November	0.0%	0.0%	0.0%	0.0%	0.0%	0.0%	4.6%
December	0.0%	0.0%	0.0%	0.0%	0.0%	0.0%	6.3%
Annual	31.5%	33.8%	34.9%	33.5%	31.5%	27.9%	80.2%

The maximum possible reduction in EA1 entrainment losses shown in Table 4.1 (34.9%) is only 1.1% more than the current entrainment reduction (33.8%) shown in Section 3.2. Additionally, the estimated reduction in impingement provided by alternative Ristroph screens, regardless of mesh size, is identical to the current reductions provided by the existing Ristroph-type TWSs.

### Conclusions

The estimated initial costs associated with the conceptual installation of the 2.0 mm fine mesh Ristroph screens would include approximately \$373 million in capital costs and approximately 3.9 million to 6.3 million MW-hrs of lost generation due to the required construction outages. As shown in Table 4.1, none of the mesh sizes evaluated would be expected to reduce EA1 entrainment losses from baseline by more than approximately 34.9%, and, therefore, would be essentially similar to current technology conditions (Section 3.2). As such, alternative Ristroph screens are not further considered to be viable alternatives to the existing intake technologies.

### 4.2.2 Dual Flow Traveling Water Screens

Dual flow traveling water screens are not considered as viable alternatives to the current screening systems at the Stations, because the use of dual flow traveling water screens (coarse or fine mesh) would not be expected to provide substantial reductions in EA1 I&E from the existing TWSs and fish return systems.

In order to reduce the through-screen velocities by increasing the available screen area, and thus potentially reduce impingement, the existing through flow traveling water screen installations at many facilities can be retrofitted to use dual flow traveling water screens [Ref. 6.94]. As discussed in Section 4.2.1, if a facility could reduce its maximum through-screen velocity to at or below 0.5 fps, impingement is considered to be reduced to acceptable levels, according to EPA. In addition, according to the Hudson River Power Plants Final Environmental Impact Statement [Ref. 6.88], NYSDEC has indicated interest in through-slot velocities of 0.25 fps. As shown in Figure 4.1, dual flow traveling water screens are mechanically similar to through flow screens but are rotated ninety degrees within the flow channel, which reduces the through-screen velocity by increasing the surface area and eliminating the potential for carryover.

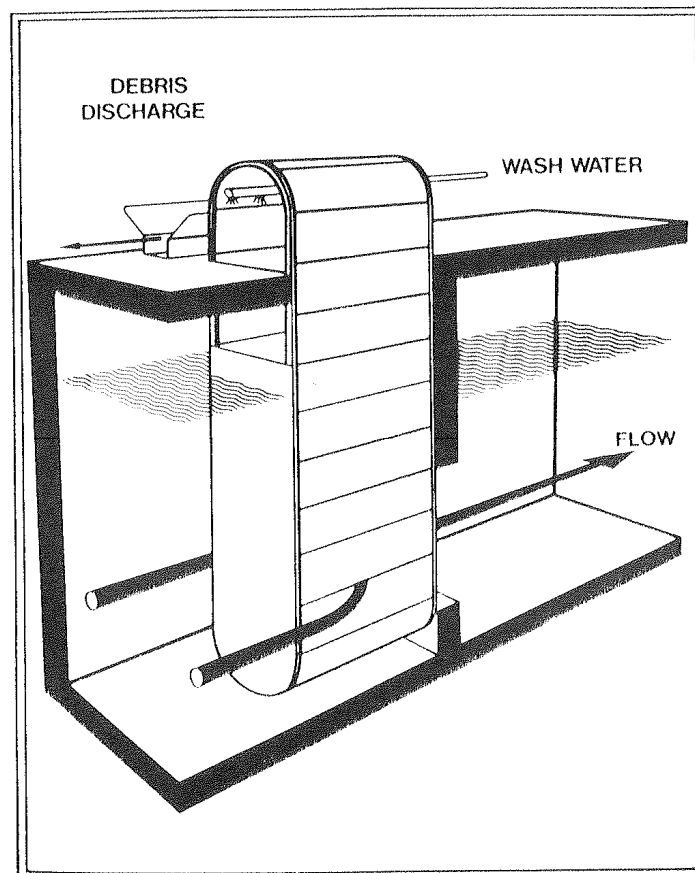

**Figure 4.1 Typical Dual Flow Screen Arrangement [Ref. 6.94]**

The orientation of a dual flow screen allows the entire submerged screen surface to be an active screen area. Thus, for an identical basket width, a dual flow screen can filter twice the volume of water as a through flow screen. If the volume of water to be filtered is constant and the traveling screens have identical basket widths, the through screen velocity of a dual flow screen will be approximately half of the through screen velocity of a through flow screen. Unlike through flow screens, the configuration of dual flow traveling water screens (parallel to the direction of incoming flow) eliminates debris carryover to the condensers and reduces condenser maintenance because the screening face of the baskets

are not rotated into the downstream flow of the intake. Figure 4.2 compares the flow pattern through a through flow traveling water screen with the flow pattern through a dual flow traveling water screen.

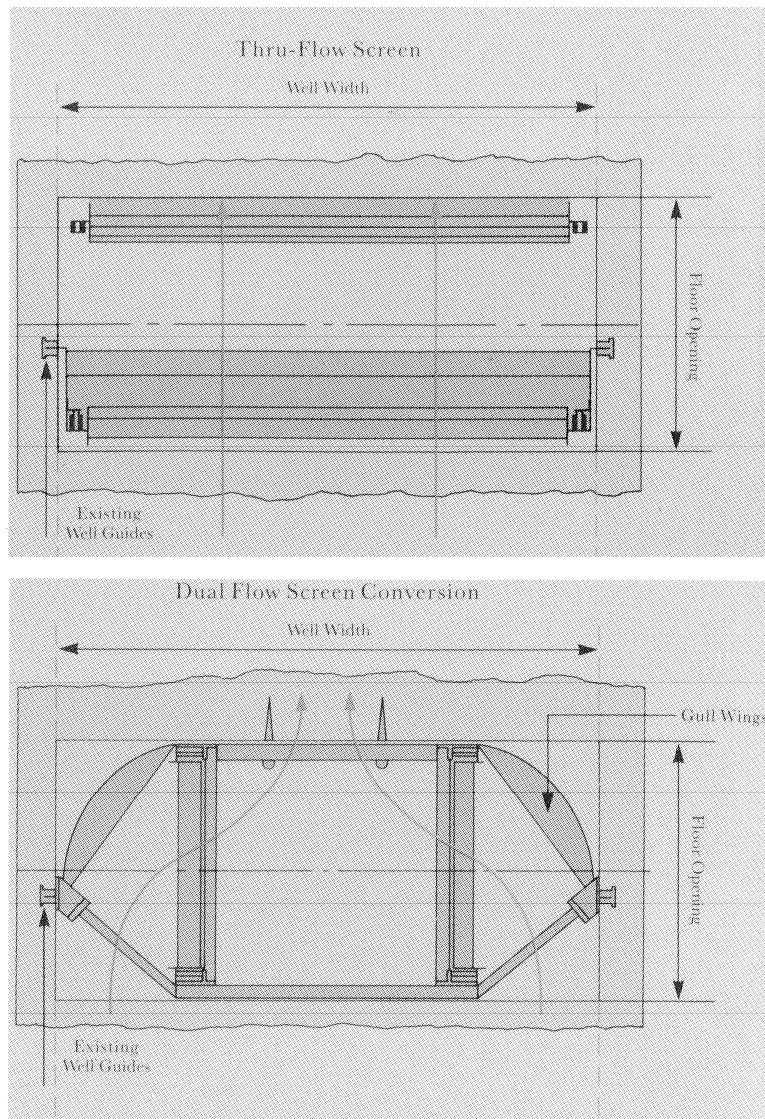

**Figure 4.2 Plan View of Through Flow to Dual Flow Retrofit [Ref. 6.94]**

Conversion from through flow to dual flow traveling water screens typically includes the installation of a special wall plate mounted perpendicular to the flow in place of the existing screen. The dual flow screen is then lowered into the channel, with baskets parallel to the flow, on the upstream side of the wall plate. An inlet opening in the wall plate allows screened water to flow to the pumps. An alternative arrangement uses a specially constructed screen mainframe that includes a wall plate made as an integral part of the screen frame with extensions or “wings” that fit into existing embedded guides. Dual flow traveling water screens have been retrofitted at nuclear power generating facilities, including Cooper Nuclear Station located on the Missouri River. In 2006, coarse mesh dual flow traveling water screens were retrofitted at Cooper Nuclear Station to

address debris carry-over problems encountered with the original through flow traveling water screens [Ref. 6.83]. Each dual flow screen is equipped with fish collection baskets and is designed to filter a maximum flow rate of 159,000 gpm with a through screen velocity of approximately 2.0 fps [Ref. 6.83].

Fine mesh dual flow screens have been in operation since 1984 at Unit 4 of the coal-fired TECO Big Bend Power Station located on the Tampa Bay estuary across from Tampa, Florida. The six dual flow screens have a 0.5 mm mesh size and filter an intake flow of approximately 483,435 gpm. Biofouling control was a significant issue at TECO Big Bend Power Plant requiring biweekly manual cleaning of the dual flow screens by a two person crew [Ref. 6.14].

Retrofitting the Stations' CWISs with coarse mesh dual flow traveling water screens (i.e., ¼-inch by ½-inch basket mesh openings) would only reduce the through-screen velocity (calculated in Section 2.4.2.4) to approximately 0.81 fps. Therefore, in order to accommodate fine mesh dual flow screens while maintaining the existing head loss across the screens and providing a through-screen velocity at or below 0.5 fps, the size of the CWISs would need to be expanded to accommodate fine mesh dual flow screens. Attachment 2, Figures 2-4 through 2-6 depict a conceptual design for 2.0 mm dual flow screens at Units 2 and 3. A new intake forebay would be dedicated to each existing CW intake channel and would house three 2.0 mm dual flow screens near its face. Per EIMCO Water Technologies (EWT), a leading manufacturer of dual flow screens, three 2.0 mm dual flow screens would be required to filter the intake water flows while maintaining a through-screen velocity at or below 0.5 fps (see Attachment 1, Section 2). The face of the expanded intake would be located between 90 and 170 ft from the face of the existing intake structure and would have a width of nearly 200 ft. New bar racks and stop logs would be installed to provide large debris removal and isolation of the screens for repair or maintenance. This conceptual design would not affect the existing operation of the SW intake channels, and would include new or modified fish return systems that would be required to safely return impinged organisms to the source water body. As shown, significant civil/structural modifications would be required to install fine mesh dual flow screens at the Stations.

### Maintenance

The maintenance activities required for dual flow screens would be expected to be similar to the current maintenance operations associated with the existing coarse mesh TWSs, although overall maintenance costs and time would be expected to increase significantly for fine mesh dual flow screens. At a minimum, maintenance costs required for 2.0 mm fine mesh dual flow TWSs would be expected to be at least three times the costs required to maintain the existing coarse mesh TWSs. However, because dual flow screens virtually eliminate debris carryover into the condenser, there would be reduced maintenance associated with cleaning the condenser.

Because fine mesh screens are more susceptible to biofouling than coarse mesh screens, it is likely that a sodium hypochlorite system would be required to periodically dispense sodium hypochlorite in front of any fine mesh dual flow screens to provide biofouling control. Any addition of sodium hypochlorite to the CW systems would need to be evaluated for potential impacts to the SPDES permit [Ref. 6.86].

### Cost

The total estimated capital cost for Unit 2 and Unit 3 for the conceptual installation of the 2.0 mm dual flow screens, as shown in Attachment 2 Figures 2-4 through 2-6, would be approximately \$350 million (see Attachment 4).

The construction activities associated with expanding the existing Unit 2 and Unit 3 intake structures and the installation of 2.0 mm fine mesh dual flow screens would take approximately six to nine months per Unit. As discussed in Section 2.4.2.3.1, refueling outages are anticipated to last approximately 25 days. Assuming that the construction activities could be scheduled to coincide with a routine maintenance outage for each Unit, there would be approximately five to eight months of lost generating capacity per Unit during the implementation of the evaluated fine mesh dual flow screens. As discussed in Section 2.1, the Stations currently generate electricity at a rated capacity of approximately 1078 MWe and 1080 MWe for Units 2 and 3, respectively. A five to eight month construction outage would result in a loss of approximately 4.7 million to 6.3 million MW-hrs per Unit. If construction activities could not be scheduled to coincide with each Unit's routine maintenance outages, the costs due to construction outages would increase.

### I&E Discussion

Any incremental impingement reductions provided by dual flow screens would not be expected to be appreciable, because the Stations' existing TWSs screens and fish return systems already provide state-of-the-art impingement protection (Section 3.2). Attachment 6 (Table 17 of Appendix A) provides the expected reductions in EA1 entrainment losses from baseline that could be achieved through the installation of fine mesh panels with various mesh sizes (summarized in Table 4.1). However, as discussed in Section 4.2.1, the maximum possible reduction in EA1 entrainment losses shown in Table 4.1 (34.9%) is only 1.1% more than the current entrainment reduction (33.8%).

### Conclusions

The estimated initial costs associated with the conceptual installation of the 2.0 mm fine mesh dual flow screens would include approximately \$350 million in capital costs and 4.7 million to 6.3 million MW-hrs of lost generation due to the required construction outages. Dual flow screens would not be expected to provide substantial reductions in EA1 I&E from the existing TWSs and fish return systems. Therefore, dual flow screens are not further considered as an alternative to the current screening systems.

## **4.2.3 Angled Traveling Screens**

Angled traveling screens are not considered to be viable alternatives to the current screening systems at the Stations, because the use of angled traveling screens (coarse or fine mesh) would not be expected to provide substantial reductions in EA1 I&E from the existing TWSs and fish return systems.

Angled traveling screens typically consist of through flow traveling screens set at an angle to the incoming flow. Angled traveling screens cause abrupt changes in the velocity and direction of the flow, creating a turbulence zone in front of the screens that fish typically avoid. Rather, fish tend to align themselves parallel to the incoming flow, coming in



contact tail first with the turbulence zone. As shown in Figure 4.3, fish move away from the turbulence zone in a direction perpendicular to the angled traveling screens. The net effect of this behavioral response, after repeated excursions away from the turbulence zone, is a lateral displacement of fish towards the end of the angled traveling screens into a bypass channel that returns fish to the source waterbody [Ref. 6.35].

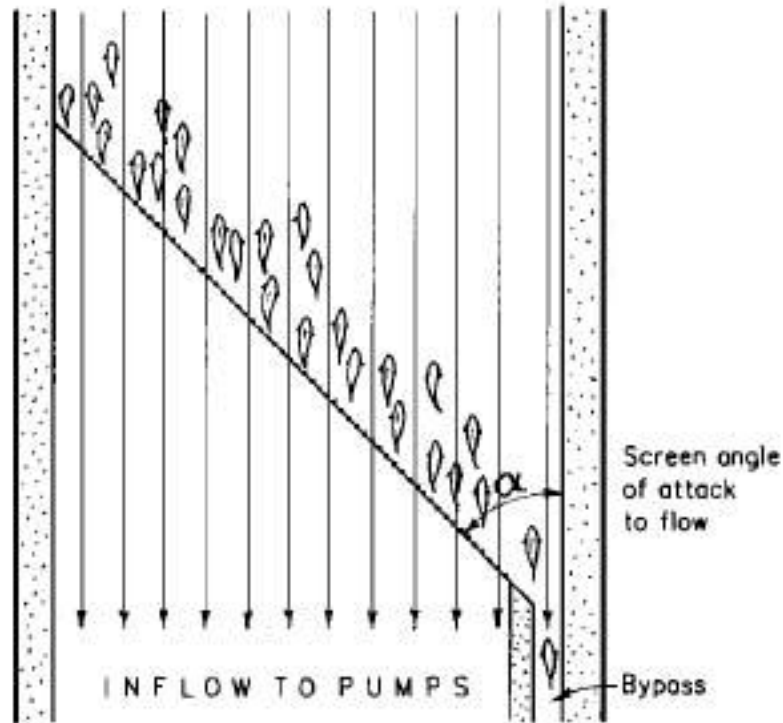

**Figure 4.3 Angled Traveling Screen Guiding Fish Towards Bypass Channel [Ref. 6.35]**

Modular inclined screens (MISs) are a specific variation of angled traveling screens, where each module consists of integrated bar racks, dewatering stop logs, inclined screens set at a  $10^\circ$  to  $20^\circ$  angle to the incoming flow, and a bypass channel to return fish to the source water body. A plan view of MISs is shown in Figure 4.4.

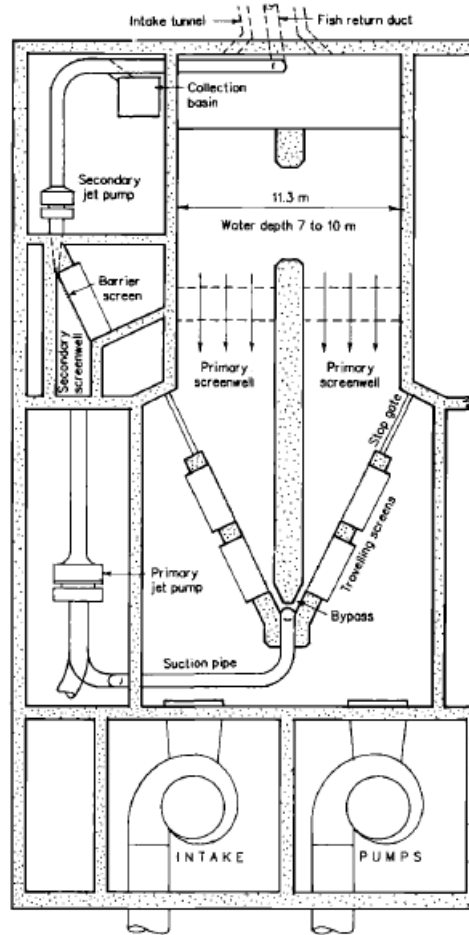

**Figure 4.4 Plan View of MISs [Ref. 6.35]**

In order to maintain existing head loss across the screen panels and provide a through-screen velocity at or below 0.5 fps, the size of the CWISs would need to be expanded to accommodate fine mesh angled traveling screens. As previously determined in Section 4.2.1, four 2.0 mm fine mesh TWSs with a wire thickness of 0.5 mm would be required per intake channel to filter the required flow while maintaining a through-screen velocity at or below 0.5 fps.

A conceptual design for angled traveling screens at the Stations would be similar to the conceptual configurations for fine mesh dual flow and fine mesh Ristroph screens shown in Attachment 2. However, the width of the expanded intake required for angled traveling screens would be larger because each angled traveling screen channel would include a fish bypass channel. The width of the expanded intake for 2.0 mm fine mesh angled traveling screens providing screened cooling water to three CW channels would be approximately 238 ft wide assuming a 1 ft wide fish bypass channel and 3 ft thick walls. Each fine mesh angled traveling screen would be paired with new bar racks and stop logs providing large debris removal and isolation of the traveling screens for repair or maintenance. Due to the fish bypass channels and pumps required to induce flow in the bypass channel, implementation of fine mesh angled traveling screens would require more civil/structural

and mechanical modifications than the implementation of fine mesh dual flow screens or fine mesh Ristroph screens.

#### Maintenance

The maintenance activities required for angled traveling screens are expected to be similar to the current maintenance operations associated with the existing coarse mesh TWSs, although additional maintenance for the new pumps required to induce flow in the bypass channels would be required. Overall maintenance costs and time would be expected to increase significantly for fine mesh angled traveling screens compared to the current coarse mesh TWSs due to the larger number of fine mesh screens required and the addition of circulating pumps for the fish bypass channels. The use of fine mesh screens would create larger debris loads; therefore, additional wear on mechanical components would be expected, resulting in a higher frequency of maintenance and replacement compared to the existing TWSs. Due to the increased number of screens required for the implementation of fine mesh angled traveling screens, maintenance costs would be expected to be approximately four to five times the costs required to maintain the existing coarse mesh TWSs.

Additionally, because fine mesh screens are more susceptible to biofouling than coarse mesh screens, it is likely that a sodium hypochlorite system would be required to periodically dispense sodium hypochlorite in front of any fine mesh angled traveling screens to provide biofouling control. Any addition of sodium hypochlorite to the CW systems would need to be evaluated for potential impacts to the SPDES permit [Ref. 6.86].

#### Cost

The conceptual installation of fine mesh angled traveling screens would require more civil/structural and mechanical work than the conceptual installation of fine mesh dual flow or Ristroph screens. Therefore, the estimated capital costs for the conceptual installation of 2.0 mm fine mesh angled traveling screens would be anticipated to be significantly higher than the estimated costs for installation of 2.0 mm fine mesh dual flow screens (Section 4.2.2) or 2.0 mm fine mesh Ristroph screens (Section 4.2.1).

#### I&E Discussion

With respect to impingement, in a scaled hydraulic study of the biological effectiveness of a MIS system (i.e., an angled screen system including a bypass channel to return fish to the source waterbody), the Electric Power Research Institute (EPRI) concluded MIS systems have potential to safely and effectively divert juvenile fish at CWISs [Ref. 6.13]. Diversion efficiency is defined as the ratio of fish diverted into a bypass channel divided by the sum of fish diverted and fish impinged against the angled screens. In a full scale study of an MIS system installed at the oil- and gas-fired Oswego Power Generating Station on Lake Ontario, diversion efficiencies of 91% for alewives, 92% for rainbow smelt, and 93% for white perch were reported [Ref. 6.35]. However, data collected during the full scale study from the bypassed fish determined that 86% of the bypassed alewives were dead or injured on arrival in the collection basin. The corresponding immediate mortalities for rainbow smelt were 59%, and for the white perch 80% [Ref. 6.35]. In addition, any impingement reductions provided by angled traveling screens would not be

expected to be appreciable when compared to the impingement reductions associated with the Stations' existing TWSs screens and fish return systems (Section 3.2).

Entrainment reductions would not be appreciable. As discussed in Attachment 6, in order to avoid entrainment, larvae have limited capabilities to move into a sweeping flow that bypasses a screen. However, due to the configuration of the angled traveling screens inside a CWIS, no sweeping flow bypassing the screen would be present. Therefore, because eggs and larvae cannot swim away from the turbulence created by angled traveling screens, there is no substantial reduction in entrainment [Ref. 6.107]. As such, angled traveling screens are not expected to improve reductions in EA1 entrainment losses compared to Ristroph screens (see Table 4.1).

### Conclusion

Angled traveling screens would not be expected to provide substantial reductions in EA1 I&E from the existing TWSs and fish return systems. Moreover, the capital costs and maintenance costs associated with angled traveling screens would be significantly higher than the costs associated with dual flow screens or Ristroph screens due to additional civil/structural and mechanical work associated with the installation of the fish bypass channels and their flow-inducing pumps. Therefore, angled traveling screens are not further considered as an alternative to the current screening systems.

## **4.2.4 WIP Screens**

Beaudrey USA W Intake Protection (WIP) screens are not considered as viable alternatives to the current screening systems at the Stations, because the use of WIP screens (coarse or fine mesh) would not be expected to substantial reductions in EA1 I&E from the existing TWSs and fish return systems.

The WIP screen is a modified revolving disc screen that may often be retrofitted into intakes that currently have through flow TWSs. The traditional revolving disc screen consists of a flat disc covered with screening material that rotates about a horizontal axis perpendicular to the water flowing into an intake. As water flows through the submerged portion of the disc, solids are retained on the screening media. On a traditional revolving disc screen, the rotation of the disc lifts the solids above the water surface where they are removed by spray nozzles.

The WIP system consists of one rotating wheel, which rotates within a frame at 1 or 2 revolutions per minute and a fish protection system. Both fish and debris are removed from the screen surface below the waterline by a fish pump and suction scoop. The aquatic organisms do not leave the water and are returned downstream of the intake structure. However, compared to traditional through flow traveling water screens, the WIP system does not utilize the entire available screen area, as shown in Figure 4.5.

With traditional through flow traveling water screens, any fish and/or debris that are not washed off the screen basket would be washed off into the flow of water and carried through the cooling water system. The potential for debris carryover is eliminated as shown in Figure 4.6, because WIP screens do not rotate over into the downstream flow, and all flow must pass through the screen before entering the screenwell and ultimately the condenser.

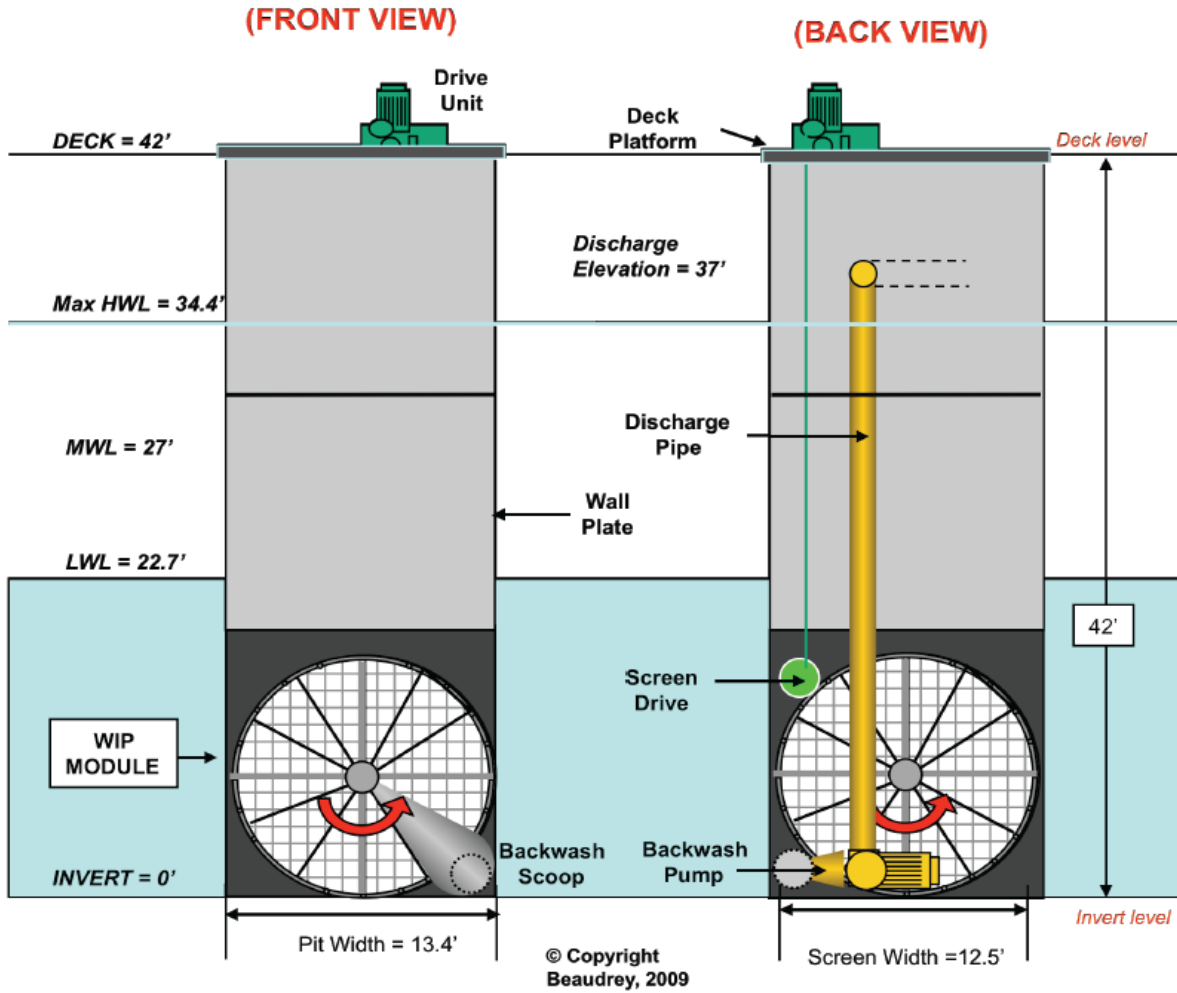

**Figure 4.5 Beaudrey WIP System**

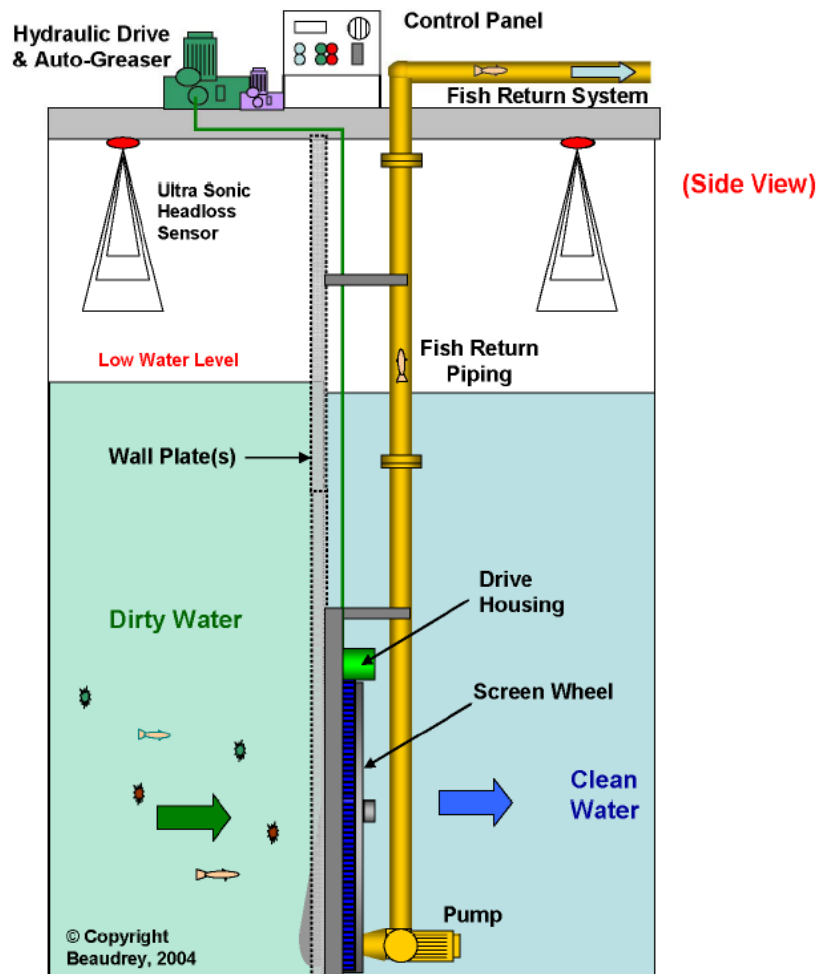

**Figure 4.6 Beaudrey WIP System, Side View**

The WIP System should have appreciably easier maintenance than the existing TWSs, because the WIP screens can be raised out of the water for maintenance activities, do not contain chainbelts or links, and lack spray nozzles and headers. The WIP screens would also eliminate debris carryover into the condensers, reducing maintenance associated with condenser fouling.

WIP screens can also be constructed with a circular fine-mesh screen designed to collect fish eggs and larvae and return them to the source waterbody. However, unlike Ristroph screens or dual flow screens, WIP Systems are not designed to have removable fine mesh inserts, eliminating the possibility of seasonal deployment during periods of high entrainment.

As discussed in Section 2.4.2.4, the existing TWSs allow 140,000 gpm or 143,200 gpm of water to flow through an area defined by the current TWS basket width and the height of the water level, resulting in a maximum through-screen velocity of approximately 1.61 fps or 1.64 fps, respectively. However, as shown in Figure 4.5, a WIP system would limit the flow area to a circular screen section and would require the same volume of flow to pass through a smaller area, resulting in an increased through-screen velocity. The through-

screen velocity of a WIP System can be calculated by replacing the basket width and mean low water terms in the through-screen velocity equation provided in Section 2.4.2 with the surface area of the screening wheel. A WIP screen designed to fit into the existing traveling water screen guides would have a width of 13ft 4 inches and would have a 12.5 ft diameter circular screen section. If the circular screen section were constructed of the same wire gauge and opening size as the current TWSs (14 gauge wire and a mesh opening size of  $\frac{1}{2} \times \frac{1}{4}$ -inches), the through-screen velocity would be approximately 4.08 fps at a flow rate of 140,000 gpm, which is 2.5 times greater than the through-screen velocity of the currently installed TWSs.

In order to provide a through-screen velocity at or below 0.5 fps, the size of the CWISs would need to be greatly expanded to accommodate extra WIP screens at the Stations. The number of fine mesh WIP screen screens required to maintain a through-screen velocity at or below 0.5 fps can be determined by replacing the basket width and mean low water terms in the equation previously referenced in Section 2.4.2.4 with the surface area of WIP screening wheel. Ten 2.0 mm fine mesh WIP screens with 12.5 ft diameter screening wheels would be required per intake channel (140,000 or 143,200 gpm) to maintain a through-screen velocity at or below 0.5 fps.

A conceptual design for 2.0 mm fine mesh WIP screens at IPEC would be similar to the conceptual configuration for fine mesh dual flow and fine mesh Ristroph screens shown in Figures 2-4 through 2-6 and Figures 2-1 through 2-3 of Attachment 2, respectively. However, the size of the expanded intake required would be significantly larger, because each of the new dedicated forebays would contain 10 fine mesh WIP screens. The width of the expanded intake for fine mesh WIP screens providing screened cooling water to three CW channels would be approximately 500 ft wide assuming 13 ft 4 inch wide WIP screen channels and 3 ft thick walls. Each fine mesh WIP screen would be paired with new bar racks and stop logs providing large debris removal and isolation of the traveling screens for repair or maintenance. Due to size of the expanded intake required, implementation of fine mesh WIP screens would require more civil/structural and mechanical modifications than the implementation of fine mesh dual flow screens or fine mesh Ristroph screens.

### Maintenance

The WIP screens should have appreciably easier maintenance than the existing TWSs because the WIP screens can be raised out of the water for maintenance purposes. In addition, WIP screens would eliminate debris carryover into the condensers reducing maintenance costs associated with the condensers. However, overall maintenance costs would be expected to increase significantly for WIP screens compared to the current TWSs, due to the number of WIP screens that would be required to screen the normal intake flows of Units 2 and 3 (120 total 2.0 mm fine mesh WIP screens). Due to the increased number of screens required for the implementation of fine mesh WIP screens, maintenance costs required for 2.0 mm fine mesh WIP screens would be expected to be approximately ten times the costs required to maintain the existing coarse mesh TWSs.

Because fine mesh screens are more susceptible to biofouling than coarse mesh screens, it is likely that a sodium hypochlorite system would be required to periodically dispense sodium hypochlorite in front of any fine mesh WIP screens to provide biofouling control.

Any addition of sodium hypochlorite to the CW systems would need to be evaluated for potential impacts to the SPDES permit [Ref. 6.86].

#### Cost

The estimated cost for the WIP System components (i.e., screens, pumps, and controllers) is 3.3 times the cost of the fine mesh Ristroph screen components and 3.7 times the cost of the fine mesh dual flow screen components (see Attachment 1, Section 3). In addition, due to the larger number of fine mesh WIP screens required and the increased costs associated with construction of the expanded intake structures that would be required to house the larger number of screens, the estimated capital costs for the installation of conceptual 2.0 mm fine mesh WIP screens is anticipated to be significantly higher than the estimated costs for installation of 2.0 mm fine mesh dual flow screens or 2.0 mm fine mesh Ristroph screens.

#### I&E Discussion

A pilot study to determine impingement reductions provided by WIP screens was conducted at Unit 5 of the OPPD's North Omaha Station (a coal-fired generating station) by EPRI [Ref. 6.12]. Unit 5 is provided with condenser cooling water from the Missouri River by an intake structure that is divided into six cells or channels. The flow through each channel is 29,385 gpm and each channel contains a bar rack, sluice gate, and traveling water screen [Ref. 6.12]. One of the six traveling water screens was replaced with a WIP screen with square 6.1 mm (0.24 inch) openings in August 2006. The results of the pilot study indicated that WIP screens have the potential to reduce impingement mortality of channel catfish and bluegill by greater than 90%, and fathead minnow and the native Missouri River fish group, comprised primarily of emerald shiner, by 79 to nearly 85% [Ref. 6.12]. However, any impingement reductions provided by WIP screens would not be expected to be appreciable because the Stations' existing TWSs screens and fish return systems already provide state-of-the-art impingement protection (Section 3.2).

No studies investigating entrainment mortality associated with WIP screens have been performed [Ref. 6.12]. In addition, other than fine mesh panels, the WIP screens do not utilize any entrainment reducing features and would not be expected to provide additional reductions in entrainment other than physical exclusion based on the size of the mesh opening. Therefore, it is assumed that WIP screens with various mesh sizes would provide similar reductions in EA1 entrainment losses as Ristroph screens (see Table 4.1); however, as discussed in Section 4.2.1, no mesh size would be expected to provide significant additional reductions in EA1 entrainment losses.

#### Conclusions

The use of WIP screens at IPEC would not be expected to provide substantial reductions in EA1 I&E losses from the existing TWSs and fish return systems. In addition, due to the number of fine mesh WIP screens and the additional intake modifications required, the capital costs and maintenance costs associated with the installation and operation of fine mesh WIP screens would be significantly higher than the costs required for fine mesh dual flow traveling screens or fine mesh Ristroph screens. Thus, WIP screens are not further considered as an alternative to the current screening systems.



#### 4.2.5 MultiDisc® Screens

Geiger MultiDisc® Screens are not considered as viable alternatives to the current screening systems at the Stations, because the use of Geiger MultiDisc® Screens (coarse or fine mesh) would not be expected to provide substantial reductions in EA1 I&E from the existing TWSs and fish return systems.

Geiger MultiDisc® Screens are oriented the same way as traditional through flow screens (i.e., installed in a channel with the screening surface oriented perpendicular to the incoming flow). However, MultiDisc® screens are comprised of circulating sickle-shaped mesh panels that are connected to a frame via a revolving chain. The linked mesh panels are guided on each side forming a unit together with the support. The forces applied by the flowing water to the center of the mesh panels are transmitted via supporting beams to the intake structure. The center of the mesh panels are supported by rollers. Water flows directly through the mesh panels. Fish and debris retained at the face of the ascending mesh panels are transported to the floor level where they are sluiced to fish return trough and debris troughs, respectively, by spray nozzles. A typical Geiger MultiDisc® Screen is shown in Figure 4.7.

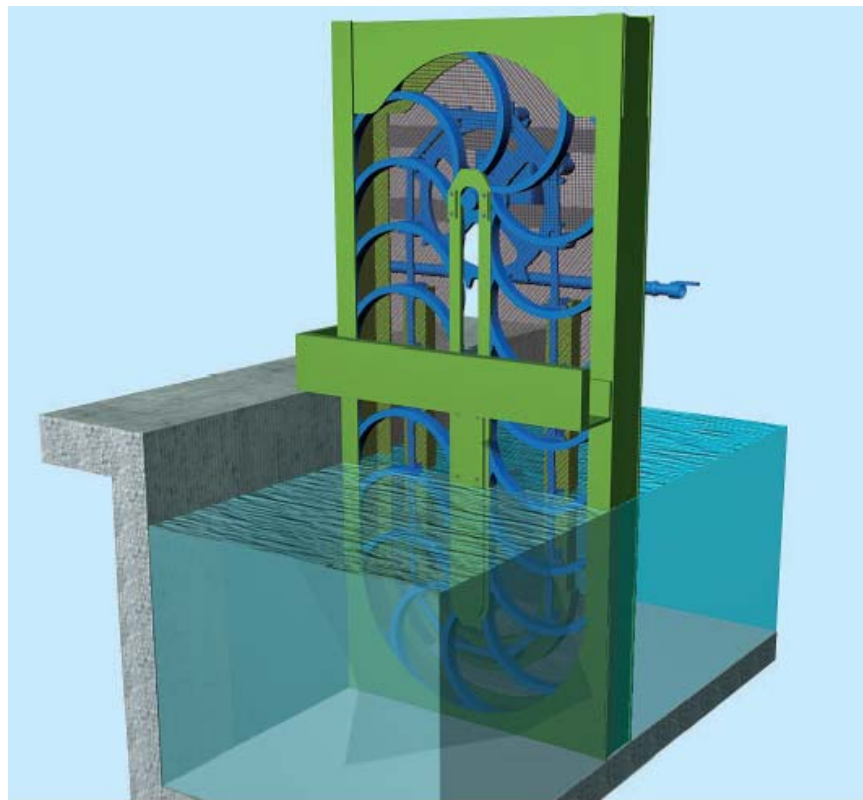

**Figure 4.7 Geiger MultiDisc® Screen [Ref. 6.96]**

MultiDisc® Screens can be modified to include provisions for reduced impingement loss of aquatic species. Fish buckets attached to the screen panels retain water during its upward travel, thereby providing captured fish with water once the fish buckets exit the water level. The fish buckets are surface treated with a sliding composite material to allow retained fish to be easily flushed from the buckets. A low pressure spray header recovers

organisms which are transported upwards on the screen surface into the bucket. Organisms impinged on the screen surface below this bucket are led via an opening in the lower panel frame into the bucket of the following mesh panel. Due to the turning system of the mesh panels at the drive unit, the fish buckets are discharged, and the retained water and fish are sluiced to a fish return trough.

MultiDisc<sup>®</sup> Screens can be constructed with fine-mesh screens designed to collect fish eggs and larvae and return them to the source waterbody. However, unlike Ristroph screens or dual flow screens, MultiDisc<sup>®</sup> screens are not designed to have removable fine mesh inserts, eliminating the possibility of seasonal deployment during periods of high entrainment.

MultiDisc<sup>®</sup> Screens have been retrofitted into the existing CWISs of nuclear power plants, including the Donald C. Cook Nuclear Plant in Michigan, the Salem Nuclear Generating Station in New Jersey, and the Fort Calhoun Station in Nebraska. Typically, MultiDisc<sup>®</sup> Screens can be retrofitted into the existing space of the current TWSs, minimizing required civil/structural modifications. However, MultiDisc<sup>®</sup> Screens are not available for the basket width required to replace the existing TWSs at the Stations. As discussed in Section 2.4.1.1, the Stations' existing TWSs have a basket width of 13 ft 4 inches, but due to design constraints, the largest basket width manufactured by Geiger is 10 ft (see Attachment 1, Section 4). The deflection of the sickle-shaped panels caused by debris loads limits the basket width of MultiDisc<sup>®</sup> Screens, because debris-loaded panels deflect at their center resulting in premature wear and deterioration. Implementation of fine mesh MultiDisc<sup>®</sup> screens in the existing CWISs would further increase the through-screen velocity and impingement mortality, due to the decrease in net porosity of the screen.

In order to provide a through-screen velocity at or below 0.5 fps, the size of the CWISs would need to be expanded to accommodate fine mesh MultiDisc<sup>®</sup> screens at the Stations. The number of fine mesh MultiDisc<sup>®</sup> screens required to maintain a through-screen velocity at or below 0.5 fps can be determined by using the equation previously referenced in Section 2.4.2.4 and multiplying the basket width and mean low water terms in the equation by 80 percent. The 20 percent reduction of the screening area conservatively accounts (i.e., understates the reduction in screening area) for submerged components of the MultiDisc<sup>®</sup> screen that reduce the flow area of the screen such as the base frame, central panel guide, and panel frames. Six 2.0 mm fine mesh MultiDisc<sup>®</sup> screens with a wire thickness of 0.5 mm would be required per intake channel (140,000 or 143,200 gpm) to maintain a through-screen velocity at or below 0.5 fps.

A conceptual design for 2.0 mm fine mesh MultiDisc<sup>®</sup> screens at the Stations would be similar to the conceptual configuration for fine mesh dual flow and fine mesh Ristroph screens shown in Figures 2-4 through 2-6 and Figures 2-1 through 2-3 of Attachment 2, respectively. However, the size of the expanded intake would be larger because each of the new dedicated forebays would contain six fine mesh MultiDisc<sup>®</sup> screens. The width of the expanded intake for 2.0 mm fine mesh MultiDisc<sup>®</sup> screens providing screened cooling water to three CW channels would be approximately 260 ft wide assuming 11 ft 4 in wide screen channels and 3 ft thick walls. Each fine mesh MultiDisc<sup>®</sup> screen would be paired with new bar racks and stop logs providing large debris removal and isolation of the screens for repair of maintenance. Due to the size of the expanded intake required,

implementation of fine mesh MultiDisc<sup>®</sup> screens would require more civil/structural and mechanical modifications than the implementation of fine mesh dual flow screens or fine mesh Ristroph screens.

#### Maintenance

MultiDisc<sup>®</sup> screens should require less maintenance than the existing TWSs because each screen panel can be individually removed at floor level and because the screening unit contains a single side bar chain. MultiDisc<sup>®</sup> screens would eliminate debris carryover into the condensers, reducing maintenance costs associated with the condensers. However, overall maintenance costs and time are expected to increase significantly for 2.0 mm fine mesh MultiDisc<sup>®</sup> screens, compared to the current TWSs due to the number of screens required to screen the normal intake flows of Units 2 and 3 (72 total 2.0 mm MultiDisc<sup>®</sup> screens). Due to the increased number of screens required for the implementation of 2.0 mm MultiDisc<sup>®</sup> screens, maintenance costs would be expected to be approximately six times the current costs required to maintain the existing coarse mesh TWSs.

Because fine mesh screens are more susceptible to biofouling than coarse mesh screens, it is likely that a sodium hypochlorite system would be required to periodically dispense sodium hypochlorite in front of any fine mesh MultiDisc<sup>®</sup> screens to provide biofouling control. Any addition of sodium hypochlorite to the CW systems would need to be evaluated for potential impacts to the SPDES permit [Ref. 6.86].

#### Cost

The estimated cost for the MultiDisc<sup>®</sup> screen components (i.e., screens, pumps, and controllers) is 1.4 times the cost of the fine mesh Ristroph screen components and 1.5 times the cost of the fine mesh dual flow screen components (see Attachment 1, Section 4). In addition, due to the number of MultiDisc<sup>®</sup> screens required and the extensive civil/structural work required for the expanded intake structures, the estimated capital costs for the installation of conceptual 2.0 mm fine mesh MultiDisc<sup>®</sup> screens is anticipated to be significantly higher than the estimated costs for installation of 2.0 mm fine mesh dual flow screens or 2.0 mm fine mesh Ristroph screens.

#### I&E Discussion

The number of 2.0 mm MultiDisc<sup>®</sup> screens incorporated into the conceptual design is based on a maximum through-screen velocity of 0.5 fps. According to the EPA, if a facility could reduce its maximum through-screen velocity to at or below 0.5 fps, it would be considered to have satisfied the standard for reducing impingement mortality. However, any impingement reductions provided by MultiDisc<sup>®</sup> screens would not be expected to be appreciable compared to the Stations' existing TWSs screens and fish return systems (see Section 3.2). Due to the similarities in the method of entrainment for MultiDisc<sup>®</sup> screens and Ristroph screens (fish pass through mesh panels oriented perpendicular to the flow), MultiDisc<sup>®</sup> screens would be expected to provide similar reductions in EA1 entrainment losses as Ristroph screens (Table 4.1). However, as discussed in Section 4.2.1, no mesh size would be expected to provide significant additional reductions in EA1 entrainment losses.

### Conclusions

The use of MultiDisc<sup>®</sup> screens at the Stations would not be expected to provide substantial reductions in EA1 I&E from the existing TWSs and fish return systems. In addition, due to the number of screens and the additional intake modifications required, the capital costs and maintenance costs associated with the installation and operation of MultiDisc<sup>®</sup> screens would be significantly higher than the costs required for dual flow traveling screens or Ristroph screens. For these reasons, MultiDisc<sup>®</sup> screens are not further considered as an alternative to the current screening systems.

## **4.3 Passive Intake Systems**

### **4.3.1 Cylindrical Wedgewire Screens**

Each of the cylindrical wedgewire screen (CWW) mesh sizes evaluated (2.0 mm to 9.0 mm) would be expected to achieve substantial additional EA1 I&E reductions from the regulatory baseline, and would be comparable to the NYSDEC Proposed Project. However, because CWW screens with smaller slot sizes would create significant opportunity for fouling, a site-specific study of slot sizes ranging from 2.0 mm to 9.0 mm is proposed to determine the optimum slot width for reducing I&E at which fouling would not be a concern.

CWW screens (see Figure 4.8) are designed to reduce I&E in three ways. First, depending on slot size, CWW screens provide a physical barrier preventing aquatic organisms larger than the screen slot size from being entrained. Second, CWW screens are located directly in a source waterbody (and not in a screen house), so sweeping flows can remove organisms from the intake flow field (this increases the effectiveness of avoidance discussed next). Sweeping flows also reduce impingement by moving organisms past the CWW screens, minimizing contact. Third, hydrodynamic exclusion of early life stages results from the low through-slot velocity of the CWW screen that is quickly dissipated, allowing organisms to escape the intake flow field. Larvae too small to be physically excluded by CWW screens have shown an active avoidance response to the changes in flow velocity and direction created by CWW screens [Ref. 6.39]. As discussed in Attachment 6, this avoidance and hydrodynamic exclusion model results in additional reductions in EA1 entrainment losses.



**Figure 4.8 Cylindrical Wedgewire Screen**

CWW screens are designed to provide a large screening area, and a low through-slot velocity (i.e., at or below 0.5 fps) [Ref. 6.94]. The screening surface consists of “V”-shaped “wedge wire” bars that are welded to support rods at their apex and are formed to maintain a uniform screen opening. The slot size is defined as the dimension of the opening between the wide ends of the wedge wire bars. CWW screens with slot sizes larger than 2.0 mm are typically considered to be wide slot screens, while CWW screens with slot sizes of 2.0 mm and smaller are considered to be narrow slot screens. Figure 4.9 shows a detailed view of the wedgewire screening material.

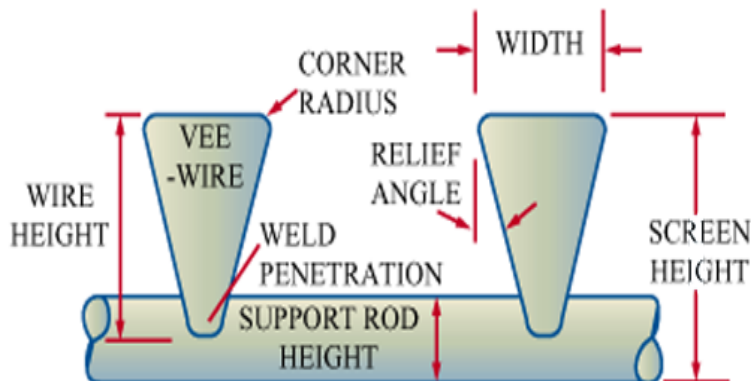

**Figure 4.9 Wedgewire Screening Material**

As shown in Figure 4.10, the shape of the wedge wire bars increases the flow area of the screen surface while reducing obstruction of the screen surface by debris accumulation.

The sharp edges of the wire profile allow for solid particles to make only two points of contact with the screen surface.

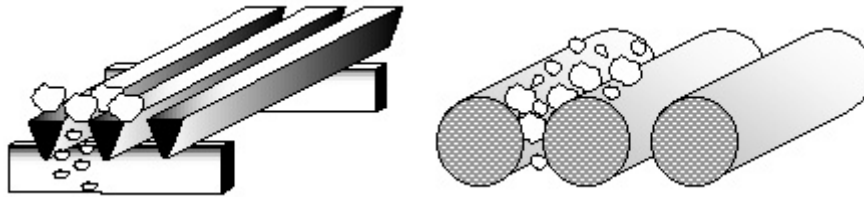

**Figure 4.10 Profile of Wedgewire Material (Left) and Round Wire Material (Right)**

Debris loading and fouling can lead to higher capture velocities and damage early life stage organisms. As such, CWW screen systems can utilize airburst systems that release compressed air through the screens, forcing accumulated debris from the screen surface. As shown in Figure 4.11, an airburst system consists of an air compressor and receiver, a distribution manifold, a control system, and an individual screen air distributor. Debris removed from the screening surface by the airburst system is carried away by the sweeping current of the waterway.

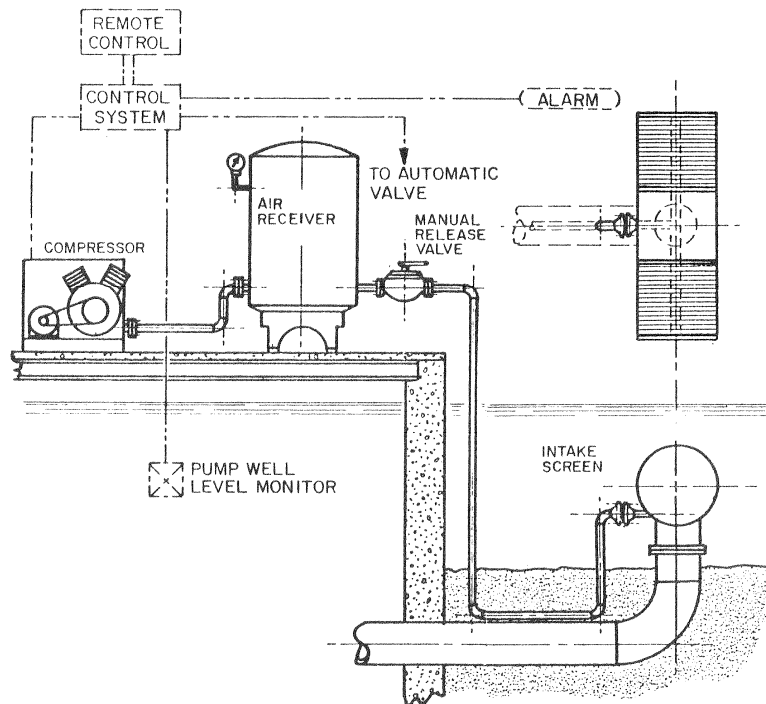

**Figure 4.11 Typical CWW Screen Airburst System [Ref. 6.94]**

Early CWW screen designs and perforated pipe intakes (obsolete intake screening systems that predate CWW screens, discussed further in Section 4.3.2), had inherent design issues that have been addressed through the development of CWW screens. These developments include:

- Internal flow modifications that allow CWW screens to achieve an even velocity distribution across the screen surface area, avoiding areas of high flow concentration. The internal modifications prevent uneven flow distributions. Prior to these modifications, most of the flow would enter the screen through the slots nearest the supply pipe, creating a localized area with high through-slot velocities. In addition, the internal flow modifications allow the length of the screens to be increased, resulting in increased flow through an individual CWW screen; previously, the length of the CWW screens was limited to the size of the screen diameter.
- Airburst systems designed to effectively remove debris from the screen surfaces.
- The use of “V” shaped “wedge wire” bars to increase the flow area of the screen surface while reducing obstruction of the screen surface by debris accumulation.
- The use of different screening materials to reduce biofouling. As shown in Attachment 1, Section 5, CWW screens constructed of a copper-nickel alloy are designed to provide protection against biofouling, specifically zebra mussels.

These developments have led to improved reliability of CWW screen installations and increased operational effectiveness.

There are no applications of CWW screens at nuclear power facilities. However, CWW screens have been effectively used in fossil-fueled power generation facilities. Oak Creek Power Plant in Milwaukee, Wisconsin operates the largest installation of CWW screens. It has four operating Units online that generate a total of 1135 MWe. The Oak Creek CWW screen system includes an offshore intake system situated approximately 6000-7000 ft from the shoreline at a depth of approximately 43 ft. According to Oak Creek (see Attachment 1, Section 6), the CWW system became operational in January 2009 and is designed to operate year round. The offshore intake system uses twenty-four (24) 8-ft diameter CWW screens with a slot size of 0.375 inches to filter a flow rate of 1,560,000 gpm (see Attachment 1, Section 6). The total intake flow rate at Oak Creek is comparable to the total intake flow rate at IPEC Units 2 and 3. The CWW screen system at Oak Creek was designed to provide a through-screen velocity at or below 0.5 fps and the system was oversized by approximately 16% (3 additional screens) to provide a margin against fouling. Johnson Screens, a leading CWW screen manufacturer, supplied Oak Creek’s CWW screens. The entire screen assemblies are manufactured from copper-nickel alloy. The CWW screens are mounted to 4 manifolds; six CWW screens are mounted to each manifold. The manifolds are connected to drop tunnels that discharge into a single transmission tunnel that flows towards the shoreline into the plant’s wetwell. The transmission tunnel was bored into the bedrock and has a total length of 9200 ft. Cooling water from the wetwell is subsequently pumped to the condenser of each Unit.

At Oak Creek, flow reductions, potentially caused by fouling and the associated differential pressure increases across the CWW screen system, are measured by gauging the water level in the wetwell. The original shoreline intake system remains operational and is

isolated using stop logs, so that, in the event that flow through the CWW screen system is not available or reduced, the stop logs can be manually opened to restore flow to the facility using lifts actuated by heavy-duty electric wrenches. Due to the distance of the offshore intake to the facility, Oak Creek's CWW system is not equipped with an airburst system; however, fouling of the CWW screens is not a significant concern based on the characteristics of the source waterbody (Lake Michigan). Biofouling caused by zebra mussels has not been an issue due to the use of copper-nickel alloy screens. A frazil ice fouling event<sup>15</sup> occurred early in 2009; however, flow through the CWW system was quickly restored without compensatory actions.

CWW screen systems have also been installed at facilities located on the Hudson River. The Charles Point Resource Recovery Facility (Charles Point), formerly known as Westchester RESCO, is located approximately ½ mile northwest of IPEC on the eastern shoreline of the Hudson River. Charles Point is a waste to energy facility that produces approximately 60 MWe and utilizes a once-through cooling system with a flow rate of 55 MGD. The cooling water intake utilizes 2.0 mm CWW screens installed in 1986 to draw water at an offshore distance of approximately 800 ft. There are eight (8) 54 inch diameter CWW screens constructed of a copper nickel alloy situated in four pairs on T-stands approximately 5 ft above of the Riverbed. According to Charles Point (see Attachment 1, Section 7), the CWW screens at Charles Point operate year round and utilize an airburst system that discharges twice daily via timers. A dive team is dispatched annually to visually inspect the screens. If there are local areas of debris buildup identified during the inspection dive, the divers will remove the debris. Flow reductions due to frazil ice were reported to occur during periods of extreme cold temperatures combined with low River water levels. These events were reported to occur every 2-3 years, and flow through the CWW screens is restored by using the airburst system. No other operational issues associated with the Charles Point CWW screens were reported.

Two 0.125-inch slot CWW screens are installed at the IBM facility in Poughkeepsie, NY and provide Hudson River water for the facility's HVAC chillers (see Attachment 1, Section 8). The CWW screens at the IBM facility have a maximum intake flow rate of 60,000 gpm per screen. According to the Facility Engineer (Attachment 1, Section 8), the stainless steel screens were installed in the early-1980s and operate year round. The CWW screens are equipped with an airburst system that discharges hourly. The CWW screens were removed and inspected in 2004 for potential damage caused by impacts from ice floes. Minor dents and a small quantity of zebra mussels were identified. Flow through the CWW screens is maintained using the airburst system. No significant fouling issues were reported, although minor icing reportedly occurs during winter months. No other operational issues associated with the IBM facility's CWW screens were reported.

In order to filter the required 840,000 gpm of CW flow per Unit at IPEC, multiple CWW screens would be required. In addition, several different slot sizes were preliminarily evaluated for the Stations. Table 4.2 shows the number and size of CWW screens that

---

<sup>15</sup> Granular ice crystals formed in turbulent, supercooled water are referred to as "frazil ice." Supercooled water occurs when the water temperature begins to drop and passes through the 32°F point. At a temperature of less than 32°F, tiny particles of ice form quickly and uniformly through the water mass. Frazil ice is extremely adhesive and will stick to any solid metallic object that is at or below the freezing point.



would be required to maintain the CW flow while retaining a maximum through-slot velocity at or below 0.5 fps.

**Table 4.2 Wedgewire Screens Required to Maintain Minimum Through-Slot Velocity of 0.5 fps**

Slot Size	# of Screens	Screen Length	Screen Diameter
9.0 mm (~ 3/8 inch)	48	257 inch	72 inch
6.0 mm (~ 1/4 inch)	48	267 inch	66 inch
3.0 mm (~ 1/8 inch)	72	239 inch	66 inch
2.0 mm (0.078 inch)	72	257 inch	72 inch
1.5 mm (0.059 inch)	60	300 inch	84 inch
1.0 mm (0.040 inch)	72	300 inch	84 inch

Low through-slot velocities would be used to ensure that organisms are not impinged on the screen because they cannot swim away from the intake velocity. According to the Hudson River Power Plants Final Environmental Impact Statement [Ref. 6.88], although EPA typically recommends CWW through-slot velocities at or below 0.5 fps, NYSDEC has indicated interest in through-slot velocities at or below 0.25 fps. As such, Table 4.3 shows the number and size of CWW screens that would be required to maintain the CW flow while retaining a maximum through-slot velocity of 0.25 fps or less.

**Table 4.3 Wedgewire Screens Required to Maintain Minimum Through-Slot Velocity of 0.25 fps**

Slot Size	# of Screens	Screen Length	Screen Diameter
9.0 mm (~ 3/8 inch)	96	257 inch	72 inch
6.0 mm (~ 1/4 inch)	96	267 inch	66 inch
3.0 mm (~ 1/8 inch)	144	239 inch	66 inch
2.0 mm (0.078 inch)	144	257 inch	72 inch
1.5 mm (0.059 inch)	120	300 inch	84 inch
1.0 mm (0.040 inch)	144	300 inch	84 inch

Because CWW screens with smaller slot sizes would create significant risk of fouling, only designs for CWW screen systems with slot sizes ranging from 2.0 mm (i.e., the slot size

used at Charles Point) to 9.0 mm (the slot size used at Oak Creek) were developed in an attempt to minimize both entrainment and fouling.

- Conceptual layout drawings of potential 9.0 mm and 2.0 mm slot CWW screen systems sized for through-slot velocities of 0.5 fps are shown in Attachment 2, Figures 2-9 and 2-11, respectively. Plan and detail drawings associated with the layout drawings of systems sized for through-slot velocities of 0.5 fps are shown in Attachment 2, Figures 2-10 and 2-12.
- Conceptual layout drawings of potential 9.0 mm and 2.0 mm slot CWW screen systems sized for through-slot velocities of 0.25 fps are shown in Attachment 2, Figures 2-13 and 2-15, respectively. Plan and detail drawings associated with the layout drawings of systems sized for through-slot velocities of 0.25 fps are shown in Attachment 2, Figures 2-14 and 2-16.

These layouts depict arrays of CWW screens attached to transmission piping that flows into common headers leading into the CWISs. The CWW screen systems would be located within the IPEC's existing exclusion zone; thus, implementation of the CWW screen systems would not limit navigability of the Hudson River. As shown in the plan and detail drawings, the common headers would connect to the CWISs downstream of the TWSs, allowing the existing screening systems to maintain operability. Newly installed stop logs and isolation valves would enable the CWW screen arrays to be isolated for maintenance, repair, or seasonal operation.

The conceptual CWW screen systems would be equipped with sensors in the CW pump pits monitoring water elevation. Decreases in water elevation would typically indicate debris accumulation on the screen surfaces, because fouling of the CWW screen slots adds further resistance to the flow of intake water and results in reduced flow volumes. When a predetermined water elevation was reached, the airburst system would be activated. The airburst cycle would dislodge debris from the CWW screens, returning the water level to an acceptable level. The sensors would also monitor the effectiveness of the airburst system in removing debris from the screen surfaces by measuring the water elevation following an airburst cycle. If the airburst systems could not adequately remove debris from the CWW screen surfaces, the water elevation would continue to fall until a second, lower water elevation was reached. At this lower water elevation, hydraulic operators installed on the existing stop logs would be used to raise the stop logs allowing cooling water to be withdrawn from the Hudson River through the existing TWSs. The stop log system would ensure a reliable supply of cooling water, preventing air intrusion and cavitation in the CW pumps, which could lead to unnecessary, unplanned reactor shutdowns.

There are several considerations with respect to the retrofit of CWW screens at the Stations summarized below:

- CWW screens are susceptible to damage and clogging due to ice formation on the screens during the winter months. Granular ice crystals formed in turbulent, supercooled water are referred to as "frazil ice." Supercooled water occurs when the water temperature begins to drop and passes through the 32°F point. At a temperature of less than 32°F, tiny particles of ice form quickly and uniformly

- through the water mass. Frazil ice is extremely adhesive and will stick to any solid metallic object that is at or below the freezing point [Ref. 6.94]. CWW screens are highly susceptible to formation of ice on the screens, as documented by the U.S. Army Corps of Engineers [Ref. 6.112]. Although the Stations do not have a history of frazil ice issues with the existing CWISs, due to the location of the CWW screens and the general susceptibility of CWW screens to frazil ice, any site-specific CWW pilot study would evaluate potential frazil ice events.
- Water flow through CWW screens, and their effectiveness with respect to entrainment, can be limited by debris buildup on the surface of the screens and siltation below the screens. Debris buildup can be periodically removed from the CWW screen surfaces by utilizing an airburst system. Without a sweeping current, the dislodged debris could resettle on the screen surface. A minimum sweeping current of at least 1 fps past the CWW screens is recommended to minimize clogging from debris accumulation [Ref. 6.115]. The Hudson River has two flood and two ebb tides within a 24.8-hour period, referred to as a semidiurnal pattern (see Section 2.3.1). The average sweeping current of the Hudson River is 1.0 fps for the flood tides and 2.1 fps for the ebb tides based on maximum observed velocities. The actual slack tide lasts for a short period as the tide changes between flood and ebb conditions. The sweeping current during the ebb and flood tides should be sufficient to facilitate adequate cleaning of the CWW screens using an airburst system. As shown in the layout drawings (Attachment 2, Figures 2-9 through 2-16), a CWW screen system at the Stations would require an array of screens that would be situated a minimum of 40 ft offshore to allow clearance for transmission piping, isolation valves, and dredging.
  - Any CWW screens used at the Stations would need to maintain the consistent intake flow required for cooling. Typically, smaller slot size screens are more susceptible to fouling, which can reduce flow. On-site physical testing would be required at the Stations to determine the optimum slot size that would address entrainment goals while ensuring a reliable flow of cooling water.
  - Adequate CW pump submergence is required to prevent air intrusion into the circulating water pumps, and a submergence margin is employed to prevent this occurrence because air intrusion and cavitation in the CW pumps could lead to unnecessary, unplanned reactor shutdowns. The resistance of the CWW screens (assumed clear of fouling or clogging) and the associated piping systems would reduce the water elevation within the CWISs and, therefore, the submergence of the CW pumps. As fouling or clogging of the CWW screens occurred, resistance through the screens would increase, causing additional water level drop in the pump bay and a reduced submergence margin for each pump. In order to avoid damage to the CW pumps caused by air entrainment, the evaluated design of the CWW screen systems require the existing CW pump pits to be excavated and deepened by approximately 6 ft. New extended pump shafts and impellers would be installed on the existing CW pumps. Deepening of the existing CW pump pits, along with installation of extended pump shafts and impellers, would ensure the submergence margin and water level required to prevent the effects of air entrainment.

In order to establish a CWW screen system that balances biological and operational effectiveness, a laboratory study of CWW screen systems would be recommended prior to full-scale implementation of a CWW screen system at Unit 2 or Unit 3. Additionally, a small scale on-site pilot study would also be recommended to begin evaluating the site-specific fouling and operational issues, including the installation of CWW screens at a single CW pump bay. The on-site study should continuously monitor pressure differential (head loss) across the screen surface as the increases in pressure differential due to fouling would be used to design set points and operational frequency of the air backwash system. The on-site study should identify the optimal location and orientation of the screen arrays within the River, and the optimal vertical location of the CWW screens off of the Hudson River bed. In particular, the minimal height off of the River bed that eliminates the possibility of siltation should be identified and the temperature gradient with respect to depth in the water column should be established.

Test deployment of the screens should be year-round to determine if River conditions are acceptable for year-round CWW screen operation, similar to Charles Point and the IBM Facility. Several different screening materials (304SS/316L/Z-Alloy) would also be tested to determine the optimum material to resist corrosion and biofouling. The study should also attempt to identify fouling sources and fouling rates. The fouling sources and rates should be established for each month of operation to identify periods of high vulnerability (e.g., eelgrass could be problematic in the spring, while leaves could be a concern in the fall, or icing in the winter).

Based on these study results, installation and operation of a full scale CWW screen system and airburst system at one Unit would be recommended. This installation would allow the Stations to more fully evaluate the performance of a CWW screening system at the Stations. The particular engineering parameters studied would include the frequency of airburst operation required to maintain a through-slot velocity at or below 0.5 fps and the optimum placement of the CWW screens in the water column to avoid siltation, icing, and fouling.

#### Maintenance

The use of narrow slot openings (i.e., 2.0 mm and smaller) dictates that the screens should be closely monitored and inspected at more frequent intervals. When the screens are initially installed, they should be inspected on a quarterly basis for the first 12 to 15 months of operation to monitor fouling/icing. Once the rate of fouling/icing has been established, inspection frequency should be altered to coincide with fouling/icing patterns.

The evaluated CWW screens would have several O&M requirements as detailed below:

- Inspect airburst systems
- Activate air cleaning systems periodically to clean CWW screens
- Inspect/lubricate isolation valves
- Manually exercise isolation valves
- Inspect CWW screens using divers or cameras
- Manually brush and/or hydroclean CWW screens

When debris accumulates on the screen body, the screens would be cleaned with an airburst system. Operations personnel would likely perform O&M activities associated with maintenance of the airburst systems and isolation valves. The frequency of manual cleaning of the screens would need to be determined by operations after installation in order to account for conditions specific to the Hudson River.

The maintenance costs would include the costs required to maintain the existing coarse mesh TWSs, the new airburst systems, and the new stop log systems. Additional underwater inspection and cleaning of the CWW screens would likely be performed by a subcontracted team of divers. Additionally, parasitic power losses due to the operation of air compressor motors for the airburst systems were evaluated. The estimated power requirements per Unit are based on two 35 hp motors operating continuously for 52 weeks. Based on these assumptions, the additional parasitic losses associated with operation of the air compressor motors for the airburst systems at each Unit would be approximately 456 MW-hr per year (912 MW-hr per year, total) for a CWW system designed for a through-slot velocity of 0.5 fps. For a CWW system designed for a through-slot velocity of 0.25 fps, the additional parasitic losses associated with operation of the air compressor motors for the airburst systems at each Unit would be approximately 912 MW-hr per year (1824 MW-hr per year, total).

#### Cost

The capital cost estimates for the implementation of the evaluated CWW screens at the Stations are detailed in Attachment 4. Equipment quotes from vendors are provided in Attachment 1. The total estimated capital costs for the installation of copper-nickel CWW screens at IPEC Units 2 and 3 with a through-slot velocity of 0.5 fps and airburst cleaning would be approximately \$41.7 million for 2.0 mm screens, and approximately \$36.5 million for 9.0 mm CWW screens. The total estimated capital costs for the installation of copper-nickel CWW screens at IPEC Units 2 and 3 with a through-slot velocity of 0.25 fps and airburst cleaning would be approximately \$63.3 million for 2.0 mm screens, and approximately \$52.0 million for 9.0 mm CWW screens. As shown in Attachment 1 Section 5, CWW screens constructed of copper-nickel could provide further protection against biofouling, specifically zebra mussels.

Several unknown factors associated with the conceptual CWW system design developed above would require resolution during the detailed design phase. These factors include: (1) design and analysis to evaluate potential flow issues within the CWISs and vortexing by the CW pumps, (2) uneven bathymetry in the River in front of the Stations requiring a different footprint or non-standard installation techniques for the CWW screen arrays, and (3) the extent of laboratory and site-specific tests of the CWW screen arrays. These factors could more than double the costs, increasing the total cost of implementing CWW screen systems to more than \$100 million.

Excavation of the existing CW pump pits and the tie-in of the CWW screen headers would take approximately six to eight weeks per pump pit, assuming that construction activities are performed 24 hours per day. Excavation of a single pump pit at each Unit could be conducted simultaneously, allowing the Units to remain online although a reduction in load would result from the reduced CW flow. Therefore, the Stations would experience approximately 36 to 48 weeks of reduced generating capacity at each Unit during

construction. Note that this is a conservative construction estimate and is considered a ‘best case’ scenario because actual construction scheduling would be dependent on numerous unknown factors including the geologic composition of the material below the pump pits, the ability of construction activities to be performed due to local weather conditions, and the ability to work 24 hours per day. Several excavation and tie-in construction tasks would require a full Unit outage to be completed; however, it is likely that these tasks could be scheduled to coincide with a routine maintenance outage for each Unit. Refueling outages are anticipated to last approximately 25 days (almost 4 weeks); therefore, there would be a total of approximately 32 to 44 weeks of reduced generating capacity at each Unit during the implementation of the evaluated CWW screen options. As discussed in Section 2.1, the Stations currently generate electricity at a rated capacity of approximately 1078 MWe and 1080 MWe for Units 2 and 3, respectively. A 32 to 44 week period of reduced generating capacity would result in a loss of approximately 22,000 to 30,000 MW-hrs at Unit 2, and approximately 11,000 to 16,000 MW-hrs at Unit 3. If the required construction and tie-in activities could not be scheduled to coincide with a routine maintenance outage, the construction costs would increase.

#### I&E Discussion

As noted earlier, CWW screens are designed to reduce I&E in three ways. First, depending on slot size, CWW screens provide a physical barrier preventing aquatic organisms larger than the screen slot size from being entrained. Second, since CWW screens are located directly in a source waterbody (and not in a screen house), sweeping flows can remove organisms from the intake flow field (this increases the effectiveness of avoidance). Sweeping flows also reduce impingement by moving organisms past the CWW screens, minimizing contact. Third, hydrodynamic exclusion of early life stages results from the low through-slot velocity of the CWW screen that is quickly dissipated, allowing organisms to escape the intake flow field. Larvae too small to be physically excluded by CWW screens have shown an active avoidance response to the changes in flow velocity and direction created by CWW screens [Ref. 6.39]. As discussed in Attachment 6, this avoidance and hydrodynamic exclusion model results in additional reductions in EA1 entrainment losses.

Attachment 6 (Tables 17 and 23 of Appendix A) provide the estimated reductions from the regulatory baseline in EA1 losses that could be achieved using 9.0, 6.0, 3.0, 2.0, 1.5, and 1.0 mm CWW screens sized for through-slot velocities at or below 0.5 fps, including the Stations’ survival rates (Attachment 6) and average historic flow reductions (Section 2.4.2.3.2). A summary of the information included in the tables is shown in Table 4.4. Note that the maximum possible reductions in EA1 I&E shown in Table 4.4 (99.9% and 89.8%, respectively) are substantially higher than the current EA1 I&E reductions (80.2% and 33.8%, respectively) shown in Section 3.2.

**Table 4.4 Potential Percent Reduction of Annual EA1 I&E Losses due to CWW Screens in Each Month with Through-Slot Velocities of 0.5 fps**

Month	EA1 Entrainment Loss Reduction						EA1 Impingement Loss Reduction
	9.0 mm	6.0 mm	3.0 mm	2.0 mm	1.5 mm	1.0 mm	
January	0.0%	0.0%	0.0%	0.0%	0.0%	0.0%	9.6%
February	0.0%	0.0%	0.0%	0.0%	0.0%	0.0%	10.5%
March	0.0%	0.0%	0.0%	0.0%	0.0%	0.0%	13.1%
April	0.5%	0.5%	0.5%	0.5%	0.5%	0.5%	8.2%
May	8.3%	8.3%	8.3%	8.3%	8.3%	7.9%	10.0%
June	28.2%	28.2%	28.2%	28.3%	28.2%	27.7%	12.7%
July	26.5%	26.5%	26.5%	26.5%	26.6%	26.6%	5.5%
August	14.8%	14.8%	14.8%	14.8%	14.8%	14.8%	5.7%
September	6.4%	6.4%	6.4%	6.4%	6.4%	6.4%	6.0%
October	4.9%	4.9%	4.9%	4.9%	4.9%	4.9%	5.1%
November	0.0%	0.0%	0.0%	0.0%	0.0%	0.0%	5.7%
December	0.0%	0.0%	0.0%	0.0%	0.0%	0.0%	7.8%
Annual	89.6%	89.6%	89.7%	89.8%	89.7%	88.8%	99.9%

An evaluation of the cumulative benefits of reductions in I&E over the expected lifetimes of Unit 2 and Unit 3 was provided in Attachment 6, accounting for both expected annual reductions in I&E losses and for the implementation time required for the technologies. For the cumulative benefits analysis, it was assumed that CWW screens could be installed and operating at Unit 2 in 2013 and at Unit 3 in 2015, the NYSDEC Proposed Project would become operational at both Units in 2029, and that both Units would cease operation in 2035.<sup>16</sup> As discussed in ENERCON's Engineering Feasibility and Costs of Conversion of Indian Point Units 2 and 3 to a Closed-Loop Condenser Cooling Water Configuration [Ref. 6.22], implementation of the NYSDEC Proposed Project would involve extended delays due to the technical complexity of the project, permitting requirements, and likely litigation relating to local zoning ordinances. Other technologies that are nearly as effective as the NYSDEC Proposed Project at reducing I&E losses, such as CWW screens, could be installed much sooner; therefore, reductions in I&E losses could begin almost immediately rather than being deferred for an extended period while technical and legal issues associated with the NYSDEC Proposed Project are resolved. Because of the earlier installation date, cumulative reductions in I&E losses over the lifetimes of Units 2 and 3 could be much greater for alternative technologies than for the NYSDEC Proposed Project. According to Attachment 6 (Appendix A, Table 27), the NYSDEC Proposed Project would result in only a 50% cumulative reduction in estimated

<sup>16</sup> As discussed in Attachment 6, the installation schedule for CWW screens is consistent with a proposal based on studies of this technology. The installation schedule for the NYSDEC Proposed Project was derived by ENERCON [Ref. 6.22] with input from counsel to Entergy and Spectra Energy Transmission (owner of the gas pipeline that would have to be re-located in order to construct the NYSDEC Proposed Project).

EA1 entrainment losses and an 86% cumulative reduction in estimated EA1 impingement losses, compared to the regulatory baseline. The reason for this is that, for most of the years between 2013 and 2029, the existing technology would still be operating. In contrast, for CWW screens, estimated cumulative total EA1 impingement and entrainment losses would be reduced by approximately 98% and 87%, respectively. These results indicate that the CWW screens would be substantially more effective than the NYSDEC Proposed Project at reducing I&E below the losses associated with the existing technology.

### Conclusions

Estimated capital costs associated with the installation of CWW screens with a through-slot velocity of 0.5 fps would be approximately \$41.7 million for 2.0 mm screens, and approximately \$36.5 million for 9.0 mm CWW screens. The estimated capital costs for the installation of CWW screens with a through-slot velocity of 0.25 fps would be approximately \$63.3 million for 2.0 mm screens, and approximately \$52.0 million for 9.0 mm CWW screens. As described previously, several unknown factors associated with the conceptual CWW system design developed above would require resolution during the detailed design phase. These factors could more than double the costs, increasing the total cost of implementing CWW screen systems to more than \$100 million. There would also be a loss of approximately 33,000 to 46,000 MW-hrs due to the CW pump pit excavation and construction. As shown in Table 4.4, each of the mesh sizes evaluated would be expected to achieve substantial reductions in EA1 I&E, comparable to the NYSDEC Proposed Project. In addition, according to Attachment 6, the estimated cumulative total reduction in EA1 entrainment losses for CWW screens (88%) would be greater than the estimated cumulative total reduction in EA1 entrainment losses for the NYSDEC Proposed Project (55%). Because CWW screens with smaller slot sizes would create significant opportunity for fouling, slot sizes ranging from 2.0 mm to 9.0 mm were selected for initial evaluation in an attempt to minimize both entrainment and fouling. A site-specific engineering and biological effectiveness study would be required to determine the optimum slot width for reducing EA1 entrainment losses while limiting fouling.

### **4.3.2 Perforated Pipe Inlets**

Perforated pipe inlets are obsolete systems that have been replaced by the development of CWW screens. They are not considered as viable alternatives to the existing technologies at the Stations, due to serious operational risks, including increased head loss across the screen face, poor velocity distribution across the screens, and surface profiles prone to clogging or snagging.

Perforated pipe inlets draw water through round or elongated perforations in cylindrical plate sections placed in a water body. Perforated pipe inlets are designed to produce low through-screen velocities. When implementing perforated pipe inlets, the perforated sections are situated parallel to the ambient current in order to use the sweeping flow to reduce impingement. Perforated pipe inlets can be designed in multiple configurations as shown in Figure 4.12. Plan and profile views of a perforated pipe inlet system are shown in Figure 4.13, and a plan view of the perforated pipe sections is shown in Figure 4.14.



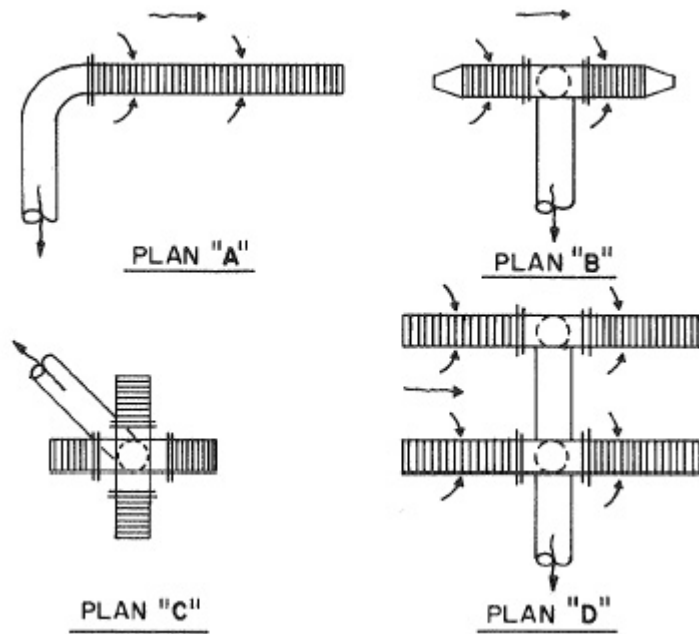

Figure 4.12 Plan Views of Perforated Pipe Inlet Variations [Ref. 6.2]

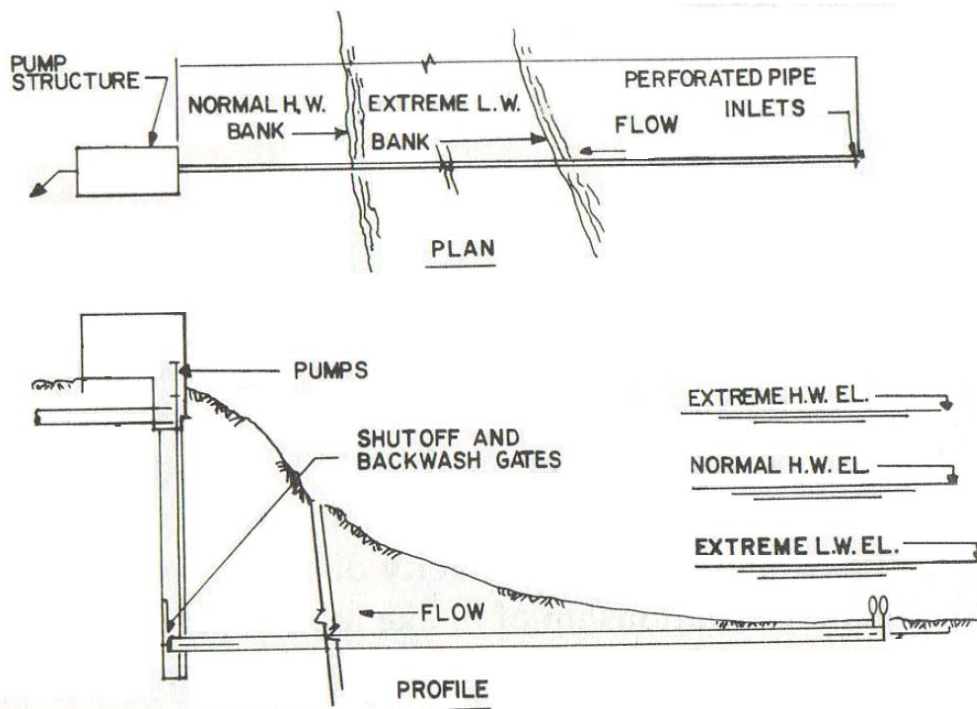
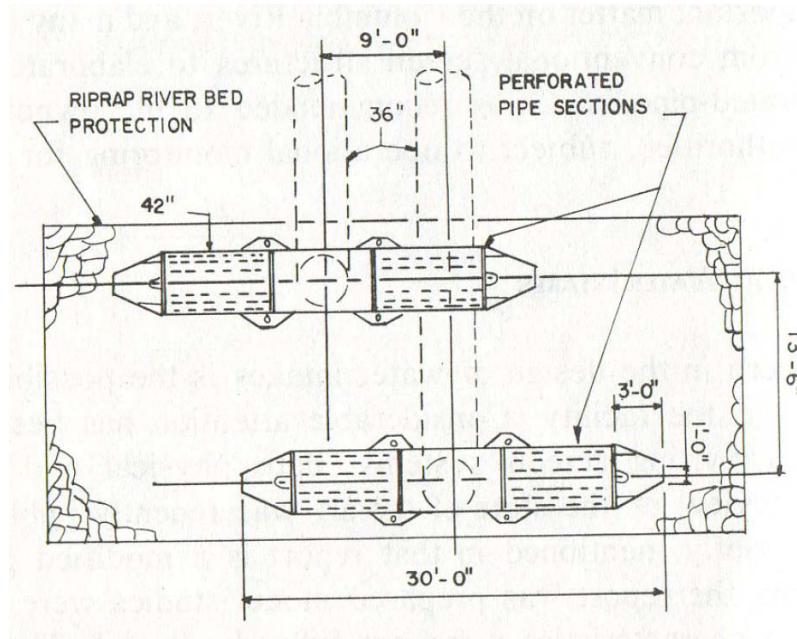

Figure 4.13 Perforated Pipe Inlet System [Ref. 6.101]



**Figure 4.14 Plan View of Perforated Pipe Inlets [Ref. 6.101]**

#### I&E Discussion

Due to the similarities between perforated pipe intakes and the wedgewire screen systems discussed in Section 4.3.1, it is expected that the I&E reductions would be similar. However, as discussed previously, perforated pipe intakes often have head loss, debris buildup, and velocity distributions issues that could attribute to increased impingement loss [Ref. 6.2].

#### Conclusions

Obsolescence of perforated pipe intakes has been caused by the development of CWW screens, which began in the late 1970s. Although perforated pipe intakes are very similar to the CWW screens discussed in Section 4.3.1, the perforated pipe openings increase the head loss across the screen face, create a poor velocity distribution, and create a surface profile prone to clogging or snagging when compared to the wedge-shaped wire screen used in CWW screens. Therefore, perforated pipe intakes are not further considered as an alternative to the existing intake technologies.

### **4.3.3 Porous Dikes/Leaky Dams**

Although the implementation of porous dikes, also known as leaky dams or leaky dikes, would be theoretically possible, porous dikes are not considered as viable alternatives to the current screening systems at the Stations due to nuclear-safety related issues with the conceptual designs and the unproven nature of this technology in front of the service water systems at nuclear generating facilities. More specifically, because the safety-related service water channels would be enclosed by any of the conceptual configurations, any reduction in void spaces within the porous dikes caused by debris, siltation, or fouling,

including by colonization of fish and plant life, combined with the lack of a back flushing system associated with these systems, could implicate nuclear-safety related issues and potential interruptions in operations due to flow reliability issues with the circulating water system.

Porous dikes are filters resembling a breakwater that surround a cooling water intake. The core of a porous dike consists of riprap stone, cobble, or gravel contained within wire-mesh cages that allow for the free passage of water through the voids or pores. Porous dikes act as behavioral and physical barriers to juvenile and adult fish, keeping them from entering a CWIS. The size of the pores in the core of the dike determines the biological effectiveness, the through-core intake velocity, and the amount of maintenance required. Although smaller pores would be expected to allow fewer fish to pass through the core of a porous dike, the through-core intake velocity would increase, as would the amount of maintenance required. Figure 4.15 shows plan and section views of a typical porous dike.

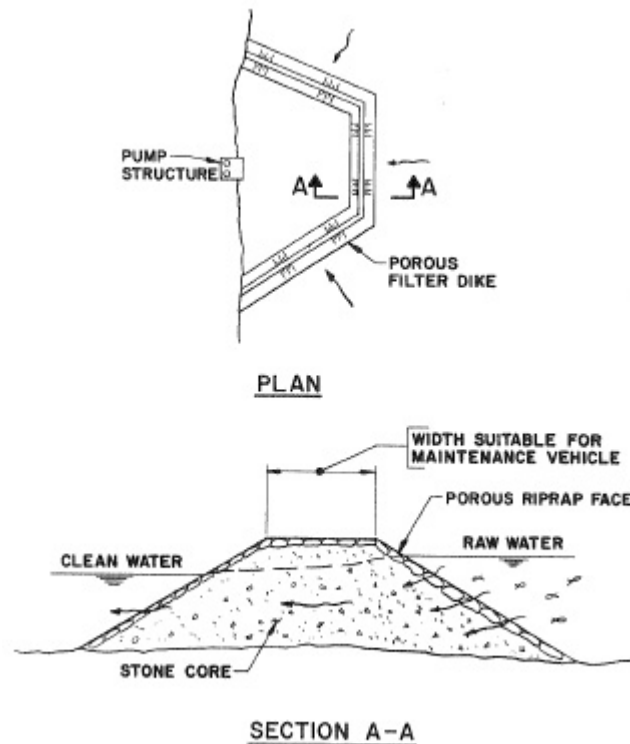

**Figure 4.15 Plan and Section View of a Porous Dike [Ref. 6.2]**

Porous dikes are typically used only for low flow rate applications, and currently no porous dike installations exist at nuclear power generating facilities or comparatively sized fossil-fuel generating facilities. The primary concern with porous dikes, particularly at nuclear facilities, is the potential for fouling. While fouling is a substantive issue for barrier and screening technologies, it is a particular issue for porous dikes, because back-flushing systems, commonly used in other screening technologies, are not feasible for porous dikes [Ref. 6.115]. Additional concerns include the buildup of ice against the porous dike walls, engineering practicality, and limitations to the recreational and nautical use of the waterway.

At nuclear facilities, any reduction in void spaces within the porous dikes caused by debris and silt and/or fouling by colonization of fish and plant life, combined with the lack of a back flushing system, could lead to an interruption of cooling water supply to nuclear-safety related systems and interruptions in the operation of the plant due to flow reliability issues with the circulating water system. The addition of this new failure mode for the SW system would affect the licensing basis of the plant and would therefore require an amendment to the Stations' NRC licenses (License Amendment). Similarly, a redesign of the SW system to avoid or mitigate new failure modes would also affect the licensing basis of the plant and would require a License Amendment.

The hydraulic and fouling characteristics of porous dikes were studied at a testing facility on the estuarine Mount Hope Bay for the Brayton Point Generating Station (BPGS), beginning in July 1979. The porous dike used for testing consisted of a reinforced concrete and steel structure with a water intake channel sectioned into three 6 ft wide and 20 ft deep sections. The first and third sections were filled with wire-mesh cages containing 3 inch stone and 8 inch stone, respectively. The center section was left open and used as a control channel. Performance of the porous dikes was characterized by an increase in head loss across the upstream and downstream faces of the test sections and a reduction in flow volume. Daily head losses were similar for the first and third sections, where increases in head loss correlated with observed fouling. The maximum reported flow rate for the first section was approximately 23 gpm/ft<sup>2</sup>, and the maximum reported flow for the third section was approximately 32 gpm/ft<sup>2</sup>. The approach velocity of the water entering the porous dike sections was consistent at approximately 0.1 fps; however, flows below 0.1 fps were obtained below the low water mark of the dikes, indicating that increased fouling occurred near the bottom. Tubes inserted into the test sections were used to measure increases in weight and biofouling, which correlated to void space reductions. Biological analysis of the fouling tubes indicated that approximately half of the accumulated materials in the porous dike sections were live organisms [Ref. 6.69]. Porous dikes were never implemented for full scale operation at BPGS.

Artificial breakwaters, which are similar in construction to porous dikes, have been shown to increase habitat for demersal fishes and invertebrates. An artificial breakwater is used to protect the ocean shoreline CWIS at the Pilgrim Nuclear Power Station (Pilgrim) in Plymouth, Massachusetts. The presence of a breakwater, like the one at Pilgrim, attracted a community of macroscopic algae, hydroids and other biofouling organisms that created a multi-tiered and diverse habitat. In turn, this diverse habitat attracted reef-dwelling fish, specifically cunner (*Tautoglabrus adspersans*). Since porous dikes are similar in construction to the breakwater at Pilgrim, they may function as artificial reefs, and – when built in ecosystems with limiting hard substrate habitat – are likely to attract a diverse community. In estuarine ecosystems, like the Hudson River Estuary, the sediment burden carried by freshwater inflow is likely to increase the potential for clogging of the pore spaces needed for porous dikes to work as they were designed [Ref. 6.76; Ref. 6.98].

For the Stations, sizing of conceptual porous dikes was estimated using a surface area of 120 ft<sup>2</sup> and the BPGS maximum flow rate of the 8 inch stone section (32 gpm/ft<sup>2</sup>) as a scaling factor. Water depths in the vicinity of the Stations' CWISs range from approximately 12 ft to 80 ft [Ref. 6.80], and, assuming an average submerged depth of 50 ft, a conceptual porous dike at Unit 2 would require a length of approximately 545 ft to

filter 870,000 gpm (design CW flow of 840,000 gpm and design SW flow of 30,000 gpm). Unit 3 would require a conceptual porous dike with a length of approximately 550 ft to filter 876,000 gpm (design CW flow of 840,000 gpm and design SW flow of 36,000 gpm). Assuming an average submerged depth of 50 ft is conservative (i.e., understates the required length), because a greater average submerged depth reduces the required length of the conceptual porous dikes. As shown in Attachment 2, Figure 2-17, the Unit 2 and Unit 3 porous dikes would extend approximately 125 ft and 75 ft, respectively, from the shoreline of the Stations into the Hudson River. The endpoints for the conceptual Unit 2 porous dike would be the existing asphalt road north of the Unit 2 CWIS and the southern end of the Unit 2 wing wall, and the endpoints for the conceptual Unit 3 porous dike would be near the southern perimeter of the condensate polishing building and the northern end of the discharge canal.

A single conceptual porous dike enclosing the CWISs for Units 2 and 3 would also include the CWIS for Unit 1 (i.e., the porous dike would also be required to filter the 16,000 gpm design flow for the Unit 1 RW pumps). In order to filter the combined flowrate of 1,762,000 gpm, a porous dike with a total length of approximately 1110 ft would be required, assuming an average submerged depth of 50 ft. As shown in Attachment 2, Figure 2-18, the single conceptual porous dike would extend approximately 105 ft into the Hudson River with a shoreline distance of approximately 900 ft. The north and south endpoints for the conceptual porous dike enclosing the CWISs for Units 2 and 3 is near the north end of the Unit 2 wing wall and south end of the Unit 3 wing wall, respectively.

#### I&E Discussion

At the Stations, a porous dike would be sized to produce a through-slot velocity at or below 0.5 fps. According to 40 CFR §125.94, if a facility reduces its through-screen velocity to at or below 0.5 fps, it is “deemed to have met the impingement mortality performance standards”. Because the effectiveness of screening early life stages by porous dikes has not been established at any site [Ref. 6.2], a study would be required to estimate the potential reductions in entrainment losses.

#### Conclusions

As shown in Attachment 2, Figures 2-17 and 2-18, the safety-related SW channels would be enclosed by either of the conceptual porous dike configurations. Therefore, any reduction in void spaces within the porous dikes caused by debris, siltation and/or fouling by colonization of fish and plant life, combined with the lack of a back flushing system associated with these systems, could implicate nuclear-safety related issues and potential interruptions in operations, due to flow reliability issues with the service water and circulating water systems. Based on these nuclear-safety related issues, the installation of porous dikes is not considered as a viable alternative to the current screening systems.

## **4.4 Barrier Technologies**

### **4.4.1 Aquatic Filter Barriers**

Although Aquatic Filter Barriers (AFBs) are theoretically feasible and have the potential to reduce I&E, certain operational issues (specifically, fouling and icing concerns) could

prohibit their operation at the Stations throughout the year. In addition, the actual design and installation of an AFB at the Stations would require extensive biological, geotechnical, and field studies to determine the optimum curtain size, perforation size, anchoring system, airburst operation schedule, and maintenance schedule. Furthermore, implementation of AFBs at the Stations would present significant nuclear safety and licensing issues (including probable License Amendments) that would need to be resolved prior to permitting of the AFBs. AFBs are not currently installed, nor have ever been licensed or installed in front of a service water intake at a nuclear facility.

The Aquatic Filter Barrier (AFB) is a relatively new technology for use at cooling water intake structures [Ref. 6.19]. The AFB is permeable to water but relatively impermeable to fish, shellfish, and ichthyoplankton, and therefore capable of reducing both I&E [Ref. 6.19]. Gunderboom® has a patented full-water-depth filter curtain, composed of polyethylene or polypropylene fabric that is supported by flotation billets at the surface of the water and anchored to the bottom of the water body. This AFB system is referred to as the Gunderboom® Marine Life Exclusion System™ (MLEST™). The MLEST™ completely surrounds the intake structure, preventing organisms from entering the cooling water intake. A deployed Gunderboom® system is shown in Figure 4.16.



**Figure 4.16 Gunderboom® MLEST™ Deployed at Lovett Generating Station**

The Gunderboom® MLEST™ is a permeable curtain typically constructed of two layers of fabric that are subdivided into vertical cells or pockets. A flotation hood keeps the system afloat and maintains complete coverage through the water column. Sufficient fabric is used to accommodate water level fluctuations [Ref. 6.99]. The fabric used to create the MLEST™ panels is shown in Figure 4.17. MLESTs™ have sizing limitations and the ability to interfere with or prevent other existing uses of the source waterbody [Ref. 6.115].

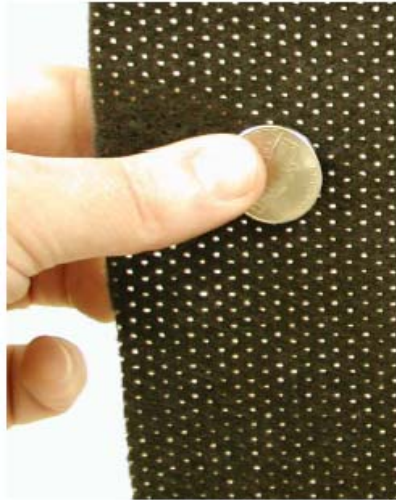

**Figure 4.17** Gunderboom® Permeable Fabric Material [Ref. 6.19]

A MLES™ is typically sized to allow a flowrate of 5 to 10 gpm/ft<sup>2</sup>. Loads on the curtain fabric are reduced by maintaining low through-curtain flow rates; however, low through-curtain flow rates increase the size of the MLES™ required. Conversely, high through-curtain flow rates decrease the size of the MLES™ required, but increase the possibility of curtain failure due to debris loading.

The MLES™ utilizes AirBurst™ systems to routinely remove deposits on the fabric panels. The AirBurst™ system consists of tubing woven into the bottom of each Gunderboom® panel that releases compressed air to dislodge debris attached to the panels. Where available, a sweeping velocity in a waterway can carry dislodged debris away from the MLES™. Laboratory tests conducted by EPRI concluded that the AirBurst™ system effectively cleaned various AFB configurations in one to three cleaning cycles under certain circumstances [Ref. 6.19].

According to the EPA's Technical Development Document for the Final Section 316(b) Phase II Rule, AFBs are "experimental in nature," and Lovett Generating Station (a coal-fired plant) was the only power plant facility where an AFB has been used at a full scale level [Ref. 6.115]. A MLES™ was deployed from 2004 through 2008 at Units 3, 4, and 5 of Lovett Generating Station, a now retired power plant located approximately 1.5 miles southwest of IPEC on the western shoreline of the Hudson River in Stony Point, NY. Units 3, 4, and 5 of Lovett Generating Station had a combined condenser cooling water intake rate of approximately 323,000 gpm (465 MGD) [Ref. 6.99]. Field and laboratory studies conducted from 1995 through 2001 were performed to develop and evaluate a MLES™ at Lovett Generating Station, prior to installation of a fully operational MLES™ in 2004 [Ref. 6.72; Ref. 6.73; Ref. 6.74]. Significant conclusions from these studies included:

- Anchoring systems for the MLES™ must be properly engineered through bathymetric and geophysical studies of the waterway to prevent detachment of the anchors caused by debris loading on the MLES™ fabric [Ref. 6.72].

- Perforation size in the MLES™ fabric is site specific and is driven by biological exclusion requirements, waterbody characteristics, and flow requirements [Ref. 6.19; Ref. 6.72].
- AirBurst™ systems must be utilized to remove debris and sediment buildup on the face of the MLES™ fabric. Frequency of airburst operation is site specific depending on debris loading characteristics. Inadequate removal of debris from the MLES™ results in submergence or overtopping of flotation billets [Ref. 6.73].
- Fabrication of the MLES™ curtain needs to conform precisely to the maximum water depths along the deployment transect to ensure effective cleaning and limit the potential for biofouling growth [Ref. 6.74].
- Flow rates through the MLES™ curtain should be between 5 and 10 gpm/ft<sup>2</sup>. Laboratory tests conducted in 1997 indicated that curtain fabrics tested at flow rates of approximately 5 gpm/ft<sup>2</sup> clogged slowly, but recovered well after cleaning. Curtain fabrics tested at flow rates of approximately 10 gpm/ft<sup>2</sup> clogged faster and the recovery rate after clogging was acceptable, but not as good as with flow rates of approximately 5 gpm/ft<sup>2</sup>. Curtain fabrics tested with flow rates in the range of 15 gpm/ft<sup>2</sup> clogged rapidly with poor flow rate recovery after cleaning [Ref. 6.73].

As noted in Attachment 6, the MLES™ at Lovett Generating Station had a 79% overall average exclusion effectiveness. According to Attachment 6, this effectiveness, and the absence of size selectivity, both suggest that performance of the MLES™ at Lovett Generating Station was directly related to its time of deployment with respect to the Hudson River fish spawning season, the proportion of the total intake flow drawn directly through the filtration mesh, and the density of ichthyoplankton in the volume of unfiltered water drawn into the intake when deployment fails. In addition, post-deployment inspections at Lovett Generating Station identified tears in the flotation billet collars, due to extensive flexing caused by tidal oscillations and tears in the MLES™ curtain fabric near airburst diffusers caused by entanglement with anchor lines or other structures [Ref. 6.74]. IPEC is located on the Hudson River approximately 1.5 miles from Lovett Generating Station and, as discussed in Attachment 6, both Lovett Generating Station and IPEC are exposed to the same source water body population of ichthyoplankton during the same seasonal cycle and are likely to experience similar entrainment through an MLES™. However, the MLES™ at Lovett Generating Station varied in depth from 20 to 35 ft deep, while an MLES™ at IPEC would have an average depth of approximately 50 ft. Therefore, it is the increased depth and associated stresses at IPEC would likely increase the occurrence and severity of tears in the flotation billet collars or the MLES™ curtain fabric, anchorage issues, and fouling/over-topping events.

Individual MLESs™ for IPEC Units 2 and 3 were conceptualized using the upper limit of the recommended flow range, 10 gpm/ft<sup>2</sup>, and the midpoint of the recommended flow range, 7.5 gpm/ft<sup>2</sup>. Individual MLESs™ using the lower limit of the recommended flow range, 5 gpm/ft<sup>2</sup>, were not considered, because the dimensions of the MLESs™ required would extend outside of IPEC's existing exclusion zone, further limiting navigability of the River. Using the upper limit of the recommended through-curtain flow rates to



conceptualize MLESs™ at Units 2 and 3 illustrates the minimum MLES™ dimensions required, while using the midpoint of the recommended through-curtain flow illustrates more conservative dimensions of MLESs™. It is not likely that any MLES™ at the Stations would be designed using the upper limit of the recommended through-curtain flow rates, because some margin of increased filtration area would be desired to ensure reliable operation of the system during periods of heavy debris loads. A site-specific study at the Stations would be required to determine this margin.

The required square footage of the curtain fabric and overall length of the conceptual MLES™ for each of these flow rates are shown in Table 4.5 and assume an average submerged depth of 50 ft. Water depths in the vicinity of the Stations' CWISs range from approximately 12 ft to 80 ft [Ref. 6.80]. Assuming an average submerged depth of 50 ft is conservative, because a greater average submerged depth reduces the required length of the conceptual MLESs™.

**Table 4.5 Conceptual MLES™ Areas and Lengths**

Design Parameter	Unit 2		Unit 3	
CWIS Flow Rate (gpm)	870,000		876,000	
Through-Curtain Flow Rate (gpm/ft <sup>2</sup> )	7.5	10	7.5	10
Curtain Fabric Area (ft <sup>2</sup> )	116,000	87,000	116,800	87,600
Overall length of MLES™ (ft)	2,320	1,740	2,340	1,750

As shown in Attachment 2, Figures 2-7 and 2-8, the shoreline endpoints for a conceptual MLES™ at each Unit were selected to avoid interferences with existing structures (i.e., the condensate polishing building and Unit 1 wharf) and to remain within the boundaries of the existing exclusion zone. Additionally, the southern endpoint of the conceptual MLES™ for Unit 3 was placed away from the southern end of the discharge canal to avoid recirculation of debris in the discharge cooling water.

A combined MLES™ enclosing the CWISs for Units 2 and 3 would also include the CWIS for Unit 1. In order to filter the combined flowrate of 1,762,000 gpm, an AFB with an overall length of approximately 3525 ft would be required based on the upper limit of the recommended flow rate through the curtain fabric of 10 gpm/ft<sup>2</sup> and an average submerged depth of 50 ft. This conceptual combined MLES™ for Units 2 and 3 would extend approximately 900 ft into the Hudson River based on a shoreline distance of approximately 1800 ft and would occupy nearly all of the exclusion zone. A combined MLES™ enclosing the CWISs of Units 1, 2, and 3 with a through-curtain flow rate at the midpoint of the recommended flow rate of 7.5 gpm/ft<sup>2</sup> would require an overall length of approximately 4700 ft, assuming an average submerged depth of 50 ft, and would not fit into the existing exclusion zone. The dimensions of a combined MLES™ are larger than the dimensions of the individual MLESs™ and a combined MLES™ likely to be installed (through-curtain flow rate of 7.5 gpm/ft<sup>2</sup>) would not fit in the existing exclusion zone. Additionally, a combined MLES™ would preclude the use of the Unit 1 wharf that is required for nautical plant security responses. Thus, a single combined MLES™ for both Units would provide no additional benefits to the individual MLESs™ for Units 2 and 3 shown in Attachment 2, and is not further considered as an alternative to the existing intake screening systems.

Actual design and installation of an AFB at the Stations would require extensive biological, geotechnical, and field studies to determine the optimum curtain size, perforation size, anchoring system, airburst operation schedule, and maintenance schedule. As noted by EPRI in its laboratory study, the potential biological effectiveness of an AFB is related to the ability of the curtain material to be maintained in position with adequate control of debris [Ref. 6.19]. Site-specific developmental studies would be required at IPEC, similar to those performed at Lovett Generating Station between 1995 and 2001, to achieve the requisite level of certainty. Furthermore, MLESs™ are susceptible to damage and clogging due to ice formation on the curtain fabric during the winter months [Ref. 6.94]. As such, the use of any MLES™ installed would be limited to seasonal deployment, because mechanisms do not currently exist to heat the curtain fabric or otherwise prevent damage due to icing. Because IPEC is located on the shore of the Hudson River, any potential MLES™ would be situated in the main channel of the waterway exposing it to large floating or submerged debris that could cause tearing, entanglement, or overtopping of the MLES™. The potential for failure or extensive damage to the MLES™ curtain fabric due to large debris would also have to be evaluated prior to implementation.

An extensive anchoring system is required to secure the curtain fabric in place and to ensure that unfiltered water does not enter the intake area below the curtain fabric. The MLES™ installed at Lovett Generating Station had a length of approximately 1500 ft and was secured in place by 123 concrete anchors [Ref. 6.3]. Each concrete anchor was 6 ft long, 3 ft wide, and 3 ft tall (54 cubic feet) [Ref. 6.73]. The concrete anchor volume corresponds to an approximate weight of 8100 pounds per anchor. The combined length of the conceptual MLESs™ at Units 2 and 3 with a through-curtain flow rate of 10 gpm/ft<sup>2</sup> would be approximately 3525 ft. Scaling from the Lovett Generating Station system, at least 287 concrete anchors would be required at IPEC to secure the curtain fabric to the floor of the Hudson River.

The primary concern with installation of an AFB is the potential for the curtain fabric to detach from its anchors and block the CWIS. The conceptual MLES™ configurations shown in Attachment 2 Figures 2-7 and 2-8 would enclose the safety-related SW intake channels. Detachment of the MLES™ curtain fabric from its anchors could allow the curtain fabric to be drawn into the CWIS, potentially clogging the SW intake channels and cutting off the SW supply required for safe shutdown of the plant. In order for a MLES™ to be considered for deployment at a nuclear power plant, extensive testing and qualification of the MLES™ materials, specifically the attachments to the anchorages, would be required prior to the completion of a comprehensive failure modes and effects analysis (FMEA). Following this analysis, the NRC would require the submittal of a License Amendment Request (LAR) detailing the changes from the existing plant configuration and analysis and indicating that the ability of the plant to achieve safe shutdown would not be negatively affected by implementation of the MLES™. Approval of the LAR by the NRC would be required prior to implementation of the MLES™. It is not likely that the NRC would approve a LAR of this type, because both NRC requirements and the Institute of Nuclear Power Operations (INPO) guidelines prohibit screen systems that may compromise the ultimate heat sink or otherwise impair water-based nuclear safety-related systems [Ref. 6.67].

Units 2 and 3 each have backup sources of cooling water flow for the SW systems that could provide SW to each Unit in the event of a blockage of the SW intake channels caused by a detached MLES<sup>TM</sup>. The Unit 1 RW pump can provide cooling water flow to the Unit 2 SW system via crossover piping and Unit 3 is equipped with three 5000 gpm backup SW pumps that take suction from the Unit 2 discharge canal. Extensive analysis of the suitability of each of these backup pumps would be required prior to the implementation of MLESs<sup>TM</sup>, because the backup pumps are not qualified for safety-related operation, and only two of the three Unit 3 backup SW pumps can currently be powered by the emergency diesel power generators [Ref. 6.64]. It is possible that the conceptual MLESs<sup>TM</sup> at Unit 2 shown in Attachment 2 Figures 2-7 and 2-8 could fail in a manner that would block the intake structures of both Units 1 and 2, precluding flow from the Unit 1 RW pump and Unit 2 SW pumps. Based on this scenario, the potential installation of new backup SW pumps in the Unit 2 discharge canal that could provide emergency cooling water flow for the SW system of Unit 2 would need to be determined prior to the implementation of MLESs<sup>TM</sup> at IPEC. Any redesign of the SW system to avoid or mitigate any new failure modes associated with the implementation of an MLES<sup>TM</sup> at either Unit would also affect the licensing basis and would require a License Amendment, as discussed previously.

#### Maintenance

MLESs<sup>TM</sup> are passive barrier systems with few mechanical components; thus, periodic inspection and cleaning would entail the majority of the maintenance scope. However, MLESs<sup>TM</sup> would require seasonal installation, retrieval, and subsequent repair to the curtain fabric adding to the overall maintenance cost. As noted previously, at Lovett Generating Station, tears in the flotation billet collars due to extensive flexing caused by tidal oscillations and tears in the MLES<sup>TM</sup> curtain fabric near airburst diffusers caused by entanglement with anchor lines or other structures were identified during post-deployment inspections [Ref. 6.74]. The small apparent opening size of the curtain fabric material required to physically exclude eggs and larvae also retains higher debris loads and dictates that the MLESs<sup>TM</sup> be inspected in frequent intervals. When MLESs<sup>TM</sup> are initially installed they should be inspected on a quarterly basis for the first 12 to 15 months of operation to monitor fouling/growth. The conditions of MLESs<sup>TM</sup> should be well documented so that fouling/growth can be closely monitored. Once the rate of fouling has been established, the inspection frequency may be altered to coincide with the fouling rate.

The evaluated AFBs / MLESs<sup>TM</sup> would have several operations and maintenance (O&M) requirements as detailed below:

- Check air cleaning systems via boat
- Clean MLESs<sup>TM</sup> using power wash system via boat deployment
- Annual deployment of MLESs<sup>TM</sup>
- Annual retrieval of MLESs<sup>TM</sup>
- Inspect MLESs<sup>TM</sup> while deployed in River
- Repair MLESs<sup>TM</sup> after removal from River

The O&M estimates for the MLESs™ are in addition to the present O&M requirements for the existing TWSs that would operate when the MLESs™ were not deployed. When debris accumulates on the MLESs™ fabric, the MLESs™ would be cleaned with an AirBurst™ system. The frequency of cleaning would need to be determined by operations after installation in order to account for conditions specific to the Hudson River.

Operations personnel would likely perform O&M activities associated with maintenance of the AirBurst™ systems and cleaning of the MLES™; however, deployment and retrieval of the MLESs™, underwater inspection of the MLESs™, and repair of the MLESs™ would likely be performed by teams of divers and specialists contracted through Gunderboom®. The minimum annual O&M cost for the evaluated MLESs™ is estimated to be approximately \$3,000,000.

Additionally, parasitic power losses would exist due to the operation of air compressor motors for the AirBurst™ systems. The estimated power requirements are based on six 200 hp motors operating 4 hours per day for 24 weeks. The 24 week estimate of the operational period of the AirBurst™ system motors is a conservative estimate of the time period that MLESs™ could be deployed without being significantly affected by icing or fouling and corresponds to the months of May through October. Based on these assumptions, the additional parasitic losses associated with operation of the air compressor motors for the airburst systems would be approximately 601 MW-hr per year.

#### Cost

The capital cost estimates for implementation of the evaluated MLESs™ are detailed in Attachment 4 and include design, procurement, implementation, and startup activities, based on the conceptual design shown in Attachment 2 Figure 2-8. The costs associated with permitting the MLESs™ are not included in this estimate. As shown in Attachment 4, the total estimated capital cost for MLESs™ at the Stations would be approximately \$67.4 million. In order to avoid interfering with normal operations, the installation of the anchoring systems for the MLESs™ would be recommended, but not required, to coincide with scheduled outages. As noted previously, the O&M and seasonal deployment, removal, and repair of the MLESs™ would cost, at a minimum, approximately \$3 million annually, not including the O&M costs for the existing CWISs.

#### I&E Discussion

Attachment 6 (Tables 17 and 23 of Appendix A) provides the estimated reductions from the regulatory baseline in EA1 I&E that could be achieved through the seasonal use of MLESs™ accounting for the Stations' survival rates (Attachment 6) and average historic flow reductions (Section 2.4.2.3.2). A summary of the information included in the tables is shown in Table 4.6. Note that the maximum possible reductions in EA1 I&E shown in Table 4.6 (90.4% and 90.2%, respectively) are substantially higher than the current EA1 I&E reductions (80.2% and 33.8%, respectively) shown in Section 3.2.

**Table 4.6 Potential Reduction in EA1 I&E due to the Installation of MLESs™**

Month	EA1 Entrainment Loss Reduction	EA1 Impingement Loss Reduction
January	0.0%	8.7%
February	0.0%	9.6%
March	0.0%	12.0%
April	0.4%	6.6%
May	9.9%	9.5%
June	30.2%	11.7%
July	25.1%	5.3%
August	13.8%	5.5%
September	6.0%	5.7%
October	4.8%	4.9%
November	0.0%	4.6%
December	0.0%	6.3%
Annual	90.2%	90.4%

Note: In order to avoid the months in which MLESs™ would be significantly affected by icing or fouling, the MLESs™ would be deployed seasonally from May through October. Therefore, the reductions presented for the months of November through April (shaded cells) indicate the reductions due to the existing TWSs and fish return systems.

### Conclusions

Although MLESs™ have the potential to reduce I&E, there are several operational issues (i.e., fouling and icing concerns) that could prohibit the operation of the AFBs throughout the year. Implementation of MLESs™ at the Stations would present significant nuclear safety and licensing issues (including possible License Amendments) that would need to be resolved prior to permitting of the AFBs. Consistent with the aforementioned conclusion, AFBs are not currently installed, nor have ever been licensed or installed in front of a service water intake at a nuclear facility. In addition, the actual design and installation of an AFB at the Stations would require extensive biological, geotechnical, and field studies to determine the optimum curtain size, perforation size, anchoring system, airburst operation schedule, and maintenance schedule.

#### **4.4.2 Fish Barrier Nets**

Fish barrier nets are not considered as viable alternatives to the current screening systems at Units 2 and 3 due to nuclear-safety related issues and the lack of comparable reductions in I&E to the NYSDEC Proposed Project or other alternative technologies. In addition, fish barrier nets have not been successfully implemented for protection of eggs or larvae and, therefore, would not be expected to provide significant reductions in entrainment

Fish barrier nets are coarse-mesh nets that are installed in front of the entrance to an intake structure primarily to reduce impingement of fish [Ref. 6.2; Ref. 6.16]. The size of the mesh openings limits the size of the organisms that can pass through the net. Although

finer meshes can be used to reduce entrainment of smaller species and juvenile fish, the larger mesh sizes are generally required to maintain low through-screen velocities (usually at or below 0.5 fps) and avoid excessive clogging [Ref. 6.2; Ref. 6.16]. Barrier nets with mesh fine enough to prevent entrainment of eggs and larvae have not been successfully deployed due to the challenges of keeping the mesh clean of silt and biofouling [Ref. 6.16]. Therefore, fish barrier nets are not considered an effective technology for reducing entrainment of eggs, larvae, or zooplankton [Ref. 6.2; Ref. 6.16].

Cooling water is drawn through the openings in the mesh before entering the plant intake. Several installation designs have been developed to accommodate a range of operating conditions. The rigid panel support system shown in Figure 4.18 is typical for large installations with high debris loading and/or biofouling and high ambient velocity conditions on large estuaries, such as at the Hudson River in front of the Stations [Ref. 6.16].

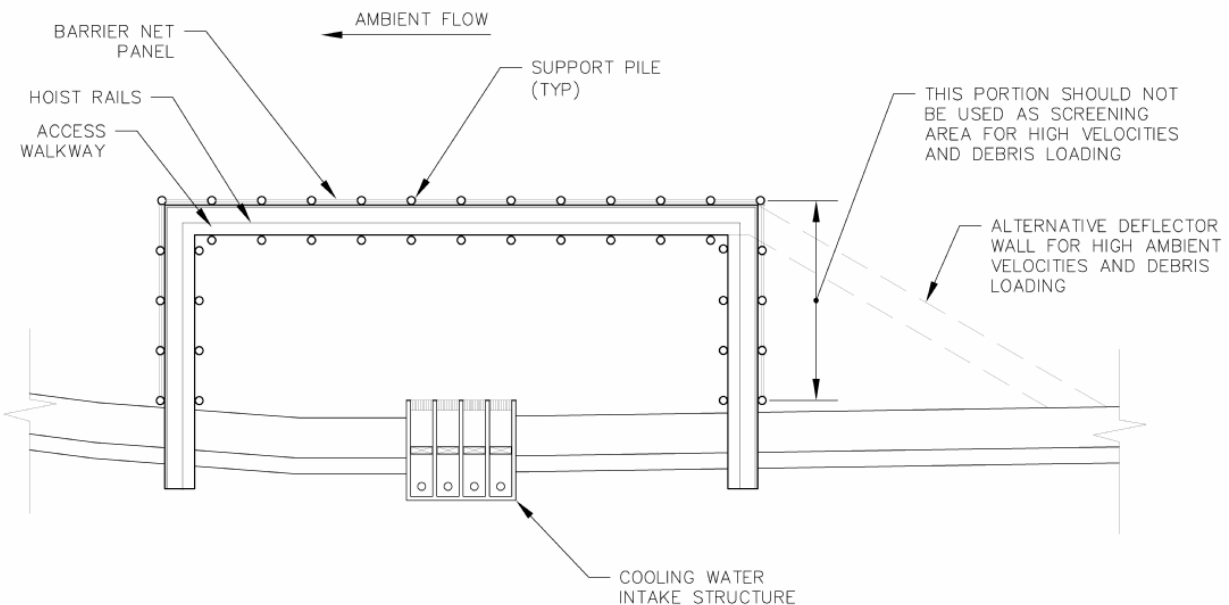

**Figure 4.18 Fixed Panel Standard Design Plan [Ref. 6.16]**

In a rigid net panel design, the net is supported by steel piles, sheet pile cells, and sheet pile isolation walls, as shown in Figure 4.19. A walkway deck typically spans the length of the net to facilitate cleaning and maintenance. Individual net panels are hoisted to the walkway level for cleaning with power sprays and brushes. Uninterrupted fish protection can be provided by using spare net panels lowered into place during cleaning.

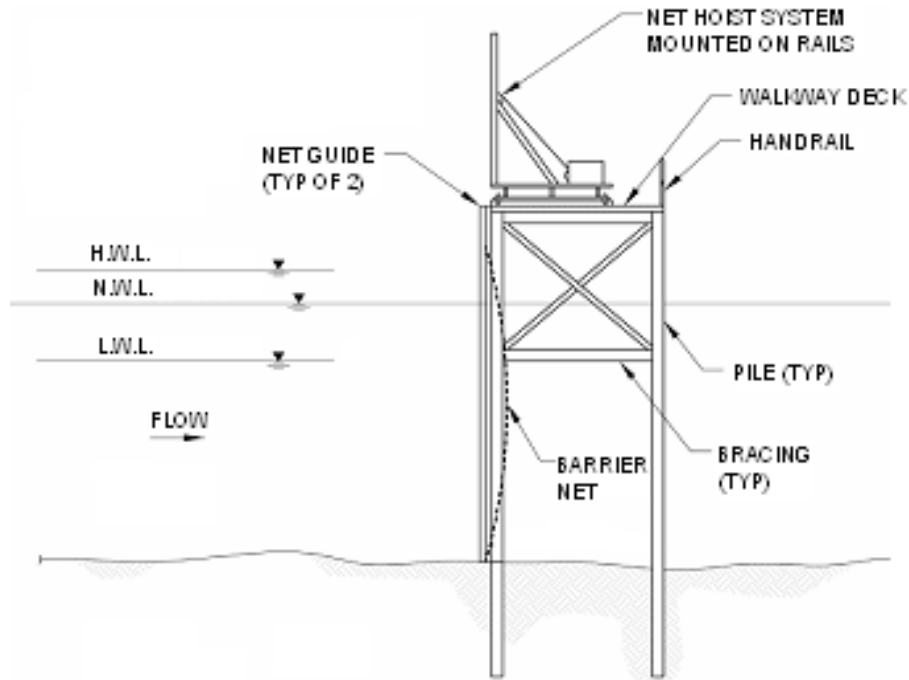

**Figure 4.19 Rigid Panel Support Design [Ref. 6.16]**

Fish barrier nets have been deployed at several large power plants. The mesh sizes (measured by the length of one of the four sides of the net opening) for these installations have ranged from  $\frac{1}{10}$  to 1- $\frac{1}{4}$  inch [Ref. 6.16]. Typical barrier net mesh sizes are  $\frac{1}{4}$ -,  $\frac{3}{8}$ -, and  $\frac{1}{2}$ -inch. As discussed in Section 2.4.1.1, the existing traveling water screens at the Stations have a mesh size of  $\frac{1}{4}$ -inch wide by  $\frac{1}{2}$ -inch tall.

Failure of a fish barrier net could present serious operational and, where applicable, nuclear safety concerns. At Detroit Edison's Monroe Plant, a fish barrier net placed across the intake canal clogged with fish and collapsed. The net failure was attributed to high intake velocities greater than 1.3 fps [Ref. 6.2]. A fish barrier net is deployed seasonally to reduce impingement at Arkansas Nuclear One (ANO), owned and operated by Entergy Arkansas, Inc. [Ref. 6.16]. The fish barrier net at ANO is installed outside an intake canal in the Lake Dardanelle reservoir and is deployed in the winter. The net material is nylon with mesh sizes of  $\frac{3}{8}$  and  $\frac{1}{2}$  inch and through-net velocities of approximately 0.04 ft/s. At ANO, emergency SW is supplied by an emergency cooling pond through a channel separate from the circulating water intake, eliminating this safety concern [Ref. 6.23].

A fish barrier net at the Stations would be designed for lower velocities than Detroit Edison's Monroe Plant, but excessive fouling and/or River flow variability at the site could cause a similar failure. As described in Section 2.4.1, the SW pump channel for each Unit has three CW pump channels located on each side. Collapse of a fish barrier net installed in front of the CW pump channels could clog the SW intake channels, cutting off the SW supply required for safe shutdown of each Unit. Both NRC requirements and INPO guidelines prohibit screen systems that could compromise the ultimate heat sink or otherwise impair water-based nuclear safety-related systems [Ref. 6.67]. Based on this

nuclear-safety related issue, the installation of a single barrier net spanning both intakes or one barrier net at each CWIS is not considered a technologically feasible means of reducing I&E. Placement of four smaller nets for each set of three CW pumps on either side of the SW channels could be possible, although the potential for net failure to affect SW pump operation could still exist. The addition of a new failure mode for the SW system would affect the licensing basis of the plant and would therefore require a License Amendment. Similarly, a redesign of the SW system to avoid or mitigate new failure modes would also affect the licensing basis of the plant and would require a License Amendment.

#### I&E Discussion

As noted in Section 3.2, the Stations' existing TWSs screens and fish return systems already provide state-of-the-art impingement protection. Therefore, it is not expected that implementation of fish barrier nets would be able to provide significant reductions in impingement. In addition, fish barrier nets have not been successfully implemented for protection of eggs or larvae and, therefore, would not be expected to provide significant reductions in entrainment [Ref. 6.2].

#### Conclusions

In addition to the nuclear-safety related issues associated with the installation of fish barrier nets at the Stations, fish barrier nets have not been successfully implemented for protection of eggs or larvae and, therefore, would not be expected to provide significant reductions in entrainment [Ref. 6.2]. There would be a potential for some additional impingement reductions with the implementation of fish barrier nets; however, due to the lack of significant entrainment reductions and the nuclear-safety related issues, fish barrier nets are not further considered as alternatives to the current intake screening systems.

### **4.4.3 Behavioral Barriers**

None of the behavioral barriers evaluated (light guidance systems, acoustic deterrents, air bubble curtains, or electrical barriers) are considered as viable alternatives to the current screening systems at the Stations because these technologies would not be expected to provide comparable reductions in I&E to the NYSDEC Proposed Project or other alternative technologies. Because eggs and larvae cannot respond to the stimuli created by behavioral barrier systems, there would be no direct reduction in entrainment. Additional site-specific studies would be required to fully evaluate the effectiveness of any behavioral barrier systems at the Stations.

Behavioral barriers deter fish from entering CWISs by utilizing their natural behavioral responses to external stimuli. In general, studies of behavioral barriers have been inconclusive or have shown no significant reduction in I&E across species [Ref. 6.2], but such systems have proved effective for certain species, because behavioral barrier performance is highly dependent on the CWIS site characteristics and fish species present [Ref. 6.2]. Consequently, there are multiple acoustic fish deterrence systems operating at power generation facilities, including the NYSDEC-authorized system at the James A. FitzPatrick Nuclear Power Plant. Therefore, the biological benefit provided by a specific behavioral barrier technology cannot be fully evaluated without conducting extensive field



and biological studies at IPEC to characterize the site conditions and the response of the fish species present.

#### **4.4.3.1 Light Guidance System**

Light guidance systems are not considered as viable alternatives to the current screening systems at the Stations because they are not expected to provide reductions in I&E comparable to the NYSDEC Proposed Project or other alternative technologies.

Light guidance systems most commonly use xenon strobe lights or mercury lights to attract or repel fish. Mercury lights are typically used to attract fish; therefore, there have been very few studies performed in the application of mercury lights for avoidance purposes. Xenon strobe lights have been proven to be more effective at repelling fish than a continuous light and are the primary light guidance technology [Ref. 6.15]. In order to evaluate the behavioral response of a fish to light, three key factors must be considered: (1) fish species, (2) developmental stage of the fish, and (3) the level of adaptation [Ref. 6.28]. These factors have led to large variations in fish response to light. Low intensity light attracts certain fish species but repels others and high intensity light has shown the same pattern [Ref. 6.2]. Some species have shown no response to any type of light stimuli. Studies have shown inconsistency in the use of xenon strobe lights to reduce fish impingement and entrainment in CWISs [Ref. 6.15].

An investigation into the effectiveness of light deterrents using the Fish Avoidance Xenon System (FAXS) supplied by EG&G Electro-Optics was conducted at Roseton Generating Station on the lower Hudson River in 1986 and 1987 [Ref. 6.17]. The strobe light source was provided by a FA-125 power supply in conjunction with a FA-107 flash head. FAXS has multiple power settings which can be calibrated to provide the greatest fish deterrence. The lowest setting results in a 750 candela (cd) light output that can operate at a flash rate between 100 flashes per minute (fpm) to 600 fpm. The highest power setting results in a 4500 cd light output that can operate at a flash rate between 100 fpm to 400 fpm. FAXS provided the greatest fish avoidance when operated at a light intensity of 4500 cd and a flash rate of 200 fpm. The investigation concluded that the effectiveness of light deterrents is highly dependent on the species and time of the day [Ref. 6.17]. Results of the investigation showed that FAXS successfully deterred white perch, but was unsuccessful at deterring alewife, American shad, blueback herring, and bay anchovy. Increases in turbidity led to increases in fish avoidance due to more scattering of light [Ref. 6.17].

Flash Technology Corporation (FTC) designed a light guidance system that succeeded the EG&G's FAXS. FTC's system, specifically designed for underwater use, was the mostly commonly used light guidance technology between 1997 and 2004 [Ref. 6.15]. Although FTC's light guidance system is no longer in production [Ref. 6.30], the FTC strobe lights were capable of operating at depths of up to 80 meters and consisted of flash heads, wiring, power supplies, and a control system. Experimental results of FTC's system showed inconsistencies similar to those identified with FAXS.

### Conclusions

Many of the species present in the vicinity of Roseton Generating Station are present at the IPEC Unit 2 and 3 CWISs. However, species are only one relevant factor in effectiveness; the different locations of the Roseton and IPEC Unit 2 and 3 CWISs on the Hudson River could cause significant variations in the diversion effectiveness of a light guidance system. Therefore, site specific studies would be required to fully evaluate the diversion effectiveness of a light guidance system. As such, light guidance systems are anticipated to provide inconsistent reductions in impingement. Moreover, eggs and larvae cannot respond to the stimuli created by light guidance systems there would be no direct reduction in entrainment. For these reasons, light guidance systems are not expected to provide significant reductions in I&E and are not further considered as alternatives to the current CWIS technologies.

#### **4.4.3.2 Acoustic Deterrents**

Acoustic deterrents are not considered as viable alternatives to the current screening systems at the Stations because they are not expected to provide reductions in I&E comparable to the NYSDEC Proposed Project or other alternative technologies.

Acoustic deterrents divert fish from CWISs by creating underwater sound waves that trigger an avoidance response. Fish have shown sudden bursts of speed and direction changes in response to certain sound frequencies and sound pressure levels [Ref. 6.28]. Sound waves can attract or repel fish from the acoustic source, and the behavioral response of a fish to a given frequency is dependent on various factors, including species and size [Ref. 6.28].

A study evaluating the effectiveness of acoustic deterrents called pneumatic poppers or “air poppers” was conducted at the Stations from July 20, 1985 to December 29, 1985 [Ref. 6.79]. The IPEC study was modeled after a similar study performed by Ontario Hydro that showed success in deterring yellow perch and alewife from the CWIS. As part of the study, four air poppers were installed around one of the Unit 2 intake channels. Air poppers release pressurized air into water to create a low frequency, high amplitude sound wave. Air pressurized to 3000 psig was released at 5 second intervals from the air poppers. The air poppers were active for 48 or 72 hour periods, followed by 48 hour periods of inactivity. The results of IPEC’s study showed that the air poppers had no significant impact on the numbers or species of fish in the vicinity of the intake or impinged by the CWIS [Ref. 6.79].

Acoustic deterrents were specifically evaluated for striped bass, white perch, and tomcod at the Stations [Ref. 6.21], leading to the development and testing of the Sonalysts, Inc. FishStartle™ system at the James A. FitzPatrick (JAF) Nuclear Power Plant. The FishStartle™ system is currently in operation at JAF and is similar to the SPA system (discussed below) in that it is capable at operating at a range of frequencies. At JAF, the FishStartle™ system was shown to substantially reduce the fish density in the vicinity of the intake when compared to the periods when the FishStartle™ system was not operating [Ref. 6.10]. However, because the site-specific feasibility of any acoustic deterrent system is highly dependent on the impinged species and their contribution to historical impingement, as well as their response to sound, and the engineering

constraints associated with the aquatic environment, extensive further study would be required to ascertain the biological benefits at IPEC Units 2 and 3.

Other hydroacoustic technology has been more successful at deterring fish from CWISs than air poppers. Fish Guidance Systems, Inc. has developed the Sound Projector Array (SPA) System that creates patterns of wave forms with a range of frequencies and sound pressure levels. The SPA System utilizes signal generators to send recorded signals through amplifiers that power underwater sound projectors. An acoustic modeling program called PrISM determines the number, location, and orientation of the sound projectors. PrISM predicts the particle movement field and accounts for important factors, such as the geometry of the intake, reflections, and potential destructive interference [Ref. 6.29]. The signal generators can produce multiple signals to reduce the chance of fish adaption to the sound. Nuclear Plant Doel (NPD), located on the Scheldt Estuary in Belgium, has conducted a study of the SPA System [Ref. 6.78]. The SPA system at NPD utilized a signal generator programmed with eight different signals connected to twenty 600 watt sound projectors. The sound was emitted in intervals of 0.2 seconds and ranged in frequency from 20 Hz to 600 Hz at a sound pressure level of 174 dB. The study also evaluated the effects of temperature and salinity changes in combination with the acoustic deterrents. Results of the study showed a reduction in total fish impingement of 59.6%. Reductions in the numbers of impinged gobies accounted for 78% of the total impingement reduction [Ref. 6.78]. Other species that showed significant reductions in impingement were herring, sprat, white bream, smelt, bass, perch, sole, and flounder. The reduction in herring impingement averaged 94.7% [Ref. 6.78]. The study also determined that changes in temperature and salinity can lead to changes in the acoustic field generated by the SPA system; however, these changes were found to be insignificant [Ref. 6.78]. These SPA system results are extremely site- and species-specific and are not necessarily representative of the reductions that would be expected at the Stations.

### Conclusions

Acoustic deterrent systems have been proven effective for certain sites with specific fish species. However, potential effectiveness of an acoustic deterrent system is highly species-specific [Ref. 6.2]. As such, site-specific studies would be required to fully evaluate the effectiveness of any acoustic deterrent system at the Stations. In addition, because eggs and larvae cannot respond to the stimuli created by acoustic deterrent systems there would be no direct reduction in entrainment. For these reasons, acoustic deterrent systems are not expected to provide significant biological benefits and are not further considered as alternatives to the current CWIS technologies.

#### **4.4.3.3 Air Bubble Curtains**

Air bubble curtains are not considered as viable alternatives to the current screening systems at the Stations because they were previously used at the Stations and were determined to be ineffective.

Air bubble curtains are designed primarily to create a visual deterrent to fish, but can also stimulate auditory and physical responses [Ref. 6.18]. The air bubble curtains are created by pumping air through a diffuser hose. As shown in Figure 4.20, nozzles in the diffuser

hose release a dense “wall” of air bubbles that deter juvenile and adult fish from the CWIS.

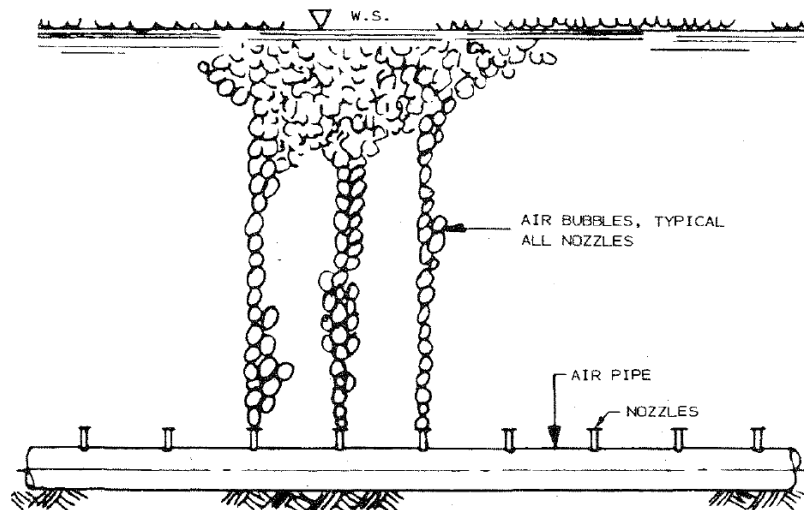

**Figure 4.20 Elevation View of Air Bubble Curtain [Ref. 6.2]**

Air bubble curtain systems were in operation for several years (late-1970’s through the mid-1980’s) at each of the Unit 1 and Unit 2 traveling water screens and one traveling water screen (TWS 36) at Unit 3, but were removed after yielding poor results [Ref. 6.15; Ref. 6.109]. The studies of the Stations’ air bubble curtain noted that the effectiveness was lower at night and during periods of high turbidity, which support the observation that fish respond to air bubbles visually and not through auditory or tactile stimuli [Ref. 6.18]. Air bubble curtain effectiveness may also be dependent on water temperature with decreased effectiveness associated with lower water temperatures [Ref. 6.108]. The air burst curtain at the Stations proved to be ineffective against white perch, striped bass, and clupeids [Ref. 6.15]. In some cases, the use of air bubble curtains increased impingement rates [Ref. 6.108].

Other field studies examining the effectiveness of air bubble curtains in reducing fish impingement at CWISs have been completed. One study on air bubble curtains was conducted in 1972 at Monroe Power Plant on Lake Erie [Ref. 6.15]. The curtains were turned on and off for seven day intervals during the study period. Results showed that the air bubble curtains were ineffective and did not reduce impingement in yellow perch, walleye, gizzard shad, drum, alewife, or smelt. Another air bubble curtain study conducted at Prairie Island Nuclear Generating Station on the Mississippi River in the 1970s showed inconsistent results [Ref. 6.15]. Small decreases in impingement of crappie and freshwater drum were observed; however, the number of impinged carp, silver chub, and white bass increased.

### Conclusions

Although dated, effectiveness studies at the Stations and elsewhere failed to establish reduced impingement in associated with air bubble curtains. Moreover, because eggs and larvae cannot respond to the stimuli created by air bubble curtains, there would be no

direct reduction in entrainment. For these reasons, air bubble curtains are not expected to provide significant biological benefits at the Stations and are not further considered as alternatives to the current CWIS technologies.

#### 4.4.3.4 Electrical Barriers

Electrical barriers deter fish by introducing electrical currents into the waterway. An electrical field is created by applying a voltage across two submerged electrodes. When fish are caught in the electrical field their behavioral response is to turn sideways to avoid the stress caused by the electrical current passing through their bodies. Orienting the electrical field parallel to the flow direction, which is generally the same as the direction fish are travelling in, results in the maximum voltage being applied to the fish (i.e., electric field lines run head-to-tail along the fish in the same direction as the flow). By turning perpendicular to the flow, fish entrained in the electrical barrier cannot continue swimming upstream and are swept away by the waterway's natural current as shown in Figure 4.21.

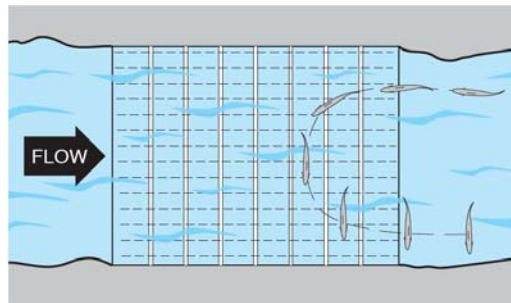

**Figure 4.21 Fish Path in a Graduated Electric Field [Ref. 6.104]**

Electrical barriers are most commonly installed to impede upstream migration of invasive fish species. However, some have been designed to deter fish from intake structures for hydropower facilities [Ref. 6.104]. There are no known permanent electrical barriers in operation at a nuclear facility's CWIS.

The electrical barriers designed by Smith-Root, Inc. for fish barrier and avoidance purposes utilize short duration direct current (DC) pulses and a graduated electrical field [Ref. 6.104]. Alternating current (AC) pulses and long, continuous pulses have proven to be more stressful to fish and are not used as a deterrent [Ref. 6.104]. The graduated electrical field consists of pulse generators providing a voltage to an electrode array on the floor of the water body as shown in Figure 4.22.

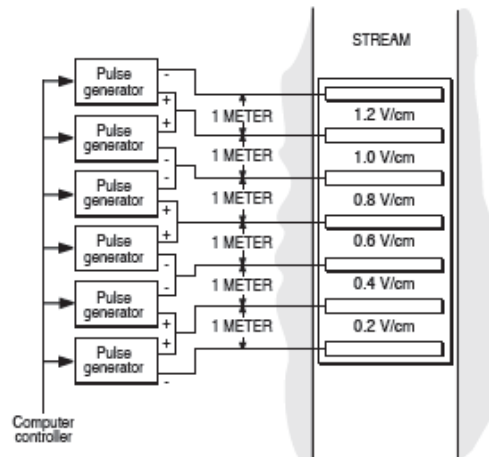

**Figure 4.22 Graduated Electrical Field Configuration [Ref. 6.119]**

The voltages of the pulse generators are set to be successively increasing, resulting in an additive effect on the electrical field's strength. Smith-Root offers output voltages of 40, 80, 120, 160, 200, and 240 V with pulse durations ranging from 0.15 milliseconds to 10 milliseconds. Voltage and pulse durations are chosen based on the specific species of fish that the barrier is aiming to exclude [Ref. 6.104].

Electrical barriers have been widely dismissed as a feasible alternative to reduce fish impingement and entrainment at CWISs due to technological reliability issues [Ref. 6.2]. Electrical field strength is highly dependent on the conductivity of the water. In estuarine applications, such as IPEC, salinity can vary greatly leading to large deviations in the conductivity of the water [Ref. 6.2]. Large variability in field strength can lead to paralysis or even mortality to the fish [Ref. 6.2]. The effectiveness of electrical barriers can also be reduced by variations in flow characteristics of the water body. If the natural flow velocity of the water body is less than the intake flow velocity, the electrical barrier can paralyze fish resulting in them being entrained in the CWIS. The Unit 2 and Unit 3 CWISs have an intake water approach velocity of approximately 1 fps at full flow and approximately 0.6 fps at reduced flow [Ref. 6.24]. Current measurement data collected offshore of IPEC during three tidal cycles showed a maximum flood velocity of 1.5 fps and maximum ebb velocity of 3.3 fps. Based on these maxima, the average flood velocity is 1.0 fps and the average ebb velocity is 2.1 fps [Ref. 6.11]. In addition, a slack tide lasts for a short period as the tide changes between flood and ebb conditions. Thus, there are periods where the average River velocity is less than the intake flow velocity at the entrance to the CWISs. Electrical barriers would likely be ineffective during these periods, and could increase impingement rates by reducing the ability of fish to travel away from the CWISs.

The sizes of the species at the Stations vary from small bay anchovy with lengths approximately 100 mm to large striped bass with lengths capable of exceeding 80 cm [Ref. 6.118]. These differences in length can greatly hinder the performance of an electrical barrier. The electrical barrier voltages are calibrated to deter a specific species type and size. A voltage suitable for deterring one species could potentially be fatal to another species due to the greater stresses caused on the species by the electrical field

[Ref. 6.2]. Conversely, a lower voltage capable of safely deterring one species could be incapable of deterring another species, allowing it to travel through the electrical barrier and possibly be entrained in the intake. In addition, the voltages introduced in the water body by electrical barriers are potential hazards for humans as well as fish [Ref. 6.104].

#### Conclusions

Design and installation of an electrical barrier at the Stations would require extensive site specific studies to determine the optimum location, size, and electrical field strength of the system. The effectiveness of electrical barrier systems is highly site-specific and dependent upon the conductivity of the water, natural flow of the waterbody, and size of the species. Based on the existing intake flow rates at the entrance to the CWISs and the average River velocities, operation of electrical barriers could increase impingement mortality. Moreover, because eggs and larvae cannot swim away from the stresses created by an electrical barrier, there would be no direct reduction in entrainment. For these reasons, electrical barriers are not expected to provide significant I&E reductions and are not further considered as alternatives to the current CWIS technologies.

#### **4.4.4 Louver System**

Louver systems are not considered as viable alternatives to the current screening systems at the Stations because they would not be expected to provide comparable reductions in I&E to the NYSDEC Proposed Project or other alternative technologies. Because eggs and larvae cannot swim away from the turbulence created by a louver system, there would be no associated reduction in entrainment. Additional site-specific biological studies would be required to produce an optimized louver system design for the Stations.

Louver systems are passive guidance barriers that typically consist of a series of evenly spaced, vertical panels aligned across the face of an intake system at an angle to the incoming flow to reduce impingement. The louver panels cause an abrupt change in the velocity and direction of the flow, creating a turbulence zone in front of the panels that fish avoid [Ref. 6.35]. Fish tend to align themselves parallel and headfirst with the incoming flow, thus coming in contact tail first with the turbulence zone. Typically, fish will move away from the turbulence zone in a direction perpendicular to the angled louvers. The net effect of this behavioral response, after repeated excursions away from the turbulence zone, is a lateral displacement of fish towards the end of the angled louvers into a bypass channel that returns fish to the source waterbody [Ref. 6.110]. A plan view of a typical louver array is shown in Figure 4.23.

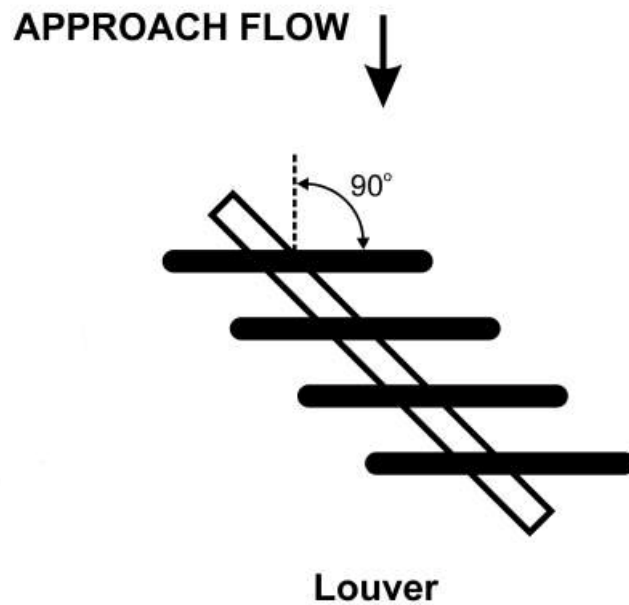

**Figure 4.23 Typical Louver Array [Ref. 6.110]**

Retrofitting louver systems upstream of the existing TWSs at the Stations would require significant civil/structural modifications. Louver arrays and a bypass channel would have to be constructed in each intake channel. The bypass channel would reduce the width of the intake channel available for flow downstream to the existing TWSs resulting in an increase in through-screen velocity and likely increase in impingement mortality.

#### I&E Discussion

Because eggs and larvae cannot swim away from the turbulence of the magnitude created by louver systems, there would be no associated reduction in entrainment [Ref. 6.107]. EPRI indicated that louver systems could provide 80-95% diversion efficiency for a wide variety of species under a range of site conditions; however, latent mortality could be a concern [Ref. 6.107]. Fish entrained in an intake channel with a louver system typically spend long periods of time swimming against the flow, just ahead of the louvers. Alden Research Laboratory (ARL) performed a series of test flume experiments where the cross-channel width of the test flume was 6 ft and the duration of the experiments ranged from 15 minutes to almost 13 hours. ARL found that the residence time of fish was often much greater than the planned duration of the experiment. In 55 of the 58 experiments conducted by ARL, fish remained swimming in the flume after the termination of the experiment. As the residence time within the intake channel increases above certain minimums, fish are more likely to suffer exhaustion and be impinged against the louver panels before reaching the bypass. The ARL study concluded that louver systems had marginal success in guiding fish into the bypass channel, as fish were more often impinged against the louvers [Ref. 6.35].

Additional studies conducted by Stone and Webster concluded that the angle of the louver system to the incoming flow ( $25^\circ$  and  $45^\circ$  in their tests) had no effect on the efficiency of the system; however, fish suffered more physical damage in tests conducted with the louvers at  $45^\circ$  than they did with the louvers at  $25^\circ$  [Ref. 6.35]. The effectiveness of



diverting fish uninjured to the bypass is more closely related to the cross-channel distance of the angled louver system than the pitch of the louvers. The cross-channel distance of a louver system is increased by 1.41 to 2.37 times the perpendicular distance in the range of 25° to 45° as shown in Figure 4.24.

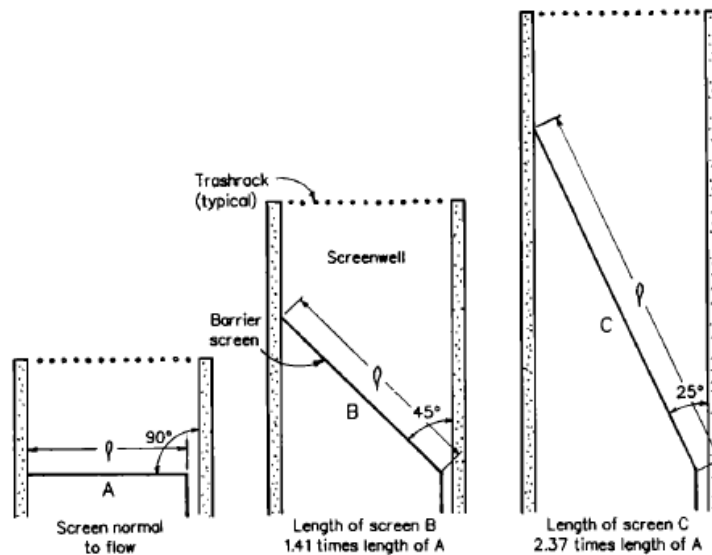

**Figure 4.24 Cross-channel Distance of Louver Systems [Ref. 6.110]**

The CW channels of Unit 2 and Unit 3 have perpendicular cross-channel distances of 13 ft 4 inches, approximately 2.2 times the distance of the ARL test flume. The approximate cross-channel distance of a louver system within a CW channel at the Stations would range between 18 ft 10 inches at 45° to 31 ft 8 in at 25°. The residence time of fish within a CW channel at IPEC equipped with a louver system is expected to be significantly greater than the residence times reported in the ARL study, thus increasing the possibility of fish impingement against the louver arrays due to exhaustion.

### Conclusions

A site-specific study would be required to produce an optimized louver system design for the Stations and determine the biological benefits of the system. However, based on the studies, louver systems would not be expected to provide any appreciable reductions in impingement at the Stations. Moreover, because eggs and larvae cannot swim away from the turbulence created by a louver system, there would be no associated reduction in entrainment. For these reasons, louver systems are not expected to provide significant reductions in I&E and are not further considered as alternatives to the current CWIS technologies.

## **4.5 Alternate Intake Location**

In order to evaluate the engineering feasibility of an offshore intake at the Stations and the potential I&E reductions associated with an offshore intake location(s), further studies of the Hudson River adjacent to each CWIS defining the density of aquatic organisms as a function of horizontal distance from the shoreline and vertical depth would be required. Despite extensive ongoing biological analysis at the Stations, no specific studies have been undertaken

to identify alternative offshore intake locations for Unit 2 or Unit 3, nor is there data suitable for that purpose. Therefore, the engineering feasibility of an offshore intake cannot be determined at this time (i.e., without first conducting a biological study establishing the optimum location of an offshore intake for Unit 2 and Unit 3).

As discussed in Section 2.4.1, the Unit 2 and Unit 3 CWISs currently draw water from the shoreline of the Hudson River through three concrete bulkheads that are subdivided into independent CW and SW intake channels. These are referred to as shoreline intake systems.

In addition to shoreline intake systems, intake systems can also be located offshore. Offshore intake systems typically draw in water through vertical inlets located offshore from the screen house and slightly above the floor of the waterbody.

Velocity caps can also be placed on top of the vertical inlets. Velocity caps are covers placed over the vertical inlets that convert vertical flow into horizontal flow. Velocity caps are sized to achieve a low intake velocity between 0.5 and 1.5 fps [Ref. 6.115]. Fish impingement is reduced through the use of velocity caps because fish tend to avoid changes in horizontal flow but are less able to detect and avoid changes in vertical flow. However, velocity caps provide no significant reduction in entrainment of larvae or eggs [Ref. 6.115]. As shown in Figure 4.25, a velocity cap reduces the approach velocities, and converts vertical flow into horizontal flow at the entrance of the intake [Ref. 6.26].

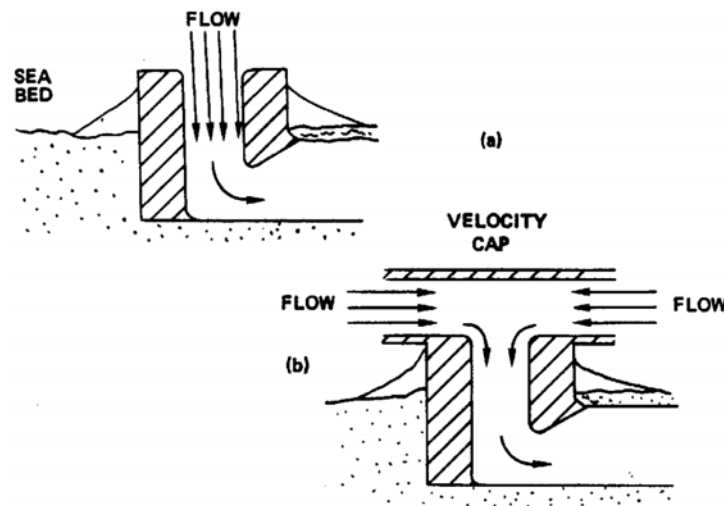

**Figure 4.25 Typical Velocity Cap Flow Direction**

Locations of offshore intakes, where feasible, are determined by various site-specific factors. Extensive studies generally are conducted to determine the optimum offshore location of the vertical inlets to minimize I&E. In estuaries, species distribution and abundance are determined by a number of physical and chemical attributes including geographic location, salinity, temperature, oxygen level, currents, and substrate. These factors, along with the degree of vertical and horizontal mixing in the estuary, dictate the spatial distribution and movement of organisms [Ref. 6.115].

An alternative offshore intake location would require significant modifications to the CWISs, including potential significant modifications to the River bed directly adjacent to the CWISs. In order to connect the velocity cap(s) to the intake channels of the existing CWISs, a large

diameter intake tunnel would need to be constructed below the floor of the Hudson River. The design, location, and depth of an offshore intake would be dependent on technological limitations and potential biological benefits.

JAF is located on the southeastern shore of Lake Ontario. The CWIS at JAF consists of an offshore submerged velocity cap that feeds an underground D-shaped tunnel running beneath the lake bed to an in-shore screenwell building that contains the majority of supporting intake equipment. Three 120,000 gpm circulating water intake pumps and three 18,000 gpm service water pumps (two are required for normal operation) draw water through the offshore intake into the in-shore screenwell building. The offshore intake is located over 900 ft from the shoreline of Lake Ontario in approximately 25 ft of water. The offshore intake has four segmented shore-facing openings that feed a D-shaped intake tunnel that runs beneath the lake bed approximately 1150 ft to the in-shore screenwell building. Attached to the velocity cap are 88 internally heated bar racks used to prevent intake clogging due to frazil ice or excessive icing [Ref. 6.68].

#### I&E Discussion

In order to determine the potential I&E reductions at IPEC an extensive site-specific study would be required to determine the optimum location. A three year biological study to assess the possible extension of the cooling water intake structure at JAF began in early 2009 and is scheduled to conclude in late 2011. In accordance with the study plan submitted to the DEC, the fish species type and density at each sampling location is determined through scheduled hydroacoustic surveys and physical sampling using trawl and gill nets [Ref. 6.93]. A similar study would be required at IPEC.

#### Conclusions

Despite extensive ongoing biological analysis, no specific studies have been undertaken to identify alternative offshore intake locations for Unit 2 or Unit 3, nor is there data suitable for that purpose. Thus, further studies of the Hudson River adjacent to each CWIS defining the density of aquatic organisms as a function of horizontal distance from the shoreline and vertical depth would be required to evaluate the potential I&E reductions associated with an offshore intake location(s). Therefore, the engineering feasibility of an offshore intake cannot be determined at this time (i.e., without first conducting a biological study establishing the optimum location of an offshore intake for Unit 2 and Unit 3).

## **4.6 Flow Reduction**

Flow reductions at the Stations could be achieved through the use of new or existing technologies (i.e., dual/variable speed pumps), operational measures (i.e., outage timing), or by replacing some or all of Hudson River water used for cooling water with an alternative source of cooling water (i.e., recycled wastewater or water from radial wells). However, additional flow reductions via new or existing technologies (i.e., dual/variable speed pumps) or operational measures (i.e., outage timing) would not be expected to provide significant biological benefits over the current flow reductions achieved by using the existing technologies and operational measures. In addition, due to insufficient amounts of recycled wastewater in the vicinity of the Stations and the limited sources of available groundwater and

land space at the Stations, the use of recycled wastewater or radial wells are not considered a technologically feasible means of significantly reducing I&E.

#### **4.6.1 Dual/Variable Speed Pumps**

Currently, the Stations reduce flow through the use of operational measures and flow reduction technologies (i.e., dual speed pumps at Unit 2 and variable speed pumps at Unit 3). The historical flow reductions (from baseline) at the Stations are described in Section 2.4.2.3. The potential for further operational flow reductions is based on equipment operational limits and operating performance impacts. Current operation is governed by limitations used to ensure adequate reliability and safety, among other factors. If it is expected that these limits may be exceeded, the Stations are required to operate atypically under various levels of restriction that decrease the net power generated.

To evaluate the potential impact of further operational flow reductions, limits on the condenser pressure and cooling water velocity were used to develop the maximum flow reductions available. A computational model of each Unit was then used to determine the operational impacts of flow reductions up to the developed limits at each Unit.

##### **4.6.1.1 Flow Reduction Parameters/Methodology**

###### **4.6.1.1.1 Main Condenser Pressure Limit**

As described in Section 2.2.2, the objective of the main condenser is to provide a heat sink for the turbine exhaust steam, turbine bypass steam, and other related flows. The main condenser is of the single pass, divided water box, de-aerating type. It consists of two shells, one for each low pressure turbine cylinder, and is a River-water-cooled unit located directly beneath the low pressure cylinders of the main turbine.

The Unit 2 condenser low vacuum alarm is set at 25 in-Hg vacuum, or approximately 5 in-Hg atmospheric [Ref. 6.65], and the Unit 3 low vacuum alarm is set at no lower than 26 in-Hg vacuum, or approximately 4 in-Hg atmospheric [Ref. 6.66].<sup>17</sup> If the condenser low vacuum alarm points are exceeded, the Unit is forced into a loss of condenser vacuum abnormal operating procedure (AOP). The loss of condenser vacuum AOP prompts actions to stabilize the condenser vacuum, determine the cause of loss of vacuum, and return the vacuum to normal. The AOP could lead to a required manual reactor shutdown if the condenser vacuum cannot be restored.

###### **4.6.1.1.2 Cooling Water Velocity Limit**

The thermal performance of the condenser is dependent on the cooling water velocity through the condenser tubes, in conjunction with the amount of fouling of the tubes. According to the Heat Exchange Institute (HEI) [Ref. 6.38], water velocities of less than 3 fps through the condenser tubes do not build up enough flow resistance within the condenser to ensure a uniform quantity of water through all of the tubes. Without

<sup>17</sup> The pressure setpoints listed in the Alarm Response Procedures [Ref. 6.65; Ref. 6.66] are 25 and 26 in-Hg absolute for Units 2 and 3, respectively. Subtracting each of these setpoints from a standard atmospheric pressure of 29.92 in-Hg results in the main condenser vacuum setpoints of 3.92 and 4.92 in-Hg for Units 2 and 3, respectively.

sufficient flow resistance in the condenser tubes, heat transfer through the tubes would not be uniform and there would be an increased potential for fouling. Condenser performance under such conditions cannot be accurately predicted, and any correlation resulting from calculations or modeling using an input velocity below 3 fps cannot be regarded as a valid analysis [Ref. 6.38]. In addition, reduced flow velocities through the condenser tubes would be expected to increase fouling in the tubes [Ref. 6.103]. Fouling increases resistance to heat transfer and could affect the performance of the condenser. Therefore, in order to maintain plant performance and safety standards, the minimum sustained condenser tube velocity considered for flow reductions at each Unit is 3 fps [Ref. 6.38].

Unit 2 and Unit 3 are designed for maximum condenser tube water velocities of 4.1 fps and 6.0 fps, respectively [Ref. 6.42]. Limiting the condenser tube water velocity to 3 fps would result in a maximum available circulating water flow reduction of 27% at Unit 2 and 50% at Unit 3. The maximum available design flow reduction (i.e., circulating water flow and service water flow; see Section 2.4.2.3) resulting from condenser tube water velocities of 3 fps would be approximately 25% at Unit 2 and 45% at Unit 3.

#### **4.6.1.1.3 Inlet Water Temperature**

Eight years (2001 through 2008) of measured daily circulating water inlet temperatures were provided by the Stations. An algorithm was run to remove erroneous values, with a resulting inlet water temperature data recovery rate of 99.8%, as shown in Attachment 3, Table 3-1.

#### **4.6.1.1.4 PEPSE Model**

The performance evaluation of power system efficiency (PEPSE) model is a state-of-the-art power plant performance modeling software used by the power industry to estimate plant operational parameters and net power generated, using system inputs such as circulating water inlet temperature. The most recent PEPSE models for each Unit<sup>18</sup> were reviewed, updated, and run to produce the results discussed herein. Diagrams of the Stations' PEPSE models have been included in Attachment 3, Figures 3-1 through 3-12.

The inlet water temperature data received from the Stations was input into the updated PEPSE models, and the circulating water flow was reduced in 5% circulating water flow increments and run over a bounding range of circulating water inlet temperatures (32°F to 84°F, in 2°F increments). By varying the circulating water flow rate, the impacts of flow reductions on the Stations operation were calculated. When required, the net thermal input was varied for each circulating water inlet temperatures in order to

---

<sup>18</sup> The Stations supplied a Unit 2 PEPSE model updated in 2006 and a Unit 3 PEPSE model updated in 2007. While finalizing the Report analysis, updated versions of the PEPSE models were developed by the Stations. The new models were reviewed and compared to the PEPSE models originally used for this Report. It was determined that using the new PEPSE models would not result in any significant differences in the analysis and any difference would result in greater power losses due to additional flow reduction at the Stations. Therefore, the PEPSE models used for this analysis produce conservative results.

achieve condenser vacuum levels above the alarm set points discussed in Section 4.6.1.1.1.

## **4.6.1.2 Flow Reduction Impacts**

### **4.6.1.2.1 Flow Reduction Analysis**

Using the daily measured cooling water intake temperatures at each percentage of flow reduction from baseline, the Stations' PEPSE models were used to determine the hourly operational power loss attributed to each defined design flow reduction. Operational power loss is defined here as a loss of generating capacity due to the thermodynamic effects of reduced cooling water flow through the condenser. In contrast, a parasitic loss is the electric power load required to operate the cycle under the changed conditions.

The annual average operational power losses at Units 2 and 3 are listed in Table 4.7 and Table 4.8, respectively. As shown, various levels of flow reduction from baseline could occur at each Unit without operational power losses in November through May. From June through October, however, even small amounts of flow reduction would result in operational power losses at both Units. The maximum operational power losses at Units 2 and 3 are provided in Attachment 3, Tables 3-2 and 3-3, respectively.

**Table 4.7 Unit 2 Average Power Loss (MWe) Attributed to Design Flow Reduction**

Month	Design Flow Reduction				
	5%	10%	15%	20%	25%
January	-0.1	-0.3	-0.5	-0.7	-0.9
February	-0.1	-0.3	-0.4	-0.7	-1.0
March	-0.1	-0.3	-0.5	-0.7	-0.9
April	-0.1	-0.1	-0.2	-0.2	-0.1
May	0.4	0.9	1.7	2.9	4.5
June	1.5	3.3	5.4	8.0	11.2
July	2.1	4.6	7.4	10.7	14.6
August	2.2	4.8	7.8	11.2	15.2
September	2.0	4.3	7.0	10.2	13.9
October	1.0	2.4	4.0	6.1	8.7
November	0.0	0.1	0.3	0.7	1.3
December	-0.1	-0.2	-0.3	-0.4	-0.4
Average Annual	0.7	1.6	2.7	4.0	5.6

Notes:

<sup>1</sup> Based on daily inlet water temperature measured from 2001 through 2008.

<sup>2</sup> Atypical inlet water temperatures less than 40°F excluded to remove effect of unstable cooling properties of water near the freezing point.

<sup>3</sup> The maximum available design flow reduction would be approximately 25% at Unit 2 based on the HEI-defined 3 fps limitation.

**Table 4.8 Unit 3 Average Power Loss (MWe) Attributed to Design Flow Reduction**

Month	Design Flow Reduction								
	5%	10%	15%	20%	25%	30%	35%	40%	45%
January	-0.2	-0.4	-0.6	-0.8	-1.3	-2.3	-3.5	-4.2	-4.4
February	-0.1	-0.3	-0.6	-0.8	-1.1	-2.0	-3.3	-4.2	-4.5
March	-0.2	-0.4	-0.6	-0.8	-1.3	-2.3	-3.5	-4.2	-4.3
April	-0.3	-0.7	-1.1	-1.6	-2.1	-2.7	-3.1	-3.2	-2.6
May	-0.2	-0.2	-0.1	0.1	0.4	1.0	2.2	4.2	7.9
June	0.6	1.3	2.4	3.8	5.7	8.3	11.9	16.8	23.4
July	1.5	3.3	5.6	8.4	11.7	15.9	21.0	27.4	36.9
August	1.7	3.8	6.4	9.4	13.0	17.4	22.8	29.5	42.3
September	1.2	2.8	4.7	7.1	10.2	14.0	18.8	24.8	32.8
October	0.2	0.6	1.2	2.0	3.2	5.0	7.6	11.4	17.0
November	-0.4	-0.8	-1.3	-1.7	-2.0	-2.1	-1.9	-1.2	0.3
December	-0.2	-0.5	-0.8	-1.3	-1.9	-2.7	-3.3	-3.6	-3.2
Average Annual	0.3	0.7	1.3	2.0	2.9	4.0	5.5	7.9	11.9

Notes:

<sup>1</sup> Based on daily inlet water temperature measured from 2001 through 2008.

<sup>2</sup> Atypical inlet water temperatures less than 40°F excluded to remove effect of unstable cooling properties of water near the freezing point.

<sup>3</sup> The maximum available design flow reduction would be approximately 45% at Unit 3 based on the HEI-defined 3 fps limitation

The negative power loss values shown in Table 4.7 and Table 4.8 correspond to potential power gains that could be achieved through flow reductions from baseline. Note that the Stations already achieve these power gains through operational flow reductions that currently occur in the winter months. These gains result from reduced subcooling of the condensate water. When subcooling occurs, the feedwater heater duty increases and turbine output is reduced. Therefore, when subcooling is reduced, turbine output and power production increase. The ability to increase power generated due to reduced subcooling is reflected in the efficient flow schedule currently in place at each Unit [Ref. 6.89].

However, the thermodynamic advantage resulting from a reduction in condensate subcooling would be somewhat counteracted by a parasitic pump load increase. As flow is reduced from 140,000 gpm to 70,000 gpm, the power load required to operate the Unit 3 variable speed pumps increases, with peak required load at approximately 95,000 gpm [Ref. 6.63]. The power load increase is due to decreasing pump efficiency and increasing total dynamic head as flow is reduced. The motor efficiency and drive efficiency would also be expected to decrease as flow is reduced [Ref. 6.102], further increasing the power load required to operate the pumps. The total power load increase is estimated to be less than 1 MWe at each Unit for the majority of operating conditions. Therefore, the parasitic power load increase has been neglected to ensure a conservative estimate (i.e., the net power loss at each Unit would actually be slightly more than predicted here).



#### 4.6.1.2.2 Power Reduction Analysis

Using the PEPSE modeling output previously described, the daily flow reduction available was calculated given an available threshold power loss. Table 4.9 and Table 4.10 provide the incremental reductions in design flow for reductions of active power in 5 MWe increments at Units 2 and 3, respectively. The tabulated values depict the average percentage of circulating water reduction available, given the HEI defined 3 fps condenser flow velocity restriction [Ref. 6.38]. Due to the condenser flow velocity limit of 3 fps, no additional reductions in flow could be achieved, and, therefore, no additional losses in active power above 20 MWe and 40 MWe for Units 2 and 3, respectively, would be warranted.

**Table 4.9 Unit 2 Average Design Flow Reduction Available at Defined Power Loss**

Month	Power Loss Threshold (MWe)				
	0	5	10	15	20
January	25.0%	25.0%	25.0%	25.0%	25.0%
February	25.0%	25.0%	25.0%	25.0%	25.0%
March	25.0%	25.0%	25.0%	25.0%	25.0%
April	18.4%	25.0%	25.0%	25.0%	25.0%
May	1.3%	23.5%	25.0%	25.0%	25.0%
June	0.0%	14.5%	22.5%	25.0%	25.0%
July	0.0%	10.7%	18.9%	24.9%	25.0%
August	0.0%	10.3%	18.3%	24.6%	25.0%
September	0.0%	11.3%	19.7%	24.9%	25.0%
October	0.3%	17.9%	24.0%	25.0%	25.0%
November	10.1%	24.9%	25.0%	25.0%	25.0%
December	22.8%	25.0%	25.0%	25.0%	25.0%
Average Annual	10.6%	19.8%	23.2%	24.9%	25.0%

Notes:

<sup>1</sup> Based on daily inlet water temperature measured from 2001 through 2008.

<sup>2</sup> Atypical inlet water temperatures less than 40°F excluded to remove effect of unstable cooling properties of water near the freezing point

<sup>3</sup> Values highlighted yellow represent those months restricted solely by the HEI-defined 3 fps limitation.

**Table 4.10 Unit 3 Average Design Flow Reduction Available at Defined Power Loss**

Month	Power Loss Threshold (MWe)								
	0	5	10	15	20	25	30	35	40
January	45.0%	45.0%	45.0%	45.0%	45.0%	45.0%	45.0%	45.0%	45.0%
February	45.0%	45.0%	45.0%	45.0%	45.0%	45.0%	45.0%	45.0%	45.0%
March	45.0%	45.0%	45.0%	45.0%	45.0%	45.0%	45.0%	45.0%	45.0%
April	44.9%	45.0%	45.0%	45.0%	45.0%	45.0%	45.0%	45.0%	45.0%
May	16.9%	41.9%	44.4%	44.9%	45.0%	45.0%	45.0%	45.0%	45.0%
June	0.2%	24.5%	33.3%	38.6%	42.2%	44.7%	45.0%	45.0%	45.0%
July	0.0%	13.9%	22.6%	29.0%	34.1%	38.9%	44.2%	45.0% <sup>4</sup>	45.0%
August	0.0%	12.4%	20.9%	27.3%	32.5%	36.7%	42.5%	45.0% <sup>4</sup>	45.0%
September	0.0%	15.9%	24.9%	31.1%	36.4%	41.8%	44.5%	45.0%	45.0%
October	4.5%	31.7%	38.6%	42.5%	44.1%	45.0%	45.0%	45.0%	45.0%
November	40.0%	44.8%	45.0%	45.0%	45.0%	45.0%	45.0%	45.0%	45.0%
December	44.9%	45.0%	45.0%	45.0%	45.0%	45.0%	45.0%	45.0%	45.0%
Average Annual	23.7%	34.1%	37.8%	40.2%	42.0%	43.5%	44.7%	45.0%	45.0%

Notes:

<sup>1</sup> Based on daily inlet water temperature measured from 2001 through 2008.

<sup>2</sup> Atypical inlet water temperatures less than 40°F excluded to remove effect of unstable cooling properties of water near the freezing point

<sup>3</sup> Values highlighted yellow represent those months restricted solely by the HEI-defined 3 fps limitation.

<sup>4</sup> Values round-up to 45.0%, but include days which were not limited by the HEI-defined 3 fps limitation.

#### 4.6.1.3 Effects of Further Operational Flow Reductions

As described in Section 2.4.2.1, Unit 2 is currently equipped with dual speed CW pumps, and Unit 3 is equipped with variable speed CW pumps. The Stations utilize both the dual speed (Unit 2) and variable speed (Unit 3) CW pumps to provide significant reductions in CW flow rates.

##### I&E Discussions

Attachment 6 (Tables 17 and 23 of Appendix A) provide the estimated reductions from the regulatory baseline in EA1 losses that could be achieved using the flow reductions associated with the defined power losses presented in Table 4.9 and Table 4.10. These reductions also account for the Stations' survival rates (Attachment 6) and average historic flow reductions (Section 2.4.2.3.2). From Attachment 6 (Tables 17 and 23 of Appendix A), Table 4.11 presents the potential reductions in EA1 I&E corresponding to various active power reductions. As discussed in Section 4.6.1.1.2, the available design flow reduction would be limited to approximately 25% at Unit 2 and 45% at Unit 3, due to the HEI-defined 3 fps limitation. Because no additional reductions in flow could be achieved, no additional losses in active power above 20 MWe and 40 MWe for Units 2 and 3, respectively, would be warranted.

**Table 4.11 Potential Percent Reduction of Annual EA1 I&E Losses at Defined Power Losses in Each Month**

Month	Power Loss Threshold ( <i>Unit 2 / Unit 3</i> )					
	<i>0 / 0 MWe</i>		<i>20 / 20 MWe</i>		<i>20 / 40 MWe</i>	
	EA1 Entrainment	EA1 Impingement	EA1 Entrainment	EA1 Impingement	EA1 Entrainment	EA1 Impingement
January	0.0%	8.8%	0.0%	8.8%	0.0%	8.8%
February	0.0%	9.6%	0.0%	9.6%	0.0%	9.6%
March	0.0%	12.0%	0.0%	12.0%	0.0%	12.0%
April	0.4%	6.7%	0.4%	6.7%	0.4%	6.7%
May	6.3%	7.4%	6.5%	7.9%	6.5%	7.9%
June	14.9%	8.5%	17.2%	9.9%	17.2%	10.0%
July	7.3%	4.0%	11.8%	4.4%	13.0%	4.5%
August	4.2%	4.2%	7.0%	4.5%	7.6%	4.7%
September	1.4%	4.4%	2.7%	4.8%	2.9%	4.9%
October	1.2%	3.9%	2.2%	4.4%	2.2%	4.4%
November	0.0%	4.7%	0.0%	5.0%	0.0%	5.0%
December	0.0%	6.5%	0.0%	6.5%	0.0%	6.5%
Annual	35.7%	80.7%	47.8%	84.7%	49.9%	85.0%

The maximum possible entrainment reduction shown in Table 4.11 (49.9%) is only 16.1% more than the current entrainment reductions based on the historic flow reductions discussed in Section 3.2 and would require substantial continuous losses in generation. In addition, the EA1 I&E reductions presented in Table 4.11 remain well below the potential percent reduction that could be achieved through conversion of IPEC to closed-loop cooling.

#### Conclusions

The maximum available reductions from baseline in EA1 I&E associated with reductions in the design flow rates would be approximately 85.0% and 49.9%, respectively. In addition, these reductions would correspond to continuous active power reductions of up to 20 MWe at Unit 2 and 40 MWe at Unit 3. As discussed in Section 4.6.1.2.2, additional losses in active power would not produce additional reductions in the design flow rates. These reductions would not be comparable to those potentially achievable by the NYSDEC Proposed Project, and a significant cost would be associated with the active power reductions resulting from the flow reductions.

#### **4.6.1.4 Conversion of Unit 2 to Variable Speed Pumps**

Both dual speed pumps and variable speed pumps allow reduced intake flow rates when ambient River temperatures are low, although variable speed pumps would provide significantly greater flow control, as the flow can be varied continuously between the maximum and minimum flow rates. The Unit 2 dual speed pumps operate at 140,000 gpm or 84,000 gpm [Ref. 6.60]. Therefore, each dual speed pump allows for reductions in flow of 0% (full flow), 40% (reduced flow), and 100% (pump offline). Reducing the

flow rate of individual dual speed pumps allows incremental flow reductions from baseline flow (i.e., maximum design flow for the Unit 1 RW and Unit 2 SW and CW pumps) of 6%, 13%, 19%, 25%, 32%, and 38% per Unit. Although the dual speed pumps have the capabilities of significantly reducing the intake flow rates at Unit 2, flow reductions of more than 25% would violate the condenser tube water velocity limit discussed in Section 4.6.1.1.2.

#### Conclusions

Although the use of variable speed pumps at Unit 2 would provide significantly greater flow control and smoother transitions between flow rates, the existing dual speed pumps provide sufficient flow reduction increments up to, and including, the maximum flow reduction of 25% allowable at Unit 2. Therefore, conversion of the Unit 2 dual speed pumps to variable speed pumps is not likely to provide any appreciable biological benefit.

### **4.6.2 Use of Recycled Wastewater as Cooling Water**

Reductions in the amount of Hudson River water used for cooling at the Stations, constituting a reduction in flow, could be achieved through the replacement of some or all of Hudson River water with an alternative source (i.e., recycled wastewater or water from radial wells). However, the use of recycled wastewater from waste treatment facilities, frequently referred to as grey water, as an alternative to using River water for thermal rejection from the each Unit's condensers is not considered as a viable method of flow reduction due to the lack of available sources in the vicinity of IPEC. To fulfill the Stations' heat transfer requirements using recycled wastewater as an alternative to Hudson River water, the approximate volume and flow required would have to be the same or greater than the volume and flow needed when using Hudson River water as the CW source.

In order to determine the availability of recycled wastewater in the vicinity of IPEC, the permitted discharge flow rates were determined for the SPDES-permitted Westchester County wastewater treatment facilities (with their distance from IPEC established). The discharge flows listed in the SPDES Permits for all wastewater treatment facilities in Westchester County are included in Table 4.12 (see Attachment 7).

**Table 4.12 SPDES Water Discharge Permit Flows**

<b>Facility (SPDES Permit)</b>	<b>Flow</b>	<b>% Req'd CW Flow</b>	<b>Driving Distance to IPEC (approx.)</b>	<b>Direct Distance (approx.)</b>
Buchanan WWTP (NY0029971)	0.5 MGD (347.2 gpm)	0.02%	<1 mi.	<1 mi.
Peekskill WWTP (NY100803)	10 MGD (6,944.4 gpm)	0.41%	4 mi.	3 mi.
Ossining WWTP (NY108324)	7 MGD (4,861.1 gpm)	0.29%	10 mi.	9 mi.
Yorktown Heights WWTP (NY0026743)	1.5 MGD (1,041.7 gpm)	0.06%	13 mi.	9 mi.
North Castle WWTP (NY109584)	0.38 MGD (263.9 gpm)	0.02%	25 mi.	16 mi.
Wild Oaks WWTP (NY0065706)	0.06 MGD (41.7 gpm)	0.0025%	29 mi.	16 mi.
Port Chester WWTP (NY0026786)	6 MGD (4,166.7 gpm)	0.25%	30 mi.	25 mi.
Oakridge WPCF (NY0030767)	0.08 MGD (55.6 gpm)	0.0033%	31 mi.	23 mi.
Yonkers Joint WWTP (NY0026689)	92 MGD (63,888.9 gpm)	3.8%	31 mi.	25 mi.
Blind Brook WWTP (NY0026719)	5 MGD (3,472.2 gpm)	0.21%	32 mi.	26 mi.
Mamaroneck WWTP (NY0026701)	18 MGD (12,500.0 gpm)	0.74%	34 mi.	26 mi.
New Rochelle WWTP (NY0026697)	13.6 MGD (9,444.4 gpm)	0.56%	38 mi.	27 mi.
<b>Total</b>	<b>154.12 MGD (107,027.8 gpm)</b>	<b>6.37%</b>	<b>278 mi.</b>	<b>206 mi.</b>

The closest wastewater treatment facility, Buchanan Wastewater Treatment Plant, is located less than 1 mile away from IPEC and discharges on average only 347.2 gpm. Yonkers Joint Wastewater Treatment Plant discharges 63,888.9 gpm, far more than any plant in Westchester County; however, it is located approximately 25 miles away and discharges only 3.8% of the 1,680,000 gpm required for normal CW flow. Furthermore, if the discharge from every wastewater treatment facility in Westchester County were combined, the amount of River water needed as a circulating fluid would be reduced by only 6.37% for both Units, or 12.74% for one Unit only, and would require between 205 and 277 miles of pipeline.

### Conclusions

Due to the limited sources of recycled wastewater in the vicinity of IPEC, recycled wastewater is not considered a technologically feasible means of significantly reducing I&E.

#### **4.6.3 Outage Timing**

The strategic timing of maintenance outages would not be able to significantly reduce EA1 I&E over the Stations' existing technologies and operational measures. As discussed in Section 2.4.2.3, maintenance outages at the Stations have the potential to significantly reduce the flow entering a CWIS during the outage periods. When a Unit is offline, a minimal amount of flow enters the CWIS as some CW would still be required after shutdown and prior to restart. Adequate SW flow must also be provided when the Unit is offline in order to maintain essential cooling of nuclear safety-related systems.

Currently, scheduled maintenance outages at each Unit occur every 24 months and are anticipated to approximately 25 days. The outages are staggered so that the Units are not offline at the same time. The current outage schedule for Unit 2 and Unit 3 calls for spring outages for each Unit. A three year schedule of requested outage dates is filed annually with New York Independent System Operator (NYISO), which reviews the requested schedule and approves or disapproves the outage dates [Ref. 6.85]. Maintenance outages are typically scheduled between seasons of peak electrical demand, between the high use winter months (December, January, and February) and the high use summer months (June, July, and August). As discussed in Section 3.2, the Stations' existing technology is considered state-of-the-art for impingement; therefore, and outage timing considerations focus on minimizing entrainment.

Attachment 6 (Tables 17 and 23 of Appendix A) provide the potential reductions in each month due to a one Unit outage at IPEC. Table 4.11 provides the potential incremental reductions a one Unit outage would have to reduce EA1 I&E when compared to the Stations' existing reductions. These reductions would be similar for an outage at either Unit 2 or Unit 3.

**Table 4.13 Potential Incremental Reductions in EA1 I&E Losses Due to Outage Timing at One Unit From the Existing Technologies and Operational Measures**

Month	EA1 Entrainment	EA1 Impingement
January	0.0%	0.3%
February	0.0%	0.2%
March	0.0%	0.3%
April	0.1%	1.0%
May	2.1%	1.5%
June	9.7%	2.9%
July	10.7%	1.2%
August	5.3%	0.9%
September	2.6%	1.2%
October	1.8%	0.6%
November	0.0%	0.5%
December	0.0%	0.3%

As shown in Table 4.11, outages taken in the months of June, July, or August would have the highest potential to provide incremental EA1 entrainment reductions. However, while scheduling each Unit's outages for the months of June, July, or August would coincide with the optimum period for EA1 entrainment reduction, this period also reflects peak summer demand. NYISO historically has underscored the importance of the Stations' generation during this period. As such, I&E reductions associated with scheduled outage shifting to June, July, or August are not further considered. The only remaining months that would have the potential to reduce EA1 entrainment are May, September, and October where the highest incremental reduction in EA1 entrainment and impingement over the Stations' current technologies and operational measures would be 2.6% and 1.2%, respectively, in the month of September.

#### Conclusions

Assuming approval from NYISO, each Unit having bi-annual outages in September would result in potential incremental EA1 entrainment and EA1 impingement reductions of up to approximately 2.6% and 1.2%, respectively, and would not provide comparable reductions to closed-loop cooling or other alternative technologies. As such, a change in the current schedule outage timing is not further considered as an alternative to the current technologies and operational measures utilized at the Stations.

#### **4.6.4 Radial Wells**

Radial wells are not considered as a viable method of flow reduction due to the limited sources of available groundwater and land space at IPEC.

Radial wells are underground horizontal wells that draw water from the surrounding aquifer. Typical radial well systems consist of a concrete pump-well caisson installed in

the ground with several perforated collector screen pipes (laterals) protruding through wall ports into the surrounding aquifer. Radial wells draw water at low velocities through many feet of porous material, reducing the flow through the CWISs and, therefore, I&E. A typical plan and section view of a radial well system is shown in Figure 4.26.

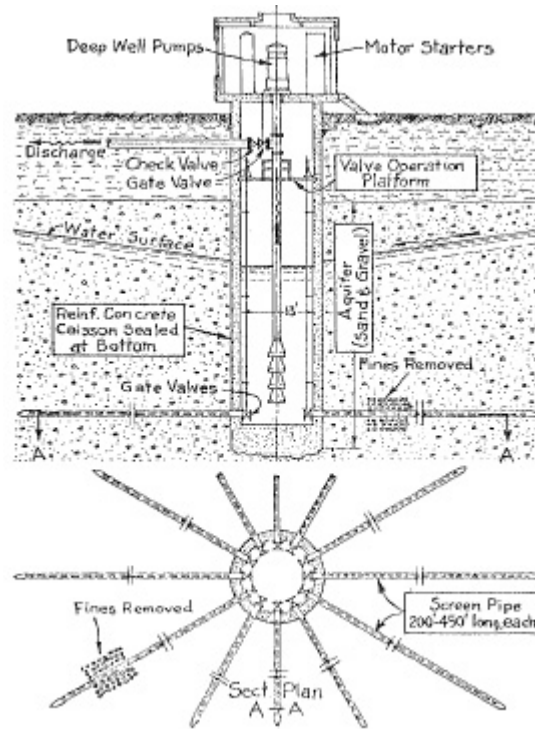

**Figure 4.26 Radial Well – Section and Plan Views [Ref. 6.2]**

Radial wells have been installed successfully at utility and municipal facilities, producing water flow rates of up to 50 MGD [Ref. 6.100]. The success of radial well technology is highly site specific and limited by the following:

- Radial wells are only suitable where there is a porous aquifer with the capacity to provide the quantity of water required. Test wells must be drilled and pump-tested to determine the exact characteristics of the aquifer and size of the required radial well system. Installation and testing of wells would take at least two to four months.
- The yield capacity of the individual caisson units is limited to approximately 25,000 gpm. However, the yield capacity is likely much less for most aquifers as the usual capacity of an individual caisson unit is 1000 to 10,000 gpm. For larger flow requirements, multiple caisson units are required and must connect to a common transmission pipe to the plant.

IPEC is situated on a complex of Cambro-Ordovician rocks represented by the Manhattan Formation and Inwood Marble Formation [Ref. 6.37]. The site lies predominantly upon the Inwood Marble Formation which consists of relatively pure carbonate rock of dolomitic and/or calcic mineralogy with silica rich zones. In the bedrock present at the



site, groundwater occurs and migrates in open fractures or voids. These void spaces are termed secondary porosity with the primary porosity being the void spaces within the bedrock itself. Inwood Marble has a very low primary porosity, and therefore does not contribute to the flow or storage of significant volumes of water [Ref. 6.37].

IPEC is located in a crystalline rock aquifer (i.e., there is limited porosity and the majority of the groundwater is in the fractures). Wells installed in a crystalline rock aquifer are typically drilled to depths ranging between 20 ft to 600 ft, yielding between 1 and 120 gpm; however, the well depths occasionally exceed 1000 ft and may yield more than 500 gpm [Ref. 6.117]. Although it is possible that higher groundwater yields could be obtained from collector screens below and near the Riverbed, site-specific pump testing would be required to determine this.

Groundwater is encountered at the site primarily in bedrock fractures and along the jointing or bedding planes of the various rock strata. Thus, groundwater may be encountered at different elevations on the site depending on the location, ground surface elevation, and if water-bearing fractures, joints, and bedding planes are encountered. Investigation performed in 2005 and 2006 indicated groundwater may be encountered in monitoring wells at the site between 3 feet to more than 80 ft above MSL and is generally encountered from 10 ft to more than 50 ft beneath the surface [Ref. 6.24].

Within a one mile radius of the site, there are seven United States Geological Survey (USGS) registered wells. As shown in Table 4.14, each well ranges in depth from 30 ft to 500 ft below the surface and, based on available information, produces between 4 gpm to 30 gpm [Ref. 6.117]. It should be noted that two of the registered wells are on the IPEC site.

**Table 4.14 Registered USGS Wells within One Mile of IPEC [Ref. 6.24]**

USGS Registered Well ID	County	Well Depth (below surface)	Approximate Distance to IPEC	Status	Capacity (gpm)	Primary Use
WE 245	Westchester	100 ft.	Onsite	Unused	4	Domestic
WE 246	Westchester	193 ft.	Onsite	Unused	N/A	N/A
WE 244	Westchester	60 ft.	3950 ft ESE	N/A	30	Unused
WE 261	Westchester	500 ft.	500 ft. ENE	N/A	25	Unused
RO 307	Rockland	192 ft.	5280 ft E	N/A	N/A	Domestic
RO 313	Rockland	30 ft.	4500 ft. NW	N/A	N/A	Domestic
RO 314	Rockland	110 ft.	5280 ft. ENE	N/A	N/A	Commercial

N/A: Information not available

As provided by Design of Water Intake Structures for Fish Protection [Ref. 6.2], the following guidelines should be considered for the conceptual design of radial well systems:

- Caisson unit spacing is typically 1500 ft; however, spacing may be closer in productive aquifers. For example, the caisson units at the Grand Gulf Nuclear Station (near Vicksburg, Mississippi) have a minimum spacing of approximately 950 feet. Pump tests conducted in the well fields determined a minimum yield of 5600 gpm.
- The diameter of the caisson depends on the space requirements for the pumps and on the clearance needed for the lateral screens. A 16 ft inner diameter is typical.

- Caissons depths of up to 200 feet are considered feasible; however, caisson depth is typically determined by the radial well vendor and is dependent on aquifer characteristics.
- The diameter of the lateral screens is typically 8 to 16 inches but sizes up to 48 inches could be considered for a very high yield aquifer.
- The maximum length of a lateral screen is approximately 450 feet for any diameter. The usual length is between 150 ft and 300 ft. The number of lateral screens and their lengths are typically determined by the vendor.
- Inflow velocity through the screens typically ranges from 1 to 2 fpm and net open area for the lateral screens typically ranges from 18 to 22 percent.
- The total length of the collector screens can be determined by the following formula:

$$\text{Length (ft)} = 2.837 * \text{Flow Rate (gpm)} / \text{Diameter (in)}$$

Based on the above design criteria, the IPEC site could conceivably support at most six radial well systems. Four radial wells could potentially be located north of the Unit 2 containment building, and two radial wells could potentially be located south of the Unit 3 containment building as shown in Attachment 2, Figure 2-19. If twelve lateral screens were installed in each caisson and each lateral screen was considered an individual well capable of producing 120 gpm, then each caisson would be capable of producing 1440 gpm. Each lateral would be approximately 22 ft long assuming a screen diameter of 16 inches, an inflow velocity of 1 fpm, and a percent open area of 18. Four radial wells servicing Unit 2 could provide up to 5760 gpm or 0.69 percent of the CW maximum design flow rate. Two radial wells servicing Unit 3 could provide up to 2880 gpm or 0.34 percent of the CW maximum design flow rate required.

### Conclusions

Due to the limited sources of available groundwater and land space at IPEC, radial wells are not considered a technologically feasible means of significantly reducing I&E.

## **4.7 Alternative Heat Rejection and Recirculation**

No method of alternative heat rejection and recirculation – including evaporative ponds, spray ponds, cooling canals and in-river heat exchangers – is considered as a viable alternative to the current screening systems at the Stations. Due to the limited sources of land area available at IPEC, evaporative ponds, spray ponds, and cooling canals are not considered a technologically feasible means of significantly reducing I&E. In-river heat exchangers would require a large amount of surface area to dissipate the required heat load, and would create a large point source heat load in the Hudson River that would have no thermal dilution. The in-river heat exchanger temperature would exceed the maximum SPDES plant discharge temperature permit limits, particularly during periods of slack tide.

### **4.7.1 Evaporative Ponds**

Evaporative ponds, also known as cooling ponds, are not considered as viable alternatives to the current screening systems at the Stations, because the land area required for an

evaporative pond to reject the heat load of one or both Units would be much greater than the land area available at IPEC.

Evaporative ponds are bodies of water that primarily use surface evaporation to reject heat to the atmosphere. The term ‘pond’ is relative and can be applied to small or large bodies of water. In areas with low land costs, artificial cooling ponds can be relatively inexpensive to construct and operate with small makeup water requirements. Most artificial cooling ponds are relatively shallow where a minimum depth of about 3.3 feet is normal. The warm discharge water entering the cooling pond will lose and gain heat as it passes through the pond by the combined mechanisms of conduction, convection, radiation, and evaporation. However, evaporation is the main mode of heat transfer and the heat loss from the cooling pond is governed by the temperature differential between the pond surface and the atmosphere. The main disadvantage of cooling ponds is the low heat transfer rate to the air requiring large evaporative surface areas for cooling large volumes of water [Ref. 6.70]. Cooling pond areas for power generation facilities typically range between 1.24 to 2.47 acres per megawatt; however, these land area requirements are not specific to nuclear generating facilities [Ref. 6.97]. Using this rule-of-thumb approximation, the Stations would require a cooling pond area of approximately 2700 to 5300 acres to reject an appropriate amount heat from the condensers for a closed recirculating system.

The South Texas Project (STP) nuclear power plant in Bay City, Texas utilizes a 46 acre essential cooling pond as the ultimate heat sink and a 7000 acre main cooling pond for circulating water purposes. STP currently operates two 1251 MWe units (Units 1 and 2). The essential and main cooling ponds were designed to support two additional 1300 MWe reactors (Units 3 and 4). Assuming that Units 3 and 4 are constructed as specified, the land area at STP used for cooling ponds will be 1.35 acres per megawatt [Ref. 6.105]. If the Stations could obtain the same cooling pond performance as STP, approximately 2913 acres of evaporative surface area would be required to reject the heat loads from the condensers.

Sizing of a conceptual cooling pond for the Stations was conducted using the methodology specified in the Advanced Air and Noise Pollution Control (AANPC) Handbook [Ref. 6.121]. A wet bulb temperature of 33.8°F and wind speed of 4.7 mph, respectively, were selected by averaging meteorological data gathered from IPEC’s weather station between 1999 through 2008. The highest wet bulb temperature reported during this time period was 79.3°F. A design heat rejection rate of  $4.65 \times 10^9$  BTU/hr is specified by the condenser data sheets. A design surface water temperature of 93.2°F was assumed based on the maximum permitted average discharge water temperature allowed by the SPDES permit [Ref. 6.86]. The choice of a high surface water temperature is a conservative assumption because an increased temperature differential between the surface water temperature and average wet bulb temperature provides greater heat transfer resulting in a smaller cooling pond surface area. The mean solar radiation coefficient was also conservatively estimated at 3795 kilocalorie per day per square meter ( $\text{kcal/d-m}^2$ ), which is an average of the lower range of the short-wave and long-wave solar radiation coefficients provided in the AANPC Handbook [Ref. 6.121]. Using these inputs, a cooling pond surface area of approximately 320 acres would be required to reject the heat load from Unit 2 or Unit 3 and a cooling pond surface area of 650 acres would be required to reject the combined heat loads

generated by Units 2 and 3. These estimated areas are conservative because the surface area of actual cooling ponds would be sized to reject the required heat loads at the highest wet bulb temperature. At a wet bulb temperature of 79.3°F, approximately 6000 acres of cooling pond surface area would be required to reject the heat load from either Unit 2 or Unit 3, and approximately 12,100 acres of cooling pond surface area would be required to reject the combined heat load generated by Units 2 and 3.

### Conclusions

Although the total land area of IPEC is approximately 239 acres, only 115 acres are currently available for use because most of the site is already occupied [Ref 6.24]. As such, the land area required for a cooling pond to reject the heat load of one or both Units would be much greater than the land area available at IPEC, based on rule-of-thumb approximations, comparison to existing cooling pond systems, and theoretical design methods. Therefore, the use of a closed re-circulating cooling pond at IPEC is not further considered.

### **4.7.2 Spray Ponds**

Spray ponds are not considered as viable alternatives to the current screening systems at the Stations, because the land area required for a spray pond to reject the heat load of one or both Units would be greater than the available open area at IPEC.

Spray ponds are modified cooling ponds with spray nozzles floating on or located just above the pond surface. Water pumped through the spray nozzles is diffused into droplets increasing the surface area in contact with the ambient air, thus enhancing the rate of evaporative heat loss. Spray ponds also transfer heat to the atmosphere through evaporation from the surface of the pond similar to conventional cooling ponds. The required surface area of a spray pond can be 20 times less than the surface area required by a conventional cooling pond for an identical heat load [Ref. 6.70]. Makeup water requirements for a spray pond are larger than a conventional cooling pond due to the increased evaporation and drift, ranging from 2 to 5 percent of the water volume sprayed. Normally, spray pond nozzles are operated at a pressure of 7 psi with flow rates up to 50 gpm per nozzle. For highest efficiency, spray ponds should have a rectangular shape with the long side oriented perpendicular to the prevailing summer wind direction [Ref. 6.106].

Sizing of a conceptual spray pond system for the Stations was conducted using the methodology specified by Spraying Systems Company [Ref. 6.106]. A design wet bulb temperature of 68.5°F was selected by analysis of meteorological data gathered from IPEC's weather station between 1999 through 2008. Per the Spraying Systems Company methodology, the design wet bulb temperature is defined as the maximum wet bulb temperature which is exceeded in less than 5% of the summer time [Ref. 6.106]. The highest wet bulb temperature reported during this time period was 79.3°F. A desired spray pond outlet temperature of 75°F was selected and corresponds to the Unit 3 condenser design inlet water temperature [Ref. 6.42]. A spray pond inlet temperature of 93.2°F was assumed, corresponding to the maximum permitted discharge water temperature allowed by the SPDES permit, and a design flow rate of 1,680,000 gpm was used, corresponding to the maximum circulating water intake flow. Based on these inputs and the 50% evaporative heat transfer efficiency recommended by Spraying Systems Company [Ref.

6.106], the outlet temperature of water sprayed once through a spray pond would cool to a temperature of approximately 81°F, exceeding the desired outlet temperature of 75°F. In order to cool to the desired outlet temperature, the water would have to be re-sprayed through a second in-line spray pond. The recommended nozzle and spacing requirements [Ref. 6.106] determined that each of the spray ponds would need a surface area of approximately 60.4 acres (120.8 total acres) to reject the heat loads generated by Units 2 and 3. Each conceptual pond would require a width of 800 ft and a length of 3290 ft, and would need to be oriented lengthwise from east to west due to the prevailing north-south summer wind direction. However, this estimated area is conservative because the surface area of an actual spray pond system would be sized to reject the required heat loads during the summer months corresponding to the highest wet bulb temperature of 79.3°F.

Based on the methodology specified by Spraying Systems Company, the outlet temperature of a spray pond system cannot be less than the design wet bulb temperature. Thus, a spray pond system designed to the highest web bulb temperature (79.3°F) could not reject the heat required to provide condenser inlet water at a temperature of 75°F. Inlet water at a temperature of 93.2°F and flow rate of 1,680,000 gpm would need to be circulated through nine spray ponds to be cooled to a temperature of 79.3°F, requiring a spray pond surface area of approximately 544 acres.

### Conclusions

As discussed in Section 4.7.1, only 115 acres are currently available for use at IPEC because most of the site is already occupied. As such, the required surface area of a spray pond system would be greater than the available open area at IPEC. Therefore, the use of closed, re-circulating spray ponds at IPEC is not further considered.

### **4.7.3 Cooling Canals**

Cooling canals are not considered as viable alternatives to the current screening systems at the Stations, because the land area required for a cooling canal to reject the heat load of one or both Units would be much greater than the land area available at IPEC.

Cooling canals are long, narrow artificial bodies of water that primarily use surface evaporation to reject heat to the atmosphere. Open cooling canal systems function as thermal buffers by reducing the temperature of heated effluent prior to discharging into an ocean, River, or estuary. Re-circulating cooling canal systems operate like radiators: heated water is discharged into one end of the system, the heat is released to the environment as the water travels through the canals, and cooled water is withdrawn from the opposite end of the system. Most cooling canals are relatively shallow with depths typically ranging from 1 ft to 3 ft. Similar to evaporative cooling ponds, the main disadvantages of cooling canals are the low heat transfer rate to the air and the large surface areas required for cooling large volumes of water [Ref. 6.70].

Turkey Point Nuclear Plant (Turkey Point) in Miami-Dade County, Florida utilizes a 6700-acre re-circulating cooling canal system for cooling of its two 693 MWe nuclear reactor units (Units 3 and 4) and two 400 MWe fossil units (Units 1 and 2). As shown in Figure 4.27, the cooling canal system consists of 32 parallel canals that carry warm water from the condenser and eight parallel canals that return cooled water to the condenser inlets.

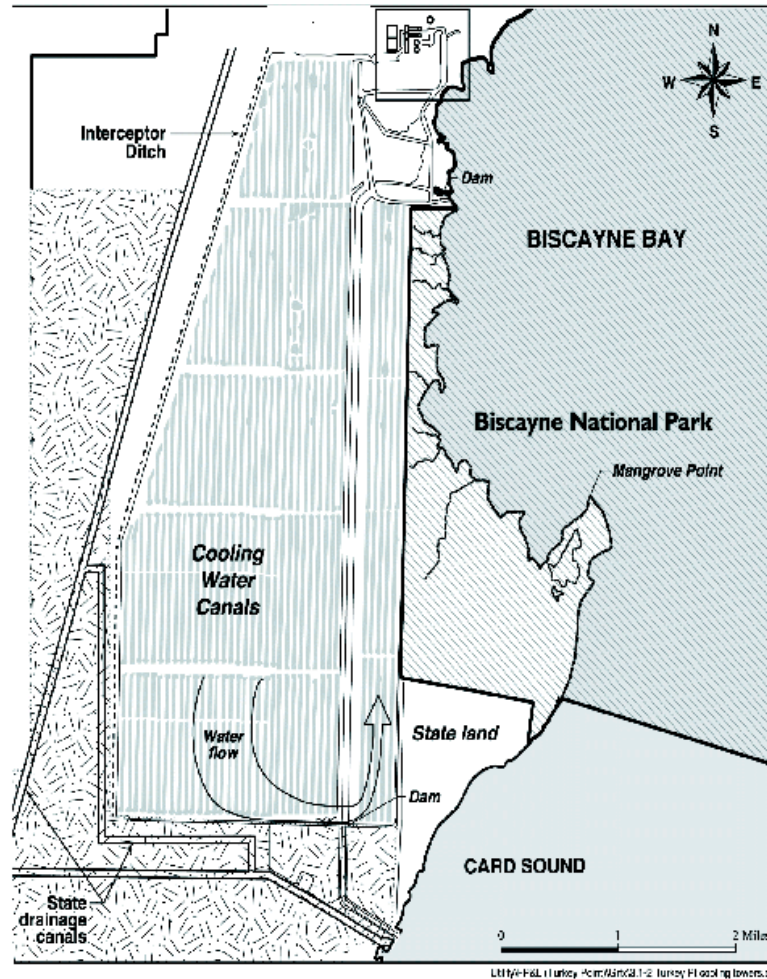

**Figure 4.27 Cooling Canal System at Turkey Point [Ref. 6.36]**

The cooling canals at Turkey Point are approximately 200 ft wide and are separated by 90 ft wide berms. The cumulative length of the canals is about 168 miles with an effective surface area of 3860 acres. Flow to the canals from Units 3 and 4 is approximately 1,300,000 gpm [Ref. 6.36]. The residence time in the canals is about 40 hours, during which time the water temperature drops to within 3 to 4°F of the adjoining Biscayne Bay's ambient temperature [Ref. 6.75]. A cooling canal system at IPEC would require less surface area than the cooling canal system at Turkey Point due to the significant difference in ambient conditions at the two sites.

The heat removal performance of a cooling canal system at IPEC is expected to be similar to a cooling pond system because each system utilizes surface evaporation as the primary mode of heat removal. Based on the heat removal performance of cooling pond systems as described in Section 4.7.1, a minimum of 320 acres of evaporative surface area would be required for the heat rejection loads of a single Unit and approximately 650 acres would be required for the heat rejection loads of Units 2 and 3 combined. The total land area necessary for a cooling canal system would likely be larger than the calculated surface area because a cooling canal system would require a system of parallel canals similar to that of Turkey Point. Applying the ratio of total land area compared to the evaporative surface

area at Turkey Point (1.74) to the calculated evaporative surface areas required at IPEC indicates that approximately 560 acres (Unit 2 or Unit 3) or 1120 acres (Units 2 and 3 combined) of land area would be required for a cooling canal system at IPEC.

### Conclusions

As discussed in Section 4.7.2, only 115 acres are currently available for use at IPEC because most of the site is already occupied. As such, the land area required for a closed re-circulating cooling canal system would be much greater than the land area available at IPEC. Therefore, the use of closed re-circulating cooling canals at IPEC is not further considered.

## 4.7.4 In-River Heat Exchangers

In-river heat exchangers are not considered as viable alternatives to the current screening systems at the Stations, because the use of in-river heat exchangers would be expected to present significant thermal biological issues.

In-river heat exchangers are a form of closed-loop cooling, whereby heat is rejected directly to the source water body without drawing an intake flow. As shown in Figure 4.28, an in-river heat exchanger works in three stages. First, the circulating water pump draws cold water across the condenser, condensing the main steam and increasing the temperature of the closed-loop flow. The hot recirculating water is then pumped from the condenser through a series of heat exchangers submerged in the source waterbody (i.e., in-river heat exchanger). The in-river heat exchanger allows heat to pass directly from the closed-loop cooling water to the flow of the river, and thus cool the closed-loop flow. After the circulating water has been cooled, it is drawn back to the condenser to close the cooling loop.

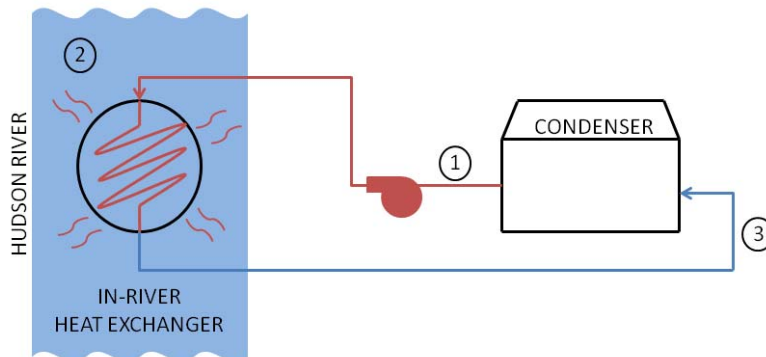

**Figure 4.28 Conceptual Diagram of In-River Heat Exchanger System**

At the Stations, in-river heat exchangers would encounter several site specific design challenges which would need to be addressed prior to determining feasibility. First, because the Hudson River is an estuary, the flow ebbs and floods and thus would not provide a constant cooling capacity, which would affect the operation of each Unit. During the transition periods between ebb and flood river flow (slack tide), the cooling capability of the in-river heat exchanger would be greatly reduced. Second, the in-river heat exchanger would need to be constructed of a material that would not corrode in the brackish Hudson River water. Materials suitable for use in brackish water typically are

more expensive and have a lower thermal conductivity than materials used in freshwater sources. Third, the in-river heat exchanger temperature would exceed the maximum SPDES plant discharge temperature permit limits [Ref. 6.86], particularly during slack tide.

Traditional cost-effective shell-and-tube heat exchangers seldom have temperature approaches less than 10°F [Ref. 6.77]. Because in-river heat exchangers at the Stations would not have a constant River cross flow rate and would be subject to corrosion and fouling performance limitations, it is assumed that in-river heat exchangers at the Stations would do no better than an approach of 10°F. However, this approach would be very optimistic based on the size required, operational considerations, and the variable flow conditions at the Stations. Complex heat exchanger configurations exist that could increase heat exchanger performance; however, the use of such configurations at IPEC would be limited by significant operational issues, including excessive fouling and pumping requirements. Lack of sufficient flow across the in-river heat exchangers could also lead to increased condenser back pressures and potential unplanned reactor shutdowns.

Based on historical river data collected at the Stations from 2001-2008, the maximum measured daily average circulating water inlet temperature is 83.8°F. At the maximum river temperature, the assumed 10°F temperature approach would result in a 93.8°F condenser inlet temperature. Similar to current once-through operation, the in-river heat exchanger system would be designed with a 17°F temperature rise over the condenser, based on the condenser BTU rejection requirements and 840,000 gpm flow rate. For context, at the maximum river temperature the condenser outlet temperature would be 110.8°F, exceeding the Stations' SPDES permit allowable discharge limit of 110°F [Ref. 6.86]. The in-river heat exchanger temperature would also exceed the SPDES permit limit of 93.2°F<sup>19</sup> between April 15 and June 30 for more than 15 days every year between 2001 and 2008, except 2003. Concurrently, the yearly average between 2001 and 2008 would exceed 10 days with an in-river heat exchanger temperature over 93.2°F.

### Conclusions

In comparison with the current once-through cooling design, an in-river heat exchanger system would inherently raise the condenser cooling water inlet and discharge temperatures. It is important to note that the in-river heat exchanger would require a large amount of surface area to dissipate the required heat load, and would create a large point source heat load in the Hudson River that would have no thermal dilution although heat dissipation through the Hudson River would occur. For context, the in-river heat exchanger temperature would exceed the maximum SPDES plant discharge temperature permit limits, particularly during periods of slack tide. In addition, operational issues associated with fouling and corrosion could present significant challenges. For these reasons, in-river heat exchanger closed-loop cooling systems would be expected to present

---

<sup>19</sup> Between April 15 and June 30, the maximum discharge temperature is limited by the SPDES permit to 93.2°F for an average of no more than ten days per year; provided that the daily average discharge temperature over this period does not exceed 93.2°F on more than 15 days in any year [Ref. 6.86].



significant thermal biological issues and are not further considered as alternatives to the current CWIS technologies.

## 5 Conclusions

Based on the feasibility and engineering evaluations documented in Section 4, Table 5.1 summarizes the various technologies and operational measures that were evaluated for biological compliance required by the NYSDEC in a draft modified SPDES permit.

**Table 5.1 Summary of Alternatives**

<b>Technology or Operational Measure</b>	<b>Comments</b>
<b>Existing CWIS Technologies and Operational Measures (Section 3)</b>	
Current Configuration	<p>Includes modified Ristroph-type traveling water screens, fish handling and return systems, low pressure screenwash systems, flow reductions due to dual/variable speed pump operation, flow reductions due to maintenance outages, and maintenance outage schedule considerations.</p> <p>Current reductions from Regulatory Baseline (Attachment 6):</p> <ul style="list-style-type: none"> <li>• EA1 Entrainment - approximately 33.8%</li> <li>• EA1 Impingement - approximately 80.2%</li> </ul>
<b>Fish Handling and Return Systems (Section 4.1)</b>	
Upgraded Fish Handling and Return System	<p>The existing fish return systems are considered to be state-of-the-art with respect to impingement losses and Siemens Water Technologies would not recommend any upgrades to the current fish return systems that would improve survivability rates.</p>
<b>Traveling Water Screens (Section 4.2)</b>	
Alternative Ristroph Screens (i.e., Ristroph screens with different mesh opening sizes than the mesh opening size of the existing Ristroph-type TWSs)	<p>Potential Reductions from Regulatory Baseline (Attachment 6):</p> <ul style="list-style-type: none"> <li>• EA1 Entrainment - up to 34.9%</li> <li>• EA1 Impingement - approximately 80.2%</li> </ul> <p>Potential Costs (2.0 mm mesh size):</p> <ul style="list-style-type: none"> <li>• Initial Costs - approximately \$373 million capital costs and approximately 3.9 million to 6.3 million MW-hrs per Unit of lost generation due to the required construction outages</li> <li>• Annual Costs - At a minimum, maintenance costs required would be at least 4 times the costs required to maintain the existing coarse mesh TWSs</li> </ul> <p>None of the mesh sizes evaluated would be expected to significantly reduce EA1 entrainment or EA1 impingement over the current screening systems.</p>

**Table 5.1 Summary of Alternatives**

Technology or Operational Measure	Comments
Dual Flow Traveling Water Screens	<p>Potential Reductions from Regulatory Baseline (Attachment 6):</p> <ul style="list-style-type: none"> <li>• EA1 Entrainment - up to 34.9%</li> <li>• EA1 Impingement - approximately 80.2%</li> </ul> <p>Potential Costs (2.0 mm mesh size):</p> <ul style="list-style-type: none"> <li>• Initial Costs – approximately \$350 million capital costs and approximately 4.7 million to 6.3 million MW-hrs per Unit of lost generation due to the required construction outages</li> <li>• Annual Costs - At a minimum, maintenance costs required would be at least 3 times the costs required to maintain the existing coarse mesh TWSs</li> </ul> <p>None of the mesh sizes evaluated would be expected to significantly reduce EA1 entrainment or EA1 impingement over the current screening systems.</p>
Angled Traveling Screens / Modular Inclined Screens	<p>Potential Reductions from Regulatory Baseline:</p> <ul style="list-style-type: none"> <li>• Similar to dual flow screens or Ristroph screens</li> </ul> <p>Potential Costs (2.0 mm mesh size):</p> <ul style="list-style-type: none"> <li>• Initial Costs - would be significantly higher than the costs associated with dual flow screens or Ristroph screens</li> <li>• Annual Costs - At a minimum, maintenance costs required would be 4 to 5 times the costs required to maintain the existing coarse mesh TWSs</li> </ul> <p>None of the mesh sizes evaluated would be expected to significantly reduce EA1 entrainment or EA1 impingement over the current screening systems.</p>
WIP Screens	<p>Potential Reductions from Regulatory Baseline:</p> <ul style="list-style-type: none"> <li>• Similar to dual flow screens or Ristroph screens</li> </ul> <p>Potential Costs (2.0 mm mesh size):</p> <ul style="list-style-type: none"> <li>• Initial Costs - would be significantly higher than the costs associated with dual flow screens or Ristroph screens</li> <li>• Annual Costs - At a minimum, maintenance costs required would be approximately 10 times the costs required to maintain the existing coarse mesh TWSs</li> </ul> <p>None of the mesh sizes evaluated would be expected to significantly reduce EA1 entrainment or EA1 impingement over the current screening systems.</p>
MultiDisc <sup>®</sup> Screens	<p>Potential Reductions from Regulatory Baseline:</p> <ul style="list-style-type: none"> <li>• Similar to dual flow screens or Ristroph screens</li> </ul> <p>Potential Costs (2.0 mm mesh size):</p> <ul style="list-style-type: none"> <li>• Initial Costs - would be significantly higher than the costs associated with dual flow screens or Ristroph screens</li> <li>• Annual Costs - At a minimum, maintenance costs required would be approximately 6 times the costs required to maintain the existing coarse mesh TWSs</li> </ul> <p>None of the mesh sizes evaluated would be expected to significantly reduce EA1 entrainment or EA1 impingement over the current screening systems.</p>

**Table 5.1 Summary of Alternatives**

Technology or Operational Measure	Comments
Passive Intake Systems (Section 4.3)	
Cylindrical Wedgewire Screens	<p>Potential Reductions from Regulatory Baseline (Through-Slot Velocity of 0.5 fps) (Attachment 6):</p> <ul style="list-style-type: none"> <li>• EA1 Entrainment - up to 89.8%</li> <li>• EA1 Impingement - approximately 99.9%</li> </ul> <p>Potential Costs:</p> <ul style="list-style-type: none"> <li>• Initial Costs <ul style="list-style-type: none"> <li>• approximately \$41.7 million for 2.0 mm screens, and approximately \$36.5 million for 9.0 mm CWW screens for a through-slot velocity of 0.5 fps</li> <li>• approximately \$63.3 million for 2.0 mm screens, and approximately \$52.0 million for 9.0 mm CWW screens for a through-slot velocity of 0.25 fps</li> <li>• resolution of unknown factors associated with the conceptual CWW system design would be required during the detailed design phase; these factors could, increase the total cost of implementing CWW screen systems to more than \$100 million</li> <li>• approximately 33,000 to 46,000 MW-hrs of lost generation due to the CW pump pit excavation and construction</li> </ul> </li> <li>• Annual Costs - At a minimum, maintenance costs would include the costs required to maintain the existing coarse mesh TWSs, the new airburst systems, and the new stop log systems, as well as the additional cost of divers as needed to clean/maintain the CWW screens</li> </ul> <p>In order to determine the optimal slot size for the Stations, a site-specific study would be required. A three-year site-specific engineering and biological effectiveness study would also be required to determine the optimum slot width for reducing EA1 entrainment losses at which fouling would not be a concern.</p>
Perforated Pipe Inlets	Perforated pipe intakes are obsolete and are have more engineering and operational difficulties than cylindrical wedgewire screens.
Porous Dikes / Leaky Dams	Porous dikes/leaky dams are not considered as viable alternatives to the current screening systems at the Stations due to nuclear safety concerns associated with possible clogging and reduced flow to safety-related SW pumps and the unproven nature of the technology at nuclear generating facilities.

**Table 5.1 Summary of Alternatives**

<b>Technology or Operational Measure</b>	<b>Comments</b>
<b>Barrier Technologies (Section 4.4)</b>	
Aquatic Filter Barriers	<p>Potential Reductions from Regulatory Baseline (Attachment 6):</p> <ul style="list-style-type: none"> <li>• EA1 Entrainment - approximately 90.2%</li> <li>• EA1 Impingement - approximately 90.4%</li> </ul> <p>Potential Costs:</p> <ul style="list-style-type: none"> <li>• Initial Costs - approximately \$67.4 million capital costs</li> <li>• Annual Costs - At a minimum, annual costs required would be approximately \$3 million for the O&amp;M and seasonal deployment, removal, and repair, not including the costs required to maintain the existing coarse mesh TWSs</li> </ul> <p>Aquatic filter barriers are not considered as the primary alternatives to the current intake screening system due to nuclear safety challenges associated with possible entanglement and reduced flow to safety-related SW pumps.</p>
Fish Barrier Nets	Fish barrier nets are not considered as viable alternatives to the current screening systems due to nuclear safety challenges associated with possible entanglement and reduced flow to safety-related SW pumps and the lack of comparable reductions to closed-loop cooling or other alternative technologies.
Behavioral Barriers (Light Guidance System, Acoustic Deterrents, Air Bubble Curtains, Electrical Barriers)	Behavioral barriers are potentially technologically feasible, but additional study would be required because previous studies of behavioral barriers performed at the Stations and other sites have been inconclusive or have shown no significant reduction in impingement or entrainment. A site-specific study would be required to provide the optimal type, location, and configuration of any behavioral barriers.
Louver System	Louver systems are potentially technologically feasible, but additional study would be required to produce an optimized design for the Stations and determine the biological benefits. However, based on previous studied a louver system would not be expected to provide any appreciable reductions to entrainment or impingement.
<b>Alternate Intake Location (Section 4.5)</b>	
Alternate Intake Location	Retrofit to an alternative intake location is potentially technologically feasible, but additional study would be required because IPEC site-specific biological information does not provide the optimal location or depth for an offshore intake.
<b>Flow Reduction (Section 4.6)</b>	
Dual / Variable Speed Pumps	The maximum available reductions from baseline in EA1 entrainment and impingement associated with reductions in the design flow rates would be approximately 49.9% and 85.0%, respectively. These reductions would not be comparable to those potentially achievable by conversion to closed-loop cooling, and a significant cost would be associated with the active power reductions resulting from the flow reductions.

**Table 5.1 Summary of Alternatives**

<b>Technology or Operational Measure</b>	<b>Comments</b>
Use of Recycled Wastewater as Cooling Water	Use of recycled wastewater is technologically infeasible due to limited sources of grey water in the vicinity of IPEC.
Outage Timing	The maximum incremental reduction in EA1 entrainment (2.6%) and EA1 impingement (1.2%) would result from a shift in scheduled outage timing to September. As such, a change in the current schedule outage timing is not further considered as an alternative to the current technologies and operational measures.
Radial Wells	Use of radial wells is technologically infeasible due to limited sources of available groundwater and land space at IPEC.
<b>Alternative Heat Rejection and Recirculation (Section 4.7)</b>	
Evaporation Ponds	Use of evaporative ponds is technologically infeasible due to limited land space at IPEC.
Spray Ponds	Use of spray ponds is technologically infeasible due to limited land space at IPEC.
Cooling Canals	Use of cooling canals is technologically infeasible due to limited land space at IPEC.
In-River Heat Exchangers	In-river heat exchanger closed-loop cooling systems would be expected to present significant thermal biological issues. For context, in-river heat exchanger temperatures would exceed the maximum SPDES plant discharge temperature permit limits, particularly during periods of slack tide.

As shown in Table 5.1, CWW screens have the potential to achieve reductions in I&E at the Stations comparable to the NYSDEC Proposed Project and are considered to be the primary alternative. As discussed in Section 4.3.1, cylindrical wedgewire screens have been implemented at a facility with a total intake flow rate comparable to the total intake flow rate at the Stations.<sup>20</sup>

Several conceptual cylindrical wedgewire screening array designs, each fitting within the Stations' exclusionary zone, were created. Although EPA typically recommends cylindrical wedgewire through-slot velocities at or below 0.5 feet per second (fps), NYSDEC has indicated interest in through-slot velocities at or below 0.25 fps. As such, separate conceptual cylindrical wedgewire screen systems were designed to provide a maximum through-slot velocity of at or below both 0.5 fps and 0.25 fps. The estimated capital costs associated with the installation of the conceptual CWW screen designs discussed in Section 4.3.1 would be:

- Approximately \$41.7 million for 2.0 mm screens, and approximately \$36.5 million for 9.0 mm CWW screens for a through-slot velocity of 0.5 fps.

<sup>20</sup> Oak Creek Power Plant in Milwaukee, Wisconsin operates the largest installation of cylindrical wedgewire screens, which includes an offshore intake system that filters a flow rate of 1,560,000 gpm. The cylindrical wedgewire screen system at Oak Creek became operational in January 2009 and is designed to operate year round.

- Approximately \$63.3 million for 2.0 mm screens, and approximately \$52.0 million for 9.0 mm CWW screens for a through-slot velocity of 0.25 fps.

As described in Section 4.3.1, several unknown factors associated with the conceptual CWW system design developed in this Report would require resolution during the detailed design phase. These factors could more than double the costs, increasing the total cost of implementing CWW screen systems to more than \$100 million. There would also be potentially 33,000 to 46,000 MW-hrs of lost generation due to the required CW pump pit excavation and construction for both Units. Each of the slot sizes evaluated would be expected to achieve comparable reductions in EA1 I&E to the NYSDEC Proposed Project. Specifically, operation of cylindrical wedgewire screens with a mesh size of 2.0 mm and through-slot velocity at or below 0.5 fps has the potential to reduce EA1 I&E from the regulatory baseline by as much as approximately 99.9% and 89.8%, respectively. In addition, according to Attachment 6, the estimated cumulative total reduction in EA1 I&E for CWW screens (98% and 87% for EA1 impingement and entrainment losses, respectively) would be greater than the estimated cumulative total reduction in EA1 I&E for the NYSDEC Proposed Project (86% and 50% for EA1 impingement and entrainment losses, respectively).<sup>21</sup> Because CWW screens with smaller slot sizes would create significant opportunity for fouling, slot sizes ranging from 2.0 mm to 9.0 mm were selected for initial evaluation in an attempt to minimize both entrainment and fouling. Before cylindrical wedgewire screens can be implemented at the Stations, a site-specific study would be required to determine the optimal slot width for reducing entrainment at which fouling would not be a concern.

---

<sup>21</sup> For the cumulative benefits analysis, the installation schedule for CWW screens is consistent with a proposal based on studies of the technology, as discussed in Attachment 6. The installation schedule for the NYSDEC Proposed Project was derived by ENERCON [Ref. 6.22] with input from counsel to Entergy and Spectra Energy Transmission (owner of the gas pipeline that would have to be re-located in order to construct the NYSDEC Proposed Project).

## 6 References

- 6.1 40 CFR Part 125. Code of Federal Regulations, Title 40, Protection of Environment, Part 125, Criteria and Standards for the National Pollutant Discharge Elimination System.
- 6.2 American Society of Civil Engineers. Design of Water Intake Structure for Fish Protection. 1982.
- 6.3 ASA Analysis & Communication, Inc. Gunderboom MLES<sup>TM</sup> Evaluation Study at the Lovett Generating Station, January 2006.
- 6.4 Blumberg, A.F., “Hydrodynamics of the Hudson River Estuary.” American Fisheries Society Symposium 51, September 18, 2006.
- 6.5 Blumberg, A.F., Dunning, D.J., Li, H., Heimbuch, D, and Geyer, W.R. “Use of a Particle-tracking Model for Predicting Entrainment at Power Plants on the Hudson River.” Estuaries. Vol. 27. No. 3. pp. 515-526. 2004.
- 6.6 Carolina Power & Light. Brunswick Nuclear Plant. 2000 Environmental Monitoring Report. August 2001.
- 6.7 Carolina Power & Light. Brunswick Nuclear Plant. Updated FSAR, Units 1 and 2. Rev. 21.
- 6.8 Central Hudson Gas & Electric Corp. Consolidated Edison Company of New York, Inc., New York Power Authority, and Southern Entergy New York. Draft Environmental Impact Statement. December 1999.
- 6.9 Consolidated Edison Company of New York, Inc. and New York Power Authority. Document Number IP-RPT-04-00270. Indian Point Units 2 and 3 Ristroph Screen Return System Prototype Evaluation and Siting Study. November 1992.
- 6.10 Curtin, M., Acoustic Barriers for Grass Carp. Proceedings of the Grass Carp Symposium. Gainesville, FL. 1994.
- 6.11 Dragos, P. and W. R. Geyer. Entrainment of passive particles into Hudson River power plants: Data report for the low-discharge condition survey. Prepared for Orange and Rockland Utilities, Inc., Pearl River, NY. Prepared by Coastal Oceanographic Associates, Sandwich, Massachusetts. 1998.
- 6.12 Electric Power Research Institute. Beaudrey Water Intake Protection (WIP) Screen Pilot-Scale Impingement Survival Study. Technical Report 1018490. Palo Alto, CA. 2009.
- 6.13 Electric Power Research Institute. Biological Evaluation of a Modular Inclined Screen for Protecting Fish at Water Intakes. Technical Report 104121. Palo Alto, CA. 1994.



- 6.14** Electric Power Research Institute. Chapter 1: Traveling Water Screens. Technical Report 1011546. Palo Alto, CA. 2004.
- 6.15** Electric Power Research Institute. Chapter 22: Behavioral Methods, Fish Passage Manual Chapter Updates. Technical Report 1011448. Palo Alto, CA. 2004.
- 6.16** Electric Power Research Institute. Design Considerations and Specifications for Fish Barrier Net Deployment at Cooling Water Intake Structures. Technical Report 1013309. Palo Alto, CA. 2006.
- 6.17** Electric Power Research Institute. Field Testing of Behavioral Barriers for Fish Exclusion at Cooling Water Intake Systems. CS-5995. Palo Alto, CA. 1988.
- 6.18** Electric Power Research Institute. Fish Protection at Cooling Water Intakes: Status Report. Technical Report 114013. Palo Alto, CA. 1999.
- 6.19** Electric Power Research Institute. Laboratory Evaluation of an Aquatic Filter Barrier (AFB) for Protecting Early Life Stages of Fish. Technical Report 1005534. Palo Alto, CA. December 2004.
- 6.20** Electric Power Research Institute. Laboratory Evaluation of Wedgewire Screens for Protecting Early Life Stages of Fish at Cooling Water Intakes. Technical Report 1005339. Palo Alto, CA. May 2003.
- 6.21** Empire State Electric Energy Research Corporation: New York Power Authority, Normandeau Associates, Inc., Sonalysts, Inc. Acoustic Fish Deterrents Research Report. EP 89-30. April 1991.
- 6.22** Enercon Services, Inc. Engineering Feasibility and Costs of Conversion of Indian Point Units 2 and 3 to a Closed-Loop Condenser Cooling Water Configuration. 2010.
- 6.23** Entergy Arkansas, Inc. Arkansas Nuclear One Units 1 and 2. Safety Analysis Report. Amendment 22.
- 6.24** Entergy Nuclear Operations, Inc. “Applicant’s Environmental Report, Operating License Renewal Stage (Appendix E to Indian Point, Units 2 & 3, License Renewal Application).” ADAMS Accession No. ML071210530. April 23, 2007.
- 6.25** Entergy Nuclear Operations, Inc. Procedure EN-DC-114. Project Management. Rev. 10. June 12, 2009.
- 6.26** Environment Agency, “Screening for Intake and Outfalls: A Best Practice Guide”, Science Report SC030231, February 2005, pp. 88-90.
- 6.27** Envirex, Inc., Fine Screen Evaluation, January 19, 1993.
- 6.28** Feist, B.E., Anderson, J.J. Review of Fish Behavior in Response to Fish Guidance Systems. Fisheries Research Institute. March 1991.

- 6.29** Fish Guidance Systems Ltd. Southampton, UK. <http://www.fish-guide.com>. Accessed January 29, 2010.
- 6.30** Flash Technology, an SPX Division. Lighting: Products. 2008. <http://flashtechonology.com/lighting/products>. Accessed January 29, 2010.
- 6.31** Fletcher, R. I. A Review of Reported Fine Mesh Screen Applications for High Volume Water-Intake Systems and Recommendations for Further Investigations. July 1990.
- 6.32** Fletcher, R. I. Comments of Fine-Mesh Investigations as Reported in the Draft Environmental Impact Station. January 1994.
- 6.33** Fletcher, R. I. Flow Dynamics and Fish Recovery Experiments: Water Intake Systems, Transactions of the American Fisheries Society. Vol. 119. No. 3. pp. 393-415. May 1990.
- 6.34** Fletcher, R. I. Hydraulic and Mechanical Considerations, an Addendum to a Review of Reported Fine Mesh Screen Applications for High Volume Water-Intake Systems and Recommendations for Further Investigations. July 1990.
- 6.35** Fletcher, R. I. Risk Analysis for Fish Diversion Experiments: Pumped Intake Systems. 1985.
- 6.36** Florida Power and Light. Generic Environmental Impact Statement for License Renewal of Nuclear Plants, Turkey Point Plant, Units 3 and 4. NUREG-1437. Supplement 5. 2002
- 6.37** GZA GeoEnvironmental, Inc. Hydrogeologic Site Investigation Report. January 2009.
- 6.38** Heat Exchange Institute. Standards for Steam Surface Condensers. 10<sup>th</sup> Edition. 2006.
- 6.39** Heuer and Tomljanovich. A Study of the Protection of Fish Larva at Water Intakes using Wedge-Wire Screening. 1978.
- 6.40** Hudson River Settlement Agreement. Stipulation of Settlement and Judicial Consent Order, In the Matter of the Application of NRDC, Inc. v. NYSDEC et al., No. 6570-91. Sup. Ct. Albany. March 23, 1992.
- 6.41** Indian Point Energy Center. Document Number TS-Q-12.302. Vendor Manual, Traveling Water Screens – IP2 Circ. Water Screens 21 to 26. Envirex Inc. Rev. 3. 1998.
- 6.42** Indian Point Energy Center. Condenser Data Sheets. Foster Wheeler Energy Corporation. FW Contract Numbers 4-87-5883 and 4-87-4877.
- 6.43** Indian Point Energy Center. Drawing 138110-05. Concrete – Discharge Tunnel & Service Building Plan, Elevations, & Details. Rev. 5. 1959.

- 6.44** Indian Point Energy Center. Drawing 138113-10. Concrete – Discharge Tunnel Plan, Elevations, & Details, Sheet No. 3. Rev 10. 1978.
- 6.45** Indian Point Energy Center. Drawing 9321-F-10073.04. Construction Sheet Piling Layout. Rev. 4. 2001.
- 6.46** Indian Point Energy Center. Drawing 9321-F-1010, Intake Structure Concrete – Bottom Slab Plan. Rev. 11.
- 6.47** Indian Point Energy Center. Drawing 9321-F-10103, Intake Structure Concrete – Bottom Slab Plan. Rev. 3.
- 6.48** Indian Point Energy Center. Drawing 9321-F-1012-14. Intake Structure Concrete – Plan Thru Walls. Rev. 14. 2001.
- 6.49** Indian Point Energy Center. Drawing 9321-F-1013-18. Intake Structure Concrete – Cross Sections. Rev. 18. 2001.
- 6.50** Indian Point Energy Center. Drawing 9321-F-1111-06. Discharge Water Tunnel West Portion, Sheet No. 1. Rev. 6. 2001.
- 6.51** Indian Point Energy Center. Drawing 9321-F-1114-3. Discharge Water Tunnel East Portion, Sheet No. 2. Rev. 3. 1973.
- 6.52** Indian Point Energy Center. Drawing 9321-F-11143-01. Discharge Water Tunnel East Portion, Sheet No. 2. Rev. 1. 1975.
- 6.53** Indian Point Energy Center. Drawing 9321-F-13333-03. Discharge Canal Plan and Permanent Sheet Piling Bulkheads. Rev. 3. 1975.
- 6.54** Indian Point Energy Center. Drawing 9321-F-20010. Ristroph Traveling Screens Intake Structure Fish & Debris Troughs Plans. Rev. 3. 2001.
- 6.55** Indian Point Energy Center. Drawing 9321-F-20011. Ristroph Traveling Screens Intake Structure Fish & Debris Troughs Elevs, Sections & Details Mechanical. Rev. 1. 1993.
- 6.56** Indian Point Energy Center. Drawing A182528 and A182529, Indian Point 1, 2, & 3 Screen Wash Water Sluice Flume Plans.
- 6.57** Indian Point Energy Center. Drawing D169372-12. Riverwater Cooling Water and Service Water System – Unit #1. Rev. 12. 1965.
- 6.58** Indian Point Energy Center. Indian Point 2. Service Water System Operation, 2-SOP 24.1. Rev. 56. 2005.
- 6.59** Indian Point Energy Center. Indian Point 2. System Description 24.0, Service Water Systems.

- 6.60** Indian Point Energy Center. Indian Point 2 UFSAR. Rev. 21. 2008.
- 6.61** Indian Point Energy Center. Indian Point 3. Procedure 3-SOP-RW-002. Intake Structure Operation. Rev. 24. 2008.
- 6.62** Indian Point Energy Center. Indian Point 3. System Description 22. Intake Structure. Rev. 4. 2005.
- 6.63** Indian Point Energy Center. Indian Point 3. System Description 23.0 – Circulating Water System. Rev. 4.
- 6.64** Indian Point Energy Center. Indian Point 3 UFSAR. Rev. 3. 2009.
- 6.65** Indian Point Energy Center. Procedure 2-ARP-SDF. Turbine Recorder. Rev. 24. 2007.
- 6.66** Indian Point Energy Center. Procedure 3-ARP-007. Panel SDF – Turbine Recorder. Rev. 27. 2009.
- 6.67** Institute of Nuclear Power Operations. SOER 07-2 Intake Cooling Water Blockage. December 2007.
- 6.68** James A. Fitzpatrick Nuclear Power Plant (JAF), Updated Final Safety Analysis Report Update. 2007.
- 6.69** Ketschke, B.A. “Use of a Porous Dike to Reduce Entrainment and Entrapment in Power Plant Cooling Water Systems.” Coastal Zone '80 Vol. I. ASCE. New York. 1980.
- 6.70** Langford, T.E. Ecological Effects of Thermal Discharges. Springer. 1990.
- 6.71** LaSalle Hydraulic Laboratory, LTD. Hydraulic Model Study of Hudson River Flows Around Cooling Water Intakes. November 1976.
- 6.72** Lawler, Matuskey and Skelly Engineers, LLC, Lovett Generating Station Gunderboom Evaluation Program 1996, May 1997.
- 6.73** Lawler, Matuskey and Skelly Engineers, LLC, Lovett Generating Station Gunderboom Evaluation Program 1997, March 1998.
- 6.74** Lawler, Matuskey and Skelly Engineers, LLC, Lovett Generating Station Gunderboom Evaluation Program 1998, December 1998.
- 6.75** Laws, E.A., Aquatic Pollution: An Introductory Text. John Wiley and Sons. 2000.
- 6.76** Lawton, R.P., et al. Annual report on assessment and mitigation impact of the Pilgrim Nuclear Power Station on finfish populations in western Cape Cod Bay. Project Report No. 68 (Jan. – Dec. 1999). In: Marine Ecology Studies Related to the

- Operation of Pilgrim Station, Semiannual Report No. 55. Entergy Nuclear Generation Company, Plymouth, MA. 2000.
- 6.77** Lindeburg, M. R. Mechanical Engineering Reference Manual for the PE Exam. 12<sup>th</sup> Edition. Professional Publications, Inc. Belmont, CA. 2006.
- 6.78** Maes, J., et al. Field Evaluation of a Sound System to Reduce Estuarine Fish Intake Rates at a Power Plant Cooling Water Intake. *Journal of Fish Biology* 64 (2004): 938-946.
- 6.79** Marcellus, K.L., Young, J. Evaluation of the Effectiveness of Pneumatic Poppers to Reduce Fish Impingement at Indian Point Unit 2. Consolidated Edison Company of New York, Inc. October 1987.
- 6.80** National Estuarine Research Reserve System. Hudson River Bathymetry Depth in Meters. [http://hrnerr.org/public/Benthic/bathy/GE\\_hudson\\_bathy.html](http://hrnerr.org/public/Benthic/bathy/GE_hudson_bathy.html). Accessed January 29, 2010.
- 6.81** National Oceanic and Atmospheric Administration. Elevations on Station Datum, Haverstraw Bay, NY. Station ID 8518924. [http://tidesandcurrents.noaa.gov/data\\_menu.shtml?stn=8518924%20HAVERSTRAW%20BAY,%20NY&type=Datums,%20accessed%2018%20December%202009](http://tidesandcurrents.noaa.gov/data_menu.shtml?stn=8518924%20HAVERSTRAW%20BAY,%20NY&type=Datums,%20accessed%2018%20December%202009). Accessed December 18, 2009.
- 6.82** National Oceanic and Atmospheric Administration. Nautical Chart 12343. Edition 19. October 2005. <http://www.charts.noaa.gov/OnLineViewer/12343.shtml>. Accessed January 29, 2010.
- 6.83** Nebraska Public Power District. Applicant's Environmental Report, Operating License Renewal Stage, Cooper Nuclear Station (Appendix E to Cooper Nuclear Station, License Renewal Application). September 30, 2008.
- 6.84** NERA Economic Consulting. Economic Comments on Nuclear Regulatory Commission DSEIS for Indian Point Energy Center. March 2009.
- 6.85** New York Independent System Operator. Outage Schedule Manual. Rev. 2. November 2, 2004.
- 6.86** New York State Department of Environmental Conservation. New York State Pollutant Discharge Elimination System (SPDES) Discharge Permit. SPDES Permit Number: NY-0004472. Entergy Nuclear Indian Point Units #2 and #3 LLC.
- 6.87** New York State Department of Environmental Conservation. New York State Pollutant Discharge Elimination System (SPDES) Discharge Permit. SPDES Permit Number: NY-0020109. Entergy Nuclear FitzPatrick LLC.

- 6.88** New York State Department of Environmental Conservation. Final Environmental Impact Statement Concerning the Applications to Renew New York State Pollutant Discharge Elimination System (SPDES) Permits for the Roseton 1 & 2, Bowline 1 & 2, and Indian Point 2 & 3. Mitigation 7. Accepted June 25, 2003.  
<http://www.dec.ny.gov/permits/54649.html>. Accessed January 27, 2010.
- 6.89** New York State Department of Environmental Conservation. Fourth Amended Stipulation of Settlement and Judicial Consent Order, National Resources Defense Council, Inc. et. al. vs. New York State Department of Environmental Conservation and Consolidated Edison Company of New York, Inc, New York Power Authority, Orange and Rockland Utilities, Inc., and Central Hudson Gas and Electric Corp. 1997.
- 6.90** New York State Department of Environmental Conservation. Interim Decision of the Assistant Commissioner In the Matter of a Renewal and Modification of a State Pollutant Discharge Elimination System (“SPDES”) permit pursuant to Environmental Conservation Law (“ECL”) Article 17 and Title 6 of the Official Compilation of Codes, Rules and Regulations of the State of New York (“6 NYCRR”) Parts 704 and 750 et seq. by Entergy Nuclear Indian Point 2, LLC and Entergy Nuclear Indian Point 3, LLC, Permittee. DEC No: 3-5522-00011/00004. August 13, 2008.
- 6.91** New York State Department of Environmental Conservation: Stark, Lynette M. “Re: Determination of Best Technology Available for “Existing Facilities” in New York”. Letter to Benjamin Grumbles, United States Environmental Protection Agency. January 24, 2005.
- 6.92** New York State Energy Research and Development Authority. Annual report on Disposition of Real and Personal Property (April 1, 2006 – March 31, 2007), Pursuant to Section 2896 of the Public Authorities Law.
- 6.93** Normandeau Associates, Inc. Revised Study Plan to Perform Biological Monitoring to Assess Extension of the Cooling Water Intake Structure at the James A. FitzPatrick Nuclear Power Plant as Specified in SPDES Permit No. NY 0020109 (Effective 08/01/2008). April 2009.
- 6.94** Pankratz, Tom, P. Screening Equipment Handbook. Technomic Publishing Company, Inc. 1995.
- 6.95** Parkinson, F.E., and Goulet, F. “Hydraulic Model Study of Hudson River Flows Around Cooling Water Intakes”. La Salle Hydraulic Laboratory Report 682 for Consolidated Edison Company of New York. November 1976.
- 6.96** Passavant Geiger. Geiger MultiDisc® Screen Brochure. Karlsruhe, Germany. 2008.
- 6.97** Pfafflin, J.R. and Ziegler, E.N., Encyclopedia of Environmental Science and Engineering: Volume I. CRC Press. 2006.

- 6.98** Pilgrim Nuclear Power Station. Entergy Nuclear Generation Company. Marine ecological studies Pilgrim Nuclear Power Station Report 69. Report Period January 2006 – December 2006. 2007.
- 6.99** Raffenburg, Matthew J. et.al. Development of Filter Fabric Technology Determined to be BTA for Minimizing Environmental Impacts at Power Generating Facilities. 2002.
- 6.100** Ranney Collector Wells. <http://www.collectorwells.com/projects.html>. Accessed January 29, 2010.
- 6.101** Richards, R.T. and Hroncich, M.J. “Perforated Pipe Water Intake for Fish Protection.” Journal of the Hydraulics Division. ASCE. Vol. 102 No. HY 2. pp 136-149. February 1976.
- 6.102** Rooks, J. A., and Wallace, A. K. Energy Efficiency of VSDs. IEEE Industry Applications Magazine. Pp. 57-61. May/June 2004.
- 6.103** Saxon, G., Jr., and Howell, A. The Practical Application & Innovation of Cleaning Technology for Condensers. ASME Power Division Special Section. August 2005.
- 6.104** Smith-Root, Inc. Electric Barriers and Guidance Systems. 2007. <http://www.smith-root.com/barriers>. Accessed January 29, 2010.
- 6.105** South Texas Project Nuclear Operating Company. South Texas Project Units 3 and 4 COLA Environmental Report. 2008.
- 6.106** Spraying Systems Co. Spray Ponds for Cooling and Evaporation. Technical Manual No. 401A.
- 6.107** Taft, E., Garnett, G., Amaral, S. Alden Research Laboratory, Fish Protection Technologies: Status Report. Presented at EPRI Power Generation Impacts on Aquatic Resources Conference. April 1999.
- 6.108** Texas Instruments Incorporated Ecological Services. Indian Point Impingement Study Report for the Period 15 June 1972 through 31 December 1973. December 1974.
- 6.109** Texas Instruments Incorporated Ecological Services. Indian Point Impingement Study Report for the Period 1 January 1974 through 31 December 1974. November 1975.
- 6.110** Tomichek, C. Evaluation of Angled Bar Racks and Louvers for Guiding Fish at Water Intakes. October 2001.
- 6.111** United Engineers & Constructors Inc. Indian Point Unit No. 2 Ristroph Screen Debris/Fish Return System Discharge Site Feasibility Study. November 1992.
- 6.112** United States Army Corps of Engineers. Ice Blockage of Intake Trash Racks. Cold Regions Technical Digest. No. 91-1. March 1991.

- 6.113** United States Department of Energy. Cost Estimating Guide. Publication No. DOE G 430.1-1. March 28, 1997.
- 6.114** United States Environmental Protection Agency, 40 CFR Parts 9, 122, 123, et al., National Pollutant Discharge Elimination System; Cooling Water Intake Structures for New Facilities; Proposed Rules.
- 6.115** United States Environmental Protection Agency. Technical Development Document for the Final Section 316(b) Phase II Existing Facilities Rule. Washington, DC. February 12, 2004.
- 6.116** United States Fish and Wildlife Service. Significant Habitats and Habitat Complexes of the New York Bight Watershed, Hudson River Estuary, Habitat Complex 32, Lower Hudson River. 1997.
- 6.117** United States Geological Survey. Ground Water Atlas of the United States, Segment 12. 1995.
- 6.118** United States Geological Survey. National Wetlands Research Center Digital Library. Species Profiles: Life Histories and Environmental Requirements of Coastal Fishes and Invertebrates – List by Species Name. <http://www.nwrc.usgs.gov/publications/specindex.htm#S>. Accessed January 29, 2010.
- 6.119** United States Nuclear Regulatory Commission. Generic Environmental Impact Statement for License Renewal of Nuclear Plants Supplement 38 Regarding Indian Point Nuclear Generating Unit Nos. 2 and 3 Draft Report for Comment, NUREG-1437 Volume 1 Supplement 38. December 2008
- 6.120** United States Nuclear Regulatory Commission. Pressurized Water Reactor (PWR) Systems, “Nuclear Reactor Concepts” Workshop Manual. <http://www.nrc.gov/reading-rm/basic-ref/teachers/04.pdf>. Accessed January 29, 2010.
- 6.121** Wang, L., Pereira, N., Hung, Y, and Li, K. Advanced Air and Noise Pollution Control. Volume II. Springer. 2004.



# Exhibit 3



UNITED STATES ENVIRONMENTAL PROTECTION AGENCY

WASHINGTON, D.C. 20460

June 17 1975

OFFICE OF ENFORCEMENT

MEMORANDUM

TO: Bruce P. Smith, Biologist  
Enforcement Division, Region III

FROM: J. William Jordan, Chemical Engineer (EG-336)  
Permit Assistance & Evaluation Division

SUBJECT: Response to Request for Interpretation of the Chemical  
Effluent Limitation Guidelines for the Steam Electric  
Power Generation Industry

I apologize for the delay in responding to your request for an interpretation of the chemical guidelines, but I was unable to schedule a meeting with DeVereaux Barnes, Power Plant Guidelines Project Officer, until this week. Dev and I discussed the problem extensively. The following paragraphs outline our discussions regarding the application of iron and copper limitations on discharges from ash ponds and three alternative approaches are offered for determining compliance with these guidelines.

In regard to your question on the 10-year, 24-hour rainfall event, the only comment that we have at this time (and this is only an "off-the-top-of-the-head" comment) is that in using the 10-year, 24-hour stipulation in the guidelines, it should be assumed that the rainfall is continuous throughout the 10-hour period. Dev indicated to me that other questions similar to this have been raised both for the Steam Electric Power Generation industry and other industries like the Fertilizer industry, and that records of these questions and responses are being kept by the Regional Desk in the Effluent Guidelines Division. I would suggest that you call the Regional Desk and get copies of this correspondence (202-426-2571) which will give a more detailed explanation.

The case described in your correspondence where several discharges are being made to the ash pond (in your example the discharges were metal cleaning wastes, boiler blowdown, and ash sluice water) there are at least three ways of placing requirements on these discharges in the permitting process. Before entering into this explanation, it should be

restated that iron and copper limits apply to metal cleaning wastes and boiler blowdown but not to ash sluice water. Total suspended solids are, however, limited for the ash sluice discharge stream. The example provided in your correspondence appears to be using an iron concentration for the ash sluice water prior to adequate treatment for the total suspended solids. One of the conclusions from our discussions this week was that even though there is no specific limitation for iron in ash sluice water, the concentration used for calculating a quantity limitation for this discharge stream should be that concentration after adequate treatment for the total suspended solids.

The following indicates three possible alternative approaches which should be satisfactory for determining compliance with the chemical effluent limitation guidelines. The examples assume that metal cleaning wastes, boiler blowdown, and ash sluice water are all discharged to the ash pond prior to a final ash pond discharge to the receiving water body. The recommended approaches are:

1. If the metal cleaning waste and boiler blowdown are adequately treated down to 1 mg/l prior to discharge to the ash pond, then this would be satisfactory for assuring compliance with the iron and copper limitation guidelines. Internal monitoring on the discharge from the treatment system for these two waste streams prior to discharge to the ash pond, could be used to demonstrate compliance with the guidelines. In this case, it would not be necessary to monitor for iron and copper in the discharge from the ash pond unless it was felt that this was necessary to monitor for compliance with water quality standards.
2. If an applicant makes a satisfactory demonstration that, because of the alkalinity and retention time of the ash pond, adequate treatment of the iron and copper is being carried out in the ash pond, then it may be acceptable to allow use of the ash pond for treatment of the iron and copper. An example of a fossil fuel power plant whose ash pond does adequately treat all of the waste streams is attached. In this particular example (see the results of the sampling analysis) there is actually less iron and copper in the discharge from the ash pond than was contained in the intake water to the power plant (in other words, a "negative net"). The efficiency of this treatment is attributable to the high alkalinity in the pond as well as 100 days retention time.

3. A more general situation where the applicant may use the ash pond as his treatment device should be discussed. In order to establish a final iron and copper limit on the discharge from the ash pond, it is recommended that the following procedure be used: the flows of the metal cleaning wastes and the boiler blowdown should be multiplied by 1 mg/l to obtain the quantity limitation from these sources. Since there are no iron and copper limits for ash sluice water, the iron and copper concentrations to use in calculating the total quantity limit for ash sluice water must be determined. As previously mentioned in the third paragraph, Dev and I feel that the applicant must determine what the concentration of iron and copper is or would be in the ash sluice water after the ash sluice water is in compliance with the total suspended solids limitation (30 mg/l). An example\* of how this third approach might work for the iron quantity limit is illustrated below:

Metal Cleaning Wastes and Boiler Blowdown

$$(4MGD) (1mg/l) (8.34lbs/gal) = 33.4lbs/day$$

Ash Sluice Water

Initially contains TSS = 300 mg/l and Fe = 40 mg/l. After treating TSS to 30 mg/l, the Fe is reduced to 4 mg/l (assumes all iron tied up in TSS).

$$(4MGD) (4mg/l) (8.34lbs/gal) = 133.6 lbs/day$$

Allowable Discharge of Iron from Ash Pond

$$33.4 lbs/day + 133.6 lbs/day = 167.0 lbs/day$$

In regard to the question on distinguishing between metal cleaning and low volume wastes, the following clarification is offered. All water washing operations are "low volume" while any discharge from an operation involving chemical cleaning should be included in the metal cleaning category.

\*Note that intake concentrations do not add intake concentrations if a net limit is allowed for iron. The Guidelines Development Document recommends "zero" net for TSS from ash ponds.

We are forwarding copies of this response to the other Regional Offices of EPA. If you have any questions on the above explanations, or if we receive any comments or questions from the other Regional Offices, revisions and/or additions will be forwarded to all ten Regions. I have also attached a copy of some proposed examples prepared by the NUS Corporation and revised by us at Headquarters which may provides some insight into the problem. When these examples are finalized, they will also be forwarded to all Regional Offices.

Thank you again for bringing this problem to our attention.

J. William Jordan

Attachments

cc: R. Schaffer  
C. Schafer  
D. Barnes  
B. Jordan  
R. Irvin  
D. Browne  
R. Chase, Reg. I  
H. Lunenfeld, Reg. II  
C. Kaplan, Reg. IV  
G. Milburn, Reg. V  
F. Humpke, Reg. VI  
R. Langemeier, Reg. VII  
R. Burns, Reg. VIII  
M. Mahor, Reg. IX  
R. Stannis, Reg. X

Appendix IV(B)  
Letter to Bill Jordan from Bruce Smith  
re Jordan Memorandum (1975)



UNITED STATES ENVIRONMENTAL PROTECTION AGENCY

REGION III

6TH AND WALNUT STREETS  
PHILADELPHIA, PENNSYLVANIA 19106

In reply refer to -  
3EN21

May 21, 1975

Mr. Bill Jordan           EG 336  
Environmental Protection Agency  
Crystal Mall 2           Room 706  
Washington, D.C.         20460

Dear Bill:

Certain aspects of the Development Document for Steam Electric Power Plants are open to various interpretations and as such, have had an adverse affect on the design and scheduling of suitable treatment facilities needed to comply with guideline limitations. I will attempt to outline two of these problem areas and offer solutions, but the main intent of this letter is to obtain written clarification from headquarters on these issues.

Table A-X-1 on page 416 of the Development Document calculates the allowable iron limitation in kg/day for the boiler blowdown and metal cleaning waste source categories and then adds the following footnote to the limitation: "+ Note: Plus effluent from sources with no limitation". This footnote is somewhat vague, and no further explanation is offered in the main text of the Development Document. Some power companies have interpreted this footnote to mean that in a situation where metal cleaning wastes are dumped into an ash basin, the final effluent limitation in lbs/day from the ash basin is calculated from adding the normal lbs/day of iron contained in the ash sluice water with the allowable lbs/day of iron for the metal cleaning wastes, i.e.:

metal cleaning wastes

2 mgd flow X 1 ppm Fe allowable X 8.34 lbs/gal = 16.7 lbs/day

ash sluice water

4 mgd flow X 100 ppm Fe normal X 8.34 lbs/gal = 3336 lbs/day

allowable discharge of iron from basin

16.7 lbs/day + 3336 lbs/day = 3352.7 lbs/day

I cannot believe this interpretation is consistent with the intent of the guidelines or the Development Document. Iron in ash sluice water is associated with the ash particles, and an ash basin may attain 50% or better

removal of the ash particles from the ash sluice water prior to discharge. The total 3352.7 lbs/day permitted by the interpretation does not account for this removal and would allow an unrealistic and unacceptable level of pollution. I can find no indication in the Development Document that an ash pond constitutes acceptable treatment for metal cleaning wastes. Acceptable control or treatment technology for the iron or copper contained in metal cleaning wastes (as described in the Document) is generally not carried out in an ash pond.

I recommend that the footnote on page 416 be applied only after the effluent stream has been adequately treated to guideline levels, i.e., the discharger must treat a metal cleaning waste stream down to 1 mg/l for iron and copper before he can add it to the ash basin. If this interpretation is not acceptable, then the discharger should be required to demonstrate that the basin is capable of treating metal cleaning wastes down to 1 mg/l for iron and copper irrespective of any influence from the ash sluice waters. Headquarters should either delete this footnote or clarify its application.

There is some confusion as to what actually constitutes metal cleaning wastes. Many companies maintain that effluent streams that result exclusively from water washing of ash found on boiler fireside, air preheater, etc. should be considered in the low volume or ash transport waste source categories, while effluent streams resulting from cleaning processes involving any chemical solution (acid cleaning of boilers) should be considered in the metal cleaning waste source category. I am inclined to agree with the companies on this issue, but the guidelines clearly do not make such a distinction in the definition of metal cleaning wastes 423.11(j). The Development Document is very ambiguous on this issue. Chemical cleaning is distinguished from water cleaning on pages 136 to 148 of the Development Document. On page 410 of the Document, boiler and air heater cleaning and other equipment cleaning is included under the Low Volume Waste Waters Category (line 3), while on page 411 of the errata sheet, boiler fireside cleaning, air preheater cleaning, and miscellaneous equipment and stack cleaning is included under the Metal Cleaning Wastes Category. Headquarters should clarify why boiler cleaning was included in the Development Document under both the low volume waste source category and the metal cleaning waste source category. Headquarters should distinguish the type of cleaning that generates metal cleaning wastes and the type of cleaning that generates low volume wastes.

Your prompt attention to these issues is requested since future treatment designs will depend on your recommendations. With the publication of the Development Document, issues such as these may no longer be left to regional discretion.



For your general information, I have enclosed a diagram and general description of Pennsylvania Power and Light's proposed Iron Precipitation Detention Basin (IPDB) which is relatively cheap to construct and can treat iron down to levels near 0 ppm. Please note that in light of the footnote on table A-X-1 of the Document, they are now reconsidering the need for such a basin.

If there are any questions concerning this discussion, please don't hesitate to contact me at 215 597-8221.

Sincerely yours,

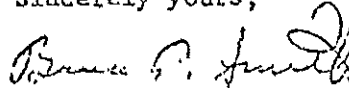

Bruce P. Smith  
Delmarva-D.C. Section

Enclosure

# Exhibit 4

NOTED JUL 09 1990 M.R.L.

UNITED STATES ENVIRONMENTAL PROTECTION AGENCY  
REGION I  
JOHN F. KENNEDY FEDERAL BUILDING  
BOSTON, MASSACHUSETTS 02203

FACT SHEET

DRAFT NATIONAL POLLUTANT DISCHARGE ELIMINATION SYSTEM (NPDES)  
PERMIT TO DISCHARGE TO WATERS OF THE UNITED STATES

NPDES PERMIT NO.: NH0001473

STATE PERMIT NO.:

NAME AND ADDRESS OF APPLICANT:

Public Service of New Hampshire  
Schiller Station  
1000 Elm Street  
P.O. Box 330  
Manchester, NH 03105

NAME AND ADDRESS OF FACILITY WHERE DISCHARGE OCCURS:

Schiller Station  
Gosling Road  
P.O. Box 150  
Portsmouth, NH 03801

RECEIVING WATER: Piscataqua River

CLASSIFICATION: Class B

I. Proposed Action, Type of Facility, and Discharge Location.

The above named applicant has applied to the U.S. Environmental Protection Agency for reissuance of its NPDES permit to discharge into the designated receiving water. The facility is engaged in electric power generation and distribution. The discharge is from once through cooling water, operational plant wastewater, process water, and coal pile runoff. The location of the discharges are shown on Attachment A.

II. Description of Discharge.

A quantitative description of the discharge in terms of significant effluent parameters based on data presented in the application and/or discharge monitoring reports is shown on Attachment B.

### III. Limitations and Conditions.

The effluent limitations of the draft permit, the monitoring requirements, and any implementation schedule (if required) may be found on Attachment D (Part I of Draft Permit).

### IV. Permit Basis and Explanation of Effluent Limitations Derivation.

Schiller Station is an electric generating facility with an approximate capacity of 200 megawatts (mw). Unit #3 is a steam driven, 25 mw generator that is fired with No. 6 fuel oil. Units #4, #5, and #6 are steam driven, 50 mw generators that are fired with either No. 6 fuel oil or bituminous coal. The fifth unit is a 24 mw combustion turbine fired with No. 1 fuel oil or natural gas.

Discharge include non-contact cooling water, operational plant wastewater, process water, and runoff, including coal pile runoff. Discharges are to the Piscataqua Estuary, a Class B waterway, with a latitude of 43° 05, 60" and a longitude of 70° 47' 00". Class B waters shall be of the second highest quality and shall have no objectionable physical characteristics, shall be near saturation for dissolved oxygen, and tidal class B waters shall not contain a coliform bacteria count greater than seventy (70) on an MPN basis. Class B waters shall be considered as being acceptable for bathing and other recreational purposes.

The Clean Water Act (CWA) establishes the national objective "to restore and maintain the chemical and biological integrity of the Nation's Waters". The CWA requires the EPA Administrator to establish effluent limitation which set forth the degree of reduction attainable through the application of best practicable control technology currently available (BPT), best conventional pollutant control technology (BCT), and best available technology economically achievable (BAT) (Section 301 and 304) for those industries for which national effluent guidelines have been promulgated. In addition, the effluent limitations must insure compliance with water quality standards as established by state law or regulation.

The effluent limitations presented in the permit are based on the Steam Electric Power Plant Guidelines (40 CFR 423) as promulgated on November 19, 1982 (47 Fed. Reg. 52290) and on the New Hampshire State Water Quality Standards. The limitations for the discharges given in Attachment D are designed to maintain the Piscataqua River as a Class B waterway in accordance with State requirements. The pH and oil and grease limitations have been established based on state certification requirements.

The chlorine effluent limitations presented in the permit are based on the effluent limitation guidelines. The guidelines state that total residual chlorine (total residual oxidants) may not be discharged from any single generating unit for more than two hours per day. Simultaneous multi-unit chlorination is permitted. The quantity of TRC discharged in once through cooling water from each discharge point shall not exceed a maximum concentration of 0.2 mg/l.

The permit compliance system (PCS) is the national data base for the NPDES program. As such, PCS promotes national consistency and uniformity in permit and compliance evaluations. To accomplish this goal, all required data are to be entered into and maintained regularly in PCS. PCS allows up to three (3) alphanumeric characters to designate an Outfall:, that is, four character designations will be truncated after the first three characters. To facilitate the PCS program the following outfalls will be redesignated as follows:

<u>Current Permit</u> <u>Outfall Designation</u>	<u>Draft Permit</u> <u>Outfall Designation</u>
001A	001
001B	015
012A	016 (normal operation)
012A	017 (metal cleaning operation)
012B	018
XXX	019
XXX	020
XXX	021
XXX	022

It should be noted that outfalls 16 and 17 are physically identical. Two designations are used to highlight the different monitoring frequencies between normal operations and operation during the time period when chemical waste from cleaning the boiler tubes enters the process waste treatment plant. Moreover, an additional discharge for each unit (#3, #4, #5, and #6) was recently identified. Each unit has travelling screens on the cooling water inlet to remove river debris. Under worse conditions, each set of screens are sequentially washed for one hour, six times per day. The maximum spray rate is 300 gpm which translates to a total of 108,000 gpd per unit. These outfalls are designated as XXX in the Form 2C application without designation in the current permit. They are designated as Outfalls 19, 20, 21, and 22 in the draft permit.

The following modifications of the current permit have been incorporated into the draft permit:

- o Outfall 001: Flow limits have been increased to allow for 24-hours operation. Also chlorine, ferrous sulfate limits and temperature rise limitations have been added to provide for condenser maintenance provisions.
- o Outfall 006: This outfall is now used for emergency purposes only. The outfall actually consists of 6 pipes; 2 pipes for each of unit numbers 4,5, and 6. The routine effluent that was previously discharged is now piped to the #7 Pit and ultimately to Water Treatment Plant #2. This discharge consists only of boiler blowdowns during an emergency condition or when a boiler experiences a severe disruption. According to the permittee these emergency conditions represent an unusual event that is generally short-lived. The outfall was not used last year.
- o Outfall(s) 007, 008, and 009: These outfalls which are associated with the Dock Boiler House which supplied auxiliary steam have been secured and "mothballed". These outfalls may be reactivated at any time for emergency steam supply to the dock area. For purposes of monthly reporting on the discharge monitoring reports (DMRs), values of zero (0) will be listed for all parameters when the outfalls are not in use.
- o Outfall 010: This outfall has been repiped to eliminate direct discharges to the river.
- o Outfall 014: This outfall has been repiped to eliminate direct discharges to the river.

EPA has determined that the proposed permit limitations satisfy all the technology requirements of the Clean Water Act, including the 1984 BAT requirements for toxic pollutants and BCT for conventional pollutants. Review of the toxic pollutant portion of the NPDES permit application indicates that no organic pollutants were detected significantly above detection limits.

The permittee's application for permit renewal indicates the presence of several heavy metals (cadmium, nickel, and mercury) not normally associated with power plant discharges. Accordingly, EPA is requiring the permittee to take one grab sample of intake and discharge of Unit #3 within 60 days after the effective date of the permit for comparative heavy metals analyses. The permittee shall determine the source of all heavy metal concentrations reported in the September 11, 1989 permit application.

The monitoring program in the permit specifies routine sampling and analysis which will provide continuous general information on the reliability and effectiveness of the installed pollution abatement equipment.

The effluent monitoring requirements have been established to yield data representative of the discharges under authority of Section 308(a) of the Clean Water Act, according to regulations set forth at 40 C.F.R. 122.41(j), 122.48, 122.41(j)(4)(5), and 122.44(i).

The remaining general and special conditions of the permit are based on the NPDES regulations, 40 CFR Parts 122 through 125, and consist primarily of Management requirements common to all permits.

#### SECTION 316 A AND B OF THE CWA

Section 316(a) of the Clean Water Act (CWA) addresses the thermal component of any effluent discharge. EPA has not developed best practicable control technology currently available (BPT) for thermal discharges from point sources. However, EPA assumes that if thermal limits satisfying BPT were developed in accordance with Section 301(b)(1)(A) of the CWA, they would be more stringent than what would be proposed by the NPDES Permit applicant. This is based upon the premise that the water quality criteria developed by EPA or by individual water quality standards developed by states would be the limiting factor in the development of the NPDES Permit. It should also be noted that thermal discharges (heat) are not subject to the technology standards required by Best Conventional Pollutant Control Technology Economically Achievable since heat is not considered to be a toxic pollutant or a conventional pollutant as defined by the CWA and outlined in 40 CFR 401.15 or 401.16.

Section 316(a) of the CWA gives the Administrator of the EPA the authority to impose alternative effluent limitations for the control of the thermal component of any discharge. However, the owner or operator of the point source must demonstrate to the satisfaction of the Administrator that existing effluent limitations are more stringent than necessary to assure the protection and propagation of a balanced indigenous community of shellfish, fish and wildlife in and on the receiving water.

Similarly, Section 316(b) of the CWA gives the Administrator of the EPA the authority to determine if the location, design, construction, and capacity of the cooling water intake structures reflect BPT for minimizing adverse environmental impact.

The authority of these two sections of the CWA has been delegated to the Regional Administrators or their designees in accordance with regulatory procedures outlined under 40 CFR 125.

A permit was issued in 1975 reflecting regulations contained in the "Effluent Guidelines and Standards for the Steam Electric Power Generating Industry" which were published on October 8, 1974. According to these regulations, the Schiller Station plant was determined to be an "old unit" since it was put into service before January 1, 1974. These regulations for "old units" did not limit the thermal discharges.

The permittee has certified that there have been no significant changes to the plant discharges, fish impingement, and river ecology during the life of the plant. The Company has also indicated that the facility has operated over 20 years with no evidence of adverse aquatic impacts. Little, if any, any impact from the thermal plume upon the biological community has been detected, and since the station has operated without any obvious environment degradation, a favorable 316(a) determination can be made. This lack of environmental impact by the plumes reflects the low effect of all normal power plant pollutants: maximum temperature, temperature rise, chlorine, organic chemicals, and heavy metals.

In 1975, EPA reviewed fish impingement data for Schiller Station and determined that the circulating water intake structure employs the best technology available for minimizing adverse environmental impact. The present design shall be reviewed for conformity to regulations pursuant to Section 316(b) when such are promulgated.

The Regional Administrator granted the 316(a) variance based upon previous hydrological and biological studies and upon the absence of detectable environmental impact during the operating history of the station.

In the current reapplication for a NPDES Permit, PSNH, Schiller Station has demonstrated to EPA that since the last reissuance of the NPDES Permit:

- a. There has been no significant changes to the design or to the operation of the station and, in particular, no changes to the circulating cooling water system.
- b. There have been no significant changes in the hydrology or in the biology of Piscataqua Estuary and surrounding waters.
- c. There have been no fish kills or any other observable environmental impact on the bay and surrounding waters.



Therefore, the Regional Administrator has determined that a 316(a) variance could be granted and that for the design of the intake structure, 316(b) satisfies the best technology available requirements. Further, the proposed draft permit, effluent limitations and special conditions imposed relative to the thermal component and intake structures, assure satisfaction of the New Hampshire Water Quality Standards for Piscataqua Estuary.

**V. State Certification Requirements.**

EPA may not issue a permit unless the State Water Pollution Control Agency with jurisdiction over the receiving waters certifies that the effluent limitations contained in the permit are stringent enough to assure that the discharge will not cause the receiving water to violate State Water Quality Standards. The staff of the New Hampshire Department of Environmental Services has reviewed the draft permit and advised EPA that the limitations are adequate to protect water quality. EPA has requested permit certification by the State and expects that the draft permit will be certified.

**VI. Comment Period, Hearing Requests, and Procedures for Final Decisions.**

All persons, including applicants, who believe any condition of the draft permit is inappropriate must raise all issues and submit all available arguments and all supporting material for their arguments in full by the close of the public comment period, to the U.S. EPA, Compliance Branch, JFK Federal Building, Boston, Massachusetts 02203. Any person, prior to such date, may submit a request in writing for a public hearing to consider the draft permit to EPA and the State Agency. Such requests shall state the nature of the issues proposed to be raised in the hearing. A public hearing may be held after at least thirty days public notice whenever the Regional Administrator finds that response to this notice indicates significant public interest. In reaching a final decision on the draft permit the Regional Administrator will respond to all significant comments and make these responses available to the public at EPA's Boston office.

Following the close of the comment period, and after a public hearing, if such hearing is held, the Regional Administrator will issue a final permit decision and forward a copy of the final decision to the applicant and each person who has submitted written comments or requested notice. Within 30 days following the notice of the final permit decision any interested person may submit a request for a formal hearing to reconsider or contest the final decision. Requests for formal hearings must satisfy the requirements of 40 C.F.R. §124.74, 48 Fed. Reg. 14279-14280 (April 1, 1983).

**VII. EPA Contact.**

Additional information concerning the draft permit may be obtained between the hours of 9:00 a.m. and 5:00 p.m., Monday through Friday, excluding holidays from:

**Nicholas Prodaný**  
Wastewater Management Section CT, ME, NH  
WMC-2113  
John F. Kennedy Federal Building  
Boston, Massachusetts 02203  
Telephone: (617) 565-3587

6/22/90  
Date

**David A. Fierra, Director**  
Water Management Division  
Environmental Protection Agency

# Exhibit 5

**RESPONSE TO COMMENTS**  
**REISSUANCE OF NH0001473**  
**PUBLIC SERVICE COMPANY OF NEW HAMPSHIRE**  
**SCHILLER STATION**

During the period, July 3, 1990 to August 1, 1990, EPA and the New Hampshire Department of Environmental Services solicited public comments on the draft National Pollutant Discharge Elimination System (NPDES) permit to be issued to the Public Service Company of New Hampshire - Schiller Station for the discharge of once through cooling water, treated operational plant wastewater, process water, and coal pile runoff to the Piscataqua River in Portsmouth New Hampshire. Comments were received from PSNH - Schiller Station. Following is a response to comments received during the public notice period, including identification and explanation of those provisions of the draft permit which have changed in the final permit:

Comment 1

Oil and grease samples are collected on a monthly basis for Outfalls 001, 011, and 018. The permit contains two limits which causes confusion when only one value is recorded each month. Public Service on New Hampshire (PSNH) requests the average monthly limit be eliminated and have a daily maximum limit only.

Response

Federal regulations at 40 CFR 122.44(1) stipulate that the limitations of a reissued NPDES permit cannot be less stringent than those of the previously issued permit, except in certain circumstances which do not apply in this case.

Comment 2

PSNH requests that the discharge monitoring report (DMR) submittal deadline for reports be the 28th of each month as required by their existing permit. Additional time is needed to compile the large amounts of data associated with an 18-outfall facility.

Response

Due to requirements by the Water Supply & Pollution Control Division of the New Hampshire Department of Environmental Services, the discharge monitoring report date can be no later than the 15th day of the month following the completed monitoring period. That date has been included in the final permit.

Comment 3

PSNH requests that an emergency temperature provision be granted for Outfalls 002, 003 and 004 to allow less restricted operation during New England power deficiencies. The request is made to lessen the risk of voltage reductions or brownouts during periods of high electrical power demand, usually triggered by extreme weather conditions.

Response

The upper temperature and change of temperature limits are water quality-based and unlike technology-based limits cannot be changed. These limits are "grandfathered" in that their basis was no prior harm to aquatic life at these elevated thermal conditions. EPA biologists have allowed upper temperature limits of 90° to 95° F with few exceptions. Ninety-five (95) degrees F is almost universally accepted amongst biologists as the upper thermal limit that will not adversely impact aquatic life.

Even though the violation can be justified and it will be of a short duration causing no observable harm to the waterway, the EPA can not authorize, through a permit caveat, a violation of an effluent limit.

The permittee can in the likelihood of a thermal excursion, report to the EPA Regional Administrator, the State Director, and the Executive Director of the New Hampshire Fish and Game Department the following information:

- 1) When the thermal excursion is expected
- 2) The expected duration of the thermal excursion
- 3) Monitoring results of impacts on aquatic life, especially any fish kills
- 4) If fish kills occur, the permittee shall operate the facility within the approved permit conditions and report to the Administrator, Director, and Executive Director.

NOTE:

Subsequent to the public notice period, the EPA and the State are requesting that the permittee take two samples from the wastewater treatment facility. The first sample shall be taken within 60 days after the effective date of the final permit. The second sample shall be taken during the first metal cleaning operation after the effective date of the permit. Both samples shall be analyzed for all heavy metals identified in Appendix D, Table III of 40 CFR 122.21 with the exception of cyanide and phenol.

An additional paragraph has been added to the permit, prohibiting the discharge of tank water draws to the Piscataqua River without treatment. In the past, some tank water draws have shown significant toxicity.

# Exhibit 6

UNITED STATES ENVIRONMENTAL PROTECTION AGENCY  
REGION I  
JOHN F. KENNEDY FEDERAL BUILDING  
BOSTON, MASSACHUSETTS 02203

FACT SHEET

DRAFT NATIONAL POLLUTANT DISCHARGE ELIMINATION SYSTEM (NPDES)  
PERMIT TO DISCHARGE TO WATERS OF THE UNITED STATES

NPDES PERMIT NO.: NH0001465

NAME AND ADDRESS OF APPLICANT:

Public Service of New Hampshire  
1000 Elm Street, P.O. Box 330  
Manchester, NH 03105

NAME AND ADDRESS OF FACILITY WHERE DISCHARGE OCCURS:

Merrimack Station  
River Road  
Bow, New Hampshire 03301

RECEIVING WATER: Merrimack River

CLASSIFICATION: B

I. Proposed Action, Type of Facility, and Discharge Location.

The above named applicant has applied to the U.S. Environmental Protection Agency for the reissuance of its NPDES permit to discharge into the designated receiving water. The facility is engaged in electric-power generation and distribution. The discharge consists of once-through cooling water, operational plant wastewater, process water, intake-dredgings de-watering water, and stormwater runoff. The facility discharges into the Merrimack River, a class B waterway, at a point: latitude 43° 08' 15", longitude 71° 28' 15". The location of the discharges are shown on Attachment A.

II. Description of Discharge.

A quantitative description of the discharge in terms of significant effluent parameters based on data presented in the application and/or discharge monitoring reports is shown on Attachment B. A water flow chart for the discharges from the facility is presented on Attachment C.



to establish effluent limitations which set forth the degree of reduction attainable through the application of best practicable control technology currently available (BPT), best conventional pollutant control technology (BCT), and best available technology economically achievable (BAT) (Section 301 and 304) for those industries for which national effluent guidelines have been promulgated. The Act also requires EPA to obtain state certification that water quality standards will be satisfied. Regulations governing state certification are set forth in 40 CFR 124.53 and 124.55.

The New Hampshire Department of Environmental Services (NHDES) is recommending that the permittee investigate options of isolating the slag (ash) settling pond from the neighboring wetlands. The NHDES wants to insure that the slag settling pond can be operated without interference from surface waters, and to allow the slag settling pond to continue to function as part of the wastewater treatment facility, separate from the waters of the State of New Hampshire. Accordingly, the necessary conditions associated with the planning and actual construction of the facilities necessary to segregate the slag settling pond from the neighboring wetlands are specified in the draft permit.

The effluent limitations presented in the draft permit for total suspended solids (TSS) are based on the Steam Electric Power Plant Guidelines (40 CFR 423) as promulgated on November 19, 1982 (47 Fed. Reg. 52290).

The permittee is requesting EPA to establish "net credit" limits for iron at the discharge of the slag pond weir (Outfalls 003A and 003B). To support their request, the permittee has demonstrated (see Attachment D) that the iron background in the Merrimack River varies from a low of 0.2 mg/l to a high of 1.1 mg/l for the past two (2) years (01/26/89 to 02/25/91). During this same time period the average iron concentration was 0.5 mg/l. As discussed in the federal regulations at 40 CFR Part 122.45, in certain cases, "net" limitations can be used to reflect credit for pollutants in the discharger's intake water. According to 40 CFR Part 122.45 (g)(1)(ii), technology-based limitations or standards can be adjusted to reflect credit for pollutants in the permittee's intake water if: the permittee demonstrates that the control system - in this case, caustic metal hydroxide precipitation - it uses to meet applicable technology-based limitations and standards would if properly installed and operated, meet the limitations and standards in the absence of pollutants in the intake water. The concentration limits for iron in the effluent limitations guidelines (ELGs) are based upon the use of hydroxide-precipitation technology, which is the standard metals removal technology that forms the basis for virtually all of EPA's BAT metals limitations for metal-bearing wastestreams. The effluent limits for total iron based on the ELGs are 1.0 mg/l, average monthly and 1.0 mg/l, daily

maximum; respectively. These concentration limits can be achieved through hydroxide precipitation, independent of the source of the pollutant. In this case, iron is present in the intake/receiving waters as well as the slag settling pond discharge during chemical cleaning operations. EPA concludes that the iron (whether from intake water or chemical cleaning operations) in the slag pond discharge can be treated using hydroxide precipitation to levels set forth in the regulations. Accordingly, the draft permit limits for iron are based on the ELGs with no credit provisions for iron background in the Merrimack River.

Also the permittee is requesting that copper monitoring be eliminated from routine discharges at the slag pond weir (Outfall 003A), since the copper level is never above 0.1 mg/l. The permittee has demonstrated (see Attachment E) that the concentration of copper at the weir discharge has been consistently below 0.1 mg/l for the past two years (01/26/89 to 02/25/91). The limits for total copper in the current permit are: 0.2 mg/l, average monthly and 0.2 mg/l, daily maximum. These limits are based on old water quality criteria. Since copper-bearing metals are discharged into the ash pond during chemical cleaning, there is a possibility that copper retained in the pond may be released at times other than chemical cleaning periods. This can occur by re-suspension of copper in the sediments or through conditions of low pH (acid rain, for example) where copper in the sediment has the potential to go back into solution. EPA feels that the monthly monitoring requirements of routine discharges in the current permit are necessary to insure that water quality requirements are maintained. Accordingly, effluent limits for total copper in the draft permit are based on New Hampshire State Water Quality standards. Moreover, it should be noted that the aquatic water quality criteria (WQC) for copper are hardness dependent. The values in the current permit are based on a hardness of 50 mg/l, as CaCO<sub>3</sub>. NHDES recently submitted harness data (from 1989 to 1990) to EPA for the Merrimack River in the vicinity of Hooksett, NH. These data indicate the average hardness of the river to be approximately 20 mg/l. In addition, the Water Quality Standards (WQS) for the State have been recently revised (April, 1990) to account for a reservation of 10 percent of a river's assimilative capacity. Hence, using a 7Q10-low flow of 420 MGD, hardness-corrected values of 3.9 ug/l and 3.0 ug/l for the acute and chronic WQC respectively, for copper, and 10 percent reserve of the river; one calculates the acute and chronic aquatic life protection-effluent limits for copper as: 77.2 ug/l, daily maximum, and 126 ug/l average monthly, respectively. Since the acute limit is more stringent, it is specified as the effluent limit in the draft permit.

The pH and oil and grease limitations have been established based on either effluent limitation guidelines (ELGs) or state

# Exhibit 7

**6.5.3. Outfalls 003A and 003B.** In previous permits two internal outfalls were established. Internal outfalls are used to monitor a specified wastewater stream before it mixes with another wastewater stream. Diluting one wastewater stream with another wastewater in order to meet discharge limitations is not considered an acceptable treatment technology. Outfall 003A was established to monitor the limits associated with the Slag Settling Pond effluent discharge. Outfall 003B was established to monitor the effluent limits associated with metal cleaning operations. As applied to the existing permit, both Outfall 003A and Outfall 003B are situated at the same location; the broad-crested weir which begins the discharge of the Slag Settling Pond (Waste Treatment Plant No. 4) to Cooling Discharge Canal (Waste Treatment Plant No. 2). After effluent enters the Cooling Discharge Canal, it ultimately discharges to the Merrimack River through Outfall 003. During routine operating periods at Merrimack Station, the effluent limitations for the discharge of the Slag Settling Pond are associated with Outfall 003A. When metal cleaning operations occur, the effluent limitations associated with Outfall 003B are applied to the discharge of the Slag Settling Pond.

All NPDES permit metal limitations are expressed in terms of "total recoverable metal" in accordance with 40 C.F.R. § 122.45(c). Two metals associated with Outfalls 003A and 003B are limited at Merrimack Station; Total Recoverable Copper (TRC) and Total Recoverable Iron. These metals are limited based on either the Steam Electric Power Generating effluent limit guidelines (ELGs) found at 40 CFR Part 423, or New Hampshire's Surface Water Quality Criteria for Toxic Substances contained in Env-WQ 1703.21. The water quality limits prevail during most periods of the Station's operation. The Steam Electric Power Generating ELG's are applied only every several years when metal cleaning operations occur at Merrimack Station.

**6.5.3.1 Outfall 003A Slag Settling Pond Discharge and Low Volume Waster Streams Effluent Limits.** The discharge to the Slag Settling Pond, also designated as WTP No. 4, consists of flows from both generating unit's slag tanks, those slag tanks' overflows and miscellaneous yard drains. Unit 1's roof drains and boiler blowdown are directed to the Slag Settling Pond. The intermediate discharge from WTP No. 1 s also directed to the Slag Settling Pond. The Slag Settling Pond discharges to WTP No. 2, the Cooling Water Discharge Canal, through Outfall 003A.

Adjacent to the Slag Settling Pond is wetlands, which drained into the Slag Settling Pond. During the present permit

development the NHDES recommended that the Permittee investigate isolating these wetlands from the Slag Settling Pond. The NHDES wanted to allow the Slag Settling Pond to continue to function as part of the wastewater treatment facility, separated from the waters of the State of New Hampshire. In 2003(?)--check year the permittee completed redirecting the wetland's runoff away from the Slag Settling Pond. The wetland's runoff now flows to Bow Bog Brook. Bow Bog brook runs through the northern portion of the Merrimack Station site before emptying into the Merrimack River.

After combusting in Merrimack Station two boilers, hot coal ash is dumped from the boiler into an ash hopper. The ash hopper contains quenching water. When the molten ash, i.e., slag, comes in contact with the quenching water, it fractures instantly, crystallizes, and forms pellets. The resulting boiler slag is a coarse, hard, black, angular, glassy material, which is transported by water from the boiler building to the slag sluice settling area for dewatering. After draining from the settling area the slag sluice water enters the Slag Settling Pond where entrained solids are further allowed to settle. Other than suspended solids settling, no other direct treatment is applied to the water in the Slag Settling Pond.

The present permit limits the Slag Settling Pond effluent for Total Suspended Solids (TSS) and Oil and Grease. These parameters are limited in accordance with the technology-based limits from 40 C.F.R. § 423.13(b)(4). There are also effluent limits for Total Recoverable Copper (TRC) and Recoverable Iron (TRI), and a pH reporting requirement.

#### Total Recoverable Copper

The existing permit limits copper to 0.20 mg/l at internal outfall 003A, the Slag Settling Pond Discharge, during routine, i.e., non-metal cleaning, plant operation. The existing permit's Fact Sheet reasoned that since copper is discharged into the Slag Settling Pond during chemical cleaning operations, the possibility exists that any copper, which has been retained in the pond from metal cleaning operations, could be released at times other than cleaning periods. This would occur by re-suspension of copper from the sediment or through conditions of low pH where copper in the sediment has the potential to go back into solution. Therefore, EPA and NHDES developed a water quality copper limit that was to be applied during routine operations, with a monthly monitoring requirement.

EPA has conducted a reasonable potential analysis to determine the probability the copper concentrations contained in Outfall 003A's effluent would exceed the present permit's 0.20 mg/l water quality limit. DMR data that reported copper concentrations for Outfall 003A were analyzed for the period March 2003 to June 2008. See Appendix (Letter). A mean and standard deviation was calculated for this data set. The average copper concentration for the DMR data is 0.010 mg/l and the variance is 0.0002. The highest copper concentration sampled during this five year period was 0.05 mg/l. Since copper concentration, on average, are 0.19 mg/l below the effluent limit and the data demonstrates extremely low variability, EPA is inclined to eliminate the total recoverable copper limit for Outfall 003A.

Review of the existing permit's Fact Sheet, however, does not provide any indication how this 0.2 mg/l copper limit was calculated or derived. The permit preceding the present permit also had an acute copper limit for Outfall 003A of 0.2 mg/l. It is surmised the 0.2 mg/l was retained based on anti-backsliding criteria. Anti-backsliding requires a reissued permit to be as stringent as the previous permit. See 40 C.F.R. § 122.44(1).

EPA and NHDES for this draft permit development have recalculated Outfall 003A's acute copper water quality limit based on a revised 7Q10.

Recalculated Dilution Factor

$$\text{Dilution Factor (DF)} = \left( \frac{\text{Merrimack River 7Q10 Flow}}{\text{Outfall 003A Discharge Flow}} \right) \times 0.9$$

Where: 7Q10 Flow - 587.75 cfs  
 Outfall 003A Flow - 13.3 cfs  
 State 10% reserve - 0.9

NOTE: Merrimack Station's reapplication stated that the maximum thirty day flow discharged from Outfall 003A was 9.0 MGD or 13.92 cfs. A statistical analysis of Outfall 003A flow data since January 2003 results in a maximum thirty day flow of 8.6 MGD or 13.3 cfs.

$$DF = \left( \frac{587.75 \text{ cfs}}{13.3 \text{ cfs}} \right) \times 0.9$$

DF = 39.76

Calculated Acute Limit

Acute Limit = Acute Water Quality Criteria X DF

Where: Acute Water Quality Criteria - 0.0036 mg/l  
DF - 39.76  
Factor to Convert Copper Acute Water Quality Criteria  
from Dissolved Metals Limit to Total Recoverable Metals -  
0.960

$$\text{Acute Limit} = \left( \frac{0.0036}{0.960} \right) \times 39.76$$

Acute Limit = 0.149 mg/l

Comparing Outfall 003A's average copper concentration of 0.010 mg/l calculated from DMR data to the recalculated acute copper limit of 0.149 mg/l, the expected average copper concentrations in the discharge is 0.139 mg/l below the acute copper limit. Since March 2003 the highest copper concentration sampled was 0.05 mg/l. Again, over the past five years the DMR data for copper has demonstrated extremely low variability. Based on a lack of reasonable potential to even approach, far less exceed, a copper water quality limits EPA has eliminated the total recoverable copper limit for Outfall 003A during normal, i.e., non-metal cleaning, plants operation.

Anti-backsliding regulations allow the establishment of less stringent limits if new information is available that was not available at the permit's issuance which would have justified a less stringent effluent limitation. See 40 C.F.R. § 122.44(1). In this situation, review of Outfall 003A's flow data for the past five years shows that the maximum flow rate is actually lower than the flow submitted in the Permittee's 1997 reapplication. Further statistical analysis of the reported copper concentrations contained in Outfall 003's DMR data demonstrated there was no potential to exceed a copper water quality based limit for Outfall 003. Use of this new information, allowed by anti-backsliding regulations, allowed for the elimination of Outfall 003A's acute copper limit.

Every three to five years, metal cleaning waste liquid from Unit 1 or 2's boiler is routed to the Waste Treatment Plant, WTP No.1, for treatment by the caustic metal hydroxide precipitation process. WTP No. 1 treated effluent is discharged to WTP No. 4,

the Slag Settling Pond. As will be explained in Section 6.5.3.2, the outfall for WTP No. 1, Outfall 003B, has been relocated from a co-location with Outfall 003A to the actual discharge pipe of WTP No. 1. In the draft permit Outfall 003B will have a technology based copper limit of 1.0 mg/l based on technology based copper limits contained in 40 C.F.R. § 423.13(e).

EPA has investigated the potential that the copper discharge from WTP No. 1, even though not exceeding its 1.0 mg/l copper limit, still might exceed New Hampshire's water quality standards for the Merrimack River. A mass balanced water quality calculation was conducted to determine the whether the contribution of copper contained in the effluent discharged from Outfall 003A would adversely effect the water quality of the Merrimack River. That calculation follows:

$$Q_d C_d + Q_s C_s = Q_r C_r$$

Where:

- $Q_d$  Outfall 003A Average 30-day Maximum Discharge; 13.3 cfs
- $C_d$  Outfall 003A Assumed Maximum Copper Concentration; 1.0 mg/l
- $Q_s$  Merrimack River 7Q10; 587.75 cfs
- $C_s$  Merrimack River Average Copper Concentration; 0.0 mg/l
- $Q_r$  Resultant Flow; 601.05 cfs
- $C_r$  Resultant In-Stream Copper Concentration; mg/l

Solving for resultant river copper concentration  $C_r$ :

$$C_r = \frac{Q_d C_d + Q_s C_s}{Q_d + Q_s}$$

$$C_r = \frac{(13.3)(1.0) + (587.85)(0.0)}{587.85 + 13.3}$$

$$C_r = 0.022 \text{ mg/l}$$

This analysis demonstrates the discharge of Outfall 003A, using assume maximum copper concentration of 1.0 mg/l, adds only 0.022 mg/l to the copper concentration levels of the Merrimack River. EPA will not require a water quality limit for total recoverable copper for effluent discharged from Outfall 003A during metal



cleaning operations.

#### Total Recoverable Iron

The existing permit has an acute limit for iron of 1.0 mg/l at internal Outfall 003A, the Slag Settling Pond Discharge, during routine, i.e., non-metal cleaning, plants operation. The present permit's Fact Sheet explains this limit is based on hydrogen-precipitation technology, which is the standard metals removal technology that forms the basis for virtually all of EPA's Best Available Technology Economically Achievable (BAT) for metal cleaning waste streams. The Fact Sheet further explains that the Slag Settling Pond discharge can be treated by this technology to meet the permitted limit of 1.0 mg/l.

The Effluent Limit Guidelines (ELG) for discharges related to the 40 Part 423 Steam Electric Power Generating Point Source Category does not place any iron limits on a fly ash transport water discharge, which is what Outfall 003A discharges. It is surmised the 1.0 mg/l iron limit for Outfall 003A is to limit any iron discharged from WWTP No. 1 to the Slag Settling Pond when treating metal cleaning wastes. Normally, Merrimack Station employs WWTP No. 1 every three to five years for several days to treat waste from boiler cleaning.

As previously described, Outfall 003A's discharge consists of flows from the two generating unit's slag tanks, those slag tanks' overflows and miscellaneous yard drains, and Unit 1's roof drains and boiler blowdown. In accordance with 40 Part 423 Steam Electric Power Generating Point Source Category neither of these effluent sources have iron limits. Most effluent discharged from Outfall 003's comes from the generating unit's slag tanks, i.e., the fly ash transport water. Referring to Appendix (Letter), Merrimack Station Schematic of Water Flow, ninety-five percent of Outfall 003A's discharge is fly ash transport water. The source of that transport water is the Merrimack River.

Based on DMR data since January 2003, the average iron concentration of Outfall 003A's discharge is 0.65 mg/l with a variance of 0.023 mg/l. The highest concentration sampled was 1.0 mg/l and the next highest was 0.85 mg/l. Over the past five years the DMR data for iron has demonstrated extremely low variability and an average that is 0.35 mg/l below the effluent's iron limit of 1.0 mg/l.

A mass balanced water quality calculation was conducted to

determine the whether the contribution of iron contained in the effluent discharged from Outfall 003A would adversely effect the water quality of the Merrimack River. That calculation follows:

$$Q_d C_d + Q_s C_s = Q_r C_r$$

Were:

$Q_d$  Outfall 003A Average 30-day Maximum Discharge; 13.3 cfs

$C_d$  Outfall 003A Maximum Iron Concentration; 1.0 mg/l

$Q_s$  Merrimack River 7Q10; 587.75 cfs

$C_s$  Merrimack River Average Iron Concentration; 0.36 mg/l

$Q_r$  Resultant Flow; 601.05 cfs

$C_r$  Resultant In-Stream Iron Concentration; mg/l

Solving for resultant river iron concentration  $C_r$ :

$$C_r = \frac{Q_d C_d + Q_s C_s}{Q_d + Q_s}$$

$$C_r = \frac{(13.3)(1.0) + (587.85)(0.36)}{587.85 + 13.3}$$

$$C_r = 0.374 \text{ mg/l}$$

This analysis demonstrates the discharge of Outfall 003A, even when using the maximum iron concentration recorded in the last five years, adds only 0.013 mg/l to the iron concentration levels of the Merrimack River. This fact, coupled with the lack of reasonable potential to even approach, far less exceed, the existing permit's iron limit for Outfall 003A, EPA has eliminated the total recoverable iron limit for Outfall 003A during normal, i.e., non-metal cleaning, plants operation.

#### Flow

The flow limits for average monthly, 9 MGD, and maximum daily, 19.1 MGD, are carried over from the existing permit.

#### Total Suspended Solids (TSS)

The chronic and acute concentration limits for Total Suspended

# Exhibit 8

RESPONSE TO COMMENTS - DATED JUNE 24, 1992  
REISSUANCE OF PERMIT NO. NH0001465  
PSNH MERRIMACK STATION  
BOW, NEW HAMPSHIRE

The U.S. Environmental Protection Agency (EPA) and the New Hampshire Department of Environmental Services (NHDES) solicited public comments from December 18, 1991 to February 15, 1992, for the draft National Pollutant Discharge Elimination System (NPDES) permit to be reissued to PSNH - Merrimack Station (PSNH). This permit is for the discharge of once-through cooling water, operational plant wastewater, process water, and storm-water runoff, including treated coal-pile runoff to the Merrimack River from Outfall 003.

During the public notice (comment) period, PSNH Merrimack Station and NHDES submitted comments on the draft permit. Following is a response to all these comments, including identification and explanation of those provisions of the draft permit which have been changed in the final permit.

These responses and associated comments are complimentary to the FACT SHEET and Draft Permit. For the reader to fully understand them, they should be familiar with the draft permit and the associated FACT SHEET, applicable National Pollutant Discharge Elimination System's (NPDES) permit regulations and State of New Hampshire's Water Quality Statutes and Regulations.

Lastly, the final permit was also developed in consultation with the United States Fish and Wildlife Service and the New Hampshire Fish and Game Department. Both agencies concur with the conditions and requirements of the final permit as they relate to their program areas of interest and concern.

limits for both condenser discharges to regulate TRC to the receiving water in this permit.

**COMMENT 6**

The permittee requests the pH limits for Outfall 003 be modified to the range of 6.0 - 8.0 standard units (s.u.), and the continuous sampling measurement requirement be changed to hourly.

**RESPONSE 6**

The pH-discharge limits are State certification requirements. EPA is maintaining the draft permit, pH limits of 6.5 - 8.0 s.u. in the final permit. Moreover, NHDES asserts that pH be sampled continuously. If equipment outages are incurred, the permittee should have the equipment repaired.

**COMMENT 7**

The permittee requests the discharge limitations for O&G at Outfall 003A be eliminated and the daily-visual monitoring condition in the current permit be retained in the final permit.

**RESPONSE 7**

O&G discharge limits are required by effluent limitations guideline (ELGs) [see 40 CFR Part 423]. EPA is required to consider both technology-based and water quality-based requirements when developing permit limits. EPA regulations also require NPDES permits to contain the more stringent of the two effluent limits for each pollutant parameter. In this case, the ELGs for O&G are more stringent.

**COMMENT 8**

The permittee requests that the total copper discharge limit at Outfall 003A be eliminated, since the ELGs regulate copper discharges for chemical cleaning operations only, and not for routine-low volume discharges from ash settling ponds, for example.

**RESPONSE 8**

The ELGs do not establish copper limitations on low volume wastes, ash pile runoff, or storm water runoff (components of the ash pond discharge, Outfall 003A). The maximum total copper limitation of 0.2 mg/l is being maintained in accordance with the anti-backsliding provision of 40 CFR 122.44 (1). It is to be noted that this discharge has shown an average total copper concentration of 0.0015 mg/l in the past two years.