

83222-30

12/23/2010

1 of 57



UNITED STATES ENVIRONMENTAL PROTECTION AGENCY  
WASHINGTON, D.C. 20460

OFFICE OF  
PREVENTION, PESTICIDES AND  
TOXIC SUBSTANCES

DEC 23 2010

Ms. Jane Miller  
Agent for J. Oliver Products, LLC  
115 Obtuse Hill  
Brookfield, CT 06804

Subject: Label Notification  
EPA Reg. N. 83222-30  
Warthog 2 EC Herbicide

Dear Ms. Miller:

The Agency is in receipt of your Application for Pesticide Notification under Pesticide Registration Notice (PRN) 98-10 dated 8/6/10 for **EPA Registration 83222-30**. The Registration Division (RD) has conducted a review of this request for applicability under PRN 98-10 and finds that the label changes requested (alternate brand name Warthog 2 EC Herbicide and new container size of 2.5 gallons) fall within the scope of PRN 98-10. The label has been date-stamped "Notification" and will be placed in our records.

If you have any questions, please contact me directly at 703-305-1243

Sincerely,

Kathryn V. Montague  
Product Manager 23  
Herbicide Branch  
Registration Division (7505P)  
Office of Pesticide Programs

2057

	United States <b>Environmental Protection Agency</b> Washington, DC 20460	<input type="checkbox"/> Registration <input type="checkbox"/> Amendment <input checked="" type="checkbox"/> Other	OPP Identifier Number
--	---	--	-----------------------

**Application for Pesticide - Section I**

1. Company/Product Number 83222-30	2. EPA Product Manager	3. Proposed Classification <input type="checkbox"/> None <input type="checkbox"/> Restricted
4. Company/Product (Name) Clethodim 2 EC Herbicide	PM# <u>23</u>	
5. Name and Address of Applicant (Include ZIP Code) J. Oliver Products, LLC c/o Biologic, Inc. 115 Obtuse Hill Road Brookfield, CT 06804 <input type="checkbox"/> Check if this is a new address	6. Expedited Review. In accordance with FIFRA Section 3(c)(3) (b)(i), my product is similar or identical in composition and labeling to: EPA Reg. No. _____  Product Name _____	

**Section - II**

<input type="checkbox"/> Amendment - Explain below.	<input checked="" type="checkbox"/> Final printed labels in response to Agency letter dated _____
<input type="checkbox"/> Resubmission in response to Agency letter dated _____	<input type="checkbox"/> "Me Too" Application.
<input checked="" type="checkbox"/> Notification - Explain below.	<input type="checkbox"/> Other - Explain below.

**Explanation:** Use additional page(s) if necessary. (For section I and Section II.)

This is a notification to 1) add an alternate brand name of "Warthog 2 EC Herbicide" and 2) add the package size of 2.5 gallons to this registration per PR Notice 98-10. This notification is consistent with the provisions of PR Notice 98-10 and the EPA regulations at 40 CFR 152.46 and no other changes have been made to the labeling or the confidential statement of formula of this product. I understand that it is a violation of 18 U.S.C. Sec. 1001 to willfully make any false statement to EPA. I further understand that if this notification is not consistent with the terms of PR Notice 98-10 and 40 CFR 152.46 this product may be in violation of FIFRA and I may be subject to enforcement action and penalties under sections 12 and 14 of FIFRA.

**Section - III**

1. Material This Product Will Be Packaged In:				2. Type of Container	
Child-Resistant Packaging <input type="checkbox"/> Yes <input type="checkbox"/> No	Unit Packaging <input type="checkbox"/> Yes <input type="checkbox"/> No	Water Soluble Packaging <input type="checkbox"/> Yes <input type="checkbox"/> No		<input type="checkbox"/> Metal <input type="checkbox"/> Plastic <input type="checkbox"/> Glass <input type="checkbox"/> Paper <input type="checkbox"/> Other (Specify) _____	
* Certification must be submitted		If "Yes" Unit Packaging wgt.    No. per container	If "Yes" Package wgt    No. per container		
3. Location of Net Contents Information <input type="checkbox"/> Label <input type="checkbox"/> Container		4. Size(s) Retail Container 1, 2.5 gal.		5. Location of Label Directions <input type="checkbox"/> on label	
6. Manner in Which Label is Affixed to Product <input type="checkbox"/> Lithograph Paper glued Stenciled				<input type="checkbox"/> Other _____	

**Section - IV**

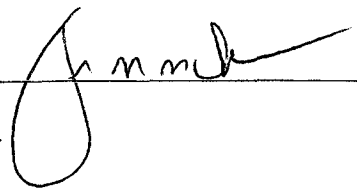
1. Contact Point (Complete items directly below for identification of individual to be contacted, if necessary, to process this application.)		
Name Jane M. Miller	Title Agent	Telephone No. (Include Area Code) (203) 740-1200
<b>Certification</b> I certify that the statements I have made on this form and all attachments thereto are true, accurate and complete. I acknowledge that any knowingly false or misleading statement may be punishable by fine or imprisonment or both under applicable law.		6. Date Application Received (Stamped)
2. Signature 	3. Title Agent	
4. Typed Name Jane M. Miller	5. Date August 6, 2010	

30857

**BIOLOGIC** INC.  
*agribusiness professionals*

August 6, 2010

Document Processing Desk (NOTIF)  
Office of Pesticide Programs (7504P)  
US Environmental Protection Agency  
One Potomac Yard  
2777 S. Crystal Drive  
Room S-4900, 4<sup>th</sup> Floor  
Arlington, VA 22202

Attention: Ms. Kathryn Montague (PM #23)

Re: "Clethodim 2 EC Herbicide"; EPA Reg. No. 83222-30  
Notification to add an Alternate Brand Name and add a Package Size

Dear Ms. Montague:

On behalf of J. Oliver Products, LLC please find enclosed an Application for Pesticide Notification to 1) add the alternate brand name of "Warthog 2 EC Herbicide" and 2) to add the container size of 2.5 gallons to the label as well. The current Storage and Disposal instructions are suitable for either a 1 or 2.5 gallon container.

The following documents are enclosed to process this Notification:

1. Application for Pesticide Notification (8570-1)
2. One (1) copy of the proposed label with the new brand name and the additional container size of 2.5 gallons listed.

Should you have any questions, or wish to reach me, please feel free to contact our office at 203-740-1200.

Sincerely,

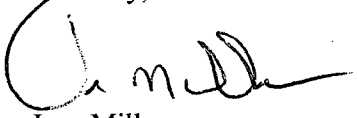

Jane Miller  
Agent to J. Oliver Products, LLC

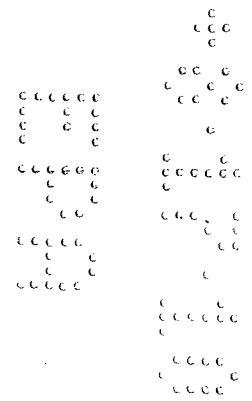

**NOTIFICATION**  
**DEC 23 2010**

# **CLETHODIM 2 EC HERBICIDE**

**[Alternate Brand Name – WARTHOG 2 EC Herbicide]**

Active Ingredient	By Wt.
*Clethodim.....	26.4%
Other Ingredients.....	<u>73.6%</u>
Total.....	100.0%

Contains Petroleum Distillates

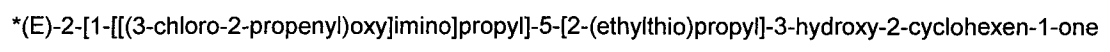

Contains 2.0 lbs. clethodim per gal.

**KEEP OUT OF REACH OF CHILDREN**

## **WARNING - AVISO**

### **SEE NEXT PAGE FOR ADDITIONAL PRECAUTIONARY STATEMENTS**

Si usted no entiende la etiqueta, busque a alguien para que se la explique a usted en detalle. (If you do not understand the label, find someone to explain it to you in detail.)

Manufactured for:  
**J. Oliver Products, LLC**  
3187 Robertson Gin Road  
Hernando, MS 38632

Made in U.S.A.

EPA Reg. No. 83222-30  
EPA Est. No. 44616-MO-001

**NET CONTENTS: 1 GALLON**  
**2.5 GALLONS**

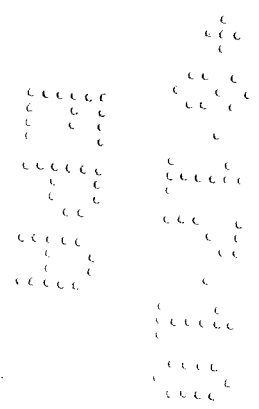

**PRECAUTIONARY STATEMENTS  
HAZARDS TO HUMANS & DOMESTIC ANIMALS  
WARNING**

Causes substantial but temporary eye irritation. Avoid contact with skin. Do not get in eyes, on skin, or on clothing. Harmful if swallowed or inhaled. Avoid breathing vapors or spray mist. Prolonged or frequently repeated skin contact may cause allergic reactions in some individuals.

<b>FIRST AID</b>	
<b>If in eyes:</b>	<ul style="list-style-type: none"> <li>• Hold eye open and rinse slowly and gently with water for 15-20 minutes.</li> <li>• Remove contact lenses, if present, after the first 5 minutes, then continue rinsing eye.</li> <li>• Call a poison control center or doctor for treatment advice.</li> </ul>
<b>If on skin or clothing:</b>	<ul style="list-style-type: none"> <li>• Take off contaminated clothing.</li> <li>• Rinse skin immediately with plenty of water for 15-20 minutes.</li> <li>• Call a poison control center or doctor for treatment advice.</li> </ul>
<b>If swallowed:</b>	<ul style="list-style-type: none"> <li>• Immediately call a poison control center or doctor.</li> <li>• Do not induce vomiting unless told to do so by the poison control center or doctor.</li> <li>• Do not give any liquid to the person.</li> <li>• Do not give anything by mouth to an unconscious person.</li> </ul>
<b>If inhaled:</b>	<ul style="list-style-type: none"> <li>• Move person to fresh air.</li> <li>• If person is not breathing, call 911 or an ambulance, then give artificial respiration, preferably mouth-to-mouth, if possible.</li> <li>• Call a poison control center or doctor for further treatment advice.</li> </ul>
<b>HOT LINE NUMBER</b>	
Have the product container or label with you when calling a poison control center or doctor, or going for treatment. You may also contact 1-800-892-0099 for emergency medical treatment information.	
<b>NOTE TO PHYSICIANS</b>	
Ingestion of this product or subsequent vomiting can result in aspiration of light hydrocarbon liquid, which can cause pneumonitis. If ingested, probable mucosal damage may contraindicate the use of gastric lavage.	

**PERSONAL PROTECTIVE EQUIPMENT (PPE)**

Some materials that are chemical-resistant to this product are listed below. If you want more options, follow the instructions for category G on an EPA chemical resistance category selection chart.

**Applicators and other handlers must wear:** long-sleeved shirt and long pants, chemical-resistant gloves such as Barrier Laminate or Viton ≥ 14 mils, shoes plus socks, and protective eyewear.

**Discard clothing and other absorbent materials that have been drenched or heavily contaminated with this product's concentrate. Do not reuse them.** Follow manufacturer's instructions for cleaning/maintaining PPE. If no such instructions exist, use detergent and hot water. Keep and wash PPE separately from other laundry.

**USER SAFETY RECOMMENDATIONS**

Users should:

- Wash hands before eating, drinking, chewing gum, using tobacco or using the toilet.
- Remove clothing/PPE immediately if pesticide gets inside. Then wash thoroughly and put on clean clothing.
- Remove PPE immediately after handling this product. Wash the outside of gloves before removing. As soon as possible, wash thoroughly and change into clean clothing.

**ENVIRONMENTAL HAZARDS**

Do not apply directly to water, to areas where surface water is present or to intertidal areas below the mean high water mark. Do not apply where runoff is likely to occur. Do not apply where weather conditions favor drift from areas treated. Do not contaminate water when disposing of equipment washwater or rinsate.

The use of this product may pose a hazard to the federally designated endangered species of Solano Grass and Wild Rice. Use of this product is prohibited in the following areas where the species are known to exist:

Solano Grass: Solano County, California: the vernal lakes area bounded by the Union Pacific Railroad and Hastings Road to the north, Highway 113 to the east, Highway 12 to the south, and Travis Air Force Base to the west.

Wild Rice: Hays County, Texas.

**PHYSICAL OR CHEMICAL HAZARDS**

Do not use or store near heat or open flame.

**DIRECTIONS FOR USE**

It is a violation of Federal Law to use this product in a manner inconsistent with its labeling.

**READ ENTIRE LABEL AND PAMPHLET. USE STRICTLY IN ACCORDANCE WITH PRECAUTIONARY STATEMENTS AND DIRECTIONS, AND WITH APPLICABLE STATE AND FEDERAL REGULATIONS.**

Do not apply this product in a way that will contact workers or other persons, either directly or through drift. Only protected handlers may be in the area during application. For any requirements specific to your State or Tribe, consult the agency responsible for pesticide regulation.

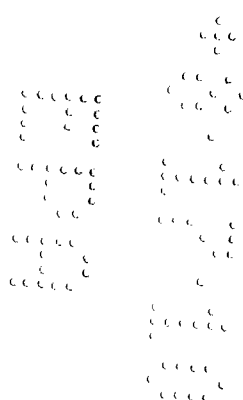

**AGRICULTURAL USE REQUIREMENTS**

Use this product only in accordance with its labeling and with the Worker Protection Standard, 40 CFR part 170. This Standard contains requirements for the protection of agricultural workers on farms, forests, nurseries, and greenhouses, and handlers of agricultural pesticides. It contains requirements for training, decontamination, notification, and emergency assistance. It also contains specific instructions and exceptions pertaining to the statements on this label about personal protective equipment (PPE), and restricted-entry interval. The requirements in this box only apply to uses of this product that are covered by the Worker Protection Standard.

Do not enter or allow worker entry into treated areas during the restricted entry interval (REI) of 24 hours.

PPE required for early entry to treated areas that is permitted under the Worker Protection Standard and that involves contact with anything that has been treated, such as plants, soil, or water, is: coveralls, chemical-resistant gloves, such as Barrier Laminate or Viton ≥ 14 mils, shoes plus socks, and protective eyewear.

**NON-AGRICULTURAL USE REQUIREMENTS**

The requirements in this box apply to uses of this product that are NOT within the scope of the Worker Protection Standards for agricultural pesticides (40 CFR Part 170). The WPS applies when this product is used to produce agricultural plants on farms, forest, nurseries, or greenhouses.

Keep all unprotected persons out of operating areas, or vicinity where there may be drift. Do not enter treated areas without protective clothing until sprays have dried.

**DISCLAIMER, RISKS OF USING THIS PRODUCT, LIMITED WARRANTY AND LIMITATION OF LIABILITY**

**IMPORTANT:** Read the entire Label including this Disclaimer, Risks of Using this Product, Limited Warranty, and Limitation of Liability before using this product. If the terms are not acceptable THEN DO NOT USE THE PRODUCT; rather, return the unopened product within 15 days of purchase for a refund of the purchase price.

**RISKS OF USING THIS PRODUCT**

The Buyer and User (referred to collectively herein as "Buyer") of this product should be aware that there are inherent unintended risks associated with the use of this product which are impossible to eliminate. These risks include, but are not limited to, injury to plants and crops to which this product is applied, lack of control of the target pests or weeds, resistance of the target pest or weeds to this product, injury caused by drift, and injury to rotational crops caused by carryover in the soil. Such risks of crop injury, non-performance, resistance, or other unintended consequences are unavoidable and may result because of such factors as weather, soil conditions, disease, moisture conditions, irrigation practices, condition of the crop at the time of application, presence of other materials either applied in the tank mix with this product or prior to application of this product, cultural practices or the manner of use or application, (or a combination of such factors) all of which are factors beyond the control of J. Oliver Products, LLC. The Buyer should be aware that these inherent unintended risks may reduce the harvested yield of the crop in all or a portion of the treated acreage, or otherwise affect the crop such that additional care, treatment and expense are required to take the crop to harvest. If the Buyer chooses not to accept these risks, THEN THIS PRODUCT SHOULD NOT BE APPLIED. By applying this product Buyer acknowledges and accepts these inherent unintended risks AND TO THE FULLEST EXTENT ALLOWED BY LAW, AGREES THAT ALL SUCH RISKS ASSOCIATED WITH THE APPLICATION AND USE ARE ASSUMED BY THE BUYER.

J. Oliver Products, LLC shall not be responsible for losses or damages (including, but not limited to, loss of yield, increased expenses of farming the crop or such incidental, consequential or special damages that may be claimed) resulting from use of this product in any manner not set forth on the label. Buyer assumes all risks associated with the use of this product in any manner or under conditions not specifically directed or approved on the label.

**LIMITED WARRANTY**

J. Oliver Products, LLC warrants only that this product conforms to the chemical description on the label and is reasonably fit for the purposes stated in the label, under average use conditions, when used strictly in accordance with the label and subject to the Risks of Using This Product as described above. To the extent consistent with applicable law AND AS SET FORTH ABOVE, J. OLIVER PRODUCTS, LLC MAKES NO OTHER WARRANTIES, EITHER EXPRESSED OR IMPLIED. No agent or representative of J. Oliver Products, LLC or Seller is authorized to make or create any other express or implied warranty.

**LIMITATION OF LIABILITY**

To the fullest extent allowed by law, J. Oliver Products, LLC or Seller is not liable for any incidental, consequential, indirect or special damages resulting from the use or handling of this product. The limitation includes, but is not limited to, loss of yield on all or any portion of the treated acreage, increased care, treatment or other expenses required to take the crop to harvest, increased finance charges or altered finance ratings, emotional or mental distress and/or exemplary damages. TO THE FULLEST EXTENT ALLOWED BY LAW, THE EXCLUSIVE REMEDY OF THE BUYER, AND THE EXCLUSIVE MAXIMUM LIABILITY OF J. OLIVER PRODUCTS, LLC OR SELLER FOR ANY AND ALL CLAIMS, LOSSES, INJURIES OR DAMAGES (INCLUDING CLAIMS BASED ON BREACH OF WARRANTY, CONTRACT, NEGLIGENCE, TORT, STRICT LIABILITY OR OTHERWISE) RESULTING FROM THE USE OR HANDLING OF THIS PRODUCT SHALL BE THE RETURN OF THE PURCHASE PRICE OF THIS PRODUCT OR, AT THE ELECTION OF J. OLIVER PRODUCTS, LLC OR SELLER, THE REPLACEMENT OF THE PRODUCT.

**PROMPT NOTICE OF CLAIM**

To the extent consistent with applicable law allowing such requirements J. Oliver Products, LLC must be provided notice as soon as Buyer has reason to believe it may have a claim, but in no event later than twenty-one days from date of planting, or twenty-one days from the date of application, whichever is latter, so that an immediate inspection of the affected property and growing crops can be made.

To the extent consistent with applicable law if Buyer does not notify J. Oliver Products, LLC of any claims in such period, it shall be barred from obtaining any remedy.

**NO AMENDMENTS**

J. Oliver Products, LLC and Seller offer this product, and Buyer accepts it, subject to the foregoing Disclaimer, Risks of Using This Product, Limited Warranty and Limitation of Liability, which may not be modified by any oral or written agreement.

**TANK MIXES**

**NOTICE: Tank mixing or use of this product with any other product which is not specifically and expressly authorized by the label shall be the exclusive risk of user, applicator and/or application advisor.**

Read and follow the entire label of each product to be used in the tank mix with this product.

**THE FOLLOWING STATEMENT ON CHEMIGATION WILL BE USED ONLY IF A SUPPLEMENTAL LABEL IS CREATED.**

**CHEMIGATION**

[Do not apply this product through any irrigation system unless the supplemental labeling on chemigation is followed. Refer to supplemental labeling entitled, "Application of CLETHODIM [WARTHOG] 2 EC Onions (dry bulbs and green) and Garlic by Chemigation", for use directions for chemigation.]

May be applied to onions and garlic by sprinkler irrigation systems. Do not apply by chemigation to any other crop, or to this crop using any other type of irrigation system.

**USE INFORMATION**

**FOR USE ON:** Alfalfa, Asparagus, Bean (dry) and Pea (shelled)<sup>1</sup>, Bean and Pea (succulent)



shelled)<sup>2</sup>, Broccoli, Cabbage, Canola\*, Carrot, Cauliflower (and other Head and Stem Brassica Vegetables)<sup>3</sup>, Celery, Clover (grown in Idaho, Oregon and Washington only), Conifers, Cotton, Cranberry, Cucumber, Eggplant (and other Fruiting Vegetables)<sup>4</sup>, Fallow Land (and other non-producing agricultural areas), Flax\*, Garden Beet, Garlic, Herbs<sup>5</sup>, Hops, Horseradish (and other Root Vegetables)<sup>6</sup>, Legume Vegetables (edible podded)<sup>7</sup>, Lettuce, Head and Leaf (and other leafy greens)<sup>8</sup>, Melons (including Cantaloupes and Watermelons)<sup>9</sup>, Mint, Mustard Greens (and other leafy brassica greens)<sup>10</sup>, Mustard Seed\*, Non-Bearing Food Crops, Non-Crop or Non-Planted Areas, Onions (dry bulb and green), Ornamentals, Peanut (including perennial), Peppers (bell and non-bell), Potato, Radish, Rhubarb (and other Leaf Petioles)<sup>11</sup>, Safflower, Sesame, Shallots (dry bulbs and green), Squash (including Pumpkins)<sup>9</sup>, Soybeans, Strawberry, Sugar Beet, Sunflower, Sweet Potato, Tomato and Yam (and other Tuberous and Corm Vegetables)<sup>12</sup>.

\*Not for use in California

- 1 Other Bean (Dry) and Pea (Shelled) crops approved for use with CLETHODIM [WARTHOG] 2 EC include: Bean (*Lupinus* spp.), grain, sweet, white and white sweet; Bean (*Phaseolus* spp.), field, kidney, lima (dry), navy, pinto and tepary; Bean (*Vigna* spp.), adzuki bean, black-eyed pea, catjang, cowpea, crowder pea, moth bean, mung bean, rice bean, Southern pea, urd bean, broad (dry), chickpea (garbanzo), guar, lablab bean and lentil; Pea (*Pisum* spp.), field and pigeon
- 2 Other Bean and Pea (Succulent Shelled) crops approved for use with CLETHODIM [WARTHOG] 2 EC includes: Bean (*Lupinus* spp.), grain, sweet, white and white sweet; Bean (*Phaseolus* spp.), field, kidney, lima (dry), navy, pinto and tepary; Bean (*Vigna* spp.), adzuki bean, black-eyed pea, catjang, cowpea, crowder pea, moth bean, mung bean, rice bean, Southern pea, urd bean, broad (dry), chickpea (garbanzo), guar, lablab bean and lentil; Pea (*Pisum* spp.), field and pigeon
- 3 Other head and stem brassica vegetables approved for use with CLETHODIM [WARTHOG] 2 EC include: Chinese broccoli, Brussels sprouts, Chinese (napa) cabbage, Chinese mustard, cavalo broccolo and kohlrabi.
- 4 Other Fruiting Vegetables (except tomato) approved for use with CLETHODIM [WARTHOG] 2 EC include: eggplant, groundcherry, pepino, peppers (all) and tomatillo.
- 5 Other Herb crops approved for use with CLETHODIM [WARTHOG] 2 EC include: angelica, balm, basil, borage, burnet, camomile, catnip, chervil (dried), chive, Chinese chive, clary, coriander (leaf), costmary, culantro (leaf), curry (leaf), dill (dillweed), horehound, hyssop, lavender, lovage (leaf), marigold, marjoram (*origanum* spp.), nasturtium, parsley (dried), pennyroyal, rosemary, rue, sage and savory, summer and winter.
- 6 Other root vegetables approved for use with CLETHODIM [WARTHOG] 2 EC include: burdock, edible; celeriac; chervil, turnip-rooted; chicory; ginseng; parsley, turnip-rooted; parsnip; radish, oriental; rutabaga; salsify; salsify, black; salsify, Spanish; skirret and turnip.
- 7 Other Edible Podded Legume Vegetable crops approved for use with CLETHODIM [WARTHOG] 2 EC include: Bean (*Phaseolus* spp.), runner, snap and wax; Bean (*Vigna* spp.), asparagus, Chinese longbean, moth, yardlong, jackbean; Pea (*Pisum* spp.), dwarf, edible-pod, snow, sugar snap, pigeon and sword bean.
- 8 Other Leafy Greens crops approved for use with CLETHODIM [WARTHOG] 2 EC include: amaranth (Chinese spinach, leafy amaranth and tampala), arugula (roquette), chervil, chrysanthemum (edible-leaved and garland), corn salad, cress (garden, yellow rock and winter), dandelion, dock (sorrel), endive (escarole), lettuce (head and leaf), orach, parsley, purslane (garden and winter), radicchio (red chicory), spinach (New Zealand and Vine (Indian and malabar).
- 9 Other cucurbit crops approved for use with CLETHODIM [WARTHOG] 2 EC include: Chayote (fruit), Chinese Wax Gourd, Citron Melon, Edible Gourd, Gherkin and Muskmelons (all) including Honeydew Melon.
- 10 Other leafy brassica greens approved for use with CLETHODIM [WARTHOG] 2 EC include: broccoli, raab, Chinese (bok choy) cabbage, collards, kale, mizuna, mustard greens, mustard spinach, rape greens and turnip greens.
- 11 Other leaf petiole crops approved for use with CLETHODIM [WARTHOG] 2 EC include: cardoon, celtuce, Chinese celery, Florence fennel, and Swiss chard.
- 12 Other tuber and corm vegetables approved for use with CLETHODIM [WARTHOG] 2 EC include: arracacha, arrowroot, Chinese artichoke, Jerusalem artichoke, edible burdock, edible canna, bitter and sweet cassava, chayote (root), chufa, dasheen (taro), ginger, leren, tanier, turmeric and bean yam.

CLETHODIM [WARTHOG] 2 EC is not recommended for use on vegetable crops being grown for seed production unless specific use directions are provided.

CLETHODIM [WARTHOG] 2 EC is a selective postemergence herbicide for control of annual and perennial grasses.

CLETHODIM [WARTHOG] 2 EC does not control sedges or broadleaf weeds.

Repeated use of CLETHODIM [WARTHOG] 2 EC (or similar postemergence grass herbicides with the same mode of action) may lead to the selection of naturally occurring biotypes that are resistant to these products in some grass species.

If poor performance occurs and cannot be attributed to adverse weather or application conditions, a resistant biotype may be present. This is most likely to occur in fields where other control strategies such as crop rotation, mechanical removal, and other classes of herbicides are not used from year to year.

Do not allow CLETHODIM [WARTHOG] 2 EC to come in contact with desirable grass crops such as corn, rice, sorghum, small grains, or turf, as these and other grass crops will be injured or killed. Minor leaf spotting may occur on treated plants under certain environmental conditions. New foliage is not affected.

**Control Symptoms**

Treated grass weeds show a reduction in vigor and growth. Early chlorosis/necrosis of younger plant tissue is followed by a progressive collapse of the remaining foliage. Symptoms will generally be observed in 7 to 14 days after application, depending on grass species treated and environmental conditions.

**APPLICATION INFORMATION**

**Timing of Applications**

Apply CLETHODIM [WARTHOG] 2 EC postemergence to actively growing grasses according to rate table recommendations. Applications made to grass plants stressed by insufficient moisture, or hot or cold temperatures, or to grass plants exceeding recommended growth stages may result in unsatisfactory control. Do not apply under these conditions.

In arid regions where irrigation is used to supplement limited rainfall, CLETHODIM [WARTHOG] 2 EC should be applied as soon as possible, after irrigation (within 7 days). In arid regions, a second application of CLETHODIM [WARTHOG] 2 EC will generally provide more effective control of perennial grass weeds than a single application. Make second application to actively growing grass 2 to 3 weeks after emergence of new growth.

Cultivation of treated grasses 7 days prior to or within 7 days after application of CLETHODIM [WARTHOG] 2 EC may reduce weed control. DO NOT APPLY CLETHODIM [WARTHOG] 2 EC if rainfall is expected within one hour, since control may be reduced.

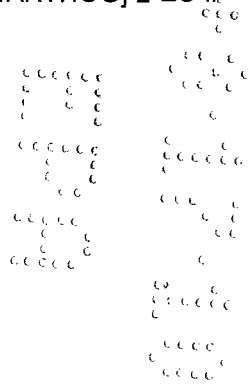

ADDITION OF ADJUVANT OR CROP OIL CONCENTRATE

CROP	ADJUVANT
Alfalfa, Cotton, Bean (dry) & Pea (shelled), Edible Podded Legume Vegetables, Peanuts (including perennial), Potato, Soybean, Bean & Pea (succulent shelled), Sugar Beet and Sunflower	Always use a crop oil concentrate* at 1.0 qt./A by ground or 1 % v/v (but not less than 1 pt./A) in the finished spray volume by air.  1 to 2 qts./A of liquid fertilizer (10-34-0, 28%N or 32%N), or an equivalent amount (2.5 to 4.0 lbs./A) of spray grade ammonium sulfate (AMS) may be added to CLETHODIM [WARTHOG] 2 EC applications, in addition to the recommended rate of crop oil concentrate. The addition of AMS has shown improved grass control for difficult to control species including: quackgrass, rhizome Johnsongrass, red rice, wild oats, volunteer cereals, and volunteer corn.
Asparagus, Canola, Carrot, Clover, Cranberry, Cucurbits, Flax, Fruiting Vegetables (except Tomato), Garden Beet, Garlic, Head & Stem Brassica Vegetables, Herbs, Hops, Leaf Petioles, Leafy Brassica Greens, Leafy Greens, Mint, Mustard Seed, Onion (Dry Bulb & Green), Root Vegetables, Safflower, Sesame, Shallots (Dry Bulb & Green), Strawberry, Sweet Potato (Yam & other Tuberous and Corm Vegetables except Potato) and Tomato	Always use a crop oil concentrate at 1% v/v in the finished spray volume unless tank mix instructions indicate otherwise.  Addition of liquid fertilizer is not recommended for these crops.
Non-Bearing Food Crops, Ornamental Plants,	Add a non-ionic surfactant containing at least 80% active ingredient at the rate of 1 pt. per 50 gals. (0.25% v/v). Use of crop oil concentrate is not recommended since it may injure flowers and foliage.
Conifer Trees, Fallow Land (and other non-producing agricultural areas), and Non-Crop or Non-planted Areas	Always use a crop oil concentrate containing at least 15% emulsifier at 1% v/v (but not less than 1 pt./A) in the finished spray volume.

\*Acceptable crop oil concentrates would be those that contain a minimum of 80% oils and 15% emulsifier. A crop oil concentrate must contain either a petroleum or vegetable oil base and must meet all the following criteria: be non phytotoxic, contain only EPA-exempt ingredients, provide good mixing quality, and be successful in local experience. Highly refined vegetable oils have proven more satisfactory than unrefined vegetable oils.

Ground Application

Use of sufficient spray volumes and pressure is essential to ensure complete coverage. Use a minimum of 5 gals. and a maximum of 40 gals. of spray solution per acre. Under the following conditions a minimum of 10 gals. per acre is required: ultra narrow row cotton, narrow row soybeans, broadleaf herbicide tank mixes, perennial grasses, volunteer corn, drought or stress conditions, heavy grass pressure or when grasses are at or near maximum height. Failure to use a minimum of 10 gals. per acre under these conditions can result in poor coverage and reduced grass control requiring repeat applications. Spray pressures should reflect a minimum of 30 psi and a maximum of 60 psi at the nozzle. Do not use flood nozzles.

Applications to onions (dry bulbs and green), garlic, and shallots (dry bulbs and green) should be made in a minimum of 20 gals. of spray solution per acre.

**Air Application**

Use a minimum of 3 gals. of spray solution per acre unless otherwise directed in this label. Increase spray volumes up to 10 gals. as grass or crop foliage becomes dense. For onions (dry bulbs and green), garlic, or shallots (dry bulbs and green): When applying by air do not exceed 8 fl. oz./A in a single application. In California, air applications to onions, garlic or shallots should be made in a minimum of 20 gals. of spray solution per acre. In states other than California, air application to onions, garlic, or shallots should be made in a minimum of 10 gals. of spray solution per acre.

**NOTE: Crop injury may occur when CLETHODIM [WARTHOG] 2 EC is applied to onions, garlic or shallots with aerial equipment.**

**Spot Treatment**

When using hand sprayers or high volume sprayers utilizing hand guns, mix 1/4% to 1/2% (0.33 oz. to 0.65 oz. per gal.) CLETHODIM [WARTHOG] 2 EC and treat to wet vegetation, while not allowing runoff of spray solution. For uses requiring crop oil concentrate, include crop oil concentrate at 1% (1.3 oz. per gal.) by volume. For uses requiring non-ionic surfactant, include non-ionic surfactant at 1/4% (0.33 oz. per gal.) by volume.

**NOTE: If CLETHODIM [WARTHOG] 2 EC is applied as a spot treatment, care should be taken to not exceed the maximum rate allowed on a "per acre" basis or crop injury may occur.**

**CHEMIGATION - ONION (Dry Bulb and Green) AND GARLIC SPRINKLER IRRIGATION APPLICATION**

**Do not apply CLETHODIM [WARTHOG] 2 EC by chemigation in the states of Idaho, Montana, Oregon and Washington.**

Apply CLETHODIM [WARTHOG] 2 EC at the high rate recommended for annual grasses (16 fl. oz. per acre) when the grass height is at the low end of the range (application to larger grasses may not provide adequate control). Add a crop oil concentrate containing at least 15% emulsifier at 1 quart per acre.

Apply CLETHODIM [WARTHOG] 2 EC in 0.1 to 0.2 acre-inch of water either at the end of a regular irrigation set or as a separate application not associated with a regular irrigation using the least amount of water that provides proper distribution and coverage. Application of more than label recommended quantities of irrigation water per acre may result in decreased product performance by removing the chemical from the zone of effectiveness. Use a metering device to inject the CLETHODIM [WARTHOG] 2 EC into the irrigation water at a constant flow. Constant agitation must be maintained in the chemical supply tank during the entire period of herbicide application. Inject the product with a positive displacement pump into the main line ahead of a right angle turn to ensure adequate mixing. Allow time for all lines to flush the herbicide through all nozzles before turning off irrigation water. To ensure the lines are flushed and free of remaining herbicide, a dye indicator may be injected into the lines to mark the end of the application period.

It is not recommended that CLETHODIM [WARTHOG] 2 EC be applied through an irrigation system connected to a public water system. Public water system means a system for the provision to the public of piped water for human consumption, if such system has at least 15 service connections or regularly serves an average of at least 25 individuals daily at least 60 days out of the year.

**Use Precautions**

- 1. Apply this product only through sprinkler irrigation systems including center pivot, lateral move, end tow, side (wheel) roll, travelers, big gun, solid set, or hand move. Do not apply

this product through any other type of irrigation system.

2. Crop injury, lack of effectiveness, or illegal pesticide residues in the crop may result from non-uniform distribution of treated water.
3. If you have any questions about calibration, you should contact State Extension Service specialists, equipment manufacturers or other experts.
4. Do not connect an irrigation system (including greenhouse systems) used for pesticide application to a public water system unless the label-prescribed safety devices for public water supplies are in place.
5. A person knowledgeable of the chemigation system and responsible for its operation or under supervision of the responsible person, shall shut the system down and make necessary adjustments should the need arise.
6. The system must contain a functional check valve, vacuum relief valve, and low pressure drain appropriately located on the irrigation pipeline to prevent water source contamination from backflow.
7. The pesticide injection pipeline must contain a functional, automatic, quick-closing check valve to prevent the flow of fluid back toward the injection pump.
8. The pesticide injection pipeline must also contain a functional, normally closed solenoid-operated valve located on the intake side of the injection pump and connected to the system interlock to prevent fluid from being withdrawn from the supply tank when the irrigation system is either automatically or manually shut down.
9. The system must contain functional interlocking controls to automatically shut off the pesticide injection pump when the water pump motor stops.
10. The irrigation line or water pump must include a functional pressure switch which will stop the water pump motor when the water pressure decreases to the point where pesticide distribution is adversely affected.
11. Systems must use a metering pump, such as a positive displacement injection pump (e.g., diaphragm pump) effectively designed and constructed of materials that are compatible with pesticides and capable of being fitted with a system interlock.
12. Do not apply when wind speed favors drift beyond the area intended for treatment.

## RESTRICTIONS AND LIMITATIONS

- Do not apply if rain is expected within 1 hour of application as control may be unsatisfactory.
- Do not apply a postemergence broadleaf herbicide within one day following application of CLETHODIM [WARTHOG] 2 EC or reduced grass control may result.
- CLETHODIM [WARTHOG] 2 EC is not recommended for use on vegetable crops being grown for seed production unless specific use directions are provided.
- For canola, do not apply more than 6 fl. oz. of CLETHODIM [WARTHOG] 2 EC per acre per season. For clover, flax, mustard seed and radish crops, do not apply more than 16 fl. oz. of CLETHODIM [WARTHOG] 2 EC (0.25 lb. ai) per acre per season. For all other crops, do not apply more than 32 fl. oz. of CLETHODIM [WARTHOG] 2 EC (0.50 lb. ai) per acre per season. Application on Long Island, New York, is restricted to no more than 16 fl. oz. of CLETHODIM [WARTHOG] 2 EC (0.25 lb. ai) per acre per season.
- Do not apply more than 8 fl. oz./A of CLETHODIM [WARTHOG] 2 EC **per application** to the following crops: asparagus, brassica vegetables (head and stem), bean (succulent shelled), carrot, cranberry, cucurbits, flax, fruiting vegetables (except tomato), garden beet, green onion, herbs, hops, leaf petioles, leafy brassica greens, leafy greens, legume vegetables (edible podded), non-bearing food crops, pea (shelled), pea (succulent shelled), root vegetables, safflower, sesame and strawberry. Do not apply more than 6 fl. oz./A of CLETHODIM [WARTHOG] 2 EC per application to canola or mustard seed. For all other crops, do not apply more than 16 fl. oz. of CLETHODIM [WARTHOG] 2 EC (0.25 lb. ai) per acre per application. **Exceeding these recommendations may result in unacceptable crop injury.**
- Do not apply under conditions of stress. Applying CLETHODIM [WARTHOG] 2 EC under conditions that do not promote active grass growth will reduce herbicide effectiveness. These conditions include drought, excessive water, extremes in temperature, low humidity and grasses either partially controlled or stunted from prior pesticide applications. Grasses under these kinds of stressful conditions will not absorb and translocate CLETHODIM [WARTHOG] 2 EC effectively, and will be less susceptible to herbicide activity.
- Optimal perennial grass control can be obtained if rhizomes or stolons are cut up by preplant tillage practices, (discing, plowing, etc.) to stimulate maximum emergence of grass shoots. Cultural practices, such as continuous no-tillage in which the perennial grass rhizomes or stolons are not cut up, result in a very staggered, non-uniform weed emergence. Due to this non-uniform weed emergence, no fewer than 2 CLETHODIM [WARTHOG] 2 EC applications per season per year are recommended at the appropriate weed-growth stage rate under continuous no-till conditions.
- Grass crops such as corn, rice, sorghum, small grains, or turf, etc. are highly sensitive to CLETHODIM [WARTHOG] 2 EC.
- While all the vegetable crops on this label have been tested and are tolerant to CLETHODIM [WARTHOG] 2 EC, not all specialty varieties of these crops have been tested. It is advised that, before applying CLETHODIM [WARTHOG] 2 EC to specialty varieties of vegetable crops on this label, crop tolerance be investigated first using a small section of the field. It is possible that injury symptoms can occur. Symptoms may appear as leaf speckling or stunting.
- Always read and follow the restrictions and limitations for all products whether used alone

or in a tank mix. The most restrictive labeling of any product used applies in tank mixtures, including all crop rotational and other crop restrictions.

- Tank mixes of CLETHODIM [WARTHOG] 2 EC and broadleaf herbicides may result in reduced grass control. If grass regrowth occurs, an additional application of CLETHODIM [WARTHOG] 2 EC may be necessary. **AVOID SPRAY DRIFT.**
- Do not allow spray from ground or aerial equipment to drift onto adjacent land or crops. When drift may be a problem, do everything possible to reduce spray drift, including:
  1. Do not spray if wind speeds are or become excessive.
  2. Do not spray if wind speed is 10 mph or greater. If sensitive crops or plants are downwind, extreme caution must be used under all conditions.
  3. Do not spray if winds are gusty.
  4. Use extreme caution when conditions are favorable for drift (high temperatures, drought, low relative humidity), especially when sensitive plants are located nearby.
  5. Do not apply when a temperature inversion exists. If inversion conditions are suspected, consult with local weather services before making an application.
  6. Further reductions in drift can be obtained by:
    - a) Using large droplet size sprays. Do not use nozzles that produce small droplets. Orient nozzles downward and slightly backward as needed to reduce drift for ground applications.
    - b) Orienting nozzles straight back with the windstream, using straight stream orifices for aerial applications. Use the lowest number of nozzles practical with the largest possible orifice size to obtain the minimum 3 GPA volume. Application height and boom length should be set according to manufacturer's instructions to minimize drift.
    - c) Increasing the volume of spray mixture (for example, a minimum of 10 GPA for ground applications) by using higher flow rate nozzles. Using lower pressure with the appropriate nozzle to obtain higher volumes will also reduce drift.
    - d) Applying as close to target plants as practical while maintaining a good spray pattern for adequate coverage.

**Do not apply under conditions involving possible drift to food, forage or other plantings that might be damaged or the crops thereof rendered unfit for sale, use or consumption.**

**CROP SPECIFIC RESTRICTIONS AND LIMITATIONS FOR CLETHODIM [WARTHOG] 2 EC**

Crops <sup>(1)</sup>	Minimum Time From Application to Harvest (PHI)	Use Rates Per Acre	Crop Oil Concentrate Rates Per Acre <sup>(2)</sup>	Special Use Instructions
Alfalfa including: Sainfoin Holy Clover Birdsfoot trefoil <sup>(3)</sup>	15 days before grazing, feeding or harvesting (cutting) for forage or hay	6-16 fl. oz <sup>(4)</sup>	1 qt. by ground or 1% v/v (but not less than 1 pt./A) by air <sup>(5)</sup>	Refer to tank mix partners for feeding, grazing and harvesting restrictions. <sup>(5,6)</sup>  The addition of AMS has shown improved grass control for difficult to control species including:

160457

**CROP SPECIFIC RESTRICTIONS AND LIMITATIONS FOR CLETHODIM [WARTHOG] 2 EC**

Crops <sup>(1)</sup>	Minimum Time From Application to Harvest (PHI)	Use Rates Per Acre	Crop Oil Concentrate Rates Per Acre <sup>(2)</sup>	Special Use Instructions
				quackgrass, rhizome Johnsongrass, red rice, wild oats, volunteer cereals, and volunteer corn.
<b>Asparagus</b>	1 day	6-8 fl. oz.	1% v/v in the finished spray volume.	Do not apply more than 8 fl. oz./A in a single application.  For repeat applications make on a minimum of a 14 day interval.
<b>Bean, Dry</b> including: Bean ( <i>Lupinus</i> spp.) Grain Sweet White White Sweet Bean ( <i>Phaseolus</i> spp.) Field Kidney Lima (dry) Navy Pinto Tepary Bean ( <i>Vigna</i> spp.) Adzuki Bean Black-eyed Pea Catjang Cowpea Crowder Pea Moth Bean Mung Bean Rice Bean Southern Pea Urd Bean Broad (dry) Chickpea (garbanzo) Guar Lablab Bean Lentil	30 days	6-16 fl. oz.	1 qt. by ground or 1% v/v (but not less than 1 pt./A) by air. <sup>(5)</sup>	Do not apply more than 16 fl. oz./A per application.  For repeat applications make on a minimum of a 14 day interval.  Refer to appropriate Table for reduced rate recommendations for the control of small annual grasses.  The addition of AMS has shown improved grass control for difficult to control species including: quackgrass, rhizome Johnsongrass, red rice, wild oats, volunteer cereals and volunteer corn.
<b>Bean, Succulent Shelled</b> including: Bean ( <i>Phaseolus</i> spp.) Broad Bean (succulent) Lima Bean (green) Bean ( <i>Vigna</i> spp.) Black-eyed Pea Cowpea Southern Pea	21 days	6-8 fl. oz.	1 qt. by ground or 1% v/v (but not less than 1 pt./A) by air. <sup>(5)</sup>	Refer to appropriate Table for reduced rate recommendations for the control of small annual grasses.  Do not apply more than one (1) application per acre per season.  The addition of AMS has shown improved grass control for difficult to control species including: quackgrass, rhizome Johnsongrass, red rice, wild oats, volunteer cereals and volunteer corn.
<b>Beet, Garden</b>	30 days	6-8 fl. oz.	1% v/v in the finished spray volume.	Do not apply more than 8 fl. oz./A in a single application.  For repeat applications make on a



**CROP SPECIFIC RESTRICTIONS AND LIMITATIONS FOR CLETHODIM [WARTHOG] 2 EC**

Crops <sup>(1)</sup>	Minimum Time From Application to Harvest (PHI)	Use Rates Per Acre	Crop Oil Concentrate Rates Per Acre <sup>(2)</sup>	Special Use Instructions
<b>Brassica Vegetables, Head &amp; Stem</b> including: Broccoli Brussels sprouts Cabbage Cauliflower	30 days	6-8 fl. oz.	1% v/v in the finished spray volume.	minimum of a 14 day interval. Do not apply more than 8 fl. oz./A in a single application. For repeat applications make on a minimum of a 14 day interval.
<b>Canola</b>	70 days	4-6 fl. oz.	1% v/v in the finished spray volume.	Do not apply after crop has begun bolting. Crop injury may occur when CLETHODIM [WARTHOG] 2 EC is applied during the bloom period. Do not apply more than 6 oz./A in a single application. Do not exceed 6 fl. oz./A in a season.
<b>Carrot</b>	30 days	6-8 fl. oz.	1% v/v in the finished spray volume.	Do not apply more than 8 fl. oz./A in a single application. For repeat applications make on a minimum of a 14 day interval.
<b>Clover</b>	15 days before grazing, feeding, or harvesting (cutting) for forage or hay	6-16 fl. oz.	1% v/v in the finished spray volume.	For use on clover grown in the states of Idaho, Oregon and Washington only. Do not exceed 16 fl. oz./A in a season.
<b>Cotton</b>	60 days	6-16 fl. oz.	1 qt. by ground or 1% v/v (but not less than 1 pt./A) by air. <sup>(5)</sup>	Do not graze treated fields or feed treated forage or hay to livestock. The addition of AMS has shown improved grass control for difficult to control species including: quackgrass, rhizome Johnsongrass, red rice, wild oats, volunteer cereals, and volunteer corn.
<b>Cranberry</b>	30 days	6-8 fl. oz.	1% v/v in the finished spray volume.	Do not apply more than 8 fl. oz./A in a single application. Do not apply between the "hook" stage and full fruit set. For repeat applications make on a minimum of a 14 day interval.
<b>Cucurbits</b> including: Chayote (fruit) Chinese Wax Gourd Citron Melon Cucumber Gherkin Gourd, Edible Muskmelons (all) including: Cantaloupes Honeydew Melon Pumpkin Squash (all) Watermelon	14 days	6-8 fl. oz.	1% v/v in the finished spray volume.	Do not apply more than 8 fl. oz./A in a single application. For repeat applications make on a minimum of a 14 day interval.

**CROP SPECIFIC RESTRICTIONS AND LIMITATIONS FOR CLETHODIM [WARTHOG] 2 EC**

Crops <sup>(1)</sup>	Minimum Time From Application to Harvest (PHI)	Use Rates Per Acre	Crop Oil Concentrate Rates Per Acre <sup>(2)</sup>	Special Use Instructions
<b>Fallow Land</b> <b>Conifer Trees</b> (and other non-producing agricultural areas) <b>Non-Crop or Non-Planted Areas</b>	N/A	6-16 fl. oz.	1% v/v (but not less than 1 pt./A) in the finished spray volume using a crop oil concentrate containing at least 15% emulsifier.	Do not plant any crop for 30 days after application unless clethodim is registered for use in that crop.
<b>Flax</b>	60 days	6-8 fl. oz.	1% v/v in the finished spray volume.	Apply prior to bloom. Crop injury may occur when CLETHODIM [WARTHOG] 2 EC is applied during the bloom period.  Do not apply more than 8 fl. oz./A in a single application.  Do not exceed 16 fl. oz./A in a season.
<b>Fruiting Vegetable</b> (except Tomato) including: Eggplant Groundcherry Pepino Peppers (all) Tomatillo	20 days	6-8 fl. oz.	1% v/v in the finished spray volume.	Do not apply more than 8 fl. oz./A in a single application.  For repeat applications make on a minimum of a 14 day interval.
<b>Herbs</b> including: Angelica Balm Basil Borage Burnet Camomile Catnip Chervil (dried) Chive Chive, Chinese Clary Coriander (leaf) Costmary Culantro (leaf) Curry (leaf) Dill (dillweed) Horehound Hyssop Lavender Lovage (leaf) Marigold Marjoram ( <i>Origanum</i> spp.) Nasturtium Parsley (dried) Pennyroyal Rosemary Rue Sage Savory, Summer and Winter	14 days	6-8 fl. oz.	1% v/v in the finished spray volume.	CLETHODIM [WARTHOG] 2 EC has not been tested on all herbs, and herb varieties. It is the responsibility of the user to test CLETHODIM [WARTHOG] 2 EC on a small portion of the crop to be treated before treating the entire field.  Crop tolerance should be verified to CLETHODIM [WARTHOG] 2 EC on a small area of the herb crop, at the desired CLETHODIM [WARTHOG] 2 EC rate and with the same crop oil concentrate that will be used on the herb field. If no crop response is evident seven (7) days after treatment, CLETHODIM [WARTHOG] 2 EC may be used on the entire field at the rate tested and with the same crop oil used in the tolerance test.  Do not apply more than 8 fl. oz./A in a single application.  For repeat applications make on a minimum of a 14 day interval.

## CROP SPECIFIC RESTRICTIONS AND LIMITATIONS FOR CLETHODIM [WARTHOG] 2 EC

Crops <sup>(1)</sup>	Minimum Time From Application to Harvest (PHI)	Use Rates Per Acre	Crop Oil Concentrate Rates Per Acre <sup>(2)</sup>	Special Use Instructions
Hops	21 days	6-8 fl. oz.	1% v/v in the finished spray volume.	Do not apply more than 8 fl. oz./A in a single application.  For repeat applications make on a minimum of a 14 day interval.

**CROP SPECIFIC RESTRICTIONS AND LIMITATIONS FOR CLETHODIM [WARTHOG] 2 EC**

Crops <sup>(1)</sup>	Minimum Time From Application to Harvest (PHI)	Use Rates Per Acre	Crop Oil Concentrate Rates Per Acre <sup>(2)</sup>	Special Use Instructions
<b>Leaf Petioles</b> including: Cardoon Celery Celtuce Chinese Celery Fennel, Florence (finocchio) Rhubarb Swiss Chard	30 days	6-8 fl. oz.	1% v/v in the finished spray volume.	Do not apply more than 8 fl. oz./A in a single application.  For repeat applications make on a minimum of a 14 day interval.
<b>Leafy Brassica Greens</b> including: Broccoli Raab Cabbage, Chinese (bok choy) Collards Kale Mizuna Mustard Greens Mustard Spinach Rape Greens Turnip Greens	14 days	6-8 fl. oz.	1 % v/v in the finished spray volume.	Do not apply more than 8 fl. oz./A in a single application.  For repeat applications make on a minimum of a 14 day interval.
<b>Leafy Greens</b> including: Amaranth Chinese Spinach Leafy Amaranth Tampala Arugula (roquette) Chervil Chrysanthemum, Edible-leaved Chrysanthemum, Garland Corn Salad Cress Garden Upland (yellow rock and winter) Dandelion Dock (sorrel) Endive (escarole) Lettuce, Head and Leaf Orach Parsley Purslane Garden Winter Radicchio (red chicory) Spinach New Zealand Vine (indian and malabar)	14 days	6-8 fl. oz.	1% v/v in the finished spray volume.	Do not apply more than 8 fl. oz./A in a single application.  For repeat applications make on a minimum of a 14 day interval.

**CROP SPECIFIC RESTRICTIONS AND LIMITATIONS FOR CLETHODIM [WARTHOG] 2 EC**

Crops <sup>(1)</sup>	Minimum Time From Application to Harvest (PHI)	Use Rates Per Acre	Crop Oil Concentrate Rates Per Acre <sup>(2)</sup>	Special Use Instructions
<b>Legume Vegetables, Edible Podded</b> including: Bean ( <i>Phaseolus</i> spp.) Runner Snap Wax Bean ( <i>Vigna</i> spp.) Asparagus Chinese Longbean Moth Yardlong Jackbean Pea ( <i>Pisum</i> spp.) Dwarf Edible-pod Snow Sugar Snap Pigeon Sword Bean	21 days	6-8 fl. oz.	1 qt. by ground or 1% v/v (but not less than 1 pt./A) by air. <sup>(5)</sup>	Do not apply more than 8 fl. oz./A in a single application.  Do not apply more than one (1) application per acre per season.  For peas apply before bloom, but no later than 21 days before harvest.  Refer to appropriate Table for reduced rate recommendations for the control of small annual grasses.  The addition of AMS has shown improved grass control for difficult to control species including: quackgrass, rhizome Johnsongrass, red rice, wild oats, volunteer cereals, and volunteer corn.
<b>Mint</b>	21 days	6-16 fl. oz. <sup>(4)</sup>	1 qt. by ground or 1% v/v (but not less than 1 pt./A by air.)	Do not apply more than 16 fl. oz./A in a single application.  For repeat applications make on a minimum of a 14 day interval.
<b>Mustard Seed</b>	75 days	4-6 fl. oz.	1% v/v in the finished spray volume.	Do not apply after crop has begun bolting. Crop injury may occur when CLETHODIM [WARTHOG] 2 EC is applied during the bloom period.  Do not apply more than 6 fl. oz./A in a single application.  Do not exceed 16 fl. oz/A in a season.
<b>Onion</b> (Dry Bulb Only) <b>Garlic</b> <b>Shallot</b> (Dry Bulb Only)	45 days	6-16 fl. oz. <sup>(7), (8)</sup>	1% v/v in the finished spray volume.	Minimum of 20 gals./A spray volume by ground in entire U.S.  Minimum of 20 gals./A spray volume by air in California. <sup>(9)</sup>  In states other than California, air applications to onions, garlic or shallots should be made in a minimum of 10 gals./A.
<b>Onion, Green</b> including: Green Eschalot Green Shallot Japanese Bunching Onion Leeks Scallion or Spring Onion	14 days	6-8 fl. oz.	1% v/v in the finished spray volume.	Do not apply more than 8 fl. oz./A in a single application.  For repeat applications make on a minimum of a 14 day interval.

**CROP SPECIFIC RESTRICTIONS AND LIMITATIONS FOR CLETHODIM [WARTHOG] 2 EC**

Crops <sup>(1)</sup>	Minimum Time From Application to Harvest (PHI)	Use Rates Per Acre	Crop Oil Concentrate Rates Per Acre <sup>(2)</sup>	Special Use Instructions
<p><b>Ornamentals</b></p> <p><b>Non-Bearing Food Crops</b></p>	<p>N/A</p> <p>N/A</p>	<p>6-16 fl. oz.</p> <p>6-8 fl. oz. <sup>(8)</sup></p>	<p>Use of crop oil concentrate is not recommended since it may injure flowers and foliage. See Special Use Instructions.</p>	<p>Add a non-ionic surfactant containing at least 80% active ingredient at the rate of 1 pt. per 50 gals. (0.25% v/v).</p> <p>Sugar maples cannot be tapped for syrup within one year of CLETHODIM [WARTHOG] 2 EC application.</p> <p>Do not apply more than 8 fl. oz./A in a single application to non-bearing food crops.</p>
<p><b>Pea, Shelled</b> including: Pea (<i>Pisum</i> spp.) Field Pigeon</p>	<p>30 days</p>	<p>6-8 fl. oz.</p>	<p>1 qt. by ground or 1% v/v (but not less than 1 pt./A) by air. <sup>(5)</sup></p>	<p>Do not apply more than 8 fl. oz./A per application.</p> <p>Do not apply more than one (1) application per acre per season.</p> <p>Apply before bloom but not later than 30 days prior to harvest. <sup>(10)</sup></p> <p>Refer to appropriate Table for reduced rate recommendations for the control of small annual grasses.</p> <p>The addition of AMS has shown improved grass control for difficult to control species including: quackgrass, rhizome Johnsongrass, red rice, wild oats, volunteer cereals and volunteer corn.</p>
<p><b>Pea, Succulent Shelled</b> including: Pea (<i>Pisum</i> spp.) English Pea Garden Pea Green Pea Pigeon Pea</p>	<p>21 days</p>	<p>6-8 fl. oz.</p>	<p>1 qt. by ground or 1% v/v (but not less than 1 pt./A) by air. <sup>(5)</sup></p>	<p>Do not apply more than 8 fl. oz./A per application.</p> <p>Do not apply more than one (1) application per acre per season.</p> <p>Apply before bloom but not later than 21 days prior to harvest. <sup>(10)</sup></p> <p>Refer to appropriate Table for reduced rate recommendations for the control of small annual grasses.</p> <p>The addition of AMS has shown improved grass control for difficult to control species including: quackgrass, rhizome Johnsongrass, red rice, wild oats, volunteer cereals and volunteer corn.</p>
<p><b>Peanut (including Perennial)</b></p>	<p>40 days</p>	<p>6-16 fl. oz.</p>	<p>1 qt. by ground or 1% v/v (but not less than 1 pt./A) by air. <sup>(5)</sup></p>	<p>The addition of AMS has shown improved grass control for difficult to control species including: quackgrass, rhizome Johnsongrass, red rice, wild oats, volunteer cereals, and volunteer corn.</p>

## CROP SPECIFIC RESTRICTIONS AND LIMITATIONS FOR CLETHODIM [WARTHOG] 2 EC

Crops <sup>(1)</sup>	Minimum Time From Application to Harvest (PHI)	Use Rates Per Acre	Crop Oil Concentrate Rates Per Acre <sup>(2)</sup>	Special Use Instructions
Potato	30 days	6-16 fl. oz.	1 qt. by ground or 1% v/v (but not less than 1 pt./A) by air. <sup>(5)</sup>	The addition of AMS has shown improved grass control for difficult to control species including: quackgrass, rhizome Johnsongrass, red rice, wild oats, volunteer cereals, and volunteer corn.
Radish	15 days	6-8 fl. oz.	1% v/v in the finished spray volume.	Do not apply more than 8 fl. oz./A in a single application.  Do not apply more than 16 fl. oz./A (0.25 lb. ai) per acre in a season.  For repeat applications make on a minimum of a 14 day interval.
Root Vegetables (except Radish), including: Chicory Ginseng Horseradish Turnip	30 days	6-8 fl. oz.	1% v/v in the finished spray volume.	Do not apply more than 8 fl. oz./A in a single application.  For repeat applications make on a minimum of a 14 day interval.
Safflower	70 days	6-8 fl. oz.	1% v/v in the finished spray volume.	Do not apply more than 8 fl. oz./A in a single application.  For repeat applications make on a minimum of a 14 day interval.
Sesame	14 days	6-8 fl. oz.	1% v/v in the finished spray volume.	Do not apply during flowering.  Do not apply more than 8 fl. oz./A in a single application.  For repeat applications make on a minimum of a 14 day interval.
Soybean	60 days	6-16 fl. oz.	1 qt. by ground or 1% v/v (but not less than 1 pt./A) by air. <sup>(5)</sup>	Do not graze treated fields or feed treated forage or hay to livestock.  Refer to appropriate Table for reduced rate recommendations for the control of small annual grasses.  The addition of AMS has shown improved grass control for difficult to control species including: quackgrass, rhizome Johnsongrass, red rice, wild oats, volunteer cereals, and volunteer corn.
Strawberry	4 days	6-8 fl. oz.	1% v/v in the finished spray volume.	Do not apply more than 8 fl. oz./A in a single application.  For repeat applications make on a minimum of a 14 day interval.

**CROP SPECIFIC RESTRICTIONS AND LIMITATIONS FOR CLETHODIM [WARTHOG] 2 EC**

Crops <sup>(1)</sup>	Minimum Time From Application to Harvest (PHI)	Use Rates Per Acre	Crop Oil Concentrate Rates Per Acre <sup>(2)</sup>	Special Use Instructions
<b>Sugar Beet</b>	40 days	6-16 fl. oz.	1 qt. by ground or 1% v/v (but not less than 1 pt./A) by air. <sup>(5)</sup>	Refer to appropriate Table for reduced rate recommendations for the control of small annual grasses.  The addition of AMS has shown improved grass control for difficult to control species including: quackgrass, rhizome Johnsongrass, red rice, wild oats, volunteer cereals, and volunteer corn.
<b>Sunflower</b>	70 days	6-16 fl. oz.	1 qt. by ground or 1% v/v (but not less than 1 pt./A) by air. <sup>(5)</sup>	The addition of AMS has shown improved grass control for difficult to control species including: quackgrass, rhizome Johnsongrass, red rice, wild oats, volunteer cereals, and volunteer corn.
<b>Sweet Potato, Yam and other Tuberous and Corm Vegetables (except Potato) including:</b> Artichoke Chinese Jerusalem Cassava Bitter Sweet Ginger	30 days	6-16 fl. oz.	1% v/v in the finished spray volume.	The addition of AMS has shown improved grass control for difficult to control species including: quackgrass, rhizome, Johnsongrass, red rice, wild oats, volunteer cereals and volunteer corn.
<b>Tomato</b>	20 days	6-16 fl. oz.	1% v/v in the finished spray volume.	For repeat applications make on a minimum of a 14 day interval.

N/A = Not Applicable

- 1 CLETHODIM [WARTHOG] 2 EC is not recommended for use on vegetable crops being grown for seed production unless specific use directions are provided.
- 2 Acceptable crop oil concentrates would be those which contain a minimum of 80% oils and 15% emulsifier. A crop oil concentrate must contain either a petroleum or vegetable oil base and must meet all the following criteria: be non phytotoxic, contain only EPA-exempt ingredients, provide good mixing quality and be successful in local experience. Highly refined vegetable oils have proven more satisfactory than unrefined vegetable oils. See the Addition of Adjuvant and Crop Oil Concentrate section for further information.
- 3 CLETHODIM [WARTHOG] 2 EC may be applied to seedling or established alfalfa grown for seed, hay, silage, green chop or direct grazing.
- 4 For weed control in established alfalfa and mint, the minimum use rate is 10 fl. oz./A.
- 5 1 to 2 qts./A of liquid fertilizer (10-34-0, 28%N or 32%N), or an equivalent amount (2.5 to 4.0 lbs./A) of spray grade ammonium sulfate (AMS) may be added to CLETHODIM [WARTHOG] 2 EC applications, in addition to the recommended rate of crop oil concentrate.
- 6 Do not apply CLETHODIM [WARTHOG] 2 EC plus 2,4-DB as a tank mix to alfalfa unless the 60 day feeding, grazing, and harvesting restriction on the 2,4-DB label can be observed.
- 7 For ground applications to garlic or shallot, do not exceed 3 fl. oz./A in a single application. For air applications to onion, garlic or shallot, do not exceed 8 fl. oz./A in a single application. For garlic and shallot, do not exceed 2 applications per season. In CA for air applications to onion, do not exceed 2



applications per season.

- 8 If CLETHODIM [WARTHOG] 2 EC is applied as a spot treatment to onion, garlic, shallot, or non-bearing food crops, care should be taken to not exceed the maximum rate allowed on a "per acre" basis or crop injury may occur.
- 9 In California, do not apply CLETHODIM [WARTHOG] 2 EC to onion, garlic, or shallot until the crop has at least two full leaves. In California, 14 day spray intervals are recommended between the application of CLETHODIM [WARTHOG] 2 EC and liquid nitrogen or other herbicide applications. Injury to crop may occur when shorter intervals are observed.
- 10 Applications of CLETHODIM [WARTHOG] 2 EC to peas during the bloom period could result in severe crop injury, including loss of yield and delayed maturity.

**IMPORTANT**

Plant tolerance to CLETHODIM [WARTHOG] 2 EC at labeled rates has been found to be acceptable for the indicated genera and species listed below. Due to variability within species, crop growth stage, environmental conditions, and application techniques, it is recommended that the user determine if the herbicide can be used safely on a few plants prior to widespread application. Neither the seller nor the manufacturer of CLETHODIM [WARTHOG] 2 EC have investigated the safety factor to plants not listed on the label.

**NON-BEARING FOOD CROPS**

**CLETHODIM [WARTHOG] 2 EC SHOULD NOT BE APPLIED TO NON-BEARING FRUIT OR NUT CROPS WHICH ARE GROWN FOR ROOT STOCK.**

**Crop injury to non-bearing fruit and nut crops can occur if CLETHODIM [WARTHOG] 2 EC is improperly applied. CLETHODIM [WARTHOG] 2 EC should not be applied directly over the top of these plant types. Instead, spray should be directed at the base of the plant where grassy weeds are growing near the ground.**

Non-bearing fruit and nut crops are plants which will not bear fruit or nuts for at least one year following CLETHODIM [WARTHOG] 2 EC application.

COMMON NAME	SCIENTIFIC NAME
Apples	<i>Malus spp.</i>
Berries	<i>Vaccinium spp.</i>
	<i>Rubus spp.</i>
Cherry, Sweet	<i>Prunus avium</i>
Citrus Fruits	<i>Citrus spp.</i>
Grapes	<i>Vitis spp.</i>
Olives	<i>Olea spp.</i>
Peach	<i>Prunus persica</i>
Pears	<i>Pyrus communis</i>
Prunes	<i>Prunus spp.</i>
Stone Fruits	<i>Prunus spp.</i>
Strawberries	<i>Fragaria spp.</i>
Tree Nuts	
Almond	<i>Prunus triloba</i>
Filbert	<i>Corylus maxima</i>
Pecan	<i>Carya illinoensis</i>
Pistachio	<i>Pistacia vera</i>
Walnut	<i>Juglans spp.</i>

**CONIFER TREES**

CLETHODIM [WARTHOG] 2 EC can be used to control labeled grasses in Christmas tree farms, conifer nurseries, and conifer plantations (but not in forests).

<b>COMMON NAME</b>	<b>SCIENTIFIC NAME</b>
Arborvitae, American	<i>Thuja occidentalis</i>
Cedars	<i>Cedrus spp.</i>
Cypress	<i>Taxodium spp.</i>
Fir, Douglas	<i>Pseudotsuga menziesii</i>
Firs	<i>Abies spp.</i>
Hemlock, Canadian/Eastern	<i>Tsuga canadensis</i>
Hemlock, Western	<i>Tsuga heterophylla</i>
Pines	<i>Pinus spp.</i>
Spruces	<i>Picea spp.</i>
Yew	<i>Taxus spp.</i>

**NON-CROP OR NON-PLANTED AREAS**

The following areas are considered non-crop or non-planted areas: rights-of-way including railroads, highways, roads, dividers, medians, pipelines, public utility lines, pumping stations, transformer stations and substations. Around airports, electric utilities, commercial buildings, manufacturing plants, storage yards, rail yards, fence lines, parkways, and post-harvest croplands. Also beneath greenhouse benches and around golf courses.

ANNUAL GRASSES (EXCEPT FOR IN ESTABLISHED ALFALFA AND MINT)				
GRASS SPECIES	SCIENTIFIC NAME	WEED HEIGHT* (inches)	RATE FL. OZ./ ACRE	HIGH RATE <sup>(1)</sup>
Barnyardgrass	<i>Echinochloa crus-galli</i>	2 to 8	6	8
Broadleaf Signalgrass	<i>Brachiaria platyphylla</i>	2 to 6	6	8
Brome				
California	<i>Bromus carinatus</i>	2 to 6	6	8
Cheat	<i>Bromus secalinus</i>	2 to 6	6	8
Downy	<i>Bromus tectorum</i>	2 to 6	6	8
Ripgut	<i>Bromus diandrus</i>	2 to 6	6	8
Canarygrass	<i>Phalaris canariensis</i>	1 to 4	6	8
Crabgrass				
Hairy	<i>Digitaria adscendens</i>	2 to 6**	6	8
Large	<i>Digitaria sanguinalis</i>	2 to 6**	6	8
Smooth	<i>Digitaria ischaemum</i>	2 to 6**	6	8
Southern	<i>Digitaria ciliaris</i>	2 to 6**	6	8
Crowfootgrass	<i>Dactyloctenium aegyptium</i>	2 to 6**	6	8
Fall Panicum	<i>Panicum dichotomiflorum</i>	2 to 8	6	8
Field Sandbur	<i>Cenchrus incertus</i>	2 to 6	6	8
Foxtail				
Giant	<i>Setaria faberi</i>	2 to 12	6	8
Green	<i>Setaria viridis</i>	2 to 8	6	8
Yellow	<i>Setaria glauc</i>	2 to 8	6	8
Goosegrass	<i>Eleusine indica</i>	2 to 6**	6	8
Itchgrass	<i>Rottboellia cochinchinensis</i>	2 to 6	6	8
Junglerice	<i>Echinochloa colona</i>	2 to 6	6	8
Lovegrass (Stinkgrass)	<i>Eragrostis cilianensis</i>	2 to 6	6	8
Rabbitsfootgrass	<i>Polypogon monspeliensis</i>	1 to 4	6	8
Red Rice	<i>Oryza sativa</i>	1 to 3	6	8
Ryegrass				
Hardy	<i>Lolium remotum</i>	2 to 6	6	8
Italian	<i>Lolium multiflorum</i>	2 to 6	6	8
Seedling Johnsongrass	<i>Sorghum halepense</i>	4 to 10	6	8
Shattercane	<i>Sorghum bicolor</i>	6 to 18	6	8
Southwestern Cupgrass	<i>Eriochloa gracilis</i>	2 to 6	6	8

continued

**ANNUAL GRASSES**  
(EXCEPT FOR IN ESTABLISHED ALFALFA AND MINT) (continued)

GRASS SPECIES	SCIENTIFIC NAME	WEED HEIGHT (inches)*	RATE FL. OZ./ ACRE	HIGH RATE <sup>(1)</sup>
Sprangle top				
Amazon	<i>Leptochloa panicoides</i>	2 to 6	6	8
Bearded	<i>Leptochloa fascicularis</i>	2 to 6	6	8
Mexican	<i>Leptochloa uninervia</i>	2 to 6	6	8
Red	<i>Leptochloa filiformis</i>	2 to 6	6	8
Texas Panicum	<i>Panicum texanum</i>	2 to 6	6	8
Volunteer Cereals <sup>(2)</sup>				
Barley	<i>Hordeum vulgare</i>	2 to 6	6	8
Oats	<i>Avena sativa</i>	2 to 6	6	8
Rye	<i>Secale cereale</i>	2 to 6	6	8
Wheat	<i>Triticum aestivum</i>	2 to 6	6	8
Volunteer Corn <sup>(3)</sup>	<i>Zea mays</i>	4 to 12	4	6
Volunteer Corn <sup>(3)</sup>	<i>Zea mays</i>	12 to 24	6	8
Volunteer Corn (S.R.) <sup>(4)</sup>	<i>Zea mays</i>	4 to 12	8 (suppression only)	
Volunteer Grain Sorghum	<i>Sorghum bicolor</i>	8 to 12	6	8
Wild Oats	<i>Avena fatua</i>	2 to 6	6	8
Wild Proso Millet	<i>Panicum miliaceum</i>	2 to 10	6	8
Witchgrass	<i>Panicum capillare</i>	2 to 8	6	8
Woolly Cupgrass	<i>Eriochloa villosa</i>	2 to 8	6	8

- Apply only to actively growing grasses at recommended weed heights.
- Apply when the first grass weed species in a mixed grass weed population reaches the recommended growth stage for treatment.
- Use the high rate under heavy grass pressure and/or when grasses are at maximum height.
- Do not apply more than 8 fl. oz./A of CLETHODIM [WARTHOG] 2 EC per application to the following crops: asparagus, carrot, cranberry, cucurbits, flax, fruiting vegetables (except tomato), garden beets, green onion, head and stem brassica vegetables, herbs, hops, leaf petioles, leafy brassica greens, leafy greens, non-bearing food crops, root vegetables, safflower, sesame and strawberry. Do not apply more than 6 fl. oz./A of CLETHODIM [WARTHOG] 2 EC per application to canola or mustard seed.

\* Generally occurs between 3-leaf stage and tillering.

\*\* Length of lateral growth.

(1) Rates higher than 8 fl. oz./A may be applied in certain geographic areas, cropping situations, or environmental conditions, where experience has shown that higher rates are needed for satisfactory control of annual grasses. In these situations, rates from 8 to 16 fl. oz./A may be applied. Do not apply more than 8 fl. oz./A of CLETHODIM [WARTHOG] 2 EC per application to the following crops: asparagus, carrot, cranberry, cucurbits, flax, fruiting vegetables (except tomato), garden beet, green onion, head and stem brassica vegetables, herbs, hops, leaf petioles, leafy brassica greens, leafy greens, non-bearing food crops, root vegetables, safflower, sesame and strawberry. Do not apply more than 6 fl. oz./A of CLETHODIM [WARTHOG] 2 EC per application to canola or mustard seed.

(2) When a cereal grain crop (such as wheat) is interseeded for crop establishment or is planted as wind breaks aid crop establishment, the minimum CLETHODIM [WARTHOG] 2 EC use rate for control is 8 fl. oz./A.

(3) Includes Roundup Ready®, Liberty Link® and IMI-CORN® volunteer corn.

(4) Sethoxydim resistant volunteer corn.

ANNUAL & PERENNIAL GRASS CONTROL IN ESTABLISHED ALFALFA AND MINT WITH CLETHODIM [WARTHOG] 2 EC			
GRASS SPECIES	WEED STAGE	RATE FL. OZ./ ACRE	HIGH RATE
Annual & Perennial Grasses Listed in Grass Table	See Table	10	16
<p><b>Mowing:</b> The best control of annual grasses can be achieved by applying CLETHODIM [WARTHOG] 2 EC before grass weeds are mowed. Once a grass is mowed it becomes tougher to control, as much of the available leaf surface has been removed. In areas without a killing frost, some annuals can over-winter after having been mowed multiple times. These grasses form large crowns and may contain many viable buds. These grasses, even though they may be an annual grass, may require repeated applications of CLETHODIM [WARTHOG] 2 EC for partial or complete control.</p> <p><b>Irrigated Alfalfa and Mint:</b> Irrigation practices can be very critical to the successful use of CLETHODIM [WARTHOG] 2 EC in established alfalfa and mint and may be necessary to initiate active growth of the weeds prior to application. Generally applications 2 to 4 days after an irrigation are most effective. Irrigation made shortly after application (2 days) can be effective, but more consistent grass control occurs when the irrigation is made before the application.</p> <p><b>Aerial Application:</b> Apply CLETHODIM [WARTHOG] 2 EC in a minimum of 10 GPA in established alfalfa and mint when applying by air.</p> <p><b>Annual Grass Control:</b> Apply CLETHODIM [WARTHOG] 2 EC at the grass sizes indicated in the Recommendation for Annual Grass Table and rates indicated. If a grass has been cut, apply CLETHODIM [WARTHOG] 2 EC after active growth has resumed and regrowth has reached the minimum height and before it reaches the maximum height indicated. Apply before the alfalfa/mint canopy covers the grasses and interferes with the spray coverage. Some annual grasses are spring- and summer-germinating plants, while others are fall-germinating plants, and the time they are actively growing and most susceptible to CLETHODIM [WARTHOG] 2 EC may vary from region to region. Also some annuals germinate over a extended period of time, and because control of small grasses is desired, applications after each weed flush may be required. As a general rule spray spring and summer-germinating grasses as early in the season as possible, after initial green-up. Spray fall-germinating weeds in the fall soon after they begin growing but before any damage is done due to frost. Late fall applications may be less effective due to environmental conditions, such as frost, slower plant growth, or the onset of flowering.</p> <p><b>Perennial Grass Control:</b> CLETHODIM [WARTHOG] 2 EC effectively controls perennial grasses such as bermudagrass, Johnsongrass, quackgrass, wirestem muhly, tall fescue, foxtail barley and orchardgrass. Due in part to lack of tillage, perennial grasses are more difficult to control in a perennial crop such as established alfalfa or mint. A program of repeated applications is usually necessary for best results. The best way to control perennial grasses is to do so in the year of stand establishment before rhizomes and stolons become large and difficult to kill.</p> <p>Use the high rate under heavy grass pressure and/or when grasses are at or near maximum height.</p> <p>Always add a crop oil concentrate at 1 qt./A by ground or 1% v/v (but not less than 1 pt./A) to the finished spray volume by air.</p>			

**ANNUAL BLUEGRASS CONTROL  
WITH CLETHODIM [WARTHOG] 2 EC**

GRASS SPECIES	WEED STAGE	RATE FL. OZ./ ACRE	HIGH RATE
Annual Bluegrass ( <i>Poa annua</i> )	to 4-leaf	6*	16
<ul style="list-style-type: none"> <li>• Apply under favorable soil moisture and humidity, which exists within a few days after rainfall or within 7 days after irrigation. Grass needs to be actively growing at time of application(s).</li> <li>• Apply at weed stage indicated on the label, as reduced control can be expected with more mature annual bluegrass.</li> <li>• Use the high rate under heavy grass pressure and/or when annual bluegrass is more mature.</li> <li>• Always add a crop oil concentrate at 1 qt./A by ground to the finished spray volume.</li> </ul>			
<p>*Use a minimum of 10 fl. oz./A to control annual bluegrass in seedling and established alfalfa and mint.</p>			

**DIRECTIONS FOR REDUCED RATE TO CONTROL  
SMALL ANNUAL GRASSES IN CANOLA, BEAN (DRY) & PEA (SHELLED) (INCLUDING  
SOYBEAN), EDIBLE PODDED LEGUME VEGETABLES, FLAX, MUSTARD SEED,  
BEAN & PEA (SUCCULENT SHELLED) AND SUGAR BEET  
(REDUCED RATE NOT FOR USE IN CALIFORNIA)**

GRASS SPECIES	SCIENTIFIC NAME	WEED HEIGHT (inches)	RATE FL.OZ/ ACRE <sup>(1)</sup>
Barnyardgrass	<i>Echinochloa crus-galli</i>	1 to 4	4
Broadleaf Signalgrass	<i>Brachiaria platyphylla</i>	1 to 4	5
<b>Crabgrass</b>			
Large	<i>Digitaria sanguinalis</i>	1 to 3*	4
Large	<i>Digitaria sanguinalis</i>	1 to 4*	5
Smooth	<i>Digitaria ischaemum</i>	1 to 3*	4
Smooth	<i>Digitaria ischaemum</i>	1 to 4*	5
Southern	<i>Digitaria ciliaris</i>	1 to 4*	5
Fall Panicum	<i>Panicum dichotomiflorum</i>	1 to 4	4
<b>Foxtail</b>			
Giant	<i>Setaria faberi</i>	1 to 4	4
Green	<i>Setaria viridis</i>	1 to 4	4
Millet	<i>Setaria italica</i>	1 to 4	5
Yellow	<i>Setaria glauca</i>	1 to 4	4
Seedling Johnsongrass	<i>Sorghum halepense</i>	1 to 6	5
Shattercane	<i>Sorghum bicolor</i>	4 to 10	4
Texas Panicum	<i>Panicum texanum</i>	1 to 4	5
<b>Volunteer Cereals</b>			
Barley	<i>Hordeum vulgare</i>	1 to 4	5
Oats	<i>Avena sativa</i>	1 to 4	5
Wheat	<i>Triticum aestivum</i>	1 to 4	5
Volunteer Corn**	<i>Zea mays</i>	4 to 12	4
Wild Proso Millet	<i>Panicum miliaceum</i>	1 to 6	4
Wild Oats	<i>Avena fatua</i>	1 to 4	5

- Apply only to actively growing grasses at recommended weed heights.
- Apply when the first grass weed species in a mixed grass weed population reaches the recommended growth stage for treatment.
- Regrowth by tillering may occur if application is made when plants are stressed by lack of moisture, excessive moisture, low or high temperatures and/or under very low humidity.

\* Length of lateral growth

\*\* Not S.R. Corn

(1) Always add a crop oil concentrate at 1 qt./A by ground application to the finished spray volume.

PERENNIAL GRASSES			
GRASS SPECIES	WEED HEIGHT (inches)	RATE FL. OZ./ ACRE	HIGH RATE
<b>Bermudagrass (<i>Cynodon dactylon</i>)</b>			
First Application	3 (or up to 6" runners)	8	16
Repeat Application(s) (if regrowth occurs)	3 (or up to 6" runners)	8	16
<b>Fescue, Tall (<i>Festuca arundinacea</i>)</b>			
First Application	4 to 8	8	16
Repeat Application(s) (if regrowth occurs)	4 to 8	8	16
<b>Foxtail Barley (<i>Hordeum jubatum</i>)</b>			
First Application	2 to 6	8	16
Repeat Application(s) (if regrowth occurs)	2 to 6	8	16
<b>Orchardgrass (<i>Dactylis glomerata</i>)</b>			
First Application	4 to 8	8	16
Repeat Application(s) (if regrowth occurs)	4 to 8	8	16
<b>Quackgrass* (<i>Elytrigia repens</i>)</b>			
First Application	4 to 12	8	16
Repeat Application(s) (if regrowth occurs)	4 to 12	8	16
<b>Rhizome Johnsongrass (<i>Sorghum halepense</i>)</b>			
First Application	12 to 24	8	16
Repeat Application(s) (if regrowth occurs)	6 to 18	6	8
<b>Wirestem Muhly (<i>Muhlenbergia frondosa</i>)</b>			
First Application	4 to 8	8	16
Repeat Application(s) (if regrowth occurs)	4 to 8	8	16
<b>Perennial Bluegrass*</b>			
<b>Roughstalk (<i>Poa trivialis</i>)</b>			
<b>Kentucky (<i>Poa prantensis</i>)</b>			
First Application	2 to 4	8	16
Repeat Application(s) (if regrowth occurs)	2 to 4	8	16
<b>Bentgrass* (<i>Agrostis</i> spp.)</b>			
First Application	2 to 4	-	16
Repeat Application(s) (if regrowth occurs)	2 to 4	-	16
<ul style="list-style-type: none"> <li>• Apply only to actively growing grasses at recommended weed heights.</li> <li>• Apply when the first grass weed species in a mixed grass weed population reaches the recommended growth stage for treatment.</li> <li>• Use the high rate under heavy grass pressure and/or when grasses are at maximum height.</li> <li>• Do not apply more than 8 fl. oz./A of CLETHODIM [WARTHOG] 2 EC per application to the following crops: asparagus, carrot, cranberry, cucurbits, flax, fruiting vegetables (except tomato), garden beet, green onion, head &amp; stem brassica vegetables, herbs, hops, leaf petioles, leafy brassica greens, leafy greens, non-bearing food crops, root vegetables, safflower, sesame and strawberry. Do not apply more than 6 fl. oz./A of CLETHODIM [WARTHOG] 2 EC per application to canola or mustard seed.</li> </ul>			
*Control of quackgrass, perennial bluegrass and bentgrass with CLETHODIM [WARTHOG] 2 EC may be enhanced by adding AMS at 2.5 to 4.0 lbs./A			



## TANK MIXES

### USE INFORMATION

The labels for each of the herbicides recommended for tank mixing with CLETHODIM [WARTHOG] 2 EC are unique to the characteristics of those products and contain restrictions and limitations that may be more restrictive than the CLETHODIM [WARTHOG] 2 EC label in certain considerations. Those concerns may include, but are not limited to:

1. Geographic restrictions - all products are not registered for use in all areas and rates may vary from one region of labeled use to another;
2. Crop rotation restrictions;
3. Applicator certification requirements;
4. Worker safety rules (e.g. protective clothing, reentry time, posting);
5. Soil type or soil characteristics (e.g. pH, OM);
6. Maximum dosage or number of applications per season;
7. Rain free period required; or
8. Application timing (e.g. pre-harvest interval)
9. Do not exceed the total season rates.

**THE MOST RESTRICTIVE LABELING OF ANY PRODUCT USED IN A TANK MIX MUST BE FOLLOWED.**

### TANK MIX APPLICATION OF CLETHODIM [WARTHOG] 2 EC AND BROADLEAF HERBICIDES FOR CONTROL OF GRASSES AND BROADLEAF WEEDS

- Apply only to actively growing grass and broadleaf weeds at recommended height or growth stage listed on each label.
- Apply when the first grass or broadleaf weed species in a mixed population reaches the recommended height or growth stage for treatment.
- Apply under favorable soil moisture and humidity that exist a few days after rainfall or within seven days after irrigation.
- Always add the appropriate adjuvant to the spray mix at the rate recommended for each specific tank mix combination.
- Tank mix applications may sometimes result in reduced grass control and possible increases in crop injury as compared to either product used alone. If regrowth occurs, or an additional flush of new grass emerges, make a second application of CLETHODIM [WARTHOG] 2 EC, as specified in the respective size and rate tables.
- Do not tank mix CLETHODIM [WARTHOG] 2 EC when broadleaf weeds are tall and/or dense enough to prevent proper grass coverage.

### MIXING INSTRUCTIONS

1. Fill clean spray tank 1/2 to 2/3 of desired level with clean water.
2. While agitating, add the correct amount of CLETHODIM [WARTHOG] 2 EC. Agitation should create a rippling or rolling action on the water surface.
3. If tank mixing CLETHODIM [WARTHOG] 2 EC with other labeled herbicides, add water soluble bags first, followed by dry formulations, flowables, emulsifiable concentrates, and then solutions. Prepare no more spray mixture than is required for the immediate spray operation.
4. Add any required adjuvants (crop oil concentrate, non-ionic surfactant and/or nitrogen solution).
5. Fill spray tank to desired level with water. **Agitation should continue until all spray solution has been applied.**

Failure to agitate the spray solution may result in improper mixing of the herbicides and unsatisfactory weed control. Mixing and compatibility qualities should be verified by a jar test.

**INFORMATION ON ANTAGONISM**

Tank mixes of CLETHODIM [WARTHOG] 2 EC with postemergence broadleaf herbicides have shown some reduction or failure to control certain grass species which would have otherwise been controlled when CLETHODIM [WARTHOG] 2 EC is applied alone. Activity of the postemergence broadleaf herbicide in the tank mix is not affected.

**ALFALFA**

**Table 1. CLETHODIM [WARTHOG] 2 EC TANK MIXES WITH BROADLEAF HERBICIDES FOR ALFALFA (Refer to the recommendation tables above for specific grasses and growth stages)**

PRODUCT <sup>(2)</sup>	APPLICATION RATES/ACRE <sup>(1)</sup>		CROP OIL CONCENTRATE <sup>(3)</sup> (V/V)	
	ANNUAL GRASSES	PERENNIAL GRASSES	GROUND	AIR
CLETHODIM [WARTHOG] 2 EC + 2,4-DB <sup>(4)</sup>	10 to 16 fl. oz. + Refer to 2,4-DB label	10 to 16 fl. oz. + Refer to 2,4-DB label	1%	1%
CLETHODIM [WARTHOG] 2 EC + PURSUIT DG <sup>(5)</sup> or PURSUIT <sup>(5)</sup>	10 to 16 fl. oz. + 1.08 to 2.16 oz. or 3 to 6 fl. oz.	-	1%	1%
CLETHODIM [WARTHOG] 2 EC + BUCTRIL® 2L <sup>(6)</sup> or BUCTRIL GEL <sup>(6,7)</sup>	10 to 16 fl. oz. + 1.0 to 1.5 pts. or 0.5 to 0.75 pt.	-	0.5%	0.5%

(1) If grass regrowth occurs or an additional flush of new grass emerges, make a second application of CLETHODIM [WARTHOG] 2 EC alone (without a tank mix herbicide), according to the appropriate size and rate recommendations.

(2) Broadleaf weed control may be reduced when grass populations are tall or dense enough to intercept the spray pattern and prevent them from receiving complete coverage. Tank mixing is not recommended in these situations.

(3) Always use a crop oil concentrate at the listed rate (but not less than 1 pt./A) in the finished spray volume. (4) CLETHODIM [WARTHOG] 2 EC plus 2,4-DB may increase the severity of crop injury when tank mixed. Alfalfa plants will generally outgrow this temporary crop injury within a few weeks.

(5) Before using this tank mix, read and understand the PURSUIT or PURSUIT DG labels for geographical restrictions and restrictions regarding alfalfa growth stage and type. Failure to do so can result in crop injury to alfalfa. Do not feed, graze, or harvest alfalfa for 30 days following an application of PURSUIT to alfalfa.

(6) In the states of Washington, Oregon, Idaho, Montana, Wyoming, Colorado, Utah, Nevada and the western halves of North Dakota, South Dakota, Nebraska, and Kansas: The CLETHODIM [WARTHOG] 2 EC plus BUCTRIL or BUCTRIL GEL tank mix must be applied in the fall or spring to seedling alfalfa when the majority of the field has a minimum of 2 trifoliates. Unacceptable crop injury may occur to alfalfa seedlings less than the 2 trifoliolate leaf stage. CLETHODIM [WARTHOG] 2 EC plus BUCTRIL or BUCTRIL GEL applications made when temperatures are expected to exceed 80°F at (and 3 days following) application can result in unacceptable crop injury. In the states not listed above, apply in the fall or spring to seedling alfalfa when the majority of the field has a minimum of 4 trifoliolate leaves. When alfalfa stand is uneven and conditions favor leaf burn, unacceptable crop injury may occur to alfalfa in the 2 trifoliolate or smaller stage of growth. CLETHODIM [WARTHOG] 2 EC plus BUCTRIL or BUCTRIL GEL applications made when temperatures are expected to exceed 70°F at (and 3 days following) application can result in unacceptable crop injury. Crop leaf burn can occur following CLETHODIM [WARTHOG] 2 EC plus BUCTRIL or BUCTRIL GEL application. Warm, humid conditions may enhance leaf burn. New crop growth will not be affected.

(7) Do not apply when alfalfa is under moisture, temperature, insect or disease stress or has been stressed by other pesticide carryover or application.

### CANOLA

**Table 2. REDUCED RATE CLETHODIM [WARTHOG] 2 EC TANK MIXES WITH BROADLEAF HERBICIDES FOR CANOLA**

(Refer to the recommendation tables above for specific grasses and growth stages.)

PRODUCT	APPLICATION RATES/ACRE		AMMONIUM SULFATE	
	ANNUAL GRASSES <sup>(1)</sup>	PERENNIAL GRASSES	GROUND	AIR
CLETHODIM [WARTHOG] 2 EC <sup>(2)</sup> + LIBERTY <sup>(3)</sup>	4 to 5 fl. oz. + 34 fl. oz.	-	3.0 lbs.	3.0 lbs.

(1) Annual grasses and sizes controlled with these tank mixtures are those that are identified in the DIRECTIONS FOR REDUCED RATE TO CONTROL SMALL ANNUAL GRASSES table.  
 (2) Do not apply Clethodim [Warthog] 2 EC tank mix during or after bolting or flowering or crop injury may occur.  
 (3) For use only on LibertyLink® canola

### COTTON

**Table 3. CLETHODIM [WARTHOG] 2 EC TANK MIXED WITH COBRA® AND MSMA APPLIED POST DIRECTED TO COTTON**

PRODUCT <sup>(1)</sup>	APPLICATION RATES/ACRE <sup>(2)</sup>		CROP OIL CONCENTRATE <sup>(3)</sup>	COMMENTS
	ANNUAL GRASSES	PERENNIAL GRASSES	GROUND	
CLETHODIM [WARTHOG] 2 EC <sup>(4)</sup> + COBRA + MSMA (4.0 lbs./gal.) or MSMA (6.6 lbs./gal.)	6 to 8 fl. oz.	8 to 16 fl. oz.	1%	Reduce broadcast rate in proportion to the band area actually treated.
	See COBRA label for rates to control broadleaf weeds and height limitations for cotton. Refer to the CLETHODIM [WARTHOG] 2 EC label for weed height and species controlled.			
	See MSMA label for rates to control broadleaf weeds and height limitations for cotton. Refer to the CLETHODIM [WARTHOG] 2 EC label for weed height and species controlled.			

(1) Broadleaf weed control may be reduced when grass populations are tall or dense enough to intercept the spray pattern and prevent them from receiving complete coverage. Tank mixing is not recommended in these situations.  
 (2) If grass regrowth occurs or an additional flush of new grass emerges, make a second application of CLETHODIM [WARTHOG] 2 EC alone (without a tank mix herbicide), according to the appropriate size and rate recommendations.  
 (3) Always use a crop oil concentrate at the listed rate (but not less than 1 pt./A) in the finished spray volume.  
 (4) If at the time of application, grass height is so tall that post-directed applications cannot get good coverage over the top of the grassy weeds, then poor control may result and a second (non-post directed) application of CLETHODIM [WARTHOG] 2 EC may be necessary.

**COTTON** (continued)

**Table 4. CLETHODIM [WARTHOG] 2 EC TANK MIXED WITH BUCTRIL 4 EC TO CONTROL EMERGED WEEDS IN BXN COTTON AS A BROADCAST APPLICATION**

PRODUCT <sup>(1)</sup>	APPLICATION RATE/ACRE <sup>(2)</sup>		CROP OIL CONCENTRATE PER ACRE <sup>(3)</sup>	COMMENTS <sup>(7)</sup>
	ANNUAL GRASSES	PERENNIAL GRASSES		
CLETHODIM [WARTHOG] 2 EC + BUCTRIL 4 EC <sup>(4,5,6)</sup>	8 to 16 fl. oz.		1 qt.	See charts for grasses controlled.
<p>(1) Broadleaf weed control may be reduced when grass populations are tall or dense enough to intercept the spray pattern and prevent them from receiving complete coverage.</p> <p>(2) If grass regrowth occurs or an additional flush of new grass emerges, make a second application of CLETHODIM [WARTHOG] 2 EC at the recommended rate with the appropriate amount of crop oil concentrate in a non-BUCTRIL tank mix.</p> <p>(3) Always add a crop oil concentrate at 1 qt./A by ground in the finished spray solution.</p> <p>(4) Applications of BUCTRIL 4 EC can be made only to cotton that has been genetically modified for crop tolerance to postemergence over-the-top applications of bromoxynil.</p> <p>(5) Do not apply the CLETHODIM [WARTHOG] 2 EC plus BUCTRIL tank mix within 75 days of harvest.</p> <p>(6) Do not exceed 2 applications of BUCTRIL before cotton is 12 inches tall and one application after 12 inches tall.</p> <p>(7) Use a minimum of 10 gals. of spray solution per acre.</p>				

**Table 5. CLETHODIM [WARTHOG] 2 EC TANK MIXED WITH GLYPHOSATE TO CONTROL EMERGED GRASSES IN COTTON AS A BROADCAST APPLICATION**

PRODUCT	APPLICATION RATE/ACRE <sup>(1)</sup>		ADJUVANT		COMMENTS
	ANNUAL GRASSES	PERENNIAL GRASSES	Glyphosate formulation <b>with</b> built in adjuvant	Glyphosate formulation <b>without</b> built in adjuvant	
CLETHODIM [WARTHOG] 2 EC + GLYPHOSATE	6 to 8 fl. oz.	8 to 16 fl. oz.	Non-ionic surfactant @ 0.125 to 0.25% v/v plus ammonium sulfate @ 8.5 to 17 lbs. per 100 gals. of carrier	Crop oil concentrate @ 1 pt./A plus ammonium sulfate @ 8.5 to 17 lbs. per 100 gals. of carrier	See charts for grasses controlled.  Use a minimum of 10 gals. of spray solution per acre.
<p>(1) If grass regrowth occurs or an additional flush of new grass emerges, make a second application of CLETHODIM [WARTHOG] 2 EC at the recommended rate with the appropriate amount of crop oil concentrate.</p>					

### BEANS (DRY AND SUCCULENT SHELLLED)

**Table 6. CLETHODIM [WARTHOG] 2 EC TANK MIXES WITH BROADLEAF HERBICIDES FOR BEANS (DRY AND SUCCULENT SHELLLED)**

(Refer to the recommendation tables above for specific grasses and growth stages.)

PRODUCT <sup>(2)</sup>	APPLICATION RATES/ACRE <sup>(1)</sup>		CROP OIL CONCENTRATE <sup>(3)</sup> (V/V)	
	ANNUAL GRASSES	PERENNIAL GRASSES	GROUND	AIR
			8 to 10 fl. oz. + 1.0 to 2.0 pts.	10 to 16 fl. oz. + 1 to 2 pts.

(1) If grass regrowth occurs or an additional flush of new grass emerges, make a second application of CLETHODIM [WARTHOG] 2 EC alone (without a tank mix herbicide), according to the appropriate size and rate recommendations.  
 (2) Broadleaf weed control may be reduced when grass populations are tall enough or dense enough to intercept the spray pattern and prevent them from receiving complete coverage. Tank mixing is not recommended in these situations.  
 (3) Always use a crop oil concentrate at the listed rate (but not less than 1 pt./A) in the finished spray volume.

### FLAX

**Table 7. REDUCED RATE CLETHODIM [WARTHOG] 2 EC TANK MIXES WITH BROADLEAF HERBICIDES FOR FLAX**

(Refer to the recommendation tables above for specific grasses and growth stages)

PRODUCT	APPLICATION RATES/ACRE		CROP OIL CONCENTRATE	
	ANNUAL GRASSES <sup>(1)</sup>	PERENNIAL GRASSES	GROUND	AIR
CLETHODIM [WARTHOG] 2 EC + BRONATE ADVANCED <sup>TM(2,3)</sup>	4 to 5 fl. oz. + 11.4 fl. oz.	-	1 pt.	1 pt.
CLETHODIM [WARTHOG] 2 EC + BRONATE <sup>®(2,3)</sup>	4 to 5 fl. oz. + 0.9 pt.	-	1 pt.	1 pt.
CLETHODIM [WARTHOG] 2 EC + BUCTRIL <sup>(2,3)</sup>	4 to 5 fl. oz. + 1.0 pt.	-	1 pt.	1 pt.
CLETHODIM [WARTHOG] 2 EC + RHONOX <sup>®(2,3)</sup>	4 to 5 fl. oz. + 0.25 to 0.5 pt.	-	1 pt.	1 pt.

(1) Annual grasses and sizes controlled with these tank mixtures are those that are identified in the DIRECTIONS FOR REDUCED RATE TO CONTROL SMALL ANNUAL GRASSES table.  
 (2) Do not apply Clethodim [Warthog] 2 EC tank mix during or after the bud stage or to ornamental flax or crop injury may occur.  
 (3) Do not apply tank mixes if temperatures are expected to exceed 85°F at (or 3 days following) application or crop injury may occur.

38057

### SOYBEAN

**Table 8. CLETHODIM [WARTHOG] 2 EC TANK MIXES<sup>(3)</sup> TO CONTROL ANNUAL GRASSES WHEN USED AS A BURNDOWN IN NO-TILL SOYBEAN**

PRODUCT	PRODUCT RATE/ACRE <sup>(1)</sup>	GRASS HEIGHT (inches)	CROP OIL CONCENTRATE /ACRE <sup>(2)</sup>	28%N OR 32%N QTS./A OR 2.5 TO 4.0 LBS. AMS
CLETHODIM [WARTHOG] 2 EC + 2,4-D ester <sup>(3)</sup>	3 fl. oz.	Foxtail 1 to 3 Fall Panicum 1 to 3	1 qt.	1 to 2 qts. or 2.5 to 4.0 lbs. AMS
	4 fl. oz.	Foxtail 1 to 4 Fall Panicum 1 to 4	1 qt.	1 to 2 qts. or 2.5 to 4.0 lbs. AMS
	6 to 8 fl. oz. + 0.5 lb. ai	(See Grass Chart for grasses claimed.)	1 qt.	1 to 2 qts. or 2.5 to 4.0 lbs. AMS

\*2,4-D ester should not be used where drift sensitive crops may be grown.

(1) If regrowth occurs or an additional flush of new grass emerges, make a second application of CLETHODIM [WARTHOG] 2 EC according to the appropriate size and rate recommendations.

(2) Always use a crop oil concentrate at the listed rate in the finished spray volume.

(3) The following products can be tank mixed with CLETHODIM [WARTHOG] 2 EC plus 2,4-D ester: VALOR® AUTHORITY® BROADLEAF, CANOPY XL®, DUAL® 8 E, DUAL II®, DUAL MAGNUM®, PROWL®, SENCOR®, SENCOR plus the DUAL products and TURBO®.

**Table 9. CLETHODIM [WARTHOG] 2 EC TANK MIXES WITH BROADLEAF HERBICIDES FOR SOYBEAN**

(Refer to the recommendation tables above for specific grasses and growth stages.)

PRODUCT <sup>(2)</sup>	APPLICATION RATES/ACRE <sup>(1)</sup>		CROP OIL CONCENTRATE <sup>(3)</sup> (V/V)	
	ANNUAL GRASSES	PERENNIAL GRASSES	GROUND	AIR
CLETHODIM [WARTHOG] 2 EC + COBRA	6 to 8 fl. oz. + 12.5 fl. oz.	8 to 16 fl. oz. + 12.5 fl. oz.	0.5 to 1%	1%
CLETHODIM [WARTHOG] 2 EC + BASAGRAN 4 SL	8 to 10 fl. oz. + 1 to 2 pts.	10 to 16 fl. oz. + 1 to 2 pts.	1%	1%
CLETHODIM [WARTHOG] 2 EC + Glyphosate (For use on Roundup Ready soybean only)	6 to 8 fl. oz. + 0.75 to 3.0 lb. ai	8 to 16 fl. oz. + 0.75 to 3.0 lb. ai	0.5 to 1% <sup>(4)</sup>	1% <sup>(4)</sup>
CLETHODIM [WARTHOG] 2 EC + ULTRA BLAZER®	6 to 8 fl. oz. + 1 to 1.5 pts.	6 to 8 fl. oz. + 1 to 1.5 pts.	0.5 to 1%	1%

continued

**Table 9. CLETHODIM [WARTHOG] 2 EC TANK MIXES WITH BROADLEAF HERBICIDES FOR SOYBEAN**  
 (Refer to the recommendation tables above for specific grasses and growth stages.)  
 (continued)

PRODUCT <sup>(2)</sup>	APPLICATION RATES/ACRE <sup>(1)</sup>		CROP OIL CONCENTRATE <sup>(3)</sup> (V/V)	
	ANNUAL GRASSES	PERENNIAL GRASSES	GROUND	AIR
CLETHODIM [WARTHOG] 2 EC + FLEXSTAR® HL <sup>(6)</sup>	6 to 8 fl. oz. Refer to the FLEXSTAR HL label for specific application rates.	8 to 16 fl. oz. Refer to the FLEXSTAR HL label for specific application rates.	1%	1%
CLETHODIM [WARTHOG] 2 EC + CLASSIC® 25 DG	8 to 10 fl. oz. + 0.5 to 0.75 oz.	10 to 16 fl. oz. + 0.5 to 0.75 oz.	1%	1%
CLETHODIM [WARTHOG] 2 EC <sup>(4)</sup> + PURSUIT® 70 DG	6 to 8 fl. oz. + 1.44 oz.	8 to 16 fl. oz. + 1.44 oz.	1%	1%
CLETHODIM [WARTHOG] 2 EC <sup>(5)</sup> + COBRA + CLASSIC 25 DG	8 to 10 fl. oz. + 6 to 8 fl. oz. + 0.5 to 0.75 oz.	-	0.5%	1%
CLETHODIM [WARTHOG] 2 EC <sup>(5)</sup> + COBRA + BASAGRAN 4 SL	8 to 10 fl. oz. + 6 to 10 fl. oz. + 1 to 1.5 pts.	-	0.5%	1%
CLETHODIM [WARTHOG] 2 EC <sup>(5)</sup> + COBRA + PURSUIT 70 DG	8 to 10 fl. oz. + 6 to 10 fl. oz. + 1.44 oz.	-	0.5%	1%
CLETHODIM [WARTHOG] 2 EC <sup>(5)</sup> + STORM®	8 to 10 fl. oz. + 1.5 pts.	-	0.5%	1%

continued

**Table 9. CLETHODIM [WARTHOG] 2 EC TANK MIXES WITH BROADLEAF HERBICIDES FOR SOYBEAN**

(Refer to the recommendation tables above for specific grasses and growth stages.)

(continued)

PRODUCT <sup>(2)</sup>	APPLICATION RATES/ACRE <sup>(1)</sup>		CROP OIL CONCENTRATE <sup>(3)</sup> (V/V)	
	ANNUAL GRASSES	PERENNIAL GRASSES	GROUND	AIR
CLETHODIM [WARTHOG] 2 EC <sup>(5)</sup> + RESOURCE® + PURSUIT 70 DG	8 to 10 fl. oz. + 4 fl. oz. + 1.44 oz.	-	1%	1%
CLETHODIM [WARTHOG] 2 EC <sup>(5)</sup> + RESOURCE + BASAGRAN	8 to 10 fl. oz. + 4 fl. oz. + 1 pt.	-	1%	1%
CLETHODIM [WARTHOG] 2 EC <sup>(5)</sup> + RESOURCE + CLASSIC	8 to 10 fl. oz. + 4 fl. oz. + 0.5 oz.	-	1%	1%
CLETHODIM [WARTHOG] 2 EC <sup>(5)</sup> + COBRA + RESOURCE	6 to 8 fl. oz. + 6 fl. oz. + 4 fl. oz.	-	0.5%	1%
CLETHODIM [WARTHOG] 2 EC <sup>(5)</sup> + FIRSTRATE®	6 to 8 fl. oz. + 0.3 oz.	8 to 16 fl. oz. + 0.3 oz.	1%	-
CLETHODIM [WARTHOG] 2 EC <sup>(5)</sup> + COBRA + FIRSTRATE	6 to 8 fl. oz. + 6 to 8 fl. oz. + 0.3 oz.	8 to 16 fl. oz. + 6 to 8 fl. oz. + 0.3 oz.	1%	-
CLETHODIM [WARTHOG] 2 EC <sup>(5)</sup> + RAPTOR® (1 AS)	6 to 8 fl. oz. + 4 to 5 fl. oz.	-	1%	-
CLETHODIM [WARTHOG] 2 EC <sup>(5)</sup> + COBRA + RAPTOR (1 AS)	6 to 8 fl. oz. + 6 to 8 fl. oz. + 4 to 5 fl. oz.	-	1%	-

continued



**Table 9. CLETHODIM [WARTHOG] 2 EC TANK MIXES WITH BROADLEAF HERBICIDES FOR SOYBEAN**

(Refer to the recommendation tables above for specific grasses and growth stages.)

(continued)

PRODUCT <sup>(2)</sup>	APPLICATION RATES/ACRE <sup>(1)</sup>		CROP OIL CONCENTRATE <sup>(3)</sup> (V/V)	
	ANNUAL GRASSES	PERENNIAL GRASSES	GROUND	AIR
CLETHODIM [WARTHOG] 2 EC <sup>(5)</sup> + SYNCHRONY® STS™	6 to 8 fl. oz. <sup>(7)</sup> + 0.5 oz./A	-	1 qt.	-
CLETHODIM [WARTHOG] 2 EC <sup>(5)</sup> + COBRA Herbicide + SYNCHRONY STS™	6 to 8 fl. oz. <sup>(7)</sup> + 4 to 8 fl. oz. + 0.5 oz.	-	1 pt.	-
CLETHODIM [WARTHOG] 2 EC <sup>(5)</sup> + RESOURCE	6 to 8 fl. oz. + 4 to 12 fl. oz.	-	1 qt.	-
CLETHODIM [WARTHOG] 2 EC <sup>(5)</sup> + FRONTROW™	8 to 10 fl. oz. + Refer to FRONTROW label for use rates.	-	1%	-
CLETHODIM [WARTHOG] 2 EC + FIRSTRATE + FLEXSTAR HL <sup>(5)</sup>	6 to 8 fl. oz. + 0.3 oz. + Refer to the FLEXSTAR HL label for specific application rates.	8 to 16 fl. oz. + 0.3 oz. + Refer to the FLEXSTAR HL label for specific application rates.	1%	-

(1) If grass regrowth occurs or an additional flush of new grass emerges, make a second application of CLETHODIM [WARTHOG] 2 EC alone (without a tank mix herbicide), according to the appropriate size and rate recommendations.

(2) Broadleaf weed control may be reduced when grass populations are tall or dense enough to intercept the spray pattern and prevent them from receiving complete coverage. Tank mixing is not recommended in these situations.

(3) Always use a crop oil concentrate at the listed rate (but not less than 1 pt./A) in the finished spray volume.

(4) The addition of 2.5 lb. of ammonium sulfate is required when CLETHODIM [WARTHOG] 2 EC is tank mixed with glyphosate. If the glyphosate formulation has a stand alone built in adjuvant, add 0.125% v/v non-ionic surfactant in place of crop oil concentrate. If the glyphosate formulation does not have a built in adjuvant system add 0.5 to 1% crop oil concentrate for ground application and 1% v/v for aerial application.

(5) The addition of 1 to 2 qts./A of liquid fertilizer (10-34-0, 28%N, or 32%N) is recommended when CLETHODIM [WARTHOG] 2 EC is tank mixed with PURSUIT, RESOURCE, STORM, FIRSTRATE, SYNCHRONY, RAPTOR FRONTROW, COBRA plus CLASSIC, COBRA plus BASAGRAN, COBRA plus PURSUIT, COBRA plus FIRSTRATE, COBRA plus SYNCHRONY, and COBRA plus RAPTOR. An equivalent amount (2.5 to 4.0 lbs./A) of spray grade ammonium sulfate (AMS) may be added in place of liquid fertilizer. Fertilizer adjuvants are to be added in addition to the crop oil concentrate.

(6) Refer to FLEXSTAR HL label for geographic and rotational restrictions.

(7) Annual grasses and sizes controlled with these tank mixtures are those that are identified in the DIRECTIONS FOR REDUCED RATE TO CONTROL SMALL ANNUAL GRASSES table.

**SOYBEAN (continued)**

**Table 10. REDUCED RATE CLETHODIM [WARTHOG] 2 EC TANK MIXES WITH BROADLEAF HERBICIDES FOR SOYBEAN (Refer to table for reduced rate use in canola, dry shelled bean & pea, edible podded legume vegetables, flax, mustard seed, soybean, succulent bean & pea and sugar beet recommendations for small annual grasses for specific grasses and growth stages)**

PRODUCT	APPLICATION RATES/ACRE <sup>(1)</sup>		CROP OIL CONCENTRATE <sup>(3,4)</sup> (V/V)	
	ANNUAL GRASSES <sup>(2)</sup>	PERENNIAL GRASSES	GROUND	AIR
CLETHODIM [WARTHOG] 2 EC + FIRSTRATE	4 to 8 fl. oz. + 0.3 oz.	-	1%	1%
CLETHODIM [WARTHOG] 2 EC + PURSUIT 70 DG	4 to 6 fl. oz. + 1.44 oz.	-	1%	1%

(1) If grass regrowth occurs or an additional flush of new grass emerges, make a second application of CLETHODIM [WARTHOG] 2 EC alone (without a tank mix herbicide), according to the appropriate size and rate recommendations.  
 (2) Annual grasses and sizes controlled with these tank mixtures are those that are identified in the DIRECTIONS FOR REDUCED RATE TO CONTROL SMALL ANNUAL GRASSES table.  
 (3) Always use a crop oil concentrate at the listed rate (but not less than 1 pt./A) in the finished spray volume.  
 (4) The addition of 1 to 2 qts./A of liquid fertilizer (10-34-0, 28%N, or 32%N) is required when CLETHODIM [WARTHOG] 2 EC is tank mixed at reduce rates. An equivalent amount (2.5 to 4.0 lbs./A) of spray grade ammonium sulfate (AMS) may be added in place of liquid fertilizer. Fertilizer adjuvants are to be added in addition to the crop oil concentrate.

**PEANUT (INCLUDING PERENNIAL)**

**Table 11. CLETHODIM [WARTHOG] 2 EC TANK MIXES WITH BROADLEAF HERBICIDES FOR PEANUT (INCLUDING PEANUT) (Refer to the recommendation tables above for specific grasses and growth stages.)**

PRODUCT <sup>(2)</sup>	APPLICATION RATES/ACRE <sup>(1)</sup>		CROP OIL CONCENTRATE <sup>(3)</sup> (V/V)	
	ANNUAL GRASSES <sup>(2)</sup>	PERENNIAL GRASSES	GROUND	AIR
CLETHODIM [WARTHOG] 2 EC + BASAGRAN	8 to 10 fl. oz. + 1.0 to 2.0 pts.	-	1%	1%
CLETHODIM [WARTHOG] 2 EC + ULTRA BLAZER	8 to 10 fl. oz. + 0.5 to 1.5 pts.	-	1%	1%
CLETHODIM [WARTHOG] 2 EC + STORM	8 to 10 fl. oz. + 1.5 pts.	-	1%	1%

(1) If grass regrowth occurs or an additional flush of new grass emerges, make a second application of CLETHODIM [WARTHOG] 2 EC alone (without a tank mix herbicide), according to the appropriate size and rate recommendations.  
 (2) Broadleaf weed control may be reduced when grass populations are tall or dense enough to intercept the spray pattern and prevent them from receiving complete coverage. Tank mixing is not recommended in these situations.  
 (3) Always use a crop oil concentrate at the listed rate (but not less than 1 pt./A) in the finished spray volume.

GRASS SUPPRESSION FOR HARVEST EFFICIENCY IN PEANUT (INCLUDING PERENNIAL) WITH CLETHODIM [WARTHOG] 2 EC			
GRASS SPECIES	WEED STAGE	RATE FL. OZ./ ACRE	HIGH RATE
Annual and perennial grasses that exceed height claimed for control on height charts "ANNUAL GRASSES" & "PERENNIAL GRASSES"	Up to and including grasses in the seed head stage.	16	32
<ul style="list-style-type: none"> <li>Do not apply as part of a tank mix when applying CLETHODIM [WARTHOG] 2 EC for grass suppression.</li> <li>Add a crop oil concentrate at 1 qt./A by ground to the finished spray volume.</li> </ul>			

**SUGAR BEET**

**Table 12. CLETHODIM [WARTHOG] 2 EC TANK MIXED WITH STINGER® APPLIED TO SUGAR BEET (Refer to the recommendation tables above for specific grasses and growth stages)**

PRODUCT <sup>(2)</sup>	APPLICATION RATES/ACRE <sup>(1)</sup>		CROP OIL CONCENTRATE <sup>(3)</sup> (V/V)	
	Annual Grasses	Perennial Grasses	Ground	Air
CLETHODIM [WARTHOG] 2 EC + STINGER	6 to 8 fl. oz.	8 to 16 fl. oz.	1%	1%
See STINGER label for rates.				
<p>(1) If grass regrowth occurs or an additional flush of new grass emerges, make a second application of CLETHODIM [WARTHOG] 2 EC alone (without a tank mix herbicide), according to the appropriate size and rate recommendations.</p> <p>(2) Broadleaf weed control may be reduced when grass populations are tall or dense enough to intercept the spray pattern and prevent them from receiving complete coverage. Tank mixing is not recommended in these situations.</p> <p>(3) Always use a crop oil concentrate at the listed rate (but not less than 1 pt./A) in the finished spray volume.</p>				

**Table 13. CLETHODIM [WARTHOG] 2 EC TANK MIXED WITH BETAMIX® or BETANEX® APPLIED TO SUGAR BEET**

PRODUCT <sup>(1)</sup>	WEEDS CONTROLLED		WEED HEIGHT (inches)	APPLICATION RATE/ACRE <sup>(2)</sup>
	COMMON NAME	SCIENTIFIC NAME		
CLETHODIM [WARTHOG] 2 EC <sup>(3)</sup> + BETAMIX or BETANEX	Barnyardgrass	<i>Echinochloa crus-galli</i>	1 to 3	8 fl. oz.
	Foxtail	<i>Setaria</i> spp.	1 to 3	
	Foxtail Millet	<i>Setaria italica</i>	1 to 3	
	Wild Oat	<i>Avena fatua</i>	1 to 3	
	Wild Proso Millet	<i>Panicum miliaceum</i>	1 to 3	
			See BETAMIX label for rates to control broadleaf weeds. <b>No additives are recommended in the tank mix.</b>	
			See BETANEX label for rates to control broadleaf weeds. <b>No additives are recommended in the tank mix.</b>	

(1) Broadleaf weed control may be reduced when grass populations are tall or dense enough to intercept the spray pattern and prevent them from receiving complete coverage. Tank mixing is not recommended in these situations.

(2) Do not use crop oil concentrate. No additives are recommended in the tank mix. If grass regrowth occurs or an additional flush of new grass emerges, make a second application of CLETHODIM [WARTHOG] 2 EC alone (without a tank mix herbicide), according to the appropriate size and rate recommendations.

(3) If grass regrowth occurs or an additional flush of new grass emerges, make a second application of CLETHODIM [WARTHOG] 2 EC at full label rate with appropriate rate of crop oil concentrate.

**TABLE 14. CLETHODIM [WARTHOG] 2 EC PLUS BETANEX OR BETAMIX TANK MIX FOR THREE SEQUENTIAL APPLICATIONS FOR ANNUAL GRASS CONTROL (MICRO-RATE APPLICATION)**

PRODUCT	APPLICATION RATES/ACRE <sup>(1)</sup>		METHYLATED SEED OIL <sup>(2)</sup> (V/V)	
	ANNUAL GRASSES	GRASSES CONTROLLED (inches)		
			GROUND	AIR
CLETHODIM [WARTHOG] 2 EC + BETANEX or BETAMIX	2 to 3 fl. oz.	Green Foxtail (1-2)	1.5%	1.5%
	+ 8 to 12 fl. oz. <sup>(3)</sup>	Yellow Foxtail (1-2)		
	or 8 to 12 fl. oz. <sup>(3)</sup>	Barnyardgrass (1-2) Wild Oat (1-2) Volunteer Cereals (1-2)		

(1) Broadleaf weed control may be reduced when grass populations are tall or dense enough to intercept the spray pattern and prevent them from receiving complete coverage. Tank mixing is not recommended in these situations.

(2) Always use a methylated seed oil at the listed rate (but not less than 1 pt./A) in the finished spray volume.

(3) Use 8 fl. oz./A rate when sugar beet are in the cotyledon to 4 leaf stage. Rate can be increased up to 12 fl. oz./A when the smallest sugar beet plants in the field are in the 4 true leaf stage or larger.

**Micro-Rate Applications to Sugar Beet Use Information**

Multiple micro-rate applications of CLETHODIM [WARTHOG] 2 EC in tank mixtures with reduced rates of BETANEX or BETAMIX and methylated seed oils may be applied by air or ground equipment to sugar beet to control early germinating annual grasses listed above. The rate of BETANEX or BETAMIX must not exceed 0.12 lb. ai./A (broadcast application) when in combination with these spray adjuvants. Note that maximum rate allowed varies depending on crop growth stage. The use of wetting agents or spray adjuvants with conventional rates (0.73 to 1.22 lb. ai./A) or multiple low rate (0.24 to 0.73 lb. ai./A) applications of BETANEX or BETAMIX is prohibited on

the BETANEX and BETAMIX master label. Favorable climatic conditions (good conditions for plant growth and development) are essential for adequate weed control. All use precautions and restrictions on the BETANEX and BETAMIX master labels must be followed.

**Micro-Rate Multiple Applications of CLETHODIM [WARTHOG] 2 EC Tank Mixes**

Apply CLETHODIM [WARTHOG] 2 EC in broadcast applications only at a rate of 2 to 3 fl. oz./A in tank mixture with either BETANEX or BETAMIX following the directions for use on the tank mix partner label. A minimum of three sequential applications of 2 fl. oz./A or a minimum of 2 sequential applications of 3 fl. oz./A should be utilized for CLETHODIM [WARTHOG] 2 EC tank mixtures. A minimum of 3 sequential applications of BETAMIX or BETANEX should be used. Accurate timing is essential; make initial application immediately after weeds emerge, and make repeat applications on 5 to 7 day intervals. If weed control is not adequate due to climatic conditions, spray coverage or other factors, return to conventional application rates of CLETHODIM [WARTHOG] 2 EC (6 to 8 fl. oz./A) and add rates of BETANEX or BETAMIX as directed on their label. When using conventional rates of BETANEX or BETAMIX in tank mixtures with CLETHODIM [WARTHOG] 2 EC, a spray adjuvant is not recommended.

**Use Precautions for Micro-Rate Applications: (See CLETHODIM [WARTHOG] 2 EC, BETANEX and BETAMIX master label for further use precautions.)**

Not all weeds will be adequately controlled, even with favorable climatic conditions. Conventional rates of CLETHODIM [WARTHOG] 2 EC, BETANEX or BETAMIX and/or hand labor may be required if multiple micro-rate applications do not adequately control weeds. Plugging of spray nozzles may be encountered due to the potential for formation of a precipitate in the spray solution that is often associated with micro-rate applications. J. Oliver Products, LLC will not be responsible for any nozzle plugging that may occur with the use of multiple micro-rate applications. Methylated seed oils must not be added if the BETANEX or BETAMIX rate exceeds 0.12 lb. ai/A broadcast, as the addition of methylated seed oils could increase the possibility of crop injury at dosage rates greater than 0.12 lb. ai/A.

**GROUND APPLICATION**

Use of sufficient spray volumes and pressure is essential to ensure complete coverage. Use a minimum of 10 gals. and a maximum of 20 gals. of spray solution per acre. Spray pressures should reflect a minimum of 30 psi and a maximum of 60 psi at the nozzle. Do not use flood nozzles.

**AERIAL APPLICATION**

Use of sufficient spray volumes is essential to ensure complete coverage. Use a minimum of 5 gals. and a maximum of 15 gals. of spray solution per acre.

**Table 15. TANK MIX APPLICATION OF CLETHODIM [WARTHOG] 2 EC AND FUNGICIDES FOR CONTROL OF GRASS WEEDS AND DISEASES IN SUGAR BEET**

PRODUCT <sup>(2)</sup>	APPLICATION RATES/ACRE <sup>(1)</sup>		CROP OIL CONCENTRATE <sup>(3)</sup> (V/V)
	ANNUAL GRASSES	PERENNIAL GRASSES	
CLETHODIM [WARTHOG] 2 EC + EMINENT®	6 to 8 fl. oz. + 13 fl. oz.	8 to 16 fl. oz. + 13 fl. oz.	1%

(1) If grass regrowth occurs, or an additional flush of new grass emerges, make a second application of CLETHODIM [WARTHOG] 2 EC alone (without a tank mix fungicide) according to the appropriate size and rate recommendations.  
 (2) Refer to CLETHODIM [WARTHOG] 2 EC and fungicide label for rates and weeds and diseases controlled.  
 (3) Always use a crop oil concentrate at the listed rate (but not less than 1 pt./A) in the finished spray volume.

**Table 16. TANK MIX APPLICATION OF CLETHODIM [WARTHOG] 2 EC AND INSECTICIDES FOR CONTROL OF GRASS WEEDS AND INSECTS IN ALFALFA, COTTON, MINT, PEANUT (INCLUDING PERENNIAL), SOYBEAN AND SUNFLOWER**

PRODUCT <sup>(2)</sup>	APPLICATION RATES/ACRE <sup>(1)</sup>		CROP OIL CONCENTRATE (V/V) <sup>(3)</sup>	CROP					
	ANNUAL GRASSES	PERENNIAL GRASSES		Alfalfa <sup>(4)</sup>	Cotton	Mint <sup>(4,5)</sup>	Peanut	Soybean	Sunflower
CLETHODIM [WARTHOG] 2 EC + ORTHENE® 75 S or ORTHENE 97	6 to 8 fl. oz. + 0.33 to 1.33 lbs. 0.25 to 1.0 lb.	8 to 16 fl. oz. + 0.33 to 1.33 lbs. 0.25 to 1.0 lb.	1%		X	X	X		
CLETHODIM [WARTHOG] 2 EC + ORTHENE 90 S <sup>(6)</sup>	6 to 8 fl. oz. + 0.25 to 1 lb.	8 to 16 fl. oz. + 0.25 to 1 lb.	1%		X	X	X	X	
CLETHODIM [WARTHOG] 2 EC + DANITOL® 2.4 EC	6 to 8 fl. oz. + 10 2/3 to 16 fl. oz.	8 to 16 fl. oz. + 10 2/3 to 16 fl. oz.	1%		X		X		
CLETHODIM [WARTHOG] 2 EC + ASANA XL®	6 to 8 fl. oz. + Refer to ASANA XL label	8 to 16 fl. oz. + Refer to ASANA XL label	1%						X
CLETHODIM [WARTHOG] 2 EC + WARRIOR®	6 to 8 fl. oz. + Refer to WARRIOR label	8 to 16 fl. oz. + Refer to WARRIOR label	1%						X
CLETHODIM [WARTHOG] 2 EC + WARRIOR	10 to 16 fl. oz. <sup>(7)</sup> + Refer to WARRIOR label	10 to 16 fl. oz. + Refer to WARRIOR label	1%	X					
CLETHODIM [WARTHOG] 2 EC + BAYTHROID®	10 to 16 fl. oz. <sup>(7)</sup> + Refer to BAYTHROID label	10 to 16 fl. oz. + Refer to BAYTHROID label	1%	X					
CLETHODIM [WARTHOG] 2 EC + DIMETHOATE®	10 to 16 fl. oz. <sup>(7)</sup> + Refer to DIMETHOATE label	10 to 16 fl. oz. + Refer to DIMETHOATE label	1%	X					

continued

**Table 16. TANK MIX APPLICATION OF CLETHODIM [WARTHOG] 2 EC AND INSECTICIDES FOR CONTROL OF GRASS WEEDS AND INSECTS IN ALFALFA, COTTON, MINT, PEANUTS (INCLUDING PERENNIAL), SOYBEAN AND SUNFLOWER (continued)**

PRODUCT <sup>(2)</sup>	APPLICATION RATES/ACRE <sup>(1)</sup>		CROP OIL CONCENTRATE (V/V) <sup>(3)</sup>	CROP					
	ANNUAL GRASSES	PERENNIAL GRASSES		Alfalfa <sup>(4)</sup>	Cotton	Mint <sup>(4,5)</sup>	Peanut	Soybean	Sunflower
CLETHODIM [WARTHOG] 2 EC + LORSBAN®	10 to 16 fl. oz. <sup>(7)</sup> + Refer to LORSBAN label	10 to 16 fl. oz. + Refer to LORSBAN label	1 to 2 pt. <sup>(8)</sup>	X					
CLETHODIM [WARTHOG] 2 EC + POUNCE®	10 to 16 fl. oz. <sup>(7)</sup> + Refer to POUNCE label	10 to 16 fl. oz. + Refer to POUNCE label	1%	X					

- (1) If grass regrowth occurs, or an additional flush of new grass emerges, make a second application of CLETHODIM [WARTHOG] 2 EC alone (without a tank mix insecticide) according to the appropriate size and rate recommendations.
- (2) Refer to CLETHODIM [WARTHOG] 2 EC and insecticide label for rates and weeds and insects controlled.
- (3) Always use a crop oil concentrate at the listed rate (but not less than 1 pt./A) in the finished spray volume.
- (4) Certain insecticides may cause temporary phytotoxic symptoms on alfalfa and mint foliage. Refer to the insecticide label for information. It is suggested that prior to using any of these insecticide/herbicide tank mixtures, that a small area of the field be first and observations for crop injury be made prior to treating the whole field.
- (5) The CLETHODIM [WARTHOG] 2 EC rate should be 6 to 8 fl. oz./A for annual grass control in baby mint, minimum of 8 fl. oz./A for annual grass control in established mint and 8 to 16 fl. oz./A for perennial grass control. Crop oil concentrate should be added at a rate of 1.0 to 2.0 pts./A.
- (6) Insecticide tank mix use with ORTHENE 90 S in soybean is permitted only in a state having an approved Section 24(c) registration for ORTHENE 90 S use in soybean.
- (7) The CLETHODIM [WARTHOG] 2 EC rate should be 6 to 8 fl. oz./A for annual grass control in seedling alfalfa.
- (8) For the CLETHODIM [WARTHOG] 2 EC plus LORSBAN tank mix, reduce the adjuvant rate down to 1.0 pt./A when the LORSBAN rate is 1.0 pt./A or higher.

**Table 17. ROUNDUP READY VOLUNTEER CORN CONTROL IN ROUNDUP READY SOYBEAN WITH CLETHODIM [WARTHOG] 2 EC HERBICIDE TANK MIX**

Roundup Ready Volunteer Corn Height (inches)	CLETHODIM [WARTHOG] 2 EC Rate fl. oz./A	Glyphosate <sup>(1)</sup> rate for formulations <b>with</b> built in adjuvant	Adjuvant
<12	4	1.0 to 2.0 lb. ai./A (Approximately equivalent to 22 to 44 fl. oz./A of ROUNDUP Weather MAX)	Non-ionic surfactant @ 0.125 to 0.25% v/v plus ammonium sulfate @ 8.5 to 17 lbs. per 100 gals./ of carrier
12 to 18	5		
18 to 24	6		

Roundup Ready Volunteer Corn Height (inches)	CLETHODIM [WARTHOG] 2 EC Rate fl. oz./A	Glyphosate <sup>(1)</sup> rate for formulations <b>without</b> built in adjuvant	Adjuvant
<12	4	Up to 2.0 lb. ai./A (Equivalent to 32 to 64 fl. oz./A of ROUNDUP Original)	Crop oil concentrate @ 1 pt./A plus ammonium sulfate @ 8.5 to 17 lbs. per 100 gals. of carrier
12 to 18	5		
18 to 24	6		

(1) Glyphosate formulation must be labeled for use on Roundup Ready soybean.

**THE MOST RESTRICTIVE LABELING OF ANY PRODUCT USED IN A TANK MIX MUST BE FOLLOWED.**

- Apply only to actively growing grass and broadleaf weeds at recommended height or growth stage listed on each label.
- Apply under favorable soil moisture and humidity which exist a few days after rainfall or within seven days after irrigation.
- Tank mix applications may sometimes result in reduced grass control. If regrowth occurs, or an additional flush of new grass emerges, make a second application of CLETHODIM [WARTHOG] 2 EC, as specified in the respective size and rate tables.
- Do not tank mix CLETHODIM [WARTHOG] 2 EC when broadleaf weeds are tall and/or dense enough to prevent proper grass coverage.
- This tank mix may be applied postemergence to ROUNDUP READY soybean up through the full flowering stage. Do not apply less than 60 days before harvest.
- Avoid contact with foliage, green stems, or fruit crops, or any desirable plants and trees, other than soybean with the ROUNDUP READY gene as severe injury or destruction will result.
- Do not allow the CLETHODIM [WARTHOG] 2 EC plus ROUNDUP to mist, drip, drift or splash onto desirable vegetation as minute quantities of the tank mix can cause severe damage or destruction to the crops, plants or other areas on which treatment was not intended. The likelihood of injury occurring from drift of this product is greatest when winds are gusty or in excess of 5 miles per hour. Even under lesser wind velocities, avoid conditions that allow spray drift to occur such as combinations of spray pressure and nozzle type that will result in fine particles (mist) that are likely to drift.

**FALLOW LAND**

CLETHODIM [WARTHOG] 2 EC may be used to control annual and perennial grasses in land that has been left fallow the previous year and other non-producing agricultural areas. Apply CLETHODIM [WARTHOG] 2 EC at 6 to 8 fl. oz./A for annual grasses and 8 to 16 fl. oz./A for perennial grasses. When both grass and broadleaf weeds are the target pest, CLETHODIM [WARTHOG] 2 EC may be tank mixed with 2,4-D ester or BANVEL® SGF for broad spectrum control. When both annual and perennial grasses occur in the same field, use a minimum of 8 fl. oz./A. CLETHODIM [WARTHOG] 2 EC rate.

**USE INFORMATION:**

- Use a minimum spray volume of 5 gals./A for aerial applications and 15 gals./A for ground applications.
- Apply only to actively growing grasses when the first grass reaches the recommended weed height as specified by the Recommendations for Annual and Perennial Grasses section of this label.
- Annual grasses that emerge after the CLETHODIM [WARTHOG] 2 EC application will not be controlled, and a second application may be necessary.
- The control of perennial grasses may require more than 1 application in non-tilled areas.
- Do not plant any crop for 30 days after application unless clethodim is registered for use in that crop.
- Do not apply to grasses that have tillered, formed seedheads or exceeded recommended growth stage.
- Do not use flood jet nozzles.
- Do not apply to drought stressed grasses.
- Do not mow area for 2 weeks prior to or after the CLETHODIM [WARTHOG] 2 EC application.



**TABLE 18. CLETHODIM [WARTHOG] 2 EC IN TANK MIXES TO CONTROL ANNUAL AND PERENNIAL GRASSES IN FALLOW LAND**

PRODUCT	APPLICATION RATES/ACRE <sup>(1)</sup>		CROP OIL CONCENTRATE <sup>(2)</sup> (V/V)	
	Annual Grasses	Perennial Grasses	Ground	Air
CLETHODIM [WARTHOG] 2 EC + 2,4-D ester or BANVEL SGF	6 to 8 fl. oz. + 0.5 lb./A or See BANVEL SGF label for rates	8 to 16 fl. oz.	1%	1%

(1) Refer to CLETHODIM [WARTHOG] 2 EC label for weed height and species control. Review BANVEL SGF and 2,4-D labels for crop restrictions, use rates and weeds controlled.  
 (2) Always use a crop oil concentrate or methylated seed oil containing at least 15% emulsifier at the listed rate (but not less than 1 pt./A) in the finished spray volume.

GRASS SUPPRESSION IN NON-CROP AREAS WITH CLETHODIM [WARTHOG] 2 EC			
GRASS SPECIES	WEED STAGE	RATE FL. OZ./ACRE	HIGH RATE
Annual and perennial grasses that exceed height claimed for control on height chart above.	Up to and including grasses in the seed head stage.	12	16

- Do not apply as part of a tank mix when applying CLETHODIM [WARTHOG] 2 EC for grass suppression.
- Add a crop oil concentrate at 1 qt./A by ground to the finished spray volume.

**TABLE 19. CLETHODIM [WARTHOG] 2 EC FOR THE CONTROL AND/OR SUPPRESSION OF TALL FESCUE IN NATIVE PRAIRIE WARM-SEASON GRASS RESTORATION PROJECTS**

PRODUCT	PRODUCT RATES	GRASS WEEDS CONTROLLED/SUPPRESSED		WEED STAGES
		Common Name	Scientific Name	
CLETHODIM [WARTHOG] 2 EC	10 to 12 fl. oz./A	Tall Fescue	<i>Festuca arundinacea</i>	4 to 6 inches tall (40 to 60% green-up)

**Adjuvant:** CLETHODIM [WARTHOG] 2 EC must be applied with crop oil concentrate at 1 qt./A, plus a spray grade ammonium sulfate at 2.5 to 4 lbs./A. Recommended Mixing Order: Thoroughly mix spray grade ammonium sulfate in water, add CLETHODIM [WARTHOG] 2 EC, then add crop oil concentrate.

**SPECIAL APPLICATION INSTRUCTIONS/PRECAUTIONS:**

- Burn or mow fields a minimum of 3 weeks prior to application to remove excess crop residue. Apply in the spring, at 40 to 60% tall fescue green-up, prior to emergence of warm-season grasses. Do not mow area for 2 weeks after the CLETHODIM [WARTHOG] 2 EC application.
- Apply in a minimum of 15 to 20 gals. of water per acre at a spray pressure of 40 to 60 PSI at the nozzle.
- Apply using flat fan or hollow cone nozzles. Do not use flood jet nozzles.
- Apply only to fields that have warm-season grasses established for 2 years. Applications of CLETHODIM [WARTHOG] 2 EC to emerged warm-season grasses may cause injury. Do not apply to warm-season grasses grown for seed.
- Do not graze treated fields or feed treated forage and or hay to livestock. Do not plant any crop for 30 days after application, unless clethodim is registered for use in that crop.

**NOTE:** CLETHODIM [WARTHOG] 2 EC applications are most effective if applied when average nighttime temperatures are consistently greater than or equal to 47°F.

**TABLE 20. CLETHODIM [WARTHOG] 2 EC FOR THE SUPPRESSION OF TALL FESCUE SEED-HEADS IN NON-PRODUCING AGRICULTURAL AREAS**

Product	Product Rate	Suppression	Application Timing
CLETHODIM [WARTHOG] 2 EC	1 1/2 to 2 fl. oz./A	Tall Fescue Seed-Heads ( <i>Festuca arundinacea</i> )	(50 to 90% Tall Fescue green-up)
<b>ADJUVANT:</b> CLETHODIM [WARTHOG] 2 EC must be applied with crop oil concentrate at 1 qt./A, plus a spray grade ammonium sulfate at 2.5 to 4 lb./A. <b>Recommended Mixing Order:</b> Thoroughly mix spray grade ammonium sulfate in water, add CLETHODIM [WARTHOG] 2 EC Herbicide, then add crop oil concentrate.			

**SPECIAL APPLICATION INSTRUCTIONS/PRECAUTIONS:**

- Apply at 50 to 90% tall fescue green-up.
- Use the higher CLETHODIM [WARTHOG] 2 EC rate if less tall fescue green matter is present.
- Do not mow area for two weeks after the CLETHODIM [WARTHOG] 2 EC application.
- Apply in a minimum of 15 to 20 gals. of water per acre at a spray pressure of 40 to 60 psi at the nozzle. Apply using flat fan or hollow cone nozzles. Do not use flood nozzles.
- 2-4-D ester maybe added to this tank mix for broadleaf control (see 2,4-D ester label for weeds controlled).
- Do not graze treated fields or feed treated forage and/or hay to livestock. Do not plant any crop for 30 days after application, unless clethodim is registered for use in that crop.

## ORNAMENTALS

For ornamental plant uses, CLETHODIM [WARTHOG] 2 EC can be used to control labeled grass weeds in greenhouses, lathhouses, shadehouses, and around outdoor ornamentals, including nurseries, parks, roadside plantings, and structure landscapes.

### IMPORTANT

CLETHODIM [WARTHOG] 2 EC successfully controls weeds in newly transplanted and established non-grassy ornamentals. Plant tolerance to CLETHODIM [WARTHOG] 2 EC at labeled rates has been found to be acceptable for the indicated genera and species listed below. Due to variability within species, crop growth stage, environmental conditions, and application techniques, it is recommended that the user determine if herbicide can be used safely on a few plants prior to widespread application. Neither the seller nor the manufacturer of CLETHODIM [WARTHOG] 2 EC have investigated the safety factor to ornamental plants not listed on the label.

The following plants have shown a tolerance for CLETHODIM [WARTHOG] 2 EC applications:

### ORNAMENTAL TREES

COMMON NAME	SCIENTIFIC NAME
Alder, Red	<i>Alnus rubra</i>
Ash	<i>Fraxinus</i> spp.
Basswood	<i>Tilia</i> spp.
Birch, European White	<i>Betula pendula</i>
Birch, River	<i>Betula nigra</i>
Birch, White	<i>Betula papyrifera</i>
Crabapple, Flowering	<i>Malus halliana</i>
Dogwood, Flowering	<i>Cornus florida</i>
Golden Chain Tree	<i>Laburnum anagyroides</i>
Maples	<i>Acer</i> spp.
Mulberry, White	<i>Morus alba</i>
Oaks	<i>Quercus</i> spp.
Olive, Wild	<i>Elaeagnus angustifolia</i>
Redbud, Eastern	<i>Cercis Canadensis</i>
Sweet Gum, American	<i>Liquidambar styraciflua</i>

### GROUND COVERS

COMMON NAME	SCIENTIFIC NAME
Bugleweed, Carpet	<i>Ajuga reptans</i>
Ivy, English	<i>Hedera helix</i>
Japanese Spurge	<i>Pachysandra terminalis</i>
Lilyturf	<i>Liriope muscari</i>
Moneywort	<i>Lysimachia nummularia</i>
Mondo Grass, White	<i>Ophiopogon jaburan</i>
Mondo Grass Dwarf	<i>Ophiopogon japonicus</i>
Periwinkle, Lesser	<i>Vinca minor</i>

## GARDEN FLOWERS AND PLANTS

COMMON NAME	SCIENTIFIC NAME
Ageratum	<i>Ageratum</i> spp.
Alyssum*, Sweet	<i>Lobularia maritima</i>
Asparagus Fern	<i>Asparagus setaceus</i>
Bleeding Heart	<i>Dicentra spectabilis</i>
Cast Iron Plant	<i>Aspidistra elatior</i>
Chrysanthemum	<i>Chrysanthemum</i> spp.
Cinquefoil	<i>Potentilla</i> spp.
Coleus	<i>Coleus</i> spp.
Coralbells	<i>Heuchera sanguinea</i>
Cranesbill	<i>Geranium</i> spp.
Dahlia	<i>Dahlia</i> spp.
Daisy, Trailing African	<i>Osteospermum fruticosum</i>
Daylily	<i>Hemerocallis</i> spp.
Dusty Miller	<i>Senecio cineraria</i>
Euonymus	<i>Euonymus</i> spp.
Gazania	<i>Gazania</i> spp.
Geranium, House	<i>Pelargonium hortorum</i>
Heather, False	<i>Cuphea hyssopifolia</i>
Hosta	<i>Hosta fortunei</i>
Iris	<i>Iris</i> spp.
Jasmine Tobacco	<i>Nicotiana glauca</i>
Loosestrife	<i>Lythrum salicaria</i>
Marigold	<i>Tagetes</i> spp.
Partridgeberry	<i>Mitchella repens</i>
Petunia*	<i>Petunia hybrida</i>
Phlox	<i>Phlox</i> spp.
Pinks	<i>Dianthus</i> spp.
Portulaca	<i>Portulaca grandiflora</i>
Salvia	<i>Salvia</i> spp.
Saxifrage	<i>Saxifraga</i> spp.
Sedum	<i>Sedum</i> spp.
Selloum	<i>Philodendron selloum</i>
Snapdragon*	<i>Antirrhinum majus</i>
Sweet Flag	<i>Acorus gramineus</i>
Tickseed	<i>Coreopsis grandiflora</i>
Touch-Me-Not	<i>Impatiens</i> spp.
Verbena	<i>Verbena</i> spp.
Violet	<i>Viola</i> spp.
Yarrow, Common	<i>Achillea millefolium</i>
Zinnia	<i>Zinnia elegans</i>

\*Slight foliage or flower speckling has been observed on these species.

## SHRUBS

COMMON NAME	SCIENTIFIC NAME
Abelia	<i>Abelia</i> spp.
Anise, Purple	<i>Illicium floridanum</i>
Aucuba	<i>Aucuba</i> spp.
Azalea*	<i>Rhododendron</i> spp.
Bamboo	<i>Bambusa</i> spp.
Barberry, Japanese	<i>Berberis thunbergii</i>
Barberry, Magellan	<i>Berberis buxifolia</i>
Bayberry	<i>Myrica pensylvanica</i>
Bottlebrush	<i>Callistemon citrinus</i>
Boxwood, Common	<i>Buxus sempervirens</i>
Camellia, Common	<i>Camellia japonica</i>
Candytuft	<i>Iberis sempervirens</i>
Cleyera	<i>Cleyera japonica</i>
Coralberry	<i>Ardisia crenata</i>
Crape Myrtle	<i>Lagerstroemia indica</i>
Coyote Brush	<i>Baccharis pilularis</i>
Fig, Creeping	<i>Ficus pumila</i>
Gardenia	<i>Gardenia</i> spp.
Holly	<i>Ilex</i> spp.
Honeysuckle	<i>Lonicera</i> spp.
Indian Hawthorn	<i>Raphiolepis indica</i>
Jasmine	<i>Jasminum</i> spp.
Jasmine, Asiatic	<i>Trachelospermum asiaticum</i>
Jasmine, Star	<i>Trachelospermum jasminoides</i>
Juniper	<i>Juniperus</i> spp.
Lantana	<i>Lantana</i> spp.
Nandina* Bamboo, Heavenly	<i>Nandinia domestica</i>
Oleander, Common	<i>Nerium oleander</i>
Oregon Grape	<i>Mahonia aquifolium</i>
Photinia	<i>Photinia</i> spp.
Pittosporum	<i>Pittosporum</i> spp.
Podocarpus	<i>Podocarpus</i> spp.
Privet	<i>Ligustrum</i> spp.
Pyracantha	<i>Pyracantha</i> spp.
Rhododendron	<i>Rhododendron</i> spp.
Rose	<i>Spiraea bumalda</i>
Sweet Olive	<i>Osmanthus fragrans</i>
Viburnum	<i>Viburnum tinus</i>
Wisteria	<i>Wisteria</i> spp.
Yellow Sage/Shrub Verbena	<i>Lantana camara</i>
*Slight foliage or flower speckling has been observed on these species.	

**ANNUAL GRASSES IN ORNAMENTALS**

GRASS SPECIES	SCIENTIFIC NAME	WEED* HEIGHT INCHES	RATE FL. OZ./ACRE <sup>(1)</sup>	HIGH RATE <sup>(2)</sup>
Barnyardgrass	<i>Echinochloa crus-galli</i>	2 to 8	8	16
Broadleaf Signalgrass	<i>Brachiaria platyphylla</i>	2 to 6	8	16
<b>Brome</b>				
California	<i>Bromus carinatus</i>	2 to 6	8	16
Cheat	<i>Bromus secalinus</i>	2 to 6	8	16
Downy	<i>Bromus tectorum</i>	2 to 6	8	16
Rippgut	<i>Bromus diandrus</i>	2 to 6	8	16
Canarygrass	<i>Phalaris canariensis</i>	1 to 4	8	16
<b>Crabgrass</b>				
Hairy	<i>Digitaria adscendens</i>	2 to 6**	8	16
Large	<i>Digitaria sanguinalis</i>	2 to 6**	8	16
Smooth	<i>Digitaria ischaemum</i>	2 to 6**	8	16
Southern	<i>Digitaria ciliaris</i>	2 to 6**	8	16
Crowfootgrass	<i>Dactyloctenium aegyptium</i>	2 to 6**	8	16
Fall Panicum	<i>Panicum dichotomiflorum</i>	2 to 8	8	16
Field Sandbur	<i>Cenchrus incertus</i>	2 to 6	8	16
<b>Foxtail</b>				
Giant	<i>Setaria faberi</i>	2 to 12	8	16
Green	<i>Setaria viridis</i>	2 to 8	8	16
Yellow	<i>Setaria glauca</i>	2 to 8	8	16
Goosegrass	<i>Eleusine indica</i>	2 to 6**	8	16
Itchgrass	<i>Rottboellia cochlin</i>	2 to 6	8	16
Junglerice	<i>Echinochloa colona</i>	2 to 6	8	16
Lovegrass (Stinkgrass)	<i>Eragrostis cilianensis</i>	2 to 6	8	16
Rabbitsfootgrass	<i>Polypogon monspeliensis</i>	1 to 4	8	16
Red Rice	<i>Oryza sativa</i>	1 to 3	8	16
<b>Rygrass</b>				
Hardy	<i>Lolium remotum</i>	2 to 6	8	16
Italian	<i>Lolium multiflorum</i>	2 to 6	8	16
Seedling Johnsongrass	<i>Sorghum halepense</i>	4 to 10	8	16
Shattercane	<i>Sorghum bicolor</i>	6 to 18	8	16
Southwestern Cupgrass	<i>Eriochloa gracilis</i>	2 to 6	8	16
<b>Sprangletop</b>				
Amazon	<i>Leptochloa panicoides</i>	2 to 6	8	16
Bearded	<i>Leptochloa fascicularis</i>	2 to 6	8	16
Mexican	<i>Leptochloa uninervis</i>	2 to 6	8	16
Red	<i>Leptochloa filiformis</i>	2 to 6	8	16
Texas Panicum	<i>Panicum texanum</i>	2 to 6	8	16
<b>Volunteer Cereals</b>				
Barley	<i>Hordeum vulgare</i>	2 to 6	8	16
Oats	<i>Avena sativa</i>	2 to 6	8	16
Rye	<i>Secale cereale</i>	2 to 6	8	16
Wheat	<i>Triticum aestivum</i>	2 to 6	8	16
Volunteer Corn	<i>Zea mays</i>	4 to 12	6	8
Volunteer Corn	<i>Zea mays</i>	12 to 24	8	16
Volunteer Grain Sorghum	<i>Sorghum bicolor</i>	8 to 12	8	16
Wild Oats	<i>Avena fatua</i>	2 to 6	8	16
Wild Proso Millet	<i>Panicum miliaceum</i>	2 to 10	8	16
Witchgrass	<i>Panicum capillare</i>	2 to 8	8	16
Woolly Cupgrass	<i>Eriochloa villosa</i>	2 to 8	8	16

- Apply only to actively growing grasses at recommended weed heights.
- Apply when the first grass weed species in a mixed grass weed population reaches the recommended growth stage for treatment.
- Use the high rate under heavy grass pressure and/or when grasses are at maximum height.

\*Generally occurs between 3-leaf stage and tillering.

\*\*Length of lateral growth.

(1) 8 fl. oz./A = approximately 0.2 fl. oz./1000 sq. ft.

(2) 16 fl. oz./A = approximately 0.4 fl. oz./1000 sq. ft.

Add a non-ionic surfactant containing at least 80% active ingredient at the rate of 1 pt. per 50 gals. (0.25% v/v).

**ANNUAL BLUEGRASS CONTROL WITH  
CLETHODIM [WARTHOG] 2 EC IN ORNAMENTALS**

GRASS SPECIES	WEED STAGE	RATE FL. OZ./ ACRE	HIGH RATE
Annual Bluegrass ( <i>Poa annua</i> )	to 4-leaf	6	16
<ul style="list-style-type: none"> <li>• Apply under favorable soil moisture and humidity that exists within a few days after rainfall or within 7 days after irrigation. Grass needs to be actively growing at time of application(s).</li> <li>• Apply at weed stage indicated on the label, as reduced control can be expected with more mature annual bluegrass.</li> <li>• Use the high rate under heavy grass pressure and/or when annual bluegrass is more mature.</li> <li>• Add a non-ionic surfactant containing at least 80% active ingredient at the rate of 1 pt. per 50 gals. (0.25% v/v).</li> </ul>			

**PERENNIAL GRASSES**

GRASS SPECIES	WEED HEIGHT (inches)	RATE FL. OZ./ ACRE <sup>(1)</sup>	HIGH RATE <sup>(2)</sup>
<b>Bermudagrass (<i>Cynodon dactylon</i>)</b>			
First Application	3 (or up to 6" runners)	8	16
Repeat Application(s) (if regrowth occurs)	3 (or up to 6" runners)	8	16
<b>Quackgrass (<i>Elytrigia repens</i>)</b>			
First Application	4 to 8	8	16
Repeat Application(s) (if regrowth occurs)	4 to 8	8	16
<b>Rhizome Johnsongrass (<i>Sorghum halepense</i>)</b>			
First Application	12 to 24	8	16
Repeat Application(s) (if regrowth occurs)	6 to 18	6	8
<b>Wirestem Muhly (<i>Muhlenbergia frondosa</i>)</b>			
First Application	4 to 8	8	16
Repeat Application(s) (if regrowth occurs)	4 to 8	8	16
<ul style="list-style-type: none"> <li>• Apply only to actively growing grasses at recommended weed heights.</li> <li>• Apply when the first grass weed species in a mixed grass weed population reaches the recommended growth stage for treatment.</li> <li>• Use the high rate under heavy grass pressure and/or when grasses are at maximum height.</li> </ul>			
(1) 8 fl. oz./A = approximately 0.2 fl. oz./1000 sq. ft. (2) 16 fl. oz./A = approximately 0.4 fl. oz./1000 sq. ft. Add a non-ionic surfactant containing at least 80% active ingredient at the rate of 1 pt. per 50 gals. (0.25% v/v)			

## STORAGE AND DISPOSAL

### PROHIBITIONS

Do not contaminate water, food or feed by storage, disposal or cleaning of equipment.  
Open dumping is prohibited.

### PESTICIDE STORAGE

Keep pesticide in original container. Do not put concentrate or dilute into food or drink containers.  
Store in cool, dry place. Do not store diluted spray.

**Emergency Response:** For help with any spill, leak, fire or exposure involving this material, call day or night 1-800-892-0099.

### PESTICIDE DISPOSAL

Wastes resulting from the use of this product may be disposed of on site or at an approved waste disposal facility.

### CONTAINER DISPOSAL

Nonrefillable container. Do not refill or reuse container. Triple rinse container (or equivalent) promptly after emptying. Then offer for recycling or reconditioning, or puncture and dispose of in a sanitary landfill, or incineration, or, if allowed by State and local authorities, by burning. If burned, stay out of smoke. Triple rinse as follows: Empty the remaining contents into application equipment or a mix tank and drain for 10 seconds after the flow begins to drip. Fill the container 1/4 full with water and recap. Shake for 10 seconds. Pour rinsate into application equipment or a mix tank or store rinsate for later use or disposal. Drain for 10 seconds after the flow begins to drip. Repeat this procedure two more times.

- ASANA® - Reg. TM of DuPont
- AUTHORITY BROADLEAF® - Reg. TM of E.I. duPont de Nemours & Co. Inc.
- BANVEL® - Reg. TM of BASF Corporation
- BASAGRAN® - Reg. TM of BASF AG.
- BAYTHROID® - Reg. TM Bayer Corporation
- BETAMIX® - Reg. TM of The Aventis Group
- BETANEX® - Reg. TM of The Aventis Group
- BLAZER® - Reg. TM of United Phosphorus, Inc.
- BRONATE®, BRONATE ADVANCED™ - Reg. TM of Bayer Crop Science
- BUCTRIL® - Reg. TM of Bayer Corporation
- CANOPY XL® - Reg. TM of E.I. duPont de Nemours & Co. Inc.
- CLASSIC® - Reg. TM of E.I. duPont de Nemours & Co., Inc.
- COBRA® - Reg. TM of Valent U.S.A. Corporation
- DANITOL® - Reg. TM of Sumitomo Chemical Co., Ltd.
- DUAL®, DUAL II® AND DUAL MAGNUM® - Reg. TMs of Syngenta Corporation
- EMINENT® - Reg. TM of Sipcarn Agro USA, Inc.
- FIRSTRATE® - Reg. TM of Dow AgroSciences LLC
- FLEXSTAR® - Reg. TM of Syngenta Corporation
- FRONTROW™ - TM of Dow AgroSciences LLC
- IMI-CORN® - Reg. TM of BASF Corporation
- LIBERTY LINK® - Reg. TM of The Aventis Group
- LORSBAN® - Reg. TM of Dow AgroSciences LLC
- ORTHENE® - Reg. TM of OMS Investments, Inc.
- POUNCE® - Reg. TM FMC Corporation
- PROWL® - Reg. TM of BASF Corporation
- PURSUIT® and PURSUIT DG® - Reg. TMs of BASF Corporation
- RAPTOR® - Reg. TM of BASF Corporation
- RESOURCE® - Reg. TM of Valent U.S.A. Corporation
- RHONOX® - Reg. TM of Nufarm Americas Inc.
- ROUNDUP READY® and ROUNDUP ULTRA® - Reg. TMs of Monsanto Company
- SELECT® - Reg. TM of Valent U.S.A. Corporation
- SENCOR® - Reg. TM of Bayer Corporation
- STINGER® - Reg. TM of Dow AgroSciences LLC
- STORM® - Reg. TM of BASF Corporation
- SYNCHRONY® STS™ - TM and Reg. TM of E.I. duPont de Nemours & Co. Inc.
- VALOR® - Reg. TM of Valent U.S.A. Corporation
- TURBO® - Reg. TM of Bayer Corporation
- WARRIOR® - Reg. TM of Syngenta Corporation



## RETURNABLE KEG

**Description:** This keg is a closed-system, refillable container designed for easy handling and convenient dispensing of product with no container disposal.

**Construction:** The keg is made of all stainless steel. Both the gaskets and seals are Viton and are compatible with the J. Oliver Products, LLC product.

**Pump System:** With the versatility of the keg, either a mechanical pump or an air pressure system may be used to dispense the product.

**Coupler:** A specific dry-disconnect coupler is required for dispensing product from the keg. This coupler is available through local agricultural equipment suppliers.

**Container Capacity:** 15 gallons or 56.7 liters (by weight)

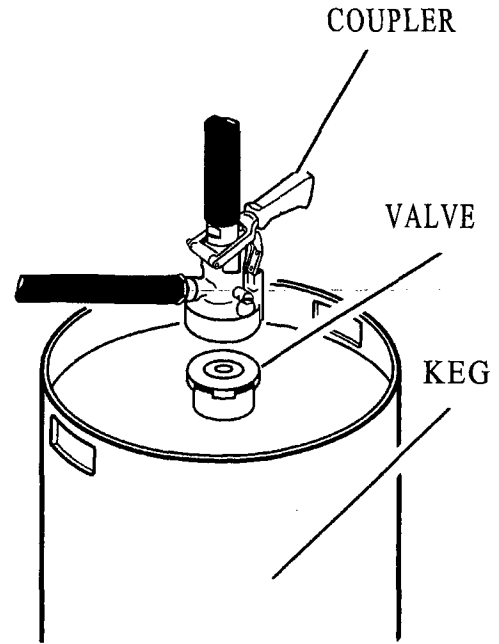

## ATTENTION!

This is a closed-system container. Do not try to remove the valve from the keg. The coupler required for removal of product is available from local agricultural equipment suppliers. The keg contains tamper evident seals that, if broken, will incur a fee for the user of the keg. Both the coupler and the valve are designed for one-way operation only. Never try to pump any type of material back into the keg.

## DIRECTIONS FOR USE

The proper coupler must be attached and engaged before removing any product from the keg. Either a mechanical pump or an air pressure system may be used and connected to the 1-inch NPT thread on the top of the coupler.

**IMPORTANT!** Attach a hose or pump to the coupler before engaging coupler. This will prevent the user from being splashed in the event that pressure build-up in the keg forces liquid up through the coupler.

### To attach and engage the coupler:

1. Pull top of black dust cover back to expose head of valve. The bottom ring of the black dust cover will still be attached to the neck of the valve. Save the dust cover for reuse when returning keg.
2. Before engaging the coupler, securely attach a hose or pump to the threaded connection.
3. Twist coupler onto valve on keg and engage coupler by pulling handle straight out to unlock and then pushing handle down into lower position to open internal valve. Handle will automatically lock in place.
4. Secure and engage coupler by pulling handle straight out to unlock and then pushing handle down into lower position to open internal valve. Handle will automatically lock in place.
5. You are now ready to begin the pumping operation.

### To remove coupler from container:

1. Release coupler by pulling handle straight out to unlock and then lifting handle into upper position. Handle will automatically lock in place.
2. Lift coupler from keg. As coupler clears top of valve, pull coupler sideways and lift it off the valve.
3. Wipe valve off and replace dust cover.
4. Flush coupler with water.
5. Wipe coupler and store in a clean place.
6. Properly dispose of cleaning towels and rinsate.

## RETURNING KEGS

Clean the outside of the keg with water or soap before returning the keg to the distributor. Leave all J. Oliver Products, LLC product labels and stickers securely attached. All J. Oliver Products, LLC product labels, stickers and other information must remain on the keg in order to comply with both State and Federal regulations.

All J. Oliver Products, LLC kegs are tracked using the individual keg serial number stamped in the top of the keg. Distributors are responsible for these kegs that have been assigned to them. Return this keg to the distributor from which it was purchased. Notify the distributor if the keg cannot be returned by the specific time.