

71995-47

3/21/2011

10f11



UNITED STATES ENVIRONMENTAL PROTECTION AGENCY
WASHINGTON, D.C. 20460

OFFICE OF CHEMICAL SAFETY
AND POLLUTION PREVENTION

MAR 21 2011

mailed
3/21/2011

Ms. Dawn Fee-White
Monsanto Company
1300 I (Eye) Street, NW
Suite 450 East
Washington, DC 20005

Subject: Notification.

Ms. Fee-White:

The Agency is in receipt of your Applications, dated July 13, 2010, for Pesticide Notification under Pesticide Registration Notice (PRN) 98-10, and under PRN 2007-4 for the products Roundup Ready-To-Use Extended Control Weed & Grass Killer Plus Weed Preventer II (EPA Reg. No. 71995-47). The Registration Division (RD) has conducted a review of this request for its applicability under PRNs 98-10 and 2007-4, and finds that the action(s) requested fall within the scope of PRNs 98-10 and 2007-4. The Confidential Statement of Formula (CSF) and/or label submitted with the application has (have) been stamped "Notification" and will be placed in our records.

Please be reminded that 40 CFR Part 156.140(a)(4) requires that a batch code, lot number, or other code identifying the batch of the pesticide distributed and sold be placed on nonrefillable containers. The code may appear either on the label (and can be added by non-notification/PR Notice 98-10) or durably marked on the container itself.

If you have any questions, please contact Phil Errico at 703-305-6663/
errico.philip@epa.gov.

Sincerely,

A handwritten signature in black ink, appearing to read "Kable Bo Davis".

Kable Bo Davis PM-25
Herbicide Branch/Registration Division (7505P)
Office of Pesticide Programs



United States
Environmental Protection Agency
 Washington, DC 20460

Registration
 Amendment
 Other

OPP Identifier Number

Application for Pesticide – Section I

1. Company/Product Number Monsanto Company, Lawn & Garden Products 71995-47	2. EPA Product Manager James A. Tompkins	3. Proposed Classification <input type="checkbox"/> None <input type="checkbox"/> Restricted
4. Company/Product (Name) Monsanto Company, Lawn & Garden Products Roundup Ready-To-Use Extended Control Weed & Grass Killer Plus Weed Preventer II	PM # 25	
5. Name and Address of Applicant (Include ZIP Code) Monsanto Company 1300 I (Eye) Street, NW – Suite 450 East Washington, DC 20005 <input type="checkbox"/> Check if this is a new address	6. Expedited Review. In accordance with FIFRA Section 3(c)(3) (b)(i), my product is similar or identical in composition and labeling to: EPA Reg. No. _____ Product Name _____	

Section – II

NOTIFICATION

MAR 21 2011

<input type="checkbox"/> Amendment – Explain below.	<input type="checkbox"/> Final printed labels in response to Agency letter dated
<input type="checkbox"/> Resubmission in response to Agency letter dated	<input type="checkbox"/> "Me Too" Application.
<input checked="" type="checkbox"/> Notification – Explain below.	<input type="checkbox"/> Other – Explain below.

Explanation: Use additional page(s) if necessary. (For section I and Section II.) PRIA address: REGULATORY.AFFAIRS@MONSANTO.COM

Notification of label change relative to PR Notice 2008-1. This notification is consistent with the guidance in PR Notice 2008-1 and the requirements of EPA regulations at 40 CFR 152.46, 40 CFR 156.10, 40 CFR 156.80, and no other changes have been made to the labeling or the confidential statement of formula of this product. I understand that it is a violation of 18 U.S.C. Sec. 1001 to willfully make any false statement to EPA. I further understand that if this notification is not consistent with the terms of PR Notice 2008-1 and 40 CFR 152.46, 40 CFR 156.10, 40 CFR 156.80, this product may be in violation of FIFRA and I may be subject to enforcement action and penalties under sections 12 and 14 of FIFRA.

Section – III

1. Material This Product Will Be Packaged In:				2. Type of Container	
Child-Resistant Packaging <input type="checkbox"/> Yes* <input checked="" type="checkbox"/> No	Unit Packaging <input type="checkbox"/> Yes <input checked="" type="checkbox"/> No	Water Soluble Packaging <input type="checkbox"/> Yes <input checked="" type="checkbox"/> No		<input type="checkbox"/> Metal <input checked="" type="checkbox"/> Plastic <input type="checkbox"/> Glass <input type="checkbox"/> Paper <input type="checkbox"/> Other (Specify)	
* Certification must be submitted		If "Yes" Unit Packaging wgt.	No. per Container	If "Yes" Package wgt.	No. per Container
3. Location of Net Contents Information <input type="checkbox"/> Label <input checked="" type="checkbox"/> Container		4. Size(s) Retail Container 24oz; 64oz; 1 Gal; 1.25 Gal; 1.33 Gal PNG; 1.33 Gal PNS		5. Location of Label Directions <input checked="" type="checkbox"/> On Label <input type="checkbox"/> On Labeling accompanying product	
6. Manner in Which Label is Affixed to Product					
				<input type="checkbox"/> Lithograph <input checked="" type="checkbox"/> Paper glued <input type="checkbox"/> Stenciled <input type="checkbox"/> Other _____	

Section – IV

1. Contact Point (Complete items directly below for identification of individual to be contacted, if necessary, to process this application.)		
Name Russell P. Schneider, Ph.D.	Title Senior Director of US Regulatory Affairs and Public Policy	Telephone No. (Include Area Code) (202) 383-2866
Certification I certify that the statements I have made on this form and all attachments thereto are true, accurate and complete. I acknowledge that any knowingly false or misleading statement may be punishable by fine or imprisonment or both under applicable law.		6. Date Application Received (Stamped)
2. Signature 	3. Title Registration Manager	
4. Typed Name Dawn Fee-White	5. Date July 13, 2010	

MONSANTO



30f11

MONSANTO COMPANY
1300 I (EYE) STREET, NW
SUITE 450 EAST
WASHINGTON, D.C. 20005
PHONE (202) 383-2866
FAX (202) 789-1748
<http://www.monsanto.com>

July 13, 2010

Document Processing Desk (NOTIF)
Registration Division – H7505P
U.S. Environmental Protection Agency
One Potomac Yard
2777 S. Crystal Drive, Room S4900
Arlington, Virginia 22202

Attention: Mr. James A. Tompkins - Product Manager 25

Subject: **Notification of Compliance with PRN 2008-1 and Submission of Final Printed Label for Roundup Ready-To-Use Extended Control Weed & Grass Killer Plus Weed Preventer II, EPA Reg. No 71995-47**

Dear Mr. Tompkins:

On July 24, 2008, the Agency approved a master label for RD 1653 with an alternate brand name on EPA Reg. No. 71995-47. Per PR Notice 2008-1, Monsanto is herein notifying the Agency of updated Environmental Hazards language consistent with a liquid RTU outdoor residential product.

Notification of label change relative to PR Notice 2008-1. This notification is consistent with the guidance in PR Notice 2008-1 and the requirements of EPA regulations at 40 CFR 152.46, 40 CFR 156.10, 40 CFR 156.80, and no other changes have been made to the labeling or the confidential statement of formula of this product. I understand that it is a violation of 18 U.S.C. Sec. 1001 to willfully make any false statement to EPA. I further understand that if this notification is not consistent with the terms of PR Notice 2008-1 and 40 CFR 152.46, 40 CFR 156.10, 40 CFR 156.80, this product may be in violation of FIFRA and I may be subject to enforcement action and penalties under sections 12 and 14 of FIFRA.

According to PR Notice 98-10, it is not necessary to notify the Agency of non-FIFRA regulated deletions consistent with 40 CFR 152.46(b). Monsanto is also using this update to remove the 1-800-CLEANUP number from the solid waste disposal instructions as we have elected not to renew that contract which expires 12/31/2010 and to remove patent statements no longer relevant to this product. On June 3, 2010, Monsanto Lawn & Garden Products requested correction to the Pesticide Product Information System to reflect the correct company name for 71995 as reflected in the transfer of registration form company number 239 to company number 71995 dated March 5, 1999. This label also reflects the corrected company name.

30f11

PACKAGE DESIGN APPROVAL		
FUNCTION	DATE	SIGNATURE
PACKAGING		
PRODUCT DEVL.		
REG. COMPLIANCE		
LEGAL		

NOTIFICATION
 MAR 21 2011

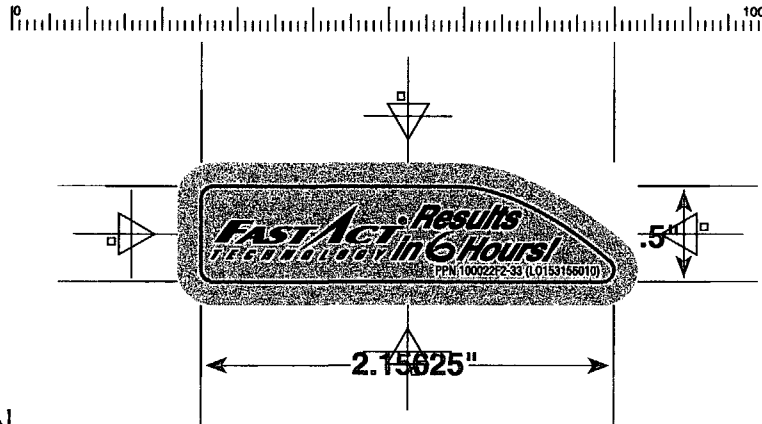

STEVENSON
THE COLOR COMPANY

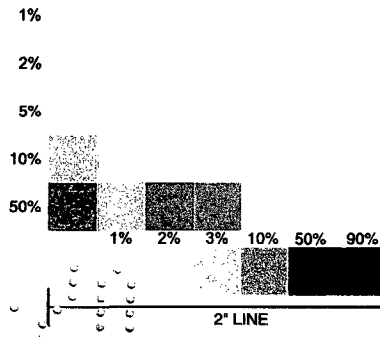

08-0043 ROUND UP FAST ACT UNDER HANDLE SHOULDER LABEL
 File Name :A0043X04 PRINTER:CCL LABEL - MEMPHIS

2" LINE

	Black		DIE
	RUC champagne		
	PANTONE 485 C		

5011

60911

NOTIFICATION

MAR 21 2011

AJ2809 / 06-27-05 VF

Brand	RU EC RTU
Description	Front label 24 oz.
PP#10002263-32	spec# LF15300D020
Date 12/07/2009	

NOTIFICATION

MAR 21 2011

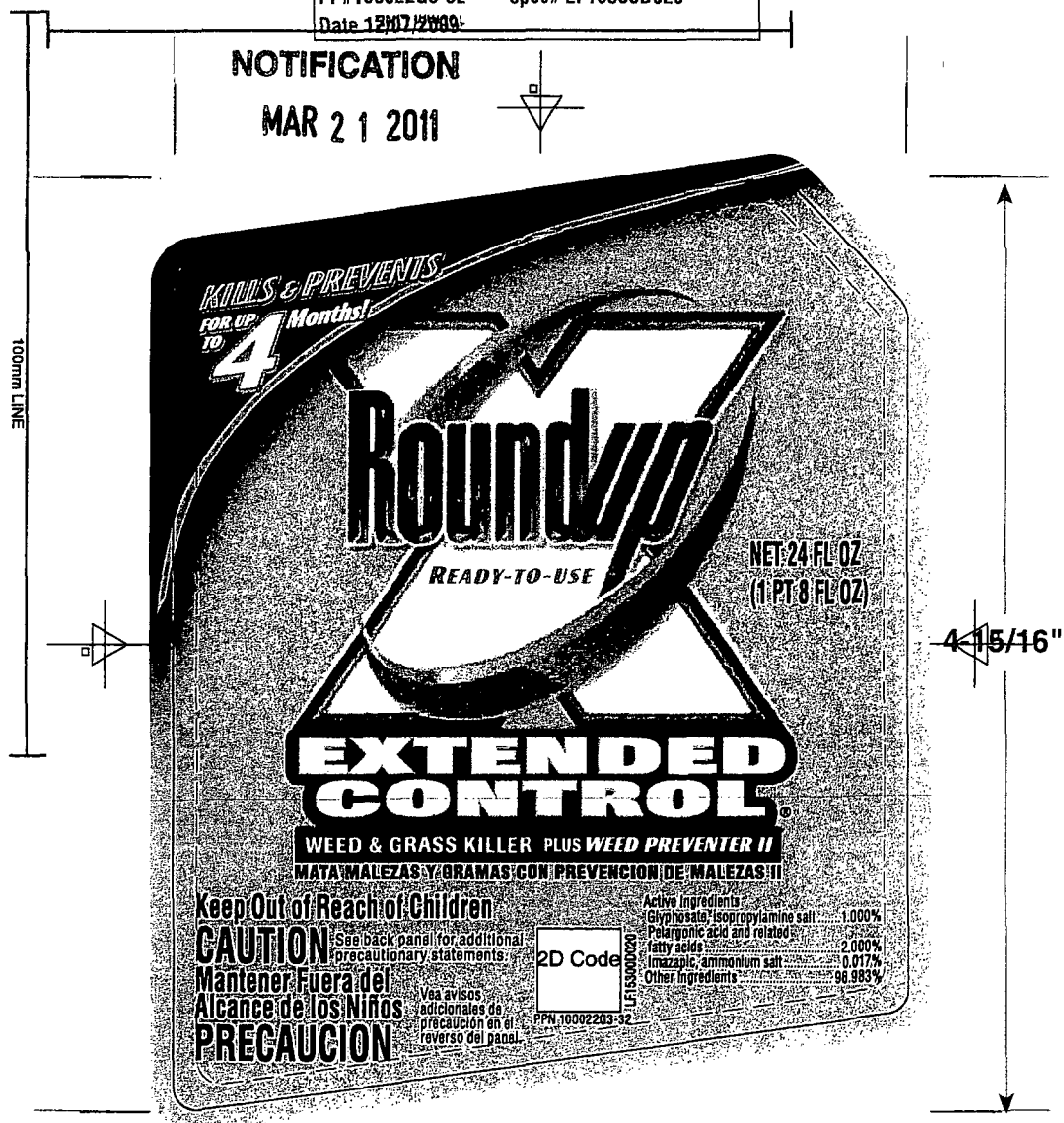

1/4"

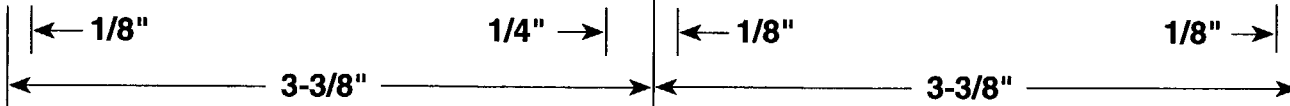

ALMACENAMIENTO Y ELIMINACION

ALMACENAMIENTO DEL PESTICIDA: Gire la boquilla a la posición de cerrado. Guarde el producto en el envase original en un lugar seguro lejos de la luz directa del sol. Protéjalo del congelamiento.

ELIMINACION DEL PESTICIDA: No vuelva a usar o rellenar este envase a menos que las instrucciones permitan diluir o verter directamente en el envase un producto concentrado o listo para usar distinto. Debe volver a usar o rellenar este envase de acuerdo con las instrucciones contenidas en la sección de **RELLENADO**. **Envase vacío:** Tírelo en la basura u ofrézcalo para reciclado si está disponible. **Envase parcialmente lleno:** Llame a su servicio local de eliminación de desechos sólidos para obtener instrucciones de eliminación. Nunca elimine el producto sin usar en ningún drenaje interior o exterior.

AVISOS DE PRECAUCION

RIESGOS PARA LOS SERES HUMANOS Y ANIMALES DOMESTICOS

PRECAUCION: Causa irritación moderada en los ojos. Evite el contacto con los ojos o la ropa. Lávese completamente con jabón y agua después de manipular.

PRIMEROS AUXILIOS

SI ENTRA EN LOS OJOS	<ul style="list-style-type: none"> Mantenga el ojo abierto y enjuague lenta y suavemente con agua durante 15 a 20 minutos. Retire los lentes de contacto, si hubiera, después de los primeros 5 minutos, luego continúe enjuagando los ojos. Llame a un centro de control de envenenamiento, 1-800-246-7219, o al médico para obtener más consejos sobre tratamiento.
-----------------------------	--------------------------------------------------------------------------------------------------------------------------------------------------------------------------------------------------------------------------------------------------------------------------------------------------------------------------------------------------------------------------------------------------------

INFORMACION MEDICA DE EMERGENCIA

- Tenga consigo el envase o etiqueta del producto cuando llame al centro de control de envenenamiento o al médico, o acuda al tratamiento.
- Puede llamar al 1-800-246-7219 para obtener información sobre el tratamiento médico de emergencia.
- Este producto se ha identificado como Roundup Listo Para Usar Control Prolongado Mata Malezas y Gramas con Prevención de Malezas II, EPA Reg. No. 71995-47.

1/4"

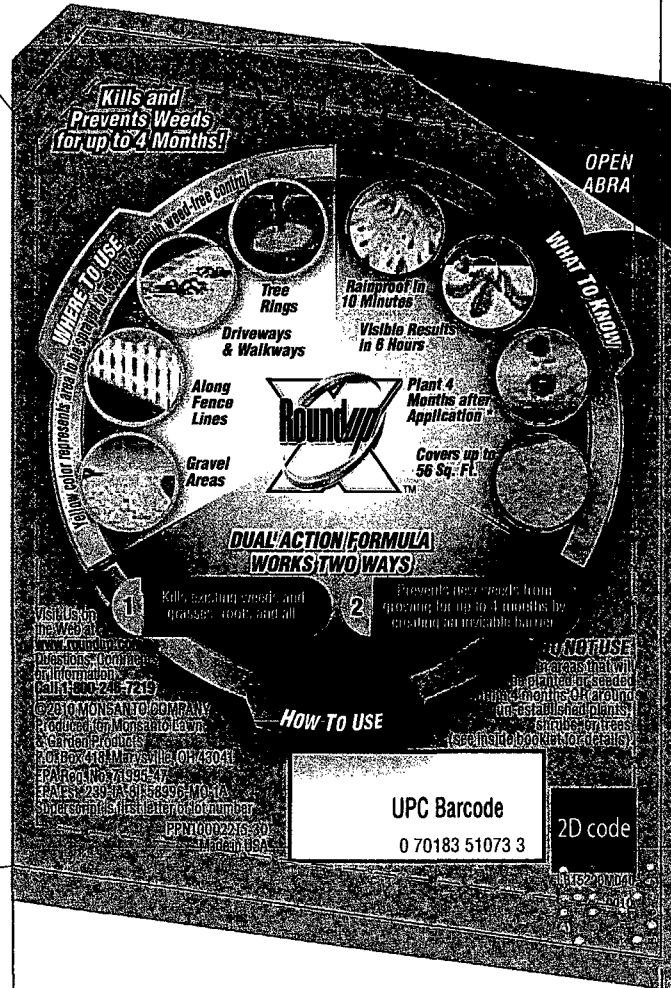

4-15/16"

70411

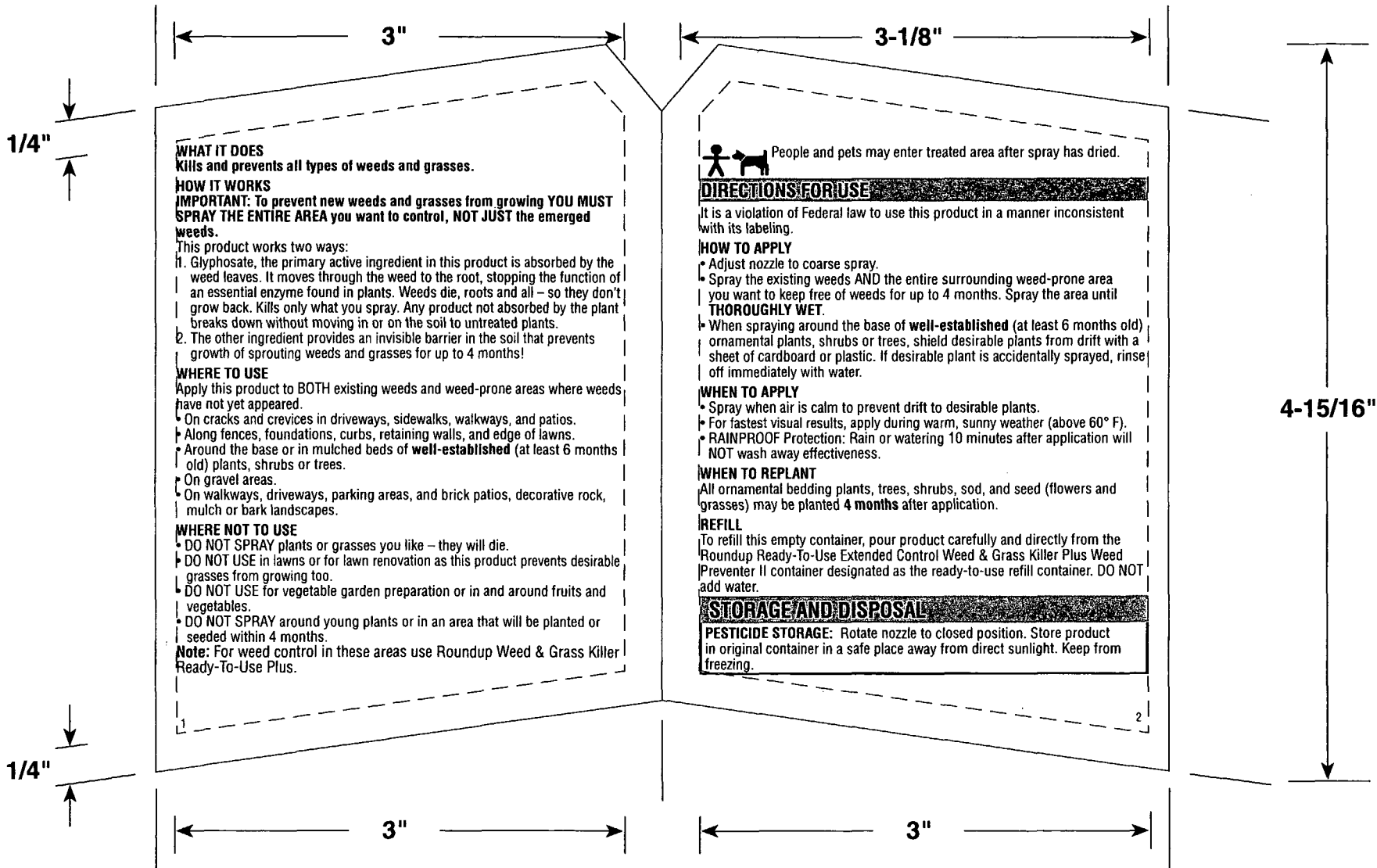

WHAT IT DOES

Kills and prevents all types of weeds and grasses.

HOW IT WORKS

IMPORTANT: To prevent new weeds and grasses from growing **YOU MUST SPRAY THE ENTIRE AREA** you want to control, **NOT JUST** the emerged weeds.

This product works two ways:

1. Glyphosate, the primary active ingredient in this product is absorbed by the weed leaves. It moves through the weed to the root, stopping the function of an essential enzyme found in plants. Weeds die, roots and all – so they don't grow back. Kills only what you spray. Any product not absorbed by the plant breaks down without moving in or on the soil to untreated plants.
2. The other ingredient provides an invisible barrier in the soil that prevents growth of sprouting weeds and grasses for up to 4 months!

WHERE TO USE

Apply this product to BOTH existing weeds and weed-prone areas where weeds have not yet appeared.

- On cracks and crevices in driveways, sidewalks, walkways, and patios.
- Along fences, foundations, curbs, retaining walls, and edge of lawns.
- Around the base or in mulched beds of **well-established** (at least 6 months old) plants, shrubs or trees.
- On gravel areas.
- On walkways, driveways, parking areas, and brick patios, decorative rock, mulch or bark landscapes.

WHERE NOT TO USE

- DO NOT SPRAY plants or grasses you like – they will die.
- DO NOT USE in lawns or for lawn renovation as this product prevents desirable grasses from growing too.
- DO NOT USE for vegetable garden preparation or in and around fruits and vegetables.
- DO NOT SPRAY around young plants or in an area that will be planted or seeded within 4 months.

Note: For weed control in these areas use Roundup Weed & Grass Killer Ready-To-Use Plus.



People and pets may enter treated area after spray has dried.

DIRECTIONS FOR USE

It is a violation of Federal law to use this product in a manner inconsistent with its labeling.

HOW TO APPLY

- Adjust nozzle to coarse spray.
- Spray the existing weeds **AND** the entire surrounding weed-prone area you want to keep free of weeds for up to 4 months. Spray the area until **THOROUGHLY WET.**
- When spraying around the base of **well-established** (at least 6 months old) ornamental plants, shrubs or trees, shield desirable plants from drift with a sheet of cardboard or plastic. If desirable plant is accidentally sprayed, rinse off immediately with water.

WHEN TO APPLY

- Spray when air is calm to prevent drift to desirable plants.
- For fastest visual results, apply during warm, sunny weather (above 60° F).
- **RAINPROOF** Protection: Rain or watering 10 minutes after application will NOT wash away effectiveness.

WHEN TO REPLANT

All ornamental bedding plants, trees, shrubs, sod, and seed (flowers and grasses) may be planted **4 months** after application.

REFILL

To refill this empty container, pour product carefully and directly from the Roundup Ready-To-Use Extended Control Weed & Grass Killer Plus Weed Preventer II container designated as the ready-to-use refill container. DO NOT add water.

STORAGE AND DISPOSAL

PESTICIDE STORAGE: Rotate nozzle to closed position. Store product in original container in a safe place away from direct sunlight. Keep from freezing.

80211

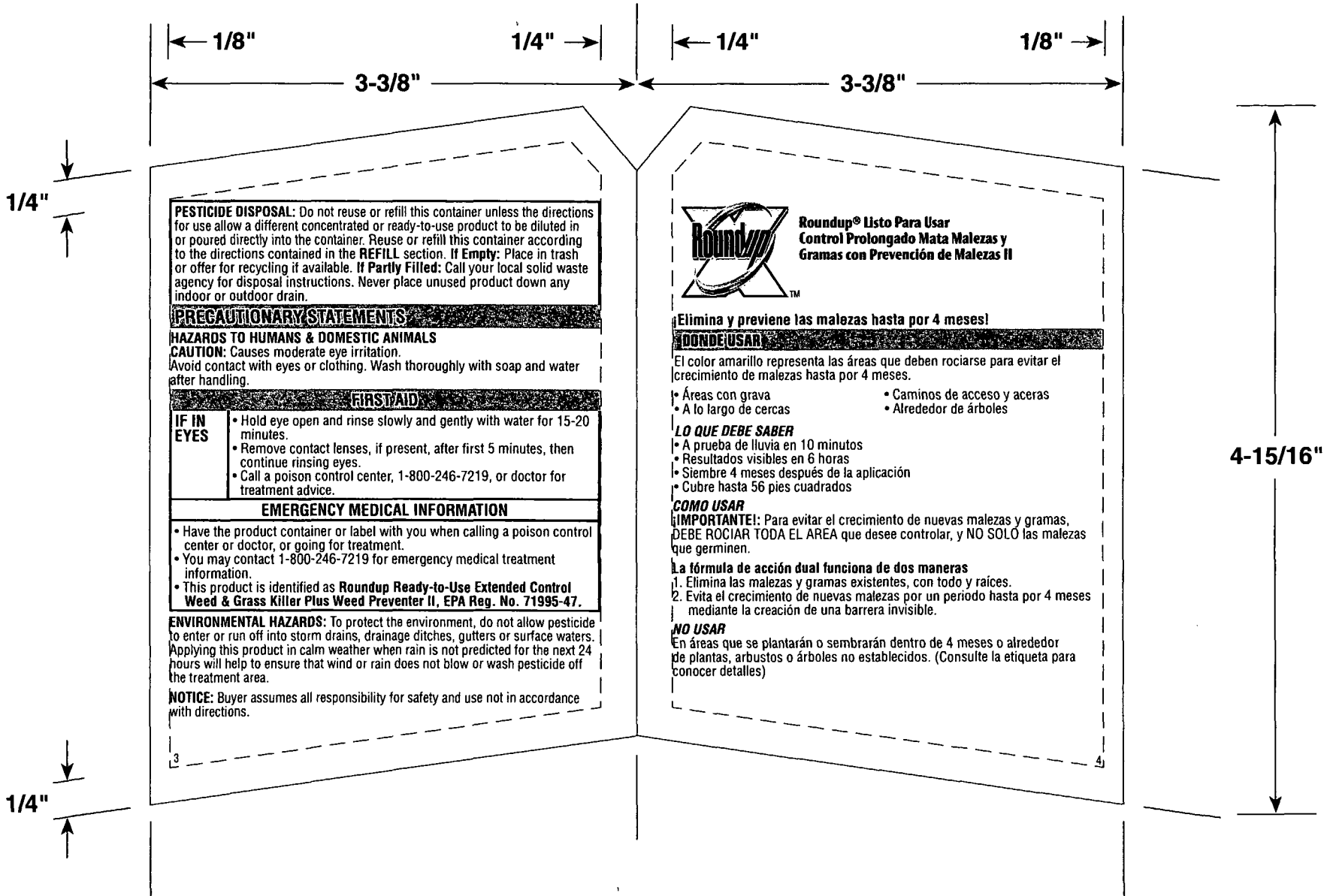

PESTICIDE DISPOSAL: Do not reuse or refill this container unless the directions for use allow a different concentrated or ready-to-use product to be diluted in or poured directly into the container. Reuse or refill this container according to the directions contained in the REFILL section. If Empty: Place in trash or offer for recycling if available. If Partly Filled: Call your local solid waste agency for disposal instructions. Never place unused product down any indoor or outdoor drain.

PRECAUTIONARY STATEMENTS

HAZARDS TO HUMANS & DOMESTIC ANIMALS
CAUTION: Causes moderate eye irritation.
 Avoid contact with eyes or clothing. Wash thoroughly with soap and water after handling.

FIRST AID

IF IN EYES	<ul style="list-style-type: none"> Hold eye open and rinse slowly and gently with water for 15-20 minutes. Remove contact lenses, if present, after first 5 minutes, then continue rinsing eyes. Call a poison control center, 1-800-246-7219, or doctor for treatment advice.
-------------------	-----------------------------------------------------------------------------------------------------------------------------------------------------------------------------------------------------------------------------------------------------------------------------------------------------------------

EMERGENCY MEDICAL INFORMATION

- Have the product container or label with you when calling a poison control center or doctor, or going for treatment.
- You may contact 1-800-246-7219 for emergency medical treatment information.
- This product is identified as Roundup Ready-to-Use Extended Control Weed & Grass Killer Plus Weed Preventer II, EPA Reg. No. 71995-47.

ENVIRONMENTAL HAZARDS: To protect the environment, do not allow pesticide to enter or run off into storm drains, drainage ditches, gutters or surface waters. Applying this product in calm weather when rain is not predicted for the next 24 hours will help to ensure that wind or rain does not blow or wash pesticide off the treatment area.

NOTICE: Buyer assumes all responsibility for safety and use not in accordance with directions.



Roundup® Listo Para Usar
Control Prolongado Mata Malezas y Gramas con Prevención de Malezas II

Elimina y previene las malezas hasta por 4 meses!

¿DONDE USAR?

El color amarillo representa las áreas que deben rociarse para evitar el crecimiento de malezas hasta por 4 meses.

- Áreas con grava
- A lo largo de cercas
- Caminos de acceso y aceras
- Alrededor de árboles

¿LO QUE DEBE SABER

- A prueba de lluvia en 10 minutos
- Resultados visibles en 6 horas
- Siembre 4 meses después de la aplicación
- Cubre hasta 56 pies cuadrados

¿COMO USAR

¡IMPORTANTE! Para evitar el crecimiento de nuevas malezas y gramas, **DEBE ROCIAR TODA EL AREA** que desee controlar, y **NO SOLO** las malezas que germinen.

La fórmula de acción dual funciona de dos maneras

- Elimina las malezas y gramas existentes, con todo y raíces.
- Evita el crecimiento de nuevas malezas por un periodo hasta por 4 meses mediante la creación de una barrera invisible.

NO USAR

En áreas que se plantarán o sembrarán dentro de 4 meses o alrededor de plantas, arbustos o árboles no establecidos. (Consulte la etiqueta para conocer detalles)

90511

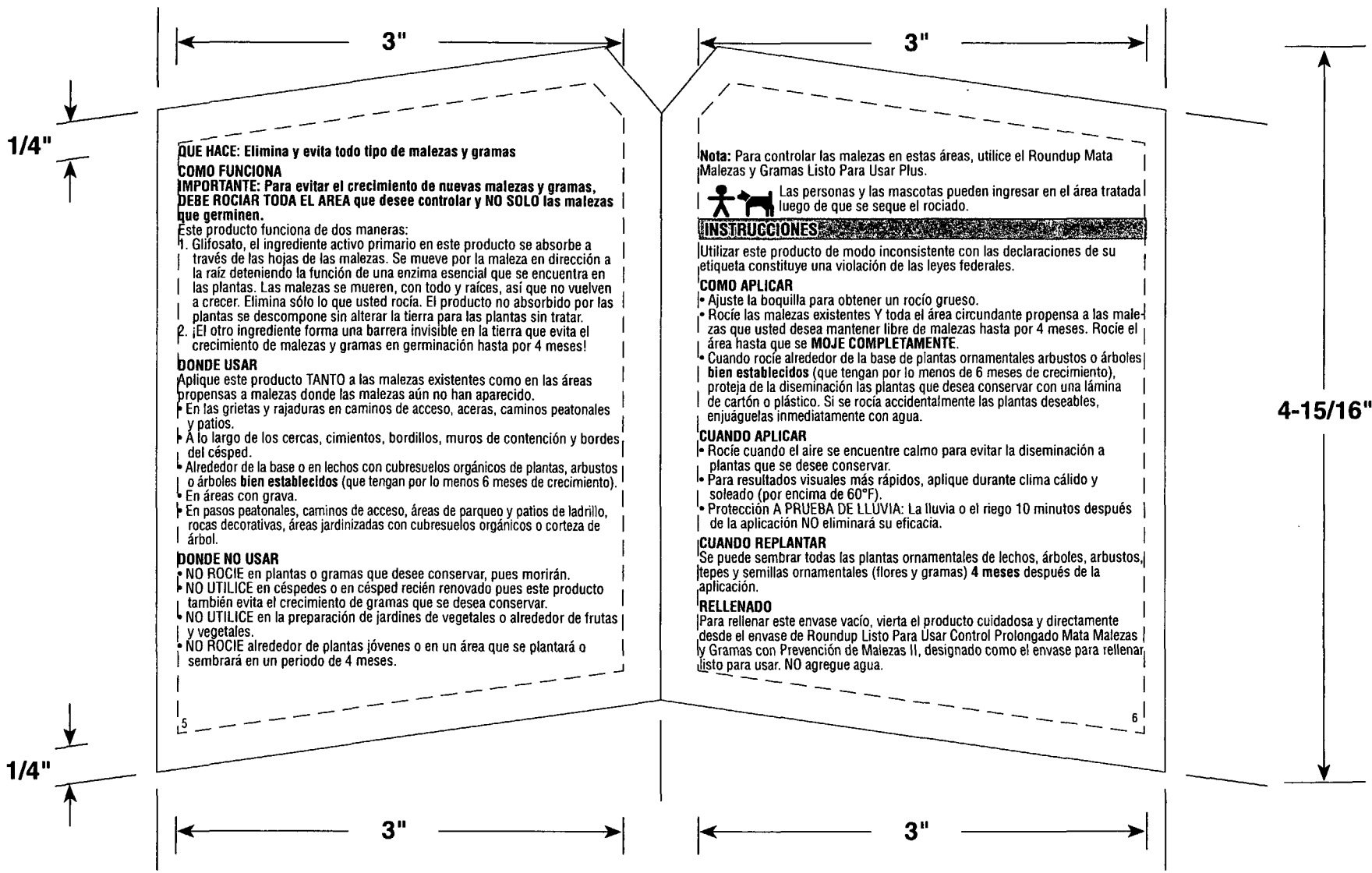

QUE HACE: Elimina y evita todo tipo de malezas y gramas
COMO FUNCIONA
IMPORTANTE: Para evitar el crecimiento de nuevas malezas y gramas, **DEBE ROCIAR TODA EL AREA** que desee controlar y **NO SOLO** las malezas que germinen.

Este producto funciona de dos maneras:
 1. Glifosato, el ingrediente activo primario en este producto se absorbe a través de las hojas de las malezas. Se mueve por la maleza en dirección a la raíz deteniendo la función de una enzima esencial que se encuentra en las plantas. Las malezas se mueren, con todo y raíces, así que no vuelven a crecer. Elimina sólo lo que usted rocía. El producto no absorbido por las plantas se descompone sin alterar la tierra para las plantas sin tratar.
 2. ¡El otro ingrediente forma una barrera invisible en la tierra que evita el crecimiento de malezas y gramas en germinación hasta por 4 meses!

DONDE USAR
 Aplique este producto **TANTO** a las malezas existentes como en las áreas propensas a malezas donde las malezas aún no han aparecido.
 • En las grietas y rajaduras en caminos de acceso, aceras, caminos peatonales y patios.
 • A lo largo de los cercas, cimientos, bordillos, muros de contención y bordes del césped.
 • Alrededor de la base o en lechos con cubresuelos orgánicos de plantas, arbustos o árboles **bien establecidos** (que tengan por lo menos 6 meses de crecimiento).
 • En áreas con grava.
 • En pasos peatonales, caminos de acceso, áreas de parqueo y patios de ladrillo, rocas decorativas, áreas jardinizadas con cubresuelos orgánicos o corteza de árbol.

DONDE NO USAR
 • **NO ROCIE** en plantas o gramas que desee conservar, pues morirán.
 • **NO UTILICE** en céspedes o en césped recién renovado pues este producto también evita el crecimiento de gramas que se desea conservar.
 • **NO UTILICE** en la preparación de jardines de vegetales o alrededor de frutas y vegetales.
 • **NO ROCIE** alrededor de plantas jóvenes o en un área que se plantará o sembrará en un periodo de 4 meses.

Nota: Para controlar las malezas en estas áreas, utilice el Roundup Mata Malezas y Gramas Listo Para Usar Plus.

 Las personas y las mascotas pueden ingresar en el área tratada luego de que se seque el rociado.

INSTRUCCIONES

Utilizar este producto de modo inconsistente con las declaraciones de su etiqueta constituye una violación de las leyes federales.

COMO APLICAR
 • Ajuste la boquilla para obtener un rocío grueso.
 • Rocíe las malezas existentes Y toda el área circundante propensa a las malezas que usted desea mantener libre de malezas hasta por 4 meses. Rocíe el área hasta que se **MOJE COMPLETAMENTE**.
 • Cuando rocíe alrededor de la base de plantas ornamentales arbustos o árboles **bien establecidos** (que tengan por lo menos de 6 meses de crecimiento), proteja de la diseminación las plantas que desea conservar con una lámina de cartón o plástico. Si se rocía accidentalmente las plantas deseables, enjuáguelas inmediatamente con agua.

CUANDO APLICAR
 • Rocíe cuando el aire se encuentre calmo para evitar la diseminación a plantas que se desee conservar.
 • Para resultados visuales más rápidos, aplique durante clima cálido y soleado (por encima de 60°F).
 • Protección A PRUEBA DE LLUVIA: La lluvia o el riego 10 minutos después de la aplicación **NO** eliminará su eficacia.

CUANDO REPLANTAR
 Se puede sembrar todas las plantas ornamentales de lechos, árboles, arbustos, tepes y semillas ornamentales (flores y gramas) **4 meses** después de la aplicación.

RELLENADO
 Para rellenar este envase vacío, vierta el producto cuidadosa y directamente desde el envase de Roundup Listo Para Usar Control Prolongado Mata Malezas y Gramas con Prevención de Malezas II, designado como el envase para rellenar listo para usar. **NO** agregue agua.

4-15/16"

10811



RIESGOS AMBIENTALES: Para proteger el ambiente, no permita que el pesticida entre o se escurra en drenajes pluviales, zanjas de drenaje, cunetas o aguas superficiales. Aplicar este producto en clima tranquilo cuando no haya pronóstico de lluvia para las siguientes 24 horas ayudará a asegurarse de que el viento o la lluvia no soplen o laven el pesticida del área de tratamiento.

NOTIFICACION: El comprador asume toda responsabilidad de la seguridad y uso que no sea conforme con las instrucciones.



Roundup® Ready-To-Use Extended Control Weed & Grass Killer Plus Weed Preventer II
Roundup Listo Para Usar Control Prolongado Mata Malezas y Gramas con Prevención de Malezas II

Guaranteed Satisfaction.

CONSUMER GUARANTEE
 If for any reason you are not satisfied after using this product, simply send us original proof of purchase and we will replace the product or refund the purchase price.

Roundup Lawn & Garden products have the best solutions for your toughest weed problems.

- Roundup Extended Control Weed & Grass Killer Plus Weed Preventer products – kills & prevents for up to 4 months
- Roundup Weed & Grass Killer Ready-To-Use Plus – no mixing, no mess
- Roundup Poison Ivy Plus Tough Brush Killer products – kills tough, brushy, hard-to-control weeds
- Roundup Weed & Grass Killer Concentrate Plus – fast visible results
- Roundup Weed & Grass Killer Super Concentrate – best Roundup concentrate value



Questions, Comments or Information
 1-800-246-7219 www.roundup.com
Preguntas, Comentarios o Información?

Patents pending. No license granted under any non-U.S. patent(s).
 Roundup Extended Control and X design are trademarks of Monsanto Technology LLC
 © 2010 MONSANTO COMPANY
 Produced for Monsanto Lawn & Garden Products
 P.O. Box 418, Marysville, OH 43041
 EPA Reg. No. 71995-47
 EPA Est. 239-IA-31, 58996-MO-1A Superscript is first letter of lot number

PPN 10002215-30 (LB15290M040)
 Made in USA

Resealable Label for Directions & Precautions / Etiqueta re-cerrable para instrucciones y avisos de precaución.

Brand:	RU EC RTU
Description:	Back ECL 24 oz.
PP#	10002215-30 spec#LB15290M040
Date	07/06/2010

AJ2852 / 07-15-05 VF

110811