



UNITED STATES ENVIRONMENTAL PROTECTION AGENCY  
WASHINGTON, D.C. 20460

OFFICE OF  
PREVENTION, PESTICIDES AND  
TOXIC SUBSTANCES

Mr. David Swain  
Regulatory Specialist for,  
Zodiac Pool Systems, Inc.  
6000 Condor Drive  
Moorpark, CA 93021

JUL 28 2010

Subject: Nature<sup>2</sup> G45-VC40  
EPA Registration Number 67712-1  
Your Amendment Dated June 1<sup>st</sup>, 2010  
EPA Received Date June 2<sup>nd</sup>, 2010

The amendment referred to above, submitted in connection with registration under the Federal Insecticide, Fungicide, and Rodenticide Act, FIFRA, as amended, to add additional brand name, label claims, and to change the company name and address, is acceptable provided you make the following labeling revisions:

On page 3, delete the term(s), Around, Round, 24/7 the clock where ever it appears on the product labeling.

On page 3, delete the term(s), Constant/Consistent from the product labeling. It implies that the product, after one application, works continuously.

On page 3, delete the phrase the Cartridge meets EPA pool efficacy requirements. Since the product is registered with the Agency, it is understood that the data generated in support of the product meets all EPA data guideline requirements and has been reviewed and found to be acceptable.

On page 3, delete the phrase hassle, trouble free algae control. It implies that the product will eliminate all problems pertaining to one's algae control problems.

On page 3, revise the statement, Destroys bacteria...with CRT to read Destroys bacteria\*... with CRT. On the bottom of the page or back panel of the labeling, insert the \* symbol and list all the organisms that the product is efficacious against.

In page4, delete the statement, It works for you, for the product labeling. It implies that the

product works on algae containment problems.

On page 4, delete the statement, It works while you [sleep, play, swim], from the labeling. It implies that the product can be applied to the pool and works with not having to apply another dose. It also implies that the applicator can apply it and no maintenance can be done.

On page 4, delete the statement, Maintenance. Management free algae control, from the product labeling. It implies that after applications, the applicator does not have to perform maintenance, and/or management.

On page 4, insert \* symbol directly after the term bacteria. Place in the back panel the \* symbol, and list the organisms.

On page 5, delete the phrases, “fight, defend against, suppress, resist” algae. According to the 40 CFR, these terms are not included in the definition of the “pesticide”.

On page 5, delete the statement, “enhanced water quality”, from the product labeling. It implies that the quality of the municipally treated water has been enhanced.

On page 5, delete the statement, controls release of active ingredients, from the labeling. The release of the active ingredients does not impact the effectiveness of the product. The total formulation impacts the effectiveness of the product.

On page 5, revise the statement, Nature<sup>2</sup> provides silver....range to read Nature<sup>2</sup> provides silver and Copper Sulfate pentahydrate.....range. Both active ingredients impart a reaction to destroy bacteria.

On page 5, revise the statement, Silver destroys bacteria to reduce.....50%\*, to read as follows, Silver destroys bacteria\* to reduce.....50%. On the bottom of the page or on the back panel, insert \* and list organisms.

On page 5, delete the terms, creators of, inventors of, pioneers in pool mineral technology. It implies that the Nature<sup>2</sup> product is the only product on the market that is an effective algacide for swimming pools.

On page 9, revise the statement, Six, four month guarantee, to read as follows: specify the exact amount of time, either six or four month guarantee instead of a range.

The alternate brand name, Nature<sup>2</sup>Fusion, is acceptable.

A stamped copy of the labeling is enclosed for your records.

If you have questions concerning this letter, please contact Karen M. Leavy at (703)-308-6237.

Sincerely,

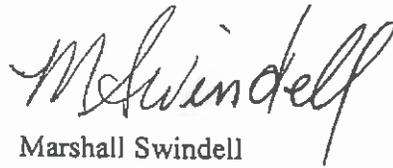
A handwritten signature in black ink that reads "M Swindell". The signature is written in a cursive style with a large, looped initial "M" and a long, sweeping tail on the "l".

Marshall Swindell  
Product Manager 33  
Regulatory Management Branch I  
Antimicrobials Division(7510P)

ACTIVE INGREDIENTS:  
 Metallic Silver\*\* .....3.51%  
 Copper Sulfate pentahydrate\*\*\* .....8.23%  
 (CAS No. 7758-99-8)  
 OTHER INGREDIENTS .....88.26%  
 TOTAL.....100.00%  
 \*\*From Silver Nitrate  
 \*\*\* Copper (Cu) as metallic ... 2.09%

\*The Nature<sup>2</sup> System consists of the patented Nature<sup>2</sup> technology<sup>†</sup> used in conjunction with a chlorine delivery device or 0.5ppm of an EPA registered chlorine pool product.  
 † Nature<sup>2</sup> technology consists of the minerals silver and copper.

KEEP OUT OF REACH OF CHILDREN  
**CAUTION**  
 SEE [BACK, SIDE, REAR] PANEL FOR ADDITIONAL PRECAUTIONARY STATEMENTS

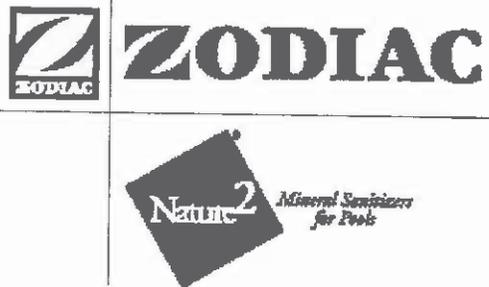

**Nature<sup>2</sup><sup>®</sup> G45-VC40**

EPA Reg. No. 67712-1  
 EPA Est. No. 67712-CA-001

NET CONTENTS: [ONE CARTRIDGE] [ONE UNIT]

ACCEPTED  
 with COMMENTS  
 EPA Letter Dated:  
 JUL 28 2010

Under the Federal Insecticide,  
 Fungicide, and Rodenticide Act as  
 amended, for the pesticide,  
 registered under EPA Reg. No.  
 67712-1

Note: Bracketed [ ] information is optional text/picture/diagram. Text separated by a comma (,) denotes and/or options {Bracket Text} is for administrative purposes. Punctuation, text size, text font, text color, capital letters, lower case letters, italics, bold and underline may vary on final printed labels. Spelling may vary when alternate spelling is acceptable; for example "algaecide" or "algicide"

**CHANGE THIS CARTRIDGE EVERY [SIX, FOUR] MONTHS**

Use of this cartridge [for] longer than [four, six] continuous months will void the warranty. Discard [the, this] cartridge at the end of [six, four] months.

**PRECAUTIONARY STATEMENT**

**Hazards to Humans and Domestic Animals**

**Caution**

In the unlikely event that a cartridge breaks, mineral media should not be ingested by humans or animals as it may cause gastric distress.

**FIRST AID**

IF INGESTED: Call poison control center or doctor immediately for treatment advice.

**DISPOSAL**

After[six, four months] [one season] of use, discard [the cartridge, Nature<sup>2</sup>, {product name}] in household trash. Do not save [the cartridge, Nature<sup>2</sup>, {product name}] for re-use. [The cartridge, Nature<sup>2</sup>, {product name}] is manufactured with the mineral media sealed inside. In the unlikely event [it, the cartridge, Nature<sup>2</sup>, {product name}] breaks, remove [it, the cartridge] and vacuum out any media introduced into the pool [water].

**DIRECTIONS FOR USE**

It is a violation of Federal Law to use this product in a manner inconsistent with its labeling.

See owner's manual inside box for directions for use.

Zodiac Pool Systems, Inc.  
2620 Commerce Way  
Vista, CA 92081-8488  
800.822.7933  
www.nature2.com

© 2010 Zodiac Pool Systems, Inc.

{insert part number}

**ACCEPTED  
with COMMENTS  
EPA Letter Dated:**

JUN 28 2011

Under the Federal Insecticide,  
Fungicide, and Rodenticide Act as  
amended, to the Pesticide,  
registered under EPA Reg. No. 67712-1

{Optional language pictures/diagrams that may appear on any panel of the carton label in any combination}

### Efficacy Claims

[4, 6 month] algae [control, treatment, preventative].

[4, 6] month Nature<sup>2</sup> cartridge meets [the] EPA [pool] efficacy requirements.

Algae control for [4, 6] months [for the life of the cartridge]

Algae treatment system

[Around, Round, 24/7] the clock algae [fighter, fighting]

[Around, Round, 24/7] the clock [disinfection, disinfecting, sanitation, sanitization]

[Around, Round] the clock algae [treatment, control, preventative] [for your swimming pool]

[Constant, Consistent, Continual, 24/7] algae [control, treatment] [for your swimming pool]

[Disinfects, Sanitizes, Works] [around, round, 24/7] [the clock]

Defend against algae [with] [the] [Nature<sup>2</sup>] [system\*]

Destroys bacteria and algae growth with CRT

[Hassle, Trouble] free algae control

[Effectively] [Fights, combats, defends against, inhibits, suppresses, resists, controls] algae [for [4, 6] months]

Keeps algae in check [for [4, 6] months]

In combination with lower chlorine levels, [Nature<sup>2</sup> technology<sup>†</sup>, {insert product name}] is proven to [effectively] control[s] [typical, common] swimming pool algae

Keep algae [at bay, under control] [for [4, 6] months]

Kills [common, typical] [swimming] pool bacteria [quickly, in a hurry]

[Insert product name] meets [the] EPA's [pool] efficacy requirements [for a period of [four, six] months].

[Nature<sup>2</sup> technology<sup>†</sup>, {product name}] and chlorine work together to effectively [inhibit, reduce, suppress, fight, control] bacteria and algae

[Nature<sup>2</sup> technology<sup>†</sup>, {product name}] effectively [reduces, inhibits, suppresses, controls] bacteria and algae

[Nature<sup>2</sup> technology<sup>†</sup>, {product name}] [Fights, combats, defends against, inhibits, suppresses, resists] algae growth

[Nature<sup>2</sup>, {product name}] minerals help rid the water of harmful bacteria

[Nature<sup>2</sup>, {product name}] [patented] mineral[s] [technology] destroy bacteria with a controlled release formula that lasts [4, 6] months

["Product name" features] Nature<sup>2</sup> technology<sup>†</sup> [which] is an effective process that sanitizes pool water using minerals and just 0.5ppm chlorine.

[Proven] control of [common] [swimming pool] bacteria [and] [algae]

Reduces [common] [swimming pool] bacteria [and] [algae]

Sanitize and inhibit [suppress, control] algae [the Nature<sup>2</sup> way!]

[Silver, Nature<sup>2</sup> technology<sup>†</sup>, {insert product name}] [with, and] [chlorine] kills bacteria

[Silver, Nature<sup>2</sup> technology<sup>†</sup>, {insert product name}] is an effective bactericide [and works well with oxidizing agents]

[Silver, Nature<sup>2</sup> technology<sup>†</sup>, {insert product name}] kills bacteria and lowers chlorine usage.

The Nature<sup>2</sup> System\* [with CRT] effectively sanitizes your pool.

**ACCEPTED**  
**with COMMENTS**  
**EPA Letter Dated:**

Under the Federal Insecticide,  
Fungicide and Rodenticide Act as  
amended for the pesticide,  
registered under EPA Reg. No. 677121

Note: Bracketed [ ] information is optional text/picture/diagram. Text separated by a comma (,) denotes and/or options {Bracket Text} is for administrative purposes. Punctuation, text size, text font, text color, capital letters, lower case letters, italics, bold and underline may vary on final printed labels. Spelling may vary when alternate spelling is acceptable; for example "algaecide" or "algicide"

*{Optional language pictures diagrams that may appear on any panel of the carton label in any combination}*

### **Ease of Use**

Algaecide [Algae] and bactericide [bacteria] [control] [all] in one [cartridge]

[Automatic], [Automatically] [dispensing of, dispenses] minerals [and chlorine] [automatically] *{the chlorine claim for use with models paired with chlorine dispensers/generators}*

Automatically dispenses minerals [and chlorine] *{the chlorine claim for use with models paired with Zodiac's salt water generator}*

Conveniently simple

Effortless algae [management, control]

Eliminate daily dosing

Engineered [for, to last] [4, 6] months [for your size] [in your] [pool]

Engineered to control bacteria and algae for [4, 6] months

Enjoy the water

Enjoy your pool [with less work]

Enjoy your pool again – eliminate the need for daily dosing

Install in seconds [– lasts [six, four] months]

Installation is simple

[It works [to control algae]] so you don't have to

[It] does the work for you

[It] works while you [sleep, play, swim]

Less time maintaining, more time relaxing!

[Maintenance, management] free algae control.

[Nature<sup>2</sup>, technology<sup>+</sup>, *{product name}*] minerals require no manual dosing

No more daily maintenance with [replacement] products that last weeks or months at a time

One [easy] step [to] algae [control, management] [in your swimming pool]

[Reclaim, regain] the fun. [Reduce the work.] [Increase your pool's life]

Save time

Simple, Do-It-Yourself Installation

Simple, [effective, efficacious], cost effective

Simply discard at the end of the season

Simply replace the cartridge every [six, four] months

Simply [replace, discard] the cartridge every [six, four] months

Spend less time shocking your pool

Spend more time in your pool, less time adding chlorine

Take back the fun of your pool by reducing the work and increasing the pool's life

Twice as nice – bacteria and algae control in one cartridge

### **Controlled Release Technology**

Controlled copper release prevents pool staining

Controls coppers release to prevent pool staining

**ACCEPTED  
with COMMENTS  
EPA Letter Dated:**

JUL 28 2010

Under the Federal Insecticide,  
Fungicide, and Rodenticide Act as  
amended, for the pesticide,  
registered under EPA Reg. No. 67712-1

Note: Bracketed [ ] information is optional text/picture/diagram. Text separated by a comma (,) denotes and/or options *{Bracket Text}* is for administrative purposes. Punctuation, text size, text font, text color, capital letters, lower case letters, italics, bold and underline may vary on final printed labels. Spelling may vary when alternate spelling is acceptable: for example "algaecide" or "algicide"

*{Optional language pictures diagrams that may appear on any panel of the carton label in any combination}*

Controlled release [of] algaecide

Controlled released algae treatment [technology]

Controlled Release Technology

Controlled Release Technology (CRT) controls the release of silver and copper mineral ions into your pool water.

Controlled release technology – no [copper, or, silver] stains, guaranteed!

[Manage, fight, combat, defend against, inhibit, suppress, resist, control] algae with controlled release technology [CRT]

[Nature<sup>2</sup>, technology<sup>†</sup>, {product name}] controls release to prevent staining

### **Innovative Technology**

21<sup>st</sup> century mineral technology

Combined mineral technology

Algae treatment with controlled release technology [CRT]

Alumina [mineral] matrix

[At, On] the leading edge of innovation [[and] technology]

Based on mineral technology {product name may be inserted at beginning}

Bromine compatible

[Complete] [Nature<sup>2</sup>] mineral pool care works in all pools

Contains minerals from nature

Contains [silver, copper] [alumina] [from nature] [!]

Copper [a component of] [Nature<sup>2</sup>, technology<sup>†</sup>, {product name}] effectively [inhibits, suppresses, controls, fights] algae [growth]

[Engineered, Patented] mineral[s] [silver] [copper] [alumina] [technology]

Features Nature<sup>2</sup> Technology<sup>†</sup>

In combination with 0.5ppm chlorine, Nature<sup>2</sup> technology<sup>†</sup> [{product name}] is as effective [against common swimming pool algae] as chlorine alone

Innovative pool [water] technology

It's Nature<sup>2</sup> Technology<sup>†</sup>

Let [Nature<sup>2</sup>, {product name}] minerals handle the [bulk, majority] of your water sanitation needs

[Manage, fight, combat, defend against, inhibit, suppress, resist, control] algae effortlessly

Mastering the elements

Mineral technology for the 21<sup>st</sup> century

Minerals + Innovation Unite

= Algae Control

= Increased Chlorine Effectiveness

= Enhanced Water Quality

[Mineral cartridge] Lasts [six, four] months

Minerals, such as silver and copper, have long been known for their sanitizing antimicrobial properties. Nature<sup>2</sup> brings the benefits of these elemental ingredients to create pool water that is noticeably cleaner, clearer, and softer.

Nature<sup>2</sup> copper [-alumina, mineral] granule [technology<sup>†</sup>]

Note: Bracketed [ ] information is optional text/picture/diagram. Text separated by a comma (,) denotes and/or options {Bracket Text} is for administrative purposes. Punctuation, text size, text font, text color, capital letters, lower case letters, italics, bold and underline may vary on final printed labels. Spelling may vary when alternate spelling is acceptable: for example "algaecide" or "algicide"

ACCEPTED  
with COMMENTS  
EPA Letter Dated:

4/11 28 2010  
Under the Federal Insecticide,  
Fungicide, and Rodenticide Act as  
amended, for the pesticide,  
registered under EPA Reg. No. 67712-1

{Optional language/pictures/diagrams that may appear on any panel of the carton label in any combination}

Nature<sup>2</sup> – it's elemental

Nature<sup>2</sup> [technology<sup>†</sup>, {product name}] controls release of active ingredients

Nature<sup>2</sup> meets the EPA requirements to lower previously approved chlorine levels by up to 50%\* (\*1.0ppm was EPA's previously approved level for a stabilized swimming pool).

[Nature<sup>2</sup>] [{product name}] [technology<sup>†</sup>, mineral formula] provides silver to destroy bacteria and alumina to help keep the pH in a safe range [without monitoring]

[Providing] innovative technology for over {insert appropriate number} years

Silver destroys bacteria to reduce chlorine use up to 50%\*

\*compared to the minimum EPA approved level of 1.0 for a stabilized swimming pool

[Silver, Nature<sup>2</sup>, {product name}] [minerals] plus 0.5ppm chlorine is as effective as 1.0ppm chlorine

Swim with mineral technology

Swim with [Nature<sup>2</sup>, mineral, {insert product name}] technology<sup>†</sup>

[Sustained, controlled] algaecide release technology

The copper in [Nature<sup>2</sup> technology<sup>†</sup>, {product name}] effectively controls algae

The Mineral Solution, Rediscovered

The Nature<sup>2</sup> System\* is an exclusive patented mineral technology.<sup>†</sup>

<sup>†</sup> Nature<sup>2</sup> technology consists of the minerals silver and copper.

[Zodiac –] [creators of, inventors of, pioneers in] pool mineral technology

[Zodiac –] leading the way in [innovation, innovative technology]

## Product Benefits

Lasts one season (up to [four, six] months)

[Lower chlorine levels] help[s] keep [the] pool pH balanced

Lower chlorine levels help prevent damage to equipment and surfaces

Requires only 0.5ppm chlorine to disinfect pool

Mineral sanitizer for fresh clean pool water.

Nature<sup>2</sup> is an effective pool sanitizing solution. In conjunction with your pool's filtration system, it delivers minerals to provide improved pool water quality. It allows you to use less chlorine, thereby reducing the potential for chlorine irritations and odors. With Nature<sup>2</sup>, your swim experience is clean, fresh, and gently soothing.

Nature<sup>2</sup> [technology<sup>†</sup>] in the presence of low levels of chlorine is proven to effectively control [typical, common] swimming pool algae.

[Nature<sup>2</sup> technology<sup>†</sup>, {product name}] is effective against swimming pool algae.

[Nature<sup>2</sup>, technology<sup>†</sup>] reduces chlorine consumption

[Nature<sup>2</sup>, technology<sup>†</sup>, {product name}] requires no sequestrant

[Nature<sup>2</sup>, {product name}] minerals [also] keeps your pH balanced by acting as a neutralizer

No sequestrant required

Reduces chlorine use to just 0.5ppm

Reduces chlorine use up to 50%

Reduce[s] [your] chlorine use

Note: Bracketed [ ] information is optional text/picture/diagram. Text separated by a comma (,) denotes and/or options {Bracket Text} is for administrative purposes. Punctuation, text size, text font, text color, capital letters, lower case letters, italics, bold and underline may vary on final printed labels. Spelling may vary when alternate spelling is acceptable: for example "algaecide" or "algicide"

ACCEPTED  
with COMMENTS  
EPA Letter Dated:

JUL 28 1981

Under the Federal Insecticide,  
Fungicide, and Rodenticide Act as  
amended for the pesticide,  
registered under EPA Reg. No. 67712-1

{Optional language pictures diagrams that may appear on any panel of the carton label in any combination}

[Reduces, Inhibits, Suppresses] [typical, common] swimming pool algae [in the presence of [0.5ppm chlorine, low chlorine levels]]

Saves you money

The mineral pool sanitizer

Won't stain.

### Swimmer Comfort

Enhance[d, s] swimmer comfort.

No unpleasant odors

[Nature<sup>2</sup> technology<sup>+</sup>, {product name}] [reduces, lowers] the formation of chloramines

[Nature<sup>2</sup>, {product name}] minerals reduces faded-swimsuits associated with chlorine

Reduces [faded swimsuits]

Reduces chlorine odors

Reduces premature damage to pool equipment or surfaces and unpleasant odors associated with chlorine

No unpleasant odors

Spend the day [in the pool] without worrying about faded swimsuits

[Nature<sup>2</sup>, system, {product name}] gives you a reliable way to have fresh, clean, clear water in your [family's] pool.

ACCEPTED  
with COMMENTS  
EPA Letter Dated:

JUL 28 2012

Under the Federal Insecticide, Fungicide, and Rodenticide Act as amended, for the pesticide, registered under EPA Reg. No. 67712-

### Water Attributes

Clarif[y, ies] pool water

Compare the Difference! {photo dependent on model}

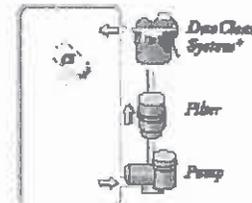
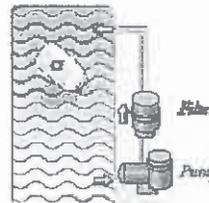
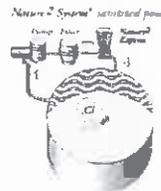
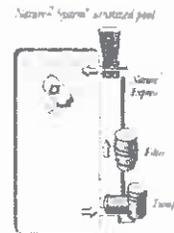
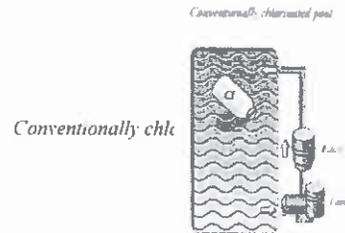
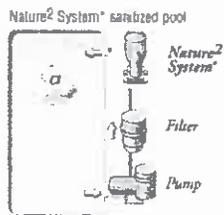
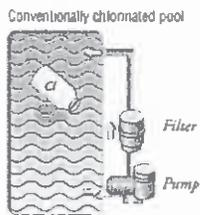

Note: Bracketed [ ] information is optional text/picture/diagram. Text separated by a comma (,) denotes and/or options {Bracket Text} is for administrative purposes. Punctuation, text size, text font, text color, capital letters, lower case letters, italics, bold and underline may vary on final printed labels. Spelling may vary when alternate spelling is acceptable: for example "algaecide" or "algicide"

{Optional language/pictures/diagrams that may appear on any panel of the carton label in any combination}

For Crystal Clear Water in All Types of Pools

[For] Water that [looks] [and] [feels] luxurious

Guaranteed – no stains!

Improves water quality by

Destroying bacteria for improved clarity

Helping to maintain a neutral pH for softer water

Makes water brilliantly clear [and] [soft]

[Nature<sup>2</sup>, {product name}] minerals condition the water for extra softness

[Nature<sup>2</sup>, {product name}] minerals make a difference you can see and feel

[Nature<sup>2</sup> technology<sup>†</sup>, {product name}] controls release to ensure algae control while preventing copper staining

[Nature<sup>2</sup> technology<sup>†</sup>, {product name}] provides [continuous] algae control [from day [1, one]]

[Nature<sup>2</sup> technology<sup>†</sup>, {product name}] [manages, fights, combats, defends against, inhibits, suppresses, resists, controls] [pool] copper levels [for stain-free algae control]

[Nature<sup>2</sup> technology<sup>†</sup>, {product name}] reduces coppers spikes from algaecide products to reduce staining

[Nature<sup>2</sup> technology<sup>†</sup>, {product name}] [regulates, controls] [the copper in] your swimming pool [copper levels] [providing you with] a no stain guarantee

[Nature<sup>2</sup> technology<sup>†</sup>, {product name}] releases copper for [immediate], hassle free algae control

Nature<sup>2</sup> water is brilliantly clear and soft



The Nature<sup>2</sup> System\* with CRT improves water quality.

Restore[s] water clarity

No stain guarantee

No stains, guaranteed

The perfect combination for clear pool water

Water feels softer with a crystal clear shine

ACCEPTED  
with COMMENTS  
EPA Letter Dated:  
JUL 2 1991  
Under the Federal Insecticide,  
Fungicide, and Rodenticide Act as  
amended, for the pesticide,  
registered under EPA Reg. No. 67712-1

Note: Bracketed [ ] information is optional text/picture/diagram. Text separated by a comma (,) denotes and/or options  
{Bracket Text} is for administrative purposes. Punctuation, text size, text font, text color, capital letters, lower case letters, italics,  
bold and underline may vary on final printed labels. Spelling may vary when alternate spelling is acceptable: for example  
"algaecide" or "algicide"

*{Optional language pictures diagrams that may appear on any panel of the carton label in any combination}*

**General Claims**

Assembled in USA from components made in USA, China and Australia

For inground [in-ground] and aboveground pools with cartridge filters up to 25,000 gallons

It's compatible. Compatible with most pool maintenance products.\*\*\*\*

\*\*\*\* Do not use [this product, Nature<sup>2</sup>] with copper-based algaecides, or Biguanides (Baquacil®, SoftSwim®, Revacil®). Baquacil is a registered trademark of *{insert company name}*., SoftSwim is a registered trademark of *{insert company name}*. Revacil is a registered trademark of *{insert company name}*.

Made in [the] USA *{A picture of the US flag may also appear}*

Replacement cartridge for [product name] + [product system]

Satisfaction guaranteed.

[Six, four] month guarantee.

The Nature<sup>2</sup> logo is a registered trademark owned by Zodiac Pool Care, Inc.

This product is covered by one or more of the following U.S. Patents: 4,608,247 4,935,116 5,352,369 372,069

To keep your patented Nature<sup>2</sup> Sanitizer operating properly, it is necessary to change [this, the] cartridge every [six, four] months.

Will not damage your pool equipment

ACCEPTED  
with COMMENTS  
\* EPA Letter Dated:

JUL

Under the Federal Insecticide,  
Fungicide, and Rodenticide Act as  
amended, for the pesticide,  
registered under EPA Reg. No. 67712-1

Note: Bracketed [ ] information is optional text/picture/diagram. Text separated by a comma (,) denotes and/or options *{Bracket Text}* is for administrative purposes. Punctuation, text size, text font, text color, capital letters, lower case letters, italics, bold and underline may vary on final printed labels. Spelling may vary when alternate spelling is acceptable: for example "algaecide" or "algicide"

{Optional language/pictures/diagrams may appear on any panel of the carton label in any combination}

\_\_\_\_\_ VC40

\_\_\_\_\_ VC20

**ACCEPTED**  
with **COMMENTS**  
EPA Letter Dated:

2005 28 2005

Under the Federal Insecticide,  
Fungicide and Rodenticide Act as  
amended to the pesticide,  
registered under EPA Reg. No.  
67712-1

- [Nature<sup>2</sup> G Cartridge For 35,000-45,000 Gallon Inground [In-ground] Pools]
- [Nature<sup>2</sup> G Cartridge For 25,000-35,000 Gallon Inground [In-ground] Pools]
- [Nature<sup>2</sup> G Cartridge For 10,000-25,000 Gallon Inground [In-ground] Pools]
- [Nature<sup>2</sup> M Cartridge For 5,000-25,000 Gallon Inground [In-ground] Pools]
- [Nature<sup>2</sup> VC Cartridge For inground [in-ground] pools from 5,000-20,000 gallons]
- [Nature<sup>2</sup> VC Cartridge For inground [in-ground] pools from 20,000-40,000 gallons]
- [Nature<sup>2</sup>] [G Cartridge] [M Cartridge] [and] [VC Cartridge] [CF] [Express] [Express Cartridge]

For [Aboveground] [and] [Inground] [In-ground] Pools [up to 25,000 Gallons]

{Part numbers may appear on the respective corresponding label. Part numbers may change without notification}

- [P/N] [W] [22325] [22330] [22335] [22340] [22345] [22350] [22355] [222360] [22380] [22385] [20055] [20065]
- [22375] [29550] [28125] [28126] [28135] [28136] [28145] [28146] [28155] [28175] [28185] [28195] [20171]
- [20080] [29500] [W20049] [W20050] [W20051] [W28000] [W28001] [W28002] [W28009]

{The following vessel /housing names may be used to help consumers determine the correct cartridge for their system}

Nature<sup>2</sup>

Fits all Nature<sup>2</sup> [Professional G], [Premium M], [R] [A] Vessels

[(Except Nature<sup>2</sup> Limited)]

[Nature<sup>2</sup>, Vision, Claritec, Clear Vision, EcoSpring, Aquatech, Visipure, White River, Fafco, California, Hawaiian ]

{optional cartridge/corresponding vessel checkbox}

Cartridge	Corresponding Vessel
<input type="checkbox"/> G25 10,000 - 25,000 Gallons	Professional G Inground [In-ground] Vessel
<input type="checkbox"/> G35 25,000 - 35,000 Gallons	Professional G Inground [In-ground] Vessel
<input type="checkbox"/> G45 35,000 - 45,000 Gallons	Professional G Inground [In-ground] Vessel
<input type="checkbox"/> M25 5,000 - 25,000 Gallons	Premium M Inground [In-ground] Vessel
<input type="checkbox"/> A30 5,000 - 30,000 Gallons	A Aboveground Vessel

{The term "cartridge" or "this product" on this master label may be replaced with the product name on the marketing label}

Note: Bracketed [ ] information is optional text/picture/diagram. Text separated by a comma (,) denotes and/or options  
{Bracket Text} is for administrative purposes. Punctuation, text size, text font, text color, capital letters, lower case letters, italics,  
bold and underline may vary on final printed labels. Spelling may vary when alternate spelling is acceptable: for example  
"algaecide" or "algicide"

{Optional language/pictures/diagrams may appear on any panel of the carton label in any combination}

This carton contains

DuoClear Cartridge	Corresponding System
<input type="checkbox"/> DuoClear 25 10,000 - 25,000 Gallons	DuoClear 25
<input type="checkbox"/> DuoClear 35 25,000 - 35,000 Gallons	DuoClear 35
<input type="checkbox"/> DuoClear 45 35,000 - 45,000 Gallons	DuoClear 45

Designed to fit DuoClear Systems for residential pools

Zodiac DuoClear Cartridge

For [10,000-25,000] [25,000-35,000] [35,000-45,000] Gallon Inground [In-ground] Pools

Fits DuoClear [25] [35] [45] System

Use only on Zodiac DuoClear systems for inground pools

Cartridge Model: DuoClear [25] [35] [45]

For [10,000 to 25,000] [25,000 to 35,000] [35,000 to 45,000] gallon pools

P/N [W20049] [20050] 20051]

Serial No. {insert number}

Replacement Cartridge for Zodiac DuoClear

For Inground [In-ground] Pools

Use only on Zodiac DuoClear Systems

Nature <sup>2</sup> Fusion Cartridge	Corresponding System
<input type="checkbox"/> Nature <sup>2</sup> Fusion 25 10,000 - 25,000 Gallons	Nature <sup>2</sup> Fusion Inground Nature <sup>2</sup> Fusion Soft 25 DuoClear 25
<input type="checkbox"/> Nature <sup>2</sup> Fusion 35 25,000 - 35,000 Gallons	Nature <sup>2</sup> Fusion Inground DuoClear 35
<input type="checkbox"/> Nature <sup>2</sup> Fusion 45 35,000 - 45,000 Gallons	Nature <sup>2</sup> Fusion Inground Nature <sup>2</sup> Fusion Soft 45 DuoClear 45

**CAUTION:** Use only as directed – This cartridge must not be used in any other model or make of sanitizer. See installation and start-up instructions. Keep out of reach of children.

If assistance is required, please call: 1-800-822-7933

ACCEPTED  
with COMMENTS  
EPA Letter Dated:

JUL 28 2010

Under the Federal Insecticide,  
Fungicide, and Rodenticide Act as  
amended, for the pesticide,  
registered under EPA Reg. No. 67712-1

Note: Bracketed [ ] information is optional text/picture/diagram. Text separated by a comma (,) denotes and/or options {Bracket Text} is for administrative purposes. Punctuation, text size, text font, text color, capital letters, lower case letters, italics, bold and underline may vary on final printed labels. Spelling may vary when alternate spelling is acceptable; for example "algacide" or "algicide"

{Optional language pictures diagrams may appear on any panel of the carton label in any combination}

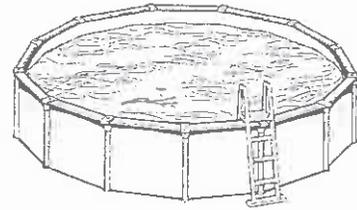

**The Mineral Cartridge**  
The Low Chlorine Alternative



**ACCEPTED  
with COMMENTS  
EPA Letter Dated:**

JUL 28 2010

**Under the Federal Insecticide,  
Fungicide, and Rodenticide Act as  
amended, for the pesticide,  
registered under EPA Reg. No. 67712-1**



Note: Bracketed [ ] information is optional text/picture/diagram. Text separated by a comma (,) denotes and/or options {Bracket Text} is for administrative purposes. Punctuation, text size, text font, text color, capital letters, lower case letters, italics, bold and underline may vary on final printed labels. Spelling may vary when alternate spelling is acceptable: for example "algaecide" or "algicide"

{Optional language/pictures/diagrams may appear on any panel of the carton label in any combination}

# The Mineral Pool Sanitizer

The Low Chlorine Alternative\*



# Nature<sup>2</sup> Mineral Cartridge

The Low Chlorine Alternative\*



ACCEPTED  
with COMMENTS  
EPA Letter Dated:

Under the Federal Insecticide,  
Fungicide, and Rodenticide Act as  
amended, for the pesticide,  
registered under EPA Reg. No. 67712-1

Note: Bracketed [ ] information is optional text/picture/diagram. Text separated by a comma (,) denotes and/or options  
{Bracket Text} is for administrative purposes. Punctuation, text size, text font, text color, capital letters, lower case letters, italics,  
bold and underline may vary on final printed labels. Spelling may vary when alternate spelling is acceptable; for example  
"algacide" or "algicide"

*{Optional language/pictures/diagrams may appear on any panel of the carton label in any combination}*



RECEIVED  
EPA COMPLIANCE  
DIVISION  
JUL 28 2000  
Under the Federal Insecticide,  
Fungicide, and Rodenticide Act as  
amended, and the pesticides,  
regulared under EPA Reg. No. 677/2-1

Note: Bracketed [ ] information is optional text/picture/diagram. Text separated by a comma (,) denotes and/or options  
{Bracket Text} is for administrative purposes. Punctuation, text size, text font, text color, capital letters, lower case letters, italics,  
bold and underline may vary on final printed labels. Spelling may vary when alternate spelling is acceptable: for example  
"algacide" or "algicide"

{Optional language pictures diagrams may appear on any panel of the carton label in any combination}



{Graphics below added by amendment on 03/XX/2010}



**ACCEPTED  
with COMMENTS  
EPA Letter Dated:**  
JUL 28 2010  
**Under the Federal Insecticide,  
Fungicide, and Rodenticide Act as  
amended, for the pesticide,  
registered under EPA Reg. No. 67712-1**

Note: Bracketed [ ] information is optional text/picture/diagram. Text separated by a comma (,) denotes and/or options {Bracket Text} is for administrative purposes. Punctuation, text size, text font, text color, capital letters, lower case letters, italics, bold and underline may vary on final printed labels. Spelling may vary when alternate spelling is acceptable: for example "algaecide" or "algicide"

*{Optional language/pictures/diagrams may appear on any panel of the carton label in any combination}*

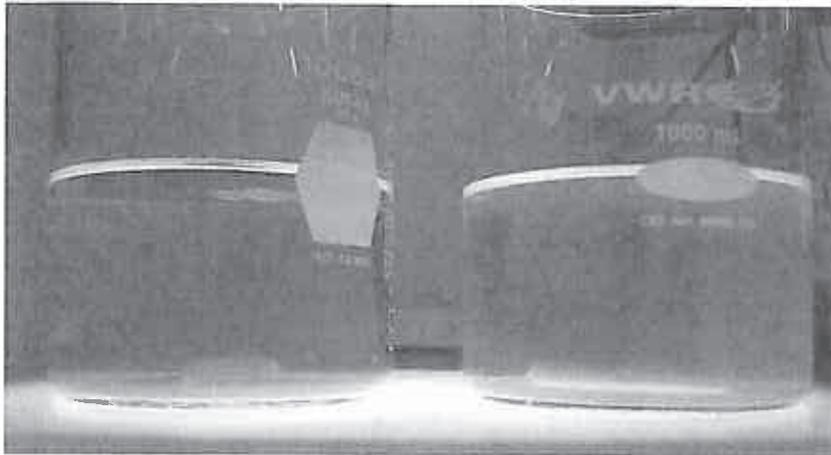

**ACCEPTED  
with COMMENTS  
EPA Letter Dated:**

**JUL 28 2010**

**Under the Federal Insecticide,  
Fungicide and Rodenticide Act as  
amended for the pesticide,  
registered under EPA Reg. No. 6772**

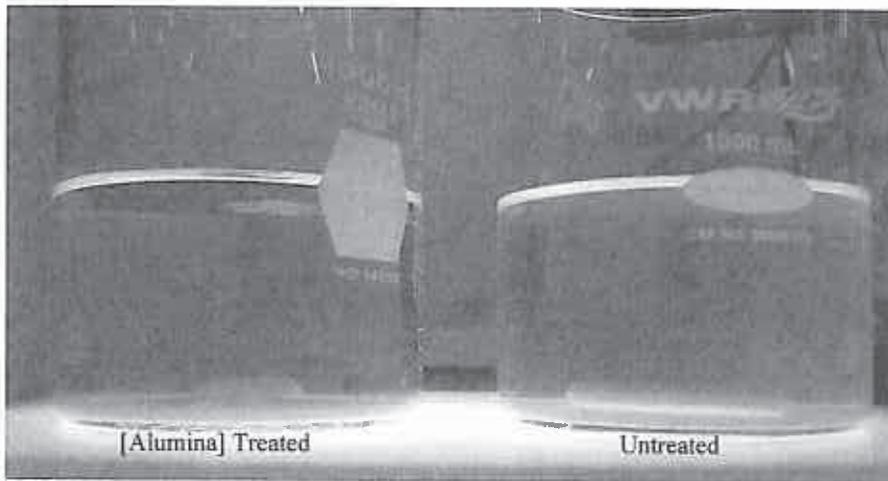

**[Clarified] with Alumina**

**Without Alumina**

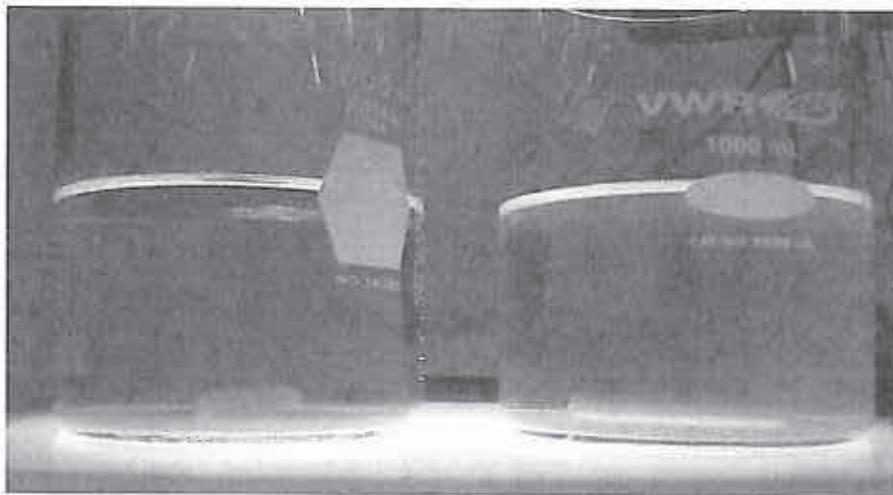

Note: Bracketed [ ] information is optional text/picture/diagram. Text separated by a comma (,) denotes and/or options {Bracket Text} is for administrative purposes. Punctuation, text size, text font, text color, capital letters, lower case letters, italics, bold and underline may vary on final printed labels. Spelling may vary when alternate spelling is acceptable; for example "algacide" or "algicide"

{Optional language/pictures/diagrams may appear on any panel of the carton label in any combination}

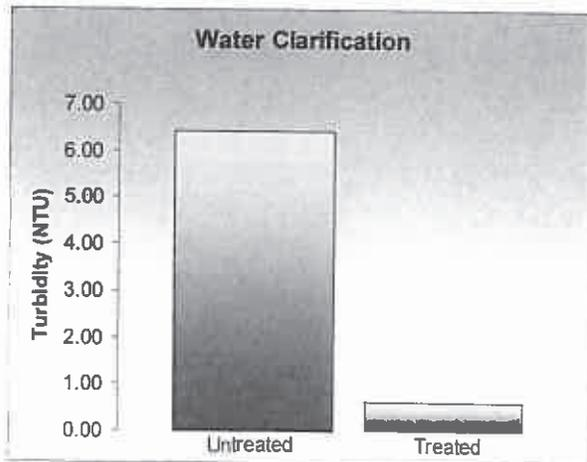
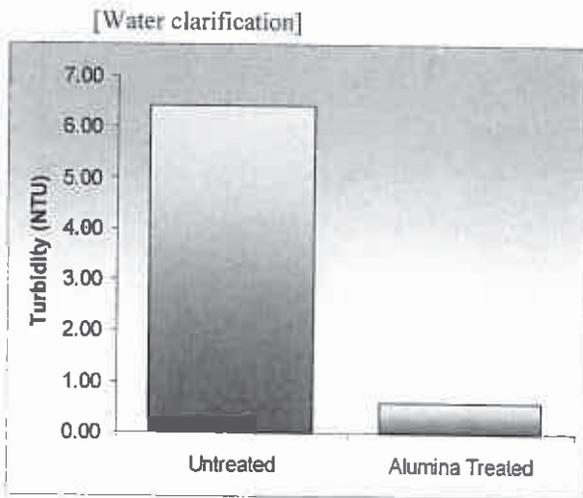
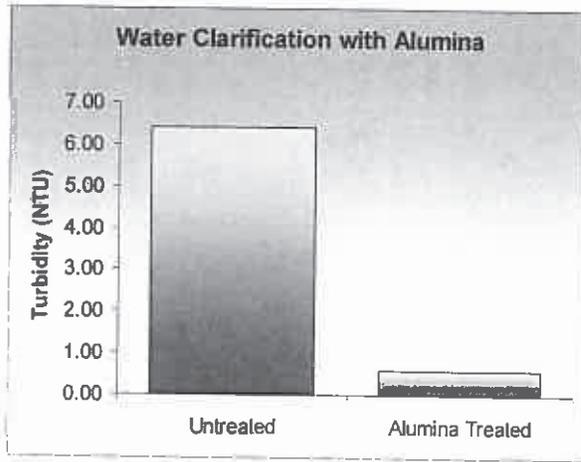

ACCEPTED  
with COMMENTS  
EPA Letter Dated:

JUL 28 2010

Under the Federal Insecticide,  
Fungicide, and Rodenticide Act as  
amended, for the pesticide,  
registered under EPA Reg. No. 67712-1

Note: Bracketed [ ] information is optional text/picture/diagram. Text separated by a comma (,) denotes and/or options  
{Bracket Text} is for administrative purposes. Punctuation, text size, text font, text color, capital letters, lower case letters, italics,  
bold and underline may vary on final printed labels. Spelling may vary when alternate spelling is acceptable: for example  
"algacide" or "algicide"

{Optional language pictures diagrams may appear on any panel of the carton label in any combination}

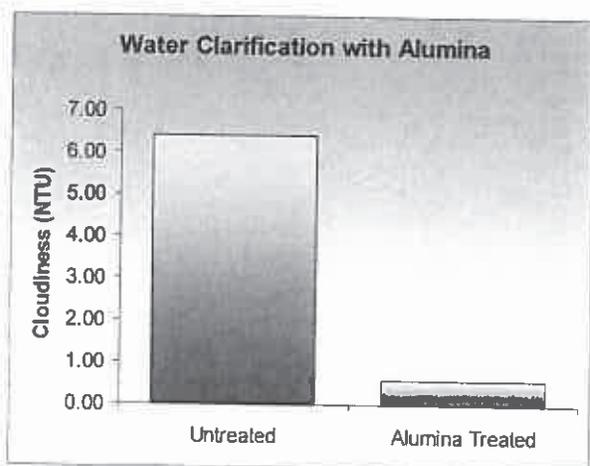
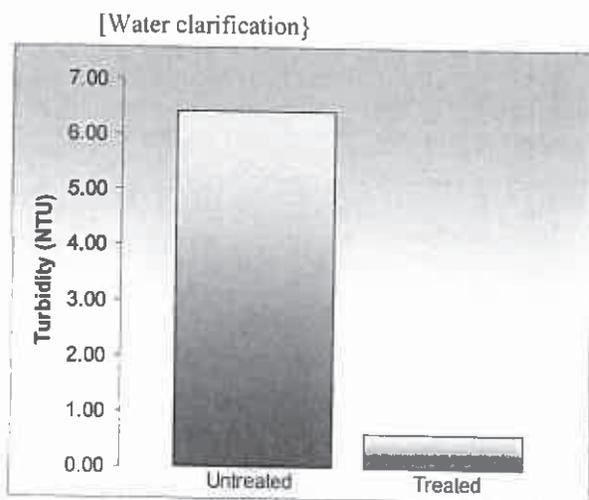

ACCEPTED  
with COMMENTS  
EPA Letter Dated:

JUL 23 2010

Under the Federal Insecticide,  
Fungicide, and Rodenticide Act as  
amended, for the pesticide,  
registered under EPA Reg. No. 67712-1

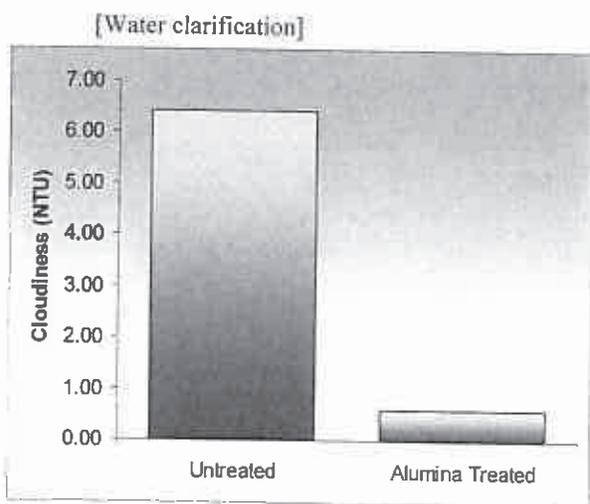

Note: Bracketed [ ] information is optional text/picture/diagram. Text separated by a comma (,) denotes and/or options {Bracket Text} is for administrative purposes. Punctuation, text size, text font, text color, capital letters, lower case letters, italics, bold and underline may vary on final printed labels. Spelling may vary when alternate spelling is acceptable: for example "algaecide" or "algicide"

{Optional language pictures/diagrams may appear on any panel of the carton label in any combination}

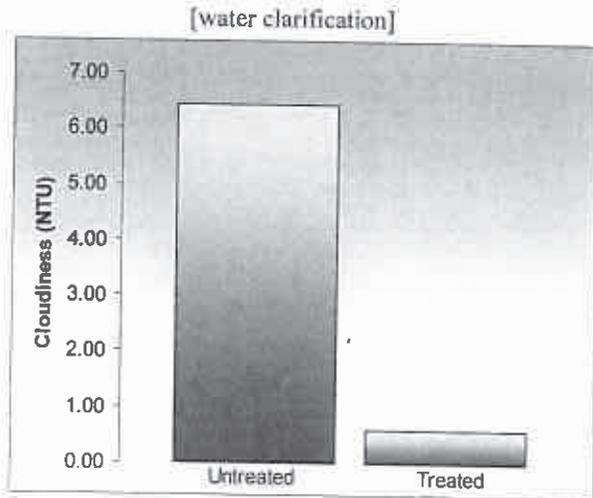
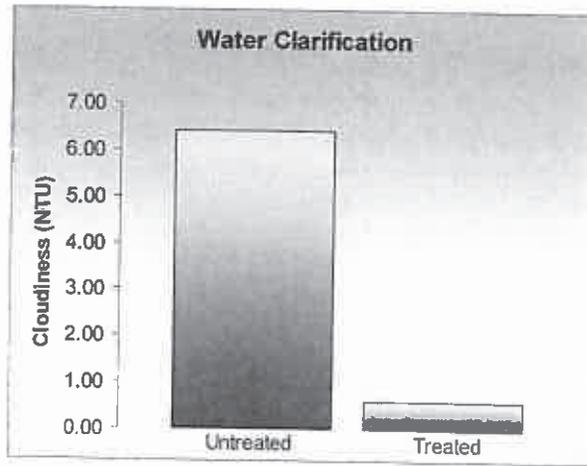

ACCEPTED  
with COMMENTS  
& EPA Letter Dated:

MAY 28 2010

Under the Federal Insecticide,  
Fungicide, and Rodenticide Act as  
amended for the pesticide,  
registered under EPA Reg. No. 67712-1

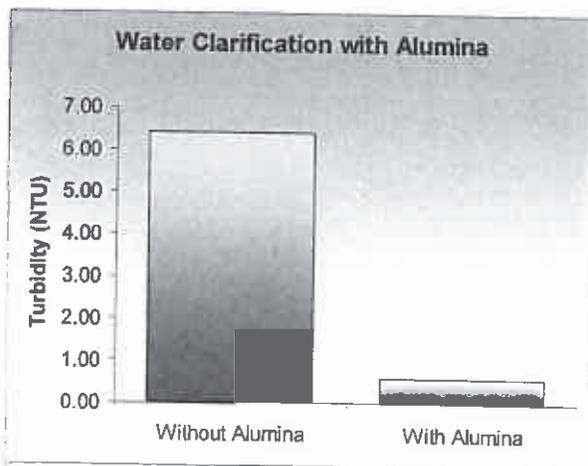

Note: Bracketed [ ] information is optional text/picture/diagram. Text separated by a comma (,) denotes and/or options {Bracket Text} is for administrative purposes. Punctuation, text size, text font, text color, capital letters, lower case letters, italics, bold and underline may vary on final printed labels. Spelling may vary when alternate spelling is acceptable: for example "algacide" or "algicide"

{Optional language pictures diagrams may appear on any panel of the carton label in any combination}

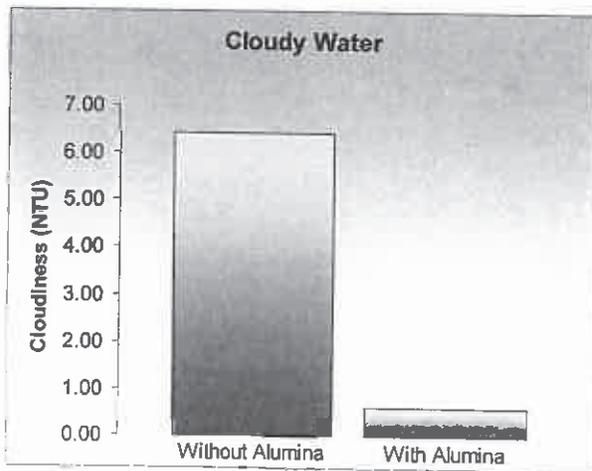
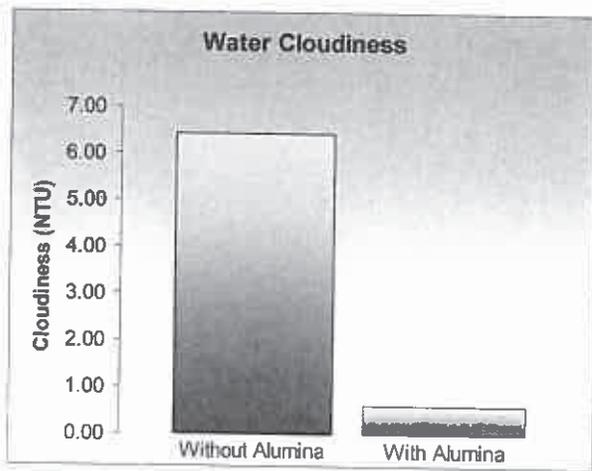
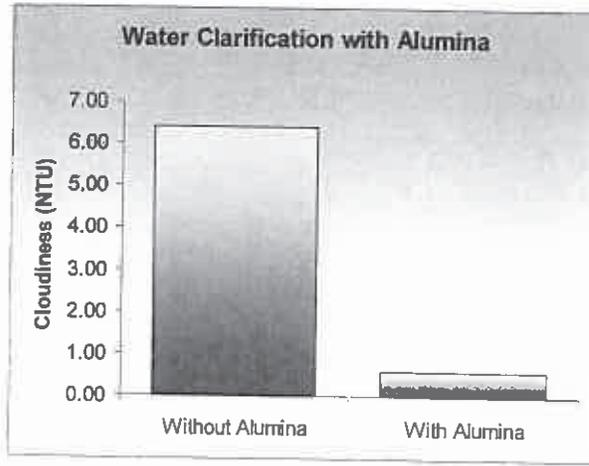

**ACCEPTED**  
**with COMMENTS**  
**& EPA Letter Dated:**

JUL 28 2010

Under the Federal Insecticide,  
Fungicide and Rodenticide Act as  
amended for the pesticide,  
registered under EPA Reg. No. 67712-1

Note: Bracketed [ ] information is optional text/picture/diagram. Text separated by a comma (,) denotes and/or options {Bracket Text} is for administrative purposes. Punctuation, text size, text font, text color, capital letters, lower case letters, italics, bold and underline may vary on final printed labels. Spelling may vary when alternate spelling is acceptable: for example "algacide" or "algicide"

{Optional language/pictures/diagrams may appear on any panel of the carton label in any combination}

{silver graphs}

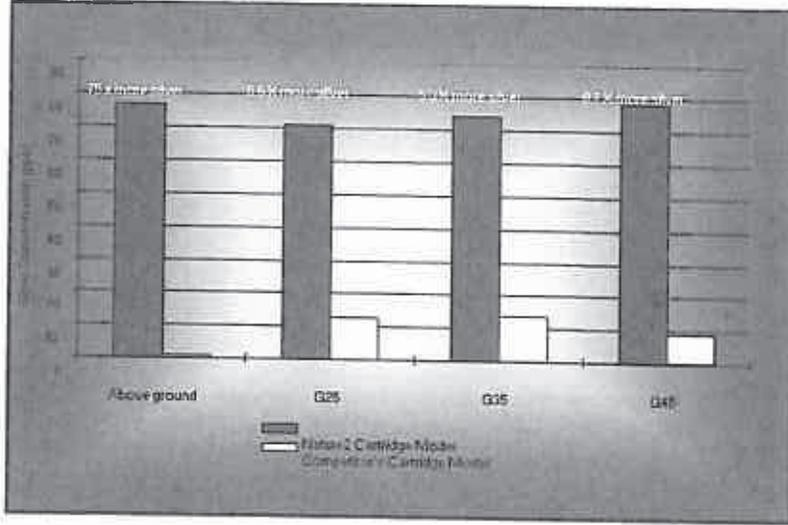

ACCEPTED  
with COMMENTS  
EPA Letter Dated:

{silver graphs}

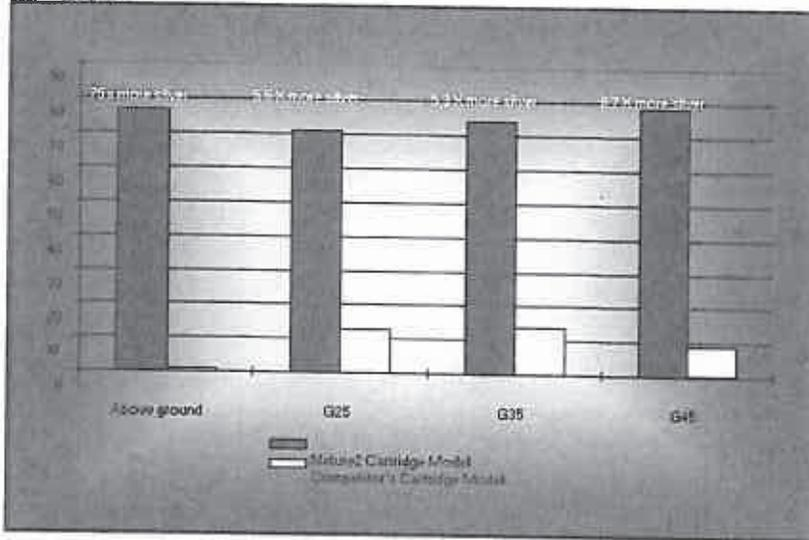

JUL 28 2010

Under the Federal Insecticide,  
Fungicide, and Rodenticide Act as  
amended, for the pesticide,  
registered under EPA Reg. No. 67712-1



{copper image, may be used with various claims}

Note: Bracketed [ ] information is optional text/picture/diagram. Text separated by a comma (,) denotes and/or options {Bracket Text} is for administrative purposes. Punctuation, text size, text font, text color, capital letters, lower case letters, italics, bold and underline may vary on final printed labels. Spelling may vary when alternate spelling is acceptable: for example "algaeicide" or "algicide"

{Optional language pictures diagrams for Express model may appear on any panel of the carton label in any combination}

Easy do-it-yourself in-line installation, in minutes [(fits 1 1/2" and 2" rigid PVC pipe)] [includes adapter that fits most aboveground pools]

Just twist onto your existing Nature<sup>2</sup> Express Assembly  
[REPLACEMENT CARTRIDGE FOR NATURE<sup>2</sup> EXPRESS] FOR [ABOVEGROUND] [AND] [INGROUND] [IN-GROUND] POOLS

Installation is simple. Simple, Do-It-Yourself Installation

In just minutes you can install Nature<sup>2</sup> Express, activate the cartridge, and start enjoying a crystal clear [Nature<sup>2</sup>] pool. Nature<sup>2</sup> Express fits most [aboveground [inground] pools up to 25,000 gallons] [with 1 1/2" or 2" rigid PVC plumbing].

[Nature<sup>2</sup> Express, This Unit] contains no moving parts [and is unaffected by heavy use, hot weather and water temperature] [and only requires replacing the cartridge every [six, four] months]. [You only have to change the replaceable cartridge every [six, four] months!] Please refer to the operating manual for complete installation instructions.

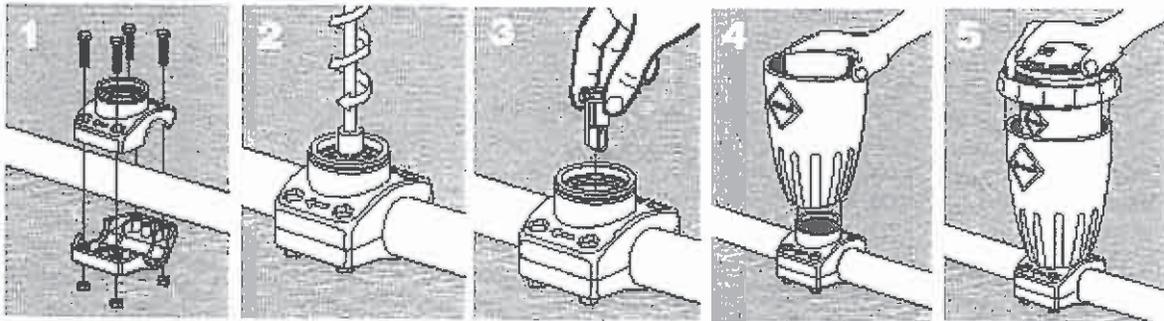

Turn pool pump off. Secure clamp assembly on the return line. [For aboveground pools with corrugated pipe, use PVC [enclosed] adapter [provided].]

Cut hole in rigid PVC pipe using a power drill and the [enclosed] hole saw [that is provided].

Insert the flow diverter into hole and snap it into place.

Snap dispenser shell onto clamp.

Thread the cartridge into the clamp, turn on pool pump and activate the cartridge. [See] [Refer to your cartridge owner's] manual for start up instructions.

#### PRODUCT SPECIFICATIONS

Capacity	For 5,000 to 25,000 gallon pools
Cartridge Life	6 months
Run Time	6 hours a day minimum

#### Installation Process:

Please refer to the Nature<sup>2</sup> Express Operating Manual for installation instructions.

Refer to the Nature<sup>2</sup> Express Owner's manual for start-up instructions.

Installation of a Nature<sup>2</sup> Express replacement cartridge takes just minutes. First turn off the pool pump. Then simply remove the existing cartridge from your Nature<sup>2</sup> Express Sanitizer and replace it with your new cartridge.

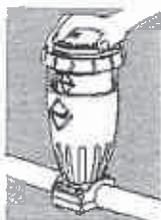

ACCEPTED  
with COMMENTS  
EPA Letter Dated:

JUL 28 2010

Under the Federal Insecticide,  
Fungicide, and Rodenticide Act as  
amended, for the pesticide,  
registered under EPA Reg. No. 67712-1

Note: Bracketed [ ] information is optional text/picture/diagram. Text separated by a comma (,) denotes and/or options {Bracket Text} is for administrative purposes. Punctuation, text size, text font, text color, capital letters, lower case letters, italics, bold and underline may vary on final printed labels. Spelling may vary when alternate spelling is acceptable: for example "algaeicide" or "algicide"

Optional language/pictures/diagrams for CF model may appear on any panel of the carton label in any combination!

FOR INGROUND [IN-GROUND] AND ABOVEGROUND POOLS WITH CARTRIDGE FILTERS

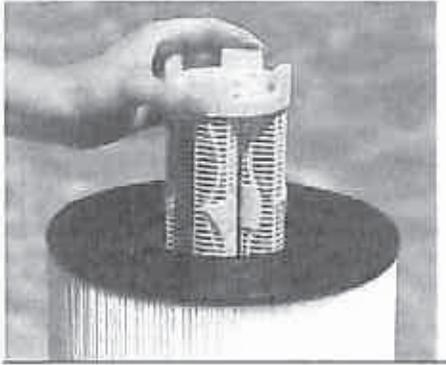

**ACCEPTED**  
**with COMMENTS**  
EPA Letter Dated:

JUL 28 2010

Under the Federal Insecticide,  
Fungicide, and Rodenticide Act as  
amended, for the pesticide,  
registered under EPA Reg. No. 67712-1

Note: Bracketed [ ] information is optional text/picture/diagram. Text separated by a comma (,) denotes and/or options {Bracket Text} is for administrative purposes. Punctuation, text size, text font, text color, capital letters, lower case letters, italics, bold and underline may vary on final printed labels. Spelling may vary when alternate spelling is acceptable: for example "algaecide" or "algicide"



ACCEPTED  
with COMMENTS  
EPA Letter Dated:

JUL 28 2004  
Nature<sup>2</sup> Mineral Sanitizer  
for Pools

Under the Federal Insecticide,  
Fungicide, and Rodenticide Act as  
amended, for the pesticide,  
registered under EPA Reg. No. 67712-1

# Nature<sup>2</sup> [G45-VC40] [Cartridge] Owner's Manual

[Replacement Cartridge for the DuoClear System] [Fusion]  
[For Nature<sup>2</sup> G Cartridges, Nature<sup>2</sup> M Cartridges, and Nature<sup>2</sup> VC Cartridge]  
[For Inground and Aboveground Pools [with Cartridge Filters]]  
[Features Nature<sup>2</sup> Technology<sup>†</sup>  
{insert product name} with Nature<sup>2</sup> Technology<sup>†</sup>

EPA Reg. No. 67712-1  
EPA Est. No. 67712-FL-001  
67712-CA-001

## IMPORTANT

**Pool Owner, save this manual! Builders, leave this manual with the pool owner!**

**We ask you to take the time to get familiar with this manual.**

Thank you for purchasing {insert product name} [with] Nature<sup>2</sup> [technology<sup>†</sup>]. We believe the more you know, the more enjoyable your family's swimming experience will be - and the more you will reduce the time, effort and cost of maintaining your pool. Pool owners who switch from conventional chemical programs to the Nature<sup>2</sup> System\* spend less time maintaining their pools. Every pool has its own characteristics of water type, amount of sunlight, etc. The recipe [included in this manual] will help insure good water quality for your pool. Remember, your authorized [Zodiac, Nature<sup>2</sup>] dealer can provide professional advice and service.

## SAFETY INSTRUCTIONS – Important information. Please read prior to installation

*[see attached page for optional information that may be placed here]*

**ATTENTION** Failure to heed the following can result in permanent injury, [electrocution] or drowning

### [ELECTRICAL HAZARD]

[Severe shock will likely occur as a result of a drill or drill cord coming in contact with water. Never allow electric drill or drill cord to come in contact with water. Only plug drill into a Class A (5 Milliampere Trip) protected Ground Fault Circuit Interrupter (GFCI) in accordance with the National Electrical Code Section 680. Please see your drill owner's manual for further safety precautions.]

### EQUIPMENT UNDER PRESSURE

Always turn pump off prior to installing or changing Nature<sup>2</sup> cartridge. Your pump/filter system is operated under pressure and the pressure must be released before you begin work. Please see your pump/filter owner's manual for further instructions.

### PREVENT CHILD DROWNING

Do not let anyone, especially small children, sit, step, lean or climb on any equipment installed as part of your pool's operational system. Locate the components of your operational system at least 3 feet from the pool so children cannot use the equipment to access the pool and be injured or drown.

### LOW CHLORINE RECIPE

You must strictly follow the low chlorine recipe included in this manual to maintain proper water chemistry and avoid health hazards. Failure to follow these instructions can lead to sickness from bacteria and other noxious organisms.

## CAUTION

### Precautionary Statement

### Hazards to Humans and Domestic Animals

#### CAUTION

In the unlikely event that a cartridge breaks, mineral media should not be ingested by humans or animals as it may cause gastric distress

#### First Aid

IF INGESTED: Call poison control center or doctor immediately for treatment advice.



The Nature<sup>2</sup> [Pool] Sanitizer is designed only for residential swimming pools.

\* The Nature<sup>2</sup> System consists of the patented Nature<sup>2</sup> technology<sup>†</sup> used in conjunction with a chlorine delivery device or 0.5ppm of an EPA registered chlorine pool product.

Note: Bracketed [ ] information is optional text/picture/diagram. Text separated by a comma (,) denotes and/or options. *[Bracket Text]* is for administrative purposes. Punctuation, text size, text font, text color, capital letters, lower case letters, italics, bold and underline may vary on final printed labels. Spelling may vary when alternate spelling is acceptable: for example "algacide" or "algicide"

\* Nature<sup>2</sup>™ technology† consists of the minerals silver and copper.  
Nature<sup>2</sup> is a registered trademark of Zodiac Pool Care, Inc.

[Optional Table of Contents]

Contents	Page	{the correct page numbers will be inserted for each manual}
Safety Instructions	1	
Start Up	2	
[Assembly]	3	
Balance the Water	3	
Install the Cartridge	3	
Recipe	4	
Provide Filtration/Circulation	4	
Troubleshooting	5	
Nature <sup>2</sup> Cartridge Replacement Intervals	6	
Winterizing Your Pool	6	
Disposal	6	
Limited Warranty	7	

**Directions for Use:**

It is a violation of Federal law to use this product in a manner inconsistent with its labeling.

**Nature<sup>2</sup> Compatibility**

Nature<sup>2</sup> Systems\* can be used with all types of pool chemical treatments available except [bromine and bromide based chemicals,] biguanide products (Baquacil<sup>1</sup>, Softswim<sup>2</sup> or Revacil<sup>3</sup>) and copper based algacides. (<sup>1</sup>A Trademark of {insert company name}, <sup>2</sup>A Trademark of {insert company name} <sup>3</sup>A Trademark of {insert company name}.)

**Important:** When converting [either] a biguanide [or bromine] treated pool to the Nature<sup>2</sup> System\*, the pool must be completely drained and refilled. Then follow the Nature<sup>2</sup> cartridge start-up procedure below.

**Important:** Please make sure that the Nature<sup>2</sup> cartridge you have selected corresponds to your swimming pool size based on gallons of water. Using a Nature<sup>2</sup> cartridge for an undersized pool may cause staining of the pool.]

## Start Up

Before starting up a new [Nature<sup>2</sup>] cartridge, clean debris and algae out of the pool and [pool] equipment.

**Important:** Do not install the new cartridge until the pool water is clean and chemically balanced.

**Balance pool water** before installing [Nature<sup>2</sup>] [sanitizer, cartridge].

pH	7.4-7.8
Calcium Hardness	200-400 ppm
Total Alkalinity	80-150 ppm

Consult with your [Nature<sup>2</sup>, Zodiac] dealer for specific water balance instructions.

ACCEPTED  
with COMMENTS  
EPA Letter Dated:

JUL 28 2010

Under the Federal Insecticide,  
Fungicide, and Rodenticide Act as  
amended, for the pesticide,  
registered under EPA Reg. No. 67712-1

Note: Bracketed [ ] information is optional text/picture/diagram. Text separated by a comma (,) denotes and/or options  
{Bracket Text} is for administrative purposes. Punctuation, text size, text font, text color, capital letters, lower case letters, italics,  
bold and underline may vary on final printed labels. Spelling may vary when alternate spelling is acceptable; for example  
"algacide" or "algicide"

## Balance the Water

To find out if your pool water is balanced:

- take a water sample to your dealer to be tested regularly, or
- ask your dealer to recommend a pool test kit for water balance.

<b>Element: pH</b> <b>Range: 7.4-7.8</b>	<b>If it's too low:</b>	The surface of your pool can become etched Metal parts in the pump and plumbing will corrode.	<b>How to fix:</b> Add pH increaser
	<b>If it's too high:</b>	"Scale" forms on the surface of your pool. The water can become cloudy. Equipment can become damaged.	<b>How to fix:</b> Add pH decreaser
<b>Element: Calcium Hardness</b> <b>Range: 200-400 ppm</b>	<b>If it's too low:</b>	Water is less stable. In plaster pools, the calcium is taken out of the plaster, causing the surface to deteriorate.	<b>How to fix:</b> Add calcium hardness increaser.
	<b>If it's too high:</b>	Rough, discolored deposits ("scale") will form on the pool surface and inside pool equipment.	<b>How to fix:</b> Drain or dilute the pool water. <b>Consult your dealer.</b>
<b>Element: Total Alkalinity</b> <b>Range: 80-150 ppm</b>	<b>If it's too low:</b>	It provides no buffer so that you constantly get fluctuating pH readings, which can damage equipment and pool surfaces.	<b>How to fix:</b> Use an alkalinity increaser.
	<b>If it's too high:</b>	White deposits ("scale") form on the tile line. The plaster on pool surface becomes rough or discolored. The water becomes cloudy or milky white.	<b>How to fix:</b> Add acid to bring alkalinity down.

## Install the [Cartridge, Sanitizer]

1 Install the cartridge [into your pool filter] after water is balanced. [See, Refer to] [the, your] Nature<sup>2</sup> {the model/product name may also be inserted here} [vessel] operating manual for additional instructions [regarding your particular model's installation]. {the product name may be used in place of or in addition to the term "cartridge"}

2 [Superoxidize, Superchlorinate] the pool water with chlorine according to manufacturer's instructions to burn off contaminants and activate cartridge.

**Important:** Initial superoxidation with chlorine is required to burn off contaminants and activate cartridge.

3 Run the circulating pump either:

- 24 hours a day for 4 days, maintaining 1-2 ppm [free] chlorine throughout, or
- 6 hours a day for 14 days, maintaining 1-2 ppm [free] chlorine throughout.

4 Let chlorine dissipate to 0.5 ppm once start up period is completed.

Do not enter the pool if the free available chlorine residual is over 3 ppm.

ACCEPTED  
with COMMENTS  
EPA Letter Dated:

JUL 28 2010

Under the Federal Insecticide,  
Fungicide and Rodenticide Act as  
amended for the pesticide,  
registered under EPA Reg. No. 67712-

Note: Bracketed [ ] information is optional text/picture/diagram. Text separated by a comma (,) denotes and/or options {Bracket Text} is for administrative purposes. Punctuation, text size, text font, text color, capital letters, lower case letters, italics, bold and underline may vary on final printed labels. Spelling may vary when alternate spelling is acceptable: for example "algaeicide" or "algicide"

## Recipe

There is one recipe for maintaining clean, clear, sanitized water with minimum time and effort. This recipe provides the easiest and most economical way to care for your Nature<sup>2</sup> pool.

**Low-Chlorine Recipe** Once the 4-day or 14-day start-up period is done, allow the free [available] chlorine residual to drop to 0.5 ppm (by reducing the amount of chlorine you add) then:

Ingredients:

Nature<sup>2</sup> cartridge {product name may be inserted}

Chlorine granules, tablets, liquid or generator

pH and total alkalinity adjusting chemicals

Calcium hardness increaser, if needed

Water test kit

**When:**

**What to do:**

Every day

Run pump and filter at least 6 hours every day.

Once a week

Balance pH and total alkalinity.

Twice a week

Check chlorine residual; add chlorine to maintain at least [a] 0.5ppm [free chlorine] [range using the chart below].

As needed

If water is hazy, superoxidize with chlorine according to manufacturer's instructions. Additional shocking is recommended following rainstorms or heavy bather load. Do not re-enter the pool if the free available chlorine residual is over 3 ppm.

Add the following amounts of chlorine per 10,000 gallons of water to increase free chlorine by 0.5 ppm

Type of Chlorine Containing Compound	% Active Ingredient	% Available Chlorine Content	Ounce Quantity Required	Gram Quantity Required
Sodium Hypochlorite Liquid	5.25	5.25	12.7	361
Sodium Hypochlorite Liquid	9.2	9.2	7.3	206
Sodium Hypochlorite Liquid	10	10	6.5	184
Sodium Hypochlorite Liquid	12	12	5.6	158
Calcium Hypochlorite	65	64	1.1	30
Dichloroisocyanurate	99	62	1.1	30
Lithium Hypochlorite	29	35	1.9	54
Trichloro-s-triazintrione	99	90	0.7	21
Chlorine Gas, from any source including chlorine generators	100	100	0.7	19

## Provide Filtration/Circulation

**To manage:** You need to:

**Circulation** Follow the manufacturer's directions for keeping the circulating pump in good working order and operate it at least six hours a day. Consult your [Nature<sup>2</sup>, Zodiac] dealer for optimum run times.

**Filtration** Check the pool's filter periodically and clean it as recommended by the manufacturer.

ACCEPTED  
NO COMMENTS  
EPA Letter Dated:  
JUL 28 2010

U.S. Environmental Protection Agency, Federal Insecticide, Fungicide, and Rodenticide Act as amended, for the pesticide, registered under EPA Reg. No. 67712-1

Note: Bracketed [ ] information is optional text/picture/diagram. Text separated by a comma (,) denotes and/or options {Bracket Text} is for administrative purposes. Punctuation, text size, text font, text color, capital letters, lower case letters, italics, bold and underline may vary on final printed labels. Spelling may vary when alternate spelling is acceptable: for example "algacide" or "algicide"

# Troubleshooting Guide

[Consult your Nature 2 Zodiac Dealer for additional assistance or call 1-800-822-7933.]

	Problem	What to look for	Treatment
<b>Cloudy water</b> Frequently caused by improper start up. See section on Start Up [and Install the Cartridge.]	Poor filtration	Slow filter turnover rates	1 Backwash and clean filter. 2 Run filter for 24 hours. 3 Increase run time per day
	Algae growth	Hazy pool water, may have slightly green appearance.	[Superchlorinate, Superoxidize] water with chlorine according to manufacturer's instructions and brush pool walls.
	Unbalanced water	1 High hardness 2 High TDS (total dissolved solids) 3 High pH 4 High total alkalinity	Balance the pool water.
<b>Algae</b> Algae may be caused by insufficient levels of oxidizer and/or inadequate water circulation.	Green algae	Pea green color; attaches to pool walls sometimes colors the entire body of water.	1 Check pH and adjust if necessary. 2 [Superchlorinate, Superoxidize] with chlorine according to manufacturer's instructions and brush pool walls. 3 Repeat steps 1 and 2 until algae is gone.
	Black algae	Black spots on pool walls.	1 Brush affected areas.
	Mustard algae	Yellow or brown film on steps or walls.	2 [Superchlorinate, Superoxidize] water with chlorine according to manufacturer's instructions. 3 Add algaecide. 4 Vacuum pool. 5 Repeat steps 1 through 4 until algae is gone.
Note: Regular algaecide treatments are recommended for outdoor pools that experience persistent algae problems. Do not use algae treatments containing either copper or sodium bromide.			
<b>Stains</b>	Blue/green	Copper or iron from pool equipment corrosion or water supply.	1 Adjust pH and total alkalinity to ideal ranges. 2 Vigorously brush stained areas. 3 Add sequestrant. 4 Run filter. 5 Twelve hours later, [superchlorinate, superoxidize] pool. 6 Test and balance water. 7 Test pool water for dissolved metals.
	Red/brown	Iron or manganese from equipment corrosion or water supply.	
	Black	Manganese in water supply.	
	Metal tarnishing	High native mineral content in water; unbalanced water.	Clean with soft cloth and mild detergent. Test water for minerals; use a sequestrant; maintain water balance.
<b>Scale</b>	Crusty deposits on pool surfaces.	High pH and high total alkalinity	Adjust pH and total alkalinity to ideal ranges.
		High TDS (total dissolved solids) or high hardness levels.	1 Replace a volume of pool water with water with low levels of dissolved solids. 2 Use sequestrant to prevent scale buildup if high hardness levels are a continuing problem.

[If you need further assistance, please call 1-800-822-7933.]

**ACCEPTED**  
**with COMMENTS**  
**EPA Letter Dated:**  
**July 28 2010**  
**Under the Federal Insecticide, Fungicide, and Rodenticide Act as amended, for the pesticide, registered under EPA Reg. No. 679**

Note: Bracketed [ ] information is optional text/picture/diagram. Text separated by a comma (,) denotes and/or options {Bracket Text} is for administrative purposes. Punctuation, text size, text font, text color, capital letters, lower case letters, italics, bold and underline may vary on final printed labels. Spelling may vary when alternate spelling is acceptable; for example "algaecide" or "algicide"

## Nature<sup>2</sup> [Cartridge, Sanitizer] Replacement Intervals

[Use the month indicator ring on the top of the [cartridge, unit]] [Monitor the cartridge replacement light on the {insert product name} control panel] to identify the date on which the cartridge should be replaced.] Always turn pump off prior to installing or changing [a] [Nature<sup>2</sup>, {the model name may be inserted here}][cartridge]. Your pump/filter is operated under pressure and the pressure must be released before you begin work. Please see your pump/filter owner's manual for further instruction.

A cartridge lasts [six, 6, four, 4] months or one season, whichever is shorter. The cartridge should not be used longer than [six, 6, four, 4] continuous months.

{The frost-belt and sun-belt information is optional language that may be used in some but not all owner's manuals}

### **[In frost-belt regions (3-6 month pool season):**

Discard your used system when you close your pool at the end of the season. Install a new system when you open your pool in the spring.]

### **[In sun-belt regions (7-12 month pool season):**

Replace your Nature<sup>2</sup> cartridge every 6 months whether or not you plan to use the pool for swimming. ]

## Winterizing Your Pool

Use these steps as a guide. Consult your dealer for specific information [in, on] your area.

### **Warm Climate**

- 1 Reduce the number of hours the pump runs since the cooler weather decreases the spread of algae and other pollutants.
- 2 There is no need to [superoxidize, superchlorinate] the pool during cool weather unless the water becomes cloudy (as may occur after a winter storm). See Cloudy Water in Troubleshooting section.

### **Cold Climate**

- 1 Check total alkalinity and pH of pool to make sure that they are in proper balance.
- 2 Vacuum the pool bottom to remove any debris or other potential contaminants.
- 3 [Superoxidize, Superchlorinate] the pool with chlorine according to manufacturer's instructions to clear the water.
- 4 Add a winter algaecide following manufacturer's instructions.

**Important:** Do *not* use a winter algaecide with copper in it. [This will void the Nature<sup>2</sup> no-stain warranty.]

- 5 Backwash the filter.
- 6 Drain part of the pool water. The amount to drain varies from one part of the country to another. Consult your dealer for advice.
- 7 Remove the [Nature<sup>2</sup>, sanitizer system] cartridge and discard with household trash.
- 8 Winterize the pipes with pool antifreeze following manufacturer's instructions.
- 9 Drain the water out of all equipment (pump, filter, etc.)
- 10 Store all baskets, hoses and cleaning equipment, indoors if possible.
- 11 Cover the pool with a winter cover.

## Disposal

After [six, four] [months] of use, discard [Nature<sup>2</sup>, {product name may be inserted}] cartridge in household trash. Do not save the [cartridge, it] for re-use. The [cartridge, {product name may be inserted}] is manufactured with the mineral media sealed inside. In the unlikely event [a cartridge, {product name may be inserted}] breaks, remove it and vacuum out any media introduced into the pool.

ACCEPTED  
with COMMENTS  
EPA Letter Dated:

JUL 28 2010

Under the Federal Insecticide,  
Fungicide, and Rodenticide Act as  
amended, for the pesticide,  
registered under EPA Reg. No. 67712-1

Note: Bracketed [ ] information is optional text/picture/diagram. Text separated by a comma (,) denotes and/or options {Bracket Text} is for administrative purposes. Punctuation, text size, text font, text color, capital letters, lower case letters, italics, bold and underline may vary on final printed labels. Spelling may vary when alternate spelling is acceptable: for example "algaecide" or "algicide"

{This warranty statement is optional}

## Limited Warranty

### Nature<sup>2</sup> Limited Warranty

The limited warranties contained within this document are the only warranties given with your [Nature<sup>2</sup>, {insert model name}] [Sanitizer, Cartridge] and supercede any prior warranties. All other warranties, expressed or implied, including the implied warranty of merchantability or the implied warranty of fitness for a particular purpose are hereby disclaimed. Our sole obligation under this warranty, and the purchaser's sole remedy, is limited to repair or replacement of the [Nature<sup>2</sup>, {insert product name}] [Sanitizer, cartridge], [or one of its parts]. The Nature<sup>2</sup> warranty applies to the original owner only.

[THE LIMITED WARRANTIES OF THE [NATURE<sup>2</sup>, {insert product name}] [Cartridge[s]] [Inground] [SANITIZER[s]] [ARE]]: [The] [Nature<sup>2</sup>, {insert product name}] [Sanitizer, cartridges] [are, is] warranted to be free of defects in materials and to perform satisfactorily for a period of [six, four] months from the date of purchase. Nature<sup>2</sup> {insert model name} [Sanitizer, cartridges] [are, is] warranted not to cause copper staining in your pool. This limited warranty requires that you exercise reasonable care of your pool and keep water in balance at all times and not use a copper-based algacide. This [limited] warranty does not cover discoloration to chromium fittings. This warranty does not cover cartridges used with any biguanide products such as Baquacil<sup>®</sup> or Soft Swim<sup>®</sup> [or any products containing Bromine or Bromine-based chemicals]. If the cartridge is defective and does not perform satisfactorily for the entire [six, four] months, we will [make a prorata rebate based on your actual period of use. You are responsible to pay the below-indicated percentage on the then applicable retail cost: <1 month-0%; 1-2 months-25%; 3-4 months-50%; 5-<6 months-75%.][replace your {insert product name}] [cartridge, sanitizer.]

### EXCLUSIONS FROM WARRANTY

[The] [Nature<sup>2</sup>, {insert product name}] [Sanitizer, cartridge[s]] [are, is] designed for use on [inground] [and] [aboveground] pools [with cartridge filters] from [5,000 to 25,000] [5,000 to 45,000] [10,000 to 45,000] gallons [depending on cartridge model]. If it is used in any other application, the warranty is void, and the purchaser and/or pool owner releases the manufacturer from [any and] all claims related to the use of the Nature<sup>2</sup><sup>®</sup> [Sanitizer, Express, Cartridge].

This warranty does not cover problems arising in whole or in part from purchaser's negligence, misuse or abuse, improper maintenance or storage, accident, improper installation, improper application, failure to follow all appropriate safety precautions, Acts of God, abnormal weather conditions, damage from plants or animals, and improper use of chemicals.

This warranty specifically excludes all incidental or consequential damages, except where state law requires them to be paid. This warranty gives you specific rights. You may have other rights that vary from state to state.

### TO SUBMIT A CLAIM

Report claims to Zodiac Pool Systems, Inc. by calling 1-800-822-7933. Only the original purchaser may submit a claim under this limited warranty. [All] Claims must be accompanied by an original purchase receipt.



ZODIAC POOL SYSTEMS, INC.

2620 Commerce Way

Vista, CA 92081

Tel: 800-822-7933

Fax: 877-327-1403

www.zodiacpoolsystems.com

ACCEPTED  
with COMMENTS  
EPA Letter Dated:

JUL 28 2010

Under the Federal Insecticide,  
Fungicide, and Rodenticide Act as  
amended, for the pesticide,  
registered under EPA Reg. No. 67712-1

Nature<sup>2</sup> is a registered trademark [owned by, of] Zodiac Pool Systems, Inc.

Printed in the USA

© Copyright 2010 Zodiac Pool Systems, Inc.

{optional manual part numbers} [W17545] [W17510] [W17570] [W17025]

Note: Bracketed [ ] information is optional text/picture/diagram. Text separated by a comma (,) denotes and/or options {Bracket Text} is for administrative purposes. Punctuation, text size, text font, text color, capital letters, lower case letters, italics, bold and underline may vary on final printed labels. Spelling may vary when alternate spelling is acceptable: for example "algacide" or "algicide"

*{Optional manual Language pictures diagrams}*

**CARTRIDGE CAPACITY**

G Cartridge	10,000 - 25,000 gallons
	25,000 - 35,000 gallons
	35,000 - 45,000 gallons
M Cartridge	5,000 - 25,000 gallons
VC Cartridge	5,000 - 20,000 gallons
	20,000 - 40,000 gallons

**CARTRIDGE CAPACITY**

DuoClear Cartridge	10,000 - 25,000 gallons
	25,000 - 35,000 gallons
	35,000 - 45,000 gallons

*{optional language for Safety Instructions}*

[Nature<sup>2</sup> ] [Nature<sup>2</sup> G Cartridge[s]] [Nature<sup>2</sup> M Cartridge[s]] [and] [Nature<sup>2</sup> VC Cartridge[s]] *{insert model name}*  
[Cartridge[s]] [have] [has] been designed to sanitize swimming pools from [5,000 to 25,000] [5,000 - 45,000]  
[10,000 to 45,000] gallons [depending on cartridge model. Make sure that your Nature<sup>2</sup> *{insert model name}*]  
[Sanitizer, Cartridge] corresponds with the proper vessel and is appropriate for your pool size by consulting the chart  
above.]

**ACCEPTED  
with COMMENTS  
EPA Letter Dated:**

JUL 28 2010

Under the Federal Insecticide,  
Fungicide, and Rodenticide Act as  
amended, for the pesticide,  
registered under EPA Reg. No. 67712-1

Note: Bracketed [ ] information is optional text/picture/diagram. Text separated by a comma (,) denotes and/or options  
*{Bracket Text}* is for administrative purposes. Punctuation, text size, text font, text color, capital letters, lower case letters, italics,  
bold and underline may vary on final printed labels. Spelling may vary when alternate spelling is acceptable: for example  
"algaecide" or "algicide"

{ Optional manual Language/pictures/diagrams }

## Assembly

The Nature<sup>2</sup> CF consists of 4 sanitizer elements, 2 end caps and 2 end spikes.

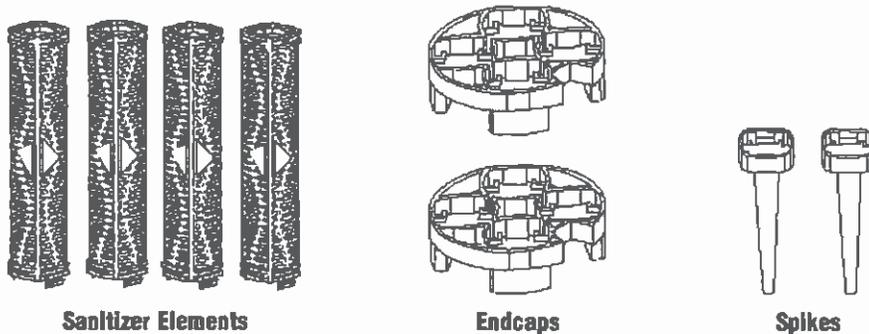

Depending upon the size of your swimming pool cartridge filter, these parts can be assembled as a bundle of 4 sanitizer elements, or as 2 sticks of 2 elements each.

**NOTE:** You should first attempt to use the bundle assembly.

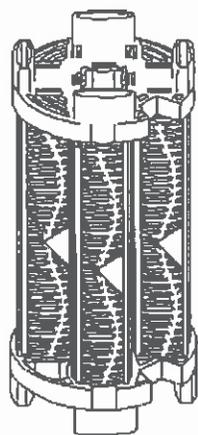

**Bundle Assembly**

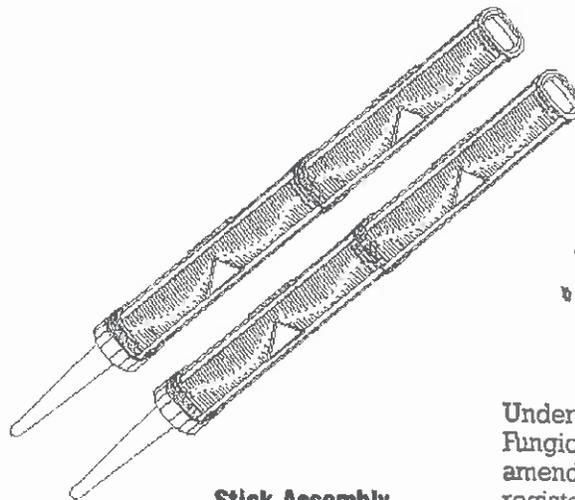

**Stick Assembly**

ACCEPTED  
with COMMENTS  
EPA Letter Dated:

JUL 28 2010

Under the Federal Insecticide,  
Fungicide, and Rodenticide Act as  
amended, for the pesticide,  
registered under EPA Reg. No. 67712-1

### Decide which Nature<sup>2</sup> CF assembly is right for your pool filter.

- 1 Turn off the pump and disassemble the pool filter as you normally would to clean the cartridge.
- 2 Check to see if the endcap fits easily into the core of your cartridge filter:
  - If it does, go to Bundle Assembly
  - If it does not, go to Stick Assembly

Note: Bracketed [ ] information is optional text/picture/diagram. Text separated by a comma (,) denotes and/or options {Bracket Text} is for administrative purposes. Punctuation, text size, text font, text color, capital letters, lower case letters, italics, bold and underline may vary on final printed labels. Spelling may vary when alternate spelling is acceptable: for example "algaecide" or "algicide"

{Optional manual Language pictures diagram }

## Bundle Assembly

The hole in the center of the endcap accommodates a center rod should your filter have one.

- 1 Lay an end cap on a flat surface and snap the 4 sanitizer elements into it, so that the tabs are pointing up.

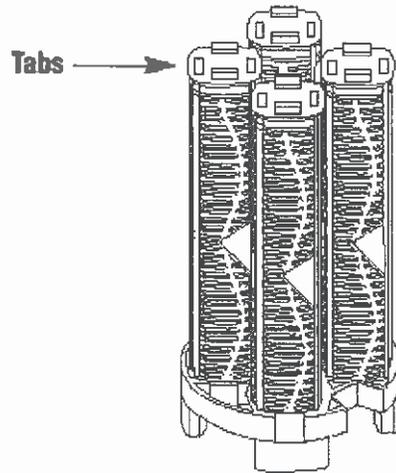

- 2 Snap the other end cap on top.

---

**Important:** Be sure that the notch on each end cap lines up together to accommodate an air bleed tube.

---

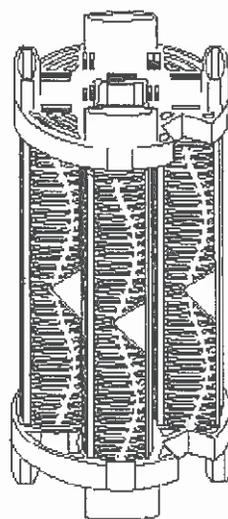

Align Notches

ACCEPTED  
with COMMENTS  
EPA Letter Dated:

JUL 28 2010

Product of the Federal Insecticide,  
Fungicide, and Rodenticide Act as  
amended, for the pesticide,  
registered under EPA Reg. No. 62712.

Note: Bracketed [ ] information is optional text/picture/diagram. Text separated by a comma (,) denotes and/or options  
{Bracket Text} is for administrative purposes. Punctuation, text size, text font, text color, capital letters, lower case letters, italics,  
bold and underline may vary on final printed labels. Spelling may vary when alternate spelling is acceptable; for example  
"algaecide" or "algicide"

{ Optional manual Language pictures diagrams }

## Stick Assembly

---

**Important:** Use only after attempting the Bundle Assembly.

---

- 1 Snap two sanitizer elements together so that each lab and slot line up.



- 2 Snap the end spike to one end.

**NOTE:** Once assembled, do not attempt to separate the sanitizer elements as the labs may break.

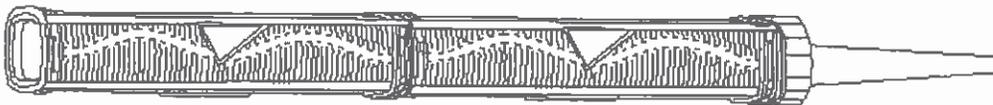

ACCEPTED  
with COMMENTS  
EPA Letter Dated:

JUL 28 2010

Under the Federal Insecticide,  
Fungicide and Rodenticide Act as  
amended, for the pesticide,  
registered under EPA Reg. No. 67712-1

Note: Bracketed [ ] information is optional text/picture/diagram. Text separated by a comma (,) denotes and/or options {Bracket Text} is for administrative purposes. Punctuation, text size, text font, text color, capital letters, lower case letters, italics, bold and underline may vary on final printed labels. Spelling may vary when alternate spelling is acceptable: for example "algaecide" or "algicide"