



UNITED STATES ENVIRONMENTAL PROTECTION AGENCY
WASHINGTON, DC 20460

OFFICE OF CHEMICAL SAFETY
AND POLLUTION PREVENTION

April 17, 2020

Mark Jernigan
Registration Manager, Pool
Recreational Water Products, Inc.
P.O. Box 1449
Buford, GA 30515

Subject: Notification per PRN 98-10 – Application to Add Graphic Illustration to the Product Label.
Product Name: T-0047
EPA Registration Number: 67262-43
Application Date: January 8, 2020
Decision Number: 559632

Dear Mr. Jernigan:

The Agency is in receipt of your Application for Pesticide Notification under Pesticide Registration Notice (PRN) 98-10 for the above referenced product. The Antimicrobials Division (AD) has conducted a review of this request for its applicability under PRN 98-10 and finds that the action requested falls within the scope of PRN 98-10.

The label submitted with the application has been stamped “Notification” and will be placed in our records.

Should you wish to add/retain a reference to the company’s website on your label, then please be aware that the website becomes labeling under the Federal Insecticide Fungicide and Rodenticide Act and is subject to review by the Agency. If the website is false or misleading, the product would be misbranded and unlawful to sell or distribute under FIFRA section 12(a)(1)(E). 40 CFR 156.10(a)(5) list examples of statements EPA may consider false or misleading. In addition, regardless of whether a website is referenced on your product’s label, claims made on the website may not substantially differ from those claims approved through the registration process. Therefore, should the Agency find or if it is brought to our attention that a website contains false or misleading statements or claims substantially differing from the EPA approved registration, the website will be referred to the EPA’s Office of Enforcement and Compliance.

If you have any questions, you may contact Michael Varco at 703-347-0403 or via email at Varco.Michael@epa.gov.

Sincerely,

A handwritten signature in black ink, appearing to read "Demson Fuller".

for

Demson Fuller, Product Manager 32
Regulatory Management Branch II
Antimicrobials Division (7510P)
Office of Pesticide Programs

*{All text in brackets [xxx] is optional and may or may not be included on a final label.}
{All text in braces {xxx} is administrative and will not appear on a final label.}*

T-0047

ACTIVE INGREDIENT:

| | |
|----------------------------|------|
| Trichloro-s-triazinetriene | 90% |
| OTHER INGREDIENTS | 10% |
| TOTAL INGREDIENTS | 100% |

(Available Chlorine: 81%)

KEEP OUT OF REACH OF CHILDREN

DANGER

See [back] [side] panel for First Aid and additional Precautionary Statements. *{If First Aid appears on back or side panel}*

See [back] [side] panel for additional Precautionary Statements. *{If First Aid appears on front panel}*

MANUFACTURED FOR:

RECREATIONAL WATER PRODUCTS

[AQUA CHEM DIVISION]

[PoolTime Division]

PO BOX 1449

BUFORD, GEORGIA 30515

NET [WEIGHT] [CONTENTS]: *{as indicated on container}*

EPA REG. NO. 67262-43

EPA EST. NO. 5185-GA-1 [(BL)] {or} [(Z)]

7616-CA-1 [(C)]

{If multiple EPA Establishment Numbers appear on the label.}

[Actual establishment shown in code above or below label printed on [bottle] [container]]

[Letter designation in lot code printed above or below on [bottle] [container] identifies actual establishment.]

NOTIFICATION

67262-43

The applicant has certified that no changes, other than those reported to the Agency have been made to the labeling. The Agency acknowledges this notification by letter dated:

04/17/2020

[What?] *{For use on front panel of label as a header above/beside product name.}*

[Why?] *{For use on front panel of label as a header above/beside marketing statements chosen from accepted label text that relates to the consumer features and benefits of product.}*

[Free [App] Water Testing & Solutions Center]
[Free Water Testing & Solutions Center]
[FREE [Water] Test Strips]
[Test Your Pool with the Clorox® Pool App]
[Download the FREE Clorox® Pool App]
[Water Testing & Solution Center]
[Test Any Strip with the Clorox® Pool App]
[Use the Clorox® Pool App to Order Products Direct from Walmart.com]
[Test Smarter]
[Anytime. Anywhere. Pool Water Analysis and Solutions.]
[Download the Free ClearPool Expert™ App]
[Expert results begin with water testing.]
[Test like an expert [with the ClearPool Expert™ App]]
[Get it on Google Play]
[Download on the App Store]

{Optional marketing statements that may be used with pool sanitization with any of the product forms on this label.}

[Slow-Dissolving Sanitizer]
[Kills Bacteria]
[Controls Bacteria and Algae]
[Controls Algae]
[Kills Bacteria and Controls Algae]
[With built-in Sunlight Protector]
[with SUNSHIELD™]
[with SUNSHIELD™ Protects chlorine from sunlight, so you use less]
[Keeps water clean]

[When?] *{For use on front panel of label as a header above/beside text chosen from accepted label text that relates to the consumer anticipated frequency of product use.}*

[2 X a week*]

[*Approximate addition rate. Please refer to directions for use.]

{The “Pool Essentials System” box below may be placed on the label to allow easy product category identification by consumers.}

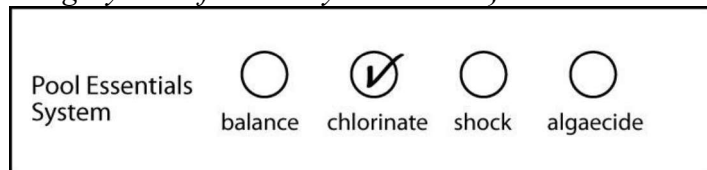

{The “4-step System” box below may be placed on the label to allow easy product category identification by consumers.}

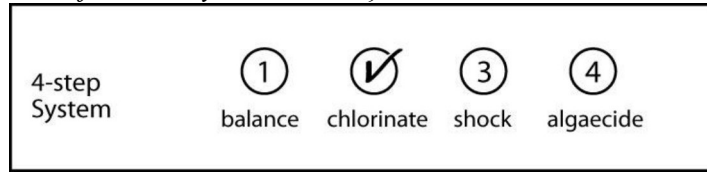

[Made in USA]

[Prevents algae]

[Algae prevention]

[Use for continuous protection against [bacteria] [and] [algae]][***]

[Provides continuous protection against [bacteria] [and] [algae]] [***]

[Continuously protects against [bacteria] [and] [algae]] [***]

[*** When used as directed]

[Protects against [bacteria] [algae] [and] [organic] [contaminants] for [clean] [and] [clear] water]**]

[Controls bacteria and prevents algae for clear [inviting] water]

[Kills bacteria and prevents algae] [for clean and clear water with less effort]

[Kills and prevents algae]

[Sanitizes and prevents algae]

[Sanitizes [and] [clarifies] [and] [prevents algae]]

[Sanitizes [and] [prevents algae] [and] [enhances filtration]]

[Sanitizer and [algaecide] [algicide]]

[Algaecide] [Algicide]

[Multi-functional [sanitizer] [algae preventer] [algae control] [algae killer] [sunlight protector] [clarifier]]

[Multi-action [sanitizer] [algae preventer] [algae control] [algae killer] [sunlight protector] [clarifier] [enhances filtration]]

[1-step [sanitizer] [algae preventer] [algae control] [algae killer] [sunlight protector] [clarifier]]

[One step [sanitizer] [algae preventer] [algae control] [algae killer] [sunlight protector] [clarifier]]

[3] [4] –in-1 formula [with] [sanitizer] [algae preventer] [algae control] [algae killer] [sunlight protector] [decontaminant] [clarifier] [and] [&] [enhances filtration]]

[Kills algae]

[Algae [fighter] [killer] [preventer]]

[Individually wrapped tablets]

[Single [use] wrapped tablets]

[Destroys [Breaks down] [Eliminates] [Controls] [swimmer] [organic] contaminates [such as] [including] [oils] [sweat] [lotion] [urine] [pee]]

[Destroys [Breaks down] [Eliminates] organic contaminants**]

[Protects against [bacteria] [algae] [and] [organic contaminants**] for [clean] [and] [clear] water]

[x] [1/2 lb] [.5 lb] [6 oz] [8 oz] [Jumbo] [Size] [Tabs] [Tablets]] {Where x equals the approximate number of tablets in container, depending on size.}

[Each Tablet weighs [6 oz] [8 oz] [1/2 lb] [.5 lb]]

[Multifunctional]

[Multi-action]

[3-in-1 [sanitizer]]

[4-in-1 [sanitizer]]
 [4 in 1 formula]
 [Kills bacteria [+] [&] [destroys] [eliminates] organic contaminants**]
 [Kills bacteria [+] [&] [destroys] [eliminates] swimmer contaminants**]
 [Prevents algae [outbreaks] [growth] [blooms] and kills bacteria]
 [Kills bacteria for clean, ready-to-swim water]
 [Removes organic contaminants** [for clear water]]
 [Removes swimmer contaminants** [for clear water]]
 [For [long lasting] clean, clear water]
 [Chlorinating tab protects your water against bacteria [and organic contaminants**] [and swimmer
 Contaminants**]]
 **[such as] [body & suntan oils] [body oils] [oils][&] [suntan oils] [&] [sweat] [perspiration] [&]
 [lotions] [&] [urine]]
 [Slow-dissolving]
 [Cleans Water & Stops Algae]
 [Maintains a Healthy Pool]
 [Maintains Pool Health]
 [Cleans Water and Stops Algae]
 [Clean Healthy Water]
 [Protects from Bacteria]
 [Prevents Bacteria]
 [Kills and Prevents All Types of Pool Algae]
 [Kills and Prevents All Types of Pool Algae*]
 [*green, mustard, black]
 [Kills and Prevents Green, Mustard and Black Algae]
 [Kills Harmful Bacteria]
 [Destroys Bacteria]
 [Prevents Corrosion, Scale and Stains]
 [Prevents Harmful Bacteria]
 [Destroys Algae]
 [Long-Lasting Sunlight Protection]
 [Sanitizer + Clarifier]
 [Crazy Clarifier]
 [XtraBlue Chlorine]
 [For Crystal Clear Water]
 [Contains Super Water Clarifier]
 [Clarifies Water]
 [Clears Cloudy Water]
 [Dual Action Tab]
 [Dual Layer Tab]

[[Prevents] [Eliminates] [Quickly] [Clears] [cloudy] [murky] [green] water]
 [[Improves] [Enhances] filtration]
 [Clarifier enhances filtration]
 [Improves filter performance]
 [Clears Cloudy Water]

[Quickly Clears Cloudy Water]
[Creates Sparkling Water]
[Provides Crystal Clear Water]
[Restores Water Clarity]
[Clarifies water]
[Gathers debris for easy filtration]
[Contains a Filter Enhancer]
[Produces Sparkling Clean Swimming Pool Water]
[Keeps water clean]
[Easy, one-step solution for clean water]
[Easy, one-step solution for clear water]
[Easy, one-step solution for clean, clear water]
[Creates crystal clear water]
[For crystal clear water]
[Provides [crystal] [sparkling] clear water]

[Chlorinating sanitizer]
[Chlorine sanitizer]
[Protected against sunlight to last longer]

[Treats up to 5,000 gallons] *{for use with products marketed for smaller pools}*
[Treats [500] [1,000] [2,000] – 5,000 gallons] *{for use with products marketed for smaller pools}*
[For small pools]
[For use with all filter & surface types]
[Easy 1 2 3 Pool Care Brand System]
[Step 2] *{Chlorination is “Step 2” in “Easy 1 2 3 Pool Care Brand System”}*
[Chlorinate]
[Do not store in direct sunlight]
[Store out of direct sunlight]
[4-in-1 [action]]
[For Pools] *{For use with products that have pool use directions}*
[For Pools Only] *{For use with products that have pool use directions}*
[Not for use in Spas] *{For use with products that have pool use directions}*

{Optional marketing statements that may be used with pool sanitization with 1 inch tablets.}

- [Stabilized Chlorinator]
- [Concentrated, Stabilized, Slow-Dissolving Sanitizer for convenient use in above ground and in-ground pools]
- [Concentrated, Slow-Dissolving Sanitizer for Routine Use in Automatic Feeders and Float Rings]
- [Concentrated, Slow-Dissolving Sanitizer for Routine Use in Automatic Feeders and Floaters]
- [Feeder]
- [Floater]

{Following Chart is Optional}

| Application Methods | FEEDER OR FLOATER | | |
|----------------------------|--|------------|--------------|
| Surface Types | [Aggregate] | [Concrete] | [Fiberglass] |
| | [Gunitite] | [Plaster] | [Vinyl] |
| Filter Types | [D.E.], [Sand], [Cartridge], [Zeolite] | | |

{Optional marketing statements that may be used with pool sanitization with 3 inch tablets.}

- [Stabilized Chlorinator]
- [Concentrated, Stabilized, Slow-Dissolving Sanitizer for convenient use in above ground and in-ground pools]
- [Concentrated, Slow-Dissolving Sanitizer for Routine Use in Automatic Feeders, Floaters or Plastic Skimmers]
- [Contains Approximately [x] 3" Tablets] {Where x equals the approximate number of tablets in container, depending on size.}
- [3" [long lasting] [tabs] [tablets]]
- [Wrapped [tablets]]
- [Individually wrapped]
- [Wrapped for easy handling]
- [Skimmer]
- [Feeder]
- [Floater]

{Following Chart is Optional}

| Application Methods | FEEDER, FLOATER OR SKIMMER | | |
|----------------------------|--|------------|--------------|
| Surface Types | [Aggregate] | [Concrete] | [Fiberglass] |
| | [Gunitite] | [Plaster] | [Vinyl] |
| Filter Types | [D.E.], [Sand], [Cartridge], [Zeolite] | | |

{Optional marketing statements that may be used with pool sanitization with sticks.}

- [Stabilized Chlorinator]
- [Concentrated, Stabilized, Slow-Dissolving Sanitizer for convenient use in above ground and in-ground pools]
- [Concentrated, Slow-Dissolving Sanitizer for Routine Use in Automatic Feeders, Floaters or Plastic Skimmers]

{Optional marketing statements that may be used with pool sanitization with pool floater sanitization.}

[Stabilized Chlorinator]

[Concentrated, Stabilized, Slow-Dissolving Sanitizer for convenient use in above ground and in-ground pools]

{Optional marketing statements that may be used with pool cartridge sanitization.}

[Stabilized Chlorinator]

[Type “E”]

[Fits E-Z Chlor and Sun Automatic Chlorinators]

[Concentrated, Stabilized, Slow-Dissolving Sanitizer for convenient use in above ground and in-ground pools]

{Optional marketing statements that may be used with Stabilized Chlorine Cartridge and Chlorinating Cartridge Type E.}

[Stabilized Chlorinator]

[Type “E”]

[Fits E-Z Chlor and Sun Automatic Chlorinators]

[Concentrated, Stabilized, Slow-Dissolving Sanitizer for convenient use in above ground and in-ground pools]

{Optional marketing statements that may be used with Dial Adjusted Pool Floater. }

[TO OPEN CUT ALONG DOTTED LINE WITH SCISSORS] *{For use when packaged in child resistant bags.}*

[Convenient]

[No handling chemicals]

[Easy-to-use]

[Easy-use floater]

[Easy-to-use dial]

[Easy, adjustable dial]

[Adjustable dial]

[Adjustable rotating dial]

[Easy, flow-control dial]

[With flow-control dial]

[Flow-control dial]

[Flow-regulation dial]

[Easy rotating dial]

[Adjust n’ go ring]

[Adjustable ring]

[Easy-adjust ring]

[Easy-to-use [flow-control ring] [adjustable ring] [adjustable dial] [flow control dial]]

[Easy-to-adjust [flow-control ring] [adjustable ring] [adjustable dial] [flow control dial]]

[Easy-to-control sanitizer flow]

[Easy-to-adjust sanitizer flow]
 [Spend less time applying products]
 [[Multi-functional] [5-in-1] [4-in-1] formula saves time]
 [[Easy] [convenient] [single-use] application saves time]
 [Use fewer products]
 [Non-refillable]
 [Single use]
 [One-time use]
 [Maintains a 1-4 ppm of chlorine for up to [four] [4] weeks]
 [Maintains a 1-4 ppm of chlorine for up to [one] [1] month]
 [Great for use during [long] vacations]
 [[Ideal] for [small] [pop-up] [inflatable] [above ground] [in-ground] [all] pools]
 [[Great] for [small] [pop-up] [inflatable] [above ground] [in-ground] [all] pools]
 [For use in [small] [pop-up] [inflatable] [above ground] [in-ground] [all] pools]
 [Ideal for small[er] pools]
 [Ideal for use in above ground pools]
 [Use for clean water]
 [Use for clear water]
 [Use for clean, clear water]
 [Use for clean, clear water]
 [For clean water]
 [For clear water]
 [For clean, clear water]
 [For clean, clear water all month [long]]
 [For use in in-ground and above ground pools]
 [For use in in-ground pools]
 [For use in above ground pools]
 [Lasts up to [one] [1] month]
 [Lasts up to [four] [4] weeks]
 [Lasts [one] [1] month]
 [Lasts [four] [4] weeks]
 [[4] [four] week protection]
 [[1] [one] month protection]
 [Month long protection]
 [Use for continuous protection against [bacteria] [and] [algae]]
 [Provides continuous protection against [bacteria] [and] [algae]]
 [Continuously protects against [bacteria] [and] [&] [algae]]
 [Protects against [bacteria] [algae] [and] [contaminants**] for clear water [for clean water] [for clean and clear water]]
 **[such as] [body & suntan oils] [body oils] [&] [suntan oils] [&] [sweat] [perspiration] [&] [lotions] [&] [urine]
 [Controls bacteria and [prevents] [controls] algae for clear [inviting] water]
 [[Crystal] clear water with less effort]
 [Clean water with less effort]
 [Less effort for clear water]
 [Less effort for clean water]

[Less effort for clean, clear water]
[Clean, clear water with less effort]
[[Crystal clear] [and] [&] [clean] water all month long]
[Keeps water clean [for up to [1] [one] month]]
[Keeps water clear [for up to [1] [one] month]]
[Keeps water clean [for up to [4] [four] weeks]]
[Keeps water clear [for up to [4] [four] weeks]]
[Keeps water clean [and] [&] clear [for up to [1] [one] month]]
[Keeps water clear [and] [&] clear [for up to [4] [four] weeks]]

{Directions to be used for pool sanitization with 1 inch tablets, Option A}

POOL SANITIZATION WITH 1 INCH TABLETS

[WHY TO USE THIS PRODUCT: For use in feeders and floaters, this multifunctional sanitizer kills bacteria and controls algae. This sanitizer will last longer compared to chlorine products such as liquid bleach or calcium hypochlorite, as it contains [SUNSHIELD[®], which protects chlorine from sunlight, so you use less.] *{or}* [sunlight protected chlorine.] It's the perfect solution for clear, inviting pool water.]

{or}

[WHY USE THIS PRODUCT: [1 Inch Tabs] *{or}* [This product], the [compound action] tablet that does more:

- Kills bacteria
- [Kills] [Controls] algae
- [Clarifies] [With Clarifier]
- [Enhances filtration]

[1 Inch Tabs] *{or}* [This product] also contains [SUNSHIELD[®], which protects chlorine from sunlight, so you use less.] *{or}* [sunlight protected chlorine.]

{or}

[WHY TO USE THIS PRODUCT: This product kills bacteria [and controls algae] in swimming pools.

IMPORTANT NOTES:

1. Shock your pool every week and also after heavy rain or heavy use to help keep your pool water properly maintained.
2. Sunlight, rainfall, temperature, number of swimmers, and frequency of pool use affect the rate of chlorine residual loss. Adjust cleaning and chemical maintenance accordingly.
3. Use this product in an automatic feeder or floater designed for this product.
4. Do not add other chemicals into the feeder or floater where this product is in use as a fire or explosion may occur.
5. To avoid damage to pool surface or materials do not allow product to come in direct contact with these materials. Do not throw tablets directly into pool.

DIRECTIONS FOR USE:

It is a violation of Federal Law to use this product in any manner inconsistent with its labeling. Read entire label and use strictly in accordance with precautionary statements and directions.

BEFORE YOU BEGIN:

1. Ensure all pool equipment is working properly. Adjust stabilizer levels to 40-50 PPM with stabilizer.
2. Test the water's pH, alkalinity, and calcium hardness and adjust to the correct level. Adjust pH to 7.2-7.6. Adjust alkalinity to 80-125 PPM for plaster pools and 125-150 for vinyl or fiberglass pools. Adjust calcium hardness to 200-275 PPM for plaster pools, 175-225 for vinyl or fiberglass pools. Be sure to follow label directions when using other products as outlined in directions for this product.
3. Check the free available chlorine level and adjust to 1-4 PPM by adding a granular chlorinating product.

NOW USE THIS PRODUCT**START-UP/INITIAL TREATMENT:**

1. If water is cloudy or green, superchlorinate pool with appropriate shock product until pool is clear.
2. Add 16 ounces of this product (approximately 23 tablets) per 10,000 gallons of pool water to feeder or floater and then test for the free available chlorine level (allow water to circulate at least 4 hours before testing). Adjust the feeder or floater following manufacturer's instructions to establish a free available chlorine level between 1-4 PPM.
3. When free available chlorine level is adjusted to 1-4 ppm, add the [algicide] *{or}* [algaecide] appropriate to your needs.

ROUTINE MAINTENANCE:

Add 16 ounces of this product (approximately 23 tablets) per 10,000 gallons of pool water per week, or as often as needed, to the floater or feeder to maintain a constant free available chlorine level of 1-4 PPM. Sunlight, rainfall, temperature, number of swimmers, and frequency of pool use affect the rate of chlorine residual loss so check the floater or feeder often and refill as needed.

Reentry into treated swimming pools is prohibited when free available chlorine levels are above 4 PPM due to risk of body injury.

{Directions to be used for pool sanitization with 1 inch tablets, Option B}

[How?]

DIRECTIONS FOR USE:

It is a violation of Federal Law to use this product in any manner inconsistent with its labeling. Read entire label and use strictly in accordance with precautionary statements and directions.

To Keep Water Clean:

- Test and balance water before using this product. Visit [the Clorox Pool&Spa Site] {or} [www.cloroxpool.com] {or} [the Pool Essentials site] {or} [www.pool essentials.com] {or} [the Aqua Chem Web Site] {or} [www.aquachem.com] {or} [the Pool Time website] {or} [www.pooltime.com] {or} [the Brand Name website] {or} [www.brandname.com] for complete pool balancing instructions.
- If the pool is cloudy or green, add a granular shock product; follow application directions on that product.
- Add tabs to an appropriate feeder or floater to bring chlorine level to 1-4 ppm; refill as needed to maintain 1-4 ppm.
- When chlorine level is adjusted to 1-4 ppm, add the [algicide] {or} [algaecide] appropriate to your needs.
- Do not add other chemicals through the feeder when using this product as an explosion might occur.
- Direct contact with pool surface or equipment may cause damage; do not add directly to the pool.
- Apply more product after heavy use, high temperatures, or rain. To keep water clear, shock pool on a weekly basis.

Reentry into treated swimming pools is prohibited above levels of 4 ppm chlorine due to risk of body injury.

{Directions to be used for pool sanitization with 1 inch tablets, Option C}

DIRECTIONS FOR USE:

It is a violation of Federal Law to use this product in any manner inconsistent with its labeling. Read entire label and use strictly in accordance with precautionary statements and directions.

Test and balance water prior to use. Adjust pH to 7.2-7.6 [and free chlorine to 1-4ppm].
Visit [website] for [free water analysis] [&] [personalized product and dosage recommendations].

Use: Protects against algae and bacteria for water that stays clean, clear & free of visible algae.

| Application Methods | |
|--|---|
| If water is cloudy or green, add a granular shock product per label directions. | |
| Feeder & Floater | Fill with [tabs] [tablets] and adjust output to bring chlorine to 1-4 ppm, test and refill as needed to maintain 1-4 ppm. |
| Do Not apply other chemicals through feeder as an explosion might occur. Direct contact with pool surfaces or equipment may cause damage. | |

For best results: Apply more product after heavy pool use, high temperatures or rain to maintain 1-4 ppm.

Re-entry into treated swimming pools is prohibited above levels of 4 ppm chlorine due to risk of body injury.

{Directions to be used for pool sanitization with 3 inch tablets, Option A}

POOL SANITIZATION WITH 3 INCH TABLETS

[WHY TO USE THIS PRODUCT: For use in feeders and floaters, this multifunctional sanitizer kills bacteria and controls algae. This sanitizer will last longer compared to chlorine products such as liquid bleach or calcium hypochlorite, as it contains [SUNSHIELD[®], which protects chlorine from sunlight, so you use less.] *{or}* [sunlight protected chlorine.] It's the perfect solution for clear, inviting pool water.]

{or}

[WHY USE THIS PRODUCT: [3 Inch Tabs] *{or}* [This product], the [compound action] tablet that does more:

- Kills bacteria
- [Kills] [Controls] algae
- [Clarifies] [With Claifier]
- [Enhances filtration]

[3 Inch Tabs] *{or}* [This product] also contains [SUNSHIELD[®], which protects chlorine from sunlight, so you use less.] *{or}* [sunlight protected chlorine.]

{or}

[WHY TO USE THIS PRODUCT: This product kills bacteria [and controls algae] in swimming pools.]

IMPORTANT NOTES:

1. Shock your pool every week and also after heavy rain or heavy use to help keep your pool water properly maintained.
2. Sunlight, rainfall, temperature, number of swimmers, and frequency of pool use affect the rate of chlorine residual loss. Adjust cleaning and chemical maintenance accordingly.
3. Use this product in an automatic feeder, floater, or skimmer designed for this product.
4. Do not add other chemicals into the feeder, floater, or skimmer where this product is in use as a fire or explosion may occur. Use this product in a skimmer only if the skimmer and the piping between skimmer and pump are plastic. In vinyl pools, do not leave the pump turned off for more than 8 hours when this product is in the skimmer. If the pump is off for more than 8 hours, bleaching and damage to liner may occur.
5. To avoid damage to pool surface or materials do not allow product to come in direct contact with these materials. Do not throw tablets directly into pool.

DIRECTIONS FOR USE:

It is a violation of Federal Law to use this product in any manner inconsistent with its labeling. Read entire label and use strictly in accordance with precautionary statements and directions.

BEFORE YOU BEGIN:

1. Ensure all pool equipment is working properly. Adjust stabilizer levels to 40-50 PPM with stabilizer.
2. Test the water's pH, alkalinity, and calcium hardness and adjust to the correct level. Adjust pH to 7.2-7.6. Adjust alkalinity to 80-125 PPM for plaster pools and 125-150 for vinyl or fiberglass pools. Adjust calcium hardness to 200-275 PPM for plaster pools, 175-225 for vinyl or fiberglass pools. Be sure to follow label directions when using other products as outlined in directions for this product.
3. Check the free available chlorine level and adjust to 1-4 PPM by adding a granular chlorinating product.

NOW USE THIS PRODUCT**START-UP/INITIAL TREATMENT:**

1. If water is cloudy or green, superchlorinate pool with appropriate shock product until pool is clear.
2. If using a feeder or floater, add 16 ounces of this product (two tablets) per 10,000 gallons of pool water to feeder or floater and then test for the free available chlorine level (allow water to circulate at least 4 hours before testing). Adjust the feeder or floater following manufacturer's instructions to establish a free available chlorine level between 1-4 PPM.
3. If using a plastic skimmer, add 16 ounces of this product (two tablets) per 10,000 gallons of pool water and test for the free available chlorine level (allow water to circulate at least 4 hours before testing), adding more tablets as necessary to establish a free available chlorine level of 1-4 PPM.
4. When free available chlorine level is adjusted to 1-4 ppm, add the [algicide] *{or}* [algaecide] appropriate to your needs.

ROUTINE MAINTENANCE:

Add 16 ounces of this product (two tablets) per 10,000 gallons of pool water per week, or as often as needed, to the floater, feeder or skimmer to maintain a constant free available chlorine level of 1-4 PPM. Sunlight, rainfall, temperature, number of swimmers, and frequency of pool use affect the rate of chlorine residual loss so check the floater, feeder or skimmer often and refill as needed.

Reentry into treated swimming pools is prohibited when free available chlorine levels are above 4 PPM due to risk of body injury.

{Directions to be used for pool sanitization with 3 inch tablets, Option B}

[How?]

DIRECTIONS FOR USE:

It is a violation of Federal Law to use this product in any manner inconsistent with its labeling. Read entire label and use strictly in accordance with precautionary statements and directions.

To Keep Water Clean:

- Test and balance water before using this product. Visit [the Clorox Pool&Spa Site] {or} [www.cloroxpool.com] {or} [the Pool Essentials site] {or} [www.pool essentials.com] {or} [the Aqua Chem Web Site] {or} [www.aquachem.com] {or} [the Pool Time website] {or} [www.pooltime.com] {or} [the Brand Name website] {or} [www.brandname.com] for complete pool balancing instructions.
- If the pool is cloudy or green, add a granular shock product; follow application directions on that product.
- **Feeder/Floater:** Add tabs to an appropriate feeder or floater to bring chlorine level to 1-4 ppm; refill as needed to maintain 1-4 ppm.
- **Skimmer:** Add [two tabs per 10,000 gallons] {or} [one tab per 5,000 gallons] of pool water to bring chlorine level to 1-4 ppm. Add additional product as needed to maintain 1-4 ppm.
- When chlorine level is adjusted to 1-4 ppm, add the [algicide] {or} [algaecide] appropriate to your needs.
- Do not add other chemicals through the feeder when using this product as an explosion might occur.
- Direct contact with pool surface or equipment may cause damage; do not add directly to the pool.
- Apply more product after heavy use, high temperatures, or rain. To keep water clear, shock pool on a weekly basis.

Reentry into treated swimming pools is prohibited above levels of 4 ppm chlorine due to risk of body injury.

{Directions to be used for pool sanitization with 3 inch tablets, Option C}

DIRECTIONS FOR USE:

It is a violation of Federal Law to use this product in any manner inconsistent with its labeling. Read entire label and use strictly in accordance with precautionary statements and directions.

Test and balance water prior to use. Adjust pH to 7.2-7.6 [and free chlorine to 1-4ppm].

Visit [website] for [free water analysis] [&] [personalized product and dosage recommendations].

Use: Protects against algae and bacteria for water that stays clean, clear & free of visible algae.

| Application Methods | |
|--|---|
| If water is cloudy or green, add a granular shock product per label directions. | |
| Feeder & Floater | Fill with [tabs] [tablets] and adjust output to bring chlorine to 1-4 ppm, test and refill as needed to maintain 1-4 ppm. |
| Skimmer | Add [2 [tabs] [tablets] per 10,000 gallons] <i>{or}</i> [1 [tab] [tablet] per 5,000 gallons] to bring chlorine to 1-4 ppm then add more tabs as needed to maintain 1-4 ppm. |
| Do Not apply other chemicals through feeder as an explosion might occur. Direct contact with pool surfaces or equipment may cause damage. | |

For best results: Add more product after heavy pool use, high temperatures or rain to maintain 1-4 ppm.

Re-entry into treated swimming pools is prohibited above levels of 4ppm chlorine due to risk of body injury.

{Directions to be used for pool sanitization with sticks}

POOL SANITIZATION WITH STICKS

[WHY TO USE THIS PRODUCT: For use in feeders, floaters, and skimmers, this multifunctional sanitizer kills bacteria and controls algae. This sanitizer will last longer compared to chlorine products such as liquid bleach or calcium hypochlorite, as it contains [SUNSHIELD[®], which protects chlorine from sunlight, so you use less.] *{or}* [sunlight protected chlorine.] It's the perfect solution for clear, inviting pool water.]

{or}

[WHY USE THIS PRODUCT: [These Sticks] *{or}* [This product], the [compound action] stick

- Kills bacteria
- [Kills] [Controls] algae
- [Clarifies] [With Claifier]
- [Enhances filtration]

[3 Inch Tabs] *{or}* [This product] also contains [SUNSHIELD[®], which protects chlorine from sunlight, so you use less.] *{or}* [sunlight protected chlorine.]

{or}

[WHY TO USE THIS PRODUCT: This product kills bacteria [and controls algae] in swimming pools.]

IMPORTANT NOTES:

1. Shock your pool every week and also after heavy rain or heavy use to help keep your pool water properly maintained.
2. Sunlight, rainfall, temperature, number of swimmers, and frequency of pool use affect the rate of chlorine residual loss. Adjust cleaning and chemical maintenance accordingly.
3. Use this product in an automatic feeder, floater, or skimmer designed for this product.
4. Do not add other chemicals into the feeder, floater, or skimmer where this product is in use as a fire or explosion may occur. Use this product in a skimmer only if the skimmer and the piping between skimmer and pump are plastic. In vinyl pools, do not leave the pump turned off for more than 8 hours when this product is in the skimmer. If the pump is off for more than 8 hours, bleaching and damage to liner may occur.
5. To avoid damage to pool surface or materials do not allow product to come in direct contact with these materials. Do not throw sticks directly into pool.

DIRECTIONS FOR USE:

It is a violation of Federal Law to use this product in any manner inconsistent with its labeling. Read entire label and use strictly in accordance with precautionary statements and directions.

BEFORE YOU BEGIN:

1. Ensure all pool equipment is working properly. Adjust stabilizer levels to 40-50 PPM with stabilizer.
2. Test the water's pH, alkalinity, and calcium hardness and adjust to the correct level. Adjust pH to 7.2-7.6. Adjust alkalinity to 80-125 PPM for plaster pools and 125-150 for vinyl or fiberglass pools. Adjust calcium hardness to 200-275 PPM for plaster pools, 175-225 for vinyl or fiberglass pools. Be sure to follow label directions when using other products as outlined in directions for this product.
3. Check the free available chlorine level and adjust to 1-4 PPM by adding a granular chlorinating product.

NOW USE THIS PRODUCT

START-UP/INITIAL TREATMENT:

1. If water is cloudy or green, superchlorinate pool with appropriate shock product until pool is clear.
2. If using a feeder or floater, add 16 ounces of this product (two sticks) per 10,000 gallons of pool water to feeder or floater and then test for the free available chlorine level (allow water to circulate at least 4 hours before testing). Adjust the feeder or floater following manufacturer's instructions to establish a free available chlorine level between 1-4 PPM.
3. If using a plastic skimmer, add 16 ounces of this product (two sticks) per 10,000 gallons of pool water and test for the free available chlorine level (allow water to circulate at least 4 hours before testing), adding more sticks as necessary to establish a free available chlorine level of 1-4 PPM.
4. When free available chlorine level is adjusted to 1-4 ppm, add the [algicide] *{or}* [algaecide] appropriate to your needs.

ROUTINE MAINTENANCE:

Add 16 ounces of this product (two sticks) per 10,000 gallons of pool water per week, or as often as needed, to the floater, feeder or skimmer to maintain a constant free available chlorine level of 1-4 PPM. Sunlight, rainfall, temperature, number of swimmers, and frequency of pool use affect the rate of chlorine residual loss so check the floater, feeder or skimmer often and refill as needed.

Reentry into treated swimming pools is prohibited when free available chlorine levels are above 4 PPM due to risk of body injury.

{Directions to be used for pool floater sanitization, Option A}

POOL FLOATER SANITIZATION

[WHY TO USE THIS PRODUCT]: This disposable floating dispenser sanitizes the water and then tips on its side when empty. The multifunctional sanitizer kills bacteria and controls algae, and will last longer compared to chlorine products such as liquid bleach or calcium hypochlorite, as it contains [SUNSHIELD[®], which protects chlorine from sunlight, so you use less.] *{or}* [sunlight protected chlorine.] It's the perfect solution for clear, inviting pool water.

{or}

[WHY TO USE THIS PRODUCT: This product kills bacteria [and controls algae] in swimming pools.]

IMPORTANT NOTES:

1. When using other products, as outlined in directions for this product, always follow label directions for those products.
2. Sunlight, rainfall, temperature, number of swimmers and frequency of pool use affect the rate of available chlorine loss. Adjust cleaning and chemical maintenance accordingly. To destroy undesirable compounds, shock pool on a regular basis, typically every 1 to 2 weeks or each time floater is replaced.
3. During shock treatment, remove floater from pool. Place floater in an empty, clean, dry plastic container. Place it back in pool when the process is completed.
4. Do not completely submerge floater or allow holes to become clogged. This could trap excess amount of chlorine gas possibly resulting in a violent explosion.
5. Do not attempt to open or refill this product.

DIRECTIONS FOR USE:

It is a violation of Federal Law to use this product in a manner inconsistent with its labeling. Read entire label directions and use strictly in accordance with precautionary statements and directions.

BEFORE YOU BEGIN:

1. Ensure all pool equipment is working properly. Backwash filter following manufacturer's directions.
2. Adjust stabilizer levels to 40-50 ppm with [Stabilizer] [Chlorine Stabilizer]. Check residual chlorine level with a test kit. Adjust to 1-4 ppm by adding a stabilized granular chlorinator.
3. Check water pH, alkalinity and calcium hardness with a test kit. Adjust pH to 7.2 - 7.6 by adding [pH Down] [pH Decreaser] to lower pH, or by adding [pH Up] [pH Add] to raise pH. Adjust alkalinity to 80 - 125 ppm for plaster pools, 125 - 150 for vinyl or fiberglass pools by adding [Alkalinity Increaser] [Alkalinity Plus]. Adjust calcium hardness to 200 - 275 ppm for plaster pools, 175 - 225 for vinyl or fiberglass pools by adding Calcium Hardness Increaser. Be sure to follow label directions.

NOW USE THIS PRODUCT:

1. Floater is marked in gallon increments from 5,000 to 40,000 gallons. To use, cut off all feeder nubs on both sides of cartridge up to and including the one corresponding to your pool's size. If pool is between sizes marked, open next higher nubs. Use a sharp knife and cut in direction away from your body and limbs. (Fig. A) Make certain holes are wide open to allow water to flow through freely.
2. Place floater with open holes in center of the pool. (Fig. B) After 24 hours check residual chlorine level with a test kit. If residual chlorine level is below 1.0 ppm cut-off one additional nub until chlorine stabilizes at 1-4 ppm. If the residual chlorine is too high, seal one set of holes with waterproof plastic tape.
3. When ready for replacement, this product will float on its side. (Fig. C)

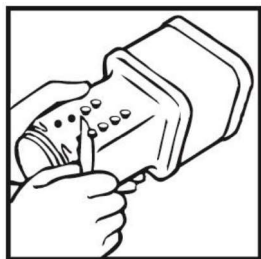

FIG. A

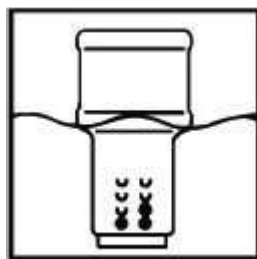

FIG. B

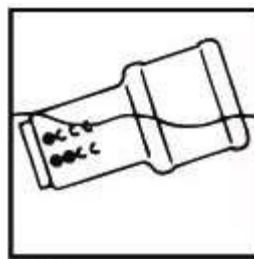

FIG. C

Reentry into treated swimming pools is prohibited when free available chlorine levels are above 4 PPM due to risk of body injury.

{Directions to be used for pool floater sanitization, Option B}

[How?]

DIRECTIONS FOR USE:

It is a violation of Federal Law to use this product in any manner inconsistent with its labeling. Read entire label and use strictly in accordance with precautionary statements and directions.

To Keep Water Clean:

- Test and balance water before using this product. Visit [the Clorox Pool&Spa Site] {or} [www.cloroxpool.com] {or} [the Pool Essentials site] {or} [www.pool essentials.com] {or} [the Aqua Chem Web Site] {or} [www.aquachem.com] {or} [the Pool Time website] {or} [www.pooltime.com] {or} [the Brand Name website] {or} [www.brandname.com] for complete pool balancing instructions.
- Cut off all feeder nubs on both sides of cartridge up to and including the pool volume. If pool is between sizes marked, open next higher nubs. Use a sharp knife and cut in direction away from your body. (Fig. A). Make certain holes are wide open to allow water to flow through freely.
- Place floater with open holes in the pool. (Fig. B) After 24 hours, if chlorine level is below 1.0 ppm cut-off one additional nub until chlorine level is 1-4 ppm. If the chlorine level is above 4 ppm, seal one set of holes with waterproof plastic tape.
- This product floats on side when empty. (Fig. C)
- To keep water clear, shock pool on a weekly basis or after heavy use, high temperatures, or rain.
- During shock treatment, remove floater from pool. Place floater in an empty, clean, dry plastic container. Place floater back in pool when the process is completed.
- Do not completely submerge floater or allow holes to become clogged. This could trap excess amount of chlorine gas possibly resulting in a violent explosion.
- Do not attempt to open or refill this product.

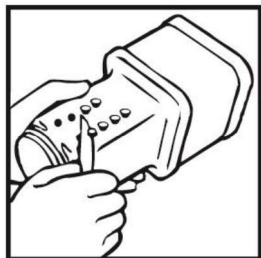

FIG. A

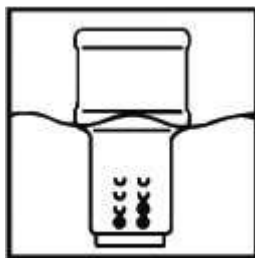

FIG. B

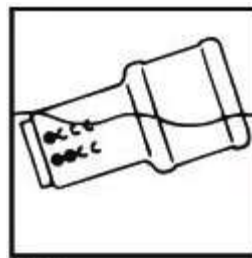

FIG. C

Reentry into treated swimming pools is prohibited above levels of 4 ppm chlorine due to risk of body injury.

{Directions for E-Z Clor Feeder Canister and Type E Canister, Option A}

SWIMMING POOL SANITIZER FOR USE IN E-Z CLOR® FEEDER

This multifunctional sanitizer when used as directed kills bacteria and controls algae, and will last longer compared to chlorine products such as liquid bleach or calcium hypochlorite, as it contains [SUNSHIELD®, which protects chlorine from sunlight, so you use less.] *{or}* [sunlight protected chlorine.] This product is not a floating device and is only to be used with automatic chlorinating systems such as a refill for automatic chlorinating systems using the Type "E" refill cartridge.

{or}

[WHY TO USE THIS PRODUCT: This product kills bacteria [and controls algae] in swimming pools.]

DIRECTIONS FOR USE:

It is a violation of federal law to use this product in any manner inconsistent with its labeling. Read entire label and use strictly in accordance with precautionary statements and directions.

Ensure all pool equipment is working properly. Backwash the filter system following manufacturer's directions. Adjust pH to between 7.2-7.6. Add stabilizer to establish a minimum stabilizer level of 40-50 ppm to reduce the degradative effects of sunlight upon the chlorine residual. Superchlorinate the pool so that a chlorine residual of between 1-4 ppm is obtained. When using other products as outlined in directions for this product, always follow directions on those products. Do not attempt to open or refill this cartridge.

1. Select a large nail, sharp knife or similar tool to punch out dimples per step #2. Place cartridge on a solid surface and work carefully to avoid injury.
2. Punch out appropriate dimples on both of the upper sides of cartridge according to the chart below based on the size of your pool:

| Gallons of pool water: | Dimples to punch: |
|------------------------|-----------------------------|
| 5,000 | 1 |
| 10,000 | 1, 2, & 3 |
| 15,000 | 1, 2, 3, 4, & 5 |
| 20,000 | 1, 2, 3, 4, 5, 6, & 7 |
| 30,000 | 1, 2, 3, 4, 5, 6, 7, 8, & 9 |

Example: 15,000 gallon pool. Punch out dimples numbered 1, 2, 3, 4 and 5. See diagram:

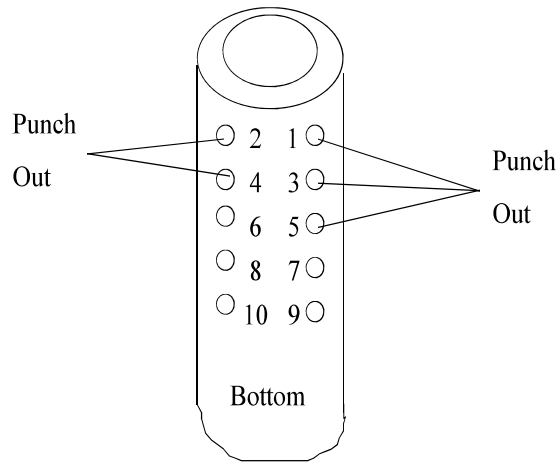

3. Punch out all eight (8) clear dots on top of cap.
4. Turn cartridge upside down and place into chlorinator. Follow equipment manufacturer's directions for installation of the Type "E" cartridge.
5. After the cartridge has been in use for 24 hours, check the chlorine level of the water with a test kit or test strips. The correct chlorine level range is 1-4 ppm. If level is below 1 ppm, punch out next higher number. If level is above 4 ppm, cover highest hole with water proof tape. Make additional adjustments as required to maintain a 1-4 ppm chlorine residual.

Reentry into treated swimming pools is prohibited above levels of 4 ppm chlorine due to risk of body injury.

{Directions for E-Z Clor Feeder Canister and Type E Canister, Option B}

SWIMMING POOL SANITIZER FOR USE IN E-Z CLOR® FEEDER

This multifunctional sanitizer with when used as directed kills bacteria and controls algae, and will last longer compared to chlorine products such as liquid bleach or calcium hypochlorite, as it contains [SUNSHIELD®, which protects chlorine from sunlight, so you use less.] *{or}* [sunlight protected chlorine.] This product is not a floating device and is only to be used with automatic chlorinating systems such as a refill for automatic chlorinating systems using the Type "E" refill cartridge.

{or}

[WHY TO USE THIS PRODUCT: This product kills bacteria [and controls algae] in swimming pools.]

DIRECTIONS FOR USE:

It is a violation of federal law to use this product in any manner inconsistent with its labeling. Read entire label and use strictly in accordance with precautionary statements and directions.

BEFORE APPLYING PRODUCT:

First, ensure all pool equipment is working properly, then backwash the filter system following manufacturer's directions. Next adjust pH to between 7.2-7.6. Then add stabilizer to establish a minimum stabilizer level of 40-50 ppm to reduce the degradative effects of sunlight upon the chlorine residual. Next, superchlorinate the pool so that a chlorine residual of between 1-4 ppm is obtained. When using other products as outlined in directions for this product, always follow directions on those products.

Note: Do not attempt to open or refill this cartridge.

1. Select a large nail, sharp knife or similar tool to punch out dimples per step #2. Place cartridge on a solid surface and work carefully to avoid injury.
2. Punch out appropriate dimples on both of the upper sides of cartridge according to the chart below based on the volume of your pool:

| Gallons of pool water: | Dimples to punch: |
|------------------------|-----------------------------|
| 5,000 | 1 |
| 10,000 | 1, 2, & 3 |
| 15,000 | 1, 2, 3, 4, & 5 |
| 20,000 | 1, 2, 3, 4, 5, 6, & 7 |
| 30,000 | 1, 2, 3, 4, 5, 6, 7, 8, & 9 |

Example: 15,000 gallon pool. Punch out dimples numbered 1, 2, 3, 4 and 5. See diagram:

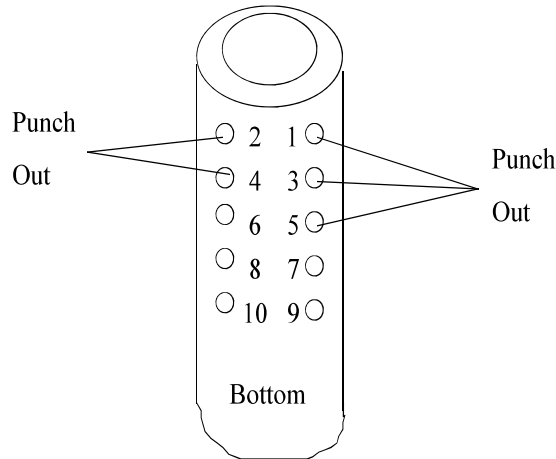

3. Punch out all eight (8) clear dots on top of cap.
4. Turn cartridge upside down and place into chlorinator. Follow equipment manufacturer's directions for installation of the Type "E" cartridge.
5. After the cartridge has been in use for 24 hours, check the chlorine level of the water with a test kit or test strips. The correct chlorine level range is 1-4 ppm. If level is below 1 ppm, punch out next higher number. If level is above 4 ppm, cover highest hole with water proof tape. Make additional adjustments as required to maintain a 1-4 ppm chlorine residual.

Reentry into treated swimming pools is prohibited above levels of 4 ppm chlorine due to risk of body injury.

{Directions to be used with Dial Adjusted Pool Floater.}

SWIMMING POOL SANITIZER

{Optional marketing paragraph A}

[[T-0047] *{or}* [This product] contains tablets featuring our [proprietary] [unique] blend that provides [5-in-1] [4-in-1] [multi-action] [sanitation], [algae prevention], [sunlight protection], [and] [clarification]. [T-0047] *{or}* [This product] releases this formula continuously for clean, clear water.]

[[T-0047] *{or}* [This product] keeps water clean with less effort and no handling of chlorinating tablets. Simply rotate the [flow-control ring] [adjustable ring] [adjustable dial] [flow control dial] to correspond to your pool size and place the floater in the water for [5-in-1] [4-in-1] sanitation for up to [[1] [one] month]] [[4] [four] weeks].]

{Optional marketing paragraph B}

[[No matter what type of pool you own there is a T-0047 solution for you.] This ready-to-use floater with [flow-control ring] [adjustable ring] [adjustable dial] [flow control dial] and [multifunctional] [multi-action] [5-in-1] [4-in-1] formula makes pool care easy. Simply adjust the [dial] [ring] to your pool size and place it in the pool for [clean] [and] [&] [crystal clear] water for up to [[1] [one] month]] [[4] [four] weeks].]

[Each tablet contains a [proprietary] [unique] blend that provides [5-in-1] [4-in-1] [multi-action] [sanitation], [algae prevention], [sunlight protection], [and] [clarification].]

[By using [T-0047] *{or}* [this product] you:

- [Spend less time applying products]
- [Save money by using fewer products]
- [Have less maintenance steps]
- [Avoid handling chlorinating tablets]]

DIRECTIONS FOR USE:

It is a violation of federal law to use this product in any manner inconsistent with its labeling. Read entire label and use strictly in accordance with precautionary statements and directions.

[Step 1:] [1.]

{Option A}

Before use, adjust water balance levels to the following:

| Water Balance Levels | |
|----------------------|-------------|
| pH | 7.2 – 7.6 |
| Stabilizer | 30 – 40 ppm |
| Chlorine residual | 1– 4 ppm |

{Option B}

[Test and balance water before using this product. Adjust pH to 7.2 – 7.6, stabilizer to 30 – 40 ppm, and make sure the pool has a chlorine residual between 1 – 4 ppm.]

[Step 2:] [2.]

{Option A}

[Adjust the [flow-control ring] [adjustable ring] [adjustable dial] [flow control dial] to pool size:

S: ≤ 7,500 gallons

M: ≤ 10,000 gallons

L: ≤ 13,000 gallons]

{Option B}

[[Set] [Adjust] the [flow-control ring] [adjustable ring] [adjustable dial] [flow control dial] to [medium] [middle] [mid-range] setting.]

[Step 3:] [3.] Place floater in pool and hold upright until it fills with water. Then leave to float.

[Step 4:] [4.] After 24 hrs, check the chlorine level to ensure 1 – 4 ppm is maintained.

{Option A}

- If below 1 ppm, adjust the [flow-control ring] [adjustable ring] [adjustable dial] [flow control dial] to a [larger pool size] [higher setting].
- If above 4 ppm, adjust the [flow-control ring] [adjustable ring] [adjustable dial] [flow control dial] to a [smaller pool size] [lower setting].

{Option B}

| Chlorine Residual | [flow-control ring] [ring] [dial] [flow control dial] Setting |
|-------------------|---|
| < 1 ppm | Adjust to [larger pool size] [higher setting] |
| > 4 ppm | Adjust to [smaller pool size] [lower setting] |

{Optional Step 5 only}

[[Step 5:] [5.] Replace when floater [has tipped on its side] [is empty].]

{Optional Step 5 & 6}

[[Step 5:] [5.] After 48 hrs, if chlorine residual is <1 ppm, add another floater to pool. Wait 24 hrs and retest chlorine [as needed].]

[[Step 6:] [6.] Replace when the floater [has tipped on its side] [is empty].]

Note:

- Hot weather, heavy pool usage or rain may require the [flow-control ring] [adjustable ring] [adjustable dial] [flow control dial] [ring] [dial] to be adjusted to a larger pool size.
- Shock pool water weekly. During shock treatment, remove floater from pool and drain. Place floater in an empty, clean, dry plastic container in a location inaccessible to children and pets. Place floater back in pool when the process is completed.
- Do not completely submerge floater or allow holes to become clogged. This could trap an excess amount of chlorine gas possibly resulting in a violent explosion.
- Do not attempt to open or refill this product.

Reentry into treated swimming pools is prohibited above levels of 4 ppm chlorine due to risk of body injury.

STORAGE AND DISPOSAL: Keep this product dry in original tightly closed container when not in use. Store in a cool, dry, well ventilated area away from heat or open flame. Moisture may decompose this product and cause a violent reaction leading to fire and explosion. In case of decomposition, isolate container if possible and flood area with large amounts of water to dissolve all material before discarding this container. Do not contaminate food or feed by storage or disposal. **CONTAINER DISPOSAL:** Non-refillable container. Do not reuse or refill this container. Offer for recycling if available. Rinse thoroughly before recycling or discarding in trash.

PRECAUTIONARY STATEMENTS:

HAZARDS TO HUMANS AND DOMESTIC ANIMALS: DANGER: Corrosive: Causes irreversible eye damage and skin burns. Harmful if swallowed, inhaled, or absorbed through skin. Do not get in eyes, on skin or on clothing. Avoid breathing dust or fumes. Irritating to nose and throat. Wear goggles or safety glasses, protective clothing and rubber gloves when handling this product. Wash thoroughly with soap and water after handling and before eating, drinking, chewing gum, using tobacco or using the toilet. Remove and wash contaminated clothing before reuse.

{When First Aid is not located on front panel of label, it will be separated by line rules from adjacent text and be in a different color.}

FIRST AID: IF IN EYES: Hold eye open and rinse slowly and gently with water for 15-20 minutes. Remove contact lenses, if present, after the first 5 minutes, then continue rinsing eye. Call a poison control center or doctor for treatment advice. **IF ON SKIN OR CLOTHING:** Take off contaminated clothing. Rinse skin immediately with plenty of water for 15-20 minutes. Call a poison control center or doctor for treatment advice. **IF INHALED:** Move person to fresh air. If person is not breathing, call 911 or an ambulance, then give artificial respiration, preferably mouth-to-mouth, if possible. Call poison control center or doctor for treatment advice. **IF SWALLOWED:** Call poison control center or doctor immediately for treatment advice. Have person sip a glass of water if able to swallow. Do not induce vomiting unless told to do so by the poison control center or doctor. Do not give anything by mouth to an unconscious person.

Have the product container or label with you when calling a poison control center or doctor, or going for treatment. [IN CASE OF MEDICAL EMERGENCY, CALL [1-303-623-5716] [1-877-800-5553] [1-866-366-5048] [telephone number supplied by supplemental registrant].]

Note to Physician: Probable mucosal damage may contraindicate the use of gastric lavage.

PHYSICAL OR CHEMICAL HAZARDS: CONTAINS A STRONG OXIDIZING AGENT. Do not mix with other chemicals. Mix only with water. Never add water to product. Always add product to large quantities of water. When using automatic feeding devices, always follow manufacturer's directions as to the proper addition of sanitizer product to chlorinators. Use clean dry utensils. Do not add this product to any dispensing device containing remnants of any other product. Such use may cause a violent reaction leading to fire or explosion. Contamination with moisture, organic matter, or other chemicals will start a chemical reaction and generate heat, hazardous gas, possible fire and explosion. In case of contamination or decomposition, do not reseal container. If possible, isolate container in open air or well-ventilated area. Flood area with large volumes of water.

{Environmental hazards statement for end-use products in containers of less than 50 pounds (solid, dry weight).}

[ENVIRONMENTAL HAZARDS: This pesticide is toxic to fish and aquatic organisms.]

{Environmental hazards statement for end-use products in containers equal to or greater than 50 pounds (solid, dry weight).}

[ENVIRONMENTAL HAZARDS: This pesticide is toxic to fish and aquatic organisms. Do not discharge effluent containing this product into lakes, streams, ponds, estuaries, oceans or other waters unless in accordance with the requirements of a National Pollutant Discharge Elimination System (NPDES) permit and the permitting authority has been notified in writing prior to discharge. Do not discharge effluent containing this product to sewer systems without previously notifying the local sewage treatment plant authority. For guidance contact your State Water Board or Regional Office of the EPA.]

[NOTE: Buyer assumes all responsibility for safety and use not in accordance with directions.]

[NOTE: User assumes all responsibility for use not in accordance with directions.]

{The following is optional text to be used at Recreational Water Products' discretion with swimming pool use directions. This information is non-essential and will be provided only as a courtesy. Will not appear on all swimming pool products.}

HOW TO CALCULATE POOL CAPACITY

| Shape of Pool | Gallons of water |
|---------------|--|
| Rectangular | Average depth x average length x average width x 7.5 |
| Circular | Diameter x diameter x average depth x 5.9 |
| Oval | Full width x full length x average depth x 5.9 |
| Irregular | Consult pool builder |

{The following is optional text to be used at Recreational Water Products' discretion. This information is non-essential and will be provided only as a courtesy. Will not appear on all labels.}

[NOTE: Any questions or comments about Aqua Chem Products? In the continental U.S. call 1-800-252-POOL (7665). Ask for your free pool care booklet.]

[Questions or comments, Call 1-800-252-POOL (7665).]
 [[Questions?] [Pool Care Tips?] [1-800-SOS-POOL]]

- [Visit the Aqua Chem website at www.aquachem.com]
- [Visit the PoolTime website at www.pooltime.com]
- [Visit the Clorox Pool & Spa website at www.cloroxpool.com]
- [Visit the Pool Essentials website at www.poolessentials.com]
- [Visit the Brand Name website at www.brandname.com]

{Optional Graphics}



4-Step System ① ② ③ ④

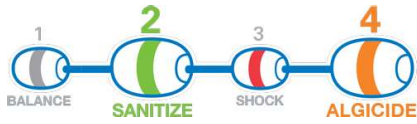

⚠ WARNING
⚠ AVISO

Children can fall into bucket and drown. Keep children away from bucket with even a small amount of liquid.

Los niños pueden caer dentro de el balde y ahogarse. Mantenga a los niños alejados de los baldes aunque solo contengan un poco de liquido.







pool time.

Expert results begin with water testing.

STEP 1 **TEST**

Start Here

TEST

DOWNLOAD THE FREE **CLEARPOOL EXPERT™ APP**

Available on the App Store | Get it on Googleplay



MY POOL CARE ASSISTANT™
Anytime, Anywhere Solutions

TEST YOUR POOL USING THE **"CLOROX® POOL" APP**

Use **Multi-Use Smart Strips™**
or now with the 3-Way Test Kit

{Optional: Text that may be included on Kit Label if this product is sold in a kit with other products.}

{For kits that treat pools 5,000 gallons or less.}

[[Brandname] Small Pool [easy] [care] [start-up] [maintenance] [start-up & maintenance] kit]
[[Brandname] Pop-up Pool [easy] [care] [start-up] [maintenance] [start-up & maintenance] kit]
[[Brandname] Inflatable Pool [easy] [care] [start-up] [maintenance] [start-up & maintenance] kit]
[[Brandname] [Small] [Pop-Up] [Inflatable] [Pool] [water] [easy] [care] [start-up] [maintenance]
[start-up & maintenance] kit]

[For small pools]
[Treats up to 5,000 gallons.]

[[Kit] contains:

- [[X] lb of (insert ABN or supplemental for EPA Reg. No. 67262-27, shock product name)]
- [[X] lb of (insert ABN or supplemental for EPA Reg. No. 67262-1, shock product name)]
- [[X] lb of (insert ABN or supplemental for EPA Reg. No. 67262-XX, [T-0047] 1" tablet product name)]
- [6-way test strips] [Smart Strips] [Multi-use Smart Strips™]
- [[small] [above ground] [pop-up] [inflatable] Pool Care Guide]

[Use only with pools that have a water re-circulating system (pump) & filter.]

{Front of Pool Care Card}

[[Small] Pool Care Guide]
[[Kit Product Name]]

[Quick start up tips

1. Start the pool equipment following manufacturer's directions. Circulate pool water with the pump on for 1-2 hours.
2. Test [and] [&] balance water using (test strip product name) provide in kit.
3. Apply [X] teaspoons (shock product name) per [X] gallons and circulate for 1-2 hrs.
4. Re-test Free Chlorine level to ensure it is between 1-4 ppm*.
5. Fill an appropriate floater or feeder with (1" tablet product name) and adjust output to bring chlorine to 1-4 ppm, test and refill as needed to maintain 1-4ppm.

{Note: Both "X" in step 3 above to match application rate on FIFRA label for shock product.}

* Entry into treated swimming pools is prohibited above levels of 4 ppm chlorine due to risk of bodily injury.

For these products and any other products, please refer to the label directions for more detail on application, storage and handling instructions. Always use a designated, clean [spoon] [scoop] that is kept out of reach of children for each chemical addition.]

{Back of Pool Care Card}

[Weekly Pool [maintenance] [Care]

- Test your water twice a week [and] [&] enter results [in our free online water analysis (website)] [online at (website)] [or use the “Clorox Pool” app] for personalized product and dosage recommendations.
- [Maintain a free chlorine residual of 1-4 ppm at all times.] {or} [Maintain 1-4 ppm of Free Chlorine at all times]
- Shock weekly [and] [&] apply more product after heavy use, high temperatures or rain.
- Brush & vacuum your pool weekly.]

[Test Pool Water Using Multi-Use Smart Strips™:

Step 1: Register a My Pool Care Assistant™ account at cloroxpool.com or on the “Clorox Pool” app [and receive \$5 off your next purchase].

Step 2: Dip one Smart Strip™ into pool water at elbow’s depth, remove immediately, then shake once to remove excess water.

Step 3: Hold the Smart Strip™ level and find test results, either:

- Online at cloroxpool.com
- Using the “Clorox Pool” app
- Manually using the 6-way test chart]]

[Water testing frequency]

| Test | Frequency | Pool Type | Ideal Range |
|------------------|----------------------|------------------|-----------------------------|
| pH | Twice weekly | All | 7.2 - 7.6 |
| Free Chlorine | Twice weekly | All | 1- 4 ppm |
| Total Alkalinity | Monthly | Plaster Vinyl | 80 -125 ppm 125 -150 ppm |
| Stabilizer | 2-3 times per season | All | Minimum of 30ppm |
| Calcium Hardness | 2-3 times per season | All | 175 - 225 ppm |



**To open the lid
(after the tear strip is removed)**

Step-1

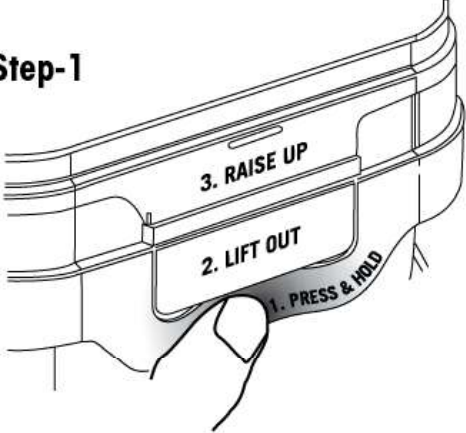

Step-2

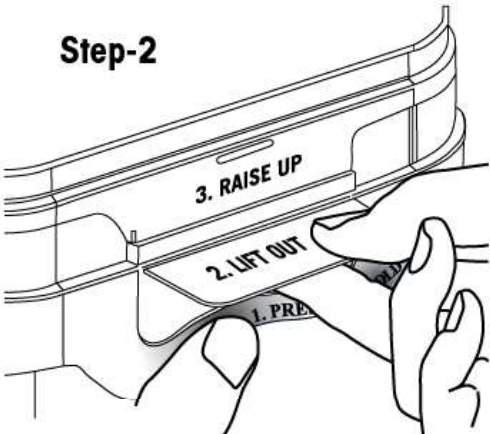

Step-3

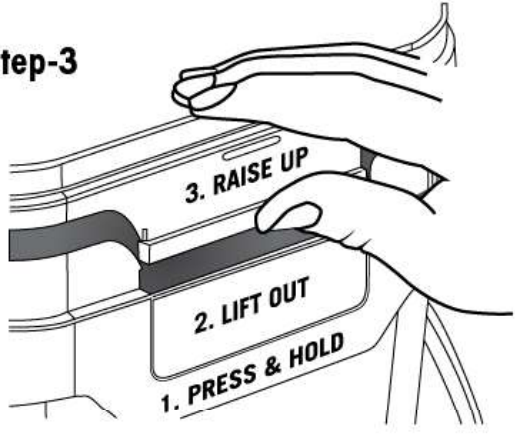

Do not store in direct sunlight

Tamper Evident Tear Strip
Tear away by using "ring pull" on either side of lid

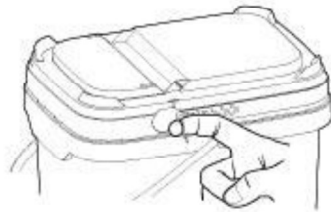

To open the lid (after the tear strip is removed)

Step-1

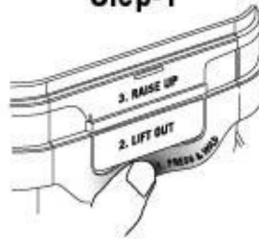

Step-2

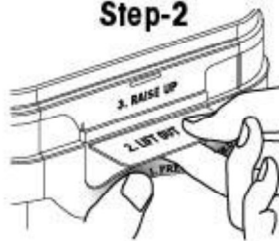

Step-3



{Optional Graphics}

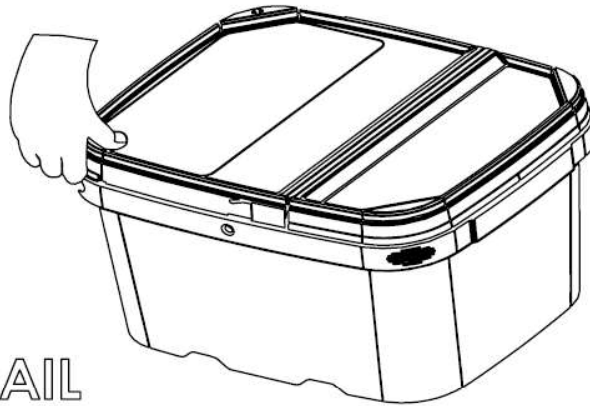

TO OPEN:
PRESS IN PAIL
CORNER AND
LIFT LID

TO CLOSE:
SNAP DOWN
LID CORNERS
AND SIDES

{Optional Graphics}



pool time.

Expert results begin with water testing.

DOWNLOAD THE FREE CLEARPOOL EXPERT™ APP

Download on the App Store | GET IT ON Google Play

The image shows a hand holding a smartphone displaying the 'Water Test' interface of the Clearpool Expert app. The interface includes color-coded charts for Total Hardness, Total Chlorine, Free Chlorine, pH, Total Alkalinity, and Stabilizer.



CLOROX
Pool & Spa

Download the **FREE** Clorox® Pool App

Water Testing & Solution Center

The image shows a hand holding a smartphone displaying the Clorox Pool & Spa app interface. The background features the Clorox logo and the text 'Pool & Spa'. The app interface on the phone shows a menu with options like 'Pool & Spa App', 'Water Testing', and 'Solution Center'. A pool noodle is visible in the background.

{Optional Graphics}

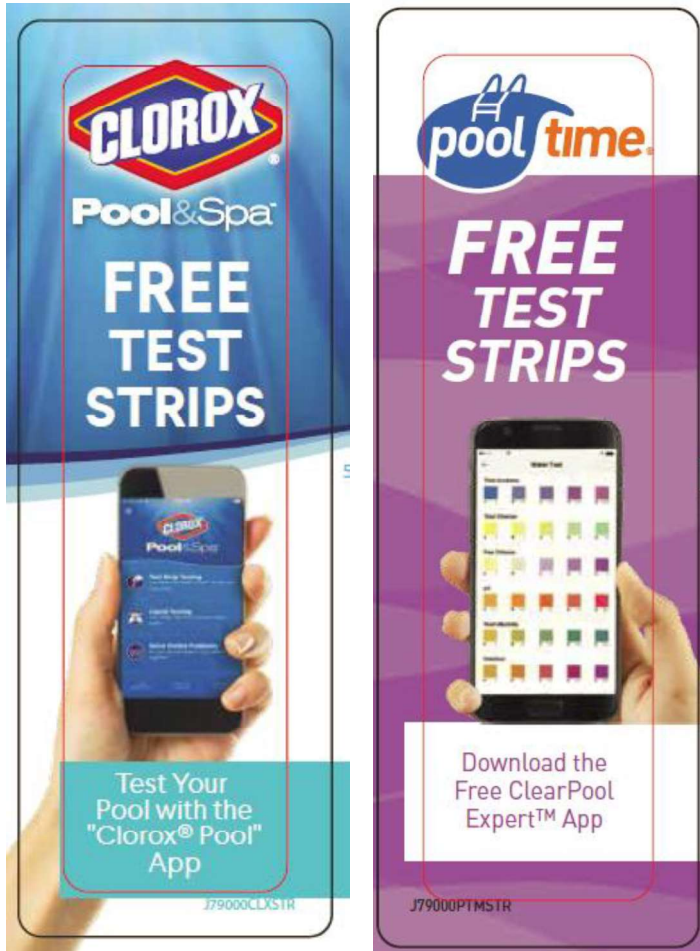

{Optional Graphics}

{Graphic immediately below is new.}

