



UNITED STATES ENVIRONMENTAL PROTECTION AGENCY
WASHINGTON, DC 20460

OFFICE OF CHEMICAL SAFETY
AND POLLUTION PREVENTION

July 25, 2019

Mark Jernigan
Registration Pool, Manager
Recreational Water Products, Inc.
P.O. Box 1449
Buford, GA 30515

Subject: Label Amendment – Addition of marketing claims, algae claims and graphics
Product Name: Granular Trichlor 28
EPA Registration Number: 67262-39
Application Date: February 12, 2019
Decision Number: 550808

Dear Mr. Jernigan:

The amended label referred to above, submitted in connection with registration under the Federal Insecticide, Fungicide and Rodenticide Act, as amended, is acceptable. This approval does not affect any conditions that were previously imposed on this registration. You continue to be subject to existing conditions on your registration and any deadlines connected with them.

A stamped copy of your labeling is enclosed for your records. This labeling supersedes all previously accepted labeling. You must submit one copy of the final printed labeling before you release the product for shipment with the new labeling. In accordance with 40 CFR 152.130(c), you may distribute or sell this product under the previously approved labeling for 18 months from the date of this letter. After 18 months, you may only distribute or sell this product if it bears this new revised labeling or subsequently approved labeling. "To distribute or sell" is defined under FIFRA section 2(gg) and its implementing regulation at 40 CFR 152.3.

Should you wish to add/retain a reference to the company's website on your label, then please be aware that the website becomes labeling under the Federal Insecticide Fungicide and Rodenticide Act and is subject to review by the Agency. If the website is false or misleading, the product would be misbranded and unlawful to sell or distribute under FIFRA section 12(a)(1)(E). 40 CFR 156.10(a)(5) list examples of statements EPA may consider false or misleading. In addition, regardless of whether a website is referenced on your product's label, claims made on the website may not substantially differ from those claims approved through the registration process. Therefore, should the Agency find or if it is brought to our attention that a website contains false or misleading statements or claims substantially differing from the EPA approved registration, the website will be referred to the EPA's Office of Enforcement and Compliance.

Page 2 of 2
EPA Reg. No. 67262-39
Decision No. 550808

Your release for shipment of the product constitutes acceptance of these conditions. If these conditions are not complied with, the registration will be subject to cancellation in accordance with FIFRA section 6. If you have any questions, please contact Wanda Henson by phone at (703) 308-6345, or via email at henson.wanda@epa.gov

Sincerely,

A handwritten signature in blue ink that reads "Wanda G. Fuller, for". The signature is written in a cursive style.

Demson Fuller, Product Manager 32
Regulatory Management Branch I
Antimicrobials Division (7510P)
Office of Pesticide Programs

Enclosure

{All text in brackets [xxx] is optional and may or may not be included on a final label.}
{All text in braces {xxx} is administrative and will not appear on a final label.}

Granular Trichlor 28

ACTIVE INGREDIENT:
Trichloro-s-triazinetriene 43.47%
OTHER INGREDIENTS 56.53%
TOTAL INGREDIENTS 100.00%
(Available Chlorine: 40%)

KEEP OUT OF REACH OF CHILDREN

DANGER

See [back] [side] panel for additional Precautionary Statements

FIRST AID: IF IN EYES: Hold eye open and rinse slowly and gently with water for 15-20 minutes. Remove contact lenses, if present, after the first 5 minutes, then continue rinsing eye. Call a poison control center or doctor for treatment advice. **IF ON SKIN OR CLOTHING:** Take off contaminated clothing. Rinse skin immediately with plenty of water for 15-20 minutes. Call a poison control center or doctor for treatment advice. **IF SWALLOWED:** Call poison control center or doctor immediately for treatment advice. Have person sip a glass of water if able to swallow. Do not induce vomiting unless told to do so by the poison control center or doctor. Do not give anything by mouth to an unconscious person. **IF INHALED:** Move person to fresh air. If person is not breathing, call 911 or an ambulance, then give artificial respiration, preferably mouth-to-mouth, if possible. Call poison control center or doctor for treatment advice.

Have the product container or label with you when calling a poison control center or doctor, or going for treatment. [IN CASE OF MEDICAL EMERGENCY, CALL [1-877-800-5553] [or other phone number]

Note to Physician: Probable mucosal damage may contraindicate the use of gastric lavage.

MANUFACTURED FOR:
RECREATIONAL WATER PRODUCTS
[AQUA CHEM DIVISION]
[PoolTime Division]
P.O. BOX 1449
BUFORD, GEORGIA 30515

NET [CONTENT] [WEIGHT]: {as indicated on container}

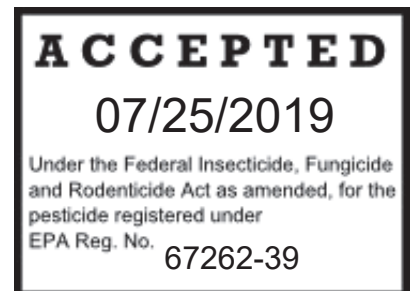

EPA REG. NO. 67262-39
EPA EST. NO. 5185-GA-1 [(BL)] {or} [(Z)]
7616-CA-1 [(C)]

{If multiple EPA Establishment Numbers appear on the label.}

[Actual establishment shown in code above or below label printed on [bottle] [container]]
[Letter designation in lot code printed above or below on [bottle] [container] identifies actual establishment.]

[Made in USA]

[NOTE: Any questions or comments about *[brand name]* products?] [In the continental U.S. call *[phone number]* Ask for your free pool care booklet.] [Questions or comments call *[phone number]*]
[[Questions?]] [Pool Care Tips?] *[phone number]*

[Free [App] Water Testing & Solutions Center]
[Free Water Testing & Solutions Center]
[FREE [Water] Test Strips]
[Test Your Pool with the Clorox® Pool App]
[Download the FREE Clorox® Pool App]
[Water Testing & Solution Center]
[Test Any Strip with the Clorox® Pool App]
[Use the Clorox® Pool App to Order Products Direct from Walmart.com]
[Test Smarter]
[Anytime. Anywhere. Pool Water Analysis and Solutions.]
[Download the Free ClearPool Expert™ App]
[Expert results begin with water testing.]
[Test like an expert [with the ClearPool Expert™ App]]
[Get it on Google Play]
[Download on the App Store]

{Multi-Functional Claims}

[Multi-purpose [pool shock] [formula] [pool cleaner] [shock] [Oxidizes] [Oxidizer] [Kills Bacteria]
[Destroys Organic Contaminants**] [organic contaminant remover**] [clarifier] [pH Balanced] [enhances filtration] [softens water] [protects equipment†] [equipment protector†][Prevents Scale†][Prevents Corrosion†][improves swimmer comfort]

[All-in-One [pool shock] [formula] [pool cleaner] [shock] [Oxidizes] [Oxidizer] [Kills Bacteria]
[Destroys Organic Contaminants**] [organic contaminant remover**] [clarifier] [pH Balanced] [enhances filtration] [softens water] [protects equipment†] [equipment protector†][Prevents Scale†][Prevents Corrosion†][improves swimmer comfort]

[Multi-functional [pool shock] [formula] [pool cleaner] [shock] [Oxidizes] [Oxidizer] [Kills Bacteria]
[Destroys Organic Contaminants**] [organic contaminant remover**] [clarifier] [pH Balanced] [enhances filtration] [softens water] [protects equipment†] [equipment protector†][Prevents Scale†][Prevents Corrosion†][improves swimmer comfort]

[2][3][4][5][6][7][8] – in [1] [One] [Formula] [pool shock] [pool cleaner] [shock] [Oxidizes] [Oxidizer] [Kills Bacteria][Destroys Organic Contaminants**][organic contaminant remover**] [clarifier] [pH Balanced] [enhances filtration][softens water] [protects equipment†][equipment protector†][Prevents Scale†][Prevents Corrosion†][improves swimmer comfort] [**[such as] [body & suntan oils] [body oils] [&] [suntan oils] [&] [sweat] [perspiration] [&] [lotions] [&] [urine]]

† *Will only be used with alternate formula containing corrosion / scale inhibitor.*

{Usage and Treatment Claims}

[For Pools]

[For Swimming Pool Use]

{Spanish statement directing Spanish speakers to obtain assistance before using product.

Translates in English to: “If you do not understand the (this) label, find someone to explain it to you in detail.”

[Si usted no entiende la etiqueta, busque a alguien para que se lo explique a usted en detalle.]

[What?] *{For use on front panel of label as a header above/beside product name.}*

[Why?] *{For use on front panel of label as a header above/beside use claims chosen from accepted label text that relates to the consumer features and benefits of product.}*

[Do Not Mix With Any Other Product]

[Do Not Mix this Product with Calcium Hypochlorite, or Any Other Product]

[TO OPEN CUT ALONG DOTTED LINE WITH SCISSORS] *{Statement to appear in upper corner of child resistant bag, when product sold in bags.}*

[Can be used in salt pools] [Compatible with salt pools]*{Reader notes: Salt pools generate hypochlorous acid using electrolysis from NaCl added to pool water.}*

[For use with all pool surfaces]

[For all pool surfaces including vinyl, plaster and fiberglass]

[For all pools, including vinyl, plaster and fiberglass]

[For all pool surfaces]

[[One] [1] lb treats 12,000 Gallons]

[For use with all filter & surface types]

[Easy open] {for 1lb bottle application}

[Easy pour] {for 1lb bottle application}

[Easy Open Easy Pour Bottle]

[Resealable. Reusable. Recyclable.] {for 1lb bottle application}

[No Scissors [Required][Needed]] {for 1lb bottle application}

[Dissolves Completely]

[Treats 12,000 Gallons] *{Only for use when sold in one pound bags or containers}*

[Treats 10,000 Gallons] *{Only for use when sold in 13.4 ounce bags or containers}*

[Won't Discolor Pool Surfaces#]

[# When Used as Directed]

[For use in vinyl, painted, fiberglass, or color plaster surface pools]

[Formulated for Vinyl Pools]

[Fast Dissolving Shock Treatment]

[Fast Dissolving]

[Dissolves in Seconds]

[Fast-Dissolving]

[Dissolves Fast]

[Suitable for All Pool Types] *{This statement alerts consumer to the fact they may use this product in above ground, in ground, indoor, outdoor, plaster, vinyl, fiberglass pools}*

[For Use In All Pool Types] *{This statement alerts consumer to the fact they may use this product in above ground, in ground, indoor, outdoor, plaster, vinyl, fiberglass pools}*

[No Need to Pre-Dissolve]

[Add Directly To Pool]

[One Bag Treats 12,000 Gallons] *{Only for use when sold in one pound bags}*

[One Bag Treats 10,000 Gallons] *{Only for use when sold in 13.4 ounce bags}*

[One Bottle Treats 12,000 Gallons] *{Only for use when sold in one pound bottles}*

[Suitable for opening pools]

[Suitable for pool opening and winterization]

[Suitable for pool opening and closing]

[Treat and Swim In As Soon As 15 Minutes*]

[Treat and Swim in 15 [min] [minutes*]]

[Swim in 15 [min] [minutes*]]

[Swim-Ready in 15 Minutes*]

[Works Quickly to Allow Swimming in as Soon as 15 Minutes*]

[* Refer to the Re-entry statement on the back panel for further guidance.]

{Kills Bacteria and Algae Claims}

[Kills Bacteria]

[Protects Against Bacteria]

[Guards Against Bacteria]

[Controls Bacteria]

[Kills Bacteria & Algae]

[Kills and Prevents All Types of Pool Algae]

[Kills and Prevents All Types of Pool Algae*]

[*green, mustard, black]

[Kills and Prevents Algae][with Algae-Fighting Crystals]

[Kills and Prevents Green, Mustard and Black Algae]

[Destroys Bacteria]

[Algae-Fighting Formula]

[Prevents Algae]

[Kills Algae]

[Destroys Algae]

[Algae-Fighting Crystals]

{Organic Contaminant Claims}

[[Removes] [Eliminates] [Destroys] [Breaks down] organic contaminants** [for sparkling clear water]]

[[Removes] [Eliminates] [Destroys] [Breaks down] [organic contaminants such as] [sunscreen] [pet dander] [fertilizer] [pollen] [skin oils] [lotions] [sweat] [urine] [pee]]

[[Controls] [Eliminates] [Destroys] [Breaks down] swimmer contaminants such as [oils] [sweat] [lotion] [urine] [pee]]

[[Controls] [Eliminates] [Destroys] [Breaks down] swimmer contaminants including [oils] [sweat] [lotion] [urine] [pee]]

[[Removes] [Eliminates] [Destroys] [Breaks down] organic contaminants**]

[Protects against [bacteria] [and] [organic contaminants**] [for] [clean] [and] [clear] [water]]

[[Clears [cloudy] water] [&] [removes swimmer contaminants**]]

[Destroys Organic Contaminants**]

**[such as] [body & suntan oils] [body oils] [&] [suntan oils] [&] [sweat] [perspiration] [&] [lotions] [&] [urine]]

[For Heavy Bather Loads]

[For Use After Heavy Rains]
[For Heavy Bather Loads or After Heavy Rains]

{Swimmer Comfort Claims}

[[Removes] [Eliminates] [Reduces] chlorine odor]
[[Removes] [Eliminates] [Reduces] pool odor]
[Effective against [chlorine] odor]
[Deodorizes your pool]
[Use to clean and deodorize]
[Creates [comfortable] [swim-ready] water]
[For a comfortable pool experience]
[Reduces chlorine odor]
[[Destroys] [Eliminates] [Removes] [Breaks down] eye irritating compounds in swimming pool water]
[[Destroys] [Eliminates] [Removes] [Breaks down] contaminants that [contribute to] [lead to] [cause] eye irritation]
[[Destroys] [Eliminates] [Removes] [Breaks down] compounds that cause chlorine odor in swimming pool water]
[[Destroys] [Eliminates] [Removes] [Breaks down] compounds that cause eye irritation and chlorine odor in swimming pool water]

{Water Clarity Claims}

[Shocks water clear]
[[Prevents] [Eliminates] [Quickly] [Clears] [cloudy] water]
[[Improves] [Enhances] filtration]
[Clarifier enhances filtration]
[Improves filter performance]
[Clears Cloudy Water]
[Quickly Clears Cloudy Water]
[Creates Sparkling Water]
[Provides Crystal Clear Water]
[Use Regularly for Sparkling Water]
[Restores Water Clarity]
[Clarifies water]
[Gathers debris for easy removal]
[Gathers debris for easy filtration]
[Plus] [Improves filter performance]
[Plus] [[Improves] [Enhances] filtration]
[Contains a Filter Enhancer]
[Produces Sparkling Clean Swimming Pool Water]
[Crystal Clear Water]
[Maintains Crystal Clear Water]
[For Crystal Clear Water]
[For Fresh, Clean Water]
[Clears Water & Destroys Filth]
[Built-in Clarifier]
[Enhances filtration]
[Clarifies [Pool] Water]

{Clean Water Claims}

[Use for a shockingly [clean] [and] [clear] pool]
[Great for an extra touch of clean]
[An added touch of clean]
[Keeps water [clean] [and] [clear] during severe heat or rain]
[Cleans pool water after heavy use]
[Freshens pool water after heavy use]
[For extra clean water]
[For fresh, clear water]
[[Powers through] [fights] [eliminates] filth]
[Works quickly to restore pool water freshness & clarity]
[[Clears [cloudy] water] [&] [removes filth]]

{pH Balance Claims}

[pH balanced to protect [pool] equipment and surfaces]
[pH balanced to prevent corrosion and scale]
[pH balanced]
[pH Buffer]

{Scale/Corrosion Control Claims. Only for use with alternate formula containing corrosion / scale inhibitor.}

[With built in scale preventative and sunlight protector]
[With built in corrosion preventative and sunlight protector]
[With built-in scale preventative, water softener and sunlight protector]
[With built-in scale preventative, water softener]
[Helps prevent corrosion & metal staining]
[Reduces Scale Formation]
[Protects pool equipment for longer life]
[Gentle on equipment – prevents corrosion/metal staining]
[Protects equipment]
[Corrosion prevention]
[Helps prevent corrosion]
[Corrosion inhibitor]
[Prevents Metal Staining]
[Protects Equipment]
[Equipment Protector]
[Prevents [corrosion] [&] [scale] [&] [metal staining]]
{Note: “Plus” denotes product features in addition to being a swimming pool shock}
[[Plus] Corrosion Prevention]
[[Plus] Corrosion Inhibitor]
[[Plus] Prevents Metal Staining]
[[Plus] Reduces Scale Formation]
[[Plus] Protects Equipment]
[[Plus] Equipment Protection]
[[Plus] Scale Prevention]
[[Plus] Prevents Corrosion and Scale [Formation]]

{Water Softener Claims}

[Makes water silky smooth]

[Makes water soft and smooth]

[Softens Water]

[Water softening]

{Note: "Plus" denotes product features in addition to being a swimming pool shock}

[Plus] Softens Water]

[Plus] Water Softener]

[Plus] Makes Water Silky Smooth]

{Step Systems Claims}

[Easy 1 2 3 Pool Care Brand System]

[Step 3]

[Shock]

{Winterization Claims}

{Optional marketing statements that may be used with swimming pool winterization.}

[For all pool surfaces] *{This statement alerts consumer to the fact they may use this product in above ground, in ground, indoor, outdoor, plaster, vinyl, fiberglass pools}*

[Winter oxidizer and clarifier]

[Suitable for above ground pools]

[Effective winter shock]

[Suitable for vinyl pools]

[First step in an effective winterization program]

[For use in vinyl, painted, fiberglass or color plaster surface pools]

[Restores water clarity]

[Quick-dissolving winter shock]

[Oxidizer, Buffer, Clarifier, Flocculant]

[No pre-dissolving]

[Suitable for all pool surfaces]

[Quick-dissolving]

[Multi-purpose]

[Dual-action]

[Regular use will create easier spring start-up]

[Suitable for closing pools]

[Suitable for winterizing pools]

{Spa Claims}

{Optional marketing statements that may be used with spa & hot tub oxidizing.}

[For Spas & Hot Tubs]

[Oxidizes and clarifies for beautiful water]

[Removes unpleasant odors]

[Restores water sparkle]

[Produces clear, sparkling spa water]

[Easy to use]

[Multi-purpose shock]

[Oxidizer, water clarifier, flocculant, buffer]

[Treats 500 gallons] *{Only to be used when sold in 1.5 ounce bags}*

[No pre-mixing]

[Reduces odors]

[Rapidly dissolving] *{Reader's Note: Product is granular and dissolves within 15 minutes.}*

{Reader's Note: Ionizers use a metal such as copper or silver as a supplemental sanitizer. These metals do not provide any oxidizing power. Therefore an oxidizer is required to break down organic contaminants such as perspiration, lotions, body oils, etc. Ozone provides oxidation of spa water only at the point of contact where ozone is being generated in the circulation system. Granular Trichlor 28 provides residual oxidation throughout the spa. The purpose of the ionizer and ozone claims are to let the consumer know that this product is compatible with swimming pools and spas that utilize Ionizer and Ozonator systems.}

[Suitable for use with ozone]

[Compatible with ozone and ionizers]

[Compatible with ionizers]

[Optional Graphics]

{Reader Notes: The "Pool Essentials System" box below may be placed on the label to allow easy product category identification by consumers.}

{When sold with shock directions only}

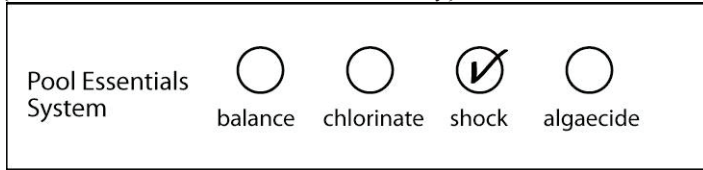

{Reader Notes: The "4-step System" box below may be placed on the label to allow easy product category identification by consumers.}

{When sold with shock directions only}

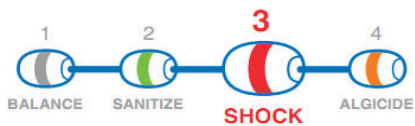
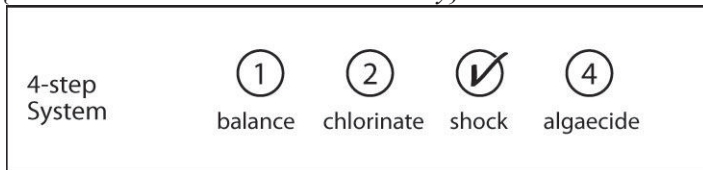

{Reader Notes: In a three step pool program the 3 steps are: 1-balance water, 2-sanitize water, 3 - shock water. The Easy 1, 2, 3 Pool Care Brand System is to remind the consumer know there are multiple steps in pool care.}



{Reader Notes: "6 in 1 Formula" is to let the consumer know that this product provides 6 benefits in one product: (1) oxidizes, (2) clarifies, (3) prevents corrosion, (4) prevents scale, (5) protects equipment, (6) softens water. These are listed out "Multi-functional claims" at the top of page 2 of this master label.}



⚠ WARNING
⚠ AVISO
Children can fall into bucket and drown. Keep children away from bucket with even a small amount of liquid.
Los niños pueden caer dentro de el balde y ahogarse. Mantenga a los niños alejados de los baldes aunque solo contengan un poco de liquido.



{Reader Notes: The QR (quick reference) square provides a symbol that is used with a smart phone so that the user can quickly link to information about the product/brand. "FPO" is "for position only". A working quick reference square will be provided on production labels.}

A circular logo with a blue border. Inside, the word "free!" is in a large, bold, blue font. Below it, "ON-LINE WATER ANALYSIS" is written in a smaller, blue, sans-serif font. A white water tap icon is positioned to the right of the text.	A square QR code on a yellow background. A green diagonal label with the letters "FPO" in white is overlaid on the QR code.
	Data rates may apply

{Directions to be used for shock and algae kill application, Option A}

[Swimming Pool [Shock] [Oxidizer]]

[WHY TO USE THIS PRODUCT: This premium shock product is easy to use and performs multiple, important maintenance functions. [Granular Trichlor 28] [This product] effectively oxidizes during shock treatment organic contaminants [(such as) [body & suntan oils] [body oils] [suntan oils], [sweat] [perspiration], lotions and urine)] that cause cloudy water, and musty odors by utilizing advanced proprietary technology. This technology combines oxidizers, water clarifiers, flocculants and buffers to provide crystal clear water with no cloudy residue and without increasing pH like ordinary shock products.

[Granular Trichlor 28] [This product] is designed for use in all pool types by adding the product directly to the pool without pre-dissolving. Because it dissolves rapidly and performs multiple maintenance functions, this product works fast and effectively, allowing swimming to resume in as little as 15 minutes.* [Granular Trichlor 28] [This product] is ideal for both last minute and routine maintenance applications.]

{or}

[WHY TO USE THIS PRODUCT: Swimming pool shock treatment.]

⚠ DO NOT mix [Granular Trichlor 28] [this product] directly with any other shock products or pool chemicals, as violent reactions could occur. [Granular Trichlor 28] [This product] must be applied directly into the pool water. DO NOT pre-dissolve [Granular Trichlor 28] [this product].

IMPORTANT NOTES:

1. When using other products, always follow label directions for those products.
2. As with other products, this product may promote metal stains on pool surfaces. Always check water for metal content and if present, stabilize metals with a stain and scale inhibitor prior to the addition of this product.

DIRECTIONS FOR USE:

It is a violation of Federal Law to use this product in any manner inconsistent with its labeling. Read entire label and use strictly in accordance with precautionary statements and directions.

BEFORE YOU BEGIN:

1. Make sure all pool equipment is working properly.
2. Backwash filter following manufacturer's directions [to ensure adequate circulation].
3. Check alkalinity, pH and calcium hardness with a test kit. Adjust alkalinity to 80 - 125 ppm for plaster pools and 125 - 150 ppm for vinyl and fiberglass pools. Adjust pH to 7.2 - 7.6. Adjust calcium hardness to 200 - 275 ppm for plaster pools and 175 - 225 ppm for vinyl and fiberglass pools.

[To Shock Water [Clear]:]

[NOW USE THIS PRODUCT:]

Routine Maintenance

1. [With pump operating, apply 1 lb. [(2, 8oz cups)] *{for use if product is not in premeasured bag}* of [Granular Trichlor 28] [this product] per 12,000 gallons directly into pool. [****]] *{or}* *{for use if product is in 13.4 ounce premeasured bag}* With pump operating, apply 1 bag of [Granular Trichlor 28] [this product] per 10,000 gallons directly into pool.] *{and/or}* [For small vinyl pools, with pump operating, apply 3.5 teaspoons of [Granular Trichlor 28] [this product] per 500 gallons or 1.3 ounces per 1,000 gallons directly into pool.***] DO NOT pre-dissolve [Granular Trichlor 28] [this product]. DO NOT apply [Granular Trichlor 28] [this product] through skimmer or chemical feeding device as other chemicals may be present which could result in a violent reaction.
2. Wait at least 15 minutes after product application before entering pool.*
3. [After 15 minutes, to] [To] prevent damage to pool surface, use an appropriate pool brush to disperse any undissolved granules which may have settled to the bottom of the pool.
4. Operate pump and filter continuously for 4 to 8 hours after product addition.
5. For best results, apply [Granular Trichlor 28] [this product] weekly as part of your maintenance routine.

[***Use a clean, dedicated spoon to dose the appropriate amount of product into the pool. Keep the dosage spoon stored out of reach of children. 3 teaspoons equals 1 tablespoon. 1.75 tablespoons equals 1 ounce.]

[****Always apply this product in its dry form using a clean dry plastic cup or scoop. Do not use this cup for any other purpose.] *{for use if product is not in premeasured bag}*

Additional Applications:

Wind, rain, increased water temperature and the number and frequency of bathers can cause cloudy water and unpleasant odors which may require additional application(s) of this product. Follow routine maintenance instructions.

[To Kill Algae:

- Brush pool surfaces while filter and pump are operating.
- [Add 1 lb. per 12,000 gallons directly to the pool water in areas of heaviest algae growth, operate filter and pump for 24 hrs.] *{or}* *{for use if product is in 13.4 ounce premeasured bag}* Add 1 bag per 10,000 gallons directly to the pool water in areas of heaviest algae growth, operate filter and pump for 24 hrs.] Hold bag no more than 3 feet over pool surface.
- Repeat brushing.
- Do not enter the pool until the free available chlorine residual is 1-4 ppm.
- Product can be re-applied after 72 hours if necessary.]

*** TEST CHLORINE LEVEL PRIOR TO RE-ENTRY. RE-ENTRY INTO TREATED SWIMMING POOLS IS PROHIBITED ABOVE LEVELS OF 4 PPM CHLORINE DUE TO RISK OF BODILY INJURY.**

[FOR POOL CLOSURE:

[Backwash filter following manufacturer's directions [to prepare your filter for closing].] Apply [Granular Trichlor 28] [this product] at a rate of [1 lb. per 6,000 gallons] *{or}* [*for use if product is in 13.4 ounce premeasured bag*] 1 bag per 5,000 gallons] before closing pool for the winter. To prevent damage to pool surface, use an appropriate pool brush to disperse any undissolved granules which may have settled to the bottom of the pool. Apply an appropriate winter algacide after addition of this product.]

{Directions to be used for shock and algae kill application, Option B}

[Swimming Pool [Shock] [Oxidizer]]

[How?]

DIRECTIONS FOR USE:

It is a violation of Federal Law to use this product in any manner inconsistent with its labeling. Read entire label and use strictly in accordance with precautionary statements and directions.

To Shock Water Clear:

- [Add 1 lb. [(2, 8oz cups)] *{for use if product is not in premeasured bag}* per 12,000 gallons into the deepest pool area [****] *{or}* [*{for use if product is in 13.4 ounce premeasured bag}* Add 1 bag per 10,000 gallons into the deepest pool area] *{or}* [Add 3.5 teaspoons per 500 gallons or 1.3 ounces per 1,000 gallons directly into pool. ***] while filter and pump are operating.
- DO NOT pre-dissolve, DO NOT apply through skimmer or chemical feeder, DO NOT mix with other chemicals; a violent reaction may result.
- Wait at least 15 minutes after product application before entering pool.*
- [After 15 minutes, to] [To] prevent damage to pool surface, use an appropriate pool brush to disperse any undissolved granules which may have settled to the bottom of the pool.
- Operate pump and filter continuously for 4 to 8 hours after product addition.
- Apply more product after heavy use, high temperatures, or rain. For best results, shock pool weekly.

[***Use a clean, dedicated spoon. Keep the spoon stored out of reach of children. 3 teaspoons equals 1 tablespoon. 1 ¾ tablespoons equals 1 ounce.]

[****Always apply this product in its dry form using a clean dry plastic cup or scoop. Do not use this cup for any other purpose.] *{for use if product is not in premeasured bag}*

[To Kill Algae:

- Brush pool surfaces while filter and pump are operating.
- [Add 1 lb. per 12,000 gallons directly to the pool water in areas of heaviest algae growth, operate filter and pump for 24 hrs.] *{or}* [*{for use if product is in 13.4 ounce premeasured bag}* Add 1 bag per 10,000 gallons directly to the pool water in areas of heaviest algae growth, operate filter and pump for 24 hrs.] Hold bag no more than 3 feet over pool surface.
- Repeat brushing.
- Do not enter the pool until the free available chlorine residual is 1-4 ppm.
- Product can be re-applied after 72 hours if necessary.]

*** TEST CHLORINE LEVEL PRIOR TO RE-ENTRY. RE-ENTRY INTO TREATED SWIMMING POOLS IS PROHIBITED ABOVE LEVELS OF 4 PPM CHLORINE DUE TO RISK OF BODILY INJURY.**

[To Close Pool:

- [Backwash filter following manufacturer's directions [to prepare your filter for closing].]
- Apply this product at a rate of [1 lb. per 6,000 gallons] *{or}* [*for use if product is in 13.4 ounce premeasured bag*] 1 bag per 5,000 gallons] into the deepest pool area while filter and pump are operating.
- To prevent damage to pool surface, use an appropriate pool brush to disperse any undissolved granules which may have settled to the bottom of the pool.
- Apply an appropriate winter algaecide after addition of this product.]

[Visit *[website]* for complete pool closing instructions.]]

{Directions to be used for shock application, Option C1, Product sold in 1 pound or larger bag/container}

DIRECTIONS FOR USE: It is a violation of Federal Law to use this product in a manner that is inconsistent with its labeling. Read entire label and use strictly in accordance with precautionary statements and directions.

[Backwash filter following manufacturer’s directions [to ensure adequate circulation].] Test and balance water prior to use. Adjust pH to 7.2-7.6. [Visit [website] for free water analysis and personalized product and dosage recommendations.]

Dosage	When/How To Use:
1 lb per 12,000 GAL	TO SHOCK WATER CLEAR AND DESTROY ORGANIC CONTAMINANTS**: <i>{Optional: Insert Pictogram A and/or B within this box}</i> Broadcast in pool’s deepest area with filter and pump on. Run filter and pump for 4-8 [hrs.] [hours]. DO NOT pre-dissolve, DO NOT add through skimmer or feeder, DO NOT mix with other chemicals (a violent reaction may result). [[After 15 minutes, to] [To] prevent damage to pool surface, use an appropriate pool brush to disperse any undissolved granules which may have settled to the bottom of the pool.] RE-ENTRY: Wait at least 15 minutes after product application before entering pool.* Enter when chlorine level is 1-4 ppm. FOR BEST RESULTS: Shock pool weekly and also after heavy use, high temperatures, or rain. Use at night to prevent sunlight degradation.
	TO CLOSE POOL: Broadcast in pool’s deepest area with filter and pump on, brushing any undissolved product. Apply an algacide per closing directions after this product. [Visit [website] for complete closing instructions.]]
[1 lb per 6,000 GAL	TO CLOSE POOL: Broadcast in pool’s deepest area with filter and pump on, brushing any undissolved product. Apply an algacide per closing directions after this product. [Visit [website] for complete closing instructions.]]

*TEST CHLORINE LEVEL PRIOR TO RE-ENTRY. RE-ENTRY INTO TREATED SWIMMING POOLS IS PROHIBITED ABOVE LEVELS OF 4 PPM CHLORINE DUE TO RISK OF BODILY INJURY.

**[such as] [body & suntan oils] [body oils] [&] [suntan oils] [&] [sweat] [perspiration] [&] [lotions] [&] [urine]

[Note: To prevent damage to pool surface, use an appropriate pool brush to disperse any undissolved granules which may have settled to the bottom of the pool.]

Pictogram A



Pictogram B



{Directions to be used for shock application, Option C2, Product sold in 13.4 ounce bag}

DIRECTIONS FOR USE: It is a violation of Federal Law to use this product in a manner that is inconsistent with its labeling. Read entire label and use strictly in accordance with precautionary statements and directions.

[Backwash filter following manufacturer’s directions [to ensure adequate circulation].] Test and balance water prior to use. Adjust pH to 7.2-7.6. [Visit [website] for free water analysis and personalized product and dosage recommendations.]

Dosage	When/How To Use:
1 bag per 10,000 GAL	TO SHOCK WATER CLEAR AND DESTROY ORGANIC CONTAMINANTS**: <i>{Optional: Insert Pictogram A and/or B within this box}</i> Broadcast in pool’s deepest area with filter and pump on. Run filter and pump for 4-8 [hrs.] [hours]. DO NOT pre-dissolve, DO NOT add through skimmer or feeder, DO NOT mix with other chemicals (a violent reaction may result). [[After 15 minutes, to] [To] prevent damage to pool surface, use an appropriate pool brush to disperse any undissolved granules which may have settled to the bottom of the pool.] RE-ENTRY: Wait at least 15 minutes after product application before entering pool.* Enter when chlorine level is 1-4 ppm. FOR BEST RESULTS: Shock pool weekly and also after heavy use, high temperatures, or rain. Use at night to prevent sunlight degradation.
	TO CLOSE POOL: Broadcast in pool’s deepest area with filter and pump on, brushing any undissolved product. Apply an algaecide per closing directions after this product. [Visit [website] for complete closing instructions.]]
[1 bag per 5,000 GAL	

*TEST CHLORINE LEVEL PRIOR TO RE-ENTRY. RE-ENTRY INTO TREATED SWIMMING POOLS IS PROHIBITED ABOVE LEVELS OF 4 PPM CHLORINE DUE TO RISK OF BODILY INJURY.

**[such as] [body & suntan oils] [body oils] [&] [suntan oils] [&] [sweat] [perspiration] [&] [lotions] [&] [urine]

[Note: To prevent damage to pool surface, use an appropriate pool brush to disperse any undissolved granules which may have settled to the bottom of the pool.]

Pictogram A

Pictogram B



{Directions to be used for shock application and algae kill, Option C3, Product sold in 1 pound or larger bag/container}

DIRECTIONS FOR USE: It is a violation of Federal Law to use this product in a manner that is inconsistent with its labeling. Read entire label and use strictly in accordance with precautionary statements and directions.

[Backwash filter following manufacturer’s directions [to ensure adequate circulation].] Test and balance water prior to use. Adjust pH to 7.2-7.6. [Visit [*website*] for free water analysis and personalized product and dosage recommendations.]

Dosage	When/How To Use:
1 lb per 12,000 GAL	TO SHOCK WATER CLEAR AND DESTROY ORGANIC CONTAMINANTS**:
	<p><i>{Optional: Insert Pictogram A and/or B within this box}</i></p> <p>Broadcast in pool’s deepest area with filter and pump on. Run filter and pump for 4-8 [hrs.] [hours]. DO NOT pre-dissolve, DO NOT add through skimmer or feeder, DO NOT mix with other chemicals (a violent reaction may result).</p> <p>[[After 15 minutes, to] [To] prevent damage to pool surface, use an appropriate pool brush to disperse any undissolved granules which may have settled to the bottom of the pool.]</p> <p>RE-ENTRY: Wait at least 15 minutes after product application before entering pool.* Enter when chlorine level is 1-4 ppm.</p> <p>FOR BEST RESULTS: Shock pool weekly and also after heavy use, high temperatures, or rain. Use at night to prevent sunlight degradation.</p>
	<p><i>TO KILL ALGAE:</i></p> <p><i>{Optional: Insert Pictogram C (brush/add product/repeat brushing) within this box}</i></p> <ol style="list-style-type: none"> 1. Brush pool surfaces while filter and pump are operating. 2. Add in areas of heaviest algae growth, operate filter and pump for 24 hrs. 3. Repeat brushing. Product can be re-applied after 72 hrs. if necessary. 4. Enter when chlorine level is 1-4 ppm.*
1 lb per 6,000 GAL	<p>TO CLOSE POOL:</p> <p>Broadcast in pool’s deepest area with filter and pump on, brushing any undissolved product. Apply an algaecide per closing directions after this product. Visit [<i>website</i>] for complete closing instructions.</p>

*TEST CHLORINE LEVEL PRIOR TO RE-ENTRY. RE-ENTRY INTO TREATED SWIMMING POOLS IS PROHIBITED ABOVE LEVELS OF 4 PPM CHLORINE DUE TO RISK OF BODILY INJURY.

**[such as] [body & suntan oils] [body oils] [&] [suntan oils] [&] [sweat] [perspiration] [&] [lotions] [&] [urine]

[Note: To prevent damage to pool surface, use an appropriate pool brush to disperse any undissolved granules which may have settled to the bottom of the pool.]

{Directions to be used for shock and algae kill application, Option C4, Product sold in 13.4 ounce bag}

DIRECTIONS FOR USE: It is a violation of Federal Law to use this product in a manner that is inconsistent with its labeling. Read entire label and use strictly in accordance with precautionary statements and directions.

[Backwash filter following manufacturer’s directions [to ensure adequate circulation].] Test and balance water prior to use. Adjust pH to 7.2-7.6. [Visit [*website*] for free water analysis and personalized product and dosage recommendations.]

Dosage	When/How To Use:
1 bag per 10,000 GAL	TO SHOCK WATER CLEAR AND DESTROY ORGANIC CONTAMINANTS**: <i>{Optional: Insert Pictogram A and/or B within this box}</i> Broadcast in pool’s deepest area with filter and pump on. Run filter and pump for 4-8 [hrs.] [hours]. DO NOT pre-dissolve, DO NOT add through skimmer or feeder, DO NOT mix with other chemicals (a violent reaction may result). [[After 15 minutes, to] [To] prevent damage to pool surface, use an appropriate pool brush to disperse any undissolved granules which may have settled to the bottom of the pool.] RE-ENTRY: Wait at least 15 minutes after product application before entering pool.* Enter when chlorine level is 1-4 ppm. FOR BEST RESULTS: Shock pool weekly and also after heavy use, high temperatures, or rain. Use at night to prevent sunlight degradation.
	TO KILL ALGAE: <i>{Optional: Insert Pictogram C (brush/add product/repeat brushing) within this box}</i> 1. Brush pool surfaces while filter and pump are operating. 2. Add in areas of heaviest algae growth, operate filter and pump for 24 hrs. 3. Repeat brushing. Product can be re-applied after 72 hrs. if necessary. 4. Enter when chlorine level is 1-4 ppm.*
	TO CLOSE POOL: Broadcast in pool’s deepest area with filter and pump on, brushing any undissolved product. Apply an algaecide per closing directions after this product. Visit [<i>website</i>] for complete closing instructions.
1 bag per 5,000 GAL	

*TEST CHLORINE LEVEL PRIOR TO RE-ENTRY. RE-ENTRY INTO TREATED SWIMMING POOLS IS PROHIBITED ABOVE LEVELS OF 4 PPM CHLORINE DUE TO RISK OF BODILY INJURY.

**[such as] [body & suntan oils] [body oils] [&] [suntan oils] [&] [sweat] [perspiration] [&] [lotions] [&] [urine]

[Note: To prevent damage to pool surface, use an appropriate pool brush to disperse any undissolved granules which may have settled to the bottom of the pool.]

Pictogram A



Pictogram B

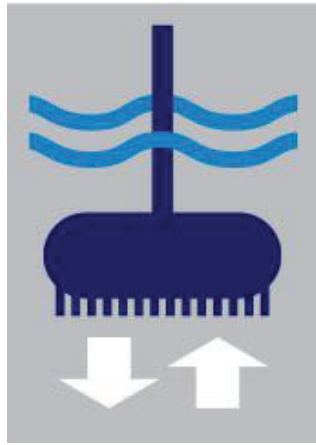

Pictogram C

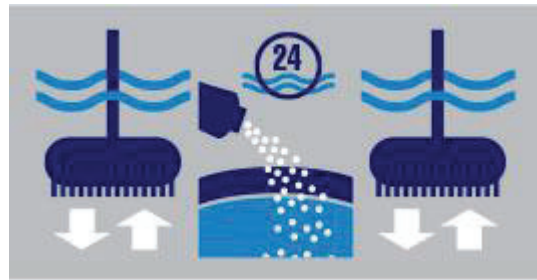

{Directions to be used for shock application, Option D- Small Pool Version}

[Swimming Pool [Shock] [Oxidizer]]

DIRECTIONS FOR USE:

It is a violation of Federal Law to use this product in any manner inconsistent with its labeling. Read entire label and use strictly in accordance with precautionary statements and directions.

Test & balance water prior to use. Adjust pH to 7.2-7.6 [and free chlorine to 1 – 4 ppm]. [Check your filter to ensure adequate circulation.] [Visit [*website*] for [free water analysis] [&] [personalized product and dosage recommendations].]

Use: Restores water freshness and clarity by oxidizing organic contaminants**.

Dosage: 3.5 [tsp] [teaspoons] per 500 gallons.

Directions: Use a designated, clean, dry spoon that is kept out of reach of children. Add directly to water with filter and pump operating continuously for 4-8 [hrs] [hours] after use. To prevent damage to pool surface, use an appropriate pool brush to disperse any undissolved granules which may have settled to the bottom of the pool.

Re-Entry: Wait at least 15 [min] [minutes]. Test chlorine level prior to re-entry. Re-entry into treated swimming pools is prohibited above levels of 4ppm chlorine due to risk of bodily injury.

For Best Results: Use weekly and apply more product after heavy use, high temperatures, or rain.

DO NOT pre-dissolve, apply through skimmer or feeder, or mix with other chemicals (a violent reaction may occur)

**[such as] [body & suntan oils] [body oils] [&] [suntan oils] [&] [sweat] [perspiration] [&] [lotions] [&] [urine]

{Directions to be used for swimming pool winterization.}

SWIMMING POOL WINTERIZATION

This product is a unique dual action formulation which is the first step in an effective winterization program. This product both oxidizes and clarifies pool water. This quick dissolving product is suitable for use in pools of any surface type.

⚠ DO NOT mix this product directly with any other pool chemicals as violent reactions could occur. This product must be applied from the [bag] [bottle] directly into the pool water. **DO NOT** pre-dissolve this product.

DIRECTIONS FOR USE:

It is a violation of Federal Law to use this product in any manner inconsistent with its labeling. Read entire label and use strictly in accordance with precautionary statements and directions.

[Use 1 pound of this product for each 6,000 gallons of pool water.] *{or}* [*for use if product is in 13.4 ounce premeasured bag*] Use 1 bag of this product for each 5,000 gallons of pool water.] With the circulation system of the pool on, broadcast the entire dosage into the deep end of the pool. Brush any undissolved product off the surface of the pool with a surface compatible brush.

Continue to circulate the pool for **at least** 30 minutes before proceeding to the next step in the winterization process.

It is recommended that as part of the closing procedures, a quality winterizing [algaecide] [algicide] be applied following the application of this product. After application of the [algaecide] [algicide], continue with the closing of the pool as directed by pool manufacturer.

For mesh covered or non-covered pools, a mid-winter treatment may be required using an appropriate EPA registered sanitizer.

{Directions to be used for spa and hot tub oxidizing.}

SPA AND HOT TUB OXIDIZER

This product is specially formulated to destroy unpleasant odors and corrects most cloudy conditions to restore spa water sparkle. It combines a blend of water clarifiers and water enhancing buffers. Special ingredients aid the filter in removing small suspended particles to further enhance water clarity. This product provides enhanced water clarity, improved bather comfort, and is convenient to use. It is designed to be used with all types of spa surfaces.

This product is convenient to use and dissolves quickly and completely. There is no pre-mixing required and no undissolved solids remain. (In water temperatures less than 70⁰ F, brush after applications to speed dissolving. Do not allow undissolved material to lie in contact with bleachable surfaces.) This product works with all surface types and may be used with chlorinating products, brominating products, ozone, as well as ionizers.

⚠ DO NOT mix this product directly with any other shock products or spa chemicals, as violent reactions could occur. This product must be applied from the [bag] [bottle] directly into the spa water. DO NOT pre-dissolve this product.

DIRECTIONS FOR USE:

It is a violation of Federal Law to use this product in any manner inconsistent with its labeling. Read entire label and use strictly in accordance with precautionary statements and directions.

1. Test and adjust spa water pH to 7.2 – 7.6 prior to application of this product.
2. Apply product when spa is not in use.
3. [Apply product at a rate of 3 tablespoons per 500 gallons.] [Apply entire 1.5 ounce packet per 500 gallons.]
4. With pump in operation, apply the entire treatment dosage at one time. Broadcast across water's surface. [To prevent damage to spa surface, use an appropriate brush to disperse any undissolved granules which may have settled to the bottom of the spa.]
5. Apply directly to spa water only. Do not add through a skimmer or any automatic dispensing device.
6. Add this product at least once a week. Additional applications are recommended after periods of heavy spa usage, significant rainfall or the appearance of cloudy water.

TEST CHLORINE OR BROMINE LEVEL PRIOR TO RE-ENTRY. DO NOT RE-ENTER SPA UNTIL YOUR TEST KIT READING INDICATES A CHLORINE LEVEL OF 5 PPM OR LESS OR BROMINE LEVEL OF 8 PPM OR LESS.

{Reader Note: 8 ppm bromine is re-entry level used for BCDMH (bromine treated) spas in EPA Registration # 5185-420.}

STORAGE AND DISPOSAL: Keep this product dry in original tightly closed container when not in use. Store in a cool, dry, well ventilated area away from heat or open flame. If product becomes damp, discard, following instructions for contamination under Physical or Chemical Hazards. **CONTAINER DISPOSAL:** Non-refillable container. Do not reuse or refill this container. Offer for recycling, if available. Triple rinse container (or equivalent) promptly after emptying.

PRECAUTIONARY STATEMENTS:

HAZARDS TO HUMANS AND DOMESTIC ANIMALS: DANGER: Corrosive. Causes irreversible eye damage. Harmful if swallowed or absorbed through the skin. Causes skin irritation. Do not get in eyes, on skin, or on clothing. Prolonged and frequently repeated skin contact may cause allergic reactions in some individuals. Wear safety glasses or goggles and rubber gloves when handling this product. Wash thoroughly with soap and water after handling and before eating, drinking, chewing gum, using tobacco or using the toilet. Remove and wash contaminated clothing before reuse.

PHYSICAL OR CHEMICAL HAZARDS: CONTAINS OXIDIZING AGENT. Do not mix with other chemicals or any other substance. DO NOT pre-dissolve or add water to this product. Always apply directly into the pool. Contamination of this product with small amounts of water or other substances may start a chemical reaction and generate heat, hazardous gas, possible fire and explosion. In case of contamination or decomposition, do not reseal [bag] [container]. Isolate [bag] [container] in open air or well-ventilated area. Flood [bag] [container] and area with large volumes of water. In case of spills, scoop up and place product in pool water, then flood spilled area with large volumes of water.

{Environmental hazards statement for end-use products in containers of less than 5 gallons (liquid) or less than 50 pounds (solid, dry weight).}

[ENVIRONMENTAL HAZARDS This pesticide is toxic to fish and aquatic organisms.]

{Environmental hazards statement for end-use products in containers of equal to or greater than 50 pounds (solid, dry weight).}

[ENVIRONMENTAL HAZARDS: This pesticide is toxic to fish and aquatic organisms. Do not discharge effluent containing this product into lakes, streams, ponds, estuaries, oceans or other waters unless in accordance with the requirements of a National Pollutant Discharge Elimination System (NPDES) permit and the permitting authority has been notified in writing prior to discharge. Do not discharge effluent containing this product to sewer systems without previously notifying the local sewage treatment plant authority. For guidance contact your State Water Board or Regional Office of the EPA.]

[NOTE: Buyer assumes all responsibility for safety and use not in accordance with directions.]

[NOTE: User assumes all responsibility for use not in accordance with directions.]

Tamper Evident Tear Strip
Tear away by using "ring pull" on either side of lid

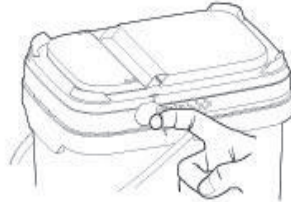

To open the lid (after the tear strip is removed)

Step-1

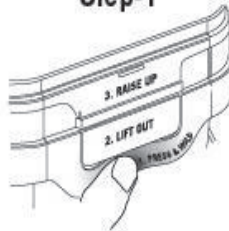

Step-2



Step-3



Tamper Evident Tear Strip

Tear away by using "ring pull" on either side of lid

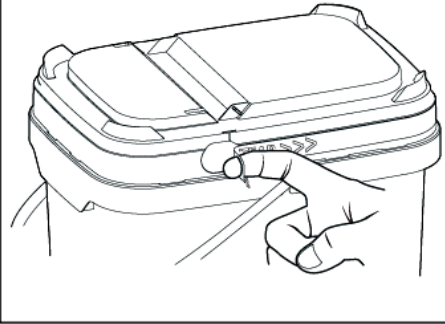

To open the lid
(after the tear strip is removed)

Step-1

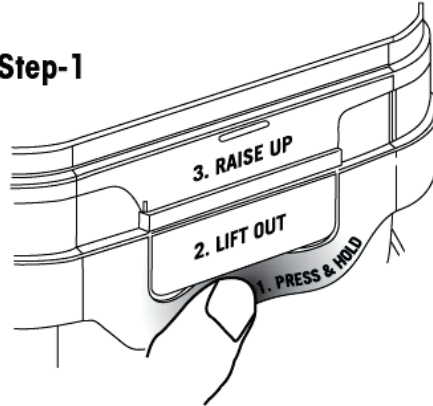

Step-2

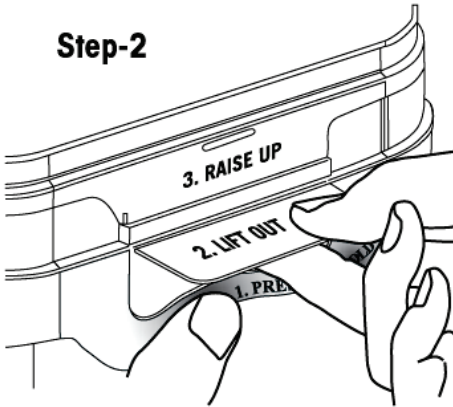

Step-3

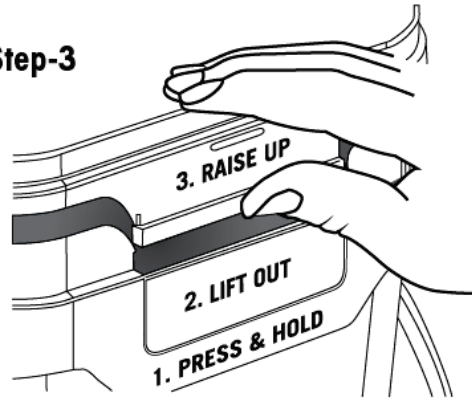

Do not store in direct sunlight

[OPTIONAL GRAPHICS CONTINUED]

{Note: The appropriate symbol(s) will be included based on packaging}

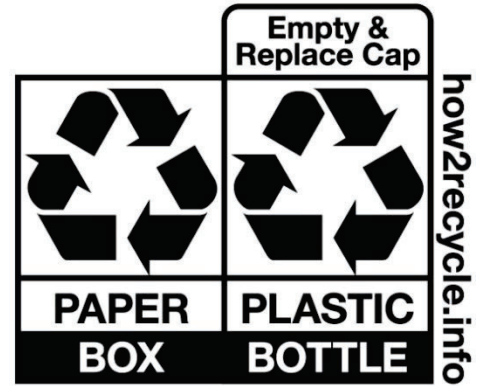
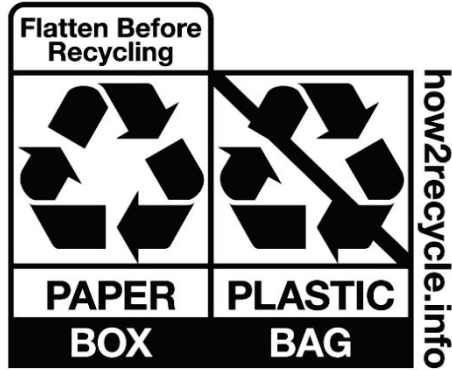

[OPTIONAL GRAPHICS CONTINUED]

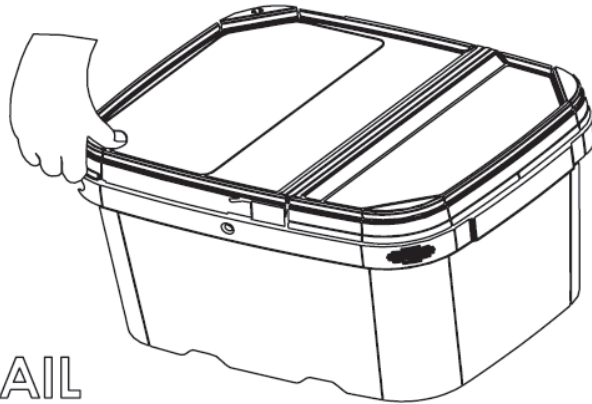

TO OPEN:
PRESS IN PAIL
CORNER AND
LIFT LID

TO CLOSE:
SNAP DOWN
LID CORNERS
AND SIDES

{Clorox Pool App icons}

{Reader's Note: The Clorox Pool App is a convenience tool for users that tracks pool history, shows pool information (i.e., analysis from test strips) and recommends products to use and where to buy them.}



[OPTIONAL GRAPHICS CONTINUED]

pool time.

Expert results begin with water testing.

DOWNLOAD THE FREE CLEARPOOL EXPERT™ APP

Download on the App Store | GET IT ON Google Play

CLOROX

Pool & Spa

Download the **FREE** Clorox® Pool App

Water Testing & Solution Center

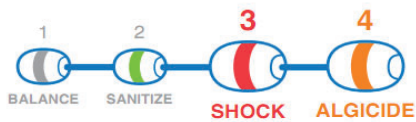

[OPTIONAL GRAPHICS CONTINUED]

The image displays two vertical promotional banners. The left banner has a blue background and features the Clorox Pool & Spa logo at the top. Below the logo, the text "FREE TEST STRIPS" is written in large, white, bold letters. At the bottom, a hand holds a smartphone displaying the Clorox Pool & Spa app interface. A teal box at the very bottom contains the text "Test Your Pool with the 'Clorox® Pool' App". The right banner has a purple background and features the "pool time." logo at the top, which includes a stylized ladder icon. Below the logo, the text "FREE TEST STRIPS" is written in large, white, bold letters. In the center, a hand holds a smartphone displaying a grid of colorful test strip results. A white box at the bottom contains the text "Download the Free ClearPool Expert™ App". At the bottom of the right banner, the code "J79000PTMSTR" is visible.

{July 24, 2019}