



UNITED STATES ENVIRONMENTAL PROTECTION AGENCY
WASHINGTON, DC 20460

OFFICE OF CHEMICAL SAFETY
AND POLLUTION PREVENTION

March 21, 2019

Mark Jernigan
Registration Manager, Pool
Recreational Water Products, Inc.
P.O. Box 1449
Buford, GA 30515

Subject: Notification per PRN 98-10 – Notification to add graphics
Product Name: SWIMMING POOL PRODUCT Z
EPA Registration Number: 67262-35
Application Date: December 20, 2018
Decision Number: 548556

Dear Mr. Jernigan:

The Agency is in receipt of your Application for Pesticide Notification under Pesticide Registration Notice (PRN) 98-10 for the above referenced product. The Antimicrobials Division (AD) has conducted a review of this request for its applicability under PRN 98-10 and finds that the action requested falls within the scope of PRN 98-10.

The label submitted with the application has been stamped “Notification” and will be placed in our records.

Should you wish to add/retain a reference to the company’s website on your label, then please be aware that the website becomes labeling under the Federal Insecticide Fungicide and Rodenticide Act and is subject to review by the Agency. If the website is false or misleading, the product would be misbranded and unlawful to sell or distribute under FIFRA section 12(a)(1)(E). 40 CFR 156.10(a)(5) list examples of statements EPA may consider false or misleading. In addition, regardless of whether a website is referenced on your product’s label, claims made on the website may not substantially differ from those claims approved through the registration process. Therefore, should the Agency find or if it is brought to our attention that a website contains false or misleading statements or claims substantially differing from the EPA approved registration, the website will be referred to the EPA’s Office of Enforcement and Compliance.

If you have any questions, you may contact Melanie Bolden at (703) 347-0165 or via email at Bolden.Melanie@epa.gov.

Sincerely,

A handwritten signature in blue ink that reads "Wanda G. Fuller, for".

Demson Fuller, Product Manager 32
Regulatory Management Branch I
Antimicrobials Division (7510P)
Office of Pesticide Programs

{All text in brackets [xxx] is optional and may or may not be included on a final label.}
{All text in braces {xxx} is administrative and will not appear on a final label.}

Swimming Pool Product Z

ACTIVE INGREDIENTS:

Sodium dichloro-s-triazinetriene	63.05%
Copper (metallic)***	0.26%
OTHER INGREDIENTS	36.69%
TOTAL INGREDIENTS	100.00%

(Available Chlorine: 39%)

*** Derived from copper citrate

KEEP OUT OF REACH OF CHILDREN DANGER

See [back] [side] panel for First Aid and additional Precautionary Statements. *{If First Aid appears on back or side panel}*

See [back] [side] panel for additional Precautionary Statements. *{If First Aid appears on front panel}*

MANUFACTURED FOR:

RECREATIONAL WATER PRODUCTS

[AQUA CHEM DIVISION]

[PoolTime Division]

P.O. BOX 1449

BUFORD, GEORGIA 30515

Net [Weight] [Contents]: *{as indicated on container}*

EPA REG. NO. 67262-35

EPA EST. NO. 5185-GA-1 [(BL)] {or} [(Z)]

7616-CA-1 [(C)]

{If multiple EPA Establishment Numbers appear on the label.}

[Actual establishment shown in code above or below label printed on [bottle] [container]]

[Letter designation in lot code printed above or below on [bottle] [container] identifies actual establishment.]

NOTIFICATION

67262-35

The applicant has certified that no changes, other than those reported to the Agency have been made to the labeling. The Agency acknowledges this notification by letter dated:

03/21/2019

[What?] *{For use on front panel of label as a header above/beside product name.}*

[Why?] *{For use on front panel of label as a header above/beside use claims chosen from accepted label text that relates to the consumer features and benefits of product.}*

{General statements available to all labels}

[Do Not Mix With Any Other Product]

[Do Not Mix this Product with Calcium Hypochlorite, or Any Other Product]

[Patented Technology]

[U.S. Patent # 7,238,290]

[TO OPEN CUT ALONG DOTTED LINE WITH SCISSORS] *{Statement to appear in upper corner of child resistant bag, when product sold in bags.}*

[With Blue Algae Fighting Crystals]

[Kills Bacteria]

[Kills Bacteria and Algae]

[Kills algae]

[Protects Against Algae]

[Guards Against Algae]

[Controls Algae]

[Can be used in salt pools]

[Compatible with salt pools]

[For use with all pool surfaces]

[For all pool surfaces including vinyl, plaster and fiberglass]

[For all pools, including vinyl, plaster and fiberglass]

[For all pool surfaces]

[[One] [1] lb treats 12,000 Gallons]

[[One] [1] bag treats 10,000 Gallons] *{Only for use when sold in 13.4 ounce bags or containers}*

[Made in USA]

[Multi-purpose [pool shock] [pool cleaner] [shock] [algaecide] [organic contaminant remover**]
[clarifier] [pH buffer]]

[All purpose [pool shock] [pool cleaner] [shock] [algaecide] [organic contaminant remover**]
[clarifier] [pH buffer]]

[Dual action [pool shock] [pool cleaner] [shock] [algaecide] [organic contaminant remover**]
[clarifier] [pH buffer]]

[Dual function [pool shock] [pool cleaner] [shock] [algaecide] [organic contaminant remover**]
[clarifier] [pH buffer]]

[Multi function [pool shock] [pool cleaner] [shock] [algaecide] [organic contaminant remover**]
[clarifier] [pH buffer]]

[[Kills Algae], [Kills Bacteria], [Oxidizes], [Destroys Organic Wastes], [Organic contaminant
remover**], [Clarifies], [Stabilizer], [Filter Enhancer], [Enhances Filtration], [Prevents Algae],
[Controls Algae,] [Contains Sunlight Protector] [pH buffer]]

**[such as] [body & suntan oils] [body oils] [&] [suntan oils] [&] [sweat] [perspiration] [&]
[lotions] [&] [urine]

[Kills all types of algae]

[Fights green, mustard and black algae]

[For [clean] [clear] [algae-free] water]

[Treats visible algae]
 [Kills [and] [prevents] [and] [controls] [green], [black], [and] [mustard] algae]
 [Kills and controls all pool algae types]
 [An all purpose pool algaecide]
 [[Prevents] [Controls] all types of algae]
 [Effective [kill] [and] [prevent] [controls] algae treatment]
 [Controls [green] [mustard] [black] algae]
 [Keeps water clear and free of visible [green] [mustard] [black] algae]
 [Fast [green] [mustard] [black] algae control]
 [[Removes] [Eliminates] [Destroys] [Breaks down] organic waste** [for sparkling clear water]]
 [[Removes] [Eliminates] [Destroys] [Breaks down] organic contaminants** [for sparkling clear water]]
 [[Removes] [Eliminates] [Destroys] [Breaks down] [organic contaminants] [sunscreen] [pet dander] [fertilizer] [pollen] [skin oils] [lotions] [sweat] [urine] [pee]]
 [[Controls] [Eliminates] [Destroys] [Breaks down] swimmer contaminants [such as] [including] [oils] [sweat] [lotion] [urine] [pee]]
 [[Removes] [Eliminates] [Destroys] [Breaks down] organic contaminants**]
 [Protects against [bacteria] [and][algae] [and] [organic contaminants**] [for] [clean] [and] [clear] [water]]
 **[such as] [body & suntan oils] [body oils] [&] [suntan oils] [&] [sweat] [perspiration] [&] [lotions] [&] [urine]
 [Prevents pH bounce]
 [pH stable to protect [pool] equipment and surfaces]
 [pH stable to prevent corrosion and scale]
 [pH neutral]
 [[Removes] [Eliminates] [Reduces] chlorine odor]
 [[Removes] [Eliminates] [Reduces] pool odor]
 [Effective against [chlorine] odor]
 [Deodorizes your pool]
 [Use to clean and deodorize]
 [[Destroys] [Eliminates] [Removes] [Breaks down] eye irritating compounds in swimming pool water]
 [[Destroys] [Eliminates] [Removes] [Breaks down] contaminants that [contribute to] [lead to] [cause] eye irritation]
 [Shocks water clear]
 [[Prevents] [Eliminates] [Quickly] [Clears] [cloudy] [murky] [green] water]
 [[Improves] [Enhances] filtration]
 [Clarifier enhances filtration]
 [Creates [comfortable] [swim-ready] water]
 [For a comfortable pool experience]
 [Use for a shockingly [clean] [and] [clear] pool]
 [Great for an extra touch of clean]
 [An added touch of clean]
 [Keeps water [clean] [and] [clear] during severe heat or rain]
 [Cleans pool water after heavy use]
 [Freshens pool water after heavy use]

[For extra clean water]

[For fresh, clear water]

[[With] Algae –Killing Crystals]

[6-in1 [multifunctional] [formula] [shock]]

[6-in-1 [action]]

{Spanish statement directing Spanish speakers to obtain assistance before using product.

Translates in English to: “If you do not understand the (this) label, find someone to explain it to you in detail.”}

[Si usted no entiende la etiqueta, busque a alguien para que se lo explique a usted en detalle.]

[Fast dissolving], [multi-functional] shock with [Xtra] [extra] [added] algae-killing [strength]

[power] [ability] for clear pool water [that is free of visible algae]]

[Fast dissolving], [multi-functional] shock with an [Xtra] [extra] [added] algae-killing ingredient for clear pool water [that is free of visible algae]]

[[Powers through] [fights] [eliminates] filth]

[Works quickly to restore pool water freshness & clarity]

[[Clears [cloudy] water] [&] [removes filth]]

[[Clears [cloudy] water] [&] [removes swimmer contaminants**]]

**[such as] [body & suntan oils] [body oils] [&] [suntan oils] [&] [sweat] [perspiration] [&] [lotions] [&] [urine]

[Improves filter performance]

[Won't impact pH]

[For use with all filter & surface types]

[Easy 1 2 3 Pool Care Brand System]

[Easy open] {for 1lb bottle application}

[Easy pour] {for 1lb bottle application}

[Step 3]

[Shock]

[For Pools] *{For use with products that have pool use directions}*

[For Pools Only] *{For use with products that have pool use directions}*

[Not for use in Spas] *{For use with products that have pool use directions}*

[For Spas] *{For use with products that have spa use directions}*

[For Spas Only] *{For use with products that have spa use directions}*

[Salt pool compatible]

[Kills all types of pool algae]

[Step 4]

[Step 4- Shock] *{Shocks are marketed as step four of a five step program to treat swimming pool water for Pool Time brand.}*

{Optional marketing statements for use only with superchlorination/shock directions}

[6-in-1 Pool Shock]

[pH Buffer]

[Will Not Increase pH]

[Clears Cloudy Water]

[Quickly Clears Cloudy Water]

[Works Quickly to Allow Swimming in as Soon as 15 Minutes*]
[Dissolves Completely]
[Creates Sparkling Water]
[Provides Crystal Clear Water]
[Use Regularly for Sparkling Water]
[[Prevents] [Controls] Algae]
[[Prevents] [Controls] [Future] Algae [Growth]]
[Treats 12,000 Gallons] *{Only for use when sold in one pound bags or containers}*
[Treats 10,000 Gallons] *{Only for use when sold in 13.4 ounce bags or containers}*
[Destroys Organic Contaminants**]
**[such as] [body & suntan oils] [body oils] [&] [suntan oils] [&] [sweat] [perspiration] [&]
[lotions] [&] [urine]

[Won't Discolor Pool Surfaces#]
[For use in vinyl, painted, fiberglass, or color plaster surface pools]
[Restores Water Clarity]
[Fast Dissolving Shock Treatment]
[Fast Dissolving]
[Treat and Swim In As Soon As 15 Minutes*]
[Treat and Swim in 15 [min] [minutes*]]
[Swim in 15 [min] [minutes*]]

*** Refer to the Re-entry statement on the back panel for further guidance.**

When Used as Directed

[[Kills Algae], [Kills Bacteria], [Oxidizes], [Destroys Organic Wastes**], [Clarifies], [Filter Enhancer], [Enhances Filtration], [Prevents Algae], [Controls Algae], [Contains Sunlight Protector]]
**[such as] [body & suntan oils] [body oils] [&] [suntan oils] [&] [sweat] [perspiration] [&]
[lotions] [&] [urine]
[Multi-Functional Formula]
[Multi-Purpose Shock]
[Suitable for All Pool Types] *{This statement alerts consumer to the fact they may use this product in above ground, in ground, indoor, outdoor, plaster, vinyl, fiberglass pools}*
[For Use In All Pool Types] *{This statement alerts consumer to the fact they may use this product in above ground, in ground, indoor, outdoor, plaster, vinyl, fiberglass pools}*
[No Need to Pre-Dissolve]
[Add Directly To Pool]
[One Bag Treats 12,000 Gallons] *{Only for use when sold in one pound bags}*
[One Bag Treats 10,000 Gallons] *{Only for use when sold in 13.4 ounce bags or containers}*
[[pH Balanced], [Filter Enhancer], [Sunlight Protected]] *{Cyanuric Acid is a known UV light stabilizer for chlorine}*
[Clarifies water]
[Improves filter performance]
[pH balanced]
[Gathers debris for easy removal]
[Gathers debris for easy filtration]
[Reduces chlorine odor and eye irritation]

[Suitable for opening pools]
[Suitable for pool opening and winterization]
[Suitable for pool opening and closing]
[Reduces chlorine odor]
[Reduces eye irritation]
[Reduces eye irritation and chlorine odor]
[Reduces [chlorine odor] [&] [eye irritation]]

[When?] *{For use on front panel of label as a header above/beside text chosen from accepted label text that relates to the consumer anticipated frequency of product use.}*
[1 X a week]

{Optional Claims to be used with Aqua Chem, Pool Time and Clorox brands using alternative brand names that contains Shock Xtra Blue in product name}

[Xtra] Kills Bacteria
[Xtra] Kills Algae
[Xtra] Kills Bacteria and Algae
[Xtra] With Blue Algae Fighting Crystals
[Xtra] [[with] Algae-Killing Crystals]

{The “Pool Essentials System” box below may be placed on the label to allow easy product category identification by consumers.}

{When sold with shock directions only}

Pool Essentials System	<input type="radio"/>	<input type="radio"/>	<input checked="" type="radio"/>	<input type="radio"/>
	balance	chlorinate	shock	algaecide

{When sold with shock/algae kill directions}

Pool Essentials System	<input type="radio"/>	<input type="radio"/>	<input checked="" type="radio"/>	<input checked="" type="radio"/>
	balance	chlorinate	shock	algaecide

{The “4-step System” box below may be placed on the label to allow easy product category identification by consumers.}

{When sold with shock directions only}

4-step System	<input checked="" type="radio"/>	<input type="radio"/>	<input checked="" type="radio"/>	<input type="radio"/>
	1 balance	2 chlorinate	shock	4 algaecide

{When sold with shock/algae kill directions}

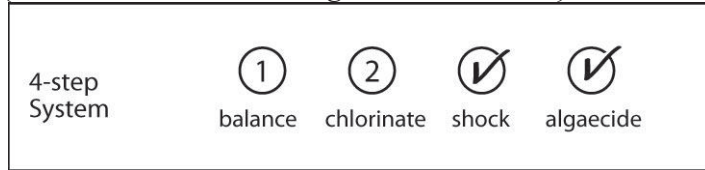

{Optional marketing statements that may be used with swimming pool winterization.}

[For all pool surfaces] *{This statement alerts consumer to the fact they may use this product in above ground, in ground, indoor, outdoor, plaster, vinyl, fiberglass pools}*

[Winter oxidizer and clarifier]

[Suitable for above ground pools]

[Effective winter shock]

[Suitable for vinyl pools]

[First step in an effective winterization program]

[For use in vinyl, painted, fiberglass or color plaster surface pools]

[Restores water clarity]

[Quick-dissolving winter shock]

[Oxidizer, Buffer, Clarifier, Flocculant]

[No pre-dissolving]

[Suitable for all pool surfaces]

[Quick-dissolving]

[Multi-purpose]

[Dual-action]

[Regular use will create easier spring start-up]

[Suitable for closing pools]

[Suitable for winterizing pools]

{Optional marketing statements that may be used with spa & hot tub oxidizing.}

[For Spas & Hot Tubs]

[Oxidizes and clarifies for beautiful water]

[Removes unpleasant odors]

[Restores water sparkle]

[Produces clear, sparkling spa water]

[Easy to use]

[Multi-purpose shock]

[Oxidizer, water clarifier, flocculant, buffer]

[Treats 500 gallons] *{Only to be used when sold in 1.5 ounce bags}*

[No pre-mixing]

[Reduces odors]

[Rapidly dissolving]

[Suitable for use with ozone]

[Compatible with ozone and ionizers]

[Compatible with ionizers]

[Stabilizes pH]

{Following chart is optional}

Our Ingredients:	What They Do:
Sodium dichloroisocyanurate	Oxidizer, Kills Bacteria, and Kills Algae, Releases Sunlight Protector
Copper (metallic)	Kills Algae, [Protects Against Algae]
pH Buffer	Prevents rapid pH changes, Will not increase pH, Shock is gentle on pool surfaces and equipment
Oxidizer	Destroys organic wastes**
Clarifier	Clumps larger particles together for water polishing
Filtration Enhancer	Magnifies filter's power to remove contaminants from pool water

**[such as] [body & suntan oils] [body oils] [&] [suntan oils] [&] [sweat] [perspiration] [&]
[lotions] [&] [urine]

{Following Chart is Optional}

[Sanitizer	Chlorine	Salt	Bromine]
[Pool Type	In ground	Above ground	Pop-Up]
[Surface Type	Aggregate	Concrete	Fiberglass
	Gunite	Plaster	Vinyl]
[Filter Type	D.E., Sand, Cartridge, Zeolite]		

{Packaging Related Claims: For use when product is packaged in bottles}

[No Scissors Needed!] *{When bottle replaces film bag of child resistant material that required
scissors to open.}*

[Re-sealable Lid]

[These shock bottles are recyclable.] *{When bottle is made with recyclable material.}*



{Directions to be used for superchlorination/shock. Option A}

SWIMMING POOL SHOCK

{To maintain brand segmentation, two sets of marketing statements are provided to maintain separate brand identity.}

{One of the following two paragraphs will be used on the label.}

[This fast acting premium 6-in-1 shock product is easy to use and performs multiple, important maintenance functions. When used as directed, Swimming Pool Product Z effectively:

- Kills bacteria and algae [and protects against algae growth].
- Destroys organic contaminants [(such as) [body & suntan oils] [body oils] [suntan oils], [sweat] [perspiration], lotions and urine)] that cause cloudy water, musty odors and eye irritation]

[Because it dissolves rapidly and is multifunctional, this product works fast and effectively, allowing swimming to resume in as little as 15 minutes.*]

{or}

[Swimming Pool Product Z contains an oxidizer, clarifier, filtration enhancer and pH buffers to provide brilliantly clear water with no cloudy residue and without increasing pH like ordinary shock products.] [Swimming Pool Product Z is suitable for use in vinyl, plaster, Pebble Tech, [aggregate], painted plaster, colored plaster, and fiberglass pools. Swimming Pool Product Z will not discolor swimming pool surfaces when used as directed.]

[Swimming Pool Product Z provides the solution for brilliant, clear, and inviting pool water and is suitable for all pool types.]

DIRECTIONS FOR USE: It is a violation of Federal Law to use this product in a manner inconsistent with its labeling. Read entire label and use strictly in accordance with precautionary statements and directions.

[Make sure all pool equipment is working properly, including pump, filter, skimmer and heater. Backwash filter following manufacturer's directions. Check alkalinity, pH and calcium hardness with a test kit. Adjust alkalinity to 80-125 ppm for plaster pools; 125-150 for vinyl or fiberglass pools. Adjust pH to 7.2 – 7.6 by adding a pH decriaser or pH increaser. Adjust calcium hardness to 200-275 ppm for plaster pools; 175-225 for vinyl or fiberglass pools. When using other products as outlined in directions for this product, always follow directions on those products.]

IMPORTANT NOTE: DO NOT pre-dissolve Swimming Pool Product Z. As with other shock products, DO NOT apply through skimmer or chemical feeding device as other chemicals may be present which could result in a violent reaction.

{Routine Maintenance section is optional and may not be included in all labels containing Swimming Pool Shock directions.}

[Routine Maintenance:

1. [With pump running, pour from 3 feet high or less 1 lb. of Swimming Pool Product Z per 12,000 gallons of pool water, directly into pool around edges.] *{or}* [*for use if product is in 13.4 ounce premeasured bag*] With pump running, pour from 3 feet high or less 1 bag of Swimming Pool Product Z per 10,000 gallons of pool water, directly into pool around edges.] *{and/or}* [For small vinyl pools, with pump operating, apply 3.5 teaspoons of Swimming Pool Product Z per 500 gallons or 1.3 ounces per 1,000 gallons directly into pool**.]
2. Wait at least 15 minutes after product application before entering pool.*
3. Operate pump and filter continuously for 4-8 hrs. after product addition.
4. For best results, apply product weekly as part of your maintenance routine.
5. This product is not a sanitizer. To sanitize your pool, use the appropriate [AquaChem] [Pool Time] product specifically formulated for this purpose.]

If Algae is Present:

1. Vacuum leaves and any other foreign debris from pool. Brush visible algae thoroughly from pool's surface with a surface-compatible brush.
2. [With pump running, pour from 3 feet or lower 1 lb. of Swimming Pool Product Z per 12,000 gallons of pool water, directly into pool water in areas of heaviest algae growth.] *{or}* [*for use if product is in 13.4 ounce premeasured bag*] With pump running, pour from 3 feet or lower 1 bag of Swimming Pool Product Z per 10,000 gallons of pool water, directly into pool water in areas of heaviest algae growth.] *{and/or}* [For small vinyl pools, with pump operating, apply 3.5 teaspoons of Swimming Pool Product Z per 500 gallons or 1.3 ounces per 1,000 gallons directly into pool**.]
3. Operate pump and filter continuously for 24 hrs. after product application.
4. Afterwards, repeat brushing of pool surfaces.
5. Do not enter the pool until the free available chlorine residual is 1-4 ppm.
6. If necessary repeat the treatment.

[[**Use a clean, dedicated spoon to dose the appropriate amount of product into the pool. Keep the dosage spoon stored out of reach of children.] [3 teaspoons equal 1 tablespoon. 1.75 tablespoons equals 1 ounce.]]

***TEST CHLORINE LEVEL PRIOR TO RE-ENTRY. RE-ENTRY INTO TREATED SWIMMING POOLS IS PROHIBITED ABOVE LEVELS OF 4 PPM CHLORINE DUE TO RISK OF BODILY INJURY.**

{Simplified use directions to be used for swimming pool superchlorination/shock. Option B}

SWIMMING POOL SHOCK

[How?]

DIRECTIONS FOR USE: It is a violation of Federal Law to use this product in a manner inconsistent with its labeling. Read entire label and use strictly in accordance with precautionary statements and directions.

- Test and balance water before using this product. Adjust pH to 7.2-7.6. Visit [the Aqua Chem Web Site] {or} [www.aquachem.com] {or} [the Pool Time website] {or} [www.pooltime.com] for complete pool balancing instructions.

To Shock Water [Clear]:

- [Add 1 lb. per 12,000 gallons into the deepest pool area, operate filter and pump for 4 to 8 hours.] {or} [*for use if product is in 13.4 ounce premeasured bag*] Add 1 bag per 10,000 gallons into the deepest pool area, operate filter and pump for 4 to 8 hours.] Hold bag no more than 3 feet over pool surface.
- DO NOT pre-dissolve, DO NOT apply through skimmer or chemical feeder, DO NOT mix with other chemicals; a violent reaction may result.
- Wait at least 15 minutes after product application before entering pool.*
- Apply more product after heavy use, high temperatures, or rain. For best results, shock pool weekly.

[To Kill Algae:

- Brush pool surfaces while filter and pump are operating.
- [Add 1 lb. per 12,000 gallons directly to the pool water in areas of heaviest algae growth, operate filter and pump for 24 hrs.] {or} [*for use if product is in 13.4 ounce premeasured bag*] Add 1 bag per 10,000 gallons directly to the pool water in areas of heaviest algae growth, operate filter and pump for 24 hrs.] Hold bag no more than 3 feet over pool surface.
- Repeat brushing.
- Do not enter the pool until the free available chlorine residual is 1-4 ppm.
- Product can be re-applied after 72 hours if necessary.]



***TEST CHLORINE LEVEL PRIOR TO RE-ENTRY. RE-ENTRY INTO TREATED SWIMMING POOLS IS PROHIBITED ABOVE LEVELS OF 4 PPM CHLORINE DUE TO RISK OF BODILY INJURY.**

[To Close Pool:

- [Add 1 lb. per 6,000 gallons into the deepest pool area while filter and pump are operating.] {or} [*for use if product is in 13.4 ounce premeasured bag*] Add 1 bag per 5,000 gallons into the deepest pool area while filter and pump are operating.]
- Apply an appropriate winter [algaecide] {or} [algicide] after addition of this product.]
- [Visit [the Aqua Chem Web Site] {or} [www.aquachem.com] {or} [the Pool Time website] {or} [www.pooltime.com] for complete pool closing instructions.]]

{Simplified use directions to be used for swimming pool superchlorination/shock. Option C1, Product sold in 1 pound or larger bag/container}

DIRECTIONS FOR USE: It is a violation of Federal Law to use this product in a manner inconsistent with its labeling. Read entire label and use strictly in accordance with precautionary statements and directions. Test and balance water prior to use. Adjust pH to 7.2-7.6 [and free chlorine to 1-4ppm]. Visit [website] for [free water analysis] [and] [personalized product and dosage recommendations].

DOSAGE:	WHEN / HOW TO USE:
1 lb per 12,000 GAL	<p>TO SHOCK WATER CLEAR AND DESTROY ORGANIC CONTAMINANTS**:</p>  <p>Broadcast in pool's deepest area with filter and pump on. Run filter and pump for 4-8 hrs. DO NOT pre-dissolve, DO NOT add through skimmer or feeder, and DO NOT mix with other chemicals (a violent reaction may result). Re-entry: Wait at least 15 minutes after product application before entering pool.* Enter when chlorine level is 1-4ppm. For best results: Shock pool weekly and also after heavy use, high temperatures, or rain. Use at night to prevent sunlight degradation.</p>
	<p>TO KILL ALGAE:</p>  <ol style="list-style-type: none"> 1. Brush pool surfaces while filter and pump are operating. 2. Add in areas of heaviest algae growth, operate filter and pump for 24 hrs. 3. Repeat brushing. Product can be re-applied after 72 hrs. if necessary. 4. Enter when chlorine level is 1-4ppm.*
1 lb per 6,000 GAL	<p>TO CLOSE POOL:</p> <p>Broadcast in pool's deepest area with filter and pump on. Apply an algaecide per closing directions after this product. Visit cloroxpool.com for complete closing instructions.</p>

*TEST CHLORINE LEVEL PRIOR TO RE-ENTRY. RE-ENTRY INTO TREATED SWIMMING POOLS IS PROHIBITED ABOVE LEVELS OF 4 PPM CHLORINE DUE TO RISK OF BODILY INJURY.
 **[such as] [body & suntan oils] [body oils] [&] [suntan oils] [&] [sweat] [perspiration] [&] [lotions] [&] [urine]

{Directions to be used for shock application, Option C2, Product sold in 13.4 ounce bag}

DIRECTIONS FOR USE: It is a violation of Federal Law to use this product in a manner that is inconsistent with its labeling. Read entire label and use strictly in accordance with precautionary statements and directions.

[Backwash filter following manufacturer’s directions [to ensure adequate circulation].] Test and balance water prior to use. Adjust pH to 7.2-7.6. Visit [*website*] for free water analysis and personalized product and dosage recommendations.

Dosage	When/How To Use:
1 bag per 10,000 GAL	TO SHOCK WATER CLEAR AND DESTROY ORGANIC CONTAMINANTS**: <i>{Optional: Insert Pictogram A and/or B within this box}</i> Broadcast in pool’s deepest area with filter and pump on. Run filter and pump for 4-8 [hrs.] [hours]. DO NOT pre-dissolve, DO NOT add through skimmer or feeder, DO NOT mix with other chemicals (a violent reaction may result). [[After 15 minutes, to] [To] prevent damage to pool surface, use an appropriate pool brush to disperse any undissolved granules which may have settled to the bottom of the pool.] RE-ENTRY: Wait at least 15 minutes after product application before entering pool.* Enter when chlorine level is 1-4 ppm. FOR BEST RESULTS: Shock pool weekly and also after heavy use, high temperatures, or rain. Use at night to prevent sunlight degradation.
	TO KILL ALGAE: <i>{Optional: Insert Pictograms B/A/B (brush/add product/repeat brushing) within this box}</i> 1. Brush pool surfaces while filter and pump are operating. 2. Add in areas of heaviest algae growth, operate filter and pump for 24 hrs. 3. Repeat brushing. Product can be re-applied after 72 hrs. if necessary. 4. Enter when chlorine level is 1-4 ppm.*
	TO CLOSE POOL: Broadcast in pool’s deepest area with filter and pump on, brushing any undissolved product. Apply an algaecide per closing directions after this product. Visit [<i>website</i>] for complete closing instructions.
1 bag per 5,000 GAL	

*TEST CHLORINE LEVEL PRIOR TO RE-ENTRY. RE-ENTRY INTO TREATED SWIMMING POOLS IS PROHIBITED ABOVE LEVELS OF 4 PPM CHLORINE DUE TO RISK OF BODILY INJURY.

**[such as] [body & suntan oils] [body oils] [&] [suntan oils] [&] [sweat] [perspiration] [&] [lotions] [&] [urine]

[Note: To prevent damage to pool surface, use an appropriate pool brush to disperse any undissolved granules which may have settled to the bottom of the pool.]

Pictogram A



Pictogram B



{Optional abbreviated use directions & graphics for use on retail box containing one pound or 13.4 oz. bags of product used for superchlorination. Retail box will also display complete use directions and precautionary statements on other panels when abbreviated use directions and graphics are included on retail box. Option A}

[1 lb. bag treats 12,000 gallons of water.] *{Only for use when sold in one pound bags or containers}*

[1 bag treats 10,000 gallons of water.] *{Only for use when sold in 13.4 ounce bags or containers}*



Step One: Open a single bag of Swimming Pool Product Z by cutting along the dotted line with scissors.



Step Two: With pump operating, pour contents directly into pool while walking along the perimeter.



Step Three: Wait at least 15 minutes before entering your pool. Test chlorine levels before re-entry*.

Be sure to operate your pump and filter continuously for 4 to 8 hours after adding Swimming Pool Product Z. For best results, apply weekly as part of your maintenance routine. Check the back of this box for more about Swimming Pool Product Z including detailed directions on application and precautionary statements.

*** Re-entry into treated swimming pools is prohibited above levels of 4 ppm chlorine due to risk of bodily injury.**

{Simplified optional abbreviated use directions & graphics for use on retail box containing one pound or 13.4 oz. bags of product used for superchlorination. Retail box will also display complete use directions and precautionary statements on other panels when abbreviated use directions and graphics are included on retail box. Option B}

[1 lb. bag treats 12,000 gallons of water.] *{Only for use when sold in one pound bags or containers}*

[1 bag treats 10,000 gallons of water.] *{Only for use when sold in 13.4 ounce bags or containers}*



Step One: Open a single bag by cutting along the dotted line with scissors.



Step Two: Add [1 lb. per 12,000 gallons] *{or}* [*for use if product is in 13.4 ounce premeasured bag*] 1 bag per 10,000 gallons] into the deepest pool area, operate filter and pump for 4 to 8 hours. Hold bag no more than 3 feet over pool surface.



Step Three: Wait at least 15 minutes after application before entering pool*.

- Apply more product after heavy use, high temperatures, or rain. For best results, shock pool weekly.
- Check the back of this box for more information, detailed application directions, and precautionary statements.

*** Test chlorine levels before re-entry. Re-entry into treated swimming pools is prohibited above levels of 4 ppm chlorine due to risk of bodily injury.**

{Directions to be used for swimming pool winterization.}

SWIMMING POOL WINTERIZATION

{To maintain brand segmentation, two sets of marketing statements are provided to maintain separate brand identity.}

{One of the following two paragraphs will be used on the label.}

[This product is a unique dual action formulation which is the first step in an effective winterization program. [Swimming Pool Product Z] *{or}* [This product] both oxidizes and clarifies pool water. This quick dissolving product is suitable for use in pools of any surface type.]

{or}

[This multipurpose formulation oxidizes, clarifies, and buffers all in one easy to use product, ensuring an easy spring start-up. Quick dissolving, this easy to use product is suitable for all pool surfaces. This unique formulation results in outstanding water clarity during the winter season and into spring start-up.]

May be used with chlorine, bromine, ozone and ionization systems. DO NOT use in pools sanitized with biguanides. This product is not a sanitizer. To sanitize your pool, use the appropriate [AquaChem] [Pool Time] product specifically formulated for this purpose.

IMPORTANT NOTE: DO NOT pre-dissolve Swimming Pool Product Z. As with other shock products, DO NOT apply through skimmer or chemical feeding device as other chemicals may be present which could result in a violent reaction.

DIRECTIONS FOR USE: It is a violation of Federal Law to use this product in any manner inconsistent with its labeling. Read entire label and use strictly in accordance with precautionary statements and directions.

Use [1 pound of this product for each 6,000 gallons] *{or}* [*for use if product is in 13.4 ounce premeasured bag*] 1 bag of this product for each 5,000 gallons] of pool water. With the circulation system of the pool on, pour from 3 feet high or less the entire dosage into the deep end of the pool. Brush any undissolved product off the surface of the pool with a surface compatible brush.

Continue to circulate the pool for **at least** 30 minutes before proceeding to the next step in the winterization process.

It is recommended that as part of the closing procedures, a quality winterizing algaecide be applied following the application of this product. After application of the algaecide, continue with the closing of the pool as directed by pool manufacturer or your dealer.

For mesh covered or non-covered pools, a mid-winter treatment may be required using an appropriate [AquaChem] [Pool Time] sanitizer.

{Directions to be used for spa and hot tub oxidizing.}

SPA AND HOT TUB OXIDIZER

{To maintain brand segmentation, two sets of marketing statements are provided to maintain separate brand identity.}

{One of the following two paragraphs will be used on the label.}

[This easy to use multi-purpose shock is specially formulated to destroy eye irritants and reduce unpleasant odors. [It is designed to correct most cloudy conditions and restore spa water sparkle.] It is compatible with ozone systems. This product enhances water comfort and stabilizes pH. [Special] [Unique] [It includes] ingredients [such as water clarifiers and filter enhancers] [that] aid the filter in removing small suspended particles to further enhance water clarity.]

{or}

[This product is specially formulated to destroy eye irritating chloramines, unpleasant odors, and corrects most cloudy conditions to restore spa water sparkle. It combines a blend of multiple oxidizers, water clarifiers and water enhancing buffers. Special ingredients aid the filter in removing small suspended particles to further enhance water clarity. This product provides enhanced water clarity, improved bather comfort, and is convenient to use. It is designed to be used with all types of spa surfaces.]

{One of the following two paragraphs will be used on the label.}

[This product is convenient to use and dissolves quickly and completely. There is no pre-mixing required and no undissolved solids remain. This product works with all surface types and may be used with chlorine, bromine, ozone, as well as ionizers. DO NOT use in spas sanitized with biguanides. This product is not a sanitizer. To sanitize your spa, use the appropriate [Spa Time] product.]

{or}

[This product dissolves quickly and completely. No premixing is required. This product is pH neutral and usage will not upset spa water balance. May be used with chlorine, ozone, bromine, and ionization systems. It is formulated for use with all types of spa surfaces. DO NOT use in spas sanitized with biguanides. This product is not a sanitizer. To sanitize your spa, use the appropriate [Spa Time] product.]

IMPORTANT NOTE: DO NOT pre-dissolve Swimming Pool Product Z. As with other shock products, DO NOT apply through skimmer or chemical feeding device as other chemicals may be present which could result in a violent reaction.

DIRECTIONS FOR USE: It is a violation of Federal Law to use this product in any manner inconsistent with its labeling. Read entire label and use strictly in accordance with precautionary statements and directions.

1. Test and adjust spa water pH to 7.2 – 7.6 prior to application of this product.
2. Apply product when spa is not in use.
3. [Apply product at a rate of 3 tablespoons per 500 gallons.] *{or}* [Apply entire 1.5 ounce packet per 500 gallons.] *{when product sold in 1.5 ounce packets}*
4. With pump in operation, apply the entire treatment dosage at one time. Broadcast across water's surface.
5. Apply directly to spa water only. Do not add through a skimmer or any automatic dispensing device.
6. Add this product at least once a week. Additional applications are recommended after periods of heavy spa usage, significant rainfall or the appearance of cloudy water.

TEST CHLORINE LEVEL PRIOR TO RE-ENTRY. DO NOT RE-ENTER SPA UNTIL YOUR TEST KIT READING INDICATES A CHLORINE LEVEL OF 5 PPM OR LESS OR BROMINE LEVEL OF 8 PPM OR LESS.

{Storage and Disposal directions when product is sold in bags.}

[STORAGE AND DISPOSAL: Keep this product dry in its original unopened bag until use. For partially used bags, fold over top of bag and secure with adhesive tape. Store unopened and partially used bags in a secure location away from children. Store in a cool, dry, well-ventilated area away from heat or open flame. If product becomes damp, discard, following instructions for contamination under Physical or Chemical Hazards. **CONTAINER DISPOSAL:** Non-refillable container. Do not reuse or refill this container. Offer for recycling, if available. Triple rinse container (or equivalent) promptly after emptying.]

{Storage and Disposal directions when product is sold in bottles.}

[STORAGE AND DISPOSAL: Keep this product dry in original tightly closed container when not in use. Store in a cool, dry, well-ventilated area away from heat or open flame. If product becomes damp, discard, following instructions for contamination under Physical or Chemical Hazards. **CONTAINER DISPOSAL:** Non-refillable container. Do not reuse or refill this container. Offer for recycling, if available. Triple rinse container (or equivalent) promptly after emptying.]

PRECAUTIONARY STATEMENTS

HAZARDS TO HUMANS AND DOMESTIC ANIMALS: DANGER: Corrosive: Causes skin burns. May be fatal if inhaled or swallowed. Causes irreversible eye damage. Harmful if absorbed through skin. Do not breathe dust or fumes. Irritating to nose and throat. Do not get in eyes, on skin or on clothing. Prolonged or frequently repeated skin contact may cause allergic reactions in some individuals. Wear safety glasses or goggles and use rubber gloves. For additional protection of skin, wear long sleeves and long pants. Wash thoroughly with soap and water after handling product and before eating, drinking or using tobacco. Remove contaminated clothing and wash clothing before reuse.

{When First Aid is not located on front panel of label, it will be separated by line rules from adjacent text and be in a different color.}

FIRST AID: IF IN EYES: Hold eye open and rinse slowly and gently with water for 15-20 minutes. Remove contact lenses, if present, after the first 5 minutes, then continue rinsing eye. Call a poison control center or doctor for treatment advice. **IF ON SKIN OR CLOTHING:** Take off contaminated clothing. Rinse skin immediately with plenty of water for 15-20 minutes. Call a poison control center or doctor for treatment advice. **IF INHALED:** Move person to fresh air. If person is not breathing, call 911 or an ambulance, then give artificial respiration, preferably mouth-to-mouth, if possible. Call poison control center or doctor for treatment advice. **IF SWALLOWED:** Call poison control center or doctor immediately for treatment advice. Have person sip a glass of water if able to swallow. Do not induce vomiting unless told to do so by the poison control center or doctor. Do not give anything by mouth to an unconscious person.

Have the product container or label with you when calling a poison control center or doctor, or going for treatment. [[IN CASE OF MEDICAL EMERGENCY, CALL [1-303-623-5716] [1-877-800-5553] [1-866-366-5048] [telephone number supplied by supplemental registrant].]

Note to Physician: Probable mucosal damage may contraindicate the use of gastric lavage.

PHYSICAL OR CHEMICAL HAZARDS: CONTAINS OXIDIZING AGENTS. Do not mix with other chemicals or any other substance. DO NOT pre-dissolve or add water to this product. Always apply directly into the pool. Contamination of this product with small amounts of water or other substances may start a chemical reaction and generate heat, hazardous gas, possible fire and explosion. In case of contamination or decomposition, do not reseal [bag] [container]. Isolate [bag] [container] in open air or well-ventilated area. Flood [bag] [container] and area with large volumes of water. In case of spills, scoop up and place product in pool water, then flood spilled area with large volumes of water.

{Environmental hazards statement for end-use products in containers of less than 50 pounds (solid, dry weight).}

ENVIRONMENTAL HAZARDS: This pesticide is toxic to fish and aquatic invertebrates and may contaminate water through runoff. Other than uses permitted by this label, do not apply directly to water. Do not contaminate water when disposing of equipment washwaters or rinsate.

[NOTE: Buyer assumes all responsibility for safety and use not in accordance with directions.]

[NOTE: User assumes all responsibility for use not in accordance with directions.]

[NOTE: Any questions or comments about Aqua Chem Products?]

[In the continental U.S. call 1-800-252-POOL (7665). Ask for your free pool care booklet.]

[Questions or comments call 1-800-252-POOL (7665).]

[[Questions?] [Pool Care Tips?] [1-800-SOS-POOL]]

[Visit Aqua Chem's Internet Web Site at <http://www.aquachem.com>]

[Visit PoolTime's Internet Web Site at <http://www.pooltime.com>]

[Visit Brand Name's Internet Web Site at <http://www.brandname.com>]

[Optional Graphics]

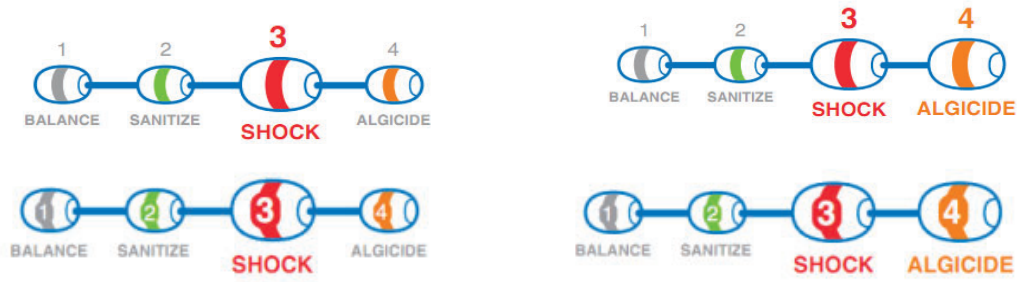



{The icon below may be used in conjunction with algae kill claims on this label. The statement “Kills algae” may be replaced with similar statements listed immediately below the icon.}

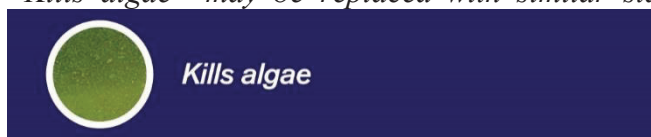

[With Blue Algae Fighting Crystals]

[Kills Bacteria and Algae]

[Kills algae]

[Protects Against Algae]

[Guards Against Algae]

[Controls Algae]

[Multi-purpose [pool shock] [pool cleaner] [shock] [algaecide] [organic contaminant remover**] [clarifier] [pH buffer]]

[All purpose [pool shock] [pool cleaner] [shock] [algaecide] [organic contaminant remover**] [clarifier] [pH buffer]]

[Dual action [pool shock] [pool cleaner] [shock] [algaecide] [organic contaminant remover**] [clarifier] [pH buffer]]

[Dual function [pool shock] [pool cleaner] [shock] [algaecide] [organic contaminant remover**] [clarifier] [pH buffer]]

[Multi function [pool shock] [pool cleaner] [shock] [algaecide] [organic contaminant remover**] [clarifier] [pH buffer]]

[[Kills Algae], [Kills Bacteria], [Oxidizes], [Destroys Organic Wastes], [Organic contaminant remover**], [Clarifies], [Stabilizer], [Filter Enhancer], [Enhances Filtration], [Prevents Algae], [Controls Algae,] [Contains Sunlight Protector] [pH buffer]]

**[such as] [body & suntan oils] [body oils] [&] [suntan oils] [&] [sweat] [perspiration] [&] [lotions] [&] [urine]
 [Kills all types of algae]
 [Fights green, mustard and black algae]
 [For [clean] [clear] [algae-free] water]
 [Treats visible algae]
 [Kills [and] [prevents] [and] [controls] [green], [black], [and] [mustard] algae]
 [Kills and controls all pool algae types]
 [An all purpose pool algaecide]
 [[Prevents] [Controls] all types of algae]
 [Effective [kill] [and] [prevent] [controls] algae treatment]
 [Controls [green] [mustard] [black] algae]
 [Keeps water clear and free of visible [green] [mustard] [black] algae]
 [Fast [green] [mustard] [black] algae control]
 [Fast dissolving], [multi-functional] shock with [Xtra] [extra] [added] algae-killing [strength] [power] [ability] for clear pool water [that is free of visible algae]]
 [Fast dissolving], [multi-functional] shock with an [Xtra] [extra] [added] algae-killing ingredient for clear pool water [that is free of visible algae]]
 [[Prevents] [Controls] Algae]
 [[Prevents] [Controls] [Future] Algae [Growth]]
 [[Kills Algae], [Kills Bacteria], [Oxidizes], [Destroys Organic Wastes**], [Clarifies], [Filter Enhancer], [Enhances Filtration], [Prevents Algae], [Controls Algae,] [Contains Sunlight Protector]]
 **[such as] [body & suntan oils] [body oils] [&] [suntan oils] [&] [sweat] [perspiration] [&] [lotions] [&] [urine]
 [Xtra] Kills Algae
 [Xtra] Kills Bacteria and Algae
 [Xtra] With Blue Algae Fighting Crystals
 [Xtra] [[with] Algae-Killing Crystals]

{The icon below may be used in conjunction with sunlight protection claims on this label. The statement “Stability for sunlight protection” may be replaced with similar statements listed immediately below the icon.}

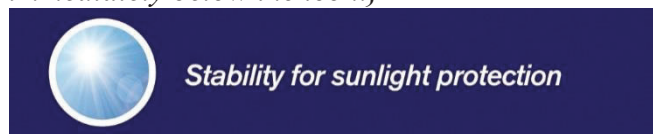

[[Kills Algae], [Kills Bacteria], [Oxidizes], [Destroys Organic Wastes**], [Clarifies], [Filter Enhancer], [Enhances Filtration], [Prevents Algae], [Controls Algae,] [Contains Sunlight Protector]]
 **[such as] [body & suntan oils] [body oils] [&] [suntan oils] [&] [sweat] [perspiration] [&] [lotions] [&] [urine]
 [[pH Balanced], [Filter Enhancer], [Sunlight Protected]] *{Cyanuric Acid is a known UV light stabilizer for chlorine}*

{The icon below may be used in conjunction with filtration claims on this label. The statement “Clarifier enhances filtration” may be replaced with similar statements listed immediately below the icon.}



- [[Improves] [Enhances] filtration]
- [Clarifier enhances filtration]
- [Improves filter performance]
- [[Kills Algae], [Kills Bacteria], [Oxidizes], [Destroys Organic Wastes**], [Clarifies], [Filter Enhancer], [Enhances Filtration], [Prevents Algae], [Controls Algae,] [Contains Sunlight Protector]]
- **[such as] [body & suntan oils] [body oils] [&] [suntan oils] [&] [sweat] [perspiration] [&] [lotions] [&] [urine]
- [[pH Balanced], [Filter Enhancer], [Sunlight Protected]] *{Cyanuric Acid is a known UV light stabilizer for chlorine}*
- [Improves filter performance]
- [Gathers debris for easy removal]
- [Gathers debris for easy filtration]

{The icon below may be used in conjunction with water clarifier claims on this label. The statement “Water clarifier” may be replaced with similar statements listed immediately below the icon.}



- [Multi-purpose [pool shock] [pool cleaner] [shock] [algaecide] [organic contaminant remover**] [clarifier] [pH buffer]]
- [All purpose [pool shock] [pool cleaner] [shock] [algaecide] [organic contaminant remover**] [clarifier] [pH buffer]]
- [Dual action [pool shock] [pool cleaner] [shock] [algaecide] [organic contaminant remover**] [clarifier] [pH buffer]]
- [Dual function [pool shock] [pool cleaner] [shock] [algaecide] [organic contaminant remover**] [clarifier] [pH buffer]]
- [Multi function [pool shock] [pool cleaner] [shock] [algaecide] [organic contaminant remover**] [clarifier] [pH buffer]]
- [[Kills Algae], [Kills Bacteria], [Oxidizes], [Destroys Organic Wastes], [Organic contaminant remover**], [Clarifies], [Stabilizer], [Filter Enhancer], [Enhances Filtration], [Prevents Algae], [Controls Algae,] [Contains Sunlight Protector] [pH buffer]]
- **[such as] [body & suntan oils] [body oils] [&] [suntan oils] [&] [sweat] [perspiration] [&] [lotions] [&] [urine]
- [[Prevents] [Eliminates] [Quickly] [Clears] [cloudy] [murky] [green] water]
- [Use for a shockingly [clean] [and] [clear] pool]
- [For extra clean water]
- [For fresh, clear water]

[[Powers through] [fights] [eliminates] filth]
 [Works quickly to restore pool water freshness & clarity]
 [[Clears [cloudy] water] [&] [removes filth]]
 [[Clears [cloudy] water] [&] [removes swimmer contaminants**]]
 **[such as] [body & suntan oils] [body oils] [&] [suntan oils] [&] [sweat] [perspiration] [&]
 [lotions] [&] [urine]
 [Clears Cloudy Water]
 [Quickly Clears Cloudy Water]
 [Creates Sparkling Water]
 [Provides Crystal Clear Water]
 [Use Regularly for Sparkling Water]
 [Restores Water Clarity]
 [[Kills Algae], [Kills Bacteria], [Oxidizes], [Destroys Organic Wastes**], [Clarifies], [Filter
 Enhancer], [Enhances Filtration], [Prevents Algae], [Controls Algae,] [Contains Sunlight
 Protector]]
 **[such as] [body & suntan oils] [body oils] [&] [suntan oils] [&] [sweat] [perspiration] [&]
 [lotions] [&] [urine]
 [Clarifies water]
 [Restores water clarity]
 [Restores water sparkle]
 [Produces clear, sparkling spa water]

*{The icon below may be used in conjunction with green algae claims on this label. The statement
 “Basic green algae” may be replaced with similar statements listed immediately below the icon.}*



[Kills all types of algae]
 [Fights green, mustard and black algae]
 [Kills [and] [prevents] [and] [controls] [green], [black], [and] [mustard] algae]
 [Kills and controls all pool algae types]
 [An all purpose pool algaecide]
 [[Prevents] [Controls] all types of algae]
 [Controls [green] [mustard] [black] algae]
 [Keeps water clear and free of visible [green] [mustard] [black] algae]
 [Fast [green] [mustard] [black] algae control]
 [[Prevents] [Eliminates] [Quickly] [Clears] [cloudy] [murky] [green] water]

{The icon below may be used in conjunction with mustard algae claims on this label. The statement “Stubborn mustard algae” may be replaced with similar statements listed immediately below the icon.}

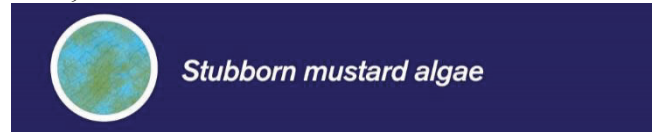

[Kills all types of algae]
[Fights green, mustard and black algae]

[Kills [and] [prevents] [and] [controls] [green], [black], [and] [mustard] algae]
[Kills and controls all pool algae types]
[An all purpose pool algaecide]
[[Prevents] [Controls] all types of algae]
[Controls [green] [mustard] [black] algae]
[Keeps water clear and free of visible [green] [mustard] [black] algae]
[Fast [green] [mustard] [black] algae control]

{The icon below may be used in conjunction with black algae claims on this label. The statement “Tough black algae” may be replaced with similar statements listed immediately below the icon.}

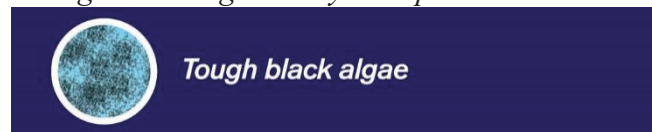

[Kills all types of algae]
[Fights green, mustard and black algae]
[Kills [and] [prevents] [and] [controls] [green], [black], [and] [mustard] algae]
[Kills and controls all pool algae types]
[An all purpose pool algaecide]
[[Prevents] [Controls] all types of algae]
[Controls [green] [mustard] [black] algae]
[Keeps water clear and free of visible [green] [mustard] [black] algae]
[Fast [green] [mustard] [black] algae control]

{The icon below may be used in conjunction with green, black and mustard algae claims on this label. The statement “Kills and controls green, black and algae” may be replaced with similar statements listed immediately below the icon.}

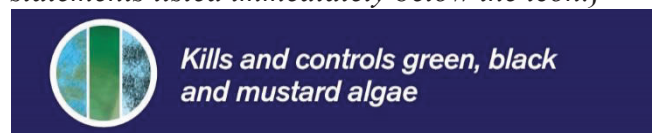

[Kills all types of algae]
[Fights green, mustard and black algae]
[Kills [and] [prevents] [and] [controls] [green], [black], [and] [mustard] algae]
[Kills and controls all pool algae types]
[An all purpose pool algaecide]
[[Prevents] [Controls] all types of algae]

[Controls [green] [mustard] [black] algae]
[Keeps water clear and free of visible [green] [mustard] [black] algae]
[Fast [green] [mustard] [black] algae control]

*{The icon below may be used in conjunction with swimmer contaminant claims on this label.
The statement "Removes swimmer contaminants" may be replaced with similar statements listed
immediately below the icon.}*



[Multi-purpose [pool shock] [pool cleaner] [shock] [algaecide] [organic contaminant remover**]
[clarifier] [pH buffer]]
[All purpose [pool shock] [pool cleaner] [shock] [algaecide] [organic contaminant remover**]
[clarifier] [pH buffer]]
[Dual action [pool shock] [pool cleaner] [shock] [algaecide] [organic contaminant remover**]
[clarifier] [pH buffer]]
[Dual function [pool shock] [pool cleaner] [shock] [algaecide] [organic contaminant remover**]
[clarifier] [pH buffer]]
[Multi function [pool shock] [pool cleaner] [shock] [algaecide] [organic contaminant remover**]
[clarifier] [pH buffer]]
[[Kills Algae], [Kills Bacteria], [Oxidizes], [Destroys Organic Wastes], [Organic contaminant
remover**], [Clarifies], [Stabilizer], [Filter Enhancer], [Enhances Filtration], [Prevents Algae],
[Controls Algae,] [Contains Sunlight Protector] [pH buffer]]
**[such as] [body & suntan oils] [body oils] [&] [suntan oils] [&] [sweat] [perspiration] [&]
[lotions] [&] [urine]
[[Removes] [Eliminates] [Destroys] [Breaks down] organic waste** [for sparkling clear water]]
[[Removes] [Eliminates] [Destroys] [Breaks down] organic contaminants** [for sparkling clear
water]]
[[Removes] [Eliminates] [Destroys] [Breaks down] [organic contaminants] [sunscreen] [pet
dander] [fertilizer] [pollen] [skin oils] [lotions] [sweat] [urine] [pee]]
[[Controls] [Eliminates] [Destroys] [Breaks down] swimmer contaminants [such as] [including]
[oils] [sweat] [lotion] [urine] [pee]]
[[Removes] [Eliminates] [Destroys] [Breaks down] organic contaminants**]
[Protects against [bacteria] [and][algae] [and] [organic contaminants**] [for] [clean] [and]
[clear] [water]]
**[such as] [body & suntan oils] [body oils] [&] [suntan oils] [&] [sweat] [perspiration] [&]
[lotions] [&] [urine]
[[Clears [cloudy] water] [&] [removes filth]]
[[Clears [cloudy] water] [&] [removes swimmer contaminants**]]
**[such as] [body & suntan oils] [body oils] [&] [suntan oils] [&] [sweat] [perspiration] [&]
[lotions] [&] [urine]
[Destroys Organic Contaminants**]
**[such as] [body & suntan oils] [body oils] [&] [suntan oils] [&] [sweat] [perspiration] [&]
[lotions] [&] [urine]

{The icon below may be used in conjunction with killing bacteria claims on this label. The statement “Kills bacteria” may be replaced with similar statements listed immediately below the icon.}



[Kills Bacteria]

[Kills Bacteria and Algae]

[[Kills Algae], [Kills Bacteria], [Oxidizes], [Destroys Organic Wastes**], [Clarifies], [Filter Enhancer], [Enhances Filtration], [Prevents Algae], [Controls Algae,] [Contains Sunlight Protector]]

**[such as] [body & suntan oils] [body oils] [&] [suntan oils] [&] [sweat] [perspiration] [&] [lotions] [&] [urine]

[Xtra] Kills Bacteria

[Xtra] Kills Bacteria and Algae

{The icon below may be used in conjunction with prevention of corrosion, scale and metal staining claims on this label. The statement “Prevents corrosion, scale and metal staining” may be replaced with similar statements listed immediately below the icon.}



[pH stable to prevent corrosion and scale]

Tamper Evident Tear Strip
Tear away by using "ring pull" on
either side of lid

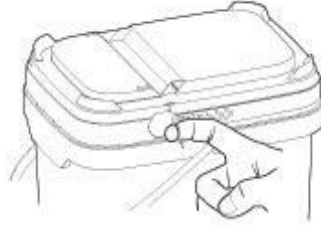

**To open the lid (after the
tear strip is removed)**

Step-1



Step-2



Step-3



Tamper Evident Tear Strip
Tear away by using "ring pull" on either side of lid

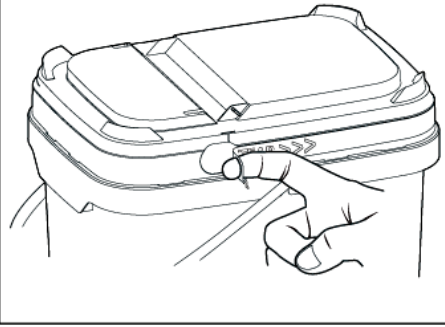

**To open the lid
(after the tear strip is removed)**

Step-1

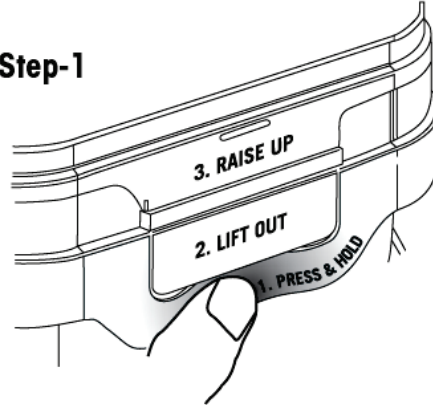

Step-2

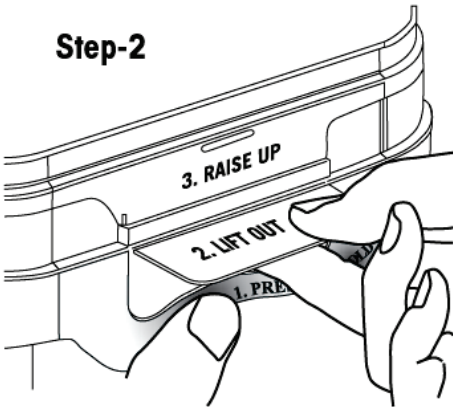

Step-3

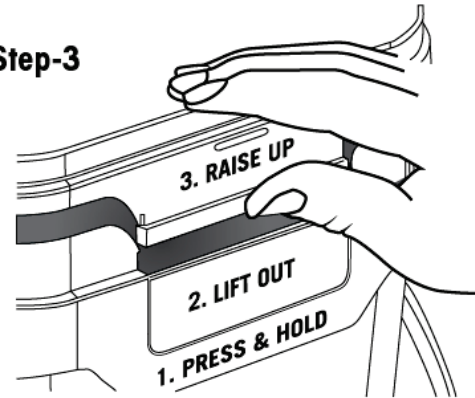

Do not store in direct sunlight

[OPTIONAL GRAPHICS CONTINUED]

{Note: The appropriate symbol(s) will be included based on packaging}

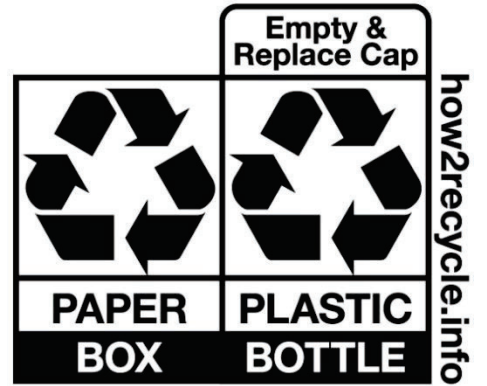
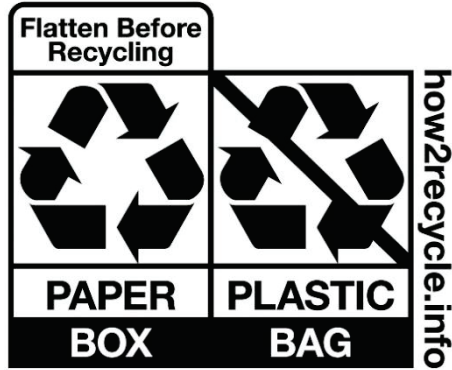

{Optional Graphics}

{New optional graphics on pages 33, 34, & 35}

{All graphics on this page are new.}

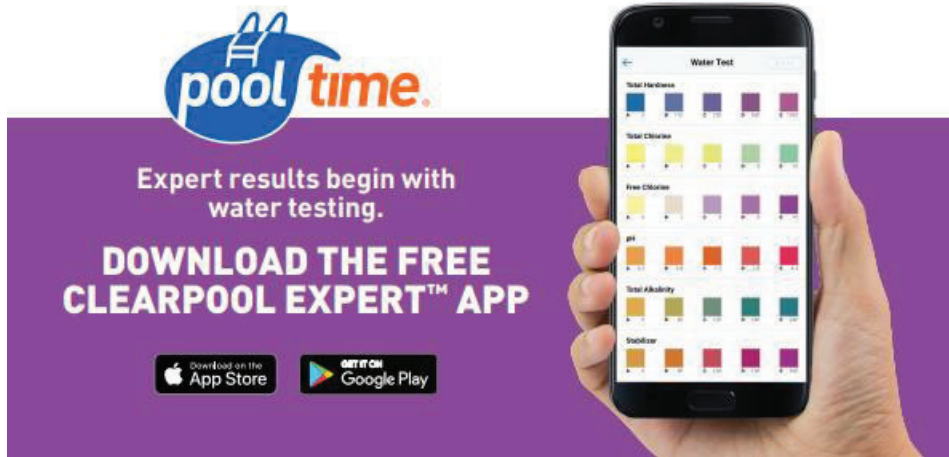

pool time.

Expert results begin with water testing.

DOWNLOAD THE FREE CLEARPOOL EXPERT™ APP

Download on the App Store | GET IT ON Google Play

The image shows a hand holding a smartphone displaying the 'Water Test' screen of the Clearpool Expert app. The screen features color-coded comparison charts for Total Hardness, Total Chlorine, Free Chlorine, pH, Total Alkalinity, and Total Copper. The background is a solid purple color.



CLOROX
Pool & Spa

Download the **FREE** Clorox® Pool App

Water Testing & Solution Center

The image shows a hand holding a smartphone displaying the Clorox Pool & Spa app interface. The background is a blue and white gradient with a pool cover texture. A yellow and white striped pencil is visible next to the phone.

{All graphics on this page are new.}

A vertical banner with a blue background. At the top is the Clorox logo in a red and white diamond shape. Below it is the text "Pool & Spa" in white. In the center, the words "FREE TEST STRIPS" are written in large, bold, white capital letters. Below this, a hand is shown holding a smartphone displaying the Clorox Pool & Spa app interface. At the bottom, a teal box contains the text "Test Your Pool with the 'Clorox® Pool' App" in white. A small code "J79000LLK51H" is visible at the very bottom.

CLOROX
Pool & Spa
FREE TEST STRIPS

Test Your Pool with the "Clorox® Pool" App

J79000LLK51H

A vertical banner with a purple background. At the top is the "pool time." logo, where "pool" is in a blue circle with a ladder icon and "time." is in orange. Below this, the words "FREE TEST STRIPS" are written in large, bold, white capital letters. Below this, a hand is shown holding a smartphone displaying the ClearPool Expert app interface. At the bottom, a white box contains the text "Download the Free ClearPool Expert™ App" in black. A small code "J79000PTMSTR" is visible at the very bottom.

pool time.
FREE TEST STRIPS

Download the Free ClearPool Expert™ App

J79000PTMSTR

{All graphics on this page are new.}

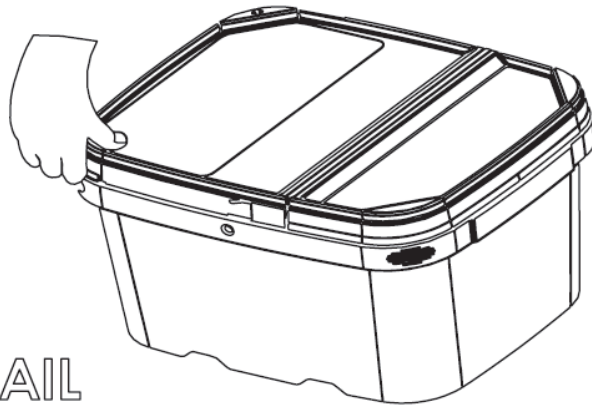

TO OPEN:
PRESS IN PAIL
CORNER AND
LIFT LID

TO CLOSE:
SNAP DOWN
LID CORNERS
AND SIDES