



UNITED STATES ENVIRONMENTAL PROTECTION AGENCY
WASHINGTON, DC 20460

OFFICE OF CHEMICAL SAFETY
AND POLLUTION PREVENTION

July 8, 2019

Mark Jernigan
Registration Manager, Pool
Recreational Water Products, Inc.
P.O. Box 1449
Buford, GA 30515

Subject: Notification per PRN 98-10 – Add marketing claims and graphics
Product Name: RWP Master Trichloro Compacted
EPA Registration Number: 67262-17
Application Date: February 6, 2019
Decision Number: 552344

Dear Mr. Jernigan:

The Agency is in receipt of your Application for Pesticide Notification under Pesticide Registration Notice (PRN) 98-10 for the above referenced product. The Antimicrobials Division (AD) has conducted a review of this request for its applicability under PRN 98-10 and finds that the action requested falls within the scope of PRN 98-10.

The label submitted with the application has been stamped “Notification” and will be placed in our records.

Should you wish to add/retain a reference to the company’s website on your label, then please be aware that the website becomes labeling under the Federal Insecticide Fungicide and Rodenticide Act and is subject to review by the Agency. If the website is false or misleading, the product would be misbranded and unlawful to sell or distribute under FIFRA section 12(a)(1)(E). 40 CFR 156.10(a)(5) list examples of statements EPA may consider false or misleading. In addition, regardless of whether a website is referenced on your product’s label, claims made on the website may not substantially differ from those claims approved through the registration process. Therefore, should the Agency find or if it is brought to our attention that a website contains false or misleading statements or claims substantially differing from the EPA approved registration, the website will be referred to the EPA’s Office of Enforcement and Compliance.

If you have any questions, you may contact Wanda Henson at (703) 308-6345 or via email at henson.wanda@epa.gov

Sincerely,

A handwritten signature in blue ink that reads "Wanda G. Fuller, for".

Demson Fuller, Product Manager 32
Regulatory Management Branch I
Antimicrobials Division (7510P)
Office of Pesticide Programs

{All text in brackets [xxx] is optional and may or may not be included on a final label.}
{All text in braces {xxx} is administrative and will not appear on a final label.}

**RWP
MASTER TRICHLORO
COMPACTED**

ACTIVE INGREDIENT:
Trichloro-s-triazinetriene 99.0%
OTHER INGREDIENTS 1.0%
TOTAL INGREDIENTS 100.0%

(Available Chlorine: 90%)

**KEEP OUT OF REACH OF CHILDREN
DANGER**

See [back] [side] panel for First Aid and additional Precautionary Statements. *{If First Aid appears on back or side panel}*

See [back] [side] panel for additional Precautionary Statements. *{If First Aid appears on front panel}*

MANUFACTURED FOR:
RECREATIONAL WATER PRODUCTS
[AQUA CHEM DIVISION]
[PoolTime Division]
PO BOX 1449
BUFORD, GEORGIA 30515

EPA REG. NO. 67262-17
EPA EST. NO. 5185-GA-1 [(BL)] {or} [(Z)]
7616-CA-1 [(C)]

{If multiple EPA Establishment Numbers appear on the label.}

[Actual establishment shown in code above or below label printed on [bottle] [container]]

[Letter designation in lot code printed above or below on [bottle] [container] identifies actual establishment.]

NET CONTENTS: *{as indicated on container}*

NOTIFICATION

67262-17

The applicant has certified that no changes, other than those reported to the Agency have been made to the labeling. The Agency acknowledges this notification by letter dated:

07/08/2019

[What?] {For use on front panel of label as a header above/beside product name.}

[Why?] {For use on front panel of label as a header above/beside marketing statements chosen from accepted label text that relates to the consumer features and benefits of product.}

- [Free [App] Water Testing & Solutions Center]
- [Free Water Testing & Solutions Center]
- [FREE [Water] Test Strips]
- [Test Your Pool with the Clorox® Pool App]
- [Download the FREE Clorox® Pool App]
- [Water Testing & Solution Center]
- [Test Any Strip with the Clorox® Pool App]
- [Use the Clorox® Pool App to Order Products Direct from Walmart.com]
- [Test Smarter]
- [Anytime. Anywhere. Pool Water Analysis and Solutions.]
- [Download the Free ClearPool Expert™ App]
- [Expert results begin with water testing.]
- [Test like an expert [with the ClearPool Expert™ App]]
- [Get it on Google Play]
- [Download on the App Store]

{Optional marketing statements that may be used with pool sanitization with any of the product forms on this label.}

- [Slow-Dissolving Sanitizer]
- [Kills Bacteria]
- [Controls Bacteria and Algae]
- [Controls Algae]
- [Kills Bacteria and Controls Algae]
- [With built-in Sunlight Protector]
- [with SUNSHIELD™]
- [with SUNSHIELD™ Protects chlorine from sunlight, so you use less]
- [Keeps water clean]

[When?] {For use on front panel of label as a header above/beside text chosen from accepted label text that relates to the consumer anticipated frequency of product use.}

[2 X a week*]

[*Approximate addition rate. Please refer to directions for use.]

{The “Pool Essentials System” box below may be placed on the label to allow easy product category identification by consumers.}

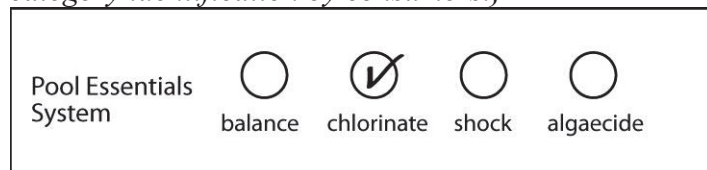

{The “4-step System” box below may be placed on the label to allow easy product category identification by consumers.}

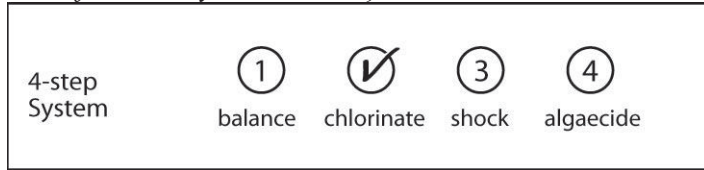

[Made in USA]
 [Prevents algae]
 [Algae prevention]
 [Use for continuous protection against [bacteria] [and] [algae]][***]
 [Provides continuous protection against [bacteria] [and] [algae]] [***]
 [Continuously protects against [bacteria] [and] [algae]] [***]
 [*** When used as directed]
 [Protects against [bacteria] [algae] [and] [organic] [contaminants] for [clean] [and] [clear] water]**]
 [Controls bacteria and prevents algae for clear [inviting] water]
 [Kills bacteria and prevents algae] [for clean and clear water with less effort]
 [Kills and prevents algae]
 [Sanitizes and prevents algae]
 [Sanitizer and [algaecide] [algicide]]
 [Algaecide] [Algicide]
 [Multi-functional [sanitizer] [algae preventer] [algae control] [algae killer] [sunlight protector]]
 [Multi-action [sanitizer] [algae preventer] [algae control] [algae killer] [sunlight protector]]
 [1-step [sanitizer] [algae preventer] [algae control] [algae killer] [sunlight protector]]
 [One step [sanitizer] [algae preventer] [algae control] [algae killer] [sunlight protector]]
 [3] [4] –in-1 formula [sanitizer] [algae preventer] [algae control] [algae killer] [sunlight protector]
 [decontaminant]]
 [Kills algae]
 [Algae [fighter] [killer] [preventer]]
 [Individually wrapped tablets]
 [Single [use] wrapped tablets]
 [Destroys [Breaks down] [Eliminates] [Controls] [swimmer] [organic] contaminants [such as]
 [including] [oils] [sweat] [lotion] [urine] [pee]]
 [Destroys [Breaks down] [Eliminates] organic contaminants**]
 [Protects against [bacteria] [algae] [and] [organic contaminants**] for [clean] [and] [clear] water]
 [x] [1/2 lb] [.5 lb] [6 oz] [8 oz] [Jumbo] [Size] [Tabs] [Tablets]] {Where x equals the approximate
 number of tablets in container, depending on size.}
 [Each Tablet weighs [6 oz] [8 oz] [1/2 lb] [.5 lb]]
 [Multifunctional]
 [Multi-action]
 [3-in-1 [sanitizer]]
 [4-in-1 [sanitizer]]
 [Kills bacteria [+] [&] [destroys] [eliminates] organic contaminants**]
 [Kills bacteria [+] [&] [destroys] [eliminates] swimmer contaminants**]
 [Prevents algae [outbreaks] [growth] [blooms] and kills bacteria]

[Kills bacteria for clean, ready-to-swim water]
[Removes organic contaminants** [for clear water]]
[Removes swimmer contaminants** [for clear water]]
[For [long lasting] clean, clear water]
[Chlorinating tab protects your water against bacteria [and organic contaminants**] [and swimmer
Contaminants**]]
[**[such as] [body & suntan oils] [body oils] [oils][&] [suntan oils] [&] [sweat] [perspiration] [&]
[lotions] [&] [urine]]
[Chlorinating sanitizer]
[Chlorine sanitizer]
[Protected against sunlight to last longer]

[Treats up to 5,000 gallons] *{for use with products marketed for smaller pools}*
[Treats [500] [1,000] [2,000] – 5,000 gallons] *{for use with products marketed for smaller pools}*
[For small pools]
[For use with all filter & surface types]
[Easy 1 2 3 Pool Care Brand System]
[Step 2] *{Chlorination is “Step 2” in “Easy 1 2 3 Pool Care Brand System”}*
[Chlorinate]
[Do not store in direct sunlight]
[Store out of direct sunlight]
[4-in-1 [action]]
[For Pools] *{For use with products that have pool use directions}*
[For Pools Only] *{For use with products that have pool use directions}*
[Not for use in Spas] *{For use with products that have pool use directions}*
[Step 3]
[Step 3- Sanitize] *{Sanitizers are marketed as step three of a five step program to treat swimming pool water
for Pool Time brand.}*

[Cleans Water & Stops Algae]
[Maintains a Healthy Pool]
[Maintains Pool Health]
[Cleans Water and Stops Algae]
[Clean Healthy Water]
[Protects from Bacteria]
[Prevents Bacteria]
[Kills and Prevents All Types of Pool Algae]
[Kills and Prevents All Types of Pool Algae*]
[*green, mustard, black]
[Kills and Prevents Green, Mustard and Black Algae]
[Kills Harmful Bacteria]
[Destroys Bacteria]
[Prevents Harmful Bacteria]
[Destroys Algae]
[Long-Lasting Sunlight Protection]

{Optional marketing statements that may be used with pool sanitization with 1 inch tablets.}

[Stabilized Chlorinator]

[Concentrated, Stabilized, Slow-Dissolving Sanitizer for convenient use in above ground and in-ground pools]

[Concentrated, Slow-Dissolving Sanitizer for Routine Use in Automatic Feeders and Float Rings]

[Concentrated, Slow-Dissolving Sanitizer for Routine Use in Automatic Feeders and Floaters]

[Feeder]

[Floater]

{Following Chart is Optional}

Application Methods	FEEDER OR FLOATER		
Surface Types	Aggregate	[Sealed]	Fiberglass
		Concrete	
	Gunite	Plaster	Vinyl
Filter Types	D.E., Sand, Cartridge, Zeolite		

{Optional marketing statements that may be used with pool sanitization with 3 inch tablets.}

[Stabilized Chlorinator]

[Concentrated, Stabilized, Slow-Dissolving Sanitizer for convenient use in above ground and in-ground pools]

[Concentrated, Slow-Dissolving Sanitizer for Routine Use in Automatic Feeders, Floaters or Plastic Skimmers]

[Contains Approximately [x] 3" Tablets] {Where x equals the approximate number of tablets in container, depending on size.}

[3" [long lasting] [tabs] [tablets]]

[Wrapped [tablets]]

[Individually wrapped]

[Wrapped for easy handling]

[Skimmer]

[Feeder]

[Floater]

{Following Chart is Optional}

Application Methods	FEEDER, FLOATER OR SKIMMER		
Surface Types	Aggregate	[Sealed]	Fiberglass
		Concrete	
	Gunite	Plaster	Vinyl
Filter Types	D.E., Sand, Cartridge, Zeolite		

{Optional marketing statements that may be used with pool sanitization with sticks.}

[Stabilized Chlorinator]

[Concentrated, Stabilized, Slow-Dissolving Sanitizer for convenient use in above ground and in-ground pools]

[Concentrated, Slow-Dissolving Sanitizer for Routine Use in Automatic Feeders, Floaters or Plastic Skimmers]

{Optional marketing statements that may be used with pool sanitization with pool floater sanitization.}

[Stabilized Chlorinator]

[Concentrated, Stabilized, Slow-Dissolving Sanitizer for convenient use in above ground and in-ground pools]

{Optional marketing statements that may be used with pool cartridge sanitization.}

[Stabilized Chlorinator]

[Type "E"]

[Fits E-Z Chlor and Sun Automatic Chlorinators]

[Concentrated, Stabilized, Slow-Dissolving Sanitizer for convenient use in above ground and in-ground pools]

{Optional marketing statements that may be used with Stabilized Chlorine Cartridge and Chlorinating Cartridge Type E.}

[Stabilized Chlorinator]

[Type "E"]

[Fits E-Z Chlor and Sun Automatic Chlorinators]

[Concentrated, Stabilized, Slow-Dissolving Sanitizer for convenient use in above ground and in-ground pools]

{Directions to be used for pool sanitization with 1 inch tablets, Option A}

POOL SANITIZATION WITH 1 INCH TABLETS

[WHY TO USE THIS PRODUCT: This product is one of the most efficient types of stabilized chlorinating sanitizer for pools with automatic feeders or floaters. This slow dissolving product releases sufficient chlorine to reduce the growth of harmful algae and bacteria in your pool. Unlike unstabilized pool sanitizers such as Calcium Hypochlorite or liquid chlorinating product (bleach), this product contains both chlorine and a stabilizer which reduces chlorine loss from sunlight.]

IMPORTANT NOTES:

1. When using other products, as outlined in directions for this product, always follow label directions for those products.
2. Sunlight, rainfall, temperature, number of swimmers and frequency of pool use affect the rate of available chlorine loss. Adjust cleaning and chemical maintenance accordingly. To destroy undesirable compounds, shock pool on a regular basis, typically every 1 to 2 weeks.
3. Use this product in an automatic or floating feeder designed for this product.
4. Do not add other chemicals through the feeder when using this product as an explosion might occur.
5. To avoid damage to pool surface or materials do not allow product to come in direct contact with these materials. Do not throw tablets directly into pool.

DIRECTIONS FOR USE:

It is a violation of Federal Law to use this product in any manner inconsistent with its labeling. Read entire label and use strictly in accordance with precautionary statements and directions.

BEFORE YOU BEGIN

1. Ensure all pool equipment is working properly. Adjust stabilizer levels to 40-50 ppm with [Stabilizer] [Chlorine Stabilizer].
2. Check water pH, alkalinity and calcium hardness with a test kit. Adjust pH to 7.2 - 7.6 by adding [pH Down] [pH Decreaser] to lower pH, or by adding [pH Up] [pH Add] to raise pH. Adjust alkalinity to 80 - 125 ppm for plaster pools, 125 - 150 for vinyl or fiberglass pools by adding [Alkalinity Increaser] [Alkalinity Plus]. Adjust calcium hardness to 200 - 275 ppm for plaster pools, 175 - 225 for vinyl or fiberglass pools by adding Calcium Hardness Increaser. Be sure to follow label directions.
3. Check residual chlorine level with a test kit and adjust to 1-4 ppm by adding a stabilized granular chlorinator.

NOW USE THIS PRODUCT

START-UP/INITIAL TREATMENT:

1. If water is cloudy or green, superchlorinate pool with appropriate shock product until pool is clear.
2. Test chlorine level and add this product to feeder or floater to bring level to 1-4 ppm. Add additional product to maintain a chlorine level of 1-4 ppm.
3. When chlorine level is adjusted to 1-4 ppm, add the algicide appropriate to your needs.

ROUTINE MAINTENANCE:

- [1.] Fill feeding device with product to assure constant chlorine level of 1-4 ppm. Check feeding device often and refill as needed.

{The following is optional text to be used at Recreational Water Products discretion. This information is non-essential and will be provided only as a courtesy. Additionally, either one or both of the dosage charts may appear on the label.}

2. This chart gives approximate weekly dosage guidelines.

Apprx Pool Size	Apprx Gallons	Water 60-70°F	Water 70-80°F	Water 80-90°F
14 x 28	15,000	5 oz.	9 oz.	14 oz.
16 x 32	20,000	7 oz.	12 oz.	18 oz.
20 x 40	35,000	12 oz.	21 oz.	31 oz.

Pool Capacity in Gallons	250	500	1000	1500	2000	2500	3000	3500	5500
1" Stabilized Tablets	1 tablet	1 tablet	1 tablet	2 tablets	2 tablets	3 tablets	3 tablets	4 tablets	6 tablets

Reentry into treated swimming pools is prohibited above levels of 4 ppm chlorine due to risk of body injury.

{Simplified use directions for swimming pool sanitization with 1 inch tablets, Option B}

[How?]

DIRECTIONS FOR USE:

It is a violation of Federal Law to use this product in any manner inconsistent with its labeling. Read entire label and use strictly in accordance with precautionary statements and directions.

To Keep Water Clean:

- Test and balance water before using this product. Visit [the Aqua Chem Web Site] {or} [www.aquachem.com] {or} [the Pool Time website] {or} [www.pooltime.com] for complete pool balancing instructions.
- If the pool is cloudy or green, add a granular shock product; follow application directions on that product.
- Add tablets to an appropriate feeder or floater to bring chlorine level to 1-4 ppm; refill as needed to maintain 1-4 ppm.
- When chlorine level is adjusted to 1-4 ppm, add the [algicide] {or} [algaecide] appropriate to your needs.
- Do not add other chemicals through the feeder when using this product as an explosion might occur.
- Direct contact with pool surface or equipment may cause damage; do not add directly to the pool.
- Apply more product after heavy use, high temperatures, or rain. To keep water clear, shock pool on a weekly basis.

{The following is optional text to be used at Recreational Water Products discretion. This information is non-essential and will be provided only as a courtesy. Additionally, either one or both of the dosage charts may appear on the label.}

- This chart gives approximate weekly dosage guidelines.

Apprx Pool Size	Apprx Gallons	Water 60-70°F	Water 70-80°F	Water 80-90°F
14 x 28	15,000	5 oz.	9 oz.	14 oz.
16 x 32	20,000	7 oz.	12 oz.	18 oz.
20 x 40	35,000	12 oz.	21 oz.	31 oz.

Pool Capacity in Gallons	250	500	1000	1500	2000	2500	3000	3500	5500
1” Stabilized Tablets	1 tablet	1 tablet	1 tablet	2 tablets	2 tablets	3 tablets	3 tablets	4 tablets	6 tablets

Reentry into treated swimming pools is prohibited above levels of 4 ppm chlorine due to risk of body injury.

{Simplified use directions for swimming pool sanitization with 1 inch tablets, Option C}

DIRECTIONS FOR USE:

It is a violation of Federal Law to use this product in any manner inconsistent with its labeling. Read entire label and use strictly in accordance with precautionary statements and directions.

Test & balance water prior to use. Adjust pH to 7.2-7.6 [and free chlorine to 1 – 4 ppm]. Visit [website] for [free water analysis] [&] [personalized product and dosage recommendations].

Use: Sanitizes water for a clean, clear pool.

Application Method	
If water is cloudy or green, add a granular shock product per label directions.	
Feeder & Floater	Fill with [tabs] [tablets] and adjust output to bring chlorine to 1-4 ppm, test and refill as needed to maintain 1-4 ppm
Do Not apply other chemicals through feeder as an explosion might occur. Direct contact with surfaces or equipment may cause damage	

For best results: Apply more product after heavy use, high temperatures or rain to maintain 1 – 4 ppm.

[Drain & Refill: For pools 1,000 gallons or less, cloudy, dull water and difficulty maintaining 1-4 ppm indicate a drain & refill is needed.] *{for use with products marketed for small pools treating ~ 1,000 gallons or less}*

Re-entry into treated swimming pools is prohibited above levels of 4 ppm chlorine due to risk of body injury.

{Directions to be used for pool sanitization with 3 inch tablets, Option A}

POOL SANITIZATION WITH 3 INCH TABLETS

[WHY TO USE THIS PRODUCT: This product is one of the most efficient types of stabilized chlorinating sanitizer for pools with automatic feeders or floaters. This slow dissolving product releases sufficient chlorine to reduce the growth of harmful algae and bacteria in your pool. Unlike unstabilized pool sanitizers such as Calcium Hypochlorite or liquid chlorinating product (bleach), this product contains both chlorine and a stabilizer which reduces chlorine loss from sunlight.]

IMPORTANT NOTES:

1. When using other products, as outlined in directions for this product, always follow label directions for those products.
2. Sunlight, rainfall, temperature, number of swimmers and frequency of pool use affect the rate of available chlorine loss. Adjust cleaning and chemical maintenance accordingly. To destroy undesirable compounds, shock pool on a regular basis, typically every 1 to 2 weeks.
3. Use this product in an automatic or floating feeder or skimmer designed for this product.
4. Do not add other chemicals through the skimmer or feeder when using this product-an explosion might occur. [Use this product in skimmer only if skimmer and the piping between skimmer and pump are plastic. In vinyl pools, do not leave pump turned off for more than 8 hours when this product is in the skimmer. If pump is turned off for more than 8 hours, bleaching and damage to liner may occur.]
5. To avoid damage to pool surface or materials do not allow product to come in direct contact with these materials. Do not throw tablets directly into pool.

DIRECTIONS FOR USE:

It is a violation of Federal Law to use this product in any manner inconsistent with its labeling. Read entire label and use strictly in accordance with precautionary statements and directions.

BEFORE YOU BEGIN

1. Ensure all pool equipment is working properly. Adjust stabilizer levels to 40-50 ppm with [Stabilizer] [Chlorine Stabilizer].
2. Check water pH, alkalinity and calcium hardness with a test kit. Adjust pH to 7.2 - 7.6 by adding [pH Down] [pH Decreaser] to lower pH, or by adding [pH Up] [pH Add] to raise pH. Adjust alkalinity to 80 - 125 ppm for plaster pools, 125 - 150 for vinyl or fiberglass pools by adding [Alkalinity Increaser] [Alkalinity Plus]. Adjust calcium hardness to 200 - 275 ppm for plaster pools, 175 - 225 for vinyl or fiberglass pools by adding Calcium Hardness Increaser. Be sure to follow label directions.
3. Check residual chlorine level with a test kit and adjust to 1-4 ppm by adding a stabilized granular chlorinator.

NOW USE THIS PRODUCT

START-UP/INITIAL TREATMENT:

1. If water is cloudy or green, superchlorinate pool with appropriate shock product until pool is clear.
2. Test chlorine level and add this product to feeder or floater to bring level to 1-4 ppm. If pool has a plastic skimmer, add one [of this product] [tablet] per 10,000 gallons of pool water. Add additional product to maintain a chlorine level of 1-4 ppm.
3. When chlorine level is adjusted to 1-4 ppm, add the algicide appropriate to your needs.

ROUTINE MAINTENANCE:

- [1.] Fill feeding device with product to assure constant chlorine level of 1-4 ppm. Check feeding device often and refill as needed.

{The following is optional text to be used at Recreational Water Products discretion. This information is non-essential and will be provided only as a courtesy.}

2. This chart gives approximate weekly dosage guidelines.

Apprx Pool Size	Apprx Gallons	Water 60-70°F	Water 70-80°F	Water 80-90°F
14 x 28	15,000	5 oz.	9 oz.	14 oz.
16 x 32	20,000	7 oz.	12 oz.	18 oz.
20 x 40	35,000	12 oz.	21 oz.	31 oz.

Reentry into treated swimming pools is prohibited above levels of 4 ppm chlorine due to risk of body injury.

{Simplified use directions for swimming pool sanitization with 3 inch tablets, Option B}

[How?]

DIRECTIONS FOR USE:

It is a violation of Federal Law to use this product in any manner inconsistent with its labeling. Read entire label and use strictly in accordance with precautionary statements and directions.

To Keep Water Clean:

- Test and balance water before using this product. Visit [the Aqua Chem Web Site] {or} [www.aquachem.com] {or} [the Pool Time website] {or} [www.pooltime.com] for complete pool balancing instructions.
- If the pool is cloudy or green, add a granular shock product; follow application directions on that product.
- **Feeder/Floater:** Add tabs to an appropriate feeder or floater to bring chlorine level to 1-4 ppm; refill as needed to maintain 1-4 ppm.
- **Skimmer:** Add one tab per 10,000 gallons of pool water to bring chlorine level to 1-4 ppm. Add additional product as needed to maintain 1-4 ppm.
- When chlorine level is adjusted to 1-4 ppm, add the [algicide] {or} [algaecide] appropriate to your needs.
- Do not add other chemicals through the feeder when using this product as an explosion might occur.
- Direct contact with pool surface or equipment may cause damage; do not add directly to the pool.
- Apply more product after heavy use, high temperatures, or rain. To keep water clear, shock pool on a weekly basis.

{The following is optional text to be used at Recreational Water Products discretion. This information is non-essential and will be provided only as a courtesy.}

- This chart gives approximate weekly dosage guidelines.

Apprx Pool Size	Apprx Gallons	Water 60-70°F	Water 70-80°F	Water 80-90°F
14 x 28	15,000	5 oz.	9 oz.	14 oz.
16 x 32	20,000	7 oz.	12 oz.	18 oz.
20 x 40	35,000	12 oz.	21 oz.	31 oz.

Reentry into treated swimming pools is prohibited above levels of 4 ppm chlorine due to risk of body injury.

{Simplified use directions for swimming pool sanitization with 3 inch tablets, Option C}

DIRECTIONS FOR USE:

It is a violation of Federal Law to use this product in any manner inconsistent with its labeling. Read entire label and use strictly in accordance with precautionary statements and directions.

Test & balance water prior to use. Adjust pH to 7.2-7.6 [and free chlorine to 1 – 4 ppm]. Visit [website] for [free water analysis] [&] [personalized product and dosage recommendations].

Use: Sanitizes water for a clean, clear pool.

Application Methods	
If water is cloudy or green, add a granular shock product per label directions.	
Feeder & Floater	Fill with [tabs] [tablets] and adjust output to bring chlorine to 1-4 ppm, test and refill as needed to maintain 1-4 ppm
Skimmer	1 [tab][tablet] per 10,000 gallons to bring chlorine to 1-4 ppm then add more [tabs][tablets] as needed to maintain 1-4 ppm
Do Not apply other chemicals through feeder as an explosion might occur. Direct contact with pool surfaces or equipment may cause damage	

For best results: Apply more product after heavy use, high temperatures or rain to maintain 1 – 4 ppm.

Re-entry into treated swimming pools is prohibited above levels of 4 ppm chlorine due to risk of body injury.

{Directions to be used for pool sanitization with sticks}

POOL SANITIZATION WITH STICKS

[WHY TO USE THIS PRODUCT: This product is one of the most efficient types of stabilized chlorinating sanitizer for pools with automatic feeders or floaters. This slow dissolving product releases sufficient chlorine to reduce the growth of harmful algae and bacteria in your pool. Unlike unstabilized pool sanitizers such as Calcium Hypochlorite or liquid chlorinating product (bleach), this product contains both chlorine and a stabilizer which reduces chlorine loss from sunlight.]

IMPORTANT NOTES:

1. When using other products, as outlined in directions for this product, always follow label directions for those products.
2. Sunlight, rainfall, temperature, number of swimmers and frequency of pool use affect the rate of available chlorine loss. Adjust cleaning and chemical maintenance accordingly. To destroy undesirable compounds, shock pool on a regular basis, typically every 1 to 2 weeks.
3. Use this product in an automatic or floating feeder or skimmer designed for this product.
4. Do not add other chemicals through the skimmer or feeder when using this product-an explosion might occur. [Use this product in skimmer only if skimmer and the piping between skimmer and pump are plastic. In vinyl pools, do not leave pump turned off for more than 8 hours when this product is in the skimmer. If pump is turned off for more than 8 hours, bleaching and damage to liner may occur.]
5. To avoid damage to pool surface or materials do not allow product to come in direct contact with these materials. Do not throw sticks directly into pool.

DIRECTIONS FOR USE:

It is a violation of Federal Law to use this product in any manner inconsistent with its labeling. Read entire label and use strictly in accordance with precautionary statements and directions.

BEFORE YOU BEGIN

1. Ensure all pool equipment is working properly. Adjust stabilizer levels to 40-50 ppm with [Stabilizer] [Chlorine Stabilizer].
2. Check water pH, alkalinity and calcium hardness with a test kit. Adjust pH to 7.2 - 7.6 by adding [pH Down] [pH Decreaser] to lower pH, or by adding [pH Up] [pH Add] to raise pH. Adjust alkalinity to 80 - 125 ppm for plaster pools, 125 - 150 for vinyl or fiberglass pools by adding [Alkalinity Increaser] [Alkalinity Plus]. Adjust calcium hardness to 200 - 275 ppm for plaster pools, 175 - 225 for vinyl or fiberglass pools by adding Calcium Hardness Increaser. Be sure to follow label directions.
3. Check residual chlorine level with a test kit and adjust to 1-4 ppm by adding a stabilized granular chlorinator.

NOW USE THIS PRODUCT

START-UP/INITIAL TREATMENT:

1. If water is cloudy or green, superchlorinate pool with appropriate shock product until pool is clear.
2. Test chlorine level and add this product to feeder or floater to bring level to 1-4 ppm. If pool has a plastic skimmer, add one of this product per 10,000 gallons of pool water. Add additional product to maintain a chlorine level of 1-4 ppm.
3. When chlorine level is adjusted to 1-4 ppm, add the algicide appropriate to your needs.

ROUTINE MAINTENANCE:

- [1.] Fill feeding device with product to assure constant chlorine level of 1-4 ppm. Check feeding device often and refill as needed.

{The following is optional text to be used at Recreational Water Products discretion. This information is non-essential and will be provided only as a courtesy.}

2. This chart gives approximate weekly dosage guidelines.

Apprx Pool Size	Apprx Gallons	Water 60-70°F	Water 70-80°F	Water 80-90°F
14 x 28	15,000	5 oz.	9 oz.	14 oz.
16 x 32	20,000	7 oz.	12 oz.	18 oz.
20 x 40	35,000	12 oz.	21 oz.	31 oz.

Reentry into treated swimming pools is prohibited above levels of 4 ppm chlorine due to risk of body injury.

{Directions to be used for pool floater sanitization, Option A}

POOL FLOATER SANITIZATION

[WHY TO USE THIS PRODUCT: This product is an easy and economical way to regulate the chlorinating product that sanitizes your pool. When used as directed, this product maintains a constant chlorine level to reduce the growth of harmful algae and bacteria in your pool. Unlike unstabilized pool sanitizers such as Calcium Hypochlorite or liquid chlorinating product (bleach), this product contains both chlorine and a stabilizer which reduces chlorine loss from sunlight.]

IMPORTANT NOTES:

1. When using other products, as outlined in directions for this product, always follow label directions for those products.
2. Sunlight, rainfall, temperature, number of swimmers and frequency of pool use affect the rate of available chlorine loss. Adjust cleaning and chemical maintenance accordingly. To destroy undesirable compounds, shock pool on a regular basis, typically every 1 to 2 weeks or each time floater is replaced.
3. During shock treatment, remove floater from pool. Place floater in an empty, clean, dry plastic container. Place it back in pool when the process is completed.
4. Do not completely submerge floater or allow holes to become clogged. This could trap excess amount of chlorine gas possibly resulting in a violent explosion.
5. Do not leave floater in pool when pool is covered with solar blanket or cover. Damage to blanket, cover or pool may result. Build-up of gases may occur within floater.
6. Do not attempt to open or refill this product.

DIRECTIONS FOR USE

It is a violation of Federal Law to use this product in a manner inconsistent with its labeling. Read entire label directions and use strictly in accordance with precautionary statements and directions.

BEFORE YOU BEGIN:

1. Ensure all pool equipment is working properly. Backwash filter following manufacturer's directions.
2. Adjust stabilizer levels to 40-50 ppm with [Stabilizer] [Chlorine Stabilizer]. Check residual chlorine level with a test kit. Adjust to 1-4 ppm by adding a stabilized granular chlorinator.
3. Check water pH, alkalinity and calcium hardness with a test kit. Adjust pH to 7.2 - 7.6 by adding [pH Down] [pH Decreaser] to lower pH, or by adding [pH Up] [pH Add] to raise pH. Adjust alkalinity to 80 - 125 ppm for plaster pools, 125 - 150 for vinyl or fiberglass pools by adding [Alkalinity Increaser] [Alkalinity Plus]. Adjust calcium hardness to 200 - 275 ppm for plaster pools, 175 - 225 for vinyl or fiberglass pools by adding Calcium Hardness Increaser. Be sure to follow label directions.

NOW USE THIS PRODUCT:

1. Floater is marked in gallon increments from 5,000 to 40,000 gallons. To use, cut off all feeder nubs on both sides of cartridge up to and including the one corresponding to your pool's size. If pool is between sizes marked, open next higher nubs. Use a sharp knife and cut in direction away from your body and limbs. (Fig.A) Make certain holes are wide open to allow water to flow through freely.
2. Place floater with open holes in center of the pool. (Fig. B) After 24 hours check residual chlorine level with a test kit. If residual chlorine level is below 1.0 ppm cut-off one additional nub until chlorine stabilizes at 1-4 ppm. If the residual chlorine is too high, seal one set of holes with waterproof plastic tape.
3. When ready for replacement, this product will float on its side. (Fig. C)

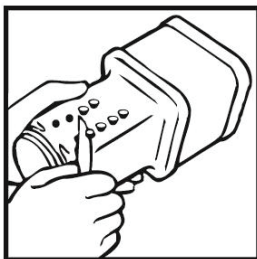

FIG. A



FIG. B

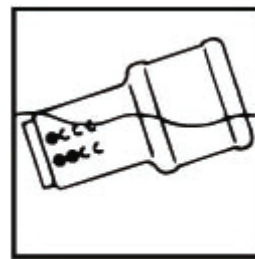

FIG. C

Reentry into treated swimming pools is prohibited above levels of 4 ppm chlorine due to risk of body injury.

{Simplified use directions for swimming pool floater sanitization, Option B}

[How?]

DIRECTIONS FOR USE:

It is a violation of Federal Law to use this product in any manner inconsistent with its labeling. Read entire label and use strictly in accordance with precautionary statements and directions.

To Keep Water Clean:

- Test and balance water before using this product. Visit [the Aqua Chem Web Site] {or} [www.aquachem.com] {or} [the Pool Time website] {or} [www.pooltime.com] for complete pool balancing instructions.
- Cut off all feeder nubs on both sides of cartridge up to and including the pool volume. If pool is between sizes marked, open next higher nubs. Use a sharp knife and cut in direction away from your body. (Fig.A). Make certain holes are wide open to allow water to flow through freely.
- Place floater with open holes in the pool. (Fig. B) After 24 hours, if chlorine level is below 1.0 ppm cut-off one additional nub until chlorine level is 1-4 ppm. If the chlorine level is above 4 ppm, seal one set of holes with waterproof plastic tape.
- This product floats on side when empty. (Fig. C)
- To keep water clear, shock pool on a weekly basis or after heavy use, high temperatures, or rain.
- During shock treatment, remove floater from pool. Place floater in an empty, clean, dry plastic container. Place floater back in pool when the process is completed.
- Do not completely submerge floater or allow holes to become clogged. This could trap excess amount of chlorine gas possibly resulting in a violent explosion.
- Do not attempt to open or refill this product.

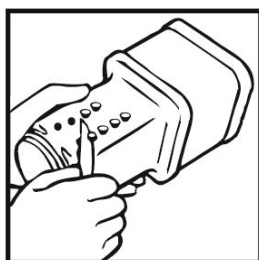

FIG. A

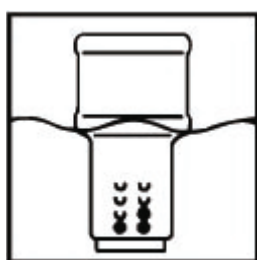

FIG. B

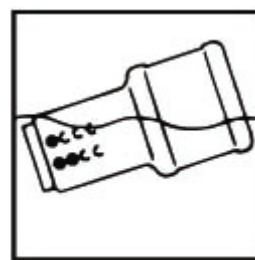

FIG. C

Reentry into treated swimming pools is prohibited above levels of 4 ppm chlorine due to risk of body injury.

{Directions to be used for pool cartridge sanitization}

POOL CARTRIDGE SANITIZATION

[WHY TO USE THIS PRODUCT: This product is an easy and economical way to regulate the chlorinating product that sanitizes your pool. When used as directed, this product maintains a constant chlorine level to reduce the growth of harmful algae and bacteria in your pool. Unlike unstabilized pool sanitizers such as Calcium Hypochlorite or liquid chlorinating product (bleach), this product contains both chlorine and a stabilizer which reduces chlorine loss from sunlight. This product is not a floating device and is only to be used with automatic chlorinating systems using the Type "E" refill cartridge.]

IMPORTANT NOTES

1. When using other products, as outlined in directions for this product, always follow label directions for those products.
2. Sunlight, rainfall, temperature, number of swimmers and frequency of pool use affect the rate of available chlorine loss. Adjust cleaning and chemical maintenance accordingly. To destroy undesirable compounds, shock pool on a regular basis, typically every 1 to 2 weeks.
3. During shock treatment, remove chlorinating cartridge from chlorinator. Place cartridge in an empty, clean, dry plastic container. Place it back in chlorinator when the process is completed.
4. Do not completely submerge cartridge or allow vent holes to become clogged. Chlorine gas may build up and could cause a violent explosion.
5. Do not attempt to open or refill this cartridge.

DIRECTIONS FOR USE

It is a violation of federal law to use this product in any manner inconsistent with its labeling. Read entire label and use strictly in accordance with precautionary statements and directions.

BEFORE YOU BEGIN

1. Ensure all pool equipment is working properly. Backwash filter following manufacturer's directions.
2. Adjust stabilizer levels to 40-50 ppm with [Stabilizer] [Chlorine Stabilizer].
3. Check water pH, alkalinity and calcium hardness with a test kit. Adjust pH to 7.2 - 7.6 by adding [pH Down] [pH Decreaser] to lower pH, or by adding [pH Up] [pH Add] to raise pH. Adjust alkalinity to 80 - 125 ppm for plaster pools, 125 - 150 for vinyl or fiberglass pools by adding [Alkalinity Increaser] [Alkalinity Plus]. Adjust calcium hardness to 200 - 275 ppm for plaster pools, 175 - 225 for vinyl or fiberglass pools by adding Calcium Hardness Increaser. Be sure to follow label directions.
4. Check chlorine level with a test kit and adjust to 1-4 ppm by adding a stabilized granular chlorinator.

NOW USE THIS PRODUCT

1. Punch out numbered holes in cartridge up to corresponding pool size as indicated below. Use a large nail, sharp knife or similar tool for this purpose. Place cartridge on a solid surface and work carefully to avoid injury.

Pool Capacity in Gallons	Open Hole Number.
10,000.....	1
20,000.....	2
30,000.....	3
40,000.....	4
50,000.....	5
60,000.....	6

2. For pools of intermediate size, open hole for next larger capacity. (Example: for 25,000 gallon pool, open hole number 3.) For pools larger than 60,000 gallons, use 2 (or more) cartridges and divide the number of holes to opened equally among them. (Example: For 80,000 gallon pool, use 2 cartridges and open hole #4 on each.)
3. Place cartridge (or cartridges) in chlorinator (follow equipment manufacturer's directions for installation of the Type "E" cartridge) and wait for 24 hours.
4. Test pool after 24 hours. Check chlorine level with test kit. Correct range should be 1-4 ppm. If level is below 1 ppm, punch out next higher number. If level is above 4 ppm, cover highest hole with water proof tape. Make additional adjustments as required to maintain a 1-4 ppm chlorine level.

Reentry into treated swimming pools is prohibited above levels of 4 ppm chlorine due to risk of body injury.

{Directions for Stabilized Chlorine Cartridge and Chlorinating Cartridge Type E}

SWIMMING POOL SANITIZER

[This product when used as directed, automatically maintains a constant chlorine level to sanitize your pool. This reduces the growth of harmful algae and bacteria in your pool for several weeks. This product is not a floating device and is only to be used with automatic chlorinating systems.]

IMPORTANT NOTES:

1. When using other products, as outlined in directions for this product, always follow label directions for those products.
2. Sunlight, rainfall, temperature, number of swimmers and frequency of pool use affect the rate of available chlorine loss. Adjust cleaning and chemical maintenance accordingly. To destroy undesirable compounds, shock pool on a regular basis, typically every 1 to 2 weeks or each time floater is replaced.
3. During shock treatment, remove floater from pool. Place floater in an empty, clean, dry plastic container. Place it back in pool when the process is completed.
4. Do not attempt to open or refill this product.

DIRECTIONS FOR USE: It is a violation of federal law to use this product in any manner inconsistent with its labeling. Read entire label and use strictly in accordance with precautionary statements and directions.

Ensure all pool equipment is working properly. Backwash the filter system following manufacturer's directions. Adjust pH to between 7.2-7.6. Add stabilizer to establish a minimum level of 40-50 ppm cyanuric acid to reduce the degradative effects of sunlight upon the chlorine residual. Superchlorinate the pool so that a chlorine residual of between 1-4 ppm is obtained. When using other products as outlined in directions for this product, always follow directions on those products. Do not attempt to open or refill this cartridge.

1. Select a large nail, sharp knife or similar tool to punch out dimples per step #2. Place cartridge on a solid surface and work carefully to avoid injury.
2. Punch out appropriate dimples on both of the upper sides of cartridge according to the chart below based on the size of your pool:

Gallons of pool water:	Dimples to punch:
5,000	1
10,000	1, 2, & 3
15,000	1, 2, 3, 4, & 5
20,000	1, 2, 3, 4, 5, 6, & 7
30,000	1, 2, 3, 4, 5, 6, 7, 8, & 9

Example: 15,000 gallon pool. Punch out dimples numbered 1, 2, 3, 4 and 5. See diagram:

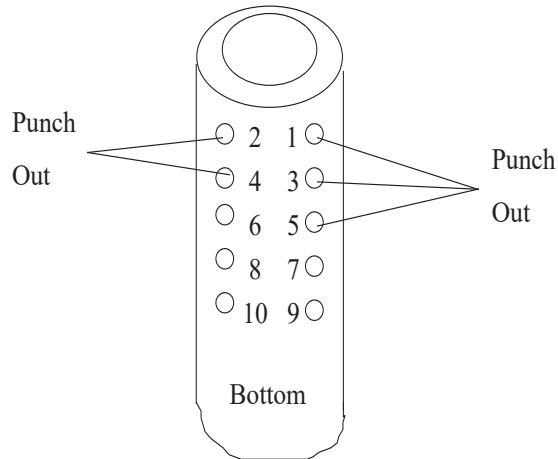

3. Punch out all eight (8) clear dots on top of cap.
4. Turn cartridge upside down and place into chlorinator. Follow equipment manufacturer's directions for installation of the Type "E" cartridge.
5. After the cartridge has been in use for 24 hours, check the chlorine level of the water with a test kit. The correct chlorine level range is 1-4 ppm.

If level is below 1 ppm, punch out next higher number. If level is above 4 ppm, cover highest hole with waterproof tape. Make additional adjustments as required to maintain a 1-4 ppm chlorine level.

Reentry into treated swimming pools is prohibited above levels of 4 ppm chlorine due to risk of body injury.

STORAGE AND DISPOSAL: Keep this product dry in original tightly closed container when not in use. Store in a cool, dry, well-ventilated area away from heat or open flame. Do not contaminate food or feed by storage or disposal. **CONTAINER DISPOSAL:** Non-refillable container. Do not reuse or refill this container. Offer for recycling, if available. Triple rinse container (or equivalent) promptly after emptying.

PRECAUTIONARY STATEMENTS:

HAZARDS TO HUMANS AND DOMESTIC ANIMALS: DANGER: Corrosive: Causes irreversible eye damage and skin burns. May be fatal if absorbed through skin. May be fatal if inhaled. Do not breathe dust or fumes. Irritating to nose and throat. Harmful if swallowed. Do not get in eyes, on skin or on clothing. Wear goggles or safety glasses, protective clothing and rubber gloves when handling this product. Wash thoroughly with soap and water after handling and before eating, drinking or using tobacco. Remove contaminated clothing and wash before reuse.

PHYSICAL OR CHEMICAL HAZARDS: STRONG OXIDIZING AGENT: Do not mix with other chemicals. Mix only with water. Never add water to product. Always add product to large quantities of water. When using automatic feeding devices, always follow manufacturer's directions as to the proper addition of sanitizer product to chlorinators. Use clean dry utensils. Do not add this product to any dispensing device containing remnants of any other product. Such use may cause a violent reaction leading to fire or explosion. Contamination with moisture, organic matter or other chemicals will start a chemical reaction and generate heat, hazardous gas, possible fire and explosion. In case of contamination or decomposition, do not reseal container. If possible, isolate container in open air or well ventilated area. Flood area with large volumes of water.

{When First Aid is not located on front panel of label, it will be separated by line rules from adjacent text and be in a different color.}

FIRST AID: IF INHALED: Move person to fresh air. If person is not breathing, call 911 or an ambulance, then give artificial respiration, preferably mouth-to-mouth, if possible. Call poison control center or doctor for treatment advice. **IF ON SKIN OR CLOTHING:** Take off contaminated clothing. Rinse skin immediately with plenty of water for 15-20 minutes. Call a poison control center or doctor for treatment advice. **IF IN EYES:** Hold eye open and rinse slowly and gently with water for 15-20 minutes. Remove contact lenses, if present, after the first 5 minutes, then continue rinsing eye. Call a poison control center or doctor for treatment advice. **IF SWALLOWED:** Call poison control center or doctor immediately for treatment advice. Have person sip a glass of water if able to swallow. Do not induce vomiting unless told to do so by the poison control center or doctor. Do not give anything by mouth to an unconscious person.

Have the product container or label with you when calling a poison control center or doctor, or going for treatment. IN CASE OF MEDICAL EMERGENCY, CALL [1-877-800-5553] [1-866-366-5048] [telephone number supplied by supplemental registrant].

Note to Physician: Probable mucosal damage may contraindicate the use of gastric lavage.

{Environmental hazards statement for end-use products in containers of less than 50 pounds (solid, dry weight).}

[ENVIRONMENTAL HAZARDS This pesticide is toxic to fish and aquatic organisms.]

{Environmental hazards statement for end-use products in containers of equal to or greater than 50 pounds (solid, dry weight).}

[ENVIRONMENTAL HAZARDS This pesticide is toxic to fish and aquatic organisms. Do not discharge effluent containing this product into lakes, streams, ponds, estuaries, oceans or other waters unless in accordance with the requirements of a National Pollutant Discharge Elimination System (NPDES) permit and the permitting authority has been notified in writing prior to discharge. Do not discharge effluent containing this product to sewer systems without previously notifying the local sewage treatment plant authority. For guidance contact your State Water Board or Regional Office of the EPA.]

[NOTE: Buyer assumes all responsibility for safety and use not in accordance with directions.]

[NOTE: User assumes all responsibility for use not in accordance with directions.]

{The following is optional text to be used at Recreational Water Products' discretion with swimming pool use directions. This information is non-essential and will be provided only as a courtesy. Will not appear on all swimming pool products.}

HOW TO CALCULATE POOL CAPACITY

Shape of Pool	Gallons of water
Rectangular	Average depth x average length x average width x 7.5
Circular	Diameter x diameter x average depth x 5.9
Oval	Full width x full length x average depth x 5.9
Irregular	Consult pool builder

{The following is optional text to be used at Recreational Water Products' discretion. This information is non-essential and will be provided only as a courtesy. Will not appear on all labels.}

[NOTE: Any questions or comments about Aqua Chem Products? In the continental U.S. call 1-800-252-POOL (7665). Ask for your free pool care booklet.]

[Questions or comments, Call 1-800-252-POOL (7665).]

[[Questions?] [Pool Care Tips?] [1-800-SOS-POOL]]

[Visit Aqua Chem's Internet Web Site at <http://www.aquachem.com>]

[Visit PoolTime's Internet Web Site at <http://www.pooltime.com>]

[Visit Brand Name's Internet Web Site at <http://www.brandname.com>]

{Optional Graphics}

4 step system:

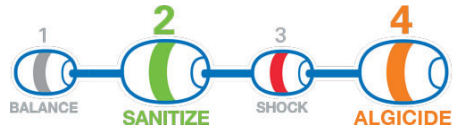

4-Step System ① ② ③ ④



4-Step System ① ② ③ ④

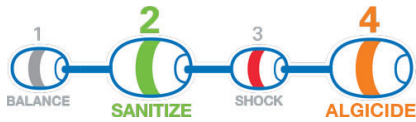

⚠️ **WARNING**
⚠️ **AVISO**



Children can fall into bucket and drown.
Keep children away from bucket with even a small amount of liquid.

Los niños pueden caer dentro de el balde y ahogarse.
Mantenga a los niños alejados de los baldes aunque solo contengan un poco de liquido.



CHLORINATE

STEP
2

Easy

1 2 3

Pool Care™
BRAND
System

STEP
SANITIZE
3



pool time.

Expert results begin with water testing.

Start Here

STEP 1 TEST

DOWNLOAD THE FREE
CLEARPOOL EXPERT APP

Available on the App Store | Get it on Google Play

{In sticker above, testing is marketed as step one of a five step program to treat swimming pool water for Pool Time brand.}

{Optional: Text that may be included on Kit Label if this product is sold in a kit with other products.}

{For kits that treat pools 5,000 gallons or less.}

[[Brandname] Small Pool [easy] [care] [start-up] [maintenance] [start-up & maintenance] kit]
[[Brandname] Pop-up Pool [easy] [care] [start-up] [maintenance] [start-up & maintenance] kit]
[[Brandname] Inflatable Pool [easy] [care] [start-up] [maintenance] [start-up & maintenance] kit]
[[Brandname] [Small] [Pop-Up] [Inflatable] [Pool] [water] [easy] [care] [start-up] [maintenance] [start-up & maintenance] kit]

[For small pools]
[Treats up to 5,000 gallons.]

[[Kit] contains:

- [[X] lb of (insert ABN or supplemental for EPA Reg. No. 67262-27, shock product name)]
- [[X] lb of (insert ABN or supplemental for EPA Reg. No. 67262-1, shock product name)]
- [[X] lb of (insert ABN or supplemental for EPA Reg. No. 67262-17, 1" tablet product name)]
- [6-way test strips] [Smart Strips] [Multi-use Smart Strips™]
- [[small] [above ground] [pop-up] [inflatable] Pool Care Guide]

[Use only with pools that have a water re-circulating system (pump) & filter.]

{Front of Pool Care Card}

[[Small] Pool Care Guide]
[[Kit Product Name]]

[Quick start up tips

1. Start the pool equipment following manufacturer's directions. Circulate pool water with the pump on for 1-2hours.
2. Test [and] [&] balance water using (test strip product name) provide in kit.
3. Apply [X] teaspoons (shock product name) per [X] gallons and circulate for 1-2 hrs.
4. Re-test Free Chlorine level to ensure it is between 1-4 ppm*.
5. Fill an appropriate floater or feeder with (1" tablet product name) and adjust output to bring chlorine to 1-4 ppm, test and refill as needed to maintain 1-4ppm.

{Note: Both "X" in step 3 above to match application rate on FIFRA label for shock product.}

* Entry into treated swimming pools is prohibited above levels of 4 ppm chlorine due to risk of bodily injury.

For these products and any other products, please refer to the label directions for more detail on application, storage and handling instructions. Always use a designated, clean [spoon] [scoop] that is kept out of reach of children for each chemical addition.]

{Back of Pool Care Card}

[Weekly Pool [maintenance] [Care]

- Test your water twice a week [and] [&] enter results [in our free online water analysis (website)] [online at (website)] [or use the “Clorox Pool” app] for personalized product and dosage recommendations.
- [Maintain a free chlorine residual of 1-4 ppm at all times.] {or} [Maintain 1-4 ppm of Free Chlorine at all times]
- Shock weekly [and] [&] apply more product after heavy use, high temperatures or rain.
- Brush & vacuum your pool weekly.]

[Test Pool Water Using Multi-Use Smart Strips™:

Step 1: Register a My Pool Care Assistant™ account at cloroxpool.com or on the “Clorox Pool” app [and receive \$5 off your next purchase].

Step 2: Dip one Smart Strip™ into pool water at elbow’s depth, remove immediately, then shake once to remove excess water.

Step 3: Hold the Smart Strip™ level and find test results, either:

- Online at cloroxpool.com
- Using the “Clorox Pool” app
- Manually using the 6-way test chart]]

[Water testing frequency

Test	Frequency	Pool Type	Ideal Range
pH	Twice weekly	All	7.2 - 7.6
Free Chlorine	Twice weekly	All	1- 4 ppm
Total Alkalinity	Monthly	Plaster Vinyl	80 -125 ppm 125 -150 ppm
Stabilizer	2-3 times per season	All	Minimum of 30ppm
Calcium Hardness	2-3 times per season	All	175 - 225 ppm

]

Tamper Evident Tear Strip
Tear away by using "ring pull" on either side of lid

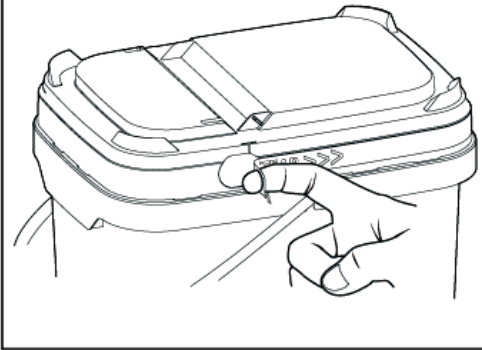

**To open the lid
(after the tear strip is removed)**

Step-1

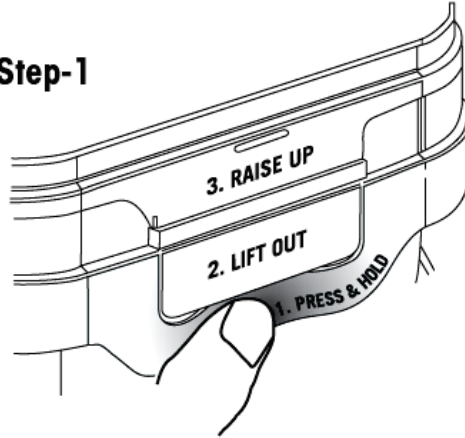

Step-2

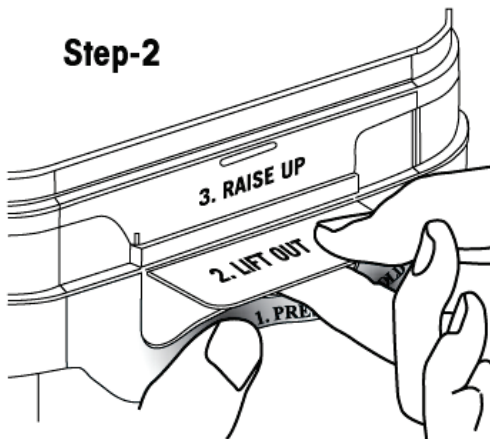

Step-3

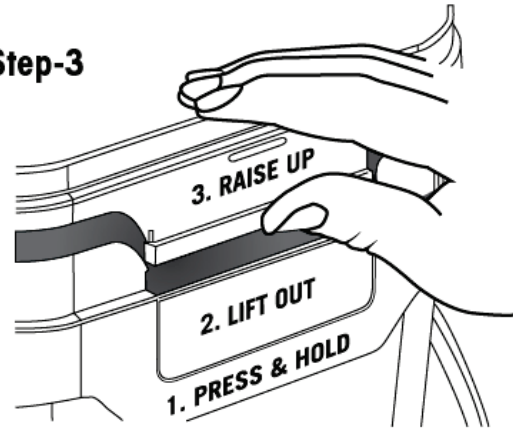

Do not store in direct sunlight

Tamper Evident Tear Strip
Tear away by using "ring pull" on either side of lid

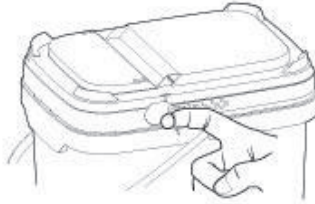

To open the lid (after the tear strip is removed)

Step-1

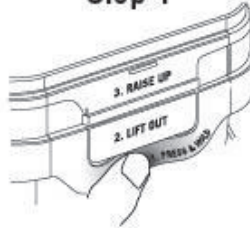

Step-2



Step-3



[OPTIONAL GRAPHICS CONTINUED]

{Note: The appropriate symbol(s) will be included based on packaging}

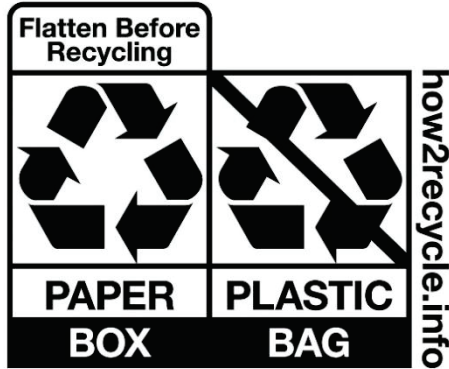

{Optional Graphics}

{All graphics on this page previously submitted December 20, 2018.}

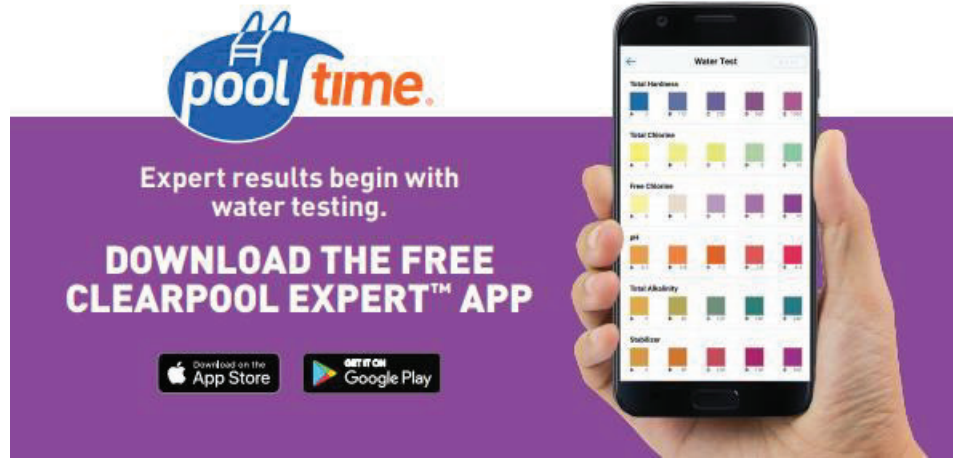

pool time.

Expert results begin with water testing.

DOWNLOAD THE FREE CLEARPOOL EXPERT™ APP

Download on the App Store | GET IT ON Google Play

The image shows a hand holding a smartphone displaying the 'Water Test' interface of the Clearpool Expert app. The interface includes color-coded swatches for Total Hardness, Total Chlorine, Free Chlorine, pH, Total Alkalinity, and Totalizer.



CLOROX

Pool & Spa™

Download the **FREE** Clorox® Pool App

Water Testing & Solution Center

The image shows a hand holding a smartphone displaying the Clorox Pool & Spa app interface. The background features the Clorox logo and the text 'Pool & Spa™'. Below the phone, it says 'Download the FREE Clorox® Pool App' and 'Water Testing & Solution Center'.

{All graphics on this page previously submitted December 20, 2018.}

CLOROX
Pool & Spa
**FREE
TEST
STRIPS**

Test Your Pool with the "Clorox® Pool" App

J79000CLXSTR

This advertisement features a blue background with the Clorox logo at the top. Below the logo, the text "Pool & Spa" is written in a smaller font, followed by "FREE TEST STRIPS" in large, bold, white letters. A hand is shown holding a smartphone that displays the Clorox Pool & Spa app interface, which includes a "Test Strip Reading" section. At the bottom, a teal banner contains the text "Test Your Pool with the 'Clorox® Pool' App". The product code "J79000CLXSTR" is located at the very bottom.

pool time.

**FREE
TEST
STRIPS**

Download the Free ClearPool Expert™ App

J79000PTMSTR

This advertisement has a purple background. At the top, the "pool time." logo is displayed. Below it, the text "FREE TEST STRIPS" is written in large, bold, white letters. A hand is shown holding a smartphone that displays the ClearPool Expert app interface, which features a grid of colorful test strip results. At the bottom, a white banner contains the text "Download the Free ClearPool Expert™ App". The product code "J79000PTMSTR" is located at the very bottom.

{All graphics on this page previously submitted December 20, 2018.}

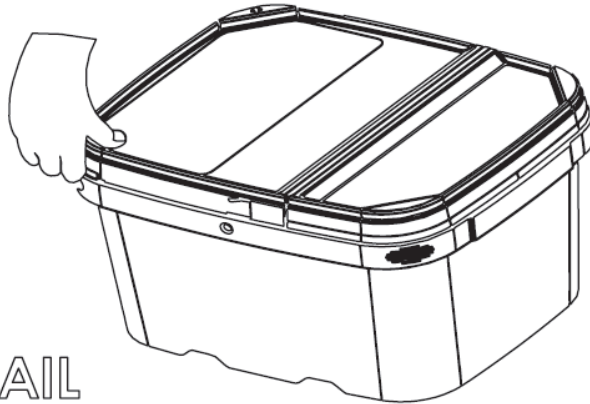

TO OPEN:
PRESS IN PAIL
CORNER AND
LIFT LID

TO CLOSE:
SNAP DOWN
LID CORNERS
AND SIDES

{Graphics on this page are new}

