

67262-1

10/21/2014

1/29



UNITED STATES ENVIRONMENTAL PROTECTION AGENCY
WASHINGTON, D.C. 20460

OFFICE OF CHEMICAL SAFETY
AND POLLUTION PREVENTION

Mr. Mark Jernigan, Registration Manager
Recreational Water Products, Inc.
Post Office Box 1449
Buford, GA 30515

OCT 21 2014

Subject: Minor Label Changes per PR Notice 98-10
RWP Master Dihydrate Granular
EPA Registration Number: **67262-1**
Application Date: October 8, 2014
Application Receipt: October 9, 2014

Dear Mr. Jernigan:

This acknowledges receipt of your Notification application, submitted under the provisions of FIFRA 3(c) 9 and PR Notice 98-10.

Purpose of the Notification:

"Notification to add clarification statements requested by the California Department of Pesticide Regulation. Additions marked on submitted label. Per PR Notice 98-10..."

General Comments:

Based on the review of the information submitted, the following comments apply.

The Notification is **Acceptable**.

A copy of the accepted Notification is attached in **Regulatory File Jacket 67262-1** for future reference.

2/29

If you have questions or concerns with regard to this Agency Letter, please contact me by email at Swift.Killian@epa.gov by telephone at **703-308-6346**. When you are submitting information or data in response to this Agency Letter, please send a copy of this Agency Letter with your response in order to facilitate processing.

Sincerely yours,

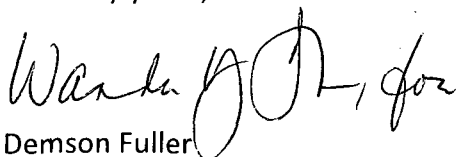
A handwritten signature in cursive script, appearing to read "Wanda J. D. for".

Demson Fuller
EPA Product Manager 32
Regulatory Management Branch II
Antimicrobials Division 7510P

*{All text in brackets [xxx] is optional and may or may not be included on a final label.}
{All text in braces {xxx} is administrative and will not appear on a final label.}*

RWP MASTER DIHYDRATE GRANULAR

ACTIVE INGREDIENT:
Sodium dichloro-s-triazinetriene dihydrate 99.0%
OTHER INGREDIENTS 1.0%
TOTAL INGREDIENTS 100.0%

NOTIFICATION
Date Received: _____
Reviewed By: _____

10-21-14
KILLIAN SWIFT

Available Chlorine: 55%

KEEP OUT OF REACH OF CHILDREN
DANGER

See [back] [side] panel for First Aid and additional precautionary statements. *{If First Aid appears on back or side panel}*

See [back] [side] panel for additional Precautionary Statements. *{If First Aid appears on front panel}*

MANUFACTURED FOR:
RECREATIONAL WATER PRODUCTS
[AQUA CHEM DIVISION]
[PoolTime Division]
PO BOX 1449
BUFORD, GEORGIA 30515

NET [CONTENT] [WEIGHT]: *{as indicated on container}*

EPA REG. NO. 67262-1
EPA EST. NO. 5185-GA-1 [(BL)] {or} [(Z)]
7616-CA-1 [(C)]

{If multiple EPA Establishment Numbers appear on the label.}

[Actual establishment shown in code above or below label printed on [bottle] [container]]

[Letter designation in lot code printed above or below on [bottle] [container] identifies actual establishment.]

.....
.....
.....
.....
.....
.....
.....
.....
.....
.....
.....
.....

{Optional marketing statements that may be used with combined directions for swimming pool sanitization, shock, algaecide and pool closing.}

- [Stabilized Granules]
- [Do not mix with other products]
- [Ideal for pool start-ups]
- [Stabilized Chlorinator]
- [Routine Chlorinator]
- [For everyday use]
- [Granular Chlorinating Concentrate]
- [Kills Bacteria]
- [Controls Bacteria]
- [With SUNSHIELD™ Protects chlorine from sunlight, so you use less]
- [[Easy-to-use],[multifunctional] chlorinating granules protect against algae and bacteria for water that stays [clean],[clear] [&] [free of visible algae]]
- [Stabilized Granules]
- [Do not mix with other products]
- [Kills algae in vinyl-lined and colored pools]
- [Algaecide]
- [For Vinyl, Colored Plaster and Fiberglass Pools]
- [For superchlorination]
- [Shock treatment]
- [Stabilized chlorinator]
- [Destroys swimmer wastes*] *[such as] [body & suntan oils] [body oils] [&] [suntan oils] [&] [sweat] [perspiration] [&] [lotions] [&] [urine]
- [Restores water clarity]
- [Best for vinyl-lined and colored pools]
- [Do not mix with other products]
- [Fast dissolving shock treatment]
- [Destroys swimmer contaminants*] *[such as] [body & suntan oils] [body oils] [&] [suntan oils] [&] [sweat] [perspiration] [&] [lotions] [&] [urine]
- [Kills Bacteria & Algae]
- [For Vinyl, Colored Plaster and Fiberglass Pools]
- [No pre-dissolving]
- [For In-ground and Above-ground Pools]
- [Won't Bleach Vinyl, Fiberglass or Colored Plaster Pools]
- [The 6-in-1 difference]
- [[3-in-1] [4-in-1] [6-in-1] [all-purpose] [formula] [sanitizer] [sanitizer & shock] [shock]]
- [[3-in-1] [4-in-1] [6-in-1] [formula]]
- [[3-in-1] [4-in-1] [6-in-1] [sanitizer] [shock] [algaecide] [pool algae killer] [pool algae preventer]
- [6-in-1 [action]]
- [4-in-1] [Formula] [Action]
- [[3-in-1] [4-in-1] [6-in-1] [all-purpose] [formula] [shock] [algaecide]]
- [Sunlight protected] [removes organic contaminants*] [removes swimmer contaminants*] [clears water]] *[such as] [body & suntan oils] [body oils] [&] [suntan oils] [&] [sweat] [perspiration] [&] [lotions] [&] [urine]
- [Kills & prevents] green & black pool algae]
- [[With] Algae-killing formula]

↑
new
↓

↑
new

- [Sunlight protected [for longer lasting chlorine]
- [Protected against sunlight [to last longer]]
- [Removes organic contaminants [for clear water] *] *new*
 *[such as] [body & suntan oils] [body oils]
 [&] [suntan oils] [&] [sweat] [perspiration] [&] [lotions] [&] [urine]
- [Removes swimmer contaminants [for clear water] *] *new*
 *[such as] [body & suntan oils] [body oils]
 [&] [suntan oils] [&] [sweat] [perspiration] [&] [lotions] [&] [urine]
- [Reduces [chlorine odor] [&] [eye irritation]]
- [Directly to water]
- [Pre-dissolve]
- [For use with all filter & surface types]
- [Easy 1 2 3 Pool Care Brand System]
- [Step 2]
- [Chlorinate]
- [Step 3]
- [Shock]
- [Do not store in direct sunlight]
- [Store out of direct sunlight]
- [Fast dissolving]
- [Clarifies water]
- [Clears cloudy water]
- [Clears water]
- [Creates sparkling water]

{Optional marketing statements that may be used with swimming pool sanitization.}

- [Stabilized Granules]
- [Do not mix with other products]
- [Ideal for pool start-ups]
- [Stabilized Chlorinator]
- [Routine Chlorinator]
- [For everyday use]
- [Granular Chlorinating Concentrate]
- [Kills Bacteria]
- [Controls Bacteria]
- [With SUNSHIELD™ Protects chlorine from sunlight, so you use less]
- [[Easy-to-use],[multifunctional] chlorinating granules protect against algae and bacteria for water
 that stays [clean], [clear] [&] [free of visible algae]]

{Optional marketing statements that may be used with vinyl pool algae killer.}

- [Stabilized Granules]
- [Do not mix with other products]
- [Kills algae in vinyl-lined and colored pools]
- [Algaecide]
- [For Vinyl, Colored Plaster and Fiberglass Pools]

{Optional marketing statements that may be used with vinyl pool shock.}

- [For superchlorination]
- [Shock treatment]
- [Stabilized chlorinator]
- [Destroys swimmer wastes*] *[such as] [body & suntan oils] [body oils] [&] [suntan oils] [&] [sweat] [perspiration] [&] [lotions] [&] [urine]
- [Restores water clarity]
- [Best for vinyl-lined and colored pools]
- [Do not mix with other products]
- [Fast dissolving shock treatment]
- [Destroys swimmer contaminants*] *[such as] [body & suntan oils] [body oils] [&] [suntan oils] [&] [sweat] [perspiration] [&] [lotions] [&] [urine]
- [Kills Bacteria & Algae]
- [For Vinyl, Colored Plaster and Fiberglass Pools]
- [No pre-dissolving]
- [For In-ground and Above-ground Pools]
- [Won't Bleach Vinyl, Fiberglass or Colored Plaster Pools]

↑
new
↓

{Optional marketing statements that may be used with pool shock.}

- [For superchlorination]
- [Shock treatment]
- [Stabilized chlorinator]
- [Destroys swimmer wastes*] *[such as] [body & suntan oils] [body oils] [&] [suntan oils] [&] [sweat] [perspiration] [&] [lotions] [&] [urine]
- [Restores water clarity]
- [Best for vinyl-lined and colored pools]
- [Do not mix with other products]
- [Fast dissolving shock treatment]
- [Destroys swimmer contaminants*] *[such as] [body & suntan oils] [body oils] [&] [suntan oils] [&] [sweat] [perspiration] [&] [lotions] [&] [urine]
- [Kills Bacteria & Algae]
- [For Vinyl, Colored Plaster and Fiberglass Pools]
- [No pre-dissolving]
- [For In-ground and Above-ground Pools]
- [Won't Bleach Vinyl, Fiberglass or Colored Plaster Pools]
- [The 6-in-1 difference]
- [[3-in-1] [4-in-1] [6-in-1] [all-purpose] [formula] [shock]]
- [[3-in-1] [4-in-1] [6-in-1] [formula][Action]]
- [[3-in-1] [4-in-1] [6-in-1] [shock] [pool algae killer] [pool algae preventer] [Sunlight protected]
- [removes organic contaminants*] [removes swimmer contaminants*] [clears water] *[such as] [body & suntan oils] [body oils] [&] [suntan oils] [&] [sweat] [perspiration] [&] [lotions] [&] [urine]
- [Kills green & black pool algae]

↑
new
↓

↑
new

[[With] Algae-killing formula]
 [Sunlight protected [for longer lasting chlorine] new
 [Protected against sunlight [to last longer]]
 [Removes organic contaminants [for clear water]*] *[such as] [body & suntan oils] [body oils]
[&] [suntan oils] [&] [sweat] [perspiration] [&] [lotions] [&] [urine]
 [Removes swimmer contaminants [for clear water]*] *[such as] [body & suntan oils] [body oils]
[&] [suntan oils] [&] [sweat] [perspiration] [&] [lotions] [&] [urine] ↑
 [Reduces [chlorine odor] [&] [eye irritation]] new
 [Directly to water]
 [Pre-dissolve]
 [For use with all filter & surface types]
 [Easy 1 2 3 Pool Care Brand System]
 [For pools up to 5,000 gallons] {for small pool product offering}
 [Easy open] {for 11lb bottle application}
 [Easy pour] {for 11lb bottle application}
 [[4-in-1] [Kills bacteria] [Removes organic contaminants*] [Reduces chlorine odor and eye
 irritation] [Reduces chlorine odor] [Reduces eye irritation] [Restores water clarity] [Does not
 bleach pool surfaces] [Won't bleach pool surfaces]] *[such as] [body & suntan oils] [body oils]
[&] [suntan oils] [&] [sweat] [perspiration] [&] [lotions] [&] [urine] ↑
 [Powers through filth for fresh, clear water] new
 [Step 3]
 [Shock]
 [Fast dissolving]
 [Clarifies water]
 [Clears cloudy water]
 [Clears water]
 [Creates sparkling water]

{Optional marketing statements that may be used with winter pool shock.}

[Winter shock treatment]
 [Fast dissolving shock treatment]
 [Makes spring start up easier]
 [Do not mix with other products]

{Optional marketing statements that may be used with spa sanitizing.}

[Stabilized chlorinator for spas]
 [For Spas & Hot Tubs]
 [Stabilized Chlorinator]
 [Routine Chlorinator]
 [For everyday use]
 [Granular Chlorinating Concentrate]
 [Destroys Contaminants*] *[such as] [body & suntan oils] [body oils] [&] [suntan oils] [&]
[sweat] [perspiration] [&] [lotions] [&] [urine] new
 [Kills Bacteria]
 [Controls Bacteria]
 [with SUNSHIELD™ Protects chlorine from sunlight, so you use less]
 [Do not mix with other products]

{Optional marketing statements that may be used with spa and hot tub shock treatment.}

- [Shock Treatment for Spas]
- [For Spas & Hot Tubs]
- [Spa Treatment]
- [Destroys Algae]
- [Destroys Bacteria]
- [Destroys Algae and Bacteria]
- [Fast Dissolving]
- [For Crystal Clear Spa Water]
- [For Crystal Clear Water]
- [For Sparkling Water]
- [For Sparkling, Clear Water]
- [Oxidizes Undesirable Compounds*] *[such as] [body & suntan oils] [body oils] [&] [suntan oils] [&] [sweat] [perspiration] [&] [lotions] [&] [urine]
- [Destroys undesirable compounds*] *[such as] [body & suntan oils] [body oils] [&] [suntan oils] [&] [sweat] [perspiration] [&] [lotions] [&] [urine]
- [Destroys contaminants*] *[such as] [body & suntan oils] [body oils] [&] [suntan oils] [&] [sweat] [perspiration] [&] [lotions] [&] [urine]
- [Do not mix with other products]

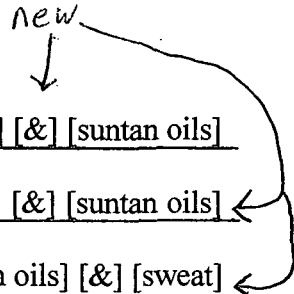

{Optional marketing statements that may be used with small, vinyl pool shock.}

- [For superchlorination]
- [Shock treatment]
- [Stabilized chlorinator]
- [Destroys swimmer wastes*] *[such as] [body & suntan oils] [body oils] [&] [suntan oils] [&] [sweat] [perspiration] [&] [lotions] [&] [urine]
- [Restores water clarity]
- [Do not mix with other products]
- [Fast dissolving shock treatment]
- [Destroys swimmer contaminants*] *[such as] [body & suntan oils] [body oils] [&] [suntan oils] [&] [sweat] [perspiration] [&] [lotions] [&] [urine]
- [Kills Bacteria & Algae]
- [No pre-dissolving]
- [For Small [Vinyl] Pools]
- [For Small [Vinyl] Aboveground Pools]

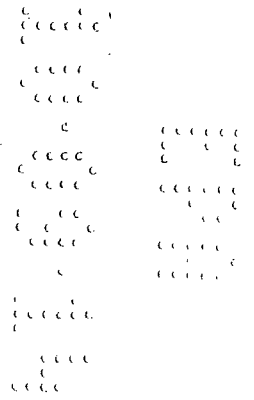
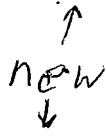

{Following chart is optional}

[Application Methods	Directly to water [or] Pre-dissolve]
[Surface Types	Aggregate Concrete Fiberglass Gunitite Plaster Vinyl]
[Filter Types	D.E., Sand, Cartridge, Zeolite]

{Spanish statement directing Spanish speakers to obtain assistance before using product. Translates in English to: "If you do not understand the (this) label, find someone to explain it to you in detail."}

[Si usted no entiende la etiqueta, busque a alguien para que se lo explique a usted en detalle.]

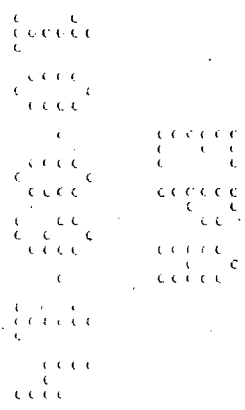

{Directions to be used for swimming pool sanitization.}

POOL SANITIZER

WHY TO USE THIS PRODUCT: This product is a quick dissolving stabilized granular swimming pool sanitizer, which when applied according to label directions, will release sufficient chlorine to retard the growth of harmful algae and control bacteria. This product's quick dissolve characteristics not only make it appropriate for all pool types, but won't leave behind the grit and haze other granular products can. Unlike calcium hypochlorite or liquid chlorine (bleach), this product's stabilized formula protects against sun light burn off, making it an efficient type of granular sanitizer for pools.

IMPORTANT NOTES

1. When using other products, as outlined in directions for this product, always follow label directions for those products.
2. Damage may be caused by direct contact of this product with pool surface or materials such as colored plaster, vinyl, wood or fiberglass.
3. This product may promote metal stains on pool surfaces. Always check water for metal content and if present, remove metals with a stain & scale inhibitor prior to the addition of this product.
4. Sunlight, rainfall, temperature, number of swimmers and frequency of pool use affect the rate of chlorine level loss. Adjust cleaning and chemical maintenance accordingly. To destroy undesirable compounds and keep pool clear, shock pool on a regular basis, typically every 1 to 2 weeks.

DIRECTIONS FOR USE:

It is a violation of Federal Law to use this product in any manner inconsistent with its labeling. Read entire label and use strictly in accordance with precautionary statements and directions.

BEFORE YOU BEGIN

1. Ensure all pool equipment is working properly. Clean or backwash filter following manufacturer's directions.
2. Adjust stabilizer levels to 40-50 ppm by adding [Stabilizer] [Chlorine Stabilizer].
3. Check water pH, alkalinity and calcium hardness with a test kit. Adjust pH to 7.2 - 7.6 by adding [pH Down] [pH Decreaser] to lower pH, or by adding [pH Up] [pH Add] to raise pH. Adjust alkalinity to 80 - 125 ppm for plaster pools, 125 - 150 for vinyl or fiberglass pools by adding [Alkalinity Increaser] [Alkalinity Plus]. Adjust calcium hardness to 200 - 275 ppm for plaster pools, 175 - 225 for vinyl or fiberglass pools by adding Calcium Hardness Increaser. Be sure to follow label directions.

11/29

NOW USE THIS PRODUCT:

START-UP/INITIAL TREATMENT:

1. If water is cloudy or green, superchlorinate pool with appropriate shock product until pool is clear.
2. With pump running and pool not in use, use a clean, dry, empty plastic scoop to broadcast 4 ounces of this product per 10,000 gallons of water directly into the deep end of the pool.
3. After two hours, test chlorine level (residual). Repeat treatments until you obtain a chlorine level of 1-4 ppm.
4. Add an algae preventative to keep your pool free of algae growth.

ROUTINE MAINTENANCE:

1. Check the chlorine level of your pool frequently with a test kit or test strips. Add this product as needed to maintain a chlorine level of 1-4 ppm. You may need to test and add product as often as each day.
2. With pump running and pool not in use, use a clean, dry, empty plastic scoop to broadcast 2-3 ounces of this product per 10,000 gallons of water directly into the deep end of the pool.

Reentry into treated swimming pools is prohibited above levels of 4 ppm chlorine due to risk of body injury.

{Combined use directions for swimming pool sanitization, shock, algaecide and pool closing}

DIRECTIONS FOR USE:

It is a violation of Federal Law to use this product in any manner inconsistent with its labeling. Read entire label and use strictly in accordance with precautionary statements and directions.

Test & balance water prior to use. Adjust pH to 7.2-7.6 [and free chlorine to 1 – 4 ppm]. Visit [website] for [free water analysis] [&] [personalized product and dosage recommendations].

Use: Protects against algae and bacteria for water that stays clean, clear & free of visible algae.

Application Methods	
Always apply in dry form using a designated clean, dry plastic scoop.	
Directly to Pool	Add product to deepest area of pool. Brush visible product until dissolved to avoid surface damage. Operate filter and pump for at least 2-4 [hrs] [hours].
Pre-dissolve in Water (recommended for water under 70° F)	Outdoors, in a clean plastic bucket add product to cool water stirring with a clean plastic or wooden spoon. NEVER add water to product. NEVER add more than 1 [lb] [pound] of this product to less than 3 gallons of cool water. Do not mix with other products when pre-dissolving.

Dosage per 10,000 gallons	When/How to Use (apply per above application methods)
4 oz	To Reach 1-4 ppm at Start-Up Test and repeat application as needed to reach 1-4 ppm of chlorine.
2-3oz	To Sanitize Daily or as needed to maintain 1-4 ppm of chlorine.
1 lb	To Shock Weekly or if water is cloudy or green.
1 lb – Light algae 2 lb – Heavy algae	To Kill Algae 1. Brush algae from pool surfaces prior to use. 2. Apply product at night per above application methods. 3. Repeat after 24 [hrs] [hours] if needed.

For Best Results: Use weekly and apply more product after heavy use, high temperatures, or rain [to maintain 1 – 4 ppm].

[To Close Pool: Add 1 [lb] [pound] per 10,000 gallons per above application methods. Next add algaecide per closing directions. [Visit [website] for pool closing instructions.]]

Re-entry into treated swimming pools is prohibited above levels of 4ppm chlorine due to risk of body injury.

{Directions to be used for vinyl pool algae killer}

FOR KILLING ALGAE IN VINYL POOLS

WHY TO USE THIS PRODUCT: This product is an easy and potent way to destroy black algae and green free floating algae in vinyl, colored plaster or fiberglass pools. This product's quick-dissolving granular form makes it ideal for treating most algae types and is appropriate for most pool surfaces under normal conditions. For treatment of mustard or yellow colored algae, use [Mustard Algae Killer] [a mustard algae killer] [or] [Algaecide Plus] [Algicide Plus].

IMPORTANT NOTES:

1. When using other products, as outlined in directions for this product, always follow label directions for those products.
2. Damage may be caused by direct contact of this product with pool surface or materials such as colored plaster, vinyl, wood or fiberglass.
3. This product may promote metal stains on pool surfaces. Always check water for metal content and if present, remove metals with a stain & scale inhibitor prior to the addition of this product.
4. Sunlight, rainfall, temperature, number of swimmers and frequency of pool use affect the rate of chlorine level loss. Adjust cleaning and chemical maintenance accordingly. To destroy undesirable compounds and keep pool clear, shock pool on a regular basis, typically every 1 to 2 weeks.

DIRECTIONS FOR USE: It is a violation of Federal Law to use this product in any manner inconsistent with its labeling. Read entire label and use strictly in accordance with precautionary statements and directions.

BEFORE YOU BEGIN

1. Ensure all pool equipment is working properly. Clean or backwash filter following manufacturer's directions.
2. Check water pH, alkalinity and calcium hardness with a test kit. Adjust pH to 7.2 - 7.6 by adding [pH Down] [pH Decreaser] to lower pH, or by adding [pH Up] [pH Add] to raise pH. Adjust alkalinity to 80 - 125 ppm for plaster pools, 125 - 150 for vinyl or fiberglass pools by adding [Alkalinity Increaser] [Alkalinity Plus]. Adjust calcium hardness to 200 - 275 ppm for plaster pools, 175 - 225 for vinyl or fiberglass pools by adding Calcium Hardness Increaser. Be sure to follow label directions.

For Green Floating Algae

NOW USE THIS PRODUCT:

1. For heavy to medium algae growth use 2 pounds per 10,000 gallons of water. For light algae growth use one pound per 10,000 gallons of water. At night or when pool is not in use, broadcast this product directly into the water in the deep end of the pool with pump running. To prevent damage to pool surface, use a pool brush to disperse any granules that may have settled to the bottom of the pool.
2. After treatment, wait 12 - 24 hours, then vacuum any remaining algae and backwash filter.
3. If algae is still visible after 24 hours, repeat this treatment.

14/29

For Black Algae

NOW USE THIS PRODUCT:

1. Shut pump off, vigorously brush any visible algae spots and wait 4 hours before proceeding to the next step.
2. For heavy to medium algae growth, use 2 pounds per 10,000 gallons of water. For light algae growth, use one pound per 10,000 gallons of water. At night or when pool is not in use, broadcast this product over areas of heaviest growth. To prevent damage to pool surface, use a pool brush to disperse any un-dissolved granules
3. After treatment, wait 12 - 24 hours, turn pump on and remove dead algae from pool surfaces with a brush, and vacuum dead algae through filter. Brush any remaining algae spots.
4. If algae is still visible, repeat this treatment.

Reentry into treated swimming pools is prohibited above levels of 4 ppm chlorine due to risk of body injury.

{Directions to be used for vinyl pool shock.}

VINYL POOL SHOCK

WHY TO USE THIS PRODUCT: This product contains a completely soluble active ingredient to destroy non-filterable swimmer wastes (such as [body & suntan oils] [body oils] [suntan oils], [sweat] [perspiration], lotions and urine) in vinyl-lined, colored plaster or fiberglass pools. When used as directed, this product restores water clarity, kills bacteria, helps kill algae, and destroys unpleasant odors.

New

IMPORTANT NOTES:

1. Mixture of this product with any other shock product (in dry form or during pre-dissolving) prior to adding to pool could result in fire and/or explosion.
2. When using other products, as outlined in directions for this product, always follow label directions for those products.
3. Damage may be caused by direct contact of this product with pool surfaces or materials such as colored plaster, vinyl, wood or fiberglass.
4. This product may promote metal stains on pool surfaces. Always check water for metal content and if present, remove metals with a stain & scale inhibitor prior to the addition of this product.
5. Sunlight, rainfall, temperature, number of swimmers and frequency of pool use affect the rate of chlorine level loss. Adjust cleaning and chemical maintenance accordingly.

DIRECTIONS FOR USE: It is a violation of Federal Law to use this product in any manner inconsistent with its labeling. Read entire label and use strictly in accordance with precautionary statements and directions.

BEFORE YOU BEGIN:

1. Ensure all pool equipment is working properly. Clean or backwash filter following manufacturer's directions.
2. Check water pH, alkalinity and calcium hardness with a test kit. Adjust pH to 7.2 - 7.6 by adding [pH Down] [pH Decreaser] to lower pH, or by adding [pH Up] [pH Add] to raise pH. Adjust alkalinity to 80 - 125 ppm for plaster pools, 125 - 150 for vinyl or fiberglass pools by adding [Alkalinity Increaser] [Alkalinity Plus]. Adjust calcium hardness to 200 - 275 ppm for plaster pools, 175 - 225 for vinyl or fiberglass pools by adding Calcium Hardness Increaser. Be sure to follow label directions.

NOW USE THIS PRODUCT:

For Start-Up Initial Shocking:

1. With pump running and pool not in use, broadcast [1 pound of this product per 10,000 gallons] {or} [10 ounces of this product per 6,000 gallons] {or} [one bag of this product per 6,000 gallons] {when product is sold in 10 ounce bags} of water directly into the pool in the deep end of the pool. To prevent possible damage to pool surface, use a pool brush to disperse any granules that may have settled to the bottom of the pool.
2. Repeat procedure after 24 hours, if needed, to establish a chlorine residual of 1-4 ppm as determined by a test kit.

16/29

For Routine Shocking:

1. Every week with pump running and pool not in use, broadcast [1 pound of this product per 10,000 gallons] *[or]* [10 ounces of this product per 6,000 gallons] *{or}* [one bag of this product per 6,000 gallons] *{when product is sold in 10 ounce bags}* of water directly into the pool in the deep end of the pool. To prevent possible damage to pool surface, use a pool brush to disperse any granules that may have settled to the bottom of the pool.

Reentry into treated swimming pools is prohibited above levels of 4 ppm chlorine due to risk of body injury.

{Directions to be used for pool shock.}

DIRECTIONS FOR USE:

It is a violation of Federal Law to use this product in any manner inconsistent with its labeling. Read entire label and use strictly in accordance with precautionary statements and directions.

Test & balance water prior to use. Adjust pH to 7.2-7.6 [and free chlorine to 1 – 4 ppm]. Visit [website] for [free water analysis] [&] [personalized product and dosage recommendations].

Use: Destroys organic contaminants* & odors for clear [swim-ready] [ready-to-swim] water.

Dosage: 1[lb] [pound] per 10,000 gallons

← new

Directions: Broadcast into pool's deepest area with filter and pump operating and continuously running for 4-8 [hrs] [hours] after use. Brush un-dissolved product to prevent possible surface damage.

For Best Results: Use weekly and apply more product after heavy use, high temperatures, or rain.

new
↓

*[such as] [body & suntan oils] [body oils] [&] [suntan oils] [&] [sweat] [perspiration] [&] [lotions] [&] [urine]

Re-entry into treated swimming pools is prohibited above levels of 4 ppm chlorine due to risk of bodily injury.

{Directions to be used for winter pool shock}

WINTER POOL SHOCK

WHY TO USE THIS PRODUCT: To avoid costly spring problems (algae, stains, cloudy water, high chlorine demand) properly prepare your pool for the winter using this product. This product oxidizes organic wastes (such as [body & suntan oils] [body oils] [suntan oils], [sweat] [perspiration], lotions and urine), provides long lasting chlorine protection, helps keep pool surfaces clean, and helps protect water during the off season months.

new

IMPORTANT NOTES

- 1. When using other products, as outlined in directions for this product, always follow label directions for those products.
- 2. This product may cause damage to pool finish or materials such as colored plaster, vinyl, wood or fiberglass pool surfaces. Avoid spilling granules on pool surface.
- 3. This product may promote metal stains on pool surfaces. Always check water for metal content and if present, remove metals with a stain & scale inhibitor prior to the addition of this product.

BEFORE YOU BEGIN

- 1. Ensure all pool equipment is working properly. Clean or backwash filter following manufacturer's directions.
- 2. Adjust stabilizer levels to 40-50 ppm by adding [Chlorine Stabilizer] [Stabilizer].
- 3. Check water pH, alkalinity and calcium hardness with a test kit. Adjust pH to 7.2 - 7.6 by adding [pH Down] [pH Decreaser] to lower pH, or by adding [pH Up] [pH Add] to raise pH. Adjust alkalinity to 80 - 125 ppm for plaster pools, 125 - 150 for vinyl or fiberglass pools by adding [Alkalinity Increaser] [Alkalinity Plus]. Adjust calcium hardness to 200 - 275 ppm for plaster pools, 175 - 225 for vinyl or fiberglass pools by adding Calcium Hardness Increaser. Be sure to follow label directions.

DIRECTIONS FOR USE:

It is a violation of Federal Law to use this product in any manner inconsistent with its labeling. Read entire label and use strictly in accordance with precautionary statements and directions.

NOW USE THIS PRODUCT:

- 1. Use one pound of this product per 10,000 gallons of water. Broadcast this product directly into water in the deep end of the pool.
- 2. Circulate water for several hours, then add algicide.
- 3. Turn off pump. Drain equipment or add antifreeze to equipment to prevent freeze damage.
- 4. Install pool cover. A second treatment of this product in mesh covered or non-covered pools may be required prior to water freezing.

Reentry into treated swimming pools is prohibited above levels of 4 ppm chlorine due to risk of body injury.

{Directions to be used for spa sanitizing}

SPA SANITIZING

WHY TO USE THIS PRODUCT: This product is a quick dissolving stabilized granular spa sanitizer, which when applied according to label directions, will release sufficient chlorine to retard the growth of harmful algae and control bacteria.

IMPORTANT NOTES

- 1. When using other products, as outlined in directions for this product, always follow label directions for those products.
- 2. This product may cause damage to spa or hot tub finish or materials such as colored plaster, vinyl, wood or fiberglass surfaces. Avoid spilling granules on spa surface.
- 3. This product may promote metal stains on spa or hot tub surfaces. Always check water for metal content and if present, remove metals with a stain & scale inhibitor prior to the addition of this product.
- 4. Sunlight, rainfall, temperature, number of swimmers and frequency of spa and hot tub use affect the rate of chlorine loss. Adjust cleaning and chemical maintenance accordingly.

BEFORE YOU BEGIN

- 1. Ensure all spa equipment is working properly. Clean or backwash filter following manufacturer's directions.
- 2. Check water pH, alkalinity and calcium hardness with a test kit. Adjust pH to 7.2 - 7.6 by adding [pH Down] [pH Decreaser] to lower pH, or by adding [pH Up] [pH Add] to raise pH. Adjust alkalinity to 80 - 125 ppm for plaster spas, 125 - 150 for vinyl or fiberglass spas by adding [Alkalinity Increaser] [Alkalinity Plus]. Adjust calcium hardness to 200 - 275 ppm for plaster spas, 175 - 225 for vinyl or fiberglass spas by adding Calcium Hardness Increaser.

DIRECTIONS FOR USE:

It is a violation of Federal Law to use this product in any manner inconsistent with its labeling. Read entire label and use strictly in accordance with precautionary statements and directions.

NOW USE THIS PRODUCT:

FOR ROUTINE MAINTENANCE DOSES:

- 1. With pump on, add 1/2 teaspoon of this product per 100 gallons of water (or 5 teaspoons per 1,000 gallons) as an initial treatment.
- 2. Repeat at 15 to 20 minute intervals until a residual of 3-5 ppm of available chlorine is established as determined by test kit.
- 3. A test kit must be used regularly to determine the frequency of additional doses of this product needed to maintain 3-5 ppm of available chlorine in the water.

20/29

[SUPERCHLORINATION OR SHOCK TREATMENT] [SUPERCHLORINATION] [SHOCK TREATMENT]

[Superchlorinate] [or] [shock] weekly as part of your routine maintenance program, or more frequently following heavy spa use. Make sure recirculating pump is operating. Use one teaspoon of this product per 100 gallons of water (or $\frac{1}{4}$ cup per 1,000 gallons) by broadcasting across water surface. Allow circulating pump to operate for 15-20 minutes. Do not enter spa until chlorine level is between 3 – 5 ppm.

Reentry into treated spas is prohibited above levels of 5 ppm chlorine due to risk of body injury.

2/29

{Directions to be used for spa and hot tub shock treatment.}

SHOCK TREATMENT FOR SPAS AND HOT TUBS

WHY TO USE THIS PRODUCT: This product is a fast-dissolving, granular product used for periodic shocking to eliminate the organic compounds (such as [body & suntan oils] [body oils] [suntan oils], [sweat] [perspiration], lotions and urine) in a spa or hot tub which cause odors and cloudy water. This product will raise residual chlorine levels but is not intended for use as a routine sanitizer.

new

IMPORTANT NOTES:

1. When using other products, as outlined in directions for this product, always follow label directions for those products.
2. Damage may be caused by direct contact of this product with spa surface or materials such as colored plaster, vinyl, wood or fiberglass.
3. This product may promote metal stains on spa surfaces. Always check water for metal content and if present, treat with a stain & scale inhibitor prior to the addition of this product.
4. Sunlight, rainfall, temperature, number of bathers and frequency of spa use affect the rate of sanitizer loss. Adjust cleaning and chemical maintenance accordingly. Use this product to shock weekly or more often as needed.

DIRECTIONS FOR USE:

It is a violation of Federal Law to use this product in any manner inconsistent with its labeling. Read entire label and use strictly in accordance with precautionary statements and directions.

BEFORE YOU BEGIN:

1. Ensure all spa equipment is working properly. Clean or backwash filter following manufacturer's directions.
2. Adjust stabilizer levels to a minimum of 40-50 ppm in outdoor spas by adding stabilizer.
3. Check water alkalinity, pH and calcium hardness with a test kit. Adjust alkalinity to 80-125 ppm for plaster spas, 125-150 for other types of spas by adding an alkalinity increaser. Adjust pH to 7.2 - 7.6 by adding a pH decreaser to lower pH, or by adding a pH increaser to raise pH. Adjust calcium hardness to 200-275 ppm for plaster spas, 175-225 for other types of spas by adding a calcium hardness increaser.
4. Ensure chlorine level is between 3-5 ppm before using this product.

NOW USE THIS PRODUCT:

1. Make sure recirculating pump is operating. Use one teaspoon of this product per 100 gallons of water (or ¼ cup per 1,000 gallons) by broadcasting across water surface.
1. Allow circulating pump to operate for 15-20 minutes.
2. Use this product weekly as part of your routine maintenance program, or more frequently following heavy spa use.
4. Do not enter spa until chlorine level is between 3 – 5 ppm.

Reentry into treated spas is prohibited above levels of 5 ppm chlorine due to risk of body injury.

{Directions to be used for *small, vinyl pool shock*}

SMALL VINYL POOL SHOCK

WHY TO USE THIS PRODUCT: This product is for use in small aboveground vinyl pools. This product contains a completely soluble active ingredient to destroy non-filterable swimmer wastes (such as [body & suntan oils] [body oils] [suntan oils], [sweat] [perspiration], lotions and urine) in vinyl-lined pools. When used as directed, this product restores water clarity, kills bacteria, helps kill algae, and destroys unpleasant odors.

IMPORTANT NOTES:

1. Mixture of this product with any other shock product (in dry form or during pre-dissolving) prior to adding to pool could result in fire and/or explosion.
2. When using other products, as outlined in directions for this product, always follow label directions for those products.
3. Damage may be caused by direct contact of this product with pool surfaces or materials such as colored plaster, vinyl, wood or fiberglass.
4. This product may promote metal stains on pool surfaces. Always check water for metal content and if present, remove metals with a stain & scale inhibitor prior to the addition of this product.
5. Sunlight, rainfall, temperature, number of swimmers and frequency of pool use affect the rate of chlorine level loss. Adjust cleaning and chemical maintenance accordingly.

DIRECTIONS FOR USE: It is a violation of Federal Law to use this product in any manner inconsistent with its labeling. Read entire label and use strictly in accordance with precautionary statements and directions.

BEFORE YOU BEGIN:

1. Ensure all pool equipment is working properly. Clean or backwash filter following manufacturer's directions.
2. Check water pH, alkalinity and calcium hardness with a test kit. Adjust pH to 7.2 - 7.6 by adding pH Decreaser to lower pH, or by adding pH Add to raise pH. Adjust alkalinity 125 - 150 PPM by adding Alkalinity Plus. Adjust calcium hardness to 175 - 225 PPM by adding Calcium Hardness Increaser. Be sure to follow label directions.

NOW USE THIS PRODUCT:

For Start-Up Initial Shocking:

1. With pump running and pool not in use, broadcast 5 teaspoons per 500 gallons of water directly into the pool*. To prevent possible damage to pool surface, use a pool brush to disperse any granules that may have settled to the bottom of the pool.
2. Repeat procedure after 24 hours, if needed, to establish a chlorine residual of 1-4 ppm as determined by a test kit.

For Routine Shocking:

1. Every week with pump running and pool not in use, broadcast 5 teaspoons per 500 gallons of water directly into the pool*. To prevent possible damage to pool surface, use a pool brush to disperse any granules that may have settled to the bottom of the pool.

new

23/29

*Use a clean, dedicated spoon to dose the appropriate amount of product into the pool. Keep the dosage spoon stored out of reach of children.

{Optional table of alternate dosage rates per gallons to be treated.}

Quick Reference Table for Initial and Routine Shocking Dosage for Common Pool Sizes

Pool Capacity in Gallons	250	500	1000	1500	2000	2500	3000	3500	5500
Standard Dose	2.0 tsp.	5.0 tsp.	3.0 tbs.	2.5 oz.	3.0 oz.	4.0 oz.	5.0 oz.	5.5 oz.	9.0 oz.

[3 teaspoons equals 1 tablespoon.]

[2 tablespoons equals 1 ounce.]

Reentry into treated swimming pools is prohibited above levels of 4 ppm chlorine due to risk of body injury.

24/29

{Storage and Disposal directions when product is sold in bags.}

[STORAGE AND DISPOSAL: Keep this product dry in its original unopened bag until use. For partially used bags, fold over top of bag and secure with adhesive tape. Store unopened and partially used bags in a secure location away from children. Store in a cool, dry, well ventilated area away from heat or open flame. Moisture may decompose this product and cause a violent reaction leading to fire and explosion. In case of decomposition, isolate bag if possible and flood area with large amounts of water to dissolve all material before discarding this bag. Do not contaminate food or feed by storage or disposal. **CONTAINER DISPOSAL:** Non-refillable container. Do not reuse or refill this container. Offer for recycling, if available. Triple rinse container (or equivalent) promptly after emptying.]

{Storage and Disposal directions when product is sold in bottles.}

[STORAGE AND DISPOSAL: Keep this product dry in original tightly closed container when not in use. Store in a cool, dry, well ventilated area away from heat or open flame. Moisture may decompose this product and cause a violent reaction leading to fire and explosion. In case of decomposition, isolate container if possible and flood area with large amounts of water to dissolve all material before discarding this container. Do not contaminate food or feed by storage or disposal. **CONTAINER DISPOSAL:** Non-refillable container. Do not reuse or refill this container. Offer for recycling, if available. Triple rinse container (or equivalent) promptly after emptying.]

PRECAUTIONARY STATEMENTS

HAZARDS TO HUMANS AND DOMESTIC ANIMALS: DANGER: Corrosive: Causes irreversible eye damage. May be fatal if inhaled. Harmful if swallowed or absorbed through skin. Do not get in eyes, on skin or on clothing. Do not breathe dust or vapor. Wear goggles, face shield or safety glasses. Wash thoroughly with soap and water after handling. Remove contaminated clothing and wash before reuse.

{When First Aid is not located on front panel of label, it will be separated by line rules from adjacent text and be in a different color.}

FIRST AID: IF IN EYES: Hold eye open and rinse slowly and gently with water for 15-20 minutes. Remove contact lenses, if present, after the first 5 minutes, then continue rinsing eye. Call a poison control center or doctor for treatment advice. **IF ON SKIN OR CLOTHING:** Take off contaminated clothing. Rinse skin immediately with plenty of water for 15-20 minutes. Call a poison control center or doctor for treatment advice. **IF SWALLOWED:** Call poison control center or doctor immediately for treatment advice. Have person sip a glass of water if able to swallow. Do not induce vomiting unless told to do so by the poison control center or doctor. Do not give anything by mouth to an unconscious person. **IF INHALED:** Move person to fresh air. If person is not breathing, call 911 or an ambulance, then give artificial respiration, preferably mouth-to-mouth, if possible. Call poison control center or doctor for treatment advice.

Note to Physician: Probable mucosal damage may contraindicate the use of gastric lavage.

Have the product container or label with you when calling a poison control center or doctor, or going for treatment. [IN CASE OF MEDICAL EMERGENCY, CALL [1-303-623-5716] [1-877-800-5553] [1-866-366-5048] [telephone number supplied by supplemental registrant].]

25/29

PHYSICAL OR CHEMICAL HAZARDS: STRONG OXIDIZING AGENT: Do not mix with other chemicals. Mix only with water. Never add water to product. Always add product to large quantities of water. Use clean dry utensils. Do not add this product to any dispensing device containing remnants of any other product. Such use may cause a violent reaction leading to fire or explosion. Contamination with moisture, organic matter or other chemicals will start a chemical reaction and generate heat, hazardous gas, possible fire and explosion. In case of contamination or decomposition, do not reseal container. If possible, isolate container in open air or well ventilated area. Flood area with large volumes of water.

[Environmental hazards statement for end-use products in containers of less than 50 pounds (solid, dry weight).]

[ENVIRONMENTAL HAZARDS: This pesticide is toxic to fish and aquatic organisms.]

{Environmental hazards statement for end-use products in containers of equal to or greater than 50 pounds (solid, dry weight).}

[ENVIRONMENTAL HAZARDS: This pesticide is toxic to fish and aquatic organisms. Do not discharge effluent containing this product into lakes, streams, ponds, estuaries, oceans or other waters unless in accordance with the requirements of a National Pollutant Discharge Elimination System (NPDES) permit and the permitting authority has been notified in writing prior to discharge. Do not discharge effluent containing this product to sewer systems without previously notifying the local sewage treatment plant authority. For guidance contact your State Water Board or Regional Office of the EPA.]

[NOTE: Buyer assumes all responsibility for safety and use not in accordance with directions.]

[NOTE: User assumes all responsibility for use not in accordance with directions.]

{The following is optional text to be used at Recreational Water Products' discretion with swimming pool use directions. This information is non-essential and will be provided only as a courtesy. Will not appear on all swimming pool products.}

HOW TO CALCULATE POOL CAPACITY

Shape of Pool	Gallons of water
Rectangular	Average depth x average length x average width x 7.5
Circular	Diameter x diameter x average depth x 5.9
Oval	Full width x full length x average depth x 5.9
Irregular	Consult pool builder

{The following is optional text to be used at Recreational Water Products' discretion. This information is non-essential and will be provided only as a courtesy. Will not appear on all labels.}

[NOTE: Any questions or comments about Aqua Chem Products? [In the continental U.S. call 1-800-252-POOL (7665).] [Ask for your free pool care booklet.]

[Questions or comments, Call 1-800-252-POOL (7665).]

[[Questions?] [Pool Care Tips?] [1-800-SOS-POOL]]

[Visit Aqua Chem's Internet Web Site at <http://www.aquachem.com>]

[Visit PoolTime's Internet Web Site at <http://www.pooltime.com>]

[Visit Brand Name's Internet Web Site at <http://www.brandname.com>]

{Optional Graphics}



⚠ WARNING
⚠ AVISO

Children can fall into bucket and drown.
Keep children away from bucket with even a small amount of liquid.

Los niños pueden caer dentro de el balde y ahogarse.
Mantenga a los niños alejados de los baldes aunque solo contengan un poco de liquido.



27/29

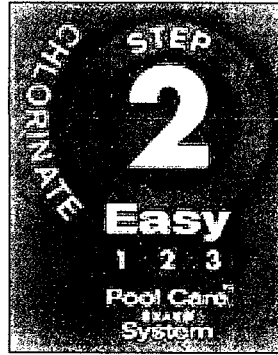
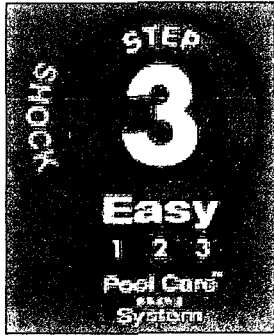

{For kits that treat pools 5,000 gallons or less.}

- [{Brandname} Small Pool [easy] [start-up] [maintenance] [start-up & maintenance] kit]
- [{Brandname} Pop-up Pool [easy] [start-up] [maintenance] [start-up & maintenance] kit]
- [{Brandname} Inflatable Pool [easy] [start-up] [maintenance] [start-up & maintenance] kit]

[Treats up to 5,000 gallons.]

[[Kit] contains:

- [[X] lb of (insert ABN or supplemental for EPA Reg. No. 67262-1, shock product name)]
- [[X] lb of (insert ABN or supplemental for EPA Reg. No. 67262-17, 1" tablet product name)]
- [6-way test strips] [Smart Strips]
- [[small] [above ground] [pop-up] [inflatable] Pool Care Guide]

[Use only with pools that have a water re-circulating system (pump) & filter.]

Tamper Evident Tear Strip
Tear away by using "ring pull" on either side of lid

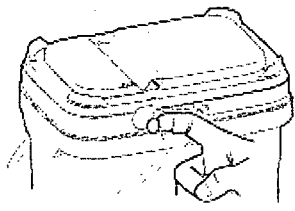

To open the lid (after the tear strip is removed)

Step-1

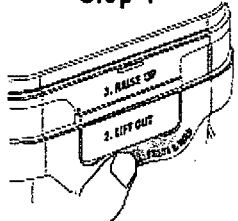

Step-2

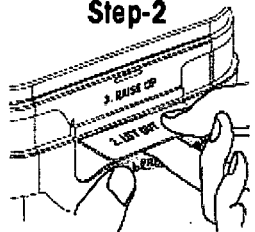

Step-3

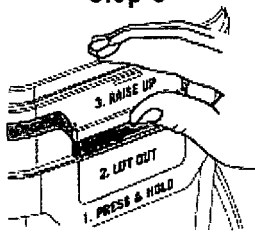



To open the lid
(after the tear strip is removed)

Step-1

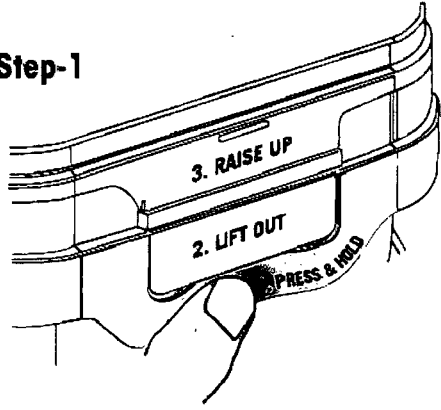

Step-2

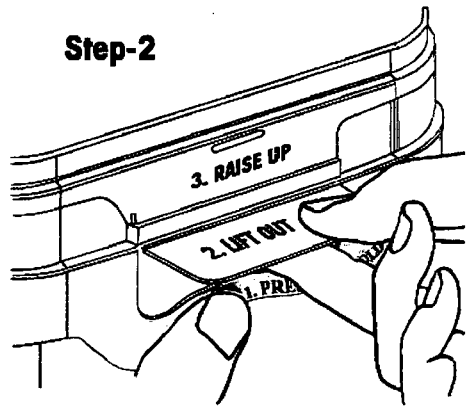

Step-3

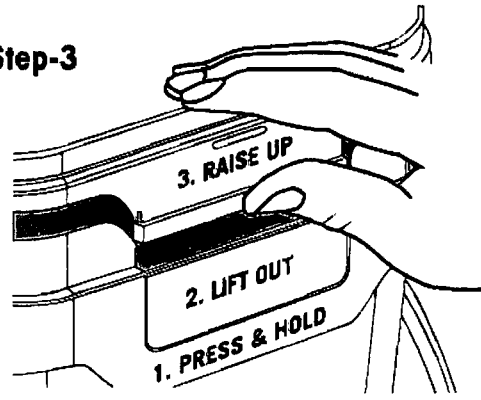

Do not store in direct sunlight