

62719-4

05/07/2013

1/53



UNITED STATES ENVIRONMENTAL PROTECTION AGENCY
WASHINGTON, D.C. 20460

MAY - 7 2013

OFFICE OF CHEMICAL SAFETY AND
POLLUTION PREVENTION

Mr. Dave Barnekow
Regulatory Leader - Regulatory Affairs
Dow AgroSciences LLC
9330 Zionsville Road
Indianapolis, IN 46268

Dear Mr. Barnekow:

Subject: Label amendment; lower dosage factor for bedbugs
Vikane
EPA Registration Number 62719-4
Submission dated December 18, 2012
Decision Number 473428

The amendment referred to above is acceptable in accordance with the Federal Insecticide, Fungicide, and Rodenticide Act, as amended, subject to the comment below:

1. Registration does not eliminate the need for continual reassessment of pesticides. If the Agency determines that, at any time, additional data are required to maintain in effect an existing registration, the Agency will require submission of such data.
2. Submit one (1) copy of the final printed label (with all the graphics, illustrations and the Structural Fumigation Manual) before you release the product for shipment bearing the amended labeling. Your release for shipment of the product constitutes acceptance of this condition. If this condition is not complied with, the registration will be subject to cancellation in accordance with FIFRA section 6(e).

A stamped copy of the label is enclosed for your records. A copy of the efficacy review is also enclosed for your perusal. If you have any questions, contact Rita Kumar at (703) 308-8291 or kumar.rita@epa.gov.

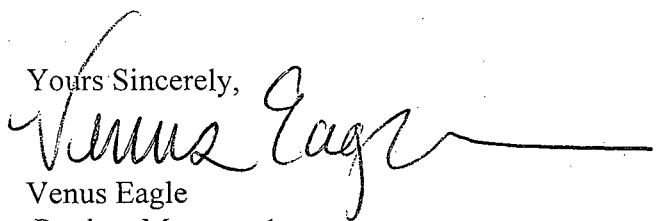
Yours Sincerely,

Venus Eagle
Product Manager 1
Insecticide Rodenticide Branch
Registration Division (7505P)

Enclosures (2)

2/53

(Cylinder Label):

RESTRICTED USE PESTICIDE DUE TO INHALATION TOXICITY
For sale to and use only by Certified Applicators or persons under their direct supervision and only for those uses covered by the Certified Applicator's certification.

Vikane®

Specialty Gas Fumigant

For control of: Existing infestations of listed insects and related pests such as drywood termites, Formosan termites, powder post beetles, death watch beetles, old house borers, bedbugs, cockroaches, clothes moths, rodents (rats, mice), and the larvae and adults of carpet beetles (except egg stage), oriental, American, and brown-banded cockroaches.

For use in: Dwellings (including mobile homes), buildings, construction materials, furnishings (household effects), shipping containers and vehicles including automobiles, buses, surface ships, passenger railcars, and recreational vehicles (but not including aircraft).

When fumigating, observe local, state, and federal rules and regulations including such things as use of chloropicrin, clearing devices, positive-pressure self-contained breathing apparatus, security requirements, and placement of warning signs.

Application personnel must participate in Dow AgroSciences' Sulfuryl Fluoride Training and Stewardship Plan.

Active Ingredient	
sulfuryl fluoride	99.8%
Other Ingredients	0.2%
Total	100.0%

**ACCEPTED
MAY - 7 2013**

Under the Federal Insecticide, Fungicide, and Rodenticide Act, as amended, for the pesticide registered under:

Keep Out of Reach of Children

DANGER  **POISON**

[Editors note: the word POISON must appear in red]

EPA. Reg. No: 62 719-4

PELIGRO

Precaucion al usuario: Si usted no lee inglés, no use este producto hasta que la etiqueta le haya sido explicada ampliamente.

Precautionary Statements

Hazards to Humans and Domestic Animals

Extremely Hazardous Liquid And Vapor Under Pressure • Fatal If Inhaled • May Be Fatal If Swallowed • Liquid May Cause Freeze Burns of Exposed Skin

Do not get in eyes, on skin, or on clothing. Vikane® specialty gas fumigant is odorless. Exposure to toxic levels may occur without warning or detection by the user.

First Aid

In all cases of overexposure, such as nausea, difficulty in breathing, abdominal pain, slowing of movements and speech, numbness in extremities, get medical attention immediately. Take person to a doctor or emergency treatment facility.

If inhaled: Get exposed person to fresh air. Keep warm and at rest. Make sure person can breathe freely. If breathing has stopped, give artificial respiration. Do not put anything in the mouth of an unconscious person. Call a poison control center or doctor for further treatment advice.

If liquid is on skin or on clothing: Immediately apply water to contaminated area of clothing before removing. Once area has thawed, remove contaminated clothing, shoes, and other items covering skin. Wash contaminated skin area thoroughly or shower. Call a poison control center or doctor for further treatment advice.

If liquid is in eyes: Hold eye open and rinse slowly and gently with water for 15-20 minutes. Remove contact lenses, if present, after the first 5 minutes, then continue rinsing eye. Call a poison control center or doctor for treatment advice.

Note to Physician: Vikane is a gas which has no warning properties such as odor or eye irritation. (However, chloropicrin is used as a warning agent and is a known lachrymator). Early symptoms of exposure to Vikane are respiratory irritation and central nervous system depression. Excitation may follow. Slowed movement, reduced awareness, and slow or garbled speech may be noted. Prolonged exposure can produce lung irritation, pulmonary edema, nausea, and abdominal pain. Repeated exposure to high concentrations can result in significant lung and kidney damage. Single exposures at high concentrations have resulted in death. Treat symptomatically.

Liquid Vikane in the eye may cause damage due to refrigeration or freezing.

Refer to elsewhere on this label for additional precautionary information and Directions for Use.

Notice: Read the entire label. Use only according to label directions. **Before using this product, read Warranty Disclaimer, Inherent Risks of Use, and Limitation of Remedies elsewhere on this label. If terms are unacceptable, return at once unopened.**

In case of emergency endangering health or the environment involving this product, call 1-800-992-5994.

Agricultural Chemical: Do not ship or store with food, feeds, drugs or clothing.

EPA Reg. No. 62719-4

EPA Est. _____

®Trademark of Dow AgroSciences LLC

Produced for

Dow AgroSciences LLC

9330 Zionsville Road

Indianapolis, IN 46268

Net Contents ____

4/53

Directions for Use

It is a violation of Federal law to use this product in a manner inconsistent with its labeling. Read all Directions for Use carefully before applying.

Storage and Handling

Store in dry, cool, well ventilated area under lock and key. Post as a pesticide storage area. If the storage area is in an occupied building, the storage area must have either 1) a forced air ventilation system that meets required local ordinances for the storage of hazardous materials and operates continuously; or 2) be equipped with a permanently mounted and properly maintained and functioning sulfuryl fluoride monitoring device designed to alert occupants of the building if sulfuryl fluoride in the air of the storage area is greater than 1 ppm. Store cylinders upright, secured to a rack or wall to prevent tipping. Do not contaminate water, food, or feed by storage.

Cylinders must not be subjected to rough handling or mechanical shock such as dropping, bumping, dragging, or sliding beyond that which would normally occur when moving cylinders. Do not transport any cylinders in closed vehicles where they occupy the same common airspace as personnel. Transport securely only in an upright position.

Do not remove valve protection bonnet and safety cap until immediately before use. Replace safety cap and valve protection bonnet when cylinder is not in use.

When cylinder is empty, close valve, screw safety cap onto valve outlet, and replace protection bonnet before returning to supplier. Only the registrant is authorized to refill cylinders. Do not use cylinder for any other purpose. Follow registrant's instructions for return of empty or partially empty cylinders.

Leak Procedures: Evacuate immediate area of leak. Use a NIOSH or MSHA approved positive pressure self-contained breathing apparatus (SCBA, not SCUBA) or combination air-supplied/SCBA respirator, such as manufactured by Ranger, Survivair, Scott, or MSA, for entry into affected areas to correct problem. Move leaking or damaged cylinder outdoors or to an isolated location, observing strict safety precautions. Work upwind if possible. Do not permit entry into leakage area by unprotected persons until concentration of fumigant in the breathing zone (areas within the structure where individuals typically stand, sit or lie down) is determined to be 1 part per million (ppm) or less, as determined by a detection device with sufficient sensitivity such as an INTERSCAN, MIRAN [SapphiRe] or Spectros ExplorIR gas analyzers. For more detailed information on the source and use of air monitoring devices or respirators, consult the Vikane Gas Fumigant Structural Fumigation Manual.

Cylinder and Product Disposal: Promptly return all empty cylinders to your distributor of Vikane. Follow proper cylinder handling directions above.

Pesticide wastes are acutely hazardous. Improper disposal of excess pesticide is a violation of Federal law. If these wastes cannot be disposed of by use according to label instructions, consult your State Pesticide or Environmental Control Agency, or the Hazardous Waste Representative at the nearest EPA Regional Office for guidance.

Information

The Structural Fumigation Manual is part of the labeling for Vikane. Before using, read and follow all label precautions and directions. Prior to the parties entering into a fumigation agreement, the Fact Sheet for Vikane must be provided to an adult occupant of the structure to be fumigated.

Vikane is a highly hazardous material and must be used only by individuals knowledgeable of the hazards of this chemical and trained in the use of required respiratory equipment, fumigant detection devices, emergency procedures, and in the proper use of this fumigant.

When used for fumigation of enclosed spaces, such as houses and other structures, warehouses, vaults, chambers, trucks, vans, boxcars, ships, and other transport vehicles, 2 persons trained in the use of this product, at least one being an applicator who is licensed/certified by the state, must be present during

s/53

introduction of fumigant, reentry prior to aeration, and during the initiation of the initial aeration procedure when exposure exceeds 1 ppm. **Two persons need not be present if monitoring is conducted remotely (outside the area being fumigated) and no one enters the fumigated structure.**

If fumigating for insect pests, do not apply when temperature at site of pest activity is below 40°F. This temperature may be measured at the slab foundation, sub-floor soil, or wherever the coolest part of the structure may be. This restriction does not apply when fumigating for rodents.

When fumigating a single unit/room within or connected to a larger structure (such as town houses, apartments, condominiums), all units of the entire structure must be vacated during the fumigation and aeration periods.

Remove food, feed, drugs, and medicinals from the structure before the fumigation if they cannot be adequately sealed to prevent exposure to Vikane. Chloropicrin must be used as described on this label to warn of an ongoing fumigation.

Preparation for Fumigation

Structural Fumigation

Remove from the structure to be fumigated all persons, domestic animals, pets, and desirable growing plants. See the Structural Fumigation Manual for instructions regarding the handling of fish tanks. For mattresses (excluding waterbeds) and pillows completely enveloped in waterproof coverings, do one of the following: 1) open the seal of the water proof covering or 2) remove the mattress or pillow from the space to be fumigated if the waterproof covering cannot be opened. Mattresses and pillows with waterproof coverings containing built-in vents designed to permit air passage are considered to have an open seal to the waterproof covering and can remain as-is in the fumigated space. Food, feed, drugs (including tobacco products), and medicinals (including those items in refrigerators and freezers) can remain in the structure if they are in plastic, glass, or metal bottles, cans, or jars with the original manufacturer's air-tight seal intact. Food, feed, drugs (including tobacco products), and medicinals (including those items in refrigerators and freezers) not in plastic, glass, or metal bottles, cans, or jars with the original manufacturer's air-tight seal intact, need to be removed from the fumigation site, or double bagged in Nylofume* bags, which are available from distributors of Vikane.

Note: Extinguish all flames, including pilot lights of water heaters, gas refrigerators, ranges, ovens, broilers, dryers, gas fireplaces, etc. Turn off or unplug all electrical heating elements such as those in heaters, pianos, organs, etc. Shut off automatic switch controls for appliances and lighting systems which will be included in the space to be fumigated.

Open operable internal doors, internal openings to attics and sub areas, storage chests, cabinets, drawers, closets, and appliances (such as washers, dishwashers, dryers, microwave or conventional ovens, etc.). Using electric fan(s) will help provide for forced distribution and aeration of basements and other dead air spaces to facilitate rapid dispersion of gas. Refrigerator and freezer doors may be left open if the units are turned off or disconnected and all food items have been removed. If the applicator chooses to leave sealed food items in closed refrigerators and freezers during the fumigation, the appliances must be opened when clearing the structure until the concentration of Vikane in them is 1 ppm or less.

Multi-Unit Structures: When fumigating a single unit/room within a larger structure (such as townhouses, apartments, condominiums), all units of the entire structure must be prepared as a fumigated structure, and all applicable rules, regulations and label instructions apply, such as occupant notification, structure preparation, posting, securing, and aeration. An adult occupant of each currently-occupied unit must be provided with the Fact Sheet for Vikane. Ensure that all exterior entranceways and exterior doors providing access to individual units are secured with secondary locks (see Securing Structure Entrances) so that only the state licensed applicator in charge can gain access. Chloropicrin need only be used in the fumigated space where Vikane is introduced. During Step (3) of Aeration Procedure 1 or 2, check all units within the fumigated structure for concentrations of Vikane with an

approved clearance device. If the concentration of Vikane is greater than 1 ppm in the breathing zone (i.e., areas within the structure where individuals typically stand, sit or lie down) in a unit, ventilate the unit with operable doors and windows open and continue to measure the concentration of Vikane until it is 1 ppm or less. Structure may be reoccupied when concentrations in the breathing zones in all units is 1 ppm or less.

Connected Structures: A connected structure is defined as any structure connected with the structure to be fumigated by construction elements (e.g., pipes, conduits, ducts, etc.) which may allow passage of fumigant between the structures. If state rules and regulations do not describe or permit a process to isolate and seal a connected structure to prevent passage of fumigant from the fumigated structure, then the connected structure must be vacated during the fumigation. When it is necessary to vacate any connected structure, that structure shall be considered as a fumigated structure and all applicable rules, regulations and label instructions apply, such as occupant notification, structure preparation, posting, securing, and aeration. Chloropicrin need only be used in structures where Vikane is introduced. Concentration levels of Vikane must be measured in the breathing zones (areas within the structure where individuals typically stand, sit or lie down) (see Aeration and Reentry) in any connected space or structure to confirm concentrations are 1 ppm or less before structure can be reoccupied.

Tarpaulin Fumigation

Open operable windows as permitted by local and state regulations. When tarping, use a highly resistant material such as a vinyl coated nylon, or polyethylene sheeting of at least 4 mil thickness. Seal all seams. Seal the bottom edges of the cover to the ground using materials such as soil, sand, or weighted "snakes." To minimize escape of gas through the soil and to avoid injury to nearby plants, wet soil outward from foundation to the cover if not sufficiently moist to act as a barrier for the gas.

Taped Fumigation

For fumigation sites that can be sealed with plastic, paper, or tape, seal adequately around doors, windows, vents, and other openings.

Chamber Fumigation

For chamber fumigation use a tightly-sealed chamber with adequate circulation.

Construction Materials, Furnishings (Household Effects), Vehicles, and Shipping Containers

Follow preparations as appropriate in above paragraphs for chamber, taped fumigation, or tarpaulin fumigation to assure good confinement of the gas for the recommended period of exposure.

Fumigation of Surface Ships in Port

Surface ships in size up to and including large ocean-going ships may be fumigated with Vikane to control the various pests listed. The professional fumigator and the ship's captain (or owner) shall follow all applicable regulations including those listed in the Coast Guard, DOT, Title 46, Shipping section, Parts 147A.1-147A.43. Except for those persons involved in fumigation, no people, plants, or pets may be on board during fumigation.

The person responsible for the fumigation must notify the master of the vessel, or his representative, of the requirements relating to personal protection equipment and detection equipment. Emergency procedures, cargo ventilation, periodic monitoring and inspections, and first aid measures must be discussed with and understood by the master of the vessel or his representative.

If leakage of the fumigant is detected, the person in charge of the fumigation shall take action to correct the leakage, or shall inform the master of the vessel, or his representative, of the leakage so that corrective action can be taken.

Food, feed, drugs, and medicinals shall not be exposed to the fumigant. If not removed from the vessel they shall be protected from exposure. The vessel must not be moved during the fumigation and aeration periods. If reentry is necessary before aeration is completed, positive pressure self-contained respiratory protection must be worn.

Warning Agent

Chloropicrin is a warning agent introduced into the structure during fumigation. In order to avoid direct exposure to the fumigant being released, chloropicrin must be released within the structure at least 5 to 10 minutes prior to introduction of the fumigant. Place a handful of wicking agent (e.g., cotton) in a chloropicrin evaporation container(s). Do not use chloropicrin evaporation containers or application equipment made of magnesium, aluminum, or their alloys as chloropicrin may be severely corrosive to such metals. To enhance the distribution of chloropicrin throughout the structure, place the chloropicrin evaporation container in the air stream of a fan. Pour chloropicrin over the wicking agent. When adding chloropicrin to evaporation containers, dispense no more than 3 fl oz per container. Use 1 fl oz/10,000 to 15,000 cubic feet (30 ml/283 to 425 cubic meters) of space to be fumigated or follow dosage rate calculated by the electronic Fumiguide™ system. Establish at least one chloropicrin introduction site for each 45,000 cubic feet of space to be fumigated. When applying chloropicrin at multiple chloropicrin introduction points within a structure, start at the point farthest from the exit and work toward the exit. Removal of all chloropicrin evaporation containers from the fumigated space during the initial phase of aeration after tarp removal will aid in the dissipation of the warning agent from the structure.

Chloropicrin need not be used when fumigating passenger railcars; however, a thorough walk-through inspection must be performed of each railcar with doors being immediately locked upon leaving each car, and a guard must be posted during fumigant introduction, exposure period, and aeration.

Chloropicrin is a warning agent which causes smarting of the eyes, tears, and discomfort, and has a very disagreeable pungent odor at very low concentrations. Chloropicrin must be used by persons certified to apply Vikane or under their supervision. Applicators must observe the chloropicrin precautionary statements and personal protective equipment appearing on this label. See the Warning Agent section of the Structural Fumigation Manual.

Protective Clothing

Wear splash-resistant goggles (goggles designed and made of material that allows no measurable movement of the liquid pesticide being used to pass through them during use) or full face shield for eye protection during introduction of the fumigant. Do not wear gloves or rubber boots. Do not reuse clothing or shoes that have become contaminated with liquid Vikane until thoroughly aerated and cleaned.

Respiratory Protection

If the concentration of Vikane in the breathing zone (areas within the structure where individuals typically stand, sit or lie down) of the fumigated area (as measured by a detector device with sufficient sensitivity such as an INTERSCAN, MIRAN [SapphIRe] or Spectros ExplorIR gas analyzers) does not exceed 1 ppm (4 mg/cubic meter), no respiratory protection is required. When this concentration is exceeded, all persons in the exposed area must wear a NIOSH or MSHA approved positive pressure self-contained breathing apparatus (SCBA, not SCUBA) or combination air-supplied/SCBA respirator such as manufactured by Ranger, Survivair, Scott, or MSA. Before using any make or brand of SCBA, learn how to use it correctly. Determine that it has an adequate air supply for the job at hand, that it fits properly, providing an adequate seal around the face, and that it is in good working order. For more detailed information on the source and use of air monitoring devices and respirators, consult the Vikane Gas Fumigant Structural Fumigation Manual.

Prefumigation Check: Check for potential leaks.

Securing Structure Entrances

To secure the structure against unauthorized entry during the fumigation exposure period and Step 2 of Aeration Procedure 1 or 2, use a locking device or barricade on all exterior doors or doorways. A locking device, such as a secondary lock, or barricade must be demonstratively effective in preventing an exterior door or doorway from being opened from the exterior using normal opening or entering processes by anyone other than the certified applicator in charge of the fumigation or persons in his/her on-site direct supervision. Consult state and local regulations for any supplementary instructions and restrictions on securing against entry.

Securing Passenger Railcars

Follow either Procedure #1 or Procedure #2 for securing railcars.

Procedure #1: A thorough walk through inspection must be performed of each railcar with doors being immediately locked upon leaving each car. Post a guard during fumigation introduction, exposure period, and aeration. Because a guard is posted, application of a warning agent is not required for passenger railcars.

Procedure #2: A thorough walk through inspection must be performed of each railcar with doors being immediately locked upon leaving each car. If no guard is posted, then apply a warning agent following instructions per label directions. To secure the passenger railcar against unauthorized entry during the fumigation exposure period, use a locking device or barricade on all exterior doors or doorways. A locking device or barricade must be demonstratively effective in preventing an exterior door or doorway from being opened using normal opening or entering processes by anyone other than the state licensed applicator in charge of the fumigation or persons in his/her on-site direct supervision. Consult state and local regulations for any supplementary instructions and local restrictions on securing against entry.

Dosage and Exposure Time

For fumigation to control drywood termites and non-egg stages of other insect and related structural and household pests, the Fumiguide calculator(s) is to be used for the coordination of fumigant rates with soil or slab temperature, exposure period, and fumigant loss rate measured as half-loss-time (HLT). When control of the egg stage is desired or when fumigating for Formosan termites, use the indicated multiple factor of the drywood termite dosage (as determined by Fumiguide calculator(s)) for pests listed in the following table:

Pest	Dosage Factor (as a multiple of drywood termite dosage)
rodents ¹	1/2X
carpet beetles ² and cockroaches ²	1X
Bedbugs	1.9X
furniture carpet beetles ²	3X
old house borers and Formosan termites	4X
clothes moths	6X
powder post beetles and death watch beetles	10X

These dosages apply to dwellings, buildings, construction materials, furnishings, and vehicles.

¹To determine the proper dose for rodent control, use 80°F as the calculating temperature. Unlike insects, rodents are warm blooded and do not require increased dosages at lower temperatures.

²More than one fumigation may be needed to control the infestation after egg hatch.

For fumigation to control rodents, use sufficient gas to accumulate at least 36 ounce-hours following equilibrium, regardless of ambient air temperature. Refer to the Vikane Gas Fumigant Structural Fumigation Manual.

The Fumiguide B Calculator is to be used for unmonitored structures to coordinate fumigant rates with temperatures, a 20- to 24-hour exposure period, and an estimated HLT.

The Fumiguide Y Calculator is used in conjunction with Fumiguide B when fumigant concentrations are monitored and/or there are measured variations in exposure time.

The Fumiguide Calculator is a hand-held microprocessor which performs the functions of both the Fumiguide B and Y calculators and includes relative humidity as a calculating factor.

These calculators, Directions for Use, and referenced literature may be obtained from Dow AgroSciences.

Introducing the Fumigant

Release the fumigant from outside the structure, tarp, or vehicle. The release point(s) should be into a large open space(s) in the fumigation site(s). Release the fumigant through a suitable leak-proof tube with a minimum burst pressure of 500 pounds per square inch (psi). Direct the fumigant into the blast of air from a fan(s) having a capacity of at least 1,000 cubic feet per minute (cfm) for each pound of Vikane released per minute. Damage to household materials can occur if insufficient fan capacity is used for the rate of Vikane released. It is recommended that protective sheeting, such as polyethylene plastic under the shooting stand, shooting hose, and shooting fan be used to further protect floors during application.

To prevent damage, do not apply fumigant directly to any surface.

Posting of Fumigated Areas

The applicator must post all entrances to the fumigated areas with signs bearing, in English and Spanish:

1. The signal word DANGER/PELIGRO and the SKULL and CROSSBONES symbol.
2. The statement, "Area under fumigation, DO NOT ENTER/NO ENTRE."
3. The date of fumigation.
4. Name of fumigant used.
5. Name, address, and telephone number of the applicator.

Only a certified applicator may authorize removal of placards, and only when the concentration of Vikane within the structure where individuals typically stand, sit or lie down, is 1 ppm or less.

Aeration and Reentry

Structures

No one is allowed in treated areas if the level of Vikane is above 1 ppm unless provided with a NIOSH or MSHA approved positive pressure self-contained breathing apparatus (SCBA, not SCUBA) or combination air supplied/SCBA respirator such as manufactured by Ranger, Survivair, Scott, or MSA.

Note: During the initial one hour aeration procedure, approved respiratory protection must be worn until the concentration of Vikane is confirmed not to exceed 1 ppm with an approved detection device. Since the INTERSCAN, MIRAN [SapphIRe] and Spectros ExplorIR gas analyzers give immediate readings, respiratory protection is not required when clearing with these instruments after having completed the initial one hour aeration procedure. If a reading indicates levels in excess of 1 ppm, leave the affected area immediately.

Only an approved detection device of sufficient sensitivity, such as the INTERSCAN, MIRAN [SapphIRe] or Spectros ExplorIR gas analyzer, can be used to confirm a concentration of Vikane of 1 ppm or less. The INTERSCAN must be calibrated according to manufacturer recommendations within one month prior to use as a clearance device. All other approved detection devices must be calibrated according to manufacturer recommendations. The concentration of Vikane must be monitored in breathing zones (areas within the structure where individuals typically stand, sit or lie down). Structure must remain posted for fumigation until cleared for reentry.

Open all operable attic doors and accesses and direct a fan into the attic. If the structure has an attached garage, the door between the garage and structure should be open. If the structure has a central air handling system, the fan (or blower) should be activated for each unit if operational. As an alternative, a fan may be placed in front of a furnace inlet to blow air into central heating and cooling ducts.

Select the appropriate procedure based on the fumigation rate:

All structures fumigated at 16 oz/MCF or less may be aerated using procedures 1 or 2.

10/53

All structures fumigated at concentrations greater than 16 oz/MCF must be aerated using procedure 2.

Aeration Procedure 1

These steps must be completed in sequence.

Step (1): Aerate structure with all operable windows and doors open, aided by the use of one or more fans, for a minimum of 1 hour. Total fan capacity, using one or more fans, shall be capable of displacing a total of 5,000 cfm.

Step (2): Secure structure and do not allow reentry for a minimum of 6 hours from the start of aeration (first opening of the seal). During this time structures must remain posted.

Step (3): After the minimum 6-hour waiting period, measure the concentration of Vikane in breathing zones of each room. If the concentration of Vikane is greater than 1 ppm, ventilate structure with operable doors and windows open and confirm concentrations are 1 ppm or less before the structure is reoccupied.

Aeration Procedure 2

These steps must be completed in sequence.

Step (1): Aerate structure with all operable windows and doors open, aided by the use of one or more fans, for a minimum of 1 hour. Total fan capacity, using one or more fans, shall be capable of displacing a total of 5,000 cfm.

Step (2): Secure the structure and do not allow reentry for a minimum of 8 hours from the start of aeration (first opening of the seal). During this time the structure must remain posted.

Step (3): After the minimum 8-hour waiting period, measure the concentrations of Vikane in breathing zones of each room. If the concentration of Vikane is greater than 1 ppm, ventilate structure with operable doors and windows open and confirm concentrations are 1 ppm or less before the structure is reoccupied.

Passenger Railcars

Passenger railcars may be aerated using either of the following two aeration procedures (railcars must remain posted until cleared for re-occupancy):

Aeration Procedure 1:

If on-board railcar ventilation systems are not operable, aerate railcar for a minimum of 6 hours using the following procedure:

Step (1): Remove all tape, seals, and/or tarps.

Step (2): Open all exterior railcar doors.

Step (3): Open all internal doors such as cabinets, closets, appliances and sleeping berths.

Step (4): In sleeper cars, turn all mattresses askew to expose cavities beneath sleeping berths.

Step (5): Ventilate the railcars for a minimum of 1 hour with enough portable fans to provide a minimum 4000 cfm capacity per floor. A bilevel railcar would require 8000 cfm capacity or greater - 4000 cfm per floor. Direct fans in such a manner to create cross-ventilation of railcar.

Step (6): After the minimum 6-hour aeration time, railcars may be reoccupied when the concentration of Vikane is 1 ppm or less with all doors and windows closed and ventilation systems turned off as measured by a detection device with sufficient sensitivity such as an INTERSCAN, MIRAN [SapphIRe], or Spectros ExplorIR gas analyzers.

Aeration Procedure 2:

If on-board railcar ventilation systems are operable, actively ventilate the railcar for a minimum of 2 hours using the following procedures:

11/53

Step (1): Remove all tape, seals, and/or tarps.

Step (2): Open all exterior car doors.

Step (3): Open all internal doors such as cabinets, closets, appliances and sleeping berths.

Step (4): In sleeper cars, turn all mattresses askew to expose cavities beneath sleeping berths.

Step (5): Turn on all on-board Heating, Ventilation, Air-Conditioning (HVAC) systems and exhaust fans.

Step (6): In sleeper cars, turn on all operable wall or ceiling mounted fans.

Step (7): Ventilate the railcar with enough portable fans to provide a minimum 4000 cfm capacity per floor (in addition to on-board systems). A bilevel railcar would require 8000 cfm capacity or greater - 4000 cfm per floor. Direct fans in such a manner to create cross-ventilation of railcar.

Step (8): After the minimum 2 hours active ventilation/aeration, the railcar may be reoccupied when the concentration of Vikane is 1 ppm or less with all doors and windows closed and ventilation systems turned off as measured by a detection device with sufficient sensitivity such as an INTERSCAN, MIRAN [SaphIRe], or Spectros ExplorIR gas analyzers.

For more detailed information on the source and use of air monitoring devices or respirators, consult the Vikane Gas Fumigant Structural Fumigation Manual. Do not reoccupy fumigation site, i.e., building, ship, vehicle or chamber, or move vehicle until aeration is complete. Warning signs must remain posted until aeration is determined to be complete.

Terms and Conditions of Use

If terms of the following Warranty Disclaimer, Inherent Risks of Use, and Limitation of Remedies are not acceptable, return unopened package at once to the seller for a full refund of purchase price paid. Otherwise, use by the buyer or any other user constitutes acceptance of the terms under Warranty Disclaimer, Inherent Risks of Use and Limitation of Remedies.

Warranty Disclaimer

Dow AgroSciences warrants that this product conforms to the chemical description on the label and is reasonably fit for the purposes stated on the label when used in strict accordance with the directions, subject to the inherent risks set forth below. TO THE EXTENT PERMITTED BY LAW, Dow AgroSciences MAKES NO OTHER EXPRESS OR IMPLIED WARRANTY OF MERCHANTABILITY OR FITNESS FOR A PARTICULAR PURPOSE OR ANY OTHER EXPRESS OR IMPLIED WARRANTY.

Inherent Risks of Use

It is impossible to eliminate all risks associated with use of this product. Plant injury, lack of performance, or other unintended consequences may result because of such factors as use of the product contrary to label instructions (including conditions noted on the label, such as unfavorable temperature, soil conditions, etc.), abnormal conditions (such as excessive rainfall, drought, tornadoes, hurricanes), presence of other materials, the manner of application, or other factors, all of which are beyond the control of Dow AgroSciences or the seller. All such risks shall be assumed by buyer.

Limitation of Remedies

To the extent permitted by law, the exclusive remedy for losses or damages resulting from this product (including claims based on contract, negligence, strict liability, or other legal theories), shall be limited to, at Dow AgroSciences' election, one of the following:

1. Refund of purchase price paid by buyer or user for product bought, or
2. Replacement of amount of product used.

Dow AgroSciences shall not be liable for losses or damages resulting from handling or use of this product unless Dow AgroSciences is promptly notified of such loss or damage in writing. In no case shall Dow AgroSciences be liable for consequential or incidental damages or losses.

The terms of the Warranty Disclaimer, Inherent Risks of Use, and Limitation of Remedies cannot be varied by any written or verbal statements or agreements. No employee or sales agent of Dow AgroSciences or the seller is authorized to vary or exceed the terms of the Warranty Disclaimer or Limitation of Remedies in any manner.

®Trademark of Dow AgroSciences LLC
EPA accepted 06/09/10

RESTRICTED USE PESTICIDE DUE TO INHALATION TOXICITY
For sale to and use only by Certified Applicators or persons under their direct supervision and only for those uses covered by the Certified Applicator's certification.

Structural Fumigation Manual for

Vikane®

Specialty Gas Fumigant

For control of: Existing infestations of listed insects and related pests such as drywood termites, Formosan termites, powder post beetles, death watch beetles, old house borers, bedbugs, cockroaches, clothes moths, rodents (rats, mice), and the larvae and adults of carpet beetles (except egg stage), oriental, American, and brown-banded cockroaches.

For use in: Dwellings (including mobile homes), buildings, construction materials, furnishings (household effects), shipping containers and vehicles including automobiles, buses, surface ships, passenger railcars, and recreational vehicles (but not including aircraft).

When fumigating, observe local, state, and federal rules and regulations including such things as use of chloropicrin, clearing devices, positive-pressure self-contained breathing apparatus, security requirements, and placement of warning signs.

Application personnel must participate in Dow AgroSciences' Sulfuryl Fluoride Training and Stewardship Plan.

Active Ingredient	
sulfuryl fluoride.....	99.8%
Other Ingredients	0.2%
Total	100.0%

Keep Out of Reach of Children

DANGER  **POISON**

[Editors note: the word POISON must appear in red]

PELIGRO

Si usted no lee inglés, no use este producto hasta que la etiqueta le haya sido explicada ampliamente.

First Aid

In all cases of overexposure, such as nausea, difficulty in breathing, abdominal pain, slowing of movements and speech, numbness in extremities, get medical attention immediately. Take person to a doctor or emergency treatment facility.

If inhaled: Get exposed person to fresh air. Keep warm and at rest. Make sure person can breathe freely. If breathing has stopped, give artificial respiration. Do not put anything in the mouth of an unconscious person. Call a poison control center or doctor for further treatment advice.

If liquid is on skin or on clothing: Immediately apply water to contaminated area of clothing before removing. Once area has thawed, remove contaminated clothing, shoes, and other items covering skin. Wash contaminated skin area thoroughly or shower. Call a poison control center or doctor for further treatment advice.

If liquid is in eyes: Hold eye open and rinse slowly and gently with water for 15-20 minutes. Remove contact lenses, if present, after the first 5 minutes, then continue rinsing eye. Call a poison control center or doctor for treatment advice.

Note to Physician: Vikane is a gas which has no warning properties such as odor or eye irritation. (However, chloropicrin is used as a warning agent and is a known lachrymator). Early symptoms of exposure to Vikane are respiratory irritation and central nervous system depression. Excitation may follow. Slowed movement, reduced awareness, and slow or garbled speech may be noted. Prolonged exposure can produce lung irritation, pulmonary edema, nausea, and abdominal pain. Repeated exposure to high concentrations can result in significant lung and kidney damage. Single exposures at high concentrations have resulted in death. Treat symptomatically.

Liquid Vikane in the eye may cause damage due to refrigeration or freezing.

In case of emergency endangering health or the environment involving this product, call 1-800-992-5994.

Agricultural Chemical: Do not ship or store with food, feeds, drugs or clothing.

EPA Reg. No. 62719-4

®Trademark of Dow AgroSciences LLC

**Produced for
Dow AgroSciences LLC
9330 Zionsville Road
Indianapolis, IN 46268**

TABLE OF CONTENTS

Page

FUMIGATING WITH VIKANE 6

- Introduction 6
- Product Stewardship for Vikane 6

CHAPTER 1 PRODUCT INFORMATION 7

- The Label..... 7
- Composition 7
- Physical Properties 7

CHAPTER 2 ADDITIONAL SAFETY INFORMATION 9

- Poisoning Symptoms..... 9
- Physician Information 9
- Fire Fighting 9
 - Fire Fighting Information 9
 - Fire Fighting Protective Clothing 10
- Worker Safety 10
 - Personal Protection Equipment 10

CHAPTER 3 CYLINDER HANDLING AND STORAGE 12

- Cylinder Safety 12
 - Cylinder Information..... 12
 - Cylinder Valve System for Vikane..... 12
 - Cylinder Storage..... 12
 - Cylinder Transport..... 13
 - Empty Cylinders 13
 - Cylinder Leak Procedures 13

CHAPTER 4 FUMIGATION PREPARATION 15

- Occupants/Customer Communications..... 15
 - Fact Sheet 15
 - Property Owner/Customer Checklist..... 15
- Multi-Unit Structures 15
- Connected Structures..... 15
- What to Remove Prior to Fumigation..... 16
- Flames Or Heating Elements..... 16
- Gas Distribution..... 17
- Fan Placement and Specifications..... 17
 - Purpose of Fans 17
 - Positioning Fans 17
 - Fan Specifications..... 18
 - Reaching Equilibrium 18
 - Continuous Circulation with Fans 18
 - Preparing for Aeration..... 18
- Electricity 18
- Monitoring Hoses..... 19
- Sealing The Structure..... 19
 - Tape and Seal..... 19
 - Tarping 19
 - Conduits 20
- Placarding and Securing Fumigated Areas..... 20
 - Posting of Fumigated Areas..... 20
 - Warning Agent..... 20
 - Securing Structures 21
 - Guards 22

CHAPTER 5 FUMIGUIDE CALCULATIONS..... 23

- Fumigant Dosage 23
- Factors Affecting Oz-Hr Dosage 23
 - Pest Factor 23

Temperature..... 25

The Fumiguide System..... 25

 Calculating HLT..... 25

 Calculating the Oz-Hr Dosage..... 26

 Calculating the Amount of Vikane to Introduce..... 26

 Using the Vikane Fumiguide When Monitoring..... 27

 Documenting Fumiguide Calculations..... 27

CHAPTER 6 RELEASE OF WARNING AGENT..... 28

 Physical Properties of Chloropicrin Compared to Vikane..... 28

 Safety Precautions When Using Chloropicrin..... 28

 Personal Protective Equipment..... 28

 First Aid..... 29

 Storage and Handling..... 29

 Introduction of Chloropicrin..... 29

 Additional Precautions for Use and Handling of Chloropicrin..... 30

CHAPTER 7 VIKANE INTRODUCTION..... 31

 Preventing Property Damage..... 31

 Choosing Fumigant Introduction Locations..... 31

 Selection and Use of Equipment for Fumigant Introduction..... 31

 Weighing the Fumigant..... 31

 Hoses..... 31

 Fan Placement and Specifications..... 32

 Protective Sheeting..... 32

 Chloropicrin Introduction..... 32

 Safety Equipment..... 33

 Releasing Vikane From the Cylinder..... 33

 Frozen Valves and Hoses..... 33

 Frozen Cylinders..... 33

 Releasing the Last 3 to 5 lb of Vikane..... 33

CHAPTER 8 MONITORING VIKANE..... 34

 Guidelines for Monitoring a Fumigation..... 34

 Equipment..... 34

 Fumiguide Calculator..... 34

 Monitoring Hoses..... 34

 Monitoring Equipment..... 34

CHAPTER 9 AERATING AND CLEARANCE TESTING..... 35

 Preparing for Aeration..... 35

 Aeration Procedures..... 35

 Aeration Procedure 1..... 36

 Aeration Procedure 2..... 36

 Clearance Testing Equipment..... 36

 Reoccupancy..... 37

 Aerating Chloropicrin..... 37

 Aerating Passenger Railcars..... 37

 Aeration Procedure 1..... 37

 Aeration Procedure 2..... 38

 Latent Mortality..... 38

 Non-Target Organisms..... 38

CHAPTER 10 SITE SPECIFIC CONSIDERATIONS (SUCH AS CHAMBERS, VEHICLES, SHIPS, PASSENGER RAILCARS)..... 39

 Chambers..... 39

 Atmospheric Pressure Chambers..... 39

 Vacuum Chambers..... 39

 Tarped Stacks..... 40

 Vehicles, Vessels, and Containers..... 40

 Selection of Fumigation Location..... 41

 Securing the Vehicle, Vessel, or Container..... 41

 Surface Ships..... 41

FUMIGATING WITH VIKANE.

INTRODUCTION

Vikane® specialty gas fumigant was specifically developed by The Dow Chemical Company in the 1950s for remedial control of wood-destroying insects and other structure-infesting pests. Vikane is registered for use exclusively by professional applicators to control existing infestations of insects, related pests, and rodents infesting dwellings (including mobile homes), buildings, construction materials, furnishings (household items), shipping containers and vehicles including automobiles, buses, surface ships, passenger railcars, and recreational vehicles (excluding aircraft).

While every structural fumigation is unique, there are basic principles and requirements to follow that are common to all structural fumigations. The purpose and objective of this Structural Fumigation Manual ("Manual") are to supplement and support the cylinder label for Vikane and to reinforce the responsible and effective use of Vikane.

Read and be familiar with the Manual before using Vikane. The Manual is part of the labeling for Vikane. The Manual contains important information for applicator safety and for the effective use of this product. If the Manual is lost, contact your distributor of Vikane or Dow AgroSciences to obtain a replacement copy.

This Manual is not intended to supersede label requirements or state and local regulations. Each applicator using Vikane is responsible for complying with all federal, state, and local regulations or codes regulating the use of this product. The development of this Manual included the study and interpretation of many codes and regulations considered relevant to the use of Vikane. However, because regulations and the enforcement of regulations can change, the applicator should stay informed about state and local regulations in areas where they operate. This Manual may be periodically revised as necessary to reflect modification of requirements.

State and local government offices, distributors of Vikane, or Dow AgroSciences' sales representatives responsible for your area can help identify the relevant agencies responsible for regulating fumigation practices in your area.

In emergency situations, help may be obtained by calling Dow AgroSciences at **1-800-992-5994**.

PRODUCT STEWARDSHIP FOR VIKANE

Product Stewardship means the responsible and ethical management of the health, safety and environmental risks of a pesticide product. Dow AgroSciences has a Product Stewardship Policy for applicators and distributors of Vikane. The objective of this policy is to promote product stewardship and educate distributors and applicators on the responsible use of Vikane in accordance with all directions, as well as Dow AgroSciences' requirements.

PRODUCT INFORMATION1

Vikane is a restricted use pesticide due to acute inhalation toxicity of sulfuryl fluoride.

THE LABEL

This product is registered by the Environmental Protection Agency, Registration Number 62719-4. The label for Vikane consists of the container label for Vikane and this document . It is illegal to use the product in any manner inconsistent with the label. Labels are periodically revised and available through Dow AgroSciences or your authorized distributor of Vikane.

COMPOSITION

Vikane is an inorganic chemical and is composed of:

Active Ingredient	
sulfuryl fluoride (by weight)	99.8%
Other Ingredients	0.2%
Total	100.0%

PHYSICAL PROPERTIES

Sulfuryl fluoride is a colorless, odorless toxic gas. Cylinders containing Vikane are under pressure and must not be stored near excessive heat or open flame. Exposures to temperatures above 158°F will cause a fusible plug to melt and the contents will be released.

Structural formula: SO₂F₂

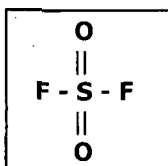

Color: None

Odor: None

Molecular Weight: 102.07 AMU

Specific Gravity: 1.35 at 20°C (68°F)

Vapor Density: 4.3 g/L at 20°C (68°F); air = 1

Vapor Pressure: 15.2 atm at 20°C (68°F)

Boiling Point: -55.2°C (-67°F) at 760 mmHg

Gas Solubility at Pressure = 1 atm: 25°C (77°F) and in water 0.075% (750 ppm) by weight, only slightly soluble in organic solvents and vegetable oils.

Stability: Stable to heat normally encountered in structural and other fumigations. Non-flammable under normal conditions in all atmospheric concentrations. However, heaters and open flames must be extinguished as temperatures over 400°C (752°F) will cause decomposition products to be formed which can be corrosive and etch metal and glass.

Heat of Vaporization: 81.1 BTU/pound at -55°C (-67°F) or 4600 cal/mol. 1 lb of sulfuryl fluoride = 4.45 moles. 1 lb of Vikane will lower 1000 cu ft of dry air by 2.5°C (4.5°F).

Volume per Pound: 1 lb of gas occupies 3.8 cu ft at 25°C (77°F) and 760 mm Hg. 1 lb of gas per 1000 cu ft of unoccupied space equals approximately 3850 ppm at room temperature and pressure (25°C at 760 mm Hg).

Hydrolysis: Hydrolysis slow in water, but rapid in basic solutions.

Reactivity: Sulfuryl fluoride is relatively non-reactive as a gas. No malodor or corrosive effects have been detected when the chemical has been used as directed. Sulfuryl fluoride can react with strong bases such as some photo developing solutions.

Effect on Ozone: Sulfuryl fluoride is not a stratospheric ozone-depleting substance. Vikane contains no chlorine or bromine and, thus, does not deplete stratospheric ozone by known mechanisms. When a structure is aerated, Vikane rapidly dissipates to non-detectable levels.

ADDITIONAL SAFETY INFORMATION 2

Vikane is toxic to most living organisms including humans. It is colorless, odorless, packaged as a liquid gas under pressure, and has no warning properties. **Vikane must only be used by certified professional applicators.**

Symptoms in humans from inhalation exposure to Vikane will depend upon the concentration and the length of exposure experienced. Vikane is toxic and must be handled carefully because of the potential hazards it presents. Disregarding the lethal potential of Vikane can result in serious illness, even death.

POISONING SYMPTOMS

Vikane is colorless, odorless and, at low concentrations, non-irritating to mucous membranes. Vikane has no warning properties at working concentrations.

The earliest sign of overexposure to Vikane is central nervous system (CNS) depression. Although dose-response data are not available for effects in humans exposed to Vikane, acute inhalation studies have been conducted on laboratory animals. No signs of CNS depression were observed in rats exposed to 450 ppm for 4 hours, while rats exposed to 750 ppm were lethargic following this exposure time.

Exposure to progressively higher concentrations is expected to result in convulsions, tremors and/or strychnine-like muscular rigidity. Rats exposed to 1000 ppm began to show CNS depression 15 minutes after initiation of exposure, and slight eye irritation was evident after 2 hours. By 3 1/2 hours, the animals were moribund and/or convulsive, and some died shortly after termination of the 4-hour exposure. Rats exposed to 1425 ppm were sedated in 20 minutes, prostrate in 40 minutes, convulsive after 1 to 2 hours and dead in 4 hours.

Humans exposed to high concentrations of Vikane may experience respiratory irritation, nausea, abdominal pain, CNS depression, slowing of movements and speech, and numbness in the extremities. Survival after exposure to high concentrations can occur even following convulsions if exposure has been brief.

PHYSICIAN INFORMATION

The prediction of possible effects in human beings is based in part on observations made on laboratory animals. On this basis, depending upon length of overexposure, it is predicted that persons exposed to Vikane will probably show little evidence of intoxication at first unless the concentration was moderate to high (>500 ppm).

Initial effects will probably be depression on the CNS with slow speech and body movement the first signs noted. Convulsions may ensue with respiratory arrest being a terminal event. Assisted respiration may be necessary.

Remove exposed patient to fresh air and put at rest. Keep the exposed individual at bed rest and under observation for at least 24 hours. Clinical observation should be directed at the pulmonary, hepatic and renal systems. A postmortem finding in a fatality attributed to sulfuryl fluoride was pulmonary edema. Death was attributed to cardio-respiratory failure.

There is no known antidote. Clinical observation is essential. Treatment is based upon the clinical judgment of the physician and the individual reaction of the patient.

IN CASE OF EMERGENCY CALL 1-800-992-5994

FIRE FIGHTING

The information below is provided as a reference for fumigators.

Fire Fighting Information

Vikane is not combustible. However, in temperatures exceeding approximately 400°C (752°F), Vikane will degrade to form hydrogen fluoride (HF) and sulfur dioxide (SO₂). Theoretically, a structure containing Vikane would produce 0.4x the concentration of Vikane in HF per 1000 cu ft.

For temperatures greater than 400°C, each mole (102 gm) of sulfuryl fluoride will degrade to form 2 moles (40 gm) of HF. However, the HF actually produced during fires involving Vikane may be insignificant because Vikane rapidly escapes from structures unless confined.

Cylinders containing Vikane are designed not to explode in high temperatures. A fusible plug in the cylinder valve body melts at 70 to 74°C (158 to 165°F).

Use of Water

Evolution of hazardous materials during a fire can be minimized by use of water. Water will scrub out part of the HF and SO₂ formed by decomposition of Vikane in the flame. Water also can be used to cool cylinders of Vikane and prevent discharge of the product caused by melted fusible plugs. Avoid runoff into waterways if possible because HF is toxic to fish.

Fire Fighting Protective Clothing

Structures Under Fumigation

Self-contained breathing apparatus and normal "turn-out" gear must be worn when fighting fires in structures under fumigation with Vikane.

Fires Involving Cylinders of Vikane

A self-contained breathing apparatus (SCBA) and encapsulating protective suit must be worn when fighting fires in atmospheres containing potentially high concentrations of Vikane. Protective suit material should be compatible with exposure to hydrofluoric acid.

WORKER SAFETY

If the concentration of Vikane in the breathing zone of the fumigated area (as measured by a detector device with sufficient sensitivity such as an INTERSCAN, MIRAN [SapphIRe] or Spectros ExplorIR gas analyzers) does not exceed 1 ppm (4 mg/cubic meter), no respiratory protection is required. Breathing zones are defined as areas within the structure where individuals typically stand, sit or lie down. If the concentration of Vikane is greater than 1 ppm, further aeration and re-testing is required. When this concentration is exceeded, or when the concentration is unknown, all persons in the exposed area must wear a NIOSH or MSHA approved positive pressure self-contained breathing apparatus (SCBA, not SCUBA) or combination air-supplied/SCBA respirator such as manufactured by Draeger, Ranger, Survivair, Scott, or MSA.

Two persons trained in the use of Vikane, at least one being an applicator licensed/certified by the state, must be present during introduction of fumigant, reentry prior to aeration, and during the initiation of the initial aeration procedure when exposure exceeds 1 ppm. Two persons need not be present if monitoring is conducted remotely (outside the area being fumigated) and no one enters the fumigated structure.

Personal Protection Equipment

The label for Vikane requires the following personal protective equipment.

Respiratory Protection

Respiratory protection must be worn when the concentration of Vikane in the breathing zone (areas within the structure where individuals typically stand, sit or lie down) exceeds 1 ppm or when the concentration is not known. Prior to introducing fumigant, the applicator should confirm that SCBAs are available and operational. The respiratory protection must be a National Institute of Occupational Safety and Health (NIOSH) or Mine Safety and Health Administration (MSHA) approved, positive-pressure self-contained breathing apparatus SCBA (not SCUBA) or combination air-supplied/SCBA respirator, such as manufactured by Draeger, Survivair, Ranger, Scott, or MSA.

Consult current OSHA standards and manufacturer recommendations for directions concerning SCBA use and maintenance.

Eye Protection

Wear splash-resistant goggles (goggles designed and made of material that allows no measurable movement of the liquid pesticide being used to pass through them during use) or a full face shield for eye protection during introduction of the fumigant.

Protective Clothing

Do not wear gloves or rubber boots. Do not reuse clothing or shoes that have become contaminated with liquid Vikane until thoroughly aerated.

IN CASE OF EMERGENCY CALL 1-800-992-5994

In all cases of overexposure, such as nausea, difficulty in breathing, abdominal pain, slowing of movements and speech, numbness in extremities, get medical attention immediately. Take person to a doctor or emergency treatment facility.

CYLINDER HANDLING AND STORAGE3

CYLINDER SAFETY

Cylinder Information

Vikane is sold as a compressed liquid gas in a high-pressure cylinder and must be handled, stored and transported with caution. Rough handling or mechanical shock to cylinders such as dropping, bumping, dragging, or sliding should be avoided when possible. Every cylinder should be inspected upon delivery for damage. If the cylinder is damaged, return the cylinder to the distributor for Vikane.

No additional gas is used to pressurize the cylinder. Each full cylinder contains 57 kg (125 lb) of product normally under about 1380 to 2070 kPa (200 to 300 psi) at typical temperatures (60 to 90°F). Inside the cylinder, a dip tube is connected to the cylinder valve and extends to the bottom of the cylinder.

Cylinder Valve System for Vikane

Cylinders of Vikane are fitted with a special valve system (see Figure 3a). The cylinder is equipped with both a safety cap and a covering called a "bonnet" which protects the valve system from being damaged and prevents accidental release of the fumigant. Do not remove valve protection bonnet and safety cap until immediately before use. Replace safety cap and valve protection bonnet when cylinder is not in use. Close valves when fumigant introduction is finished or the cylinder is empty.

Avoid hanging or lifting cylinders by the valves. Use a proper sling to lift cylinders. Use a "hanging" bonnet or other device specifically designed for this purpose when weighing a cylinder on a hanging scale. Hanging bonnets are available through distributors of Vikane.

Figure 3a, Vikane Cylinder Valve

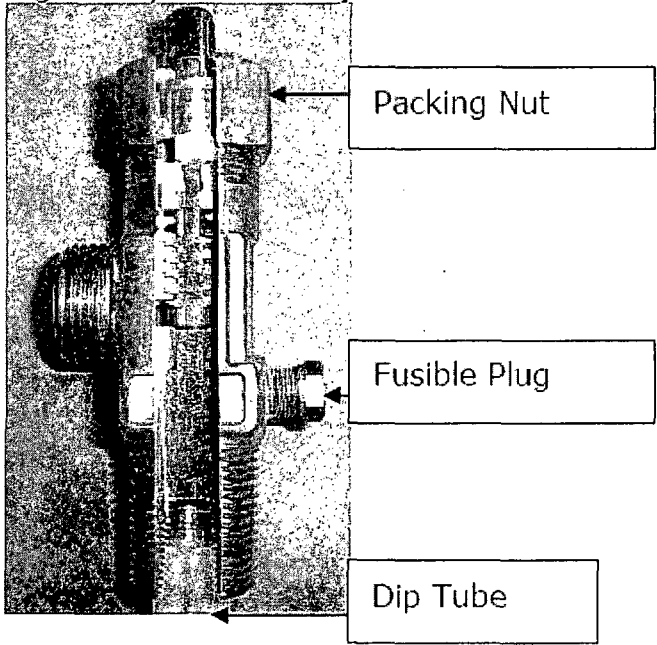

Cylinder Storage

Store cylinders of Vikane in a dry, cool, well-ventilated area under lock and key. Post as a pesticide storage area. If the storage area is in an occupied building, the storage area must have either 1) a forced air ventilation system that meets required local ordinances for the storage of hazardous materials and operates continuously; or 2) be equipped with a permanently mounted and properly maintained and functioning sulfuryl fluoride monitoring device designed to alert occupants of the building if sulfuryl fluoride in the air of the storage area is greater than 1 ppm. Store cylinders upright, secured to a rack, wall or similar stable fixture to prevent tipping.

Keep the safety cap and protective bonnet on cylinders except when introducing the fumigant.

Various state and local authorities may regulate the storage of Vikane. Be certain to check with the appropriate authorities in your area.

Do not contaminate water, food, or feed by storage.

Cylinder Transport

Transport cylinders capped and secured in an upright position. Do not transport cylinders that are unsecured or laying on their side. These are requirements of the Department of Transportation (DOT) when transporting compressed air cylinders. Loose cylinders can become airborne and cause significant damage in an accident.

Because of the toxicity of Vikane, do not transport cylinders in the same airspace as the driver or other occupants of vehicles, such as in vans or unpartitioned trucks.

Always store and transport cylinders in a secure upright position.

Do not transport cylinders of Vikane in the same airspace or breathing zone of any area occupied by the driver and other occupants of vehicles.

Consult your local distributor or Dow AgroSciences for training resources for DOT regulations.

Air Transportation

Never transport cylinders of Vikane by aircraft.

Empty Cylinders

Return all empty cylinders to your distributor of Vikane. Follow proper cylinder handling directions above. When the cylinder is empty, close the valve, screw the safety cap onto valve outlet, and replace protection bonnet before returning to supplier. Only Dow AgroSciences is authorized to refill cylinders. Do not use cylinders for any other purpose.

Remember to close valve completely on empty cylinders.

Cylinder Leak Procedures

If a cylinder is suspected of leaking fumigant, evacuate immediate area. Use a NIOSH or MSA approved positive pressure self-contained breathing apparatus (SCBA, not SCUBA) or combination air-supplied/SCBA respirator, such as manufactured by Draeger, Ranger, Survivair, Scott, or MSA, for entry into affected areas to correct problem. The SCBA must be worn when exposure is greater than 1 ppm or when the concentration is unknown.

Move leaking or damaged cylinder outdoors or to an isolated location, observing strict safety precautions. Work upwind if possible. Do not permit entry into the leakage areas in which fumigant concentration exceed 1ppm by unprotected persons until concentration of fumigant in the breathing zone (areas within the structure where individuals typically stand, sit or lie down) is determined to be 1 ppm or less, as determined by a detection device with sufficient sensitivity such as an INTERSCAN, MIRAN [SapphIRe] or Spectros ExplorIR gas analyzers.

Often tightening the packing nut on the top of the valve to about 35 to 40 N.m (25 to 30 foot pounds) of torque with an adjustable wrench will stop the leak. Do not use excessive force to open a stuck or improperly seated valve. Call Dow AgroSciences at 1-800-992-5994 if immediate guidance is needed on

how to handle a leaking cylinder. For cylinders that are deemed to be defective, contact your distributor of Vikane or Dow AgroSciences for return procedures. Avoid using a cylinder in which you believe the valve may be defective.

Once the cylinder is empty, contact your distributor of Vikane for proper return instructions.

IN CASE OF EMERGENCY CALL 1-800-992-5994

Avoid marking functional cylinders with paint as this could cause confusion when returning cylinders requiring special service.

FUMIGATION PREPARATION4

Fumigator should read and be familiar with the Manual prior to using the fumigant.

Some local ordinances may require notification of local police or fire department and emergency responders of impending start and finish times for a structural fumigation, and relevant safety and health information on the fumigant to be used, in case of emergency.

Always follow federal, state and local regulations.

OCCUPANTS/CUSTOMER COMMUNICATIONS

Fact Sheet

Prior to the parties entering into a fumigation agreement, the Fact Sheet for Vikane must be provided to an adult occupant of the structure to be fumigated or of each currently occupied unit in multi-unit structures. This Fact Sheet is required by the label for Vikane and should not be confused with the customer checklist required by some state regulations. Copies of the Fact Sheet may be ordered from Dow AgroSciences or your distributor representative for Vikane.

Property Owner/Customer Checklist

Follow state requirements for informing occupants and owners of buildings to be fumigated of the fumigation process and of their involvement in preparation, vacancy and re-occupancy. Some states require the applicator to provide the customer with a list of preparations required for the fumigation. The customer may also be required to acknowledge in writing certain liabilities, such as potential damage to plants included within the fumigation or tarping space, and fragile structural features such as tile roofs, antennas, gutters, awnings, attached fences, etc.

Listed below are items that the applicator should consider informing owners and occupants of a building to be fumigated prior to the fumigation. Some of these items of notification may be required by state regulations.

- Their specific role of occupant/owners in preparation for fumigation - what to prepare, turn off, remove, etc.
- There can be no entry by unauthorized personnel into the structure until it is certified clear for reentry by the fumigation company.
- The applicator or state regulations may require property owners to provide keys to the applicator for the structure to be fumigated. Follow state regulations regarding fumigator access to the fumigated space.
- Occupants/owners should inform the applicator of known or potential connections to adjacent buildings.

MULTI-UNIT STRUCTURES

When fumigating a single unit/room within a larger structure (such as townhouses, apartments, condominiums), all units of the entire structure must be prepared as a fumigated structure, and all applicable rules, regulations and label instructions apply, such as occupant notification, structure preparation, posting, securing and aeration. An adult occupant of each currently occupied unit must be provided with the Fact Sheet for Vikane.

CONNECTED STRUCTURES

A connected structure is defined as any structure connected with the structure to be fumigated by construction elements (e.g., pipes, conduits, ducts, etc.) which may allow passage of fumigant between the structures. If state rules and regulations do not describe or permit a process to isolate and seal a connected structure to prevent passage of fumigant from the fumigated structure, then the connected structure must be vacated during the fumigation. When it is necessary to vacate any connected structure, that structure shall be considered as a fumigated structure and all applicable rules, regulations

and label instructions apply, such as occupant notification, structure preparation, posting, securing, and aeration. The connected structure does not need to be sealed. Chloropicrin does not need to be introduced into the connected structure. Chloropicrin need only be used in the space where Vikane is introduced. Concentration levels of Vikane must be measured (see Aeration and Clearance Testing) in any connected space or structure to confirm concentrations are 1 ppm or less before structure can be reoccupied.

WHAT TO REMOVE PRIOR TO FUMIGATION

Remove from the structure to be fumigated all persons, domestic animals, pets, and desirable growing plants.

Domestic animals and pets do not include feral animals, which include domesticated animals that have reverted to a wild condition and are not legally owned by any person(s). If pets, domestic or feral animals are observed or known to occupy areas of the structure to be fumigated, it is recommended that the fumigator and property owner determine whose responsibility it will be to remove, trap or otherwise exclude these animals from the structure prior to the fumigation. It is recommended that the applicator inform occupants and owners of the following: 1) to notify nearby neighbors of the date of fumigation; 2) to keep pets away during the fumigation; and 3) to close off any open access to the subarea to prevent pets from entering. This should assist in vacating the structure of pets, domestic and feral animals prior to the fumigation.

Remove fish tanks containing live fish, or remove the fish, or develop a plan for preparing the tank for fumigation. If necessary, exclude water in the tank and biological filters, if present, from the fumigated space by sealing with gas resistant tarps or sheeting. If water aeration is required during fumigation, provide fresh air from outside the fumigated space for the tank aerator.

For mattresses (excluding waterbeds) and pillows completely enveloped in waterproof coverings, do one of the following: 1) open the seal of the water proof covering or 2) remove the mattress or pillow from the space to be fumigated if the waterproof covering cannot be opened. Mattresses and pillows with waterproof coverings containing built-in vents designed to permit air passage are considered to have an open seal to the waterproof covering and can remain as-is in the fumigated space.

Food, feed, drugs (including tobacco products), and medicinals (including those items in refrigerators and freezers) can remain in the structure if they are in plastic, glass, or metal bottles, cans, or jars with the original manufacturer's air-tight seal intact. Food, feed, drugs (including tobacco products), and medicinals (including those items in refrigerators and freezers) not in plastic, glass, or metal bottles, cans, or jars with the original manufacturer's air-tight seal intact, need to be removed from the fumigation site, or double bagged in Nylofume® bags, which are available from distributors of Vikane. Opened items that do not need to be removed or sealed in Nylofume bags include dental hygiene products (including toothpaste, mouthwash, dental adhesives, and dental whitening products), cosmetics including lipstick, all externally applied lotions and ointments, ice and water.

Sulfuryl fluoride can react with strong bases such as some photo developing solutions. It is advised that the fumigator recommend to occupants that photo developing solutions that are not in a manufacturer's airtight container be removed or bagged in Nylofume bags prior to the fumigation or replaced after the fumigation.

FLAMES OR HEATING ELEMENTS

Vikane is a very stable compound that is relatively non-reactive and non-flammable. However, under high heat conditions present in gas flames or glowing electric elements, Vikane can decompose into SO₂, HF, and other decomposition products. HF readily solubilizes in water to form hydrofluoric acid. This acid is highly reactive and can corrode or damage many materials including metals, glass, ceramic finishes, and fabrics. Therefore, extinguish all flames including pilot lights of furnaces, hot water heaters, dryers, gas refrigerators, ranges, ovens, broilers, gas fireplaces, etc. Turn off or unplug all electrical heating elements such as those in heaters, dryers, etc. Turn off or unplug all heaters, electric pianos or organs, etc. Shut off automatic switch controls for appliances and lighting systems that will be included in the space to be fumigated.

Follow procedures required by the local gas company when shutting off natural gas or propane service. The local gas company or other appropriate authority will need to turn on gas service after it has been turned off to determine that the gas flow and pressure are normal.

Before fumigating, extinguish ALL flames, including pilot lights and turn off ALL glowing heating elements. The heat of gas flames, pilot light flames, or the glowing wires or hot surfaces of electric heaters can cause Vikane to break down to form a corrosive material.

Chlorine Gas: Damage to metals can also occur from the inclusion in the tent of the swimming pool chlorinators that generate chlorine gas for chlorination. These pieces of equipment should either be turned off or excluded from the fumigation.

GAS DISTRIBUTION

Open operable internal doors, internal openings to attics and sub areas, storage chests, cabinets, drawers, closets, and appliances (such as washers, dishwashers, dryers, microwave or conventional ovens, etc.). This will aid in fumigant distribution and aeration. Refrigerator and freezer doors may be left open if the units are turned off or disconnected and all food items have been removed. (If the applicator chooses to leave sealed food items in closed refrigerators and freezers during the fumigation, the appliances must be opened when clearing the structure until the concentration of Vikane in them is 1 ppm or less.)

If the structure has an attached garage, the door between the garage and structure should be open during aeration. This door can remain open during the fumigation.

FAN PLACEMENT AND SPECIFICATIONS

Purpose of Fans

There are three purposes for fans in a structural fumigation:

1. Fumigant introduction
2. Equilibrium and circulation
3. Aeration

Positioning Fans

The following is a requirement for positioning of fans:

- During aeration, open all operable attic doors and accesses and direct a fan into the attic. This fan can be positioned prior to fumigant introduction and operated throughout the fumigant exposure period if desired. There is no set pattern established for the positioning or the number of fans to use.

The following guidelines for fan placement may be followed when practical:

- Introduction: Each fan used at a release point for fumigant introduction should be into a large open space in the fumigation site. Multiple release points may be necessary depending upon the size of the fumigated space and the amount of fumigant to be introduced (see chapter on Introduction of Vikane).
- Equilibrium: Fans should be strategically placed to facilitate rapid dispersion and equilibrium of the fumigant:
 - Consider using at least one fan for each level of the structure, including basements.
 - If a building is compartmentalized, such as containing steeples or towers, consider placing fans in each compartment or section.
 - Consider using at least one fan per 45,000 cubic feet of space for circulation. The number of fans required will depend upon the structure volume and configuration.
- Aeration: If the structure has a central air handling system, the fan (or blower) should be activated for each unit if operational. As an alternative, a fan may be placed in front of a furnace inlet to blow air into central heating and cooling ducts. This fan can be positioned prior to fumigant introduction and operated throughout the fumigant exposure period if desired.

Fan Specifications

There are specifications for fan capacity used at a release point for fumigant introduction and during aeration as follows:

- Introduction: These fans must have a minimum capacity of at least 1000 cubic feet per minute (cfm) for each pound of Vikane released per minute. More than one fan can be used at the fumigant release point to obtain this capacity.
- Aeration: The fan(s) must have a total capacity of 5000 cfm and must operate for at least one hour with all operable doors and windows opened. More than one fan can be used to obtain this capacity.

Check the manufacturer rating for fan capacity (cfm) to determine if sufficient capacity is used to meet label requirements.

Other specifications for fans used during fumigation are at the discretion of the applicator, unless otherwise specified by state and local laws. It is recommended that the applicator consider the following when selecting and installing fans at a fumigation site:

- The fans should be UL listed and grounded. Fans are available with a thermal shut-off switch that automatically turns off the fan motor if it overheats.
- Use fans that have a durable housing to protect the blades, such as metal cage fans, commercial or industrial grade fans, etc.
- Use fans with housing and electric cords intact.

Reaching Equilibrium

When liquid Vikane is released from the introduction hose, it extracts heat from the surrounding air as it expands to form a gas. A pound of liquid Vikane changing to the gas phase will drop the temperature of 1000 cubic feet of dry air 4.5°F (28.3 m³ of air 2.5°C).

The chilling can cause the formation of a cloud of condensed water (fog) that should be dissipated before it collects on a surface. The rate of dissipation depends upon the fumigant release rate, relative humidity, and fan capacity, quantity, and placement.

Vikane gas is heavier than air and can initially settle to the bottom of the fumigation space unless mechanically mixed. Vikane will eventually move from an area of high concentration to low concentration and can reach equilibrium in a confined space without the use of fans. Nonetheless, the rate of passive diffusion of Vikane may be too slow to achieve equilibrium within a desirable period so mechanical mixing of Vikane with air using fans is important.

Continuous Circulation with Fans

After fumigant introduction is completed and equilibrium is obtained, fans may be left operating during the fumigation exposure period if desired. Continuous circulation using fans during the fumigant exposure period will not detectably affect the loss rate (half-loss time, HLT) of Vikane for an adequately sealed structure.

Preparing for Aeration

When preparing for the fumigation, it is recommended to plan ahead for the aeration period and take steps to aid aeration by strategic placement of fans and other aeration tools. Fans are excellent aids in attaining rapid aeration and are important when cross ventilation is poor. The fans used for fumigant introduction and distribution may need to be repositioned to enhance aeration.

ELECTRICITY

Electricity is needed to operate fans during fumigant introduction and aeration. If electricity is not available on the property to be fumigated, the applicator should make alternate arrangements, such as having a generator or securing power from a neighbor.

MONITORING HOSES

If fumigant concentrations will be monitored during the fumigant exposure period, monitoring hoses are placed in the structure prior to fumigant introduction. Consult the chapter on Monitoring Vikane for guidance on placement of monitoring hoses.

SEALING THE STRUCTURE

Increasing the seal (HLT) of the fumigation site is one of the most effective ways to ensure a quality fumigation and reduce the total amount of fumigant needed. There are various methods available to seal structures.

Tape and Seal

Some types of construction, such as stucco, brick masonry block, concrete, and metal, may be adequately sealed by using sealing materials, such as polyethylene sheeting, laminated paper, non-porous panels, fumigation tape, spray adhesives, foams and insulation materials. These materials are used to seal gaps in doors, windows, roof eaves, loading docks, pipes, vents, and other openings. When properly used, these materials can adequately confine the fumigant within the structure.

However, even with thorough taping and sealing, fumigant can leak through the building walls and roof at an unknown rate. The Fumiguide™ System for estimating HLT was developed for tarped structures and may not accurately estimate the HLT of tape and seal structures (see chapter on Fumiguide Calculations). For this reason, it is recommended to monitor a tape and seal structure with a Fumiscope or similar device to confirm the HLT and adequate dosage accumulation (see chapter on Monitoring Vikane).

Tarping

Tarpaulins (tarps) can be used to cover the entire structure/area being fumigated, or in combination with tape and seal methods, to cover part of a structure. This method is effective on a wide variety of structure sizes and types. The ability of a tarp to contain a gas depends upon its construction material, the condition of the tarp, and the quality of the tarp installation.

Tarp Material

Use tarps made of materials that will adequately confine Vikane for the required time, such as 4 to 6 mil polyethylene, laminated polyethylene, vinyl coated nylon, neoprene coated nylon, and PVC (polyvinyl chloride) coated nylon.

Materials of at least 4 mil (160 microns) in thickness should be used. Polyethylene tarps less than 4 mil (160 microns) are not recommended because they do not possess the strength and weight needed for the handling, wind resistance and abrasion encountered in most fumigations.

Tarp Condition

Tarps should be kept in good repair to minimize fumigant loss through tears and extensive abrasions. It is recommended to seal tarp tears using appropriate methods, which can include sewing, patching with tarp material using glue or a heat gun, taping, or rolling and clamping the tarp to cover these openings. Consult manufacturers for recommended repair methods for their tarps.

The applicator can protect tarps from tearing by covering sharp structural edges with materials such as tape, carpeting, corner pads, etc.

Tarp Installation

To minimize escape of gas through the soil and to avoid injury to nearby plants, wet soil outward from foundation to the cover if not sufficiently moist to act as a barrier for the gas. Watering the soil in the subarea of crawlspace structures immediately prior to fumigation is not recommended in geographies with high humidity and high soil moisture content, such as the southeastern U.S., because moisture may condense on interior surfaces during the fumigation causing water damage and/or odor problems. For

fumigated structures located over or adjacent to water, placing tarps in water can provide an adequate underseal.

To minimize gas loss, a smooth ground surface should be created when practical for tarps to contact by following steps such as:

- Rake back sufficient loose material, such as mulch, gravel, bark chips, pine needles, and debris from the foundation.
- Use sand or soil to ramp, or use tape and adhesives, to seal gaps around rigid, immovable objects, such as curbs, pavers, and garden edging.

Seal the bottom edges of the tarp to the ground using materials such as soil, sand, or weighted "snakes." Sufficient tarp "apron" should be available at ground level for the sealing and to accommodate shifting of tarps from wind movement. These guidelines may be followed to minimize gas loss:

- Use sufficiently filled snakes for sealing tarps for expected conditions.
- Overlap snakes to minimize fumigant passage between them.
- For water snakes, roll and securely clamp the ends to minimize water leakage during the fumigation exposure period. Block/secure the water snakes to prevent them from rolling off the tarp apron.

Where tarps join, the edges should be tightly rolled and clamped. Tall or highly stressed tarp seams, such as in windy conditions, will require closer spacing of clamps.

Conduits

The fumigated structure should be inspected for pipes, conduits, ducts, or others features which would result in fumigant loss outside of the fumigated space. If possible, these features should be sealed to stop excessive gas loss.

PLACARDING AND SECURING FUMIGATED AREAS

Posting of Fumigated Areas

Vikane is a toxic gas. All entrances of the fumigated environment and any connected area must be posted with warning signs. Some states have extensive regulations regarding warning sign formatting, size, information content, placement, and weather durability. The warning signs must be printed with:

1. The signal word DANGER/PELIGRO and the SKULL and CROSSBONES symbol.
2. The statement "Area under fumigation, DO NOT ENTER/NO ENTRE."
3. The date of fumigation.
4. Name of fumigant used.
5. Name, address, and telephone number of the applicator.

The following are additional considerations for posting warning signs:

- Securely affix warning signs to all sides of the structure.
- Have information on signs remain legible during the entire posting period.
- Use telephone number(s) written on the warning signs that allow for prompt 24-hour communication, including weekends, with the certified applicator in case of emergency.
- Follow all state and federal regulations regarding use of and information reported on warning signs.

Only a certified applicator may authorize removal of warning signs. The warning signs may be removed only when the concentration of Vikane within the breathing zones (areas within the structure where individuals typically stand, sit or lie down) of the fumigated area is 1 ppm or less after Step 3 of the aeration procedure.

Warning Agent

Vikane has no intrinsic warning properties. Chloropicrin is used as a warning agent and is introduced into the fumigated structure at least 5 minutes before Vikane is introduced (see chapter on Release of Warning Agent).

Securing Structures

To secure the structure against unauthorized entry during the fumigation exposure period and Step 2 of Aeration Procedure 1 or 2 (see chapter on Aerating and Clearance Testing), use a locking device or barricade on all exterior doors or doorways. A locking device, such as a secondary lock, or barricade must be demonstratively effective in preventing an exterior door or doorway from being opened from the exterior using normal opening or entering processes by anyone other than the certified applicator in charge of the fumigation or persons in his/her on-site direct supervision. Consult state and local regulations for any supplementary instructions and restrictions on securing against entry.

Examples of common locking devices to secure the fumigated structure against unauthorized entry include:

Clam Shell Locks

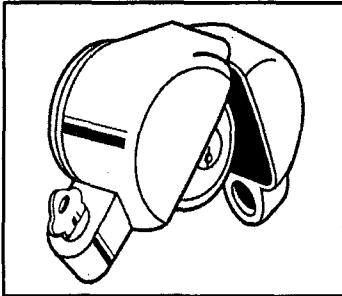

Clam shell locks are designed to prevent use of the door or occupant's keys to unlock entrance doors.

Key-Way Locks

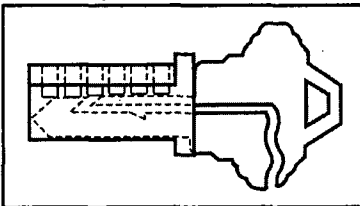

Key-way locks are designed to prevent use of the occupant's keys to unlock entrance doors. These function by inserting a two-part locking key into the door keyhole and removing only half of the key. The other half of the locking key remaining in the door prevents insertion of the occupant's key.

J-SAFE Locks

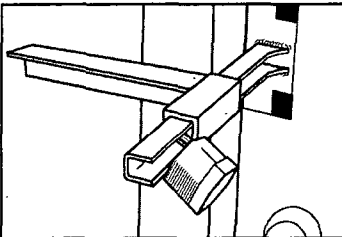

A variety of other devices, such as chains, padlocks, plywood and c-clamps, can be used depending upon the entrance configuration.

Existing locking devices, such as pins or bars for sliding glass doors, or interior bolts, can be used to secure entrances without the use of secondary locking devices if the devices cannot be opened or removed from the exterior of the structure.

The purpose of opening windows in tarped buildings during the fumigant exposure period is to reduce the time for the fumigant to reach equilibrium inside the building and between the building and the tarps. For wood-destroying insects, this can be necessary for sufficient fumigant exposure of target pests infesting external structural features such as wood eaves and soffits. Windows are not considered normal entries and should be opened, if operable and as permitted by local and state regulations, during fumigation of tarped buildings. Consult state and local regulations for any supplementary instructions and restrictions on opening windows.

Although windows are not considered normal entries, in areas where security may be an issue, fumigators may do the following to reduce the number of windows that need to be opened during the fumigant exposure period:

- For single story structures, open at least one operable window in each room, including garages, that contain one or more windows that can be accessed and opened by normal means (e.g., does not require moving furniture, removing nails, or cutting seals such as paint).
- For multi-story structures with shared interior airspace between floors, all windows on the ground level may remain closed. Open at least one operable window in each room of upper stories that contain one or more windows that can be accessed and opened by normal means (e.g., does not require moving furniture, removing nails, or cutting seals such as paint).

Guards

For fumigation of passenger rail cars using Vikane, guards may be used in lieu of use of chloropicrin as a warning agent. Guards may be required in state or local regulations or by the customer. If chloropicrin is not used as a warning agent when fumigating passenger rail cars with Vikane, then a guard is required.

FUMIGUIDE CALCULATIONS.....5

FUMIGANT DOSAGE

The dosage of a fumigant is calculated as the product of its concentration (C in ounces) and exposure time (T in hours). The oz-hr dosage can be achieved by varying C (ounces/1000 cubic feet) and T (hours) to produce a toxic effect on the target pest(s). Therefore, the oz-hr dosage required to kill the target pest(s) is accumulated over a period of time and is measured in ounce-hours.

Dosage = Concentration (C) x Time (T) = oz-hr/1000 cu ft = oz-hr Dosage The concentration in oz/1000 cu ft of fumigant multiplied by the exposure time in hours.

Concentration of Vikane 1 oz/1000 cu ft = 240 ppm
--

FACTORS AFFECTING OZ-HR DOSAGE

The oz-hr dosage required is determined by pest species and life stage, and the temperature at the site of the pest.

Pest Factor

The toxicity of fumigants, including Vikane, is determined largely by the uptake of fumigant by the target pest during the time of exposure. The post-embryonic stages of all arthropods tested are more susceptible to Vikane than the eggs, and are controlled with relatively low dosages of Vikane. Table 5a shows oz-hr dosage in laboratory trials required to control different life stages of various pest species.

Higher dosages of Vikane are required for complete control of egg stages. For social insects, such as termites and ants, control of the egg stage is not necessary when workers are eradicated. The larvae of social insects hatching from eggs will not survive without the care of workers. For termites and ants, fumigant dosages lethal for workers will also kill winged reproductives, called swarmers.

Table 5a Lethal Accumulated Dosages (LAD₉₉) (oz-h/1000 cu ft) of Sulfuryl Fluoride for Various Arthropod Species

Species		Hrs of exposure	Temp (°F)	Life Stage of Arthropod			
Scientific Name	Common Name			Adult	Egg	Larva/Nymph	Pupa
Ticks and spiders							
Rhipicephalus sanguineus	brown dog tick	16	72	186 ^d (2) ^h	--	--	--
		8	81	108	--	--	--
Lactrodectus hesperus	black widow spider	20	81	82 (4)	300 ^a	--	--
Loxosceles reclusa	brown recluse spider	20	81	77 (7)	--	--	--
Cockroaches							
Periplaneta americana	American cockroach	16	80	9 ^c (7)	413 ^c (14)	--	--
		8	81	--	>402 ^d (14)	--	--
Blattella germanica	German cockroach	16	80	19 ^c (3)	--	--	--
		4	70	16 (2)	64 ^c (13)	--	--
		8	81	--	--	17 ^f (9)	--
Supella longipalpa	brown-banded cockroach	16	80	64 ^a (14)	>256 ^d (14)	64 ^a (14)	--
Termites							
Neotermes jouteli	--	22	81	36 (5)	--	--	--
Zootermopsis angusticollis	western dampwood termite	22	81	35 (5)	--	--	--
Kalotermes approximatus	--	22	81	44 (5)	--	--	--
Cryptotermes cavitrons	--	22	81	37 (5)	--	--	--
		4-20	81	48 ^a (3)	--	--	--
Incisitermes snyderi	--	22	81	46 (5)	--	--	--
Incisitermes schwarzi	--	4-20	81	48 ^a (3)	--	--	--
Incisitermes minor	western drywood termite	22	81	51 (5)	--	--	--
		24	80	47 (5-14)	--	--	--
Reticulitermes flavipes	eastern subterranean termite	22	81	20 (5)	--	--	--
Reticulitermes tibialis	--	22	81	30 (5)	--	--	--
Coptotermes formosanus	formosan subterranean termite	22	81	39 (5)	--	--	--
		4-20	81	48 ^a (3)	--	--	--
		24	86	132 ^a (0)	--	--	--
Prorhinotermes simplex	--	22	81	42 (5)	--	--	--
Bed bugs							
Cimex lectularius	bed bug	16	80	64 ^a (14)	64 ^a (14)	64 ^a (14)	--
		24	77	95.9 ⁱ (7)	69.1 (7)	95.9 ⁱ (7)	--
		24	59	238.1 ⁱ (3)	149.8 (8)	238.1 ⁱ (3)	--
Dermestid beetles							
Attagenus unicolor	black carpet beetle	16	80	--	1213 ^e	38 ^c (14)	--
		22	80	44 (4)	1694 (18)	68 (2)	--
Anthrenus flavipes	furniture carpet beetle	22	80	78 (6)	854 (18)	156 (8)	--
Dermestes maculatus	hide beetle	22	80	29 (3)	769 (5)	28 (6)	--
Trogoderma granarium	khapra beetle	8	70	--	>499 ^d	80 ^c	128 ^c
Wood-boring beetles							
Lasioderma sericome	cigarette beetle	16	80	15 ^c (14)	--	--	--
		22	80	35 (3)	712 (10)	56 (3)	--
Lyctus planicollis	southern lyctus beetle	16	79	--	512 ^c	--	--
Lyctus brunneus	--	6.5	72	--	289 ^{a,d}	--	--
Euvrilletta pellata	--	18	72	--	470 ^{a,h}	--	--
Hemicoeelus gibbicollis	--	20	72	--	>500 ^d	87 ^a	--
Grain beetles							
Tribolium confusum	confused flour beetle	5	77	55 (7)	--	--	--
		16	80	55 ^c (14)	1125 ^c (14)	--	--
		24	80	--	1517 ^c	--	--
Sitophilus granarius	granary weevil	5	77	18 (7)	--	--	--
		16	80	15 ^c (14)	794 ^c (14)	14 ^c (14)	14 ^c (14)
Rhyzopertha dominica	lesser grain borer	16	80	10 ^c (14)	219 ^c (14)	--	21 ^c (14)
Oryzaephilus surinamensis	sawtoothed grain beetle	16	80	14 ^c (7)	--	--	--
Tenebroides mauritanicus	cadelle	5	77	--	--	82 (7)	--
Moths							
Ephestia elutella	tobacco moth	16	80	--	768 ^a (14)	64 ^a (14)	--
Sitotroga cerealetta	angourmois grain moth	16	80	21 ^c (3)	87 ^c (14)	24 ^c (14)	--
Anagasta kuehniella	Mediterranean flour moth	16	80	34 ^c (3)	--	42 ^c (14)	--
Spodoptera eridania	southern armyworm	16	80	--	363 ^c	--	--
Tineola bisselliella	webbing clothes moth	10	80	--	280 ^a (14)	70 ^c (14)	--
Flies and fleas							
Musca domestica	house fly	16	80	15 ^c (0)	--	--	22 ^c
Ctenocephalides felis	cat flea	20	72	--	--	--	24 ^e

Species		Hrs of exposure	Temp (°F)	Life Stage of Arthropod			
Scientific Name	Common Name			Adult	Egg	Larva/Nymph	Pupa
Ants							
Camponotus floridanus	carpenter ant	8	81	18 (5)	--	--	--
Camponotus modus	carpenter ant	8	61	48 (8)	--	--	--
Camponotus vicinus	carpenter ant	8	61	35 (8)	--	--	--

^aLowest LAD (oz-h/1000 ft³ is equivalent to mg-h/h and g-h/m³) tested resulting in 100% mortality of life stage.

^bNumber in parentheses is days after fumigation at which mortality was assessed.

^cLAD₉₅

^dHighest concentration tested; emergence from same eggs/egg cases observed.

^eLAD₉₀

^fNinth-generation selection of survivors from exposure to sulfuryl fluoride.

^g>2-day old eggs.

^h>4-day old eggs.

ⁱLowest dosage tested for confirmatory trials

Source: E.M. Thoms and Scheffrahn, R.H. (1994) "Control of Pests by Fumigation with Vikane Gas Fumigant." DOWN TO EARTH™ 49(2).

Temperature

As temperature decreases, the respiration rate of arthropods decreases, reducing fumigant uptake. Therefore, the fumigant dosage must be increased as the temperature at the site of the target pest decreases. The exception to this is rodents, which are warm-blooded animals and do not require increased dosages at lower temperatures. To determine the proper dose for rodent control, use 80°F as the calculating temperature.

THE FUMIGUIDE SYSTEM

The Vikane Fumiguide is used for all fumigations using Vikane. The Vikane Fumiguide is part of the labeling for this product and must be used to calculate the dose to apply. The following Fumiguides are available:

- **The Fumiguide B Calculator** is a slide rule designed to estimate confinement, measured as HLT, determine dosage for a non-monitored exposure period of 20 to 24 hours, and convert ounces/1000 cu ft to total pounds required.
- **The Fumiguide Y Calculator** is a slide rule designed to determine actual HLT based upon measurements of concentration of Vikane during fumigation, determine dosage for a monitored exposure period of 2 to 72 hours, and oz-hr dosage for drywood termites based upon temperature. When the Fumiguide Y Calculator is used to calculate dosage for a non-monitored fumigation, the pounds of fumigant introduced must be increased by 33% since fumigant confinement has not been verified. This 33% increase must be manually calculated by the fumigator because the Fumiguide Y calculates dosages for monitored fumigations.
- **The Fumiguide Calculator** incorporates the calculations of the Fumiguide B and Y into a hand-held, electronic calculator. The Fumiguide calculates the rate (pounds/minute) of fumigant introduction based upon fan capacity, measured in amps, and relative humidity. The Fumiguide Calculator determines the dosage for monitored and non-monitored fumigations with exposure periods of 2 to 72 hours; converts ounces/1000 cu ft to total pounds required, and determines oz-hr dosage for dosage factors up to 10-fold the drywood termite dosage. The calculator will also calculate the chloropicrin dosage and can calculate additional pounds required for interrupted fumigations, such as when tarps blow open.

Contact distributors for Vikane or Dow AgroSciences to order Fumiguide calculators. General guidelines for use of the Fumiguide System are provided below.

Calculating HLT

Fumigant confinement is described as HLT, the time for the initial fumigant concentration to be reduced by half. The Fumiguide System uses five factors to estimate HLT:

1. Tarpaulin condition
2. Seal condition (where a tarp is sealed to the ground, structural and landscape features, another tarp, etc.)
3. Wind speed
4. Volume of fumigated space
5. Underseal (concrete for slab or soil type for crawlspace)

Considerations when estimating HLT using the Fumiguide System:

- **Tarpaulin condition and seal condition are qualitative ratings and are based upon the experience of the applicator.** If the applicator does not know how to rate these conditions or the building is a tape and seal with no tarpaulin used, it is recommended that the fumigation be monitored to determine the actual HLT.
- **The average forecasted wind speed for the duration of the fumigation can be used for calculating the HLT** because the wind speed prior to fumigant introduction may change during the fumigant exposure period.
- **The structural volume is the product of the building length (L), width (W), and average height (H).** For a square or rectangular, flat-roofed building, the volume is L x W x H. For a structure with a typical gabled roof, the average height equals the height to the roofline (eaves) plus one-half the height from the roofline to the roof peak. For basement structures, the distance below grade to the flooring should be included in height measurements to calculate volume. For tarped structures, areas within the tarped space, such as chimneys, steps, decks, and roof overhangs, should be included in the volume for the fumigated space. If desired, contact Dow AgroSciences for training materials on calculating volumes for more complex structures to be fumigated with Vikane.
- **If a structure contains both slab and crawlspace foundations, the underseal should be based upon the soil type in the crawlspace** unless this crawlspace is small in size compared to that of the slab or is partitioned from the slab for fumigation.

Calculating the Oz-Hr Dosage

The Vikane Fumiguide calculates the oz-hr dosage based upon the target pest, its life stage, and temperature at the site of the target pest. In the Fumiguide System, a dosage factor of "1" is the oz-hr dosage for drywood termites. For other target pests, the Fumiguide System calculates higher or lower dosages as multiples of the dosage required to kill drywood termites at the same temperature, depending upon the susceptibility of these pests to Vikane. For example, 10-fold the drywood termite dosage is required to control the egg stage of anobiid beetles (see Table 5b).

Table 5b

Pest	Dosage Factor (as a multiple of drywood termite dosage)
rodents ¹	1/2X
carpet beetles ² and cockroaches ²	1X
Bedbugs	1.9X
furniture carpet beetles ²	3X
old house borers and Formosan termites	4X
clothes moths	6X
powder post beetles and death watch beetles	10X

¹To determine the proper dose for rodent control, use 80°F as the calculating temperature. Unlike insects, rodents are warm blooded and do not require increased dosages at lower temperatures. At least 36 ounce-hours must be accumulated, regardless of temperature, for successful rodent fumigation.

²More than one fumigation may be needed to control the infestation after egg hatch.

Calculating the Amount of Vikane to Introduce

The Fumiguide System calculates the amount of Vikane to introduce into a fumigated space based upon the following factors:

- Estimated HLT
- **Monitored or non-monitored fumigation** - To compensate for not confirming the actual HLT, 33% more Vikane is added to a non-monitored fumigation compared to a monitored fumigation when all other conditions are equal. Monitoring a fumigation can reduce the amount of Vikane applied.
- Oz-hr dosage to be accumulated
- **Exposure time (for oz-hr dosage accumulation)** – Exposure time for oz-hr dosage accumulation is measured from fumigant equilibrium to the initiation of aeration. It can take one hour on average for sulfuryl fluoride to reach equilibrium throughout the fumigated space, including pest harborages, *after fumigant introduction is completed. Therefore, it is recommended to subtract one hour from the end of fumigant introduction to the initiation of aeration to obtain the exposure time used for Fumiguide calculations.*
- Volume of the fumigated space

Using the Vikane Fumiguide When Monitoring

During the exposure period, the concentration of Vikane can be measured by a Fumiscope or similar device at two or more time intervals to calculate the actual HLT, per the following recommendations:

1. Measure (with a gas measuring instrument such as a Fumiscope or similar device) concentration of Vikane/1000 cu ft at or after equilibrium.
2. Take a second measurement of concentration of Vikane after a sufficient time elapsed to calculate the HLT. Accuracy of calculating the actual HLT increases as time between monitoring intervals is increased.
3. If the HLT is shorter than estimated (more rapid loss of fumigant), then more Vikane may need to be added to finish on time or the exposure time may be extended if sufficient Vikane remains.
4. Use the Vikane Fumiguide Y or electronic calculator to determine actual HLT, oz-hr dosage accumulation, and if additional fumigant or time is needed to achieve the required oz-hr dosage.

For assistance with dosage calculations and the Fumiguide System, contact your local distributor or Dow AgroSciences' representative or call Dow AgroSciences at 1-800-352-6776.

Documenting Fumiguide Calculations

Follow all federal, state, and local requirements for documenting fumigations. Federal law requires documentation of date, site and amount of Vikane applied as a restricted use pesticide. Some states require additional documentation. It is suggested that the applicator document the site address, date and time of fumigant introduction, cylinder number of Vikane, target pest, and Fumiguide input variables.

RELEASE OF WARNING AGENT6

Vikane has no intrinsic warning properties, such as odor. The warning agent chloropicrin is released before introducing Vikane to allow time for it to begin to volatilize and distribute throughout the space to be fumigated.

The warning agent chloropicrin must be released into the fumigated space at least 5 to 10 minutes before introduction of Vikane.

The only exceptions to use of chloropicrin would be when fumigating passenger railcars and permanent and temporary fumigation chambers including, but not limited to, shipping containers, storage pods, trailers and trucks, with the following requirements:

- A thorough walk-through inspection must be performed of each railcar/chamber with doors being locked immediately upon leaving.
- For railcars, a guard must be posted during fumigant introduction, exposure period, and aeration if chloropicrin is not used.
- A guard is not required for permanent and temporary fumigation chambers, unless required by state regulations, if locking device(s) or barricade(s) are installed that are demonstratively effective in preventing the fumigated space from being entered using normal opening or entering processes by anyone other than the certified applicator in charge of the fumigation or persons in his/her on-site direct supervision.

There may be unusual circumstances in which the use of chloropicrin is not possible due to its unknown effects on sensitive items, such as artifacts in museums or in police evidence storage. In these circumstances, waiving the use of chloropicrin must be approved by the state regulatory authority and must include alternative safety precautions, such as guarding the fumigated site.

PHYSICAL PROPERTIES OF CHLOROPICRIN COMPARED TO VIKANE

Chloropicrin	Vikane
CCl ₃ NO ₂	SO ₂ F ₂
trichloronitromethane	sulfuryl fluoride
threshold limit value: 0.1 ppm	threshold limit value: 1 ppm
boiling point: 112°C (233.6°F)	boiling point: -55.2°C (-67°F)
vapor pressure: 20 mm Hg at 20°C	vapor pressure: 13,442 mm Hg at 25°C

SAFETY PRECAUTIONS WHEN USING CHLOROPICRIN

Chloropicrin is a warning agent that causes smarting of the eyes, tears, discomfort, and has a very disagreeable pungent odor at very low concentrations.

Chloropicrin must be used by a person certified to apply Vikane or under their supervision. Applicators must observe the chloropicrin precautionary statements and personal protective equipment appearing on this label. Chloropicrin must be applied by persons certified to apply Vikane or under their supervision on site, with a second person trained in the use of chloropicrin being available on site.

Personal Protective Equipment

Some materials that are chemical-resistant to this product are nitrile and butyl. For more options, follow the instructions for category F on the chemical-resistance category selection chart.

All persons applying chloropicrin must wear:

- Long-sleeved shirt and long pants
- Chemical-resistant gloves
- Protective eyewear or face shield (do **not** wear goggles)
- Persons applying chloropicrin must wear either a positive pressure self-contained breathing apparatus or combination air-supplied/SCBA when applying chloropicrin to more than two chloropicrin introduction points within a single fumigated structure

The employer of any person applying chloropicrin must make sure that they are provided and correctly wear the required personal protective equipment. Follow manufacturer's instructions for cleaning/maintaining PPE. If no such instructions for washables exist, use detergent and hot water. Keep and wash PPE separately from other laundry.

First Aid

First aid recommendations, such as time to flush eyes or skin if contacted by chloropicrin, vary depending upon the product label. General first aid procedures are as follows:

If inhaled: Move person to fresh air. Keep warm. If person is not breathing, call 911 or an ambulance, then give artificial respiration, preferably by mouth to mouth if possible. Do not give anything by mouth to an unconscious person. Call a poison control center or doctor for further treatment advice.

If on skin or clothing: Immediately remove contaminated clothing, shoes or any other item on skin. Rinse skin immediately with plenty of water for 15-20 minutes. Call a poison control center or doctor for treatment advice.

If in eyes: Hold eye open and rinse slowly and gently with water for 15-20 minutes. Remove contact lenses, if present, after the first 5 minutes, then continue rinsing eye. Call a poison control center or doctor for treatment advice.

If swallowed: Call a poison control center or doctor for treatment advice. Have person sip a glass of water if able to swallow. Do not induce vomiting unless told to do so by a poison control center or doctor. Do not give anything by mouth to an unconscious person.

Note to Physician: Chloropicrin is a volatile liquid that is an active ingredient in tear gas. As a gas it is a powerful lachrymator. Symptoms of overexposure are profuse lachrymation, respiratory distress and vomiting. Pulmonary edema may develop later.

Storage and Handling

Storage

Store upright in a cool, dry, well-ventilated area under lock and key. Store only in original container. Do not contaminate water, food or feed by storage or disposal.

Spill and Leak Procedures

Evacuate immediate area of spill or leak. Use a self-contained breathing apparatus (SCBA) for entry into affected area to correct the problem. Move the leaking or damaged containers outdoors or to an isolated location, observing strict safety precautions. Work upwind if possible. Allow spilled material to evaporate or absorb onto vermiculite, dry sand, earth, or similar absorbent material. Thoroughly aerate absorbent materials outdoors prior to disposing on site or at an approved disposal facility. Do not permit entry into spill area or cleanup area by unprotected persons until chloropicrin is aerated.

Disposal

If the chloropicrin container is disposable and is non-returnable to the supplier, it is recommended to aerate the empty container opened (e.g., cap off) within the fumigated space during fumigation. The location should be close to a fan and/or chloropicrin introduction site. Replace cap. After it has been aerated inside of the fumigated space, close the container (e.g., replace the cap) and dispose in a sanitary landfill or by other approved state and local procedures.

INTRODUCTION OF CHLOROPICRIN

Research indicates that when chloropicrin is applied according to label directions at each introduction site for Vikane, it will rapidly reach and maintain warning concentrations throughout the fumigated space for the fumigation exposure period. In order for chloropicrin to perform effectively as a warning agent, it must be applied:

- In a shallow container with fresh wicking material.
- In the air stream of a fan.
- At a rate of 1 oz/10,000 to 15,000 cu ft or follow dosage rate calculated by the electronic Fumiguide system. As of November 2007, new and upgraded electronic Fumiguides will calculate a maximum and

minimum chloropicrin dose in ounces to apply. The maximum ounce dose will be based upon 1 oz/10,000 cubic feet. The minimum ounce dose will be based on structure size, underseal (slab or soil) and fumigant exposure time.

- At not more than 3 fl oz of chloropicrin per evaporation container.
- At one or more chloropicrin introduction sites for each 45,000 cu ft of space to be fumigated.

In addition, it is suggested that chloropicrin be introduced:

- On each floor of a multi-story structure.
- At each introduction site of Vikane.
- In areas without excessive furnishings and contents to adsorb chloropicrin.

When applying chloropicrin at multiple chloropicrin introduction points within a structure, start at the point farthest from the exit and work toward the exit.

ADDITIONAL PRECAUTIONS FOR USE AND HANDLING OF CHLOROPICRIN

- **Do not rely upon chloropicrin as the only deterrent to unauthorized entry during the fumigation.** Follow all label, state and local regulations for: conducting the final inspection to insure the fumigation site is vacated of people, pets, and domestic animals prior to fumigant introduction; securing structure entrances; and posting of warning signs. State and local regulations may require additional security measures, such as posting of guards.
- **Use a measuring device to measure the calculated volume of chloropicrin to apply.** Measuring devices with a graduated scale for fluid ounces and reclosable caps are available. An additional advantage of using these devices is that chloropicrin can be measured outside the structure so only the amount of chloropicrin needed during the fumigation is carried into the structure.
- **Do not apply liquid chloropicrin directly to soil, concrete or wood in the fumigated space.** Odor from chloropicrin desorbing from these surfaces after direct application can be persistent and difficult to remove.
- **Do not apply chloropicrin in containers made of magnesium, aluminum, or their alloys since chloropicrin is corrosive to these metals.**
- **Removal of all chloropicrin evaporation containers from the fumigated space during initial phase of aeration after tarp removal** may aid in the dissipation of the warning agent from the structure.
- **The DOT regulates the transportation of chloropicrin.** Regulations include transporting chloropicrin in a DOT-approved shipping container, secured in a separate airspace from the driver and vehicle occupants, in a placarded vehicle operated by a driver with a commercial driver's license with Haz-Mat endorsement.

Contact your local distributor or Dow AgroSciences for information on purchasing evaporation containers, measuring devices for chloropicrin (liquid or airborne concentrations), and training sources for DOT regulations.

VIKANE INTRODUCTION.....7

PREVENTING PROPERTY DAMAGE

- Improper introduction of Vikane may cause property damage from the following processes:
- Liquid Vikane directly contacting surfaces and causing freeze damage or corrosion. Gaseous Vikane is non-corrosive.
 - Excessive condensation, called a "fog-out," causing staining, tarnishing, or corrosion. As described in the chapter on Fumigation Preparation, when liquid Vikane is released from the introduction hose, it extracts heat from the surrounding air as it expands to form a gas. The chilling can cause the formation of a cloud of condensed water (fog) that should be dissipated before it collects on surfaces. Minute quantities of certain byproducts in Vikane may damage susceptible surfaces, such as metals, tile, glass, and carpeting, during a fog-out when they are dissolved in water at sufficient concentrations at the introduction location. These byproducts are of no consequence in the gaseous phase.

Release of Vikane as a liquid, not a gas, and fog-outs can be prevented by the applicator selecting the appropriate fumigant introduction release location(s), introduction hoses, and fans as described below.

CHOOSING FUMIGANT INTRODUCTION LOCATIONS

Apply Vikane in a manner to achieve equilibrium, minimize fog-out potential or damage to fumigated materials, and ensure safety to personnel, pets, and domestic animals. Considerations for introduction location selection include:

1. The largest, open space(s) where **fumigant will not be applied directly to any surface.**
2. Areas without excessive contents (e.g., clutter, many boxes, overstuffed furniture, and pillows) to adsorb chloropicrin since it is suggested that chloropicrin be applied at each introduction site for Vikane.
3. Multiple introduction sites may be necessary if the structure is large, multi-story, has multiple firewalls or is compartmentalized, or if high dose rates of Vikane are applied.
 - a. One fumigant introduction site for each 20,000 to 45,000 cu ft in residential dwellings or similar compartmentalized structures is recommended.
 - b. At least one introduction site on each floor of a multi-story structure is recommended. Unfinished attics and crawlspaces generally are not used as introduction sites to introduce Vikane due to the potential for fog-outs.

SELECTION AND USE OF EQUIPMENT FOR FUMIGANT INTRODUCTION

Select equipment for the introduction of Vikane to meet the following criteria:

- Reliably measure the amount of Vikane being introduced.
- Not damage the cylinder of Vikane or valve.
- Not break down or contaminate Vikane.
- Confine Vikane until it is released into the fumigation area.
- Prevent a fog-out and liquid sulfuryl fluoride from contacting surfaces that could be damaged.
- Enhance fumigant distribution to reach equilibrium.

Weighing the Fumigant

Measure the pounds of Vikane introduced using equipment such as weighing scales. Platform or hanging scales can be used to weigh the cylinder containing Vikane during fumigant introduction to determine the pounds of fumigant introduced. If hanging scales are used, hanging bonnets or similar devices designed for this purpose must be used to hang the cylinder from the scale. Consult Dow AgroSciences or your distributor of Vikane for sources of hanging bonnets or cylinder slings.

Never suspend the cylinder containing Vikane by the valve!

Hoses

Release Vikane through an introduction hose that meets the following criteria:

- Leak proof hose with a minimum burst pressure of 500 pounds per square inch (psi).
- Should be flexible, kink resistant, durable and compatible with liquid Vikane.
- Has appropriate diameter and length to control the introduction rate of Vikane so fan capacity is not exceeded. Vikane is introduced into the blast of air from one or more fans having a total capacity of at least 1000 cu ft per minute (cfm) for each pound of Vikane released per minute. Tables 7a and 7b below can be used to select the appropriate diameter and length of introduction hose to obtain the desired introduction rate for Vikane based on fan capacity. (The maximum introduction rate for Vikane is also calculated by the Fumiguide electronic calculator based on fan amps and relative humidity.)

Table 7a Effect of Inside Diameter Size on Introduction Rate of Vikane Through a 25 ft Polyethylene Hose at 65°F

Tube Inside Diameter (ID)	Pounds Vikane per Minute
1/8	4
1/4	20
1/2	45

Table 7b Effect of Hose Length (1/8" ID) on Introduction Rate of Vikane at 65°F

Hose Length (ft)	Pounds Vikane per Minute
25	4.0
50	2.8
100	2.0 ¹

¹Where fumigant introduction rates lower than 2 lb/min. are needed, a longer hose can be used, e.g., 200 ft.

Use of 1/8 inch ID introduction hose of about 100 feet in length will provide a fumigant introduction rate for drywood termite fumigations that will not exceed the capacity of most standard industry fans.

Prior to use, confirm with distributor or manufacturer that the introduction hose meets the above requirements.

Securing Introduction Hose

Secure the introduction hose to the introduction fan, an introduction stand or by other means to avoid damaging surfaces, furnishings or structural features.

A commonly used method is to securely attach the introduction hose to a tarp clamp and then use the tarp clamp to attach the hose to the fan cage. The fan cage is then angled upward at about 45°. Introduction hoses should not be attached to customer furnishings or structural features such as door knobs to avoid damaging surfaces of these items by clamping, taping, or contact with liquid Vikane.

It is recommended to leave the introduction hose in place during the fumigation exposure period in case additional fumigant needs to be introduced later depending upon fumigant confinement conditions.

Fan Placement and Specifications

Refer to the chapter on Fumigation Preparation for complete directions and recommendations on fan specifications and placement prior to introduction.

Protective Sheeting

It is recommended that protective sheeting, such as polyethylene plastic or tarps, be placed under the introduction stand (if used), hose and fan to further protect floors and floor coverings during application. All of the fumigant introduction options outlined above offer the flexibility to incorporate protective sheeting in critical areas.

Chloropicrin Introduction

Chloropicrin can be introduced at introduction sites for Vikane. Chloropicrin must be used within the structure at least 5 to 10 minutes prior to the introduction of Vikane. Complete directions and

recommendations for chloropicrin use and handling are reviewed in the chapter Release of Warning Agent.

Safety Equipment

Wear splash-resistant goggles (goggles designed and made of material that allows no measurable movement of the liquid pesticide being used to pass through them during use) or full face shield for eye protection during introduction of the fumigant. Do not wear gloves or rubber boots. Do not reuse clothing or shoes that have become contaminated with liquid Vikane until thoroughly aerated and cleaned. Have proper respirator protection (SCBA) available in case of an emergency, such as a ruptured introduction hose. Follow label, state, and local regulations regarding inspection of the space to be fumigated prior to release of the fumigant.

RELEASING VIKANE FROM THE CYLINDER

Refer to the chapter Cylinder Handling and Storage for a complete description of cylinder configuration and handling.

Each cylinder of Vikane is equipped with a dip tube that extends from the bottom of the tank to a valve on the top. To release the fumigant, this valve is opened to permit a free flow of the liquid, which vaporizes as it escapes from the introduction hose. The valve should be turned fully open to fill the fumigant introduction hose with liquid Vikane. Initially, the valve should be opened slightly until flow has begun and then opened about one full turn, which should give full flow through the fumigant introduction hose. When finished, close the valve tightly using an appropriate wrench with a handle of sufficient length to provide the necessary torque. A clearance detector or leak detector may be used to test for a tight seal of the introduction hose at the cylinder valve. Contact Dow AgroSciences for information on the types of wrenches that should be used to open and close valves of cylinders of Vikane.

Frozen Valves and Hoses

As previously discussed in the chapter Fumigation Preparation, when liquid Vikane is released from the introduction hose, it extracts heat from the surrounding air as it expands to form a gas. A pound of liquid Vikane changing to the gas phase will drop the temperature of 1000 cu ft of dry air 4.5°F (28.3 m³ of air 2.5°C).

If the valve is "just cracked" to reduce the rate of release from the cylinder, Vikane will expand from a liquid to a gas in the introduction hose, chilling and frosting of the exterior of the valve and hose. This is avoided by allowing full flow through the cylinder valve. The rate of flow of Vikane should be controlled by the ID and length of hose (see Tables 7a and 7b) and not be restricting flow through the valve.

Frozen Cylinders

If there is a break in the dip tube in the cylinder (a rare occurrence), Vikane will be discharged through the valve and introduction hose as a gas, not a liquid, when the liquid level falls below the break in the broken dip tube. As the liquid expands in the cylinder, heat will be extracted from the surrounding area as described above and the cylinder will frost or freeze at that point. Vikane will be discharged, but at a slower rate because it is in the gaseous phase. Cylinders showing signs of a broken dip tube should be returned to the distributor (see chapter on Cylinder Handling and Storage) so that the problem can be repaired before refilling. Contact your distributor of Vikane for instructions on documentation and return of a potentially malfunctioning cylinder.

Releasing the Last 3 to 5 lb of Vikane

The final pounds of Vikane in a cylinder generally are in a gaseous state and will move through the introduction hose more slowly than will the liquid fumigant. Testing by Dow AgroSciences has determined that it can take up to 20 minutes at 75°F (air temp) to release the last 2 lb of sulfuryl fluoride from a compressed gas cylinder.

MONITORING VIKANE8

The goal in monitoring fumigant concentration during the fumigation exposure time is to calculate the actual HLT and oz-hr dosage accumulation. This allows the applicator to adjust the fumigation if needed, by adding more fumigant or modifying the exposure time, so the necessary oz-hr dosage is accumulated. Monitoring a fumigation is not required by the label for Vikane, but may be requested by a customer or by regulatory officials in certain conditions for verification of oz-hr dosage accumulation.

GUIDELINES FOR MONITORING A FUMIGATION

1. Consider monitoring Vikane in the space(s) most representative of the atmosphere in the structure, such as the living space of a residential building. In large jobs, multiple sampling locations may be appropriate. Monitoring can also be conducted in the attic and/or crawlspace, if present and accessible, to determine fumigant distribution throughout the structure.
2. In partitioned structures, monitoring samples should be taken from the separate sections, such as each floor of a multistory building.
3. The time required between measurements to determine the actual HLT will depend upon the fumigant confinement. The time between readings should be sufficient to detect a change in the fumigant concentration. Usually two to four hours will be adequate, but in the case of structures with excellent confinement, more time may be required.
4. To confirm the total oz-hr dosage accumulated, the fumigated space will need to be monitored at two time intervals occurring approximately at equilibrium and prior to aeration.

EQUIPMENT

Fumiguide Calculator

The Fumiguide electronic calculator can be used for both non-monitored and monitored fumigations. The Fumiguide Y may also be used for monitored fumigations. These calculators require two fumigant concentration measurements (taken at two different time intervals following fumigant introduction) and the time between the two measurements to calculate an actual HLT and oz-hr dosage accumulation.

Monitoring Hoses

Monitoring hoses for sampling fumigant concentrations should be placed in the structure prior to fumigant introduction. Semi-rigid hoses typically 1/8" to 1/2" ID are used. Monitoring hoses larger than 1/2" ID may take a longer time to pull the sample from the fumigated space to the monitoring device because of the larger volume of air needed to be moved.

Monitoring Equipment

The Fumiscope, using a thermal conductivity sensor, is an example of equipment commonly used to measure concentrations of Vikane during the fumigation exposure time. The Fumiscope (including models EV, E-200, D, 5.0 and RDA) is not sensitive enough to use as a clearing device after aeration of Vikane. Follow all manufacturer recommendations for use and calibration of Fumiscope. Contact distributors and Dow AgroSciences for information on where to purchase or repair equipment, such as the Fumiscope, for monitoring fumigations of Vikane.

AERATING AND CLEARANCE TESTING.....9

When used for fumigation of enclosed spaces, two persons trained in the use of this product, at least one being an applicator who is licensed/certified by the state, must be present during the initiation of the initial aeration procedure.

PREPARING FOR AERATION

When preparing the fumigation, it is recommended to plan ahead for the aeration period and take steps to aid aeration by strategic placement of fans and other aeration tools. The fans used for fumigant introduction and distribution (Fig. 9a) may need to be repositioned to enhance aeration (Fig 9b). The most efficient use of the aeration fans is to position so airflow is moving in one direction. This is done by positioning fans for fresh air intake in openings on one side of the structure and fans for exhausting fumigant in openings on the opposite side of the structure (Fig. 9b). Consult local regulations for any additional requirements or restrictions for aeration procedures.

Figure 9a Example of Fan Placement for Introduction and Distribution of Vikane

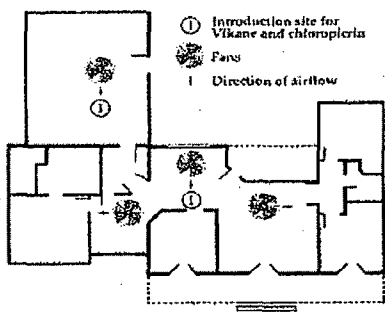
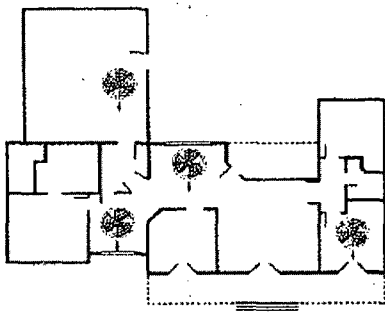

Figure 9b Example of Fans Repositioned for Unidirectional Flow for Aeration of Vikane



AERATION PROCEDURES

Aeration procedures available to the fumigator may vary depending upon the state. Refer to the label registered in the state, your distributor, or your Dow AgroSciences representative for further information.

No one should be in treated areas if the level of Vikane is above 1 ppm, or if the level of Vikane is unknown, unless provided with a NIOSH or MSHA approved positive self-contained breathing apparatus (SCBA, not SCUBA) or combination air supplied/SCBA respirator such as manufactured by Ranger, Survivair, Scott or MSA.

Aeration Procedures 1 and 2 are as follows:

All structures fumigated at 16 oz/Mcf or less may be aerated using procedures 1 or 2.

All structures fumigated at concentrations greater than 16 oz/Mcf must be aerated using procedure 2.

Aeration Procedure 1

These steps must be completed in sequence.

Step (1): Aerate structure with all operable windows and doors open, aided by the use of one or more fans, for a minimum of 1 hour. Total fan capacity, using one or more fans, shall be capable of displacing a total of 5000 cfm.

Step (2): Secure structure and do not allow reentry for a minimum of 6 hours from the start of aeration (first opening of the seal). During this time structures must remain posted.

Step (3): After the minimum 6-hour waiting period, measure the concentration of Vikane in breathing zones of each room. Breathing zones are defined as areas within the structure where individuals typically stand, sit or lie down. If the concentration of Vikane is greater than 1 ppm, further aeration and re-testing are required. If the concentration of Vikane is greater than 1 ppm, ventilate structure with operable doors and windows open and confirm concentrations are 1 ppm or less before the structure is reoccupied.

Aeration Procedure 2

These steps must be completed in sequence.

Step (1): Aerate structure with all operable windows and doors open, aided by the use of one or more fans, for a minimum of 1 hour. Total fan capacity, using one or more fans, shall be capable of displacing a total of 5000 cfm.

Step (2): Secure the structure and do not allow reentry for a minimum of 8 hours from the start of aeration (first opening of the seal). During this time the structure must remain posted.

Step (3): After the minimum 8-hour waiting period, measure the concentrations of Vikane in breathing zones of each room. Breathing zones are defined as areas within the structure where individuals typically stand, sit or lie down. If the concentration of Vikane is greater than 1 ppm, further aeration and re-testing are required. If the concentration of Vikane is greater than 1 ppm, ventilate structure with operable doors and windows open and confirm concentrations are 1 ppm or less before the structure is reoccupied.

Aeration Procedures 1 and 2 require the applicator to aerate the structure with operable doors and windows open and with the aid of one or more fans for a minimum of one hour. This active ventilation is required to enhance fumigant diffusion and prevent fumigant concentrations from exceeding 1 ppm following clearance. These aeration procedures have been tested under a variety of structural and environmental conditions typically encountered while conducting structural fumigations. The applicator may increase the total aeration period beyond a total six to eight hours for ease in scheduling.

During the initial one-hour aeration procedure, approved respiratory protection must be worn until the concentration of Vikane is confirmed not to exceed 1 ppm with an approved detection device. Since the INTERSCAN, MIRAN [SapphIRe] and Spectros ExplorIR gas analyzers give immediate readings, respiratory protection is not required when clearing with these instruments after having completed the initial one hour aeration procedure. If a reading indicates levels in excess of 1 ppm, leave the affected area immediately.

At the conclusion of the aeration period, the structure and any connected structure must be tested with an approved detection device of sufficient sensitivity such as the INTERSCAN, MIRAN [SapphIRe] or Spectros ExplorIR gas analyzers to confirm a concentration of Vikane of 1 ppm or less in the breathing zones of each room. Breathing zones are defined as areas within the structure where individuals typically stand, sit or lie down. If the concentration of Vikane is greater than 1 ppm, further aeration and re-testing is required.

CLEARANCE TESTING EQUIPMENT

The INTERSCAN, MIRAN [SapphIRe] or Spectros ExplorIR gas analyzers are approved detection devices of sufficient sensitivity to clear structures following fumigation with Vikane. All are continuous reading instruments which may be battery operated.

The **INTERSCAN** Model GF1900 has an integral pump that draws the air sample through a pyrolyzer (furnace) where the sulfuryl fluoride is converted to SO₂ which then passes through an SO₂ sensor. The sensor output is registered on a direct reading dial as ppm of sulfuryl fluoride. The unit can also be AC powered.

The **Miran SapphIRE** utilizes a single beam, infrared detection technology to directly measure low concentrations (0 to 5 ppm) of sulfuryl fluoride.

The **Spectros ExplorIR** utilizes a non-dispersive infrared (NDIR) technology to directly measure sulfuryl fluoride. The monitor contains an internal purge air bag which is used to automatically re-zero readings. The purge air bag must be refilled with fresh air about every 30 minutes of detector operation.

Prior to using these instruments to clear a structure for reoccupancy, follow the manufacturer's directions for filling the internal air bag for the ExplorIR and for zeroing the meters for the Interscan and MIRAN analyzers. Manufacturer's instructions also include information regarding appropriate and necessary calibration and maintenance. Documentation to verify the last calibration check of the clearance device(s) being used is often requested by state regulatory enforcement personnel during inspections of fumigation operations. Manufacturer's recommendations must be followed to ensure proper operation of these instruments. Contact your distributor or Dow AgroSciences for information on where to purchase and service these detectors.

New devices may be developed to detect Vikane. Contact your nearest representative from Dow AgroSciences for the latest information on detection devices.

REOCCUPANCY

Until the final clearance is verified, the structure is still considered under fumigation and appropriate precautions are to be taken, such as warning signs remaining posted on all entrances. Do not allow reoccupancy of any fumigated area until the aeration and clearing process is complete according to directions and concentrations of Vikane do not exceed 1 ppm as determined by the use of a detection device with sufficient sensitivity. Only a certified applicator may authorize the removal of the warning signs. Consult local authorities for instructions regarding documentation of clearance such as posting clearance notices.

Follow all federal, state, and local requirements for reoccupancy.

AERATING CHLOROPICRIN

The following procedures are contained on the label for Vikane to aid in aerating chloropicrin:

- Open all operable attic doors and accesses and direct a fan into the attic.
- If the structure has an attached garage, the door between the garage and structure should be open.
- If the structure has a central air handling system, the fan (or blower) should be activated for each unit if operational. As an alternative, a fan may be placed in front of a furnace inlet to blow air into central heating and cooling ducts.

AERATING PASSENGER RAILCARS

Passenger railcars may be aerated using either of the following two aeration procedures (railcars must remain posted until cleared for re-occupancy):

Aeration Procedure 1

If on-board railcar ventilation systems are not operable, aerate railcar for a minimum of 6 hours using the following procedure:

Step (1): Remove all tape, seals, and/or tarps.

Step (2): Open all exterior railcar doors.

Step (3): Open all internal doors such as cabinets, closets, appliances and sleeping berths.

Step (4): In sleeper cars, turn all mattresses askew to expose cavities beneath sleeping berths.

Step (5): Ventilate the railcars for a minimum of 1 hour with enough portable fans to provide a minimum 4000 cfm capacity per floor. A bilevel railcar would require 8000 cfm capacity or greater than 4000 cfm per floor. Direct fans in such a manner to create cross-ventilation of railcar.

Step (6): After the minimum 6-hour aeration time, railcars may be reoccupied when the concentration of Vikane is 1 ppm or less with all doors and windows closed and ventilation systems turned off as measured by a detection device with sufficient sensitivity such as an INTERSCAN, MIRAN [SapphIRe] or Spectros ExplorIR gas analyzers.

Aeration Procedure 2

If on-board railcar ventilation systems are operable, actively ventilate the railcar for a minimum of 2 hours using the following procedures:

Step (1): Remove all tape, seals, and/or tarps.

Step (2): Open all exterior car doors.

Step (3): Open all internal doors such as cabinets, closets, appliances and sleeping berths.

Step (4): In sleeper cars, turn all mattresses askew to expose cavities beneath sleeping berths.

Step (5): Turn on all on-board Heating, Ventilation, Air Conditioning (HVAC) systems and exhaust fans.

Step (6): In sleeper cars, turn on all operable wall or ceiling mounted fans.

Step (7): Ventilate the railcar with enough portable fans to provide a minimum 4000 cfm capacity per floor (in addition to on-board systems). A bilevel railcar would require 8000 cfm capacity or greater - 4000 cfm per floor. Direct fans in such a manner to create cross-ventilation of railcar.

Step (8): After the minimum 2 hours active ventilation/aeration, the railcar may be reoccupied when the concentration of Vikane is 1 ppm or less with all doors and windows closed and ventilation systems turned off as measured by a detection device with sufficient sensitivity such as an INTERSCAN, MIRAN [SapphIRe] or Spectros ExplorIR gas analyzers.

Do not reoccupy the railcar or move the railcar until aeration is complete. Warning signs must remain posted until aeration is determined to be complete.

LATENT MORTALITY

Sometimes live insects may be found immediately after a fumigation. Under optimum conditions, the target pest(s) will be dead or dying by the end of the fumigation period. Latent mortality in insects occurs for exposures very near mortality threshold levels. Researchers have observed a delay in mortality of three to five days following exposure to Vikane. Therefore, judgment of the success of the fumigation should not be made on the presence of live organisms immediately following the fumigation.

NON-TARGET ORGANISMS

Live organisms which are not specific targets of the fumigation may found within the fumigated space following aeration. This does not indicate the fumigation failed to control the target pests because lethal dosage requirements may be higher for non-target organisms than for the target pest(s). Also, the non-target organism may have entered the structure during the aeration period.

SITE SPECIFIC CONSIDERATIONS (SUCH AS CHAMBERS, VEHICLES, SHIPS, PASSENGER RAILCARS)..... 10

When fumigating chambers, vehicles, ships, passenger railcars, containers, or any other structures, all appropriate label instructions apply such as structure preparation, posting, securing, fumigant introduction and aeration.

Site specific considerations are discussed below

CHAMBERS

Load chambers and stacks so that adequate air movement can occur around fumigated items to allow even distribution of the gas.

Atmospheric Pressure Chambers

Design and Construction

A suitable atmospheric fumigation chamber consists of a sufficiently gas-tight room with an appropriate door. An application system, exhaust fan and a small circulation fan for gas distribution are recommended.

Exhaust Fan(s)

The size of the exhaust fan will depend upon the size of the fumigation chamber and the aeration time requirements. Generally, a fan capable of changing the air in the chamber in 5 to 10 minutes is recommended. The chamber should exhaust Vikane away from adjoining buildings or work areas. Consult your state agency for emission control requirements.

Vacuum Chambers

Vacuum chambers require special designs that take into account the vacuum pressure exerted on the materials of construction. For this reason, it is recommended that trained engineers be consulted before constructing a vacuum chamber. Follow all directions given by the manufacturer or design engineer.

Specially built steel chambers for vacuum fumigations provide the fastest and most effective fumigation. After the commodity is placed in the chamber, pumps evacuate air. Vikane is introduced and rapidly penetrates all space previously occupied by air. A lethal dosage of Vikane results when the proper concentration is maintained for the required fumigation period.

Drawing a Vacuum

A vacuum of 25 to 27 inches of mercury is commonly drawn for vacuum fumigations. It is advisable to check to ensure that the vacuum is maintained according to plan. Unplanned vacuum release indicates leakage. Note that some vacuum fumigations are planned to allow release of the vacuum during exposure with the objective of improving penetration of the commodity as air enters the chamber.

Introducing Fumigant

Because of the special design of vacuum chambers, it is recommended that the manufacturer or design engineer's operation procedure be followed. A small fan can be used to distribute the gas uniformly in the chamber if the vacuum is to be maintained throughout the exposure period.

Dosage Monitoring

The Fumiscope or similar device cannot be used to measure Vikane during a vacuum fumigation unless the vacuum is released. If the vacuum is maintained and thus no gas is leaking from chamber, the achieved oz-hr dosage can be calculated by using the simple Concentration x Time formula.

Aeration Procedures

At the end of the exposure, release the vacuum. It is recommended to purge the chamber of air/fumigant two times by pulling a partial vacuum prior to checking the gas concentration for reentry purposes.

For both atmospheric and vacuum chamber fumigations:

- Load chambers so that adequate air movement can occur to allow distribution of the fumigant.
- Application of chloropicrin is not required for chamber fumigations if the chamber 1) can be inspected prior to fumigant introduction to confirm that all persons, domestic animals, and pets have been vacated and 2) is secured to prevent the chamber door from being opened using normal opening or entering processes by anyone other than the certified applicator in charge of the fumigation or persons in his/her on-site direct supervision.
- An introduction fan/circulation fan is recommended when introducing Vikane into chambers to distribute fumigant throughout the chamber. However, if a sufficient open space is not available or if use of an introduction fan is not practical, an introduction/circulation fan is not required. Introduce the fumigant in a manner to avoid a fog-out slowly and not apply liquid Vikane to the surfaces of fumigated commodities.
- Aeration of Vikane from the chamber head space is generally very rapid, but desorption from fumigated items can occur for a longer period of time. Always check for the concentration of Vikane with a suitable detector before entering the chamber without proper respiratory protection (SCBA). It is advised to keep the exhaust fans running during the aeration period and also while unloading the chamber. Only the certified applicator can authorize the removal of warning signs when it has been determined that the concentration of Vikane in the chamber head space is 1 ppm or less.

Contact Dow AgroSciences for consultation regarding any specific question regarding construction of fumigation chambers.

TARPED STACKS

Fumigations may be conducted in temporary chambers created using tarpaulins or other gas impermeable sheeting as the "walls" to hold in the fumigant. These are also called "stack fumigations."

It is recommended to place items on a sufficiently airtight underseal, such as another tarp, polyethylene, concrete, or asphalt, when practical and cover items with impermeable sheeting (i.e., tarp). The edge of the tarp can be sealed either by weighting the edges with soil, sand, "snakes" or equivalent, or by rolling and clamping the edges with the underlying tarp (if used) to envelope the fumigated items. See the chapter on Fumigation Preparation for information on tarps and sealing methods. Monitoring these fumigations is recommended since the HLT may be difficult to estimate using the Fumiguide system.

Tarp/stack fumigations must be conducted outdoors or in a building that must comply with all requirements for a structural fumigation (removal of people, pets and plants, use of warning agent, posting of warning signs, etc.).

Tarp/stack fumigations must be conducted outdoors or in a building that will not be occupied during fumigation and aeration periods.

VEHICLES, VESSELS, AND CONTAINERS

Vikane is not registered for the treatment of aircraft or underwater vessels.

Passenger railcars and empty and loaded shipping containers, trucks, automobiles, busses, recreational vehicles (including campers and trailers), surface ships, and other transport vehicles or vessels may be fumigated in essentially the same manner as small structures. Monitoring these fumigations is recommended since the HLT may be difficult to estimate using the Fumiguide system. Automobiles may remain in garages that are being fumigated; however, the applicator must be able to inspect all areas of the vehicle (including the trunk) prior to fumigant introduction.

In-transit fumigation (including aeration) of any vehicle is prohibited on public roads or waterways. Do not move a vehicle while under fumigation.

Follow all local, state and federal regulations covering the fumigation of vehicles and vessels.

Selection of Fumigation Location

Place vehicles, containers, and vessels in a location that is appropriate for conducting a fumigation away from other work areas. Small pleasure boats may either be removed from the water and fumigated on land or fumigated in the water. Large vessels, such as houseboats, and ocean-going vessels, such as freighters and cruise ships, can be fumigated in the water at dockside.

Securing the Vehicle, Vessel, or Container

Secure the vehicle to prevent entry by unauthorized person using normal means during the fumigation. It is also advised that secured by setting the brakes and blocking the wheels so that the vehicle will not move during the fumigation and aeration periods.

Surface Ships

Follow all local, state, and federal requirements for ship fumigation, including those required by the United States Department of Transportation, Chapter 1, Parts 147A.1-147A.43 in the Code of Federal Regulations, Section 46 Shipping and the label for Vikane. Since the codes listed are for fumigants in general, do not use procedures that are not permissible for Vikane as directed by label instructions and regulations. The certified applicator and ship's captain or owner shall follow the requirements listed on the label for Vikane and local and state requirements. Except for those persons involved in the fumigation, no unauthorized persons may be on board during fumigation.

Fumigation of Vessels on Water

If vessels are sealed by tarping, it is common practice to extend the tarps below the water surface, unless restricted by local or state regulations, taking into consideration the change in water level in tidal water and how this may affect tarps sealed around the lines mooring the boat to the dock. Water acts as an excellent barrier for the Vikane because of its low water solubility. When using the Fumiguide System to estimate HLT for fumigations in water, experience has demonstrated that using the slab rating to describe the water underseal is appropriate.

Securing Passenger Railcars

Follow either Procedure #1 or Procedure #2 for securing railcars.

Procedure #1: A thorough walk through inspection must be performed of each railcar with doors being immediately locked upon leaving each car. Post a guard during fumigation introduction, exposure period, and aeration. Because a guard is posted, application of a warning agent is not required for passenger railcars.

Procedure #2: A thorough walk through inspection must be performed of each railcar with doors being immediately locked upon leaving each car. If no guard is posted, then apply a warning agent following instructions per label directions. To secure the passenger railcar against unauthorized entry during the fumigation exposure period, use a locking device or barricade on all exterior doors or doorways. A locking device or barricade must be demonstratively effective in preventing an exterior door or doorway from being opened using normal opening or entering processes by anyone other than the state licensed applicator in charge of the fumigation or persons in his/her on-site direct supervision. Consult state and local regulations for any supplementary instructions and local restrictions on securing against entry.