



UNITED STATES ENVIRONMENTAL PROTECTION AGENCY
WASHINGTON, DC 20460

OFFICE OF CHEMICAL SAFETY
AND POLLUTION PREVENTION

May 4, 2021

Abigail T. D. Wacek
Regulatory Agent to King Technology Inc.
King Technology
530 11th Avenue South
Hopkins, MN 55343

Subject: Label Amendment – Updating directions for use and optional label claims
Product Name: Pool Frog Mineral Reservoir
EPA Registration Number: 53735-11
Application Date: May 19, 2020
Action Case Number: 00218819

Dear Ms. Wacek:

The amended label referred to above, submitted in connection with registration under the Federal Insecticide, Fungicide and Rodenticide Act (FIFRA), as amended, is acceptable. This approval does not affect any conditions that were previously imposed on this registration. You continue to be subject to existing conditions on your registration and any deadlines connected with them.

A stamped copy of your labeling is enclosed for your records. This labeling supersedes all previously accepted labeling. Pursuant to 40 CFR 156.10(a)(6) you must submit one copy of the final printed labeling before you release the product for shipment with the new labeling. In accordance with 40 CFR 152.130(c), you may distribute or sell this product under the previously approved labeling for 18 months from the date of this letter. After 18 months, you may only distribute or sell this product if it bears this new revised labeling or subsequently approved labeling. “To distribute or sell” is defined under FIFRA section 2(gg) and its implementing regulation at 40 CFR 152.3.

Should you wish to add/retain a reference to the company’s website on your label, then please be aware that the website becomes labeling under FIFRA and is subject to review by the Agency. See FIFRA section 2(p)(2). If the website is false or misleading, the product would be misbranded and unlawful to sell or distribute under FIFRA section 12(a)(1)(E). 40 CFR 156.10(a)(5) lists examples of statements EPA may consider false or misleading. In addition, regardless of whether a website is referenced on your product’s label, claims made on the website may not substantially differ from those claims approved through the registration process, FIFRA section 12(a)(1)(B). Therefore, should the Agency find or if it is brought to our attention that a website contains false or misleading statements or claims substantially differing from the EPA approved registration, the website will be referred to the EPA’s Office of Enforcement and Assurance.

Page 2 of 2
EPA Reg. No. 53735-11
Action Case Number/Decision No. 00218819

Your release for shipment of the product constitutes acceptance of these conditions. If these conditions are not complied with, the registration will be subject to cancellation in accordance with FIFRA section 6. If you have any questions, please contact Aidan Fife by phone at 703-347-8522, or via email at fife.aidan@epa.gov.

Sincerely,

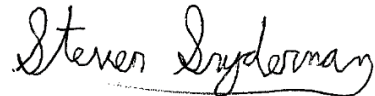
A handwritten signature in black ink that reads "Steven Snyderman". The signature is written in a cursive style with a horizontal line underneath the name.

Steven Snyderman, Product Manager 33
Regulatory Management Branch II
Antimicrobials Division (7510P)
Office of Pesticide Programs

Enclosure: Accepted label

[All text in braces {xxx} is optional and may or may not be included on a final label.]
[All text in brackets [xxx] is administrative and will not appear on a final label.]

[Master Label] Pool Frog Mineral Reservoir

[Alternate Brand Name: Aqua Smarte Mineral Reservoir]
[Alternate Brand Name: Instant Frog]
[Alternate Brand Name: Spa Frog]
[Alternate Brand Name: Spa Frog Mineral Spa Care]
[Alternate Brand Name: Spa Frog Mineral Cartridge]
[Alternate Brand Name: Spa Frog Floating System]
[Alternate Brand Name: Pool Frog Mineral Cartridge]
[Alternate Brand Name: Filter Frog]
[Alternate Brand Name: Pool Frog Value Pack]
[Alternate Brand Name: Aqua Smarte Value Pack]
[Alternate Brand Name: Frog Mineral Pac]
[Alternate Brand Name: Frog Min Pac]
[Alternate Brand Name: Frog Leap Mineral A-SALT!]
[Alternate Brand Name: Frog Leap Mineral ASSAULT!]
[Alternate Brand Name: Frog Leap Anti-Bac Mineral Pac]
[Alternate Brand Name: Frog Leap Mineral Element]
[Alternate Brand Name: Aqua Smarte Mineral A-SALT!]
[Alternate Brand Name: Aqua Smarte Mineral ASSAULT!]
[Alternate Brand Name: Aqua Smarte Mineral Element]
[Alternate Brand Name: Aqua Smarte Plus Mineral Activator]
[Alternate Brand Name: Frog Pool Boy]
[Alternate Brand Name: Frog Sentry]
[Alternate Brand Name: Frog Jr. Pool Boy]
[Alternate Brand Name: Frog Jr. Sentry]
[Alternate Brand Name: Frog Splasher Pool Boy]
[Alternate Brand Name: Frog Splasher Sentry]
[Alternate Brand Name: Frog Pop Up Pool Sanitizer]
[Alternate Brand Name: Frog Pop Up Pool Sanitizer Plus]
[Alternate Brand Name: Pop Up Pool Sanitizer]
[Alternate Brand Name: Pop Up Pool Sanitizer Plus]
[Alternate Brand Name: Frog Pop-Up Pool Sanitizer]
[Alternate Brand Name: Frog Pop-Up Pool Sanitizer Plus]
[Alternate Brand Name: Pop-Up Pool Sanitizer]
[Alternate Brand Name: Pop-Up Pool Sanitizer Plus]
[Alternate Brand Name: Flippin' Frog]
[Alternate Brand Name: Flippin' Frog Mineral Cartridge]
[Alternate Brand Name: Flippin' Frog XL]
[Alternate Brand Name: Flippin' Frog 2XL]
[Alternate Brand Name: @ease Mineral Cartridge]
[Alternate Brand Name: @ease Floating Sanitizing System]
[Alternate Brand Name: @ease In-Line Sanitizing System]
[Alternate Brand Name: FROG @ease In-Line Sanitizing System]
[Alternate Brand Name: FROG @ease Floating Sanitizing System]
[Alternate Brand Name: FROG @ease Mineral Cartridge]
[Alternate Brand Name: FROG Serene Floating Sanitizing System]
[Alternate Brand Name: FROG Serene Mineral Cartridge]
[Alternate Brand Name: FROG Filter Mate]

[Front Panel]

POOL FROG MINERAL RESERVOIR

{PATENTED} MINERAL {POOL} {SPA} {HOT TUB} {SANITIZER} {DISINFECTANT}
{REPLACEMENT}

{The Complete Low Chlorine Alternative+}
{The Complete Low Bromine {or Chlorine} Alternative+}

{The Frog Mineral {System} {Technology} {Formula}+ reduces {chlorine} {bromine} use up to 50%*}
{Up To 50%* Chlorine Reduction with Frog Mineral System}
{Up to 50% reduction in {bromine} or {chlorine} use*}

{Eliminates daily dosing for less work}

{The Frog Mineral {System} {Technology} {Formula}+ Improves Water Quality By:}

- {Destroying bacteria for improved clarity}
- {Helping to maintain a neutral pH}
- {Reducing {chlorine} {bromine} use for softer water}

{Frog now comes with water polishers for easier pool startup.} {with Start-Up Water Polishers}

{Fresh mineral water[∞]}
{[∞] for {pools} {spas} {hot tubs}}

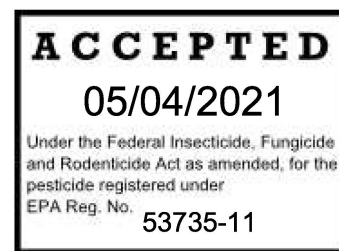

KEEP OUT OF REACH OF CHILDREN

CAUTION

{See {Side Panel or} Enclosed {Product Label and} Instruction Manual for Complete Directions for Use}

Active Ingredient:

Silver Chloride ----- 0.5%
Other Ingredients: ----- 99.5%
Total: ----- 100.0%

Net Wt.: _____ {lbs} {oz} {grams}
EPA Reg. No.: 53735-11
EPA Est. No.: xxxxx-xx

Manufactured by: King Technology, Inc., 530 11th Ave. South, Hopkins, MN 55343
{kingtechnology.com} {frogproducts.com} {800-222-0169}

[Disclosure Statements 1 for Product Description #1: Pool Cartridge, Product Description #2: Skimmer Application, Product Description #5: Floating Pool Cartridge and Product Description #6: Cartridge for Bulk Chlorinator]

+ FROG Mineral {System} {Technology} {Formula} consists of the {FROG} minerals silver chloride and carbonate used in conjunction with 0.5 ppm chlorine. The Pool Frog Mineral Reservoir {cartridge} {pac} must be used in conjunction with {53735-2 Brand Name}, {an EPA registered chlorine pool product or a chlorine delivery device}.

*Compared to the minimum EPA recommended chlorine level of 1.0 ppm for a stabilized swimming pool.

[Disclosure Statements 2 for Product Description #3: Spa Cartridge for In-Line or Floating System, Product Description #4: Filter Spa Product – all products used with 53735-10 or 53735-16]

+ FROG Mineral {System} {Technology} {Formula} consists of the FROG minerals silver chloride and carbonate used with 1.0 ppm bromine {or chlorine}. The Pool Frog Mineral Reservoir {cartridge} {pac} must be used in conjunction with {the {53735-10 or 53735-16 Brand Name} {(EPA Reg. No. 53735-10)} {(EPA Reg. No. 53735-16)},} an EPA registered bromine {or chlorine} {spa} {hot tub} product or a bromine {or chlorine} delivery device.

*Compared to the minimum ANSI recommended {bromine} or {chlorine} level of 2.0 ppm for a {spa} {hot tub}.

[Disclosure Statements 3 for Product Description #7: Spa Floating/Flipping System, Product Description #8: Spa In-Line System, Product Description #9 Spa Filter Well Systems – all products used with 53735-14]

+ FROG {Mineral} {System} {Technology} {Formula} consists of the FROG minerals silver chloride and carbonate used with 0.5 ppm of {53735-14 Brand Name}. The Pool Frog Mineral Reservoir must be used in conjunction with the {53735-14 Brand Name}.

*Compared to the minimum ANSI recommended {bromine} or {chlorine} level of 2.0 ppm for a {spa} {hot tub}.

[Product Description 1 and Directions for Use for Pool Cartridge with 53735-2 Brand Name]

Product Description: The Pool Frog Mineral Reservoir is the heart of an advanced pool care system that destroys bacteria. The {patented} mineral formula in the Pool Frog Mineral Reservoir {is a disinfectant that} also neutralizes acids, which helps keep the pH in an acceptable range with less monitoring. The controlled release of minerals provides an optimum level of protection in your pool. The Frog Mineral {System} {Technology} {Formula}+ reduces chlorine use up to 50%*. Simply use with at least 0.5 ppm of an EPA registered source of chlorine such as the {53735-2 Brand Name} or a chlorine delivery device. Using the Pool Frog Mineral {System} {Technology} {Formula}+ improves {swimming pool pleasure} {your swimming experience} by reducing the problems associated with chlorine including faded bathing suits, premature damage to pool equipment or surfaces and smelly odors. With the Pool Frog Mineral Reservoir, pool care is easy and effective. Once wetted, the time-released mineral coating of this product is effective up to 6 consecutive months or one pool season, whichever is shorter. After that time, even if upon shaking you hear the spent media inside, it is no longer effective and must be replaced. Mark the calendar with stickers provided to replace this product.

Replace the Pool Frog Mineral Reservoir after 6 months.

It is a violation of Federal Law to use this product in a manner inconsistent with its labeling.

Directions For Use with {53735-2 Brand Name}: For {use in} {in-ground} {above ground} pools up to {15,000} {20,000} {25,000} {30,000} {35,000} {40,000} gallons. For a complete system, use this product inside the {Cycler} {chlorinator} {feeder} along with the {53735-2 Brand Name}. This product is compatible with pool chemicals except biguanides. Before inserting the Pool Frog Mineral Reservoir as the pool maintenance product, balance the pH to between 7.2 and 7.8 and total alkalinity between 80-120 ppm and shock the pool with a {chlorine shock per the manufacturer's directions.} {shock pac per its label directions.} Then follow the {se} directions {below}:

1. Turn circulation pump off, {turn control dial to {Pac Removal}, Setting {0} or {Off} depending on your model and remove cap} {from Cycler} {chlorinator} {feeder}.
2. {Line up slot on the side of the Pool Frog Mineral Reservoir with the fin inside the Cycler and} lower {Pool Frog Mineral Reservoir} into the {Cycler} {chlorinator} {feeder}.
3. If using the {53735-2 Brand Name}, insert {into the center of this product} according to the directions on its label then replace the cap on the {Cycler} {chlorinator} {feeder} and turn pump back on. {Set the control dial on the {Cycler} {chlorinator} {feeder} per the size and pump run time of your pool according to the chart in the manual.}

Directions for Use with Alternate Source of Chlorine: If using an alternative EPA registered source of chlorine, follow steps 1 and 2 above then replace the {Cycler} {chlorinator} {feeder} cap, {set the control dial to {Maximum}, Setting {10} {5} or {On} depending on your model} and turn pump back on. Maintain recommended chlorine levels of 0.5 to 1.0 ppm in the pool.

DO NOT USE ANY OTHER {PAC} {CHLORINE CHAMBER} OR BULK CHEMICAL INSIDE THE MINERAL RESERVOIR. DAMAGE TO THE RESERVOIR, POOL OR OTHER EQUIPMENT COULD RESULT.

[Product Description 2 and Directions for Use for Skimmer Application]

Product Description: Pool Frog Mineral Reservoir destroys bacteria. The {patented} mineral formula in the Pool Frog Mineral Reservoir {is a disinfectant that} also neutralizes acids, which help keep the pH in an acceptable range with less monitoring. The controlled release of minerals provides optimum protection in the pool. The Frog Mineral {System} {Technology} {Formula}+ reduces chlorine use up to 50%*. Use Pool Frog Mineral Reservoir with at least 0.5 ppm of an EPA registered source of chlorine or a chlorine delivery device. Using the Frog Mineral {System} {Technology} {Formula}+ with reduced chlorine levels improves {swimming pool pleasure} {your swimming experience} by reducing the problems associated with chlorine including faded bathing suits, premature damage to pool equipment or surfaces and smelly odors. With Pool Frog Mineral Reservoir, pool care is easy and effective. Once wetted, the time-released mineral coating of this product is effective up to 6 consecutive months or one pool season whichever is shorter. After that time, even if upon shaking you hear the spent media inside, it is no longer effective and must be replaced.

Replace the Pool Frog Mineral Reservoir after 6 months.

It is a violation of Federal Law to use this product in a manner inconsistent with its labeling.

Directions for Use: For in-ground pools up to 25,000 gallons. This product is compatible with pool chemicals except biguanides. Before using Pool Frog Mineral Reservoir as the pool maintenance product, balance the pH to between 7.2 and 7.8 and total alkalinity between 80-120 ppm and shock the pool with a chlorine shock per the manufacturer's directions. Then follow the directions below:

1. Set reminder dial on Pool Frog Mineral Reservoir to 6 months from date of installation. Turn dial by hand or with a coin if needed.
2. Remove {skimmer cover} {pump lid}.
3. {Remove skimmer basket handle if necessary and} {insert} {drop} Pool Frog Mineral Reservoir into the {skimmer} {pump} basket.
4. {If using Pool Frog Mineral Reservoir with a suction side automatic cleaner installed through the skimmer, it will be necessary to use a vac plate that may come with the skimmer or automatic cleaner.}
5. Once installed, maintain recommended chlorine levels of 0.5 to 1.0 ppm in the pool by using an EPA registered source of chlorine approved specifically for swimming pools or a chlorine delivery device.

[Product Description 3 and Directions for Use for Spa Cartridge with 53735-10 or 53735-16 Brand Name]

For use in the {In-Line System} {or the} {Floating System}

Product Description: The Pool Frog Mineral Reservoir is a disinfectant that contains a {patented} mineral formula that destroys bacteria while neutralizing acids, which helps keep the pH in an acceptable range with less monitoring. Using the Frog Mineral {System} {Technology} {Formula}+ with reduced levels of {bromine} improves {spa} {hot tub} pleasure {by reducing the problems associated with {bromine} including faded bathing suits, premature damage to {spa} {hot tub} equipment or surfaces and smelly odors}.

Replace the Pool Frog Mineral Reservoir after 4 months or when draining and refilling {spa} {hot tub} with fresh water.

It is a violation of Federal Law to use this product in a manner inconsistent with its labeling.

Directions for Use: For use in {spas} {hot tubs} up to {500} {600} gallons. Use Pool Frog Mineral Reservoir with the {53735-10 or 53735-16 Brand Name} in {either} the {In-Line System} {or} {Floating System}. Ensure all {spa} {hot tub} equipment is working properly. {Operate the pump and filter {for at least 3 hours per day} {as recommended by your hot tub manufacturer}.} {The pump and filter should be operated at least 3 hours per day.} Clean filter following manufacturer's directions. Adjust pH to between 7.2 – {7.6} {7.8}. {With a freshly filled {spa} {hot tub},} {Begin with} {Establish} a bromine or chlorine residual of 1.0-2.0 ppm {with} {from} {{53735-12 Brand Name} start-up shock {that came in the package}} {an EPA approved {spa} {hot tub} shock} {or by other means} following the directions on that product.

Always maintain a bromine residual of at least 1.0 ppm. Shock {spa} {hot tub} {with Brand Name} once a week or if the water looks cloudy. {When using other products as outlined in directions for this product, always follow directions on those products. Keep the {spa} {hot tub} free of leaves and debris.}

Setting Pool Frog Mineral Reservoir: While holding the bottom of the cartridge, turn the top until the number 6 appears in the setting window. {This cartridge may be used in {one of} the following application{s}:}

{Using the In-Line System: Open cap of In-Line System. Push down and turn cartridge holder counter-clockwise to unlock. Pull holder out. Snap the Pool Frog Mineral Reservoir into the area marked "Minerals" (top portion) making sure to line up the indentation near the top of the cartridge with the raised line on the holder. For best results insert the {53735-10 or 53735-16 Brand Name} in the area marked "Bromine or SmartChlor" (bottom portion). When cartridge is snapped in, replace holder by lining up arrow on handle with arrow on system lip, push down and lock in place. Replace cap.}

{Using the Floating System: Push the Pool Frog Mineral Reservoir into the bottom opening of the floating system. For best results insert the {53735-10 or 53735-16 Brand Name} into the other opening. Set entire system in the {spa} {hot tub} water.}

[Product Description 4 and Directions for Use for Filter Spa Product]

Product Description: Pool Frog Mineral Reservoir {is a disinfectant that} contains a {patented} mineral formula that destroys bacteria while neutralizing acids, which helps keep the pH in an acceptable range with less monitoring. Using the Frog Mineral {System} {Technology} {Formula}+ with reduced levels of {bromine} {or chlorine} improves {spa} {hot tub} pleasure {by reducing the problems associated with bromine {or chlorine} including {faded} {fading} bathing suits, premature damage to {spa} {hot tub} equipment or surfaces and smelly odors}.

Replace Pool Frog Mineral Reservoir after 4 months or when draining and refilling {spa} {hot tub} with fresh water.

It is a violation of Federal Law to use this product in a manner inconsistent with its labeling.

Directions for Use: For use in {spa}s {hot tubs} up to {500} {600} gallons. Ensure all {spa} {hot tub} equipment is working properly. {Operate the pump and filter for at least 3 hours per day.} {The pump and filter should be operated at least 3 hours per day.} Clean filter following manufacturer's directions. Adjust pH to between 7.2 – {7.6} {7.8}. With a freshly filled {spa} {hot tub}, establish a bromine or chlorine residual of 1.0-2.0 ppm with {an EPA approved {spa} {hot tub} shock} {or by other means} {a start-up {spa} {hot tub} shock packet}. Always maintain a {bromine} {or chlorine} residual of at least 1.0 ppm. Shock {spa} {hot tub} {with Brand Name} once a week or as needed. When using other products as outlined in directions for this product, always follow directions on those products. Keep the {spa} {hot tub} free of leaves and debris.

Installing Pool Frog Mineral Reservoir: {Set reminder dial to four months from month of installation. Turn dial by hand or with a coin if needed.} {Mark your calendar with enclosed reminder sticker for the 4 month replacement date.} {Set for 4 months} Place Pool Frog Mineral Reservoir in one of the following locations:

- a. Majority of {Spas} {Hot Tubs}: insert Pool Frog Mineral Reservoir inside filter cartridge core. Do not allow product to sit too low in the filter. If blocking water flow, install in filter well. If installed inside a standpipe, attach a string to the {handle on top} {Frog head handle} for easy removal.
- b. High Flow {Spas} {Hot Tubs}: on skimmer filters with 2.5 HP or larger pump motors, place Pool Frog Mineral Reservoir in filter well outside the filter cartridge.
- c. Small Cartridge or Other {Spas} {Hot Tubs}: place Pool Frog Mineral Reservoir in skimmer tray.

[Product Description 5 and Directions for Use for Floating Pool Cartridge with 53735-2 Brand Name]

Product Description {For Pool Frog Mineral Reservoir Mineral{s} {Cartridge}}: Pool Frog Mineral Reservoir is a disinfectant that {part of a complete {pool} {water} care system} {mineral sanitizing pool care} {pool care with sanitizing minerals} {sanitizing mineral pool care} {for {pop up} {splasher} {small above ground} {easy set} {quick set} {metal frame} {oval frame} {ultra frame} {frame} {set} pools} {and swim spas} that {uses the} {utilizes a} {patented} mineral formula with {low{er}} {reduced} levels of chlorine to destroy bacteria, help maintain {a neutral} pH {with less monitoring} and restore water clarity. Use with the chlorine {half} {hemisphere} {replacement} {cartridge} {pac} {recharge} and simply {connect.} {turn} {twist} to set {the dial} {and} {then} {toss into} {plop in} {tether to} the pool {or swim spa}. Everything is prefilled and contained {{for} no mess, no guess {and} no stress {{pool} {water} care}}. {The best part is it flips over when {empty} {out} {time to replace a {chlorine} cartridge.} {Hey! Less Work Hey! Less Chlorine Hey! Less Money.} {Plus minerals reduce chlorine use up to 50% which {helps} prevent{s} faded {bleached} {swim}suits, premature damage to {pool} equipment or surfaces and smelly odors}.

It is a violation of Federal law to use this product in a manner inconsistent with its labeling.

[NOTE TO REVIEWER: THERE ARE SEVERAL PRODUCTS COVERED UNDER THESE DIRECTIONS FOR USE – EACH ONE COVERS A DIFFERENT GALLON RANGE. OUT OF THESE OPTIONS, WE WILL ONLY USE THE APPROPRIATE RANGE FOR EACH PRODUCT LABEL].

Directions For Use: For use in {{above ground} {or} {in ground} pools {up to {12'} {15'} {16'} {18'} {20} {21} in diameter} {or} {approximately {3000} {4000} {5000} {6000} {8000} {10,000} gallons} {between {1000} {2000} {5000} and {5000} (6000) {10,000} gallons}.} {May also be used in swim spas approximately {1000} {1500} to {2000} {2500} 3000} {3500} gallons. {Not recommended for pools under {1000} {2000} {5000} gallons}. {Use one per {5000} {10,000} gallons.} {Check the package to ensure you have the right Pool Frog Mineral {Reservoir} {System} {or} {chlorine recharge} {cartridge} for your size pool {or swim spa}.} Ensure all {pool} equipment is working properly with adequate circulation per the {pool} manufacturer. Balance the water's pH to between 7.2 and 7.8. Shock {pool} {the water} to remove contaminants (follow manufacturer's directions).

[Assembly Option #1]

{To assemble: Remove the outer packaging {before using {the Pool Frog Mineral {Reservoir} {System} {or} {chlorine recharge} {this cartridge}}. Bring the {insert color} mineral and {insert color} chlorine {halves} {hemispheres} {cartridges} {pacs} {pieces} {sections} together {with {arrows} {alignment marks} {tick marks} {icons} {water drops} {snaps} aligned along the edge of both {halves} {cartridges}} {with the arrow on the chlorine cartridge lined up with the {unlock symbol} {catches} on the Pool Frog Mineral Reservoir} {(see Figure A)}. {Push together and twist {the bottom cartridge x degrees} to {lock} {the lock {symbol} {position}}. {Rotate the two cartridges until you hear the {safety} {locking} tab click into place.} {Rotate the two {halves} {hemispheres} {cartridges} {pacs} {pieces} {sections} opposite of each other {(see Figure B)} until the {recommended} initial setting for your pool {or swim spa} size {appears in the setting window} {is lined up with the {arrow} {alignment mark} {tick mark} {icon} {water drop}.} {see Figure C)} {(see chart in {Brand System} manual)}. {For example, the} most common pool size {of} 15' {diameter}, 4000 gallons {would start on} setting #5.}

[Assembly Option #1A]

{Align the bottom {chlorine} cartridge with {marks} {arrows} {symbols} {tab guides} on the top {mineral} cartridge. Push in until you hear {it {click} {snap} into place} {the tab guides engage}.} {Line up the {features} {snaps} {marks} {tab guides} on the two cartridges and push together until you hear the cartridge click into place.} {Twist the dial on the {bottom} {chlorine} cartridge to the setting {number} for your pool {or swim spa} size (see chart).} {Start with the {factory} {middle} {medium} {center} setting. If you find less chlorine is needed turn the dial to {the} {a} lower setting –if more is needed turn it to {the} {a} higher setting.} Even at the lowest setting {of 0} there will be some chlorine released into the {pool} {water}.

Once set, place directly in the {pool} {or swim spa}. {With the cord provided} {Tether it to the pool {side} {or ladder} {with {a string} {the cord} {provided} through the {loop} {hole} in the product}.} {For swim spas do not tether the product but allow it to free float.} Initially test {the} water {daily} {for chlorine} {using} {with} {Brand} Test Strips {or a recognized swimming pool test kit or testing device}. Adjust the {system up or down by one setting per day} {setting if necessary} until the ideal free available chlorine (FAC) range of 0.5 to 1.0 ppm is maintained. {You may remove} product from pool when in use.} {You must remove from swim spas when in use due to high jet action that could deplete the chlorine cartridge prematurely.}}

[Assembly Option #2]

{To assemble: Remove outer packaging

- Align arrows on {insert color} mineral and {insert color} chlorine cartridges (see Figure A {below})
- Push together and rotate to connect (see Figure # {below})
- Find setting from initial setting chart (see Figure # {below})
- Lock in setting and place in pool (see Figure # {below})
- {Attach cord and tether to pool or ladder}
- Maintain 0.5 to 1.0 ppm free chlorine level
- Initially test water with {Brand} Test Strips daily
- Adjust setting if needed one number per day
- {Product may be removed when pool is in use}
- {Product must be removed from swim spas when in use}}
- Shock pool as needed to maintain water clarity

When the {complete {Brand} System} {Pool Frog Mineral Reservoir} {flips} {rolls} over the chlorine {half} {cartridge} is empty and must be replaced.

To remove, {rotate the two {halves} {hemispheres} {cartridges} {pacs} {pieces} {sections} until the {arrows} {alignment marks} {tick marks} {icons} {water drops} align along the edge of both {halves} {cartridges} (see Figure A) and pull apart}.

{To remove the {bottom} {chlorine} cartridge, release the {safety} {locking} tab by pulling or pushing the release with your finger.} {To release the {bottom} {chlorine} cartridge, squeeze the tabs and pull the empty cartridge out.}

{If the Pool Frog Mineral Reservoir has not been used for 6 months or one pool season whichever is shorter, simply attach a new chlorine {brand} {half} {hemisphere} {replacement} {cartridge} {pac} {recharge} and set the complete system back in the water.} Do not allow chlorine cartridge to sink to the bottom or pool/swim spa} bleaching may occur.

If the chlorine {brand} {half} {hemisphere} {replacement} {cartridge} {pac} {recharge} still contains a small amount of chlorine after the system has {flipped} {rolled} over, place in {pool {or swim spa} until completely empty} {hang on the tether via the {hook} {loop} on the side of the cartridge {until completely empty}. {Once the Pool Frog Mineral Reservoir has been used for 6 months or one pool season whichever is shorter, the minerals are no longer active. Replace the entire Pool Frog Mineral {System} {Reservoir} and discard the mineral {half} {hemisphere} {cartridge} {pac} {piece} {section} in the trash.}

[The following copy is engraved on the Floating Pool Cartridge plastic container]

Not A Toy

No es un juguete

Keep Out of Reach of Children

CAUTION

EPA Reg. No.: 53735-11{-xxxxx}

{kingtechnology.com} [OR] {heycoolpool.com}

{U.S. & Foreign patents pending}

{Patents} {Patent Pending}: {www.kingtechnology.com/IP} [OR] {www.heycoolpool.com/IP}

King Technology: Pool Frog Mineral Reservoir EPA Reg. No. 53735-11

Label Version **May 18, 2020-3**

Page 9 of 105

[Product Description 6 and Directions for Use for Cartridge for Bulk Chlorinator with 53735-2 Brand Name]

Product Description: Pool Frog Mineral Reservoir is a disinfectant that is part of a complete pool care system that works inside an {Hayward®} {Rainbow®} chlorinator utilizing a {patented} mineral formula with low levels of chlorine to destroy bacteria, help maintain pH and restore water clarity. The {Brand} Mineral {System} {Technology} {Formula}+ reduces chlorine use up to 50%*. Simply use with the {53735-2 Brand Name} by {attaching} {connecting} {latching} the two pacs together and inserting in the center of a {Hayward®} {Rainbow®} {or equivalent} chlorinator. Using the Pool Frog Mineral {System} {Technology} {Formula}+ improves {swimming pool pleasure} {your swimming experience} by reducing the problems associated with chlorine including faded bathing suits, premature damage to pool equipment or surfaces and smelly odors.

Replace the Pool Frog Mineral Reservoir after 6 months.

It is a violation of Federal Law to use this product in a manner inconsistent with its labeling.

Directions For Use: For use inside {Hayward®} chlorinator models CL200 and CL220} {Rainbow®} chlorinator models 300 and 320} {or equivalent chlorinators} for pools up to {10,000} {15,000} {20,000} {25,000} {30,000} {35,000} {40,000} gallons. Pool Frog Mineral Reservoir must be used with the {53735-2 Brand Name}. Before using, balance the pH to between 7.2 and 7.8 and total alkalinity between 80-120 ppm and shock the pool with a {chlorine shock per the manufacturer's directions.} {shock pac per its label directions.} Make sure the chlorinator is completely empty of chemical. Never mix chemicals. If used previously with a chemical other than Trichlor, clean inside of chlorinator thoroughly. Then follow the directions below:

1. {Remove {tape} {foil} covering the water holes on the bottom and {side of}} {Remove plug from side of} the {53735-2 Brand Name}.
2. Connect the Pool Frog Mineral Reservoir to the {53735-2 Brand Name} by bringing the two pieces together, lining up the arrows and turning the {53735-2 Brand Name} clockwise until locked in place.
3. Turn circulation pump off, turn the {Hayward®} {Rainbow®} chlorinator dial to off and remove its cap.
4. {Lift} {Use} handle {and} {to} insert the complete system into the {Hayward®} {Rainbow®} chlorinator by lining up the short square channel on the Pool Frog Mineral Reservoir with the dial side of the chlorinator. Lower until seated. The cap will not close properly if the product is not seated correctly. Lift up and reinsert until seated properly.
5. Replace the cap on the {Hayward®} {Rainbow®} chlorinator and turn pump back on. Set the control dial according to the chart in the manual. When using the Pool Frog Mineral Reservoir maintain a free available chlorine (FAC) level of 0.5 ppm to 1.0 ppm. Adjust the chlorinator dial to increase or decrease chlorine output.
6. {If using Algaecide Pac. Before attaching the {53735-2 Brand Name} (step 2) {push} {screw} {affix} {insert} algaecide {pac} {container} {bottle} {on} {in} to the {chlorinator} {adapter that attaches to the} {Pool Frog Mineral Reservoir} {while inside the chlorinator} {then insert into chlorinator}. Replace cap, turn dial full open and run for 90 minutes. Remove algaecide bottle and discard or recycle.}

[Product Description 7 and Directions for Use for {Spa} {Hot Tub} Floating/Flipping System with 53735-14 Brand Name]

Product Description: A complete two part system for {hot tubs} {spas} {swim spas} up to {500} {600} {3000} gallons consisting of Pool Frog Mineral Reservoir disinfectant and {53735-14 Brand Name} which together provides Fresh Mineral Water[∞] that is cleaner because it kills bacteria two ways, clearer because the minerals help keep the pH in an acceptable range with less monitoring and softer because minerals condition the water and with 75% less chlorine*, the water feels soft and doesn't fade swimsuits, damage equipment or create smelly odors.

Replace the Pool Frog Mineral Reservoir after 4 months or when draining and refilling {spa} {hot tub} with fresh water.

It is a violation of Federal Law to use this product in a manner inconsistent with its labeling.

Directions for Use: For use in {spas} {hot tubs} {swim spas} up to {500} {600} {3000} gallons. Use with the {53735-14 Brand Name}. Ensure all {spa} {hot tub} {swim spa} equipment is working properly. Operate the pump and filter {for at least 3 hours per day} {as recommended by your hot tub manufacturer}. Clean filter following manufacturer's directions. May be used with a previously filled {spa} {hot tub} {swim spa} unless it was sanitized with bromine or biguanides. Then drain and fill the {spa} {hot tub} {swim spa} with fresh water {before using this product}.

Read entire operating instructions for complete directions for use.

[The following copy is engraved into the plastic container]

Not a toy

No es un juguete

Keep Out of Reach of Children

CAUTION

EPA Reg. No.: 53735-11{-xxxxx}

{kingtechnology.com} [OR] {heycoolpool.com}

{U.S. & Foreign patents pending}

{Patents} {Patent Pending}: {kingtechnology.com/IP} [OR] {heycoolpool.com/IP}

[Protective Seal Copy:]{Remove this {seal} {label} before use. Hold over the {hot tub} {spa} and allow any {fines} {particles} to dissolve in the water.}

[Product Description 8 and Directions for Use for {Spa} {Hot Tub} In-Line System with 53735-14 Brand Name]

Product Description: A complete two-part system consisting of Pool Frog Mineral Reservoir disinfectant and {53735-14 Brand Name} for {hot tubs} {spas} up to {500} {600} gallons. This system provides Fresh Mineral Water[∞] that is cleaner because it kills bacteria two ways, clearer because the minerals help keep the pH in an acceptable range with less monitoring and softer because minerals condition the water. With 75% less chlorine*, the water feels soft and doesn't fade swimsuits, damage equipment or create smelly odors.

Replace the Pool Frog Mineral Reservoir after 4 months or when draining and refilling {spa} {hot tub} with fresh water.

It is a violation of Federal Law to use this product in a manner inconsistent with its labeling.

Directions for Use: For use in {spas} {hot tubs} up to {500} {600} gallons. Use Pool Frog Mineral Reservoir with the {53735-14 Brand Name} in the {brand} {In-Line} {Sanitizing} System. Ensure all {spa} {hot tub} equipment is working properly. Operate the pump and filter {for at least 3 hours per day} {as recommended by your hot tub manufacturer}. Clean filter following manufacturer's directions. May be used with a previously filled {spa} {hot tub} unless it was sanitized with bromine or biguanides. Then drain and fill the {spa} {hot tub} with fresh water before using this product.

{Start-up:} {Adjust} {Balance the water according to the water balance guidelines with} pH {to} between 7.2 – {7.6} {7.8} {and Total Alkalinity {between} {at} 80 and 120}. {With a freshly filled {spa} {hot tub},} {After balancing} {Begin with} {Establish} {a free chlorine residual of 0.5-1.0 ppm} {with} {from} {{53735-12 Brand Name} start-up shock {that came in the package} {an EPA approved {spa} {hot tub} shock} {or by other means} following the directions on that product.

Always maintain a {free} chlorine residual with {53735-14 Brand Name} of 0.5 to 1.0 ppm. Shock {spa} {hot tub} {with Brand Name} {once a week or as needed} {when you replace a {53735-14 Brand Name} or once a month}. {When using other products as outlined in directions for this product, always follow directions on those products. Keep the {spa} {hot tub} free of leaves and debris.}

Setting Pool Frog Mineral Reservoir: While holding the bottom of the cartridge, turn the top until the number 6 appears in the setting window.

Using the {In-Line} System: Open cap of In-Line System. Push down and turn cartridge holder counter-clockwise to unlock. Pull holder out. Snap the Pool Frog Mineral Reservoir into the area marked "Minerals" (top {portion} {section}) making sure to line up the indentation near the top of the cartridge with the raised line on the holder.

For best results insert the {53735-14 Brand Name} {in the area marked "Bromine or SmartChlor" (bottom {portion} {section})}. When cartridge is snapped in, replace holder by lining up arrow on handle with arrow on system lip, push down and lock in place. {Then} Replace {in-line} cap.}

[Product Description 9 and Directions for Use for {Spa} {Hot Tub} Filter Well Systems with 53735-14 Brand Name]

Product Description: A complete two-part system consisting of Pool Frog Mineral Reservoir disinfectant and {53735-14 Brand Name} {custom {fit} {designed}} {exclusively} {specially made} {for} {that fits only} {Brand} {hot tubs} {spas} up to {500} {600} gallons. This system provides Fresh Mineral Water[∞] that is cleaner because it kills bacteria two ways, clearer because the minerals help keep the pH in an acceptable range with less monitoring and softer because minerals condition the water. With 75% less chlorine*, the water feels soft and doesn't fade swimsuits, damage equipment or create smelly odors.

Replace the Pool Frog Mineral Reservoir after 4 months or when draining and refilling {spa} {hot tub} with fresh water.

It is a violation of Federal Law to use this product in a manner inconsistent with its labeling.

Directions for Use: For use in {spas} {hot tubs} up to {500} {600} gallons. Use {Pool Frog Mineral Reservoir} with the {53735-14 Brand Name} in the {brand} Sanitizing System {for Brand Spas}. Ensure all {spa} {hot tub} equipment is working properly. Operate the pump and filter {for at least 3 hours per day} {as recommended by your hot tub manufacturer}. Clean filter following manufacturer's directions. May be used with a previously filled {spa} {hot tub} unless it was sanitized with bromine or biguanides. Then drain and fill the {spa} {hot tub} with fresh water before using this product.

Read entire operating instructions for complete directions for use.

[Disposal Statement 1 for All Pool Applications: Pool Cartridge, Skimmer Application, Floating Pool Cartridge and Cartridge for Bulk Chlorinator]

Disposal: After six months of use {or one pool season whichever is shorter}, discard Pool Frog Mineral Reservoir in trash even if it appears there is spent media left inside. Non-refillable container. Do not reuse or refill this container. {Do not attempt to reuse the {Reservoir} {cartridge} {pac} {hemisphere} {replacement} once removed from the {Brand Cyclor} {skimmer} {floating Brand system} {pool.} In the unlikely event that a {Reservoir} {cartridge} {pac} {hemisphere} {replacement} should break and release raw minerals into the pool - vacuum out.

[Disposal Statement 2 for All {Spa} {Hot Tub} Applications: Spa Cartridge for In-Line and Floating System, Filter Spa Product, Spa Floating/Flipping System, Spa In-Line System and Spa Filter Well Systems]

Disposal: After four months of use, or when draining and refilling the {spa} {hot tub} with fresh water, discard Pool Frog Mineral Reservoir in trash even if, upon shaking, it appears there is spent media left inside. Once wetted the time released minerals in the cartridge are effective up to four months. Non-refillable container. Do not reuse or refill this container. {Do not attempt to reuse the product once removed from the {spa} {hot tub}.}

{NOTICE: To the extent consistent with applicable law, neither King Technology, Inc. nor the seller of this product can accept any responsibility where the product is not used according to directions and for the manner in which it was intended.}

{NOTE: To the extent consistent with applicable law, buyer assumes all responsibility for safety and use not in accordance with directions.}

[Operational Instructions 1 for Pool Cartridge used with 53735-2 Brand Name]
[All text is optional]

POOL FROG Mineral Reservoir:
{Patented} Mineral Pool {Sanitizer} {Disinfectant}

Operational Instructions

**REPLACE {Pool Frog Mineral Reservoir} EVERY 6 MONTHS OR
AFTER ONE POOL SEASON WHICHEVER IS SHORTER.**

Fresh Mineral Water[∞]. Cleaner because it kills bacteria two ways. Clearer because it helps keep pH in range. Softer because it reduces chlorine use up to 50%*. Easier with prefilled pacs for no mess, no guess and no stress.

{Swimming Pool Tips} {Start-up} {Step One: Prepar{e}{ing} the Pool}

1. Make sure the pool has adequate circulation. The total volume of pool water must completely circulate through the pump and filter at least 1 to 2 times per day. This usually requires 8 to 12 hours of circulation. Check with your dealer for the proper circulation time for your pool.
2. Check the pool's filter gauge often and periodically clean filter per the manufacturer's directions. A dirty filter will slow the flow of water which could hamper proper circulation.
3. Check the Water Hardness of your fill water before adding to the pool. If calcium content is higher than 400 ppm find a soft water source to fill your pool instead; otherwise water balance will be very difficult.
4. {If using source water that is high in iron or other metals, see your dealer before filling or topping off the pool. It may require the use of a metal control product.} {Check for metals in the pool such as iron or copper. Before attempting water balance, these should be removed. See your dealer for a metal out or sequestrant and follow the label directions carefully.}
5. Before beginning with any pool care program, you must first balance your pool water. {At spring start-up always circulate the water for at least 24 hours before testing it.} Take a water sample to your local pool professional {or use a complete test kit} {that will} {to} test for the important Water Balance Guidelines. {Our recommendation for} {For best results in} achieving water balance{,} {is to} follow steps 5a through 5e in order. **IMPORTANT:** Always follow printed instructions on the balancing chemical packages. Add balancing chemicals in small increments one at a time with circulation running {and} {For best results,} wait 8-12 hours before testing again and adding any additional balancing chemicals.
 - a. Take a water sample from the pool and dip a {Brand} Test Strip into it.
 - b. Look at the Total Alkalinity reading first. Adjustments should be made to bring the Total Alkalinity in the range of 80 – 120 ppm prior to making any adjustments to pH even if it throws pH off further.
 - c. After Total Alkalinity is in range, test for pH. It should be between 7.2 and 7.8. If higher or lower, add a pH adjuster.
 - d. Then test your {Calcium} {Water} Hardness again. {It should be between 200 and 400 ppm. If higher, partially drain the pool and fill with water low in calcium.} If lower {than 200 ppm}, add Calcium Increaser. {Always maintain 200-400 ppm.}

Water Balance Guidelines	
pH:	7.2-7.8
Total Alkalinity:	80-120 ppm
{Calcium} Hardness:	200-400 ppm
Total Dissolved Solids:	<1500
{Stabilizer} {/} {Conditioner}:	
{Cyanuric Acid:}	{20}{30}-{50}{80} ppm
Free Chlorine:	0.5-1.0 ppm

- e. Lastly test for stabilizer or conditioner levels. Add stabilizer/conditioner if the level is below 20 ppm. This will prevent chlorine burn off. If stabilizer level is above 80 ppm, partially drain water and re-fill.

If balancing takes longer than 2 days shock the water and maintain a chlorine level while continuing balancing.

6. {After balancing the water} {Initially} {Shock the pool with {an EPA registered} {a} chlorine shock only {a shock pac} to rid the water of all contaminants and establish a chlorine residual. {Always} Follow the manufacturer's directions carefully.} {If using standard chlorine shock} {Do not add shock in or near the skimmer or into the {cyclor} {chlorinator} {feeder} as it could damage equipment, risk potential explosion or discolor your pool surface.} {See the DANGER box below for important guidance on shocking.}

{DANGER}

Never add any other types of chlorine, pH adjusters, shock treatments or algaecides through the skimmer. These products should be added directly into the pool if required.

Never use fast dissolving chlorine tablets, liquid bleach, or calcium hypochlorite in the {Brand System}.} **NOTE: THIS STEP IS VERY IMPORTANT TO START-UP. USE CHLORINE SHOCK ONLY.**

**{Start-up and Operation} {Step Two: Put{ting} The System To Work}
{Pool Frog Mineral Reservoir {now with Start-up Water Polishers for easier start-up.}}**

1. {Install a POOL FROG Mineral Reservoir into the {Brand System}. (See page x for directions.) Replace cap and run {Brand System}, with POOL FROG Mineral Reservoir inserted, for 10 minutes {on setting {Maximum}, Setting {10} {5} or {On} depending on the model} {on the highest setting}.

REPLACE THE POOL FROG MINERAL RESERVOIR EVERY 6 MONTHS OR AFTER ONE POOL SEASON WHICHEVER IS SHORTER. {After that time you will hear the {spent} {used} {media} {minerals} inside, however it is no longer effective and must be replaced.}

2. {Shock the pool with {potassium monopersulfate} {non-chlorine shock pac Brand Name} to rid the water of all contaminants. (See page x for directions.)}
3. {Create a chlorine residual with {53735-13 Brand Name} or {an EPA registered} {a} chlorine shock {See page x for directions.} This step is very important {to start-up.} Always begin with chlorine in the pool water.} {(See page x for directions.)}
4. {Test the water before adding {53735-9 Brand Name}} {When the pH is between 7.2-7.8 and the chlorine level is no more than 4.0 ppm.} {For {a} {an} {90 day} algae protection guarantee, Insert {53735-9 Brand Name} into POOL FROG Mineral Reservoir {in Brand System} . (See page x for directions.)}
5. When chlorine reading is down to 1.0 ppm, which may take a few days, insert {53735-2 Brand Name} {chlorine pac}. (See {left column} {page x} for directions.)}

{Start-up and Operation {Continued}} {Step Three: Setting the {Control} Dial}

{This system is designed to work effectively with a variety of pool equipment as long as the basic procedures below are followed.}

1. Set control dial by matching up the parameters of your pool on the charts below. THIS IS A STARTING POINT ONLY and may need to be adjusted to fit your individual pool needs. See # {x} for directions.

Using Model xxxx		SINGLE-SPEED PUMP OR HIGH-SPEED PUMP RUN TIME											
		8 HOUR PUMP RUN TIME				12 HOUR PUMP RUN TIME				24 HOUR PUMP RUN TIME			
		PUMP SIZE		PUMP SIZE		PUMP SIZE		PUMP SIZE		PUMP SIZE		PUMP SIZE	
Gallons	Diameter	1/2 hp	3/4 hp	1 hp	1 1/2 hp	1/2 hp	3/4 hp	1 hp	1 1/2 hp	1/2 hp	3/4 hp	1 hp	1 1/2 hp
7,000	(18")	5.0	4.5	4.0	3.5	4.5	4.0	3.0	5.0*	3.5	3.0	2.5	4.0*
9,000	(21")	5.5	5.0	4.5	4.0	5.0	4.5	4.0	5.5*	4.0	3.5	3.0	4.5*
12,000	(24")	6.0	5.5	5.0	4.5	5.5	5.0	4.5	4.0	4.5	4.0	3.5	5.0*
15,000		NR	6.0	5.5	5.0	6.0	5.5	5.0	4.5	5.0	4.5	4.0	3.5
20,000		NR	NR	6.0	5.5	NR	6.0	5.5	5.0	5.5	5.0	4.5	4.0

Using Model xxxx		SINGLE-SPEED PUMP OR HIGH-SPEED PUMP RUN TIME											
		6 HOUR PUMP RUN TIME				12 HOUR PUMP RUN TIME				24 HOUR PUMP RUN TIME			
		PUMP SIZE		PUMP SIZE		PUMP SIZE		PUMP SIZE		PUMP SIZE		PUMP SIZE	
Gallons	Diameter	3/4 hp	1 hp	1 1/2 hp	2 hp	3/4 hp	1 hp	1 1/2 hp	2 hp	3/4 hp	1 hp	1 1/2 hp	2 hp
7,000	(18")	4.0	3.5	3.0	3.0*	3.0	2.5	4.0*	3.5*	1.5	3.5*	3.0*	2.5*
9,000	(21")	4.5	4.0	3.5	3.0	3.5	3.0	2.5	4.0*	2.5	4.0*	3.5*	3.0*
12,000	(24")	5.0	4.5	4.0	3.5	4.0	3.5	3.0	2.5	3.0	2.5	1.5	3.5*
18,000		NR	5.0	4.5	4.0	5.0	4.0	3.5	3.0	3.5	3.0	2.5	2.0
25,000		NR	NR	5.0	4.0	NR	5.0	4.0	3.5	4.0	3.5	3.0	2.5
30,000		NR	NR	6.0	5.0	NR	5.5	5.0	4.0	4.5	4.0	3.5	3.0
35,000		NR	NR	7.0	6.0	NR	6.5	5.5	5.0	5.5	4.5	4.0	3.5
40,000		NR	NR	NR	7.0	NR	NR	6.5	5.5	6.5	5.5	4.5	4.0

* – Bypass installation recommended. NR – This pump size is not recommended for this size pool. Recommended Flow Rate: 20 - 60 gpm

{IMPORTANT: {If using a multi-speed pump,} Pump run times of at least 6 hours per day at high speed are recommended for proper performance. If running low speed only or on high speed less than 6 hours, please follow the 24 Hour Low Speed directions below:

24 HOUR, LOW SPEED PUMP RUN TIME

In order to ensure proper performance when running on low speed for 24 hours per day or high speed less than 6 hours per day, bleed the air while the pump is on by unscrewing the {cap} {or} {back} knob {on the back of the cyclor near the cap} until water appears. Then screw the knob back {on} {in}. Repeat this process each time the cap is removed for any reason. Set the control dial at #6 and follow the adjustment directions in {Step x} {below} to determine the correct setting for your pool.}

2. For the first week test the pool water daily for free chlorine {with {Brand} Test Strips} to ensure correct dial setting. Continue to test weekly throughout the season. After testing, adjust the dial up by ½ increment if the free chlorine reading has dropped below 0.5 ppm or down by ½ increment if the reading has risen above 1.0 ppm. Continue this process each day until the {free chlorine} reading stabilizes to at least 0.5 ppm.} {color on the test strip matches the ideal {Brand} range of 0.5 ppm to 1.0 ppm chlorine.} Remember to adjust dial by ½ increments only, in order to prevent over chlorination which may bleach pool surfaces.

If using another means of chlorine

{Follow steps 1-5 on Start-up and Operation and then continue below.}

2. {Set the {Brand System} to} {Maintain setting of {Maximum}, Setting {10} {5} or {On} depending on the model} {the highest setting}. {Set wide open.} No adjustments needed.
3. Maintain a minimum chlorine reading of 0.5 ppm with a chlorine delivery device or hand feeding.

{Step Four: Routine Pool Care

- Run filtration system enough hours to circulate all water 1 to 2 times per day. More than that could result in over chlorination.
 - Regularly test water with {Brand} Test Strips to maintain pH and Total Alkalinity.
- NOTE: Water balance is affected by bather load, chemical usage, evaporation and the makeup of source water so maintaining water balance regularly is important.

- Maintain 0.5 to 1.0 ppm chlorine level at all times.

Note: {Chlorine levels are lower only when used with Pool Frog Mineral Reservoir} {These lower chlorine levels are only acceptable when using {Brand} minerals.}

- Shock the pool every other week or as needed. We recommend a non-chlorine shock {as reducing chlorine use is the goal of {Brand} products}. However, using a chlorine shock is ok too. {Additional shocking may be required if the pool is under heavy use, high heat or rain.
- {Before closing the pool for winter, use the {53735-9 Brand Name} {53735-9 Brand Name and 53735-13 Brand Name} following the {directions {on the pac label} {below}} {same directions as {53735-9 and 53735-13 Brand Name} on page x.}}
- {Remember to replace Pool Frog Mineral Reservoir and all other {Brand} replacements as directed.}

{How to replace the {Brand} components}

{Replacing} {Using} a POOL FROG Mineral Reservoir

1. {Check the {top} {front} of the box {and {back} label of product to} make sure you have the correct POOL FROG Mineral Reservoir to fit your {Brand System}. {The colored barcode will indicate {if it fits in ground versus above ground.} {how many gallons it will handle.}} {Above Ground Series XXXX or In Ground Series XXXX for use with Cyclor Models XXXX and XXXX.}} {The POOL FROG Mineral Reservoir {will} fit{s} in the {Brand Model XXXX} {and the} {Brand Models XXXX and or XXXX.}}

THE POOL FROG MINERAL RESERVOIR MUST BE REPLACED EVERY 6 MONTHS OR AFTER ONE POOL SEASON WHICHEVER IS SHORTER.

2. {{Once you have determined you have the right mineral reservoir,} open the box and remove the POOL FROG MINERAL RESERVOIR.}

IMPORTANT: Remove and read the inserted information card.

{DANGER

USE ONLY the factory recommended replacement POOL FROG Mineral Reservoir, {53735-9 Brand Name} {and} {53735-2 Brand Name} {and {53735-9 and 53735-13 Brand Name}}. DO NOT USE any other pac or bulk chemical tablets in the {Brand System} {or put anything inside other than the appropriate {Brand} product as directed in the product instructions}. Use of any other product could result in damage to pool equipment or surface, unsafe pool conditions, fire or explosion. Warranty will be void if the correct {Brand products} {POOL FROG Mineral Reservoir, {53735-9 Brand Name} {and} {53735-2 Brand Name} {and {53735-9 and 53735-13 Brand Name}} are not used.}

3. Turn off pump {and turn dial to {Pac Removal}, Setting {0} or {Off} depending on the model.} {turn dial to lowest setting.} {This reduces the flow of water into the unit when the cap is open.}.
4. Open {Brand System} cap, if using {53735-2 Brand Name}, stand back to avoid inhaling chlorine fumes. {Repeat steps 3 and 4 for each product you insert into the {Brand System}.}

5. {Find slot on side of POOL FROG Mineral Reservoir and line up with fin inside the {Brand System}.} {Pull up on {53735-2 Brand Name} to {remove} {disconnect} old Reservoir and discard in trash.} {Insert {53735-2 Brand Name} inside new reservoir.} {Push together until parts connect.} Lower {POOL FROG Mineral Reservoir} into {Brand System} until secure.
[Image Callouts] Slot in Pool Frog Mineral Reservoir, Fin inside of {Brand System}

Mark your calendar for the six month replacement of the POOL FROG Mineral Reservoir. Once wetted, the time released mineral coating of this product is effective up to 6 consecutive months or one pool season whichever is shorter. After that time, even if you hear the spent media inside, it is no longer effective and must be replaced.

{Replacing} {Using} the {53735-9 and 53735-13 Brand Name} and {Non-Chlorine Shock Brand Name}

{Non-Chlorine Shock Pac Brand Name} is a one-time start-up product used to rid the water of contaminants.

{53735-13 Brand Name} is also used at start up and sets the chlorine residual to help find the proper dial setting {for maintaining up to 50%* less chlorine {while using the chlorine {53735-2 Brand Name}}.

{53735-9 Brand Name} offers a 90-day Algae Protection Guarantee. {53735-9 Brand Name} also sold separately.

1. To remove colored caps, {by grabbing} {grab} on to the lip of one cap {with a pliers} and {pulling} {pull} up until cap releases. Repeat the process for the other cap.
2. {Turn pac over} {invert pac} and shake slightly until ingredients fall into tower areas.
3. Line up the small leg of the {pac} {Non-chlorine shock pac Brand Name} {or} {53735-13 Brand Name} with the small opening in the POOL FROG Mineral Reservoir and large leg with the large opening.} {Insert into center of POOL FROG Mineral Reservoir.} Lower {pac} into {POOL FROG Mineral Reservoir} until secure.
4. Replace cap by hand only. DO NOT OVER TIGHTEN.
5. Turn control dial on {Brand System} to {the highest} Setting {10} {ON}
6. Run the pump and filter for each pac according to the directions on the product label. Remove from the {Brand System} when empty and discard or offer for recycling if available.
[Image Callouts]: Top View, Pac Towers, {Brand System} {53735-9 and 53735-13 Brand Name} pacs.

{Replacing} {Using} {53735-9 Brand Name} {FOR AN ALGAE-PROTECTION GUARANTEE} {If you are not using {53735-9 Brand Name} proceed to Step x.}}

For a preventative dose, add one {53735-9 Brand Name} for pools up to 15,000 gallons or two {53735-9 Brand Name} for pools between 15,000 and 30,000 gallons.

1. Remove cap from {53735-9 Brand Name} without removing seal. {NOTE: Wait 24 hours after shocking before using {53735-9 Brand Name}. Avoid adding other chemicals until this product has been circulated (filtered) for at least 24 hours.} {If {53735-2 Brand Name} is currently being used inside the POOL FROG Mineral Reservoir, remove and set aside.}
2. {Insert upside down into center of POOL FROG Mineral Reservoir} pushing down firmly on {53735-9 Brand Name} {bottle} allowing key in {Brand System} {or Pool Frog Mineral Reservoir} to puncture seal.
3. Replace cap by hand only. DO NOT OVER TIGHTEN. Turn control dial {on Brand System} to {Maximum}, {Setting {10} {5} or {On} depending on the model} {the highest setting}.

4. Turn pump on for 90 minutes allowing {53735-9 Brand Name} to circulate through pool.
5. To remove {53735-9 Brand Name}, turn pump off, turn dial to {Pac Removal}, {Setting {0} or {Off} depending on the model} {lowest setting} and remove cap.
6. Lift {53735-9 Brand Name} up {and} {to} allow any water in the container to drain through the {Brand System}, {remove} {disconnect} {from Pool Frog Mineral Reservoir} before discarding in trash or offer{ing} for recycling if available.

{NOTE: If water shows more than a hint of blue inside {Brand System}, replace the {Brand System} cap, turn dial to {Maximum} {Setting {10} {5} or {On}} {the highest setting} and run the pump for one minute.}

{7a. {If pool size requires additional {53735-9 Brand Name}, repeat steps x-x.} {Follow steps x-x if another bottle is needed.}}

7b. When water is clear in Brand System}, {proceed to step x.} {install {53735-2 Brand Name}}

Mark your calendar for the 90-day replacement of {53735-9 Brand Name}

See {53735-9 Brand Name} product labeling for complete directions for use.

{Replacing} {Using} The {53735-2 Brand Name}

{{53735-2 Brand Name} for use in the in ground and above ground systems}

{{53735-2 Brand Name} 2 lb. for use in the {Brand System}

{{53735-2 Brand Name} 4 lb. for use in the {dual {25K} {40K}} {Brand System}

{53735-2 Brand Name} are recommended to assure up to 50%* reduction in chlorine use. Pacs sold separately.}

DANGER: Never use fast dissolving chlorine tablets, liquid bleach, or calcium hypochlorite in the {Brand System}.

WARNING: Avoid sparks, smoking or open flames {near {Brand System} or chemicals} {when handling the {Non-chlorine shock pac Brand Name}, {53735-13 Brand Name} or} {53735-2 Brand Name}}.

Turn pump off. Turn control dial to {Pac Removal}, {Setting {0} or {Off} depending on the model} {lowest setting}. Remove cap from {Brand System} and stand back to let any chlorine fumes dissipate.

1. Open Pac

1a. {53735-2 Brand Name} {2 lb.}

To remove colored {caps} {tabs} {by grabbing} {grab} on to the lip of one cap {with a pliers} and {pulling} {pull} up until cap releases. Repeat the process for the other cap.

1b. {53735-2 Brand Name} {x lb.} {Model #}

Find the indent in the plastic handle and cut using a 2" PVC cutter or hacksaw. Either way, make sure the blade comes straight across on the indent line for a clean cut. If openings are pinched together, open with fingers or re-cut closer to the colored screens inside the {53735-2 Brand Name}. Leave at least ¼" of plastic to fit into the {Brand System}.

[Image Callouts] Colored Caps, Avoid pinched opening, A correct oval opening

1c. {Turn {bac} pac over} {invert 53735-2 Brand Name} and shake slightly until {chlorine tablets} {ingredients} fall into tower areas.

[Image Callouts] {53735-2 Brand Name} {Model #} {2 lb.} {4 lb.} Towers

2. Insert pac into {Brand System}

- 2a. {53735-2 Brand Name} {2 lb.}
{For 53735-2 Brand Name:} Line up the small leg {of the {53735-2 Brand Name}} with the small opening in the POOL FROG Mineral Reservoir and large leg with the large opening. Lower {pac} {into {Brand System} {POOL FROG Mineral Reservoir}} until secure.
- 2b. {53735-2 Brand Name} {x lb.}
{For Model #:} Line up the openings in the pacs with the keys in the {Brand System}. Note: Openings are a different shape than keys. Lower pac until secure.
[Image Callouts] Opening in {53735-2 Brand Name}, Key in {Brand System}
3. Replace cap by hand only. Do not over tighten.
4. The {chlorine} pacs are made of HDPE plastic. Non-refillable container. Do not reuse or refill this container. Rinse thoroughly before discarding in trash or offer{ing} for recycling if available.
5. Once you know how long your pacs last, mark your calendar for the approximate replacement times for the {53735-2 Brand Name}.

{FOR {IN GROUND} MODEL{S} {# or Name}}

Cap removal is easier if using the tool included with the cyclor. To loosen cap, place cap tool on cap and hit the handle with the flat of your hand counter-clockwise. DO NOT USE CAP TOOL TO TIGHTEN CAP.}

Troubleshooting

Cloudy Water or Low Chlorine Levels

- Check water balance. Ensure pH, Total Alkalinity, Calcium Hardness and Stabilizer levels are correct.
- Check {53735-2 Brand Name}. If empty, replace following directions on the label.
- Make sure your Pool Frog Mineral Reservoir is not older than 6 months as it will be ineffective and more chlorine will be required to maintain the pool until you replace the Pool Frog Mineral Reservoir.
- Turn the system dial up or run your pump longer per day to increase chlorine output.
- Shock the pool {with a chlorine or non-chlorine shock} to regain clarity.

High Chlorine Levels

- Remove the chlorine pac from the {Brand} System until the chlorine level is down to 1.0 ppm.
- Lower the dial setting on the {Brand} System by 1 number.
- Test in 24 hours. Repeat process until chlorine level stays within 0.5 to 1.0 ppm.

Algae

- Use an algaecide following manufacturer's directions carefully. This may involve more than one dose.
- Run circulation 24 hours a day and brush the sides of the pool often
- When clarity starts to return shock the pool
- To prevent algae for 90 days try {53735-9 Brand Name} and its Algae Protection Guarantee.

Learn more at kingtechnology.com } frogproducts.com } or call 800-222-0169

[Operational Instructions 2 for Skimmer Application used with any EPA registered source of chlorine]

[All text is optional]

POOL FROG MINERAL RESERVOIR {For Service}

{Patented} Mineral Pool {Sanitizer} {Disinfectant} Instruction Manual

ELIMINATES DAILY DOSING FOR LESS WORK

SPARKLING WATER FOR IN GROUND POOLS

Specifications

For in ground pools {ONLY}. Not to be used in above ground pools.

Lasts 6 months once product is wetted.

Easy to set reminder dial for product replacement.

Reduces chlorine use up to 50%*

(With chlorinator or floater turn setting down or use fewer tablets.)

Step One – Prepar{e}{ing} the Pool

1. Make sure the pool has adequate circulation. For pools the water must completely circulate through the pump and filter at least 1 to 2 times per day. This usually requires 8 to 12 hours but check with your dealer to make sure.
2. Check the pool's filter gauge often and periodically clean filter per the manufacturer's directions. A dirty filter will slow the flow of water which could hamper proper circulation.
3. Check the Water Hardness of your fill water before adding to the pool. If calcium content is higher than 400 ppm find a soft water source to fill your pool instead; otherwise water balance will be very difficult
4. If using source water that is high in iron or other metals, see your dealer before filling or topping off a pool. It may require the use of a metal control product.
5. Before beginning with any water care program, you must first balance your water. {At spring start-up for pools always circulate the water for at least 24 hours before testing it.} Take a water sample to your local pool professional {or use a complete test kit} that will test for the important Water Balance Guidelines. Our recommendation for achieving water balance is to follow steps a through e in order. **IMPORTANT:** Always follow printed instructions on the balancing chemical packages. Add balancing chemicals in small

Water Balance Guidelines

pH:	7.2-7.8
Total Alkalinity:	80-120 ppm
{Calcium} Hardness:	200-400 ppm
Total Dissolved Solids:	<1500
{Stabilizer} {/} {Conditioner}:	
{Cyanuric Acid:}	{20}{30}-{50}{80} ppm
Free Chlorine:	0.5-1.0 ppm

increments one at a time with circulation running and wait 8-12 hours before testing again and adding any additional balancing chemicals.

- a) Take a water sample from the pool and dip a {Brand} Test Strip into it.
 - b) Look at the Total Alkalinity reading first. Adjustments should be made to bring the Total Alkalinity in the range of 80 – 120 ppm prior to making any adjustments to pH even if it throws pH off further.
 - c) After Total Alkalinity is in range, test for pH. It should be between 7.2 and 7.8. If higher or lower, add a pH adjuster.
 - d) Then test for Calcium Hardness. It should be between 200 and 400 ppm. If higher, partially drain the pool and fill with water low in calcium. If lower, add Calcium Increaser.
 - e) Lastly test the {stabilizer or conditioner} {cyanuric acid} levels. Add {stabilizer/conditioner} {cyanuric acid} if the level is below {20} {30} ppm. This will prevent chlorine burn off in the pool.
6. {After balancing the water} Shock the pool with an EPA registered chlorine shock to rid the water of all contaminants. If balancing takes longer than 2 days shock the water and maintain a chlorine level while continuing balancing. Follow manufacturer's directions carefully.

NOTE: THIS STEP IS VERY IMPORTANT TO START-UP. USE CHLORINE SHOCK ONLY.

{Installing a Pool Frog Mineral Reservoir} {Step Two: Putting the System to Work}

1. Set reminder dial on the Pool Frog Mineral Reservoir to 6 months from date of installation. Turn dial by hand or with a coin if needed.
2. {Remove skimmer cover and skimmer basket handle if applicable. {{Insert} {Drop} the Pool Frog Mineral Reservoir into skimmer basket. **DIAGRAM A**} {Remove pump lid. Insert Pool Frog Mineral Reservoir into the pump basket. **DIAGRAM A**}
3. If using the Pool Frog Mineral Reservoir with a suction side automatic cleaner installed through the skimmer, it will be necessary to use a vac plate that may come with the skimmer or automatic cleaner. **DIAGRAM B**

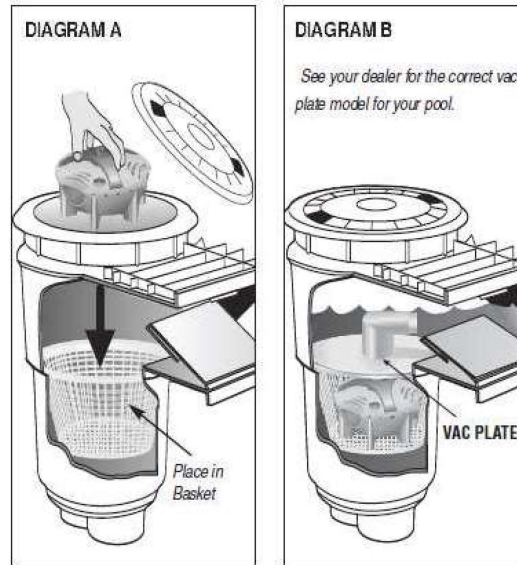

Step Three: {Regular} {Routine} Pool Care

1. Run pump and filter at least 8 hours per day.
2. Regularly test water for pH, total alkalinity and chlorine levels.
3. Maintain at least 0.5 ppm chlorine level at all times. A chlorinator or floater is recommended. If using chlorine pucks in the skimmer basket, place them under the Pool Frog Mineral Reservoir.
4. Shock pool every two weeks or as needed to maintain water quality. Follow label directions on the chlorine shock treatment used.
5. Check filter gauge regularly and clean or back-wash when needed per the manufacturer's directions.
6. Periodically clean {skimmer} {pump} basket of excess debris as normal.

REMEMBER TO REPLACE THE POOL FROG MINERAL RESERVOIR EVERY 6 MONTHS OR AFTER ONE POOL SEASON WHICHEVER IS SHORTER.

Learn more at {kingtechnology.com} {frogproducts.com} or call 800-222-0169

[Operational Instructions 3a for Spa Cartridge used in Floating System with 53735-10 or 53735-16 Brand Name]
[All text is optional]

Floating System {Operation} Instructions

{Congratulations! Your {spa} {hot tub} came with a complete mineral and bromine {sanitation} {disinfecting} {disinfection} system. When using the {patented} Pool Frog Mineral Reservoir with the proprietary {53735-10 or 53735-16 Brand Name}, you'll enjoy your {spa} {hot tub} more with less work and less bromine.

Less Work Because:

- The {Brand} Mineral {System} {Technology} {Formula}+ continuously works to control bacteria for four full months.
- Cartridges last longer to eliminate daily maintenance.
- Cartridges are prefilled for no measuring or mess.
- Simply adjust to your settings and relax for weeks.

Less Bromine Because:

- With minerals in the water, bromine use is cut by up to 50%.*
- Bromine lasts longer: {2} {3}-4 weeks on a 350 gallon {spa} {hot tub} with average use.
- With minerals and low levels of bromine, the water feels softer.
- The system reduces odors and leaves the water crystal clear.
- {Brand} Mineral System} {Technology} {Formula}+ works with bromine.}

{{Brand} sanitizes your hot tub by creating Fresh Mineral Water[®] that's

- Cleaner because it kills bacteria two ways
- Clearer because it helps keep pH {in an acceptable range} {balanced}
- Softer because {minerals condition the water for softness} there's up to 50% less bromine
- Easier with prefilled cartridges for no mess, {no guess, no stress} {or measuring}}

You're going to love your {Brand} System. If you have any questions, contact our customer service representatives at **800-222-0169**.

* Compared to the minimum ANSI recommended bromine level of 2.0 ppm for a {spa} {hot tub}.

{Spa} {Hot Tub} Start Up} {Step One: Prepar{e}ing} the {Hot Tub} {Spa}

1. Fill {spa} {hot tub} with fresh water. If using source water that is high in iron or other metals, see your dealer before filling the {spa} {hot tub}. It may require the use of a metal control product.
2. Clean or replace filter cartridges {when dirty} (*Follow manufacturer's instructions*).
3. Balance water by following steps a through d in order. **IMPORTANT:** Always follow printed instructions on the balancing chemical packages. Add balancing chemicals in small increments one at a time with the jets on and wait 6 hours before testing again and adding any additional balancing chemicals.
 - a. Take a water sample from the {spa} {hot tub} and dip a {Brand} Test Strip into it.
 - b. Look at the Total Alkalinity reading first. Adjustments should be made to bring the Total Alkalinity in the range of 80 – 120 ppm prior to making any adjustments to pH even if it throws pH off further.
 - c. After Total Alkalinity is in range, test for pH. It should be between 7.2 and 7.8. If higher or lower, add a pH adjuster.

Water Balance Guidelines

pH:	7.2 – {7.6} {7.8}
Total Alkalinity:	80 – 120 ppm
{Calcium} Hardness:	150-250 ppm
Total Dissolved Solids:	<1500
{Cyanuric Acid:	{0}{20}{30}-{50}{80} ppm}
*Free Bromine:	1.0 – 2.0 ppm

- d. Lastly test for Calcium Hardness. It should be between 150 and 250 ppm. If higher, partially drain the {spa} {hot tub} (about 6 inches) and fill with water low in calcium. If lower, add Calcium Increaser.

If balancing takes longer than 2 days, shock the water and maintain a chlorine level while continuing balancing.

4. **Very Important!** {{After balancing and} Before using cartridges,} Establish an initial residual of 1.0-2.0 ppm bromine or chlorine {with {either granular Brominating Concentrate™ (which typically contains 85% sodium dichlor (chlorine) and 15% sodium bromide) OR a chlorine shock} {a chlorine shock or sodium bromide product}}. {For best results use {53735-12 Brand Name} {a start-up {spa} {hot tub} shock packet} that quickly dissolves with an effervescent {fizzing} action – one packet per {500} {600} gallons.} {Do not use a non-chlorine shock.} {Use} {Confirm proper residual amount} {the appropriate bromine test strips or kit and follow manufacturer’s instructions.} {{Brand} Test Strips} {to accurately maintain the reduced 1.0 to 2.0 ppm bromine level following the label directions carefully} {before employing Floating System.} {Brominating Concentrate™ is a registered trademark of Bio-Lab, a Chemtura Company.}
- Note: Bromine levels are lower only when used with Pool Frog Mineral Reservoir
5. Heat water to the manufacturer’s recommended temperature {before using cartridges}.
6. {Begin {regular} {routine} {spa} {hot tub} care {procedures} (see back page) as soon as {start up is complete} {{spa} {hot tub} is prepared.}

{Setting} {Step Two: Set the} Cartridges

- The Floating System has two replaceable cartridges. The combination provides the Fresh Mineral Water∞ benefits of cleaner, clearer and softer water that’s easier to take care of.
 - {insert color} = Pool Frog Mineral Reservoir
 - {insert color} = {53735-10 or 53735-16 Brand Name}
- Set the {insert color} Pool Frog Mineral Reservoir to {wide open on} #6 (hold the bottom and turn the top until 6 appears in the setting window). No further adjustments are necessary for the life of this cartridge.
- {Set the {insert color} {53735-10 or 53735-16 Brand Name} to the setting that matches your {spa} {hot tub} size in gallons.} {With a freshly filled {spa} {hot tub}, initially set the {insert color} {53735-10 or 53735-16 Brand Name} on #5 for the first 24 hours **ONLY.**} {Then the first} {For one} week {or so, before each use,} test the water {daily} {with {Brand} Test Strips} and adjust cartridge up or down by 1 setting per day until the {bromine stabilizes to at least 1.0 ppm.} {color on the test strip matches the ideal {Brand} bromine range of 1.0 to 2.0 ppm.}

System Setting Chart	
200 Gallons	#
{250 Gallons}	#
{300 Gallons}	#
{350 Gallons}	#
{400 Gallons}	#
{450 Gallons}	#
{500 Gallons}	#
600 Gallons	#

NOTE: The more you use the {spa} {hot tub}, for instance when you first {get it} {own it}, the greater the setting to achieve at least 1.0 ppm. (This may require a higher setting than what is listed in the chart.) If usage decreases or the bromine level is greater than 2.0 ppm, lower the setting.

{Using the Floating System} {Step Three: Put{ting} the System to Work}

- Insert both cartridges into the {insert color} floating holder by pushing them into the openings until they stay in place.
- Let the Floating System free-float in the {spa} {hot tub}.
- When using the {spa} {hot tub}, simply remove the Pool Frog Mineral Reservoir, drain {most of} the water into the {spa} {hot tub} and {set} {invert} on the side of the {spa} {hot tub} {inverted} so {all} excess water drains into {the} holder.
- REMEMBER TO {REPLACE IT IN THE WATER WHEN FINISHED USING {HOT TUB} {SPA}} {RETURN SYSTEM TO {HOT TUB} {SPA} WHEN YOU GET OUT!}

Replacing Cartridges

- A. {The Pool Frog Mineral Reservoir must be replaced every 4 months. After four months of use, or when draining and refilling the {spa} {hot tub} with fresh water, discard Pool Frog Mineral Reservoir in trash even if, upon shaking, it appears there is spent media left inside. Once wetted the time released minerals in the cartridge are effective up to four months. Do not attempt to reuse the product once removed from the {spa} {hot tub}. For ease in remembering to replace, mark your calendar with the reminder stickers provided with product.}
- A. {Replace {insert color} Pool Frog Mineral Reservoir every four months or when draining and refilling {spa} {hot tub}
 - Discard it in the trash even if it appears to have media left inside
 - Don't attempt to reuse: the minerals are spent after 4 months
 - Use the enclosed stickers to remind you when it's time to replace}
- B. {Replace the {53735-10 or 53735-16 Brand Name} when empty. Drain water to ensure cartridge is empty then discard in trash {or offer for recycling}. The cartridge life will vary depending on {spa} {hot tub} size and number of users. Once your usage is determined, mark the calendar with enclosed reminder stickers.}
- B. {Replace {insert color} {53735-10 or 53735-16 Brand Name} when empty
 - Life of cartridge varies depending on {spa} {hot tub} size and number of users
 - Drain water from cartridge to ensure it is empty
 - Discard in trash or offer for recycling if available}

{Step Four: Routine} {Regular} {spa} {Hot tub} Care

- Drain and refill {spa} {hot tub} {as directed by your {spa} {hot tub} manufacturer} {or every four months when Pool Frog Mineral Reservoir need to be replaced}.
 - Run filtration system as {manufacturer recommends} {recommended by your {spa} {hot tub} manufacturer}.
 - Regularly test water {with {Brand} Test Strips. Maintain} {for} pH, total alkalinity and calcium hardness levels {with the precise {Brand} Test Strips.}
- NOTE: Water balance is affected by bather load, chemical usage, evaporation and the makeup of source water so maintaining water balance regularly is important.
- Maintain at least 1.0 ppm bromine level at all times.
- Note: Bromine levels are lower only when used with Pool Frog Mineral Reservoir
- Shock the {spa} {hot tub} once a week or as needed with {{Brand Name} easy single-dose shocking} {a non-chlorine shock}. {Heavily used {spas} {hot tubs} may require more frequent shocking.}
 - {Additional shocking may be required if the {spa} {hot tub} is under heavy use. This is often the case when the {spa} {hot tub} is new.}
 - {Remember to replace Pool Frog Mineral Reservoir and {53735-10 or 53735-16 Brand Name} as directed under "Replacing Cartridges".} {Replace Pool Frog Mineral Reservoir and bromine cartridges as directed.}

Troubleshooting

Cloudy Water or Low Bromine Levels

- Check water balance. Ensure pH, Total Alkalinity and Calcium Hardness are correct.
- Check bromine cartridge. If empty, replace following directions in Step Three.
- Make sure your Pool Frog Mineral Reservoir is not older than 4 months as it will be ineffective and more bromine will be required to maintain the {spa} {hot tub} until you replace the Pool Frog Mineral Reservoir.
- Shock the {spa} {hot tub} with {Brand Name} {or} {a non-chlorine shock} to regain clarity.

High Bromine Levels

- Remove the system from the hot tub until the bromine level is down to 2.0 ppm.
- Lower the bromine cartridge setting by 1 number and replace system in the {spa} {hot tub}.
- Test in 24 hours. Repeat process until bromine level stays within 1.0 to 2.0 ppm.

Learn more at kingtechnology.com frogproducts.com or call 800-222-0169

[Operational Instructions 3b for Spa Cartridge used in In-Line System with 53735-10 or 53735-16 Brand Name]
[All text is optional]

In-Line System Operating Instructions

{Congratulations!}

Your {spa} {hot tub} came with a complete mineral and bromine {sanitation} {disinfecting} {disinfection} system. When using the {patented} Pool Frog Mineral Reservoir with the {proprietary} {53735-10 or 53735-16 Brand Name}, you'll enjoy your {spa} {hot tub} more with less work and less bromine.

Less Work Because:

- The {Brand} Mineral {System} {Technology} {Formula}+ continuously works to control bacteria for four full months.
- Cartridges last longer to eliminate daily maintenance.
- Cartridges are prefilled for no measuring or mess.
- Simply adjust to your setting and relax for weeks.

Less Bromine Because:

- With minerals in the water, bromine use is cut by up to 50%*.
- Bromine lasts longer: {up to} {2} {3}-4 weeks on a 350 gallon {spa} {hot tub} with average use.
- With minerals and low levels of bromine, the water feels softer.
- The system reduces odors and leaves the water crystal clear.
- {Brand} Mineral {System} {Technology} {Formula}+ works with bromine.

Simply set and insert into the bottom section of the In-Line System. Everything is prefilled and contained for no mess, no guess {and} no stress {spa} {hot tub} care.}

{sanitizes your hot tub by creating Fresh Mineral Water[®] that's

- Cleaner because it kills bacteria two ways
- Clearer because it helps keep pH {in an acceptable range} {balanced}
- Softer because {minerals condition the water for softness} there's up to 50% less bromine
- Easier with prefilled cartridges for no mess, {no guess, no stress} {or measuring}}

You're going to love your {Brand} System. If you have any questions, contact our customer service representatives at **800-222-0169**.

* Compared to the minimum ANSI recommended bromine level of 2.0 ppm for a {spa} {hot tub}.

{Let Us Dissect This {Brand} For You:} The complete In-Line System

The In-Line System {is made up} {consists} of (A) a {Brand} cap {that is easily distinguishable among the fittings on the top {rim} {edge} of the {spa} {hot tub}}, (B) a cartridge holder that pulls out of the system, (C) a Pool Frog Mineral Reservoir {that helps control bacteria in the water} and (D) a bromine cartridge {that helps support the minerals while oxidizing contaminants like body oils {and ammonia compounds responsible for smelly chloramines}. The cartridges are adjustable to meet your specific {spa} {hot tub} water care needs.}



A. {Brand} Cap



B. Cartridge Holder



C. Pool Frog Mineral Reservoir



D. 53735-10 or 53735-16 Brand Name

Water Balance Guidelines

pH:	7.2- {7.6} {7.8}
Total Alkalinity:	80-120 ppm
{Calcium} Hardness:	150-250 ppm
Total Dissolved Solids:	<1500
{Cyanuric Acid}:	{0}{20}{30}- {50} {80} ppm
*Free Bromine:	1.0-2.0 ppm

Cut-away view of cartridges snapped into holder and placed into the In-Line System

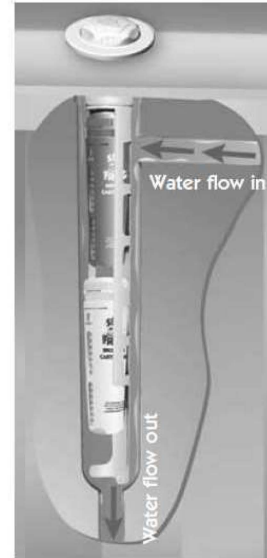

Start Up **{Step One: Prepar(e)ing the {Hot Tub} {Spa}}**

{Follow all directions from your {spa} {hot tub} manufacturer on filling and balancing the water in your {spa} {hot tub}. Standard guidelines for balancing the water are as follows:}

1. Fill {spa} {hot tub} with fresh water. If using source water that is high in iron or other metals, see your dealer before filling the {spa} {hot tub}. It may require the use of a metal control product.
2. Clean or replace filter cartridges {when dirty} (*Follow manufacturer's instructions*).
3. Balance water by following steps a through d in order. **IMPORTANT:** Always follow printed instructions on the balancing chemical packages. Add balancing chemicals in small increments one at a time with the jets on and wait 6 hours before testing again and adding any additional balancing chemicals.
 - a. Take a water sample from the {spa} {hot tub} and dip a {Brand} Test Strip into it.
 - b. Look at the Total Alkalinity reading first. Adjustments should be made to bring the Total Alkalinity in the range of 80 – 120 ppm prior to making any adjustments to pH even if it throws pH off further.
 - c. After Total Alkalinity is in range, test for pH. It should be between 7.2 and 7.8. If higher or lower, add a pH adjuster.
 - d. Lastly test for Calcium Hardness. It should be between 150 and 250 ppm. If higher, partially drain the {spa} {hot tub} (about 6 inches) and fill with water low in calcium. If lower, add Calcium Increaser.

If balancing takes longer than 2 days, shock the water and maintain a chlorine level while continuing balancing.

4. **Very Important!** {Shock {spa} {hot tub} to establish a 1.0-2.0 ppm bromine or chlorine residual. Add directly to {spa} {hot tub} following manufacturers' directions.} {After balancing and} Before using cartridges.} Establish an initial residual of 1.0-2.0 ppm bromine or chlorine {with {either granular Brominating Concentrate™ (which typically contains 85% sodium dichlor (chlorine) and 15% sodium bromide) {{53735-12 Brand Name} start-up shock {that came in this package} {a chlorine shock.} {a chlorine shock or sodium bromide product.}}

{For best results use {53735-12 Brand Name}.} {This} start-up {spa} {hot tub} shock packet {that} quickly dissolves with an effervescent {fizzing} action – one packet per {500} {600} gallons {Do not use a non-chlorine shock.} Do NOT add through the In-Line System. {Use} {Confirm proper residual amount using} {the appropriate bromine test strips or kit and follow manufacturer’s instructions.} {{Brand} Test Strips} {that came in the package} {to accurately maintain the reduced 1.0 to 2.0 ppm bromine level following the label directions carefully} {before employing the Cartridges.}

NOTE: Bromine levels are lower only when used with Pool Frog Mineral Reservoir

5. {Heat water to the manufacturer’s recommended temperature.} {When {spa} {hot tub} reaches operating temperature per your {spa} {hot tub} manufacturer’s directions, remove the shrink wrap from both cartridges. Set the mineral and bromine cartridges according to directions on page # and insert them into the System.}
6. {Begin {routine} regular {spa} {hot tub} care {procedures} (see page #) as soon as {start-up is complete} {{spa} {hot tub} is prepared}.}

{Adjusting and When to Replace {53735-10 or 53735-16 Brand Name}:} {Step Two: Set the Cartridges}

{As every {spa} {hot tub} is different, finding the right setting for the {53735-10 or 53735-16 Brand Name} will require monitoring your usage for the first week or two. Begin with an initial setting based on the chart {below} {on page #} and monitor bromine levels daily or before each use, adjusting the cartridge by one setting per day until a 1.0-2.0 ppm level has been achieved. {Use {Brand} Test Strips with the ideal Frog bromine range clearly marked on the label.} To adjust cartridge, remove from system and turn to the next highest setting if the bromine level is low, or the next lower setting if the bromine level is high. The bromine cartridge needs to be replaced when empty. Drain water to ensure empty then discard in trash. On most {spas} {hot tubs}, it will last between {2} {3} and 4 weeks. Always maintain at least 1.0 ppm bromine level.}

The In-Line System uses two replaceable cartridges.

- {Insert Color} = Pool Frog Mineral Reservoir
- {Insert Color} = {53735-10 or 53735-16 Brand Name}

The combination provides the Fresh Mineral Water[∞] benefits of cleaner, clearer and softer water that’s easier to take care of. Remove the shrink wrap from both cartridges before proceeding.

- Set the {insert color} Pool Frog Mineral Reservoir to #6 (hold the bottom and turn the top until 6 appears in the window). No further adjustments are necessary for the life of the cartridge.
- Set the {insert color} {53735-10 or 53735-16 Brand Name} to the setting that matches your {spa} {hot tub} size in gallons {and pump run time per day}. For one week test the water daily with {Brand} Test Strips and adjust cartridge up or down by 1 setting per day until the {bromine stabilizes between 1.0 and 2. 0 ppm} {color on the test strip matches the ideal FROG bromine range of 1.0 to 2.0 ppm}.

INITIAL START-UP SETTING

System Setting Chart	
200 Gallons	#
{250 Gallons}	#
{300 Gallons}	#
{350 Gallons}	#
{400 Gallons}	#
{450 Gallons}	#
{500 Gallons}	#
600 Gallons	#

NOTE: The more you use the {spa} {hot tub}, for instance when you first {get it} {own it}, the greater the setting to achieve at least 1.0 ppm. (This may require a higher setting than what is listed in the chart.) If usage decreases or the bromine level is greater than 2.0 ppm, lower the setting.

Step Three: Put{ting} the System To Work

- Open cap of In-Line System and set aside. DO NOT OPEN CAP WHILE JETS ARE ON.
- Remove holder by pushing down and turning counterclockwise before pulling out.
- {Remove spent cartridges by pushing bottom out through openings in back of holder. Then grab cartridge and pull out.}
- Snap the Pool Frog Mineral Reservoir into the area marked "Minerals" (top portion) and the {53735-10 or 53735-16 Brand Name} into the area marked {"Bromine"} {or SmartChlor"} (bottom portion) making sure to line up the indentation at the top of the cartridges with the raised area on the holder.

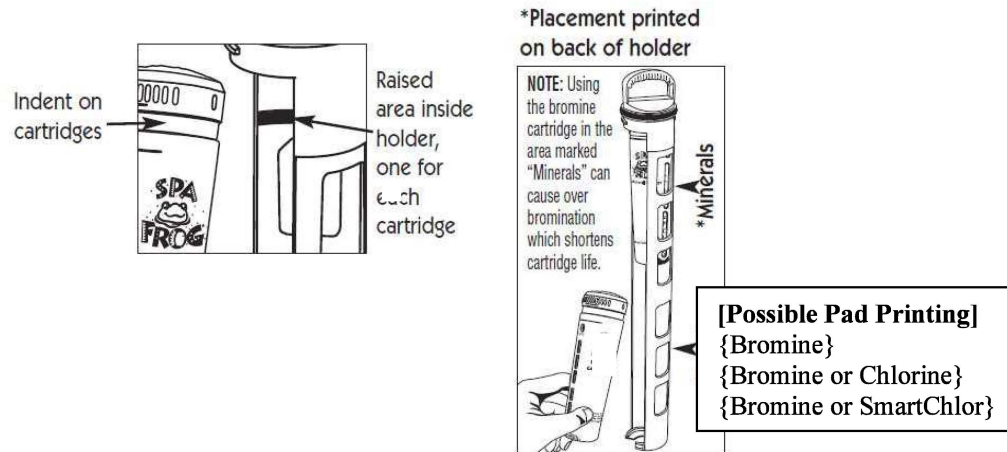

- Slowly insert holder into system (see diagrams). Line up holder arrow-❶ with system arrow-❷. Push down until holder tabs-❸ go past system tabs-❹ and turn holder to the right (clockwise) until it stops. To ensure a locked position, attempt to pull holder up. If it stays in place, the lock is secure.

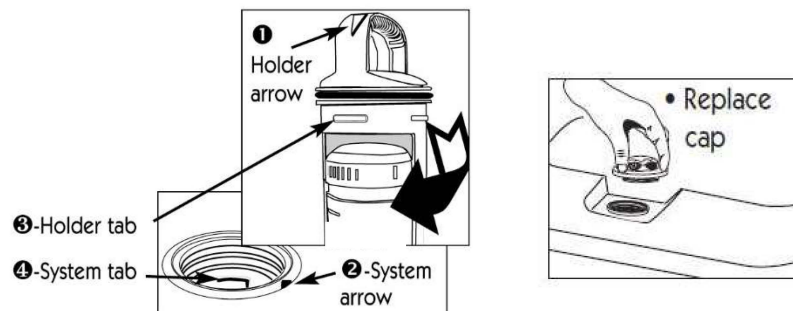

{Adjusting and When to Replace Pool Frog Mineral Reservoir:

- Set the {color} Pool Frog Mineral Reservoir wide open on #6 by holding the bottom and turning the top until the number 6 appears in the setting window. No further adjustments are necessary}

Replacing Cartridges

- {The Pool Frog Mineral Reservoir must be replaced every 4 months. After four months of use, or when draining and refilling the {spa} {hot tub} with fresh water, discard Pool Frog Mineral Reservoir in trash even if, upon shaking, it appears there is spent media left inside. Once wetted the time released minerals in the cartridge are effective up to four months. Do not attempt to reuse the product once removed from the {spa} {hot tub}. {For ease in remembering,

mark your calendar with the Reminder Stickers included with this manual.} {See {spa} {hot tub} manufacturer's draining recommendations.}}

- {Replace {insert color} Pool Frog Mineral Reservoir every four months or when draining and refilling {spa} {hot tub}
 - Discard it in the trash even if it appears to have media left inside
 - Don't attempt to reuse: the minerals are spent after 4 months
 - Use the enclosed stickers to remind you when it's time to replace}
- {Replace {insert color} {53735-10 or 53735-16 Brand Name} when empty
 - Life of cartridge varies depending on {spa} {hot tub} size and number of users
 - Drain water from cartridge to ensure it is empty
 - Discard in trash or recycle}

{Step Four: Routine} {Regular} {Spa} {Hot Tub} Care {Procedures}:}

Always follow the directions for operating your particular {spa} {hot tub}.

- Drain and refill {spa} {hot tub} {as directed by your {spa} {hot tub} manufacturer} {or every four months when Pool Frog Mineral Reservoir need to be replaced}.
- Run filtration system as {manufacturer recommends} {directed by your {spa} {hot tub} manufacturer} {to maintain proper water flow through the In-Line System {or at least 3 hours per day}}.
- {Regularly} {Periodically} {Weekly} test water {with {Brand} Test Strips and follow directions in Step 1 for maintaining}. Maintain {to maintain} {for} pH, total alkalinity {and calcium hardness} levels {with the precise {Brand} Test Strips that include special instructions for using with Frog products}.
NOTE: {Water balance} {pH} is affected by bather load, chemicals used, evaporation and the make-up of your source water so maintaining water balance regularly is important.
- {Maintain at least 1.0 ppm bromine level at all times.}
NOTE: Bromine levels are {lower only} {reduced up to 50%*} when used with Pool Frog Mineral Reservoir
- Shock the {spa} {hot tub} with {granular chlorine or} {{Brand Name} for easy single-dose shocking} {a non-chlorine shock} {once a week or as needed with {Brand Name} {a non-chlorine shock}}. {Additional shocking may be required if the {spa} {hot tub} is under heavy use. This is often the case when the {spa} {hot tub} is new.} {Heavily used {spas} {hot tubs} may require more frequent shocking.}
- {Remember to replace your Pool Frog Mineral Reservoir and {53735-10 or 53735-16 Brand Name}s as directed {in Step 3: Put the System to Work} {under "Adjusting and When to Replace".} {Replace Pool Frog Mineral Reservoir and bromine cartridges as directed.}
- Lubricate in-line holder o-ring twice a year with a silicone lubricant.

Troubleshooting

Cloudy Water or Low Bromine Levels

- Check water balance. {Ensure pH, Total Alkalinity and Calcium Hardness are correct.} {pH and Total Alkalinity need to be in the proper ranges for the In-Line System to work correctly.}
- Check bromine cartridge {and replace if empty – see instructions under}. {If empty, replace following directions in} Step {Three} {3}: Put{ting} the System to Work.
- Make sure your Pool Frog Mineral Reservoir is not older than 4 months as it will be ineffective and more bromine will be required to maintain the tub until you replace the Pool Frog Mineral Reservoir. {Shock the {spa} {hot tub} with {Brand Name} {or} {a non-chlorine shock} to regain clarity.}

High Bromine Levels

- Remove the bromine cartridge from the In-Line System until the bromine level is down to 2.0 ppm.
- Lower the bromine cartridge setting by 1 number and replace in the In-Line System.
- Test in 24 hours. Repeat process until bromine level stays within 1.0 to 2.0 ppm.

[Operational Instructions 4 for Filter Spa Product used with any EPA registered source of chlorine or bromine]

[All text is optional]

Operation Manual For Use in Filter Core

Specifications

- Fits in most filters.
- Handles {spas} {hot tubs} up to 600 gallons.
- Lasts 4 months.
- {Easy to set reminder dial for product replacement.}
- Use with {bromine or chlorine} {chlorine or bromine}.

{{Spa} {Hot Tub} Start Up} {Step 1: Prepar{e}{ing} the {hot tub} {spa}}

1. Fill {spa}{hot tub} with fresh water. If using source water that is high in iron or other metals, see your dealer before filling the {spa} {hot tub}. It may require the use of a metal control product.
2. Clean or replace filter cartridge when dirty
(*Follow manufacturer's directions*).
3. Balance water {by following steps a through d in order} {according to the chart}. **IMPORTANT:** Always follow printed instructions on the balancing chemical packages. Add balancing chemicals in small increments one at a time with the jets on and wait 6 hours before testing again and adding any additional balancing chemicals.

Water Balance Guidelines

pH:	7.2 – {7.6} {7.8}
Total Alkalinity:	80 – 120 ppm
{Calcium} Hardness:	150-250 ppm
Total Dissolved Solids:	<1500
{Stabilizer} {/} {Conditioner}:	
{Cyanuric Acid}:	{0}{20}{30}–{50}{80} ppm
*Free Bromine {or Chlorine}:	1.0 – 2.0 ppm

- a. Take a water sample from the {spa} {hot tub} and dip a {Brand} Test Strip into it.
- b. Look at the Total Alkalinity reading first. Adjustments should be made to bring the Total Alkalinity in the range of 80 – 120 ppm prior to making any adjustments to pH even if it throws pH off further.
- c. After Total Alkalinity is in range, test for pH. It should be between 7.2 and 7.8. If higher or lower, add a pH adjuster.
- d. Lastly test for Calcium Hardness. It should be between 150 and 250 ppm. If higher, partially drain the {spa} {hot tub} (about 6 inches) and fill with water low in calcium. If lower, add Calcium Increaser.

{If balancing takes longer than 2 days, shock the water and maintain a chlorine level while continuing balancing.}

4. {After balancing,} Shock {spa} {hot tub} to establish a bromine or chlorine residual of 1.0-2.0 ppm with {an EPA approved {spa} {hot tub} shock} {or by other means} {a {spa} {hot tub} start-up shock packet}. For best results use {53735-12 Brand Name} start-up {spa} {hot tub} shock packet {that} quickly dissolves with an effervescent {fizzing} action – one packet per {500} {600} gallons} (*Follow manufacturer's directions*).
5. Heat water to the manufacturer's recommended temperature.
6. {As soon as {spa} {hot tub} is prepared, begin {Routine} {Regular} {Spa} {Hot Tub} Care procedure on back page.}

{Installing Pool Frog Mineral Reservoir} {Step 2: Put{ting} the System to Work}

- {Set reminder dial on Pool Frog Mineral Reservoir to 4 months from month of installation. Turn dial by hand or with a coin if needed.} {Mark your calendar with enclosed reminder sticker for the 4 month replacement date.}

- {Place Pool Frog Mineral Reservoir in one of the following locations in {spa} {hot tub}:
 - a) Majority of {Spas} {Hot Tubs}** – Insert Pool Frog Mineral Reservoir inside filter cartridge core (**Diagram A**). Do not allow Pool Frog Mineral Reservoir to sit too low in the filter. If blocking water flow install in filter well (**Diagram B**). If Pool Frog Mineral Reservoir is inside a standpipe, attach a string to the {handle on top} {Frog head handle} for easy removal.
 - b) High Flow {Spas} {Hot Tubs}** On skimmer filters with 2.5 HP or larger pump motors, place Pool Frog Mineral Reservoir in filter well outside the filter cartridge (**Diagram B**).
 - c) Small Cartridge or Other {Spas} {Hot Tubs}** – Place Pool Frog Mineral Reservoir in skimmer tray (**Diagram C**).

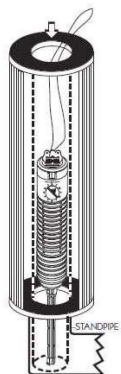

Diagram A

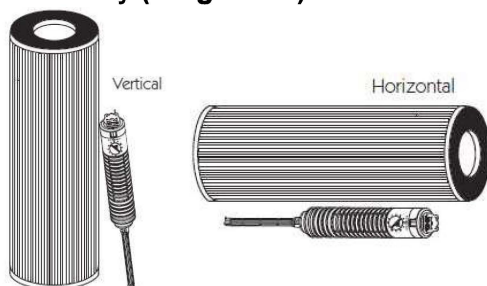

Diagram B –
High Flow Spas {Hot Tubs}
in Filter Well

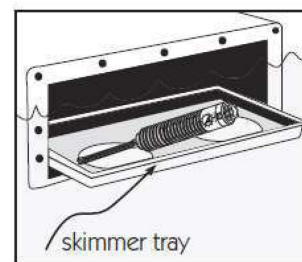

Diagram C

If unit is too tall, cut rod at hash marks to shorten.}

- {Place Pool Frog Mineral Reservoir in hot tub: Locate filter cartridge attached {in} {to} hot tub.
- Remove filter cartridge from inside of hot tub by pulling out straight from the wall.
- Insert a New Pool Frog Mineral Reservoir into the center opening.
- Replace the filter cartridge.
- Attach by pushing straight into place.
- Finished [callout] Hot Tub Wall}

{Step Three: Routine} Regular {Spa} {Hot Tub} Care

- {Always} Drain and refill {spa} {hot tub} {as directed by your {spa} {hot tub} manufacturer} {or} {at least} {every four months} {when Pool Frog Mineral Reservoir needs to be replaced}.
- Ensure all {spa} {hot tub} equipment is working properly.
- Run filtration system a minimum of three hours per day.
- Regularly test water for pH, total alkalinity and bromine {or chlorine} levels. Maintain at least a 1.0 ppm bromine {or chlorine} level at all times. Note: Bromine {or chlorine} levels are lower only when used with the Frog Mineral {System} {Technology} {Formula}+
- Shock the {spa} {hot tub} {with {Brand Name} for easy single-dose shocking} once a week or as needed. Additional shocking may be required if the {spa} {hot tub} is under heavy use. This is often the case when the {spa} {hot tub} is new.
- The Pool Frog Mineral Reservoir must be replaced every 4 months. After four months of use or when draining and refilling the {spa} {hot tub} with fresh water, discard Pool Frog Mineral Reservoir in trash even if, upon shaking, it appears there is spent media left inside. Once wetted the time released minerals in the cartridge are effective up to four months. Non-refillable container. Do not reuse or refill this product. Do not attempt to reuse the product once removed from the {spa} {hot tub}.
{Set for 4 mos.}

Troubleshooting

Most issues are caused by improper water balance or sanitizer levels. If water is cloudy:

- Check water balance. Ensure pH, Total Alkalinity and Calcium Hardness are correct.
- Make sure your chlorine or bromine levels are at least 1.0-2.0 ppm.
- Make sure your Pool Frog Mineral Reservoir is not older than 4 months as it will be ineffective and more bromine/chlorine will be required to maintain the {spa} {hot tub} until you replace the Pool Frog Mineral Reservoir.
- Shock the {spa} {hot tub} with {Brand Name} {or} {a non-chlorine shock} to regain clarity.

Learn more at kingtechnology.com frogproducts.com or call 800-222-0169

[Operational Instructions 5 for Floating Pool Cartridge used with 53735-2 Brand Name]
[All text is optional]

FROG Mineral System Operation Manual

This is not a toy. For sanitizing {pop-up} {soft sided} {Intex style} pools {or swim spas} only!
{Tether to pool with enclosed cord.} {If using in a swim spa, allow to free float in the water.}

{Welcome to {pool} {water} care courtesy of FROG. The FROG {Mineral {Water} System+}
{Mineral Sanitizing Pool Care System} {pool care with sanitizing minerals} {sanitizing mineral
pool care} {will help} destroy{s} bacteria to keep your pool {or swim spa} clean with less work
and up to 50% less chlorine*. It is super easy to use and will keep you enjoying a clean,
clear swimming pool [or swim spa] for weeks at a time. Here's all you do:}

{The Pool Frog Mineral Reservoir is {part of} a complete {pool} {water} care system for {pop-up}
{soft sided} {Intex style} pools {or swim spas} up to {1,000} {5,000} {10,000} gallons. It {uses}
{utilizes} {the} {our} {patented} mineral formula {in the top cartridge} {of the FROG Mineral
Reservoir} with {low{er}} {reduced} levels of chlorine from the {bottom} chlorine cartridge to
destroy bacteria, help maintain pH and restore water clarity. Simply {connect,} {turn} {twist} to
set {the dial} and {toss into} {tether to} {plop in} the pool {or swim spa}. Everything is prefilled
and contained {{for} no mess, no guess {and} no stress {pool care.}} {The best part is it flips
over when {empty} {out} {it's time to replace {a} {the} {chlorine} cartridge.} {Hey! Less Work
Hey! Less Chlorine Hey! Less Money}

Register your Pool Frog Mineral Reservoir at {kingtechnology.com} {frogproducts.com}
For complete instructions read the entire manual.

{Pool} {Start-up} {Step One: Prepar{e}{ing} the Pool}

1. Make sure the pool has adequate circulation. The total volume of pool water must completely circulate through the pump and filter at least 1 to 2 times per day. This usually requires 8 to 12 hours of circulation. Check with your dealer for the proper circulation time for your pool.
2. Check the pool's filter gauge often and periodically clean the filter per the manufacturer's directions. A dirty filter will slow the flow of water which could hamper proper circulation.
3. Check the Water Hardness of your fill water before adding to the pool. If calcium content is higher than 400 ppm find a soft water source to fill your pool instead; otherwise water balance will be very difficult.
4. {If using source water that is high in iron or other metals, see your dealer before filling or topping off the pool. It may require the use of a metal control product.} {Check for metals in the pool such as iron or copper. Before attempting water balance these should be removed. See your dealer for a metal out or sequestrant and follow the label directions carefully}
5. {At spring start-up always circulate the water for at least 24 hours before testing it.} {Use test strips or a test kit to} balance your water according to the water balance guidelines. The Pool Frog Mineral Reservoir {System} controls {maintains} the free chlorine level {only.} pH is affected by weather and the make-up of your source water. For {help in balancing} {best results in achieving water balance}, follow steps 5a through 5e in order. **IMPORTANT:** Always follow printed instructions on the balancing chemical packages. Add balancing chemicals in small increments one at a time with circulation running and wait 8-12 hours before testing again and adding any additional balancing chemicals.
 - a. Take a water sample from the pool and dip a {Brand} Test Strip into it.
 - b. Look at the Total Alkalinity reading first. Adjustments should be made to bring the Total Alkalinity in the range of 80 – 120 ppm prior to making any adjustments to pH even if it throws pH off further.

- c. After Total Alkalinity is in range, test for pH. It should be between 7.2 and 7.8. If higher or lower, add a pH adjuster.
- d. Then test for Calcium Hardness. {It should be between 200 and 400 ppm.} If higher, partially drain the pool and refill with water low in calcium. If lower {than 200 ppm}, add Calcium Increaser. {Always maintain 200-400 ppm}
- e. Lastly test for stabilizer or conditioner levels. Add conditioner if the level is below 20 ppm. This will prevent chlorine burn off. If stabilizer is above 80 ppm, partially drain water and re-fill.

{If balancing takes longer than 2 days, shock the water and maintain a chlorine level while continuing balancing.}

6. {Initially} Shock pool {with a chlorine shock {only}} {at start-up}} to remove contaminants {and establish a chlorine residual.} Always follow manufacturer's directions carefully. See the DANGER box below for important guidance on shocking.

DANGER: Never add any types of chlorine, pH adjusters, shock treatments or algaecides {on or} {near} {within 3 feet of} the Frog Mineral System}. Damage to the pool or equipment, unsafe pool conditions, fire or explosion could result.

Water Balance Guidelines

pH:	7.2-7.8
Total Alkalinity:	80-120 ppm
{Calcium} Hardness:	200-400 ppm
Total Dissolved Solids:	<1500
{Stabilizer} {/} {Conditioner}:	
{Cyanuric Acid:}	{20}{30}-{50}{80} ppm
Free Chlorine:	0.5-1.0 ppm

Step Two: Put{ting} the System to Work

- a. Remove {the} {outer} packaging from both the mineral and chlorine {cartridges} {pacs} of the {Brand System}. NOTE: Small mineral particles may have dislodged from the cartridge in shipping. Simply discard {particles} in trash.
- b. [OPTION 1] Bring the two {cartridges} together and line up tarrow on the chlorine cartridge with the unlock symbol on the Pool Frog Mineral Reservoir. {Push together and twist {the bottom cartridge x degrees} {to lock} }.
[OPTION 2] {Align the {53735-2 Brand Name} with {tab guides} on the Pool Frog Mineral Reservoir. Push until you hear the cartridge click into place.}
- c) {Then simply toss it into the pool or swim spa.} {For pools,} tether it to the pool {side} {frame} {or ladder} {with the cord provided,} away from the skimmer or a return jet.} {For swim spas, allow the system to free float in the water.}

NOTE: This product may be removed from the pool when in use {or if the pool has over chlorinated.} Lift out of the water and let drain into the pool. Then hang over the outside of the pool {on {the cord provided} {a string}} or place on the ground or surface that is not susceptible to bleaching from the chlorine. {For swim spas, this product MUST be removed from the water when in use due to high jet action that could deplete the chlorine cartridge prematurely.} Remember to replace the product once exiting the pool {or swim spa} {or when the chlorine levels return to normal.}

{Setting the FROG Mineral System} {Step Three: Setting the {Control} Dial}

[OPTION 1] Twist the mineral {cartridge} {pac} opposite of the chlorine {cartridge} {pac} until the setting number for your pool {or swim spa} size is lined up with the {arrow} {on the chlorine cartridge} (see setting chart).

[OPTION 2] Twist the dial on the chlorine cartridge to the setting {number} for your pool {or swim spa} size (see setting chart).} {Start with the {factory} {middle} {center} {medium} setting. If you find less chlorine is needed turn the dial to {the} {a} lower setting –if more is needed turn it to {the} {a} higher setting.} Even at the lowest setting {of 0} there will be some chlorine released into the pool.

[graphic callouts:] {insert color} Pool Frog Mineral Reservoir, {insert color} chlorine cartridge, Setting {#} on Pool Frog Mineral Reservoir, Twist {mineral opposite of chlorine} {dial on bottom of chlorine cartridge}

- c. {Test the water periodically and {adjust the setting until the chlorine level is} maintain{ed} at {least a} 0.5 ppm to 1.0 ppm {chlorine level}. Use the precise {Brand} Test Strips to help measure the ideal chlorine range when used with Pool Frog Mineral Reservoir. {Based on average pool usage,} chlorine will last {on average} {about} {up to} {4-6 weeks for pools up to {3000} {4000} gallons or} {{2} {3}-4 weeks for pools up to {5000} {6000} {10,000} gallons,} {3-4 weeks} {several weeks on an average swim spa} {except during times of hot} {depending on the water temperature{s} and {heavy} pool {or swim spa} use.}

{Pool Frog Mineral Reservoir} Initial Setting Chart {For {2000} {5000} to {5000} {10,000} Gallons}					
Diameter	Pool {or Swim spa} Gallon Size} {Gallons}	Setting #	Diameter	Pool Gallon Size} {Gallons}	Setting #
8-10'	{1000}	#	18'	{5000}	{Low} {Less} {Small Pool}
10'	{1500}	#	18'	{5500}	{Low} {Less} {Small Pool}
12'	{2000}	#	18'	{6000}	{#} {Medium}
12'	{2500}	#	18'	{6500}	{#} {Medium}
15'	{3000}	#	20'	{7000}	{#} {Medium}
15'	{3500}	#	20'	{8000}	{#} {High} {More} {Large Pool}
15'-16'	{4000}	#	21'	{9000}	{#} {High} {More} {Large Pool}
15'-16'	{4500}	#	21'	{10,000}	{#} {High} {More} {Large Pool}

 {Most common pool size} {For example, pools 15' in diameter or 4000 gallons would use setting x} NOTE: {See the information that came with your pool or} calculate pool gallons by multiplying diameter x diameter x water height (feet) x 5.9 or visit our pool volume calculator at kingtechnology.com frogproducts.com. {Swim spa users should check with the manufacturer for gallon sizes.}

Replacing the {53735-2 Brand Name} {Cartridges} {Pacs}

1. When the product is almost empty it will {begin to} slowly {flip} {roll} over giving you {a day or two} notice that it's about time to replace. Do not remove the chlorine cartridge until the system has completely flipped. {If it stays on its side longer than a day or two, pull unit out of the water and let it drain. Reset it in the water to see if it flips completely.}
2. {When it completely {flips} {rolls} over} {replace by rotating the two {cartridges} {pacs} until the {arrows align along the edge of both cartridges and pull apart} {arrow on the chlorine cartridge aligns with the unlock symbol on the Pool Frog Mineral Reservoir and pull apart}. {release the chlorine cartridge by squeezing the tabs and pull the empty cartridge out.}
3. If the chlorine {cartridge} {pac} contains a small amount of chlorine after the system has {flipped} {rolled} over, {place in pool {or swim spa} to float by itself} {hang on the tether via the {hook} {loop} on the side of the {almost empty chlorine} cartridge} {until completely empty}. Do not allow chlorine cartridge to sink to the bottom or pool {/swim spa} bleaching may occur.
4. When completely empty, discard in trash {or offer for recycling if available}.

{Regular} {Step Four: Routine} Pool Care

1. {For pools,} Run pump and filter at least 8 hours per day {but ideally 24 hours per day}. {Swim spas should run their circulation per the swim spa manufacturer.} Clean or replace your filter

cartridge weekly. Lack of circulation may cause bleaching of pool {or swim spa} surface and improper sanitization levels.

2. {Regularly} Skim the surface of any debris and remove {anything} {debris} collected on the return fitting to your pump {or the main drain of the swim spa}.
3. Regularly test water for pH, total alkalinity and chlorine levels. Adjust your pH when it rains or when adding fresh water to the pool {or swim spa}. Maintain {a} {at least} 0.5 to 1.0 ppm chlorine level at all times.
4. Replace {the} chlorine {cartridge} when {the FROG Mineral System completely} {flips} {flipped} {rolls} over.
5. Shock the pool {at least} {weekly in the heat of the season {or} {and}} {at least weekly when the pool {or swim spa} is being used often and every few days when the water temperature is 90 degrees or more} {as needed} to maintain water clarity. We recommend a non-chlorine shock s reducing chlorine use is the goal of {Brand} products. However, using a chlorine shock is ok too. {Follow label directions on the shock treatment used.} See DANGER box under Preparing the Pool {#2}.
6. Replace the complete Frog Mineral {Reservoir} {System} every 6 months or after one pool season whichever is shorter. If the pool is drained and refilled prior to six months {or one pool season}, Pool Frog Mineral Reservoir must be replaced at that time.

Troubleshooting

Cloudy Water or Low Chlorine Levels

- Check water balance. Ensure pH, Total Alkalinity, Calcium Hardness and Stabilizer levels are correct.
- Check chlorine cartridge and replace if empty – see instructions under “Replacing Cartridges”.
- Make sure your Pool Frog Mineral Reservoir is not older than 6 months as it will be ineffective and more chlorine will be required to maintain the pool until you replace the Pool Frog Mineral Reservoir.
- Shock the pool {with a chlorine or non-chlorine shock} to regain clarity. See DANGER box under Prepar{e}{ing} the Pool {#2}.

High Chlorine Levels

- Remove the FROG System from the pool until the chlorine level is down to 1.0 ppm.
- Lower the dial setting on the FROG System by 1 number and replace in the pool.
- Test in 24 hours. Repeat process until chlorine level stays within 0.5 to 1.0 ppm.

Algae

- Use an algaecide following manufacturer’s directions carefully. This may involve more than one dose.
- Run circulation 24 hours a day and brush the sides of the pool often
- When clarity starts to return shock the pool. See warning under Prepar{e}{ing} the Pool #2.

Learn more at kingtechnology.com frogproducts.com or call 800-222-0169

[Operational Instructions 6 for Cartridge for Bulk Chlorinator used with 53735-2 Brand Name]
[All text is optional]

FROG Mineral System Operation Manual

Welcome to pool care courtesy of FROG. The FROG Mineral System+ will destroy bacteria to keep your pool clean with less work and up to 50% less chlorine*. It is super easy to use because it fits inside your current {Hayward®} {Rainbow®} {or equivalent} chlorinator. You simply enjoy a clean, clear swimming pool without touching or counting chlorine {tablets} {pucks} again. Here's all you do:

Swimming Pool Tips

1. Make sure the pool has adequate circulation. The pool water must completely circulate through the pump and filter at least 1 to 2 times per day. This usually requires 8 to 12 hours. Check with your dealer for the proper circulation time for your pool.
2. Before beginning with any pool care program, you must first balance your pool water. {At spring start-up always circulate your water for at least 24 hours before testing it.} Take a water sample to your local pool professional {or use a complete test kit} that will test for the following important elements.

Water Balance Guidelines	
pH:	7.2-7.8
Total Alkalinity:	80-120 ppm
{Calcium} Hardness:	200-400 ppm
Total Dissolved Solids:	<1500
{Stabilizer} {/} {Conditioner}:	
{Cyanuric Acid:}	{20}{30}-{50}{80} ppm
Free Chlorine:	0.5-1.0 ppm

3. If your fill water is high in metals, use a sequestering agent or metal out product at start up only before using the mineral reservoir. See your local dealer for details on using these products and always follow manufacturer's directions carefully.
4. After your pool is up and running smoothly, continue to test your water for pH, total alkalinity and chlorine {with {Brand} Test Strips} and maintain its balance by adding any necessary adjustment products (see you dealer for details).
5. Check the pool's filter gauge often and periodically clean filter per the manufacturer's directions. A dirty filter will slow the flow of water which could hamper proper circulation.

{How to replace the Pool Frog components}

{Replacing} {Using} a Pool Frog Mineral Reservoir and {53735-2 Brand Name}

1. Check the {top} {front} of the box {and {back} label of product} to make sure you have the correct Pool Frog Mineral Reservoir to fit your {Hayward®} {Rainbow®} chlorinator.

THE POOL FROG MINERAL RESERVOIR MUST BE REPLACED EVERY 6 MONTHS OR AFTER ONE POOL SEASON WHICHEVER IS SHORTER.

2. Remove the material covering the holes on the bottom {and side} of {remove the plug from the side of} the {53735-2 Brand Name}.

3. {If using {53735-9 Brand Name}. {push} {screw} {affix} {insert} algaecide {pac} {container} {bottle} {on} {in} to the {chlorinator} {adapter that attaches to the} {Pool Frog Mineral Reservoir} {while inside the chlorinator} {then insert into chlorinator}. Replace cap, turn dial full open and run for 90 minutes. Remove algaecide {pac} {container} {bottle} and discard or recycle.}
4. Connect the Pool Frog Mineral Reservoir to the {53735-2 Brand Name} by bringing the two together, lining up the arrows and turning the {53735-2 Brand Name} clockwise to lock.
5. Turn off pump, turn chlorinator dial closed or off and open the cap.
6. {Lift up} {Use} the handle {and} {to} lower the complete system into the {Hayward®} {Rainbow®} chlorinator by lining up the square channel on the side of the Pool Frog Mineral Reservoir and {53735-2 Brand Name} with the dial side of the {Hayward®} {Rainbow®} chlorinator.
7. Replace the chlorinator cap. If the system is not seated properly the cap will not close. Pull up, check alignment and re-lower into chlorinator.

Channel in Pool Frog Mineral Reservoir
Dial side of {Hayward®} {Rainbow®} chlorinator

Replacing the {53735-2 Brand Name}

{53735-2 Brand Name} will help ensure a reduction of up to 50%* in chlorine use. *Pacs sold separately.* (EPA Reg. No. 53735-2)

**Compared to the minimum EPA recommended chlorine level of 1.0 ppm for a stabilized swimming pool.*

Avoid sparks, open flame or smoking when handling the pac.

1. When the {53735-2 Brand Name} is empty remove the entire {system} {product} from the chlorinator. Turn the {53735-2 Brand Name} counter clockwise to unlock it from the Pool Frog Mineral Reservoir. Simply connect a new {53735-2 Brand Name} by lining up the arrows and turning the {53735-2 Brand Name} clockwise until it locks.
Alignment arrows
Turn clockwise
2. {Lift up} {Use} the handle {and} {or} lower the complete system into the {Hayward®} {Rainbow®} chlorinator by lining up the square channel on the side of the Pool Frog Mineral Reservoir and {53735-2 Brand Name} with the dial side of the {Hayward®} {Rainbow®} chlorinator.

The pacs are made of HDPE plastic. Non-refillable container. Do not reuse or refill this container. Offer for recycling if available. Rinse thoroughly before recycling or discarding in trash.

Mark your calendar for the six month replacement of the Pool Frog Mineral Reservoir and approximate replacement times for the {53735-2 Brand Name}. Once wetted, the time released mineral coating of this product is effective up to 6 consecutive months or one pool season whichever is shorter. After that time, even if you hear the spent media inside, it is no longer effective and must be replaced.

Start-up and Operation

1. Add a stabilizer or conditioner to the pool at the beginning of the season if the stabilizer level is below 20 ppm. This will prevent chlorine burn off. Follow manufacturer's directions carefully.
2. {Shock the pool with {an EPA registered chlorine shock} {53735-13 Brand Name} to rid the water of all contaminants before beginning. Follow manufacturer's directions carefully.}

Do not add shock in or near the skimmer or into the chlorinator as it could damage equipment, risk potential explosion or discolor your pool surface.

THIS STEP IS VERY IMPORTANT TO START-UP. USE CHLORINE SHOCK ONLY.

3. {If using the {53735-9 Brand Name} {pac} {container} {bottle}, follow the directions for use on that product now.}
4. Install Pool Frog Mineral Reservoir and {53735-2 Brand Name} into the {Hayward®} {Rainbow®} chlorinator. See page 1 for directions.

REPLACE THE POOL FROG MINERAL RESERVOIR EVERY 6 MONTHS OR AFTER ONE POOL SEASON WHICHEVER IS SHORTER.

5. **SETTING CONTROL DIAL** Set control dial by matching up the parameters of your pool on the charts below. THIS IS A STARTING POINT ONLY and may need to be adjusted to fit your individual pool needs. See # {x} for directions.

Initial Setting Chart	
Pool Gallon Size	Setting #
10,000	#
15,000	#
20,000	#
25,000	#
30,000	#
35,000	#
40,000	#

6. For the first week test the pool water daily for free chlorine {with {Brand} Test Strips} to ensure correct dial setting. Continue to test weekly throughout the season. After testing, adjust the dial up by ½ increment if the free chlorine reading has dropped below 0.5 ppm or down by ½ increment if the reading has risen above 1.0 ppm. Continue this process each day until the {reading stabilizes to at least 0.5 ppm.} {color on the test strip matches the ideal Frog range of 0.5 ppm to 1.0 ppm free available chlorine (FAC).} Remember to adjust dial by ½ increments only, in order to prevent over chlorination which may bleach pool surfaces.
7. Shock pool every two weeks or as needed to maintain water quality. Follow label directions on the chlorine shock treatment used.

Hayward® is a registered trademark of Hayward Industries Inc.
Rainbow® is a registered trademark of Pentair Inc.

Learn more at frogproducts.com or call 800-222-0169

[Operational Instructions 7 for {Spa} {Hot Tub} Floating/Flipping System used with 53735-14 Brand Name]
[All text is optional]

Floating {Sanitizing} System {Operati{on}{ng}} Instructions

This is not a toy. For {sanitizing} {disinfecting} {spas} {hot tubs} {swim spas} only!

{{Brand}} is the hot tub sanitizing system that takes the guess work out of water care so you always feel at ease while enjoying your hot tub.

- {{Brand}} creates Fresh Mineral Water[∞] that's cleaner, clearer and softer
- {{Brand}} employs {53735-14 Brand Name} Technology that knows when and how much free chlorine is needed so it uses up to 75% less.*
- {{Brand}} flips over when it's time to replace the {53735-14 Brand Name}
- {{Brand}} requires far less shocking – only once a month!

* Compared to the minimum ANSI recommended chlorine level of 2.0 ppm for a {spa} {hot tub}.

Read entire operating instructions for complete directions for use

{Step One: Prepar{e} {ing} the {Spa} {Hot Tub} {Swim Spa} {Start Up}

1. Fill {spa} {hot tub} {swim spa} with fresh water. If using source water that is high in calcium, iron or other metals, see your dealer before filling the {spa} {hot tub}. {It may require the use of a metal control product.} If previously using bromine and switching to {{Brand System}}, you must drain and refill your {spa} {hot tub} {swim spa} before using this product. {If previously using dichlor you may convert to {{Brand System}} without having to drain the {spa} {hot tub} {swim spa} as long as the {stabilizer} {conditioner} {cyanuric acid level is below {50} {80} ppm.}
2. Clean or replace filter cartridges when dirty (*Follow manufacturer's instructions*).
3. Balance water following steps a through d in order. **IMPORTANT:** Always follow printed instructions on the balancing chemical packages. Add balancing chemicals in small increments one at a time with the jets on and wait 6 hours before testing again and adding any additional balancing chemicals.
 - a. Take a water sample from the {spa} {hot tub} {swim spa} and dip a {{Brand}} Test Strip into it.
 - b. Look at the Total Alkalinity reading first. Adjustments should be made to bring the Total Alkalinity in the range of 80 – 120 ppm prior to making any adjustments to pH even if it throws pH off further. {Since pH tends to rise in hot tubs, maintaining a Total Alkalinity closer to the low end of 80 will make managing the hot tub easier.}
 - c. After Total Alkalinity is in range, test for pH. It should be between 7.2 and 7.8. If higher or lower, add a pH adjuster. {Again, due to rising pH in {spas} {hot tubs} {swim spas}, try to maintain as close to the low end of 7.2 as possible.}
 - d. Lastly test for Calcium Hardness. It should be between 150 and 250 ppm. If higher, partially drain the {spa} {hot tub} {swim spa} (about 6 inches) and fill with water low in calcium. If lower, add Calcium Increaser.

Water Balance Guidelines

pH:	7.2 – {7.6} {7.8}
Total Alkalinity:	80 – 120 ppm
{Calcium} Hardness:	150-250 ppm
Total Dissolved Solids:	<1500
{Stabilizer} {/} {Conditioner}	
{Cyanuric Acid}:	{0}{20}{30}-{50}{80} ppm
{*Free Chlorine:	0.5 – 1.0 ppm}

If balancing takes longer than 2 days, shock the water and maintain a chlorine level while continuing balancing.

4. **Very Important!** After balancing and before using cartridges, {establish} {ensure there is} an initial residual of 0.5-1.0 ppm free chlorine {with {53735-12 Brand Name} start-up shock

{included in this package} that quickly dissolves with an effervescent fizzing action – one packet per {500} {600} gallons.

5. Heat water to the manufacturer’s recommended temperature {before using cartridges}.

Step Two: Put{ting} the {Brand} System To Work

INITIAL START-UP SETTING

{53735-14 Brand Name} Setting Chart	
Gallons	Setting #
x – x	#
x – x	#
x – x	#
x – x	#
x-x	#
x-x	#

[Note to Reviewer: the spa/hot tub gallon range in the setting chart will be between 200 and 600 gallons while the swim spa gallon range will be between 1000 and 3000 gallons]

The {Brand} Floating System has two replaceable cartridges.

- {insert color} = Pool Frog Mineral Reservoir
- {insert color} = {53735-14 Brand Name}

The combination provides the Fresh Mineral Water[∞] benefits of cleaner, clearer and softer water that’s easier to take care of.

Simply follow these easy steps:

1. Remove outer packaging from the {53735-14 Brand Name}.
2. Line up arrows on both cartridges, push together and lock.
3. Twist the dial on the {53735-14 Brand Name} to the setting number for your {spa} {hot tub} {swim spa} (see chart based on gallons)
4. Toss into the {spa} {hot tub} {swim spa}. It will float in the water at a slight tilt.
5. If you like, remove {Brand} System from the {spa} {hot tub} {swim spa} while {bathing} {soaking}. Lift out {Brand} System and let drain into the {spa} {hot tub} {swim spa}. Place on any surface not susceptible to chlorine bleaching. Remember to return it to the {spa} {hot tub} {swim spa} afterwards.

Replacing Cartridges

- A. When the {Brand} Floating System flips completely over, remove the {insert color} {53735-14 Brand Name}
 - {53735-14 Brand Name} will last {about} {up to 4} {3-4} weeks {/} {for an average} 400 gallon {spa} {hot tub} {or 2000 gallon swim spa}
 - Floating System naturally lists in the water. To check if {53735-14 Brand Name} is empty, lift up and drain all water from the system, then replace in the {spa} {hot tub} {swim spa} and see if it flips completely.
 - Detach {53735-14 Brand Name} by twisting to align with “unlock” arrow and pull apart
 - Attach new cartridge (see Step 2: Put{ting} the System to Work)
 - Discard in trash or offer for recycling if available. Note: If the {53735-14 Brand Name} still contains a small amount after detaching, place in {spa} {hot tub} {swim spa} to float on its own until empty. Do not let it sink to bottom as it may bleach {spa} {hot tub} {swim spa} surface.

- B. Pool Frog Mineral Reservoir: After 4 months or when draining and refilling the {spa} {hot tub} {swim spa}, the {color} Pool Frog Mineral Reservoir must be replaced even if you hear the spent minerals inside. This cartridge is available only in the {Brand System}.

{Step Three}: {Routine} {Regular} {Spa} {Hot Tub} {Swim Spa} Care

- Drain and refill {spa} {hot tub} {swim spa} {as directed by your {spa} {hot tub} {swim spa} manufacturer} {or every four months when Pool Frog Mineral Reservoir needs to be replaced}. {Whenever you drain and refill, make sure to replace your {Brand} Minerals.}
- Run filtration system as recommended by your {spa} {hot tub} {swim spa} manufacturer {or at least 3 hours per day}.
- {Periodically} {Regularly} {Weekly} test water with {Brand} Test Strips and follow directions in {Step One} {Start-up} for maintaining pH, total alkalinity and calcium hardness.

NOTE: pH is affected by {weather} bather load, chemicals used, evaporation and the make-up of your source water so maintaining water balance regularly is important.

- {53735-14 Brand Name} will maintain {at least a 0.5 ppm} {a 0.5 to 1.0 ppm} free {active} chlorine level as long as the water is balanced.

NOTE: Free chlorine levels are reduced up to 75%* when using Pool Frog Mineral Reservoir {and {53735-14 Brand Name} Technology}

{NOTE: Why {Brand} Test Strips? The {53735-14 Brand Name} forms a chlorine reserve that will be inaccurately measured as total chlorine on other test strips. Unlike conventional chlorine, the {53735-14 Brand Name} reserve readily shifts to free chlorine as needed, maintaining {spa} {hot tub} {swim spa} health with a low level of chlorine.}

- Shock the {spa} {hot tub} {swim spa} with {granular chlorine or} {{Brand Name} for easy single-dose shocking} {a} {non-chlorine shock} when you replace the {53735-14 Brand Name}, or once a month {or if the water looks cloudy}.
- Replace the {53735-14 Brand Name} when the system flips over and the complete {Brand} System that includes a Pool Frog Mineral Reservoir as directed under “Replacing Cartridges”

Troubleshooting

Cloudy Water {or Low Chlorine Levels}

- Shock the {spa} {hot tub} {swim spa} with {Brand Name} {or} {a} {non-chlorine shock}
- Check water balance. pH and Total Alkalinity need to be in the proper ranges for the {Brand} System to work correctly
- Check {53735-14 Brand Name} and replace if empty—see instructions under {“Replacing Cartridges”} {Step 2: Put{ting} the System to Work}
- If {53735-14 Brand Name} is not empty, turn dial setting up 1 number while maintaining water balance. If needed turn the dial up again.
- Check your calendar. The entire {Brand System}, including the Pool Frog Mineral Reservoir, needs to be replaced every four months. Without the minerals, {53735-14 Brand Name} will not be enough to sanitize the {spa} {hot tub} {swim spa}.

{53735-14 Brand Name} Life

- If {{spa} {hot tub} is larger than 400 gallons} {swim spa is larger than 2000 gallons} with significant bather load, you may require a higher dial setting which will shorten the cartridge life.
- If you think the cartridge setting is too high, you can turn the dial setting down 1 number while maintaining water balance. If needed turn the dial down again.
- If {Brand} System continually is sucked into the skimmer or filter well, tether the product to the tub away from the jets.

- Remove {Brand} System while using the hot tub with the jets running

High Chlorine Levels

- This is highly unlikely with {Brand System} because {53735-14 Brand Name} is self-regulating. However, if you use standard test strips, it may appear that total chlorine is higher than the free chlorine. No worries—the strip is measuring the {53735-14 Brand Name} reserve, which will shift to free chlorine as needed. Please always use the {Brand} Test Strips that were included with your System.

Learn more at [{kingtechnology.com}](#) [{frogproducts.com}](#) or call 800.222.0169

Register your Floating System at [{kingtechnology.com}](#) [{frogproducts.com}](#)

[Operational Instructions 8 for Spa Cartridge used in In-Line System with 53735-14 Brand Name]

[All text is optional]

In-Line Sanitizing System Operating Instructions

{{Brand} System is the {spa} {hot tub} sanitizing system that takes the guess work out of water so you always feel at ease while enjoying your {spa} {hot tub}.

- {Brand} creates Fresh Mineral Water[∞] that's cleaner, clearer and softer
- {Brand} employs {53735-14 Brand Name} Technology that knows when and how much free chlorine is needed so it uses up to 75% less.*
- {Brand} requires far less shocking – only once a month!

Register your In-Line System at kingtechnology.com frogproducts.com

* Compared to the minimum ANSI recommended chlorine level of 2.0 ppm for a {spa} {hot tub}.

Let Us Dissect This System For You: The complete In-Line System

The In-Line System is made up of (A) a cap that is easily distinguishable among the fittings on the top {rim} {edge} of the {spa} {hot tub}, (B) a cartridge holder that pulls out of the installed system inside the {spa} {hot tub}, (C) a Pool Frog Mineral Reservoir that helps control bacteria in the water and (D) a {chlorine} {sanitizer} {disinfectant} {{53735-14 Brand Name}} cartridge that helps support the minerals while oxidizing contaminants like body oils{and ammonia compounds responsible for smelly chloramines} . The cartridges are adjustable to meet your specific {spa} {hot tub} water care needs.

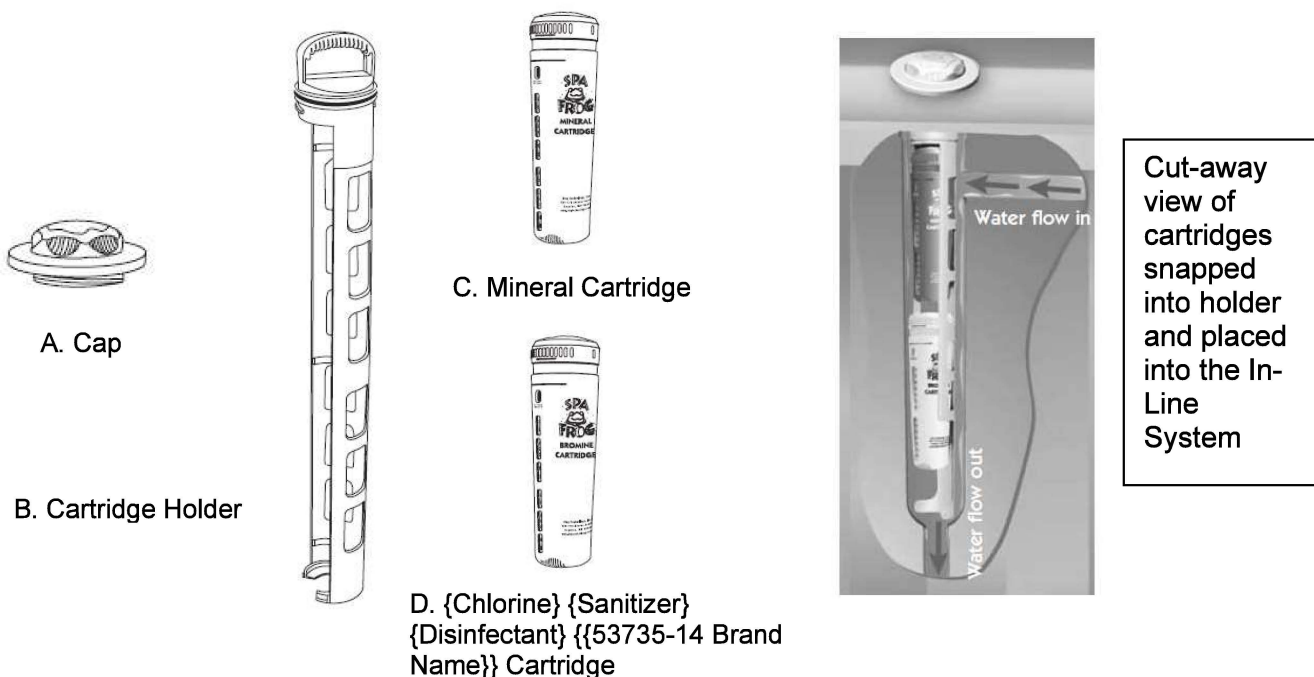

{Start Up} {Step One: Prepare}ing} the {Hot Tub} {Spa}} {Follow all directions from your {spa} {hot tub} manufacturer on filling and balancing the water in your {spa} {hot tub}. Standard guidelines for balancing the water are as follows:}

1. Fill {spa} {hot tub} with fresh water. If using source water that is high in calcium, iron or other metals, see your dealer before filling the tub. {It may require the use of a metal control product.} If previously using bromine {and switching to {53735-14 Brand Name}}, you must drain and refill {your {spa} {hot tub}} {before using this product}. {If previously using dichlor you may convert to {53735-14 Brand Name} without having to drain the {spa} {hot tub} as long as the {stabilizer} {conditioner} {cyanuric acid} level is below {50} {80} ppm.}
2. Clean or replace filter cartridges {when dirty} (*Follow manufacturer's instructions*).
3. Balance water by following steps a through d in order. **IMPORTANT:** Always follow printed instructions on the balancing chemical packages. Add balancing chemicals in small increments one at a time with the jets on and wait 6 hours before testing again and adding any additional balancing chemicals.
 - a. Take a water sample from the {spa} {hot tub} and dip a {Brand} Test Strip into it.
 - b. Look at the Total Alkalinity reading first. Adjustments should be made to bring the Total Alkalinity in the range of 80 – 120 ppm prior to making any adjustments to pH even if it throws pH off further. {Since pH tends to rise in hot tubs, maintaining a Total Alkalinity closer to the low end of 80 will make managing the hot tub easier.}
 - c. After Total Alkalinity is in range, test for pH. It should be between 7.2 and 7.8. If higher or lower, add a pH adjuster. {Again, due to rising pH in hot tubs, try to maintain as close to the low end of 7.2 as possible.}
 - d. Lastly test for Calcium Hardness. It should be between 150 and 250 ppm. If higher, partially drain the {spa} {hot tub} (about 6 inches) and fill with water low in calcium. If lower, add Calcium Increaser.

Water Balance Guidelines

pH:	7.2-{7.6} {7.8}
Total Alkalinity:	80-120 ppm
{Calcium} Hardness:	150-250 ppm
Total Dissolved Solids:	<1500
{Stabilizer} {/} {Conditioner}	
{Cyanuric Acid}:	{0}{20}{30}-{50}{80} ppm
{*Free Chlorine}:	0.5-1.0 ppm

{If balancing takes longer than 2 days, shock the water and maintain a chlorine level while continuing balancing.}

4. **Very Important!** {After balancing and} Before using cartridges, {establish} {ensure there is} an initial residual of 0.5-1.0 ppm {free} chlorine with {{53735-12 Brand Name} start-up shock {included in this package}} {an EPA registered chlorine shock}. {that} quickly dissolves with an effervescent {fizzing} action – one packet per {500} {600} gallons
5. {Heat water to the manufacturers recommended temperature.}

Step Two: Set the Cartridges

The {Brand} In-Line System uses two replaceable cartridges.

- {Insert Color} = Pool Frog Mineral Reservoir
- {Insert Color} = {53735-14 Brand Name}

The combination provides the Fresh Mineral Water[∞] benefits of cleaner, clearer and softer water that's easier to take care of. Remove the shrink wrap from both cartridges before proceeding.

- Set the {insert color} Pool Frog Mineral Reservoir to #6 (hold the bottom and turn the top until 6 appears in the window). No further adjustments are necessary for the life of the cartridge.
- Set the {insert color} {53735-14 Brand Name} to the setting that matches your {spa} {hot tub} size in gallons {and pump run time per day}. {53735-14 Brand Name} will maintain a low 0.5 to 1.0 ppm chlorine level as long as the pH stays within 7.2 and 7.8 so there is little need to adjust the cartridge setting. If needed, you {may increase or decrease the dial setting} {have two additional settings to increase output}.

INITIAL START-UP SETTING

{53735-14 Brand Name} Setting Chart	
Gallons	Setting #

X-X	#
X-X	#
X-X	#
X-X	#
X-X	#
X-X	#

[Note to Reviewer: the spa/hot tub gallon range in the setting chart will be between 200 and 600 gallons]

{NOTE: The more you use the {spa} {hot tub}, for instance when you first {get it} {own it}, the greater the setting to achieve at least 0.5 ppm. (This may require a higher setting than what is listed in the chart.) If usage decreases or the chlorine level is greater than 1.0 ppm, lower the setting.}

Step Three: Put{ting} the System to Work

- Open cap of In-Line System and set aside. DO NOT OPEN CAP WHILE JETS ARE ON.
- Remove holder by pushing down and turning counterclockwise 1/8th turn before pulling out.
- {Remove spent cartridges by pushing bottom out through openings in back of holder. Then grab cartridge and pull out.}
- Snap the Pool Frog Mineral Reservoir into the area marked “Minerals” (top portion) and the {53735-14 Brand Name} Cartridge into the area marked {“Bromine”} {or Chlorine”} {or SmartChlor”} (bottom portion) making sure to line up the indentation at the top of the cartridges with the raised area on the holder.

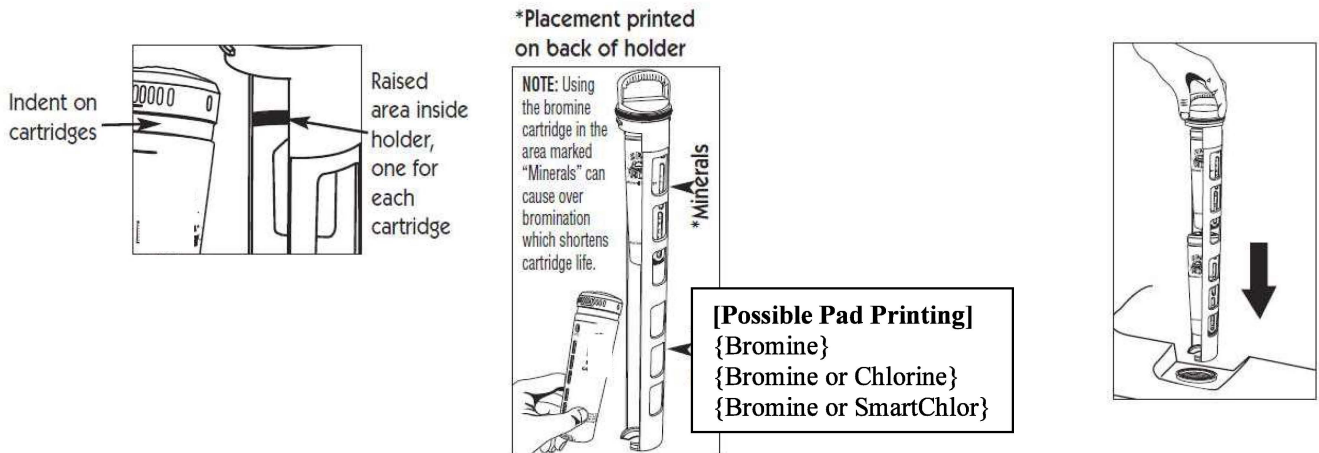

- Slowly insert holder into system (see diagrams). Line up holder arrow-① with system arrow-②. Push down until holder tabs-③ go past system tabs-④ and turn holder {to the right} {(clockwise)} until it stops. To ensure a locked position, attempt to pull holder up. If it stays in place, the lock is secure.

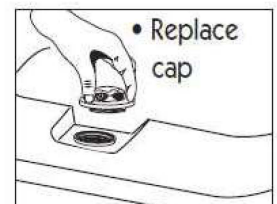
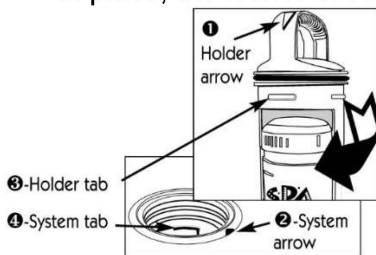

Replacing Cartridges

- Replace {insert color} Pool Frog Mineral Reservoir every four months or when draining and refilling {spa} {hot tub}.
 - Discard it in the trash even if it appears to have media left inside
 - Don't attempt to reuse: the minerals are spent after 4 months
 - {Use the enclosed stickers to remind you when it's time to replace}
- Replace {insert color} {53735-14 Brand Name} when empty based on the {Brand} test strip showing a lighter color than the out indicator {on the {test strip} bottle}
 - The life of the cartridge varies depending on {spa} {hot tub} size and number of users. The {53735-14 Brand Name} will last {about 3-4} {up to 4} weeks for an average 400 gallon hot tub. Drain water from cartridge to ensure it is empty. Discard in trash or offer for recycling if available.

{Step Four: Routine} {Regular} {Spa} {Hot Tub} Care {Procedures}:}

{Always follow the directions for operating your particular {spa} {hot tub}.}

- Drain and refill {spa} {hot tub} as directed by your {spa} {hot tub} manufacturer} {or every four months when {Brand} Minerals need to be replaced}. {Whenever you drain and refill, make sure to replace your {Brand} Minerals.}
- Run filtration system as {manufacturer recommends} {directed by your {spa} {hot tub} manufacturer} {to maintain proper water flow through the In-Line System {or at least 3 hours per day}}.
- {Periodically} {Regularly} {Weekly} test water {with {Brand} Test Strips and follow directions in {Step One} {Start-up} for maintaining pH, total alkalinity {and calcium hardness}}.
- NOTE: pH is affected by {weather} bather load, chemicals used, evaporation and the make-up of your source water so maintaining water balance regularly is important. {Use {Brand} Test Strips {that came with your {Brand} Mineral System} or a test kit to routinely check your pH, Total Alkalinity and Calcium Hardness.}
- {{53735-14 Brand Name} will maintain {at least a 0.5 ppm} {a 0.5 – 1.0 ppm} free chlorine level {as long as the water is balanced} {at all times}. On the {Brand} Test Strip is an Out Indicator that shows when the {53735-14 Brand Name} is empty. {The {53735-14 Brand Name} forms a chlorine {bank} {reserve} that is measured as total chlorine on a standard test strip/kit. This chlorine {bank} {reserve} readily shifts to free chlorine as needed to maintain {a desirable} {our recommended} low level of chlorine {available for disinfection}.} {Based on average {spa} {hot tub} usage,} chlorine will last {on average} {about} {up to} {2} {3}-4 weeks for {spas} {hot tubs} {up to} {of} {350} {400} {500} {600} gallons.}}

NOTE: Free chlorine levels are reduced up to 75%* when using {Brand} Minerals {and {53735-14 Brand Name} Technology}. Use test strips {that came with your {Brand} Mineral System} or a test kit to routinely check your pH

{NOTE: Why {Brand} Test Strips? The {53735-14 Brand Name} forms a chlorine reserve that will be inaccurately measured as total chlorine on other test strips. Unlike conventional chlorine, the {53735-14 Brand Name} reserve readily shifts to free chlorine as needed, maintaining {spa} {hot tub} health with a low level of chlorine.}

- Shock the {spa} {hot tub} with {{Brand Name} for easy single-dose shocking} {granular chlorine or} {a} {non-chlorine shock} {when you replace the {53735-14 Brand Name}}

Cartridge or once a month} {if the water looks cloudy} {and/or add a {spa} {hot tub} clarifier according to label directions}. {With {53735-14 Brand Name}, far less shocking is required compared to standard water treatments that require weekly shocking or shocking after every use.} See troubleshooting for other issues.

- {Remember to} Replace your {53735-14 Brand Name} cartridges and the complete {Brand} System (that comes with a Pool Frog Mineral Reservoir)} as directed {under “Step 3: Put{ting} the system to work”}.
- Lubricate in-Line holder o-ring twice a year with a silicone lubricant.

Troubleshooting

Cloudy Water {or Low Chlorine Levels}

- Shock the {spa} {hot tub} with {Brand Name} {or} {a} {non-chlorine shock}
- Check water balance. pH and Total Alkalinity need to be in the proper ranges for the {Brand} System to work correctly
- Check {53735-14 Brand Name} and replace if empty—see instructions under {Replacing Cartridges} {Step 3: Put{ting} the System to Work}
- If {53735-14 Brand Name} is not empty, turn dial setting up 1 number while maintaining water balance. If needed turn dial up again.
- Check your calendar. The entire {Brand} System, including the Pool Frog Mineral Reservoir, needs to be replaced every four months. Without the minerals, {53735-14 Brand Name} will not be enough to sanitize the {spa} {hot tub}.

{53735-14 Brand Name} Life

- If hot tub is larger than 400 gallons {or has} {with} significant bather load, you may require a higher dial setting which will shorten the cartridge life.
- If you think the cartridge setting is too high, you can turn the dial setting down 1 number while maintaining water balance. If needed turn the dial down again.

High Chlorine Levels

- This is highly unlikely with {Brand} System because {53735-14 Brand Name} is self-regulating. However, if you use standard test strips, it may appear that total chlorine is higher than the free chlorine. No worries—the strip is measuring the {53735-14 Brand Name} reserve, which will shift to free chlorine as needed. Please always use the {Brand} Test Strips that were included with your System.

Learn more at {kingtechnology.com} {frogproducts.com} or call 800.222.0169

[Operational Instructions 9 for Spa Cartridge used in {Filter Well} System with 53735-14 Brand Name]

[All text is optional]

{Brand} Sanitizing System Operating Instructions

{Brand} is a {spa} {hot tub} sanitizing system {{specially made} {custom {fit} {designed}}} {exclusively} for {Brand} Spas that takes the guess work out of water care so you always feel at ease while enjoying your {spa} {hot tub}.

- {Brand} System creates Fresh Mineral Water[∞] that's cleaner, clearer and softer
- {Brand} System employs {53735-14 Brand Name} Technology that knows when and how much free chlorine is needed so it uses up to 75% less.*
- {Brand} System requires far less shocking – only once a month!}

* Compared to the minimum ANSI recommended chlorine level of 2.0 ppm for a {spa} {hot tub}.

Read entire operating instructions for complete directions for use

Step One: Prepar{e}{ing} the {Hot Tub} {Spa}

1. Fill {spa} {hot tub} with fresh water. If using source water that is high in calcium, iron or other metals, see your dealer before filling the tub. {It may require the use of a hose filter and/or metal control product.} If previously using bromine and switching to {53735-14 Brand Name}, you must drain and refill your {spa} {hot tub} before using this product. If previously using dichlor you may convert to {53735-14 Brand Name} without having to drain the {spa} {hot tub} {as long as your {stabilizer} {conditioner} {cyanuric acid} level is below {50} {80} ppm}.
2. Clean or replace filter cartridges {when dirty} (*Follow manufacturer's instructions*).
3. Balance water following steps a through d in order. **IMPORTANT:** Always follow printed instructions on the balancing chemical packages. Add balancing chemicals in small increments one at a time with the jets on and wait 6 hours before testing again and adding any additional balancing chemicals.
 - a. Take a water sample from the {spa} {hot tub} and dip a {Brand} Test Strip into it.
 - b. Look at the Total Alkalinity reading first. Adjustments should be made to bring the Total Alkalinity in the range of 80 – 120 ppm prior to making any adjustments to pH even if it throws pH off further. {Since pH tends to rise in hot tubs, maintaining a Total Alkalinity closer to the low end of 80 will make managing the hot tub easier.}
 - c. After the Total Alkalinity is in range, test for pH. It should be between 7.2 and 7.8. If higher or lower, add a pH adjuster. {Again, due to rising pH in hot tubs, try to maintain as close to the low end of 7.2 as possible.}
 - d. Lastly test for {Calcium} Hardness. It should be between 150 and 250 ppm. If higher, partially drain the {spa} {hot tub} (about 6 inches) and fill with water low in calcium. If lower, add Calcium Increaser.

Water Balance Guidelines	
pH:	7.2-{7.6} {7.8}
Total Alkalinity:	80-120 ppm
{Calcium} Hardness:	150-250 ppm
Total Dissolved Solids:	<1500
{Stabilizer} {/} {Conditioner}	
{Cyanuric Acid}:	{0}{20}{30}-{50}{80} ppm
{Free Chlorine}:	0.5-1.0 ppm

If balancing takes longer than 2 days, shock the water and maintain a chlorine level while continuing balancing.

4. **Very Important!** After balancing and before using cartridges, {establish} {ensure there is} an initial residual of 0.5-1.0 ppm {free} chlorine with {{53735-12 Brand Name} start-up shock {included in this package} that quickly dissolves with an effervescent {fizzing} action – one packet per {500} {600} gallons} {a chlorine shock}.

- Heat water to the manufacturers recommended temperature.

{Step Two: Set{ting} the Cartridges}

The {Brand} System uses two replaceable cartridges.

- {Insert Color} = Pool Frog Mineral Reservoir
- {Insert Color} = {53735-14 Brand Name}

The combination provides the Fresh Mineral Water[∞] benefits of cleaner, clearer and softer water that’s easier to take care of.

- Remove the {53735-14 Brand Name} from its bag before proceeding.
- Set the {insert color} Pool Frog Mineral Reservoir to # using the dial on {the bottom of} the cartridge. No further adjustments are necessary for the life of the cartridge.
- Set the {insert color} {53735-14 Brand Name} to the setting that matches your {spa} {hot tub} {model number} {or size in gallons}. If needed, you may increase or decrease the dial setting.
- Once set, {53735-14 Brand Name} will maintain a low 0.5 to 1.0 ppm chlorine level as long as the pH stays within 7.2 and 7.8 so typically there is little need to adjust the cartridge setting.

{53735-14 Brand Name} Setting Chart		
{Brand} Models	{Gallons}	Setting #
a, b, c	{x-x}	#
d, e, f	{x-x}	#
g, h, i	{x-x}	#
j, k, l	{x-x}	#
m, n, o	{x-x}	#
p, q, r	{x-x}	#

[Note to Reviewer: the spa/hot tub gallon range in the setting charge will be between 200 and 600 gallons.]

Step Three: Put{ting} the System to Work

[OPTION FOR BRAND A SPAS SERIES X] For #, # and # Series

- Remove filter snap cap. Hold weir door/filter plate out into the hot tub slightly or remove from the hot tub.
- If cartridge {holder} {carrier} is already installed between the filter cartridges, remove by pulling up on the handle.
- Snap the Pool Frog Mineral Reservoir into {one} {top} {bottom} {left side} {right side} {front} {back} opening of the cartridge {holder} {carrier}. With the {Brand} logo facing the {holder} {carrier}, put the dial end of the cartridge into the {holder} {carrier} first by connecting the tab on the {holder} {carrier} with the indent in the cartridge. Then push the top part of the cartridge {up} {in} until it snaps into place.
- Follow the same procedure for the {53735-14 Brand Name} Cartridge into the other opening.
- With the {insert color} {53735-14 Brand Name} facing the inside of the hot tub, Insert cartridge {holder} {carrier} between the filter cartridges under the weir door/filter plate pushing down until it stays in place.
- Replace filter snap cap.

[Callouts for this section] {Dial end of} Cartridge, {Holder} {Carrier}, {Detail of Cartridge} {Holder} {Carrier} Tab

[OPTION FOR BRAND A SPAS SERIES XX] For # Series

- Turn off main power to the {spa} {hot tub} and remove the JetPak to the right of the main control.
- Remove Simplicity Filter Holder by taking hold of the handle, pushing it {into} {towards the middle of} the {spa} {hot tub} and lift out.
- Insert Pool Frog Mineral Reservoir and {53735-14 Brand Name} into the two openings below the filter cartridge. Push cartridges in until they are latched
- To remove cartridges, push them in until they are free of the latches, then slide them out.
- Replace Simplicity Filter Holder and the JetPak over it. Turn on main power.

[Callouts for this section] Simplicity Filter Holder, Two openings for cartridges, Cartridges installed

[OPTION FOR BRAND B SPAS]

- Remove the filter cover.
- If the {Brand} cartridge {holder} {carrier} is already installed, remove {holder} {carrier} by pulling up and away from filter cartridge using the handle at the top of the {holder} {carrier}.
- Open the arms of the {Brand} cartridge {holder} {carrier} until they snap into position. The handle with the {Brand} logo is the top of the {holder} {carrier}.
- Inserting the Pool Frog Mineral Reservoir into the holder: With the {Brand} logo facing up, place the bottom of the rounded edge of the cartridge into the front of {the upper} {the lower} {one} opening of the {holder} {carrier} and push the cartridge back until it locks into place.
- Follow the same procedure with the {53735-14 Brand Name} in the {other} {upper} {lower} opening.
- Unscrew both hot tub filter cartridges to find the one that does not have a grid underneath it. Once determined, screw both filter cartridges back in place.
- Installing the {Brand} {holder} {carrier}: With the {Brand} cartridges facing the inside of the hot tub and the handle of the {holder} {carrier} at the top, slide the {holder} {carrier} down over the filter cartridge that does NOT have the grid underneath it until it covers the entire length of the filter cartridge. If necessary, spread the arms on the {holder} {carrier} to get them around the filter cartridge.
 - Note: {On some {Brand} Spas} {Sometimes}, the filter cartridge over the grid is a {2 part} {ProClarity™} {cartridge system with a plastic base}. Always install the {Brand} cartridge {holder} {carrier} on the {1 piece} {other} filter cartridge.
- In order to re-install the filter cover, you must first rotate the {Brand} {holder} {carrier} by pulling the top part out about ½" away from the filter cartridge and turning the {holder} {carrier} until it touches the other filter cartridge.
- Re-install the filter cover.

[Callouts for this section] {Rounded edge of} Cartridge, {Holder} {Carrier}, {Front of} {Holder} {Carrier} {Opening}, {Filter Cartridge grid}

[OPTION FOR BRAND B SPAS FLOATER] Simply follow these easy steps:

- Remove outer packaging from {53735-14 Brand Name}.
- Set the dial on the Pool Frog Mineral Reservoir to wide open on setting x.
- Set the dial on the {53735-14 Brand Name} to the setting number based on your {spa} {hot tub} model number (see chart).
- Insert the two cartridges into the holder one at a time. Put bottom of cartridge into holder bracket with setting dial facing out. Then push cartridge in place.
- Place into the {spa} {hot tub} to float.
- If you like, remove {Brand} System from the {spa} {hot tub} while {bathing} {soaking}. Lift out {Brand} System and let drain into the {spa} {hot tub}. Place on any surface not susceptible to chlorine bleaching. Remember to return it to the {spa} {hot tub} afterwards.

[OPTION FOR BRAND C SPAS]

- Remove the filter lid.
- Installing the {Brand} cartridge {holder} {carrier}: with the filter cartridge in place, slide the {Brand} {holder} {carrier} down over the pipe where the nut is that holds the filter cartridge on. Make sure the openings for the {Brand} cartridges are facing the filter area and the fin on the {holder} {carrier} goes between two pleats on the filter cartridge. Push the {holder} {carrier} down using the top handle until it snaps in place. {Do not install on the other side of filter cartridge.}
- Inserting the Pool Frog Mineral Reservoir into the {holder} {carrier}: With the {Brand} logo facing up, place the bottom of the rounded edge of the cartridge into the front of the {holder}

{carrier} opening closest to the {outside} {inside} of the {spa} {hot tub} and push the cartridge back until it locks into place.

- Follow the same procedure to insert the {53735-14 Brand Name} in the {other} opening {closest to the {outside} {inside} of the {spa} {hot tub}}.
- Make sure the cartridges are completely under water. If not, add water to the {spa} {hot tub} until the cartridges are covered and balance the pH and Total Alkalinity.
- Re-install the filter lid.

[Callouts for this section] {Rounded edge of} Cartridge, {Holder} {Carrier}, {Front of} {Holder} {Carrier} {Opening}, {Filter Cartridge} {Nut}, {Pipe}, {Wall of} {Spa} {filter well}, {Fin}

[OPTION D]

- Remove the filter {lid} {cover}.
- Insert {Brand} {holder} {carrier} in the filter well area per the diagram
- Snap Pool Frog Mineral Reservoir into one opening and {53735-14 Brand Name} into the other opening.
- Re-install the filter {lid} {cover}.

Replacing Cartridges

- Replace {insert color} Pool Frog Mineral Reservoir every four months or when draining and refilling the {spa} {hot tub}.
 - Discard it in the trash even though you will hear the spent media left inside
 - Don't attempt to reuse: the minerals are spent after 4 months
 - {This cartridge is available only in the {Brand} System}
- Replace {insert color} {53735-14 Brand Name} when empty based on the {Brand} test strip showing a lighter color than the out indicator {on the {test strip} bottle}
 - The life of the cartridge varies depending on {spa} {hot tub} size and number of users. {53735-14 Brand Name} will last {about 3-4} {up to 4} {2-4} weeks for an average 400 gallon hot tub.
 - Drain water from cartridge to ensure it is empty
 - Discard in trash or offer for recycling if available.

Step Four: Routine {Spa} {Hot Tub} Care:

- Drain and refill {spa} {hot tub} as directed by your {spa} {hot tub} manufacturer {or every four months when Pool Frog Mineral Reservoir need to be replaced}. {Whenever you drain and refill, make sure to replace your {Brand} Minerals.}
- Run filtration system as {directed} {recommended} by your {spa} {hot tub} manufacturer to maintain proper water flow through the system.
- Regularly test water with {Brand} Test Strips and follow directions in Step One for maintaining pH, Total Alkalinity and {Calcium Hardness}.
- NOTE: pH is affected by {weather} bather load, chemicals used, evaporation and the make-up of your source water so maintaining water balance regularly is important.
- {53735-14 Brand Name} will maintain {at least a 0.5 ppm} {a 0.5 – 1.0 ppm} free chlorine level as long as the water is balanced.

NOTE: Free chlorine levels are reduced up to 75%* when using {Brand Name} Minerals {and {53735-14 Brand Name} Technology}.

{NOTE: Why {Brand} Test Strips? The {53735-14 Brand Name} forms a chlorine reserve that will be inaccurately measured as total chlorine on other test strips. Unlike conventional chlorine, the {53735-14 Brand Name} reserve readily shifts to free chlorine as needed, maintaining spa health with a low level of free chlorine.}

- Shock the {spa} {hot tub} with {granular chlorine or} {{Brand Name}} for easy single-dose shocking} {a} {non-chlorine shock} {when you replace the {53735-14 Brand Name} Cartridge or once a month} {or if the water looks cloudy}.
- {Remember to} Replace your {53735-14 Brand Name} and complete {Brand} System (that comes with a Pool FROG Mineral Reservoir) as directed {under “Step 3: Put{ting} the System to Work”}.

Troubleshooting

Cloudy Water {or Low Chlorine Levels}

- Shock the {spa} {hot tub} with {Brand Name} {or} {a} {non-chlorine shock}
- Check water balance. pH and Total Alkalinity need to be in the proper ranges for the {Brand} System to work correctly. {Since pH tends to rise in hot tubs, maintain Total Alkalinity and pH closer to the lower end of the ideal range on the {Brand} Test Strip.}
- Check {53735-14 Brand Name} and replace if empty—see instructions under {Step 3:} {Put{ting} the System to Work} {Replacing Cartridges}
- If {53735-14 Brand Name} is not empty, turn dial setting up 1 number while maintaining water balance. If needed turn dial up again.
- {Check} {Mark} your calendar. The entire {Brand} System including a Pool Frog Mineral Reservoir needs to be replaced every four months. Without the minerals, {53735-14 Brand Name} will not be enough to sanitize the {spa} {hot tub}. Simply purchase a new {Brand} System package for a new Pool Frog Mineral Reservoir.

{53735-14 Brand Name} Life

- If hot tub is larger than 400 gallons with significant bather load, you may require a higher dial setting which will shorten the cartridge life.
- If you think the cartridge setting is too high, you can turn the dial setting down 1 number while maintaining water balance. If needed turn the dial down again.

High Chlorine Levels

- This is highly unlikely with {Brand} System because {53735-14 Brand Name} is self-regulating {the free chlorine levels}. However, if you use standard test strips, it may appear that total chlorine is higher than the free chlorine.
- No worries—the strip is measuring the {53735-14 Brand Name} reserve, which will shift to free chlorine as needed. Please always use the {Brand} Test Strips that were included with your System.

Learn more at kingtechnology.com frogproducts.com or call 800.222.0169

Register your {Brand} Sanitizing System at kingtechnology.com frogproducts.com

[Additional copy for Water Balance Guide insert for Pool Frog Mineral Reservoir use with {53735-14 Brand Name} – All copy is optional]

Hot Tub Water Balance Guide: How to get your hot tub relaxation ready. Before you balance:

Step 1 – Test your water for hardness. Take a sample of the water you plan to use to fill your hot tub to your dealer and check for hardness. If over 250 ppm, don't use that water to fill your hot tub! A simple hose filter from your local dealer can solve your issue.

Step 2 – After the hot tub is filled, take a sample of that water to your dealer to check for metals. If it tests high for metals, use a metal out product.

4 Tips for successful weekly balancing

5. Always balance in order with Step 1: Total Alkalinity, then Step 2: pH and then Step 3: recheck water hardness.

Step 1: Total Alkalinity 80-120 ppm: Starting with Total Alkalinity (TA) first will make it much easier to balance the pH. Low TA: add TA Increaser or TA Up. High TA: add the same product that lowers pH usually called pH Decreaser or pH Down.

STOP: Proceed to pH ONLY when Total Alkalinity is between 80 and 120 ppm

Step 2: pH 7.2-7.8: pH is important for maintaining clean, clear water that doesn't attack surfaces or irritate skin. Low pH: add a pH Increaser or pH Up product. High pH: add a pH Decreaser or pH Down product.

STOP: Proceed to Water Hardness ONLY when pH is between 7.2 and 7.8.

Step 3: Water Hardness 150-250 ppm: Check Water Hardness AGAIN to make sure the calcium level is not too low so the water does not corrode surfaces. Low Water Hardness: if Water Hardness is under 150 ppm, add Calcium Increaser.

6. Add adjustment chemicals in small increments (follow label directions carefully)
7. Wait 6 hours between adjustments so your adjustment chemical has time to work
8. If balancing takes longer than 2 days, add a chlorine shock to maintain sanitizer levels.

When Total Alkalinity is 80-120, pH is 7.2-7.8 and water hardness is 150-250 ppm, your water is balanced.

Troubleshooting Tips for {Brand} Mineral Floating or In-Line Systems

Hot tub owners tell us the {Brand} Mineral System is the easiest water care system they have ever used. The key is to maintain water balance and make sure you replace the {53735-14 Brand Name} when empty (approximately every 3-4 weeks). Here are a few tips should you experience one of these issues:

Cloudy Water / Under Chlorination

1. Check your water balance. If your pH or TA is off, {53735-14 Brand Name} will not be as effective. Most often the free chlorine residual is low when the pH is too high. Add pH Down to bring the pH into the ideal range of 7.2-7.8. The free chlorine residual will then come back up to 0.5 ppm after the pH adjust has been made.
2. Check to see if your {53735-14 Brand Name} is empty. In some circumstances, the system may not completely flip over. Pull it out of the hot tub and drain all the water. Then put it back in. If it immediately flips over, it's empty. You can also shake it slightly to feel if there is any {53735-14 Brand Name} material left in side.
3. Make sure your Pool Frog Mineral Reservoir have not been used for more than 4 months. When you hear minerals left inside the blue cartridge, it is because one of the minerals does not completely dissolve. The mineral that does the bacteria fighting however only lasts 4 months so you must replace the Pool Frog Mineral Reservoir at that time. We suggest making a note on your calendar for the replacement date of the minerals and be sure to replace every time you drain and refill your hot tub

High Combined Chlorine Levels

1. This is normal! With the {Brand} Mineral System self-regulating process, there is a chlorine reserve that converts to free chlorine automatically when needed.

2. When testing {53735-14 Brand Name} with a standard test strip, you will see the total chlorine is higher than the free chlorine. The total is the {53735-14 Brand Name} reserve that is inactive. When the hot tub needs more free chlorine to kill bacteria, it pulls from the reserve. Therefore, no shocking is required when the total reading is different than the free reading.
3. To prevent confusion, always use {Brand} Test Strips. A 30-count bottle comes with every {Brand} Mineral Floating and In-Line System.

[Copy for packaging and labeling - All text on this page is optional]

{{Brand} Mineral {System} {Technology} {Formula}+ improves {swimming pool pleasure} {your swimming experience} by reducing the problems associated with chlorine. {Experience the {Brand} difference} {It gives you}:

- Less work with no daily dosing {of minerals or chlorine}.
- Sparkling water for above ground and in ground pools.
- Prefilled pacs eliminate fumes typical of chlorine buckets.
- Reduces Fading Swimsuits
- Lower chlorine levels help prevent damage to equipment and surfaces.
- A neutral pH with less monitoring

Let Us Dissect This {Brand} For You

A Mineral {Sanitizing} {Disinfecting} System With 3-Parts

- {Brand} Cyclor holds the Mineral Reservoir and {53735-2 Brand Name}
- Pool Frog Mineral Reservoir contains the minerals
- {Brand} chlorine {53735-2 Brand Name} (sold separately) provides low chlorine support.

Here's How It Works

- The {Brand} System destroys bacteria
- The {Brand} Mineral System reduces chlorine use up to 50% compared to the minimum EPA recommended chlorine level of 1.0 ppm for a stabilized swimming pool.
- When using the chlorine {53735-2 Brand Name} water flows through minerals and chlorine so one unit does all.

{Brand} is more fun

Up To 50%* Chlorine Reduction with {Brand} Mineral System

Take home the complete mineral system including:

{Brand}'s Complete Pool Care System includes:

1. Pool Frog Mineral Reservoir
 - Fits inside the {Brand} Cyclor
 - Contains minerals that help to {control} {destroy} bacteria
 - Replace mineral reservoir every season – do not use more than 6 consecutive months.
2. {53735-2 Brand Name} (sold separately)
 - Prefilled with Trichlor (chlorine) tablets.
 - Sits inside the Pool Frog Mineral Reservoir for a complete system
 - Set the Cyclor dial for achieving at least 0.5 ppm chlorine level (see instruction manual)
 - Replace {53735-2 Brand Name} when empty
3. {53735-9 Brand Name} Algae Preventative (sold separately)
 - Algae Protection Guarantee when used with the Complete {Brand} System
 - Dispenses in 90 minutes and provides 90 days of algae protection

Don't forget {53735-13 Brand Name} for spring openings and {53735-13 Brand Name} for pool closings.

There's a {Brand} For You!

[All text on this page is optional]

{Brand} Copy by Category:

1. Less Work

- Less work with a 6 month Mineral Reservoir and pre-filled chlorine {53735-2 Brand Name}.
- Less work with prefilled disposable cartridges.
- No more daily maintenance with replacement products that last weeks or months at a time.
- Take back the fun of your pool by reducing the work and increasing the pool's life.
- {{Brand} offers} more fun {with your family}! Let {Brand} do the work for you.
- Relaxation and peace of mind.
- Set the Cyclor valve and it dispenses minerals and chlorine automatically.
- Automatic dispensing of minerals and {chlorine} {bromine} – Automatic pool care.

2. Less {Chlorine} {Bromine}

- {Brand} is a mineral system with a prefilled {53735-2 Brand Name} that meets the EPA requirements to lower previously approved safe chlorine levels by up to 50%.* (*1.0 ppm was EPA's previously approved safe level for a stabilized swimming pool).{for pools}
- Pool Frog Mineral Reservoir is a mineral system using a prefilled bromine cartridge that meets the EPA requirements to lower previously approved safe bromine levels by up to 50%.* {for spas} {for hot tubs}
- With standard chlorine products for swimming pools, EPA has NOT approved a chlorine level of 0.5 ppm without using minerals.
- With standard bromine {or chlorine} products for {spas} {hot tubs} and hot tubs, EPA has NOT approved a bromine {or chlorine} level of 1.0 ppm without using minerals.
- The {Brand} Mineral {System} {Technology} {Formula}+ destroys bacteria so less {chlorine} {bromine} is needed for complete {pool} {spa} {hot tub} care.
- Minerals help destroy bacteria so less {bromine} {or chlorine} is needed for complete {spa} {hot tub} care.
- Lowers {chlorine} {bromine} {usage} {use}
- Reduces {chlorine} {bromine} consumption
- {Brand} Mineral {System} {Technology} {Formula}+ reduces the formation of chloramines and odors.
- {Brand} Mineral {System} {Technology} {Formula}+ reduces chloramines and its effects.

3. Water Quality

- Minerals make a difference you can see and feel.
- Water feels softer with a crystal clear shine.
- For softer water with a crystal clear shine.
- {Brand} minerals condition the water for extra softness.
- {Brand} Mineral {System} {Technology} {Formula}+ reduces the problems associated with {chlorine} {bromine} like {faded} {fading} swimsuits.
- Lower chlorine levels help prevent damage to equipment and surfaces.
- Spend the day in the {pool} {spa} {hot tub} without worrying about faded swimsuits.
- Pool Frog gives you a reliable way to have fresh, clean, clear water in your family's {pool} {spa} {hot tub}.
- With Pool Frog Mineral Reservoir your {spa} {hot tub} will have the feel of a hot spring in the Rocky Mountains cascading over your tired limbs and soothing muscles.
- Pool Frog Mineral Reservoir transforms your {spa} {hot tub} into the perfect environment for soothing relaxation.
- The perfect {spa} {hot tub} environment.

[All text on this page is optional]

- Makes water brilliantly clear {and soft}
 - Restores water clarity
 - {Brand} Mineral {System} {Technology} {Formula}+ conditions water for extra softness
 - The Pool Frog Mineral {system} {formula} destroys bacteria and reduces chlorine use so the water is easy on swim suits, and less irritating to skin.
 - Effectively {fights} {destroys} bacteria
 - Prevents the things you don't like about chlorine like bleached swim suits
4. How {Brand} Mineral {System} {Technology} {Formula}+ Works
- {Brand} Mineral {System} {Technology} {Formula}+ helps rid the water of harmful bacteria.
 - {Brand}'s {patented} mineral {System} {Technology} {Formula}+ destroys bacteria with a controlled release formula that lasts {6} {4} months.
 - {Brand} minerals also help keep your pH balanced by acting as a neutralizer.
 - Complete mineral pool care works in all pools.
 - Complete mineral {spa} {hot tub} care works in all {spas}* {hot tubs*}. (*Any {spa} {hot tub} can take advantage of a complete system including the Pool Frog Mineral Reservoir used with the {53735-10 or 53735-16 Brand Name}.)
 - Improves water quality by:
 - Helping to maintain a neutral pH for softer water.
 - Let {Brand} Mineral {System} {Technology} {Formula}+ handle the bulk of your water {sanitation} {disinfection} {disinfecting} needs.
 - Silver plus 0.5 ppm chlorine is as effective as 1.0 ppm chlorine alone. {for pools}
 - Silver plus 1.0 ppm bromine {or chlorine} is as effective as 2.0 ppm of bromine {or chlorine} alone. {for spas} {for hot tubs}
 - Pool Frog Mineral Reservoir works together with very low levels of {bromine} {or chlorine} to control bacteria, condition the water and help neutralize pH.
 - The {Brand} Mineral {System} {Technology} {Formula}+ provides silver to help destroy bacteria and carbonate to help keep the pH in an acceptable range without monitoring.
 - The {Brand} Mineral {System} {Technology} {Formula}+ contains silver to help destroy bacteria and carbonate to help keep the pH in an acceptable range without monitoring.
 - Silver helps destroys bacteria to reduce chlorine use up to 50%*
 - {Brand} minerals constantly work to keep bacteria away.
 - Pool Frog's mineral formula {kills} {destroys} {is sure tough on} waterborne bacteria.
5. How To Use
- Just set it and forget it for weeks at a time.
 - Maintain at least 0.5 ppm of chlorine.
 - Mark your calendar with enclosed reminder stickers for the 6 month replacement date.
 - Replace the Pool Frog Mineral Reservoir every six months or once a season.
 - Replace the chlorine {53735-2 Brand Name} when empty – usually every 1-3 weeks.
 - Replace the 7 pound chlorine Pac for Pool Frog XL Pro when empty – usually every 3-4 weeks.

[All text on this page is optional]

{Brand} comes with water polishers for easier pool start up.
Pool Frog Mineral Reservoir with Start-up Water Polishers for easier start up.
{Plus} Start-Up Water {Polishers} {Clarifiers}
25% {more} {extra} water polishers {than the original mineral reservoir}
25% more water polishers for sparkling water
25% greater clarifying power {than the original mineral reservoir}
More water polishers {than the original mineral reservoir}
More start up water polishers {than the original mineral reservoir}
{Additional} {Extra} water polishers {for sparkling water}
{Pool} {Spa} {Hot tub} start-up just got {clearer} {easier}
Start your {Brand} pool with clearer water this season
Insanely Cool Pool Care
{Patented} Get Down™ Pool Care Technology
{Patented} Get Down Mineral™ Pool Care Technology
Get Down Mineral Technology
Get Down Mineral Pool and {Spa} {Hot Tub} Care Technology
Get Down Mineral Pool Care Technology
Get Down Pool and {Spa} {Hot Tub} Care Technology
Get Down Pool Care Technology

[The following text may or may not appear on an insert inside packaging]

Important – Remove and Read

Less Chlorine with {53735-2 Brand Name} {Pool Frog Mineral {System} {Technology} {Formula}+.
To assure a 50%* chlorine reduction use this Pool Frog Mineral Reservoir with {a} {the appropriate} {chlorine} {Bac} Pac {for your system}. See setting chart in manual for the proper control dial setting.

Operation without {53735-2 Brand Name}.

If using {Pool Frog Mineral Reservoir} with an alternative source of chlorine leave the center of the Pool Frog Mineral Reservoir empty and set the Pool Frog control dial to {Maximum} Setting {10} {5} or {On} depending on your Pool Frog System. {No adjustments necessary.}

{Brand} Test Strips

To accurately measure the reduced chlorine level of 0.5 to 1.0 ppm, use {Brand} Test Strips and adjust your dial setting to maintain the ideal {Brand} chlorine range and get a longer life to the {53735-2 Brand Name}.

Helpful Start-up Tips

Starting up your pool with {Brand}

1. Test your water with {Brand} Test Strips and balance the Total Alkalinity to 80-120, the pH to 7.2-7.8 and the {calcium} Hardness to 200-400.
2. Replace your minerals every spring. Even if you hear the minerals left inside - they are no longer effective to kill bacteria after 6 months.
3. Start-up the pool with {Brand} algaecide that protects your pool against algae for 90 days – guaranteed!
4. Insert a chlorine pac and set the dial to maintain the low 0.5 to 1.0 ppm level. Use {Brand} Test Strips to dial in the ideal range.
5. Have a fun summer!

Still need help? Download the free {Brand} Water Care App, visit your local {Brand} Dealer, {call} {contact} Customer Service at xxx-xxx-xxxx

[Other Optional Text]

Free {53735-9 Brand Name} Offer Inside - \$XX.XX Value

Special Offer Inside

See Inside for Special Offer

Above Ground Series {4500} or {5100} {6100} {6500} {6700} {xxxx} (Order #xx-xx-xxxx) for use in Model

Fits the following Cyclers: Pool Frog Series 4500, 5100, 5200, 6100, 6500 or xxxx

Prevail Series 5770 or 5771 In Ground Series 5400 or xxxx (xx-xx-xxxx) for use in Model

Fits the following Cyclers: Pool Frog Series 5400, 5600, or xxxx and Prevail Series 5790 01-12-5472

Series 6100 or xxxx (xx-xx-xxxx) 01-12-6152

Series 6500 or xxxx (xx-xx-xxxx) 01-12-6152

For use with Aqua Smarte Models 5700 and 6700 or xxxx

Contents;

Pool Frog Mineral Reservoirs

{53735-2 Brand Name}

{Plus} Free {Brand} Test Strips {(\$\$ Value)} {Inside}

\$\$ Mail-in Coupon for this purchase

\$\$ Mail-in Coupon for {Brand} Test Strips

\$\$ Mail-in Coupon for {53735-9 Brand Name}

Fits Series XXX

Fits Collections XXX

[All text on this page is optional]

[Additional Copy for Skimmer Application packaging and labeling]

{{Brand} Mineral {System} {Technology} {Formula}+ improves {swimming pool pleasure} {your swimming experience} by reducing the problems associated with chlorine. Experience the {Brand} Difference:

- Less work with no daily dosing of minerals or chlorine.
- Sparkling water for in ground pools.
- Reduces Fading Swimsuits
- Lower chlorine levels help prevent damage to equipment and surfaces.}

{Set reminder dial to the six month replacement date.}

{Drops in Skimmer!}

{Don't close your eyes to the perfect pool.}

{The Perfect Pool Begins With Pool Frog Mineral Reservoir}

- {Lasts a full six months with a handy reminder dial
- Shroud prevents clogging and acts as a handle
- Water flows in the snorkel and openings on top and sides
- Water flows out the bottom dispensing low levels of minerals into the pool}

[Additional Copy for Pool Cartridge used in Floating System packaging and labeling]

- {Brand} – The Perfect Choice for Splasher Pools
- Splash Into Summer With Pool Care From {Brand}
- Small pools still need proper care – make it a snap with {Brand}
- Make sure your pool is properly treated – use {Brand}
- Before you Splash, use {Brand}!
- {Brand} makes pool care a snap with 3 Easy steps:
 1. Set the cartridges according to the instructions for each
 2. Snap them into the floating holder and place in water
 3. Replace cartridges when directed (see instructions inside)
- Before your family goes for a splash – make sure the water is treated with {Brand}.
- All pools require a method for controlling bacteria growth – even small above ground pools!
- {Brand} contains minerals that help destroy bacteria and reduce chlorine use up to 50%.
- For use in the {Brand} System
- Especially important for little people in little pools that create a big breeding place for bacteria.
- EPA registered minerals help inhibit bacterial growth when used in conjunction with reduced levels of chlorine.
- {Brand} allows your family to splash with a smile.
- Free floats in the pool.
- Set upside down outside the pool while in use. Remember to replace when finished using the pool.

[All text on this page is optional]

{Spa} {Hot Tub} Care with Less Work
Mineral and Bromine {or Chlorine} {Spa} {Hot Tub} Care

Works in all {spas} {hot tubs}
Reduces bromine {or chlorine} use up to 50%*
Cuts bromine {or chlorine} use up to 50%*

Relax - {Brand}'s on the Job
Reusable Holder
Replacement Cartridges

Register your Pool Frog Mineral Reservoir at kingtechnology.com frogproducts.com
Put{s} the AAAHH in Your {Spa} {Hot Tub}
{Brand} Mineral and Bromine {or Chlorine} {Spa} {Hot Tub} Care

For Use in the In-Line System
For Use in Spa Floater or Installed In-Line System
For use in the Automatic In-Line System Only

In-Line System Only
In-Line System, {53735-10 or 53735-16 Brand Name}, Pool Frog Mineral Reservoir, Floating System
Easy top-loading of cartridges

Ask your dealer if your {spa} {hot tub} came with a{n} {Brand} In-Line System
Ask for the 200 gram {53735-10 or 53735-16 Brand Name} for longer life
See side panel for in-line details

Less bromine {or chlorine}-with minerals helping to control bacteria
Less work with no daily dosing of minerals or bromine {or chlorine}
Less work with prefilled disposable cartridges

Reduces maintenance with prefilled adjustable cartridges
Less maintenance - Cuts Maintenance Time
Relaxation and peace of mind

For use in the Floating System
Floating System, Floating Holder
Cartridges are easy to snap in and out when replacing
Floats in Any {Spa} {Hot Tub}, Works in all {spas} {hot tubs}

Silky smooth feeling
Soft water
Soft water with less chlorine so your skin feels more {less irritated} {comfortable}

Soft feeling water with {far} {up to 50%*} less {chlorine} {bromine} that's easier on skin,
swimsuits and {spa} {hot tub} surfaces
Silky smooth feeling water
Silky feeling water that comes from water softness
Helps maintain a neutral pH to provide silky water
Using less bromine {or chlorine} helps reduce odors

[All Text on this page is optional]

Reduces Odors

Setting Window

Cartridge Kit for Automatic {Spa} {Hot Tub} Care

Contains: 1 Pool Frog Mineral Reservoir - Lasts 4 Months

3 {53735-10 or 53735-16 Brand Name} – Each Lasts {2} {3}-4 Weeks

200 grams each – Lasts 3-5 weeks

Just follow the easy guidelines below:

1. Fill {spa} {hot tub} with fresh water and bring {spa} {hot tub} to recommended temperature.
2. Balance the water's pH and total alkalinity and shock the {spa} {hot tub} to establish a bromine or chlorine residual of 1.0-2.0 ppm {using the {spa} {hot tub} start-up shock packet}.
3. Adjust your cartridges:
 - a. For the {insert color} Pool Frog Mineral Reservoir – set wide open on Setting #6.
 - b. For the {insert color} {53735-10 or 53735-16 Brand Name} – set the cartridge to #5 for the first 24 hours ONLY. Then adjust down to maintain a low 1.0-2.0 ppm of bromine. That's up to 50%* less bromine than standard {spas} {hot tubs} require.
4. Insert cartridges into floating holder openings.
5. Let the Floating System free-float in your {spa} {hot tub}. When using the {spa} {hot tub}, simply lift up the Floating System, drain most of the water and set on the side of the {spa} {hot tub} inverted so all excess water drains into the holder. Return to {spa} {hot tub} when finished using.
6. Replace your cartridges:
 - a. For the {insert color} {53735-10 or 53735-16 Brand Name} – replace when empty. The cartridge life will vary. Once your usage is determined, mark the calendar with enclosed replacement reminder stickers.
 - b. For the {insert color} Pool Frog Mineral Reservoir – replace every 4 months or when draining and refilling the {spa} {hot tub} with fresh water.
7. Shock the {spa} {hot tub} with {Brand Name} {a non-chlorine} or chlorine shock once a week or more often if the {spa} {hot tub} is heavily used.

Replace {53735-10 or 53735-16 Brand Name} every {2} {3}-4 weeks. Bromine usage varies depending on {spa} {hot tub} size and number of {spa} {hot tub} users.

Pool Frog Mineral Reservoir must be replaced every 4 months. NOTE: You may still feel the “spent” minerals inside, but they are no longer effective and need to be replaced. Simply discard in trash.

See inside label for directions for use and disposal instructions.

Just follow the easy guidelines in the enclosed manual and the following helpful tips:

VERY IMPORTANT! Before using cartridges, establish a bromine or chlorine residual of 1.0-2.0 ppm {with granular Brominating Concentrate™ or a chlorine shock} {{spa} {hot tub} start-up shock packet}. (See instruction manual.)

Brominating Concentrate™ is a registered trademark of Bio-Lab, a Chemtura Company.

Cartridges are easy to snap in and out when replacing.

If desired, invert and set on side of {spa} {hot tub} when {spa} {hot tub} is in use.

Mark your calendar with enclosed replacement reminder stickers.

Experience the shape of {Brand} water testing with free {Brand} Test Strips inside.

It's easier to maintain the low 1.0 ppm bromine level with {Brand} Test Strips. See inside for details.

Start-up is easier with the {spa} {hot tub} start-up shock packet with its {effervescent} {fizzing} action

[The following rebate copy may or may not appear on packaging – All text is optional]

that shows it's working. See inside for details. Start up your freshly filled {spa} {hot tub} with a free {53735-12 Brand Name}.

Free {spa} {hot tub} start-up shock packet inside! Free {53735-12 Brand Name} inside \$x.xx Value

Free Cartridge Rebate

Free {53735-10 or 53735-16 Brand Name} Rebate - \$##.## Value

\$##.## Rebate with the purchase of {Brand} Test Strips

Purchase must include 1 {Brand} Test Strips (50 ct) from any participating store.

{Brand} Test Strips \$##.## Rebate

{Plus} Free {Brand} Test Strips Inside

See side panel for \$##.## Rebate on New {Brand} Test Strips

Save \$##.## {when you try} {on} the complete Floating System {with:}

- 50%* less bromine use
- Less work – more fun!
- Soft water with a crystal clear shine

Plus we guarantee you'll love {Brand}!

See product or kingtechnology.com frogproducts.com for full details.

Get \$##.## back when you purchase a Floating System for mineral and bromine {spa} {hot tub} care that keeps water clean and crystal clear.

Receive a Free {53735-10 or 53735-16 Brand Name} with purchase of this kit.

How: Purchase from any participating {Brand} retailer (no on-line sales). See kingtechnology.com frogproducts.com for a retailer in your area. Send completed coupon below with original sales receipt and original UPC bar code (no copies or facsimiles) showing the purchase of {product name} to King Technology {name of rebate} {submittal address}.

When: All entries must be postmarked {within 30 days of purchase.} {no later than} {and offer expires} {date}. Important: This is a mail in rebate only. This is NOT {valid in store} an in-store rebate. Limit: one {name of rebate} rebate per household. Read all terms and conditions carefully. This is a one time offer. See details on back.

[Rebate form has the following:]

Full Name, Address, City, State, Zip, Phone, e-mail.

{I am using these cartridges in the (check one)}

- In-Line System (built into the {spa} {hot tub}) that came installed on my {spa} {hot tub}.
- Floating System (floats in the {spa} {hot tub})

{I am using {Brand} Test Strips with the (check one)}

- Pool Frog {Above Ground} {25K Gallon} System
- Pool Frog {In Ground} {40K Gallon} System
- {Brand} Mineral Floating System
- {Brand} Mineral In-Line System

{Caldera Spas Dealer / Dealer Address}

{Spa} {Hot tub} Brand

You must attach proof of purchase.

This rebate is intended for the end user consumer only; and may not be used with any other coupon or offer. Limit: one rebate per household. This offer is product specific; substitutions will not be honored. Product must be purchased from a U.S. retailer (no on-line sales) and consumer must reside within the continental United States. Theft, diversion, reproduction, transfer, sale or purchase of this offer form is prohibited and will void rebate. Submissions from P.O. boxes will not be honored. If your primary address is a P.O. box, see your local Post Office for a street address. Submissions from groups or organizations will not be honored or acknowledged. Names and addresses may be verified. Use of fictitious names or addresses could result in federal claims of mail fraud. Offer void where restricted or prohibited by law. King Technology is not responsible for late, lost, mutilated, illegible, misdirected or postage due requests. King Technology reserves the right to rescind this offer. This offer may not be reprinted without the express written consent of King Technology. Please allow 6-8 weeks for delivery of

[The following Satisfaction Guarantee may or may not appear on packaging – All text is optional]

Unconditional Satisfaction Guarantee

You'll LOVE the {Brand} Mineral Floating System or your money back!

If after 90 days you don't experience...

- 50%* less bromine use
- Less work - more fun!
- Soft water with a crystal clear shine

we'll replace it or refund your money. And that's a fact!

This is a limited warranty. See back for details.

Within 90 days of purchasing the {Brand} Mineral Floating System, if you are not completely satisfied, we will refund your money or replace the {Brand} Mineral Floating System only. To submit your claim, the following must be sent to King Technology:

- 1) The Floating System holder ({insert color} piece with {Brand} logo).
- 2) The receipt(s) showing the purchase of the {Brand} Mineral Floating System and at least 3 {53735-10 or 53735-16 Brand Name}.
- 3) A water test analysis showing the water was balanced and the bromine level was between 1.0 and 2.0 ppm.
- 4) A written statement explaining your dissatisfaction and your request for either replacement or refund.
- 5) Return all of the above to:

King Technology Inc. c/o {Brand} Mineral System Satisfaction Guarantee
530 11th Ave S, Hopkins, MN 55343

Please allow 4-6 weeks for processing your request.

If you have any questions, please contact Customer Service at 800-222-0169.

[All Text on this page is optional]

Refer a Friend to {Brand} {Program} {and {get} {earn} a free Pool Frog Mineral Reservoir}. See side panel.

Here's how it works:

1. You tear off the enclosed program form and give to your friend.
2. They purchase a {Pool Frog Mineral Reservoir and 6 {53735-14 Brand Name}s} { Floating System} and submit the form and their receipt to King Technology, Inc.
3. Your friend receives {a free} {Cycler} {{Brand} equipment} {\$x Rebate and a money back guarantee} directly from King Technology
4. You receive a free {Pool Frog Mineral Reservoir} {53735-9 Brand Name} {53735-13 Brand Name} directly from King Technology.

Help your friend enjoy the {Brand} benefits that you experience every day.

The free gift is our way of saying thanks for making {Brand} your choice for {pool} {spa} {hot tub} water care and spreading the word to others!

Give your friend the gift of {Brand}!

If you appreciate Pool Frog Mineral Reservoir – refer a friend to either {Brand} or the {Brand} Mineral Floating System and we'll send you a free Pool Frog Mineral Reservoir

On {Brand} Mineral System Retail Cartridge Kit Package

Refer a Friend to {Brand}

\$10 Rebate and Guarantee

Free Pool Frog Mineral Reservoir \$x.xx Value

To {Brand} Mineral System User: Cut out this panel, fill in your information under "My Name" and give to your friend who owns a {spa} {hot tub}. When they purchase a {Brand} Mineral Floating System, you get a free Pool Frog Mineral Reservoir! Program ends x-x-xx.

To Friend: When you purchase a {Brand} Mineral Floating System, fill in your information under "My Friends Name" and mail with your original receipt to King Technology, Inc. 530 11th Ave S. Hopkins, MN 55343. You will receive a \$10 rebate and a 90 day money back guarantee! Must be postmarked no later than x-x-xx.

Refer a Friend Offer; This offer is intended for new customers of {Brand} Mineral System only. You cannot refer yourself, nor can you refer someone already using this product. Limit x referrals per 12 consecutive month period. This offer is not transferable or redeemable for cash.

\$10 Rebate Offer: May only be used with the Refer a Friend or {Brand} Mineral System Money Back Guarantee offer. Both Offers; Must be residents of the United States and 18 years or older. Offer may expire without prior notice. Determination of program eligibility as well as any exceptions are at the sole discretion of King Technology, Inc.

[All text on this page is optional]

How To Use: {Simple Instructions for {spa} {hot tub} cartridge used in Floating System}

- Simply snap out and snap in the prefilled Pool Frog Mineral Reservoir.
- Set reminder dial to the four month replacement date.
- For the {insert color} Pool Frog Mineral Reservoir – set wide open on setting #6.
- Insert cartridge into floating holder openings.
- Easy top loading access makes it a snap to replace the Pool Frog Mineral Reservoir in the holder.
- No assembly required.
- By dropping it inside your filter cartridge, filter well or skimmer, Pool Frog Mineral Reservoir works with no electricity and no hassles for four full months.
- Set it and forget it for up to 4 months.

- Simple {spa} {hot tub} care
- Insanely Cool {Spa} {Hot Tub} Care
- {Patented} Get Down™ {Spa} {Hot Tub} Care Technology
- {Patented} Get Down Mineral™ {Spa} {Hot Tub} Care Technology
- Get Down Mineral Technology
- Get Down Mineral Pool and {Spa} {Hot Tub} Care Technology
- Get Down Mineral {Spa} {Hot Tub} Care Technology
- Get Down Pool and {Spa} {Hot Tub} Care Technology
- Get Down {Spa} {Hot Tub} Care Technology
- Reduces sanitizer demand
- For bromine & chlorine
- Enjoy softer, cleaner water
- Enjoy clearer, cleaner {spa} {hot tub} water with the help of minerals
- Contains minerals that help to control bacteria while reducing sanitizer demand
- When combined with proven chemistry, you'll experience {spa} {hot tub} water that is clearer, cleaner and softer to the touch
- Works with bromine and chlorine
- Fits most filters
- Simple installation
- One-piece design
- Compatible with {Brand Name} {non-chlorine shock} {chlorine} {or} {bromine}
- Installation is easy
- Insert into filter cartridge, in filter well or in skimmer.
- Lower your chlorine or bromine level to 1.0 ppm
- Replace at least every 4 months or when draining and refilling {spa} {hot tub}.
- After that time, even if upon shaking, you hear the spent media inside, it is no longer effective and must be replaced.
- Product is effective up to 4 consecutive months or when draining and refilling the {spa} {hot tub}.
- After following the simple {spa} {hot tub} care start-up program located in the back of your {spa} {hot tub} care guide, it's time to add the Pool Frog Mineral Reservoir.
- Test pH, Total Alkalinity, chlorine/bromine levels regularly with test strips. Shock after each use or at least once a week with chlorine {shock} or {Brand Name} {non-chlorine shocks}.
- It is normal for a small amount of granules and dust to become dislodged from the Pool Frog Mineral Reservoir during shipment.

[All text on this page is optional]

- For use only with {Brand}.
- This product to be used only with {Brand}
- See your {Brand} manual for complete operating instructions [Note to Reviewer: {Brand} is a brand of hot tub]
- {Patented} Mineral Spa {Sanitizer} {Disinfectant}.
- Mineral {Spa} {Hot Tub} Care is developed with technology from {Brand}
- {Exclusively} {Custom} {Fit}{s}{ted} {Designed} {for} {Brand} Spas

{Brand}'s Got Your Back with:

- Strong consumer benefits
- No price increase on {Brand} products
- Free POP materials
- No price increases on Mineral Reservoirs and steps to grow your business
- By absorbing the high cost of chlorine to help protect you and your customers
- {Brand} programs
- Tools to grow your business
- Strong profits
- EPA registered product

Minerals make {all} the difference {for pools} {for spas} {for hot tubs}

Consumers want to make a difference.

Get Down chlorine or bromine use up to 50%* {which exceeds consumer expectations}

Get Down work {maintenance time} {for more fun and relaxation}

Get Down problems like faded swimsuits

Get Down long term damage to pool surfaces and equipment

[Copy on rebate coupons]

{Brand} \$##.## Value with X# mail in coupons {and free {Brand} Test Strips (\$##.## value)}

A clear way to see the {Brand} mineral value

For use with {Brand} pool and {spa} {hot tub} products

Designed for low chlorine or bromine measuring down to 0.5 ppm

One bottle handles pools up to 15,000 gallons for 90 days. Two bottles handle pools from 15,000 to 30,000 gallons for 90 days.

Purchase MUST include 1 {53735-9 Brand Name} from any participating store.

Pack contains 6 {53735-2 Brand Name} and 1 Mineral Reservoir.

Minerals cut chlorine use up to 50%

Pool Frog offers more fun with less work.

Purchase MUST include 1 Mineral Reservoir and 6 {53735-2 Brand Name} from any participating store.

[All text on this page is optional]

[Copy on packaging for Filter Spa Product]

Easy Installation {into most filters}. No Assembly Required.

Let us Dissect This {Brand} For You

- Openings in cap for additional water flow
- Reminder dial for replacing every 4 months
- Scooped louvers draw water in and through minerals inside
- Bottom louvers allow clean water out
- Welded rod helps prevent breakage

Pool Frog Mineral Reservoir works together with very low levels of bromine or chlorine to control bacteria, condition the water and help neutralize pH.

Easier to install

- Set reminder dial to the four month replacement date
- Insert Pool Frog Mineral Reservoir into filter cartridge, in filter well or in skimmer
- Lower your bromine or chlorine levels to as low as 1.0 ppm*
- Replace Pool Frog Mineral Reservoir every 4 months or when draining and refilling {spa} {hot tub}

{Convenient} Reminder Dial {for easy-to-remember 4 month replacement}
Set {it and forget it} for 4 mos.

Minerals offer

{Brand} Offers More Relaxation

- Simply a more enjoyable {spa} {hot tub} experience
- Permanent rod fits almost all {spas} {hot tubs}
- Welded rod helps prevent breakage
- Inserts easily into filter
- Conveniently fits inside the filter cartridge
- Also works in most skimmers or filter wells

Prefilled Stick

4 Months of Fresh

US Patent # and other US Patents and Foreign Patents pending

Patents: www.kingtechnology.com/IP

Patents: www.heycoolpool.com/IP

[All text on this page is optional]

{Brand} Mineral Systems Work Wonders {One-ders} {1-ders}
{Brand} is {the one} {a wonder}
Wonders {One-ders} {1-ders} {The one} for your water
Wonders {One-ders} {1-ders} {The one} for your workload
Wonders {One-ders} {1-ders} {The one} for you wallet

Adopt a {Brand} for worry free water
Adopt the {Brand} Technology
Take {Brand} home and experience softer water with a crystal clear shine
Make {Brand} a part of your family
When {Brand}'s a part of your family you relax and enjoy your {pool} {spa} {hot tub} more
Let {Brand} keep your family happy with crystal clear water that takes less time to maintain
{Brand} does the work so you can enjoy more time with your family
When you adopt a {Brand} you adopt more than a technology. You adopt a better, easier,
more fun {pool} {spa} {hot tub} environment.
Send in your adoption (warranty) card today!

{Brand}-tastic Water – {Brand}tastic Fun!
{Brand} minerals reduce {chlorine} {bromine} use up to 50% {for {Brand}-tastic water}
{Brand}-tastic means water with a softer feel, less odors and a crystal clear shine.
{Brand}-tastic fun means less work with long lasting prefilled replacements and less pH
monitoring.

{Brand}-ability
{Brand}-simple
{Brand}-mineral
{Brand}-complete
{Brand}-atude
{Brand}-attitude
{Brand}-support

Hybrid water care that's fun and easy
Hybrid water care that's {Brand}-tastic
Hybrid water care that's {Brand}-tastically fun

With hybrid water care, minerals reduce {chlorine} {bromine} use while maintaining a clean,
clear {pool} {spa} {hot tub}
The 2 in 1 water care system that reduces {chlorine} {bromine} use up to 50%
In {Brand}'s Hybrid System, minerals do a lot of the work so you need less {chlorine}
{bromine}

{Brand} minerals with less {chlorine} {bromine} make {pool} {spa} {hot tub} care a snap so
you work less and have more fun

{Brand} knows water – {Brand} knows fun
The mineral system experts
{Brand} – the water experts
{Brand} – the mineral system experts
{Brand} is an expert at clean clear water with 50% less {chlorine} {bromine} and less work
{Brand} knows you want to keep your water clean and clear and your life easy

[All text on this page is optional]

{Brand} knows how to do the job so you work less and enjoy your pool, {spa} {hot tub} more
Clean clear water without the work and worry just as {Brand} intended
Just as {Brand} intended
Let {Brand} turn your {pool} {spa} {hot tub} into a water oasis
{Brand} minerals reduce {chlorine} {bromine} use up to 50% to turn your {pool} {spa} {hot tub}
into a water oasis.

Mineral System{s}
Mineral Hybrid System{s}
Mineral Water Care System{s}
Mineral Hybrid Water Care System{s}

{Brand} simple
Great water care made {Brand} simple
Less {chlorine} {bromine} through minerals
{Brand} it and leave it
{Brand}... in control
{Brand}... cruise control for your {pool} {spa} {hot tub}

Make your chlorine {bromine} last twice {2X} {two times} as long as {longer than} traditional {normal}
{standard} pools {spas} {hot tubs} with {Brand} minerals and only 0.5 ppm {1.0 ppm} chlorine
{bromine} levels.

Maintaining 0.5 ppm {1.0 ppm}, chlorine {bromine} lasts twice {2X} {two times} as long {longer} with
{Brand} over traditional {normal} {standard} pool {spa} {hot tub} care methods.

Maintaining 0.5 ppm {1.0 ppm} rather than the standard 1.0 ppm {2.0 ppm}, chlorine {bromine} lasts
twice {2X} {two times} as long {longer} with {Brand}.

Compared to the traditional {normal} {standard} {minimum recommended} chlorine level for pools,
{Brand} minerals make chlorine last twice {2X} {two times} as long {longer}.

{Brand} Minerals double the life of your chlorine {bromine} over pools {spas} {hot tubs} on chlorine
{bromine} alone.

With {Brand} Mineral Systems, chlorine {bromine} lasts twice {2X} {two times} as long {longer} than
pools {spas} {hot tubs} on chlorine {bromine} alone.

With {Brand} Mineral Systems you can go twice {2X} {two times} as long {longer} between chlorine
{bromine} changes compared to pools {spas} {hot tubs} on chlorine {bromine} alone.

With {Brand} in, you can get twice {2X} {two times} the life out of your chlorine {bromine} than
{traditional} {normal} {standard} pools {spas} {hot tubs} at higher chlorine {bromine} levels.

{Brand} uses only half the chlorine {bromine} of {traditional} {normal} {standard} pool {spa} {hot tub}
care methods.

The {Brand} Mineral System allows your chlorine {bromine} {chlorine or bromine} to last {twice} {2X}
{two times} {as long} {longer} as {traditional} {normal} {standard} {minimum recommended} levels.

[All text on this page is optional]

The {Brand} Mineral System allows one-half the chlorine {bromine} {chlorine or bromine} to be used compared to {industry standards} {{traditional} {normal} {standard} pool care methods}.

Put {Brand} in, take half the {chlorine} {bromine} out that {traditional} {normal} {standard} pools {spas} {hot tubs} maintain.

With {Brand} minerals cutting {chlorine} {bromine} use by 50%, that means your chlorine {bromine} lasts twice {2X} {two times} as long {longer}!

The {Brand} Mineral Hybrid System uses minerals to extend the life of your chlorine - up to twice {2X} {two times} as long {longer} than pools on chlorine alone.

The 2 in 1 {two in one} water care system that helps {chlorine} {bromine} last twice {2X} {two times} as long {longer}.

{Brand} provides the 1-2 {one-two} punch: {minerals and 50% less chlorine} {with chlorine that lasts twice {2X} {two times} as long {longer}}.

Minerals and 0.5 ppm chlorine {destroys} {kills} bacteria allowing you to use up to 50% less chlorine.

Minerals and 1.0 ppm bromine {destroys} {kills} bacteria allowing you to use up to 50% less bromine.

Using minerals and up to 50% less {chlorine} {bromine} means {savings to you} {less work and more savings}.

Minerals and {0.5 ppm chlorine} {1.0 ppm bromine} is all you need. Otherwise you use twice {2X} {two times} of what you don't want – {chlorine} {bromine}!

With {Brand} Mineral Systems, chlorine lasts twice {2X} {two times} as long as {longer than} the industry standards {{traditional} {normal} {standard} {minimum recommended} {higher} levels.} {the standard 1.0-3.0 ppm chlorine level.} {{traditional} {normal} {standard} pools.}

With {Brand} Mineral Systems, bromine lasts twice {2X} {two times} as long as {longer than} the industry standards {{traditional} {normal} {standard} {minimum recommended} {higher} levels.} {the standard 2.0-4.0 ppm bromine level.} {{traditional} {normal} {standard} {spas} {hot tubs}.}

To help chlorine last 2X longer use this Pool Frog Mineral Reservoir with the {53735-2 Brand Name}.

Don't forget {53735-13 Brand Name} for spring openings and {53735-13 Brand Name} for fall closings!

Use {53735-13 Brand Name} for optimal performance of your {Brand} Mineral System

Use {53735-13 Brand Name} {for a 1-2 Winterizing Punch} {to prepare for a smoother spring start-up}

What's living in your pool?

Don't share your pool with {common bacteria, bugs, pests you don't want}

Your pool party has a long list of unwanted guests.

Don't let undesirables crash your pool party

[All text on this page is optional]

{Brand} dial-a-sure
The lower chlorine system
Worry about your water? Go {Brand} for no worries.
{Brand} on duty
{Brand} never sleeps

{Brand} is always in the pool
The {Brand} System+ is always working to protect you and your family
Don't get in the water without the {Brand}.
{Brand} twist and shout

Dial-a-{Brand}
Dial-a-Clear Pool
Dial-a-Clean Pool

{Brand} works
With {Brand}, you know it's {clean} {clear} {sanitized} {fresh} {sparkling}

Your Pool needs {Brand}
Pool water needs {Brand}
{Pop-up, splasher, small} pools need {Brand}
{Brand} System+ in – bacteria out

Dirty water needs {Brand}
{Brand} gets it clean, keeps it clean.
{Brand} keeps bob bob bobbin along
{Brand} - Always In! – Always Clean {Clear} {Sanitized} {Fresh} {Sparkling}!
{Brand} - Always Cleaning So You Don't Have to!

KNOW your Pool is Clean {Clear} {Sanitized} {Fresh} {Sparkling}!
Toss it in. Leave it in.
Great Ball-O-Clean!

{Pop-up, Splasher, Small} Pools Need Cleaning Too!
Toss it in. Clean it up!
Finally! Small Pools Get Big Clean!

The easiest way to keep small pools {clean} {clear} {sanitized} {fresh} {sparkling}
Small Pools Need Big Clean!
Small Pools – Big Clean!

It's like having your own 24/7 pool service! Just dial the number to your pool size and toss it in the pool. When the {Brand} System turns over and stays over, simply replace the chlorine and toss it back in. It's that easy!

{A} {One of the} leader{s} in reduced-chlorine mineral water care.
Toss it in for weeks of worry-free water!

[All text on this page is optional]

Dual-Core system for maximum water clarity and cleanliness!

Minerals and low levels of Chlorine for a{n} {ultra} clean{er} {pool} {spa} {hot tub}

Clean {Clear} {Sanitized} {Fresh} {Sparkling} water starts with {Brand}

Fresh, sparkling water starts with {Brand} that kills harmful bacteria with up to half the chlorine.

Need Clean {Clear} {Sanitized} {Fresh} {Sparkling} Water? Get {Brand}

Don't get in the pool without {Brand}

For Clean Pool Water You Need {Brand}

Twist and Toss

Live in pool cleaner

Live in pool help

Live in pool care

Live in caretaker

{And} Minerals reduce chlorine costs to {just} pennies a day

With minerals chlorine use costs only pennies a day

{Brand} - Keep it in – Keep it clean

{Brand} keeps {cleaning} {sanitizing} {working} so you don't have to

{Brand} is a lazy man's best friend

{Brand} in – water {clean} {clear} {sanitized} {ready to go}

{Brand} is a pool caretaker

Satisfaction Guarantee – Like it or your money back.

{The lazy man's best friend for} clear, clean water

Your partner in sanitizing pop up pools

The pairing of minerals and chlorine continuously maintains clear, clean water for weeks.

Clear, clean and easy {way to have} soft water

Put your pool in good hands!

You need a buddy that's always lending a hand to keep your water clean and clear.

{Especially made} for {pop up} {splasher} {small} {swimming} pools

Mom's love {it} {Pool Frog Mineral Reservoir}

The {Brand} System+ keeps {small} pools healthy

The Clean Machine

The Small Pool Must for Bacteria that Disgust!

The ESSENTIAL Small Pool Sanitizer

Kills Bacteria. Clears the Water.

The {Automatic} All-in-One Small Pool Sanitizer

[All text on this page is optional]

Cleaner water - Round the clock

The easy way to give smaller pools a bigger clean

Provides a Clean Zone in your small pool

Finally, an easy way to keep your small pool clean and clear

Protect your small pool from bacteria all day and night.

Keeping an eye out for bacteria 24/7

Your front line against bacteria in your small pool

Your blockade against small pool bacteria

The automatic small pool sanitizer

The always-on small pool sanitizer

When {it} {flips} {rolls over} replace this {bottom} {half} {recharge} {insert color} {chlorine} {cartridge}

Flips over when {53735-14 Brand Name} is empty and needs to be replaced.

Replace {this} {bottom} {half} {recharge} {chlorine} {cartridge} when {flipped} {rolled} {over} {viewable} {seen} {bottom showing}

Chlorine: Replace when {this} {chlorine} half floats up

{This is} not a toy.

Visit kingtechnology.com frogproducts.com to find a stocking retailer

Minerals: Lasts 6 months

Turn your chlorinator into a mineral system

For {Hayward®} {Rainbow®} chlorinator users

The experience of mineral pool care without an installation

Turn your {Hayward®} {Rainbow®} {chlorinator} into a {Brand} {mineral system}!

Improve your water quality with precise chlorine output

No more touching chlorine tablets

No need to haul heavy buckets of chlorine

No guessing how much chlorine to use

Better than {chlorine} buckets!

{Ditch} {Buck} {Leap frog} the {chlorine} buckets with {Brand Name} prefilled chlorine pac

No more {peak and valley} {yo-yo} {up and down} {chlorination} {chlorine levels}

Get more from your {Hayward®} {Rainbow®} chlorinator by converting to {Brand}!

Chlorinators are old school – {it's time for} {upgrade to} {Brand}!

Experience a better pool care method for no more money

Reduced chlorine {solution} {technology} for {Hayward®} {Rainbow®} chlorinator users

Clean water with up to {1/2} {half} {50%} the chlorine*

{Brand} {We} keep it clean with up to {1/2} {half} {50%} the chlorine*

{Brand} {helps} keep{s} it clean with up to {1/2} {half} {50%} the chlorine*

Kills bacteria with up to {1/2} {half} {50%} {less} {the} chlorine*

[All text on this page is optional]

{Destroys} {Kills} {Eliminates} {harmful} bacteria with up to {1/2} {half} {50%} the chlorine*
{Brand} patrols your pool with up to {1/2} {half} {50%} the chlorine*
Keep {it} {your pool} clean with up to {1/2} {half} {50%} the chlorine*

Fights bacteria with up to {1/2} {half} {50%} the chlorine*
Battles bacteria with up to {1/2} {half} {50%} the chlorine*

{Patented technology} for {pop-up} {splasher} {inflatable} {smaller above ground} {easy set} {quick set} {frame} {metal frame} {oval frame} {ultra frame} pools up to {12'} {15'} {16'} {18'} {diameter} {3000} {4000} {5000} {6000} {gallons} {gal.}

Perfect for {keeping} {pop-up} {splasher} {inflatable} {smaller above ground} {easy set} {quick set} {frame} {metal frame} {oval frame} {ultra frame} pools {clean} {disinfected} {clear} – {1} {Brand} up to {12'} {15'} {16'} {18'} {diameter} or {3000} {4000} {5000} {6000} {gallons} {gal.}

{Patented} {Proprietary} {Exclusive} {pop-up} {splasher} {inflatable} {smaller above ground} {easy set} {quick set} {frame} pool {bacterial} {protection} {technology} – {1} {Brand} up to {12'} {15'} {16'} {18'} {diameter} or {3000} {4000} {5000} {6000} {gallons} {gal.}

{Designed} {Made} specifically for use in {pop-up} {splasher} {inflatable} {small above ground} {easy set} {quick set} {metal frame} {oval frame} {ultra frame} {frame} {set} pools {between} {1000} {2000} gallons {up to} {16"} {18"} in diameter {or} {and} {5,000} {6,000} gallons.

Large pool technology {brought home to any backyard} {now available for} {pop-up} {splasher} {inflatable} {small above ground} {easy set} {quick set} {metal frame} {oval frame} {ultra frame} {frame} {set} pools.

Easy-to-follow instructions inside the box.
3 {easy} steps to keep your pool clean:
Clean pool in 3 {easy} steps

Keeping {your} {the} pool clean {is as easy as 1-2-3} {has never been so easy}
{Destroy} {Kill} {Eliminate} {harmful} bacteria {and prevent algae} in 3 easy steps
1 - Connect {algaecide}, {mineral and chlorine together} {upper and lower} halves and {select} {twist to} {appropriate} setting on {Brand} {based on pool size and use}
2 – {Place} {Toss} {Flip} {Throw} {Brand} in pool

{3 - When} {Brand} {flips} {rolls} {over} {upside down}, {he's telling you it's time to} {change} {replace} {bottom half} {the chlorine recharge} {cartridge}
3 - {Brand} {flips} {rolls} {over} {upside down} when it is time to {change} {replace} {bottom half} {chlorine recharge} {cartridge}
3 - Change cartridge when {{Brand} flips} {flipped} {rolls over}
3- {Flips} {Rolls} {over} {upside down} when chlorine {recharge} {half} {cartridge} needs replacing

Set, float, {flip} {rolls over}, replace {chlorine} {half} {recharge} {cartridge}
Attach {cartridge} {recharge}, select setting, float, {flip} {rolls over}, {replace cartridge} {re-cartridge} {recharge} {Adjustable dial settings}
{Attach} {Connect} and set
Re-connect and Re-Set

{It} Float{s} til{l} {flipped} {it flips} {it rolls over}
Replace {chlorine} {cartridge} {recharge} {half} {bottom}
Silver {smart} {ion} {mineral} technology plus low levels of chlorine

[All text on this page is optional]

Silver ion {minerals} {mineral technology} work{s} {in conjunction} {partner} with {low levels of} chlorine to {kill} {eliminate} {destroy} {inhibit} harmful bacteria

Minerals with low levels of chlorine destroy bacteria

Silver ion {minerals} {mineral technology} {kill}{s} {eliminate}{s} {destroy}{s} {inhibit}{s} bacteria{l} growth when used in conjunction with low levels of chlorine

When used in conjunction with low levels of chlorine, silver ion {minerals} {mineral technology} {kill}{s} {eliminate}{s} {destroy}{s} harmful bacteria {and inhibit{s} its growth}

Silver ion {boost} {action} {Brand} reduces chlorine use by 50%

Silver ion {boost} {action} {Brand} {needs} {works with} {equals} {=} 50% less chlorine

Silver ion {boost} {action} {Brand} keeps your pool clean with up to {1/2 the} {half the} {50% less} chlorine.

Silver ion chlorine technology

Silver smart chlorine reduction technology

Silver ion mineral {plus} {+} replaceable chlorine

Advantages of {using} less chlorine:

Advantages of using up to {1/2} {half} {50% less} {the} chlorine:

Up to {1/2 the} {half the} {50% less} chlorine means:

Increased enjoyment with:

{Less} {Reduced} chlorine {smell} {odor} {aroma}

Improved water {feel} {softness}

Water feels softer

Spa-like softness

Soft water feel

Crystal clear shine

Crystal clear water {looks inviting}

Sparkling clear water

You buy the pool. {We} {Brand} keep{s} it clean.

King Technology, Inc. – Improv{ing} {ed} {your} {pool} {spa} {hot tub} water

King Technology, Inc. – the {pool} {spa} {hot tub} water {experts} {patrol} {professionals}

{Chlorine} {Recharge} {Cartridge} {Bottom half} Lasts up to 3 weeks! (see instructions inside for details)

{{Brand} Minerals} {Top half} last{s} up to 6 months or a full season! (see instructions inside for details)

[References of dual action will only be used when Pool Frog Mineral Reservoir is sold with chlorine or bromine]

Dual Action

{1 – 2 punch} {Dual action} {2-Part action} against {harmful} bacteria

Fighting together to protect swimmers from {harmful} bacteria

{2-part} {Dual} action gives bacteria a 1-2 punch

Kill{ing}{s} bacteria with a 1-2 Punch

{Brand} {sanitizes} {does the job} {keeps it clean} for pennies a day!

The next best thing requires {50%} (a lot) more chlorine!

If your chlorine level is {2.0} {3.0} ppm, using {Brand} can cut your use {70%} {80%}

Self-Contained {Dual Action} {Reduced Chlorine} Pool {Care} {Sanitizer}

When it starts to turn you have a day or two before it's empty

King Technology: Pool Frog Mineral Reservoir EPA Reg. No. 53735-11

Label Version **May 18, 2020-3**

Page **79** of **105**

[All text on this page is optional]

Slowly {flips} {rolls} over to let you know it's almost empty

Flips over when {chlorine {cartridge} is} empty

Early warning system built in as it takes a few days to completely {flip} {roll over}

{Silver Ion} Minerals + low levels of chlorine

{Silver Ion} Minerals + controlled levels of chlorine

Less chlorine hassle

Saves {you} money

No-touch chlorine cartridge

Up to 18 ft. or 6,000 gallons

Up to 15 ft. or 5,000 gallons

{For {pop-up} {easy set} {do it yourself} pools} {12 to 18} {18 to 21} {feet} {foot} {in} {diameter;} {2000 to 5000 gallons} {5000 to 10,000 gallons}

Stays clean with consistent low-levels of chlorine

{Tells you} {Let's you know} when it's empty

Complete pool care system

Conditions the water for spa-like softness

Top half lasts up to 6 months (or one season)

{Bottom half} {Chlorine} lasts about 4-6 weeks in pools up to {3000} {4000} gallons with average use or about 2-4 weeks in pools up to {5000} {6000} gallons.

Additional replacement {chlorine} cartridges sold separately

Keeping the Pool clean has never been so easy

Align arrows, twist and set for your pool size. {Set the cartridge per the} {See chart in} manual

Tie off in pool away from skimmer. Product will tip over when empty.

When empty, twist off {53735-14 Brand Name} (and recycle). Attach replacement cartridge.

Attach new {insert color} {53735-14 Brand Name} to {insert color} Pool Frog Mineral Reservoir and set back in pool.

Low Chlorine vs. Too Much Chlorine

Chlorine is by far the leading disinfectant used to kill bacteria in swimming pools because it works. But it needs to be controlled as chlorine in too high a dose can be a problem.

Keeping the right amount of chlorine in the pool promotes comfort and enjoyment.

The Pool Frog Mineral Reservoir's {patented} design manages chlorine levels in two ways.

First, it combines low-levels of chlorine with another anti-bacteria agent – {silver ion} minerals.

Together, they destroy bacteria.

Secondly, the {patented} interior design of the System controls the flow of chlorine to eliminate the too-high, too-low situations.

The result is consistent sanitation with up to half the chlorine.

{Click} {Twist} on {to replace}, {click} {twist} off {chlorine} {cartridge} {when empty}

Easy to twist off the empty cartridge and twist on a new one

Simply twist off the old {insert color} cartridge and replace

{This} {Replacement} {Chlorine} Cartridges {designed} {for} {fits} Pool Frog Mineral Reservoir}

{Clean} {Clear} water the easy way! Easy way to cleaner, clearer water

It's {Brand} but a leap ahead

Mineral pool care that's a leap ahead

Leap ahead with {Brand}

Leap into summer

[All text on this page is optional]

Specially designed for {Brand} mineral system users.

Flippin' amazing {pool care}

Flippin' amazing technology turns {old fashioned} {pool} {water} care upside down

{Brand} { {Kills} {Destroys} {Gets rid of} bacteria {two} {2} ways {with} {silver ion minerals} {mineral ions} {minerals} {and} {plus} {low levels of} {less} {chlorine}*.

In fact, it's half as much chlorine.

{Friendly} {Easy} {pop-up} {mineral} pool care

It's {flippin'} {amazing} {exciting} {easy} {easy to use} {profitable} {cool} {awesome} {friendly} {fun} {original} {one of a kind}

THE {pop-up} {mineral} pool technology that cuts chlorine use in half*

Low - and - slow chlorine release cartridge (lasts {2} {3}-4 weeks)

Amazing mineral{s} {system} {technology} {formula} kill bacteria

Float{s} {and} {&} Flip{s} {technology} tells {user} {you} when {it's empty} {to replace the {53735-14 Brand Name}}

Pool Frog Mineral Reservoir releases ions while {53735-14 Brand Name} releases low (0.5 ppm) levels of chlorine

Visual{ly} {out indicator} {tells you} {at a glance} {when} {the cartridge needs replacing} {it's empty} {it's time to replace}

The {no-mess, no-guess, no-stress} pool care for pop-up pools featuring {Brand}'s {innovative} technology. Prefilled {cartridges} {pacs} {chambers} for no mess, no guess, no stress

Prevents smelly odors and bleached {swimming} suits

No more worries about the proper dosage or handling smelly, bulky chemical{s} {buckets}. Pool Frog Mineral Reservoir {simply floats in the pool} keep{s} {ing} the water sparkling clean, clear and soft for weeks; then flips over when {the chlorine is} empty. {Simply replace with a new {53735-14 Brand Name}.} {Saves} {Less} work and {up to 50%* less chlorine} {saves money}! It's that easy! {Saves you work and money.}

Some floaters were not built with the {adjustability} {technology} to precisely meter chlorine so they {tend to} {sometimes} dispense higher chlorine levels than is needed.

Not all floaters are built with the {technology} {adjustability} to precisely meter chlorine, which may result in the {dissension} {dissolution} {dissolving} {using} {of} more chlorine than is needed.

Standard floaters come in different sizes with different output abilities which can mean one pool has too much chlorine while another doesn't have enough.

{And} {Brand} leaves {your} water soft, clean and silky

{It's patented.} It's EPA registered

{Patented} minerals {reduce} {cuts} chlorine use up to 50%*

{Helps} {you} ensure{s} the pool {is always} {stays} {sanitized} {clear and clean}

{Brand} works hard for you!

Clean & Clear the easy way

Clean, Clear & Easy

{Complete} {Clear} {Clean} Water Solution

Figure A – Align arrows

Figure B – Rotate to set

Figure C – Initial Setting Chart

{The {prefilled} [insert color] {53735-14 Brand Name}} Lasts 3-4 weeks

{It's} New

This side up

[All text on this page is optional]
[Copy on packaging for Floating Pool Cartridge]

Contents: 12 {53735-14 Brand Name}s
Retailer: Pull here to remove

Scan to learn more about {Brand}Made in the U.S.A.
Distributed by Arch Chemicals, Inc. P.O. Box 724438 Atlanta, GA 31139-1438

“Cool” sanitizing pool care – minerals and less chlorine!
The {latest} {up to date} {innovative} {high tech} {cool} pool technology combines minerals and {low levels of} {50% less} {half the} chlorine

Minerals benefit you with:

Clean, clear, {pH balanced} water
Forget about faded swimsuits or {harsh} {smelly} odors
Silky soft, sparkling clear water

{insert color} Mineral{s} {cartridge} last{s} all summer^

^ {Brand} minerals last {up to} 6 months or one pool season whichever is shorter
{The {Brand} Mineral system+} {Minerals} scrub{s} bacteria away

{insert color} {cartridge} {side} up? It's time to replace {your chlorine cartridge}.
When it flips to {insert color} side up
{insert color} {cartridge} {side} up? {Brand} is working to sanitize your pool.
Water looks inviting and feels even better
Less cost {to maintain the pool}

More time for {what really matters} {fun!} {Super easy for more fun!}
{Hey! easy} mineral {sanitizing} {quality} pool care
Pool care {made easy} with {sanitizing minerals} {mineral sanitizing ions}
Sanitizing mineral pool care
Crystal clear water made easy
Hey! {our new} {cool} pool care with minerals
Uses essential minerals to sanitize and keep pH neutral
Uses sanitizing mineral ions and keeps the pH neutral

Bacteria{l} {fighting} {killing} {sanitizing} mineral ions and {low levels of} {half the} {50% less} chlorine
{protect your family} {and} {leave your water looking sparkling clear and clean}
Bacteria{l} {fighting} {killing} {sanitizing} mineral system+ {protects your family} {and} {leaves your water looking sparkling clear and clean}

Use only chlorine? Not anymore! {Patented} {Bacteria killing} Minerals {destroy bacteria}
reduc{e}{ing} {cuts} chlorine use up to 50%*.

Plop it in – wait til it flips
Plop and flip
Plop it in until it flips
Simply plop {it} in the pool – flips when {it's out} {empty}
Plop {it back} in the pool
When it flips, it's time to replace the chlorine {cartridge}
Remove {the empty} & {replace} {twist on} a new {chlorine} cartridge
Hey! less work
Hey! less chlorine
Hey! {less} {saves} money

[All text on this page is optional]

{Minerals mean less is more} {With minerals less is more} – less chlorine and more benefits
{Spend} More or less? It's your choice.

- Spend less time working on your pool
 - No adding chlorine daily or by hand
 - Long lasting cartridges are easy to replace
- Spend less money on “fix-it” chemicals
 - Mineral protection helps prevent problems
 - Less chlorine use equals less chlorine cost
- Use less chlorine than standard pools
 - Water feels softer with less chlorine
 - Prevents bleached suits and smelly odors

Minerals – the insurance policy against a green pool
Minerals keep working even when the {chlorine} {bromine} {level drops} {is empty}
Minerals help keep the pool from turning cloudy

Bacteria doubles every 20 minutes – the {Brand} System+ {stops bacteria in its tracks} {keeps bacteria at bay}
{Better} {Amazing} {Brilliant} {Improved} {Enhanced} {Advanced} {Quality} {First Rate} {First Class}
{Excellent} {Superior} Water – pH neutral – sparkling clear

Less {chlorine} {work} {money} {swimsuit {fading} {bleaching}} {monitoring} {worries} {hassles}
{bromine} {time} {cost} {daily {duties} {dosing} {odors} {harshness} {over dosing}}

More {fun} {enjoyment} {relaxation} {softness} {pleasure} {satisfaction} {gratification} {leisure}
{recreation}

Stop! Do not mix with other products or dissolve before use.
Read precautions / first aid statements on label {before using}
Call 7 days a week (8am to 10pm Eastern Time) with questions concerning pool water care
Helpline: Call {866-HTH-POOL} {866-484-7665} toll free or visit hthpools.com
In case of medical emergency call: {800-654-6911} {800-424-9300}
Customer {call} {care} center: 800-455-4311

{Nothing is easier than} {You can't mess up} plop {in}
{Visit us at} {Learn more at} {heycoolpool.com}
{From} Hey! Cool Pool

{Value Pack} {Contains} {Includes}: 1 {Brand} Mineral {Cartridge} {Complete System} {and} {plus} #
{Replacement} {Prefilled} Chlorine Cartridge{s}
Complete 2 Part Cartridge System {Inside} {Included} {- Minerals and Chlorine}
{Contains} {Includes} 2 cartridges {(minerals and chlorine)} for 1 complete system
{Brand} is a complete system of 2 cartridges {- Minerals and Chlorine}
Duo system {of} mineral{s} {+} {and} chlorine {cartridges}

{Brand} fresh {mineral clean pool care} {clean and easy}
Fresh {mineral} {pool} {spa} {hot tub} {water} care
Great water care value
Refresh your {pool} {spa} {hot tub} with {Brand}
{Brand} fresh water is clean water
Freshen up your {pool} {spa} {hot tub} {bottom line} with {Brand}
No one says fresh like {Brand}

[All text on this page is optional]

{Brand} {keeps water} {does} fresh
{Brand} makes fresh – {the} mineral pool care for your customers and your business
Fresh ideas {to help grow your business} {only from {Brand}}

Fresh new {products} {business strategies} bring in new customers while maintaining old customers
With {Brand} you know {it's} {your} {water's} {pool's} {spa's} fresh
The fresh {alternative to standard water care} {way to good clean fun}

Think Fresh – Think {Brand}
Think {Brand} – Think Fresh
Keep your water {Brand} Fresh
Don't dump it – revive it!

Water starts fresh and stays fresh with {Brand}
You don't need a new pool, you need {Brand} {Fresh}
{{Brand} keeps your pool} {spring} fresh all summer long

Summer long value pack
A summer pool care value pack
Complete summer pool care inside the box

Restore your water with {Brand} {Fresh}
Revitalize your {backyard fun} {business} with {Brand} {Fresh} Mineral Pool Care
C'mon in, the water's {fresh} {clean} {clear} {inviting} {fine}

Flip {plop} Fresh
Flippin' {Brand} Fresh
Fresh as a {Brand}

So fresh, so clean, so clear, so easy {- Brand}
So clean, so clear, so fresh, so easy {- Brand}
The universal language of fresh - {Brand}

More {fresh} {refreshed}
{Brand} happiness
Fresh, recycle, refresh

Chlorine is great because, well... it works! But, sometimes there really can be too much of a good thing. Too much chlorine can be harsh, fading swimming suits and damaging pool equipment. So we came up with a clever (and fun) alternative – *Pool FROG Mineral Reservoir!*

We all know chlorine does the job of keeping water clean but it's not always fun to swim in. It fades suits and pool surfaces. It smells to high heaven at times. That's why we invented {Brand} fresh mineral water[∞].

Pool FROG Mineral Reservoir {uses minerals in addition to} [and/or] {creates mineral water along with} a small dose of chlorine to kill off unwanted bacteria. So, you get the benefits of chlorine, without all the negative {effects} {drawbacks}! Oh, and the minerals leave your water feeling soft and silky.

[All text on this page is optional]

And no more yo-yo pH because too much chlorine can drive your pH down. A low level of chlorine {will have less effect} {keeps the pH more stable}.

You probably know that chlorine is used to keep your pool clean, but {use} {put} too much {in} and it can fade bathing suits, damage pool equipment, leave a harsh smell and ruin your summer! That's why we {put minerals in} {create mineral water with} Pool Frog Mineral Reservoir. {Minerals} {Mineral water} allow{s} us to use a much smaller amount of chlorine and still kill the unwanted bacteria. You'll love the way Pool Frog Mineral Reservoir keeps your water silky soft and crystal clear all summer!

Without the {right treatment} {proper amount of the right stuff}, all pools {and {spas} {hot tubs}} are subject to nasty bacteria growth that causes murky water and harsh smells. But, Pool Frog Mineral Reservoir's {one-two {combo} {punch} of minerals and low levels of chlorine} {mineral water with far less chlorine} deliver a knockout blow that destroys bacteria in its tracks.

On the other hand, if you treat your pool with too much chlorine, it won't be long before the kids are complaining that the water doesn't feel good and it stinks! And to add insult to injury, uncontrollable variables like outdoor temperature, swim usage, the length of the season, and rainy weather mean varying pH levels that need constant balancing.

But, we're guessing you didn't buy an {above ground} {pool} {spa} {hot tub} to become an expert in pool chemistry. You just want clean, clear water without all the fuss. We intimately know this because we're pool owners, too! That's why we invented Pool Frog Mineral Reservoir {Brand} {fresh} {mineral water}.

{Brand} Fresh
{Featuring} {Brand} Fresh mineral water[∞]
{Brand} Fresh mineral {swimming} pool water
{Brand} Fresh mineral {spa} {hot tub} water
{Brand} Fresh mineral water[∞] {made} easy
The sparkling water for any pool or {spa} {hot tub}

{Fresh Mineral Water[∞]} {Splash Therapy} {– one dip to soothe body and soul}
Fresh Mineral Water[∞]. No sweat
{Fresh} Mineral Water refreshment you can {have fun in} {relax in} {say aaahh in} {splash in} {laugh in} {smile in}

Quench your thirst for fun
Fresh Mineral Water[∞] is {easy} {less time consuming} to take care of
{Brand} Fresh Mineral Water[∞]. Not imported. {Refreshed} {Made fresh} in your own backyard
{Patented} mineral technology makes perfect clear water
No hard feelings with Fresh Mineral Water[∞]

Raise your glasses to Fresh Mineral Water[∞] – your sunglasses that is
Happy Hours with Fresh Mineral Water[∞]
{Brand} Fresh Mineral Water[∞]. On a hot day, just add fun!
{Brand} Fresh Mineral Water[∞]. The perfect mixer for any summer occasion

{Brand} Fresh Mineral Water[∞] makes any pool occasion effervescent
CRT – Chlorine Reduction Technology
A fresh perspective on {pool} {spa} water

Experience the difference of Pool Frog Mineral Reservoir
Sparkling {mineral} water for pools up to {5000} {10,000} {15,000} {25,000} {40,000} gallons

[All text on this page is optional]

Sparkling {mineral} water for {spas} {hot tubs} up to 600 gallons
Fresh {intelligence} {perspective} {start} {look} {feeling}
{Minerals} {Mineral water} make{s} a difference you can see and feel
Lasts {4} {6} full months

Relax, Laugh, Have Fun!
Watch your {grand} kids laughing, splashing and {playing} {having fun}
Feel the relaxing ahhhhh of fresh mineral water[∞]

Enhances swimmer comfort
Prevents unpleasant odors
Stress free pool care

Cheaper to maintain
Flip, Plop and forget
Forget about {pool} {spa} {hot tub} hassles and keep all the great memories!

Forget about maintenance for a few days (or weeks). It's ok – {Brand} is in charge
Crystal clear {pool} {spa} {hot tub} water for dummies
{Pool} {Spa} {hot tub} care for dummies

Here is what {Pool Frog Mineral Reservoir} {mineral water} users say:

"I rarely have to shock"

"very little maintenance"

"keeps water clean and clear"

"This product is so easy to use and it works well"

"keeps my pool water clean without irritating the swimmers"

"I love the {Brand} products, they make everything so easy."

"No harsh chlorine smell, no handling of chemicals. Simple, clean, perfect"

"Used a lot less chlorine and the filter stayed much cleaner and more efficient"

"We had some family critics who said that pools were a lot of work. NOT with {Brand} they aren't"

"{Brand} is so easy to use and has dropped the chlorine level, but kept the pool perfect."

Mineral{s} {water} replace{s} pounds of chlorine every summer
Experience the difference of {Brand}
The {Brand} Fresh Mineral Water[∞] Pool {Spa} {Hot Tub}

The Mineral Water {Swimming} {Pool} {Spa} {Hot Tub}
The Mineral Water {Swimming} {Pool} {Spa} {Hot Tub} {made easy} Guys
The Fresh Mineral Water[∞] {Swimming} {Pool} {Spa} {Hot Tub}

Crystal Clear {fresh} Mineral Water Pool
You've heard of Salt Water Pools. This is a {sparkling} {fresh} Mineral Water Pool.
It's like a whole new product - The {sparkling} {fresh} Mineral Water Pool
The difference is {crystal clear} {fresh}.

A fresh approach to keeping pool water clean - easier
A fresh approach to keeping pool water cleaner
A fresh approach to keeping pool water cleaner made easy
Go ahead - get fresh with us.
Get fresh in the pool.
Get fresh with {Brand}

[All text on this page is optional]

Pool boys have been really getting fresh lately.
Refresh yourself.
Get refreshed

Good clean fun - with a splash.
Why have a chlorine pool when you can swim in fresh mineral water[∞].
Get fresh in your pool with fresh mineral water[∞]

Refreshingly {easy} {clean} {clear} {comfortable} {enjoyable}
Nice {pool} {spa} {hot tub}! Can we freshen that up for you?
Buying the pool was easy. Shouldn't taking care of the pool water be just as easy?

"Don't you hate it when you're all ready to have some fun in your pool – it's a beautiful sunny day, and the kids are all set to jump in – only to find that bacteria and algae have taken over, leaving the pool green, cloudy and too dirty to swim in. Talk about a kill joy."

We have two words to share with you – Pool Frog Mineral Reservoir - the "almost too easy" way to keep your water crystal clear all summer long – from *Hey! Cool Pool*. How easy is it you ask? Well, you simply plop it in the pool and it goes to work on nasty bacteria and other things that make water cloudy, murky or worse. When it flips over it's time to replace the bottom cartridge. Then plop it back in.

Where most pool floaters use 100% chlorine, Pool Frog Mineral Reservoir uses minerals, leaving you with fresh mineral water[∞] that feels softer without fading swimsuits, damaging pool surfaces or creating smelly odors. Having a mineral water pool means you're not swimming in a {chlorine} {chemical} bath like most pools. Mineral water also maintains its balance better meaning less work and greater comfort for swimmers.

This EPA registered product for water care, without all that chlorine, has been sold in larger pools for over 15 years. Pools as small as {1000} {2000} gallons can experience the mineral water difference.

Here's how it works. There are two cartridges. The top {insert color} cartridge provides mineral water all summer long. The {insert color} cartridge will deplete every 3-4 weeks. Simply connect the two cartridges by lining up the arrow with the unlock symbol. Then you twist to the setting that's right for your pool. There's a helpful chart in the manual with a setting for every pool size. Then plop it in the pool.

You'll know when to replace the bottom cartridge when the product flips over and the {insert color} side is up. Simply twist the top back to the unlock symbol and pull apart. Recycle the empty cartridge and lock in a new one. At the end of the summer, if the bottom cartridge still contains some ingredient, wrap in a plastic bag and store in a cool dry place for the winter. Discard the top cartridge as it is spent once removed from water (or after six months whichever comes first). Start fresh with a new system next summer.

With thousands of pool owners enjoying the benefits of fresh mineral water[∞], we want to encourage you to take the Pool Frog Mineral Reservoir challenge. Try it in your pool for 30 days and see if you don't experience softer, clearer water with less work! Then you too will be a believer in mineral water!

Enjoy clearer pool water with less work

Pool Frog Mineral Reservoir is available at most Walmart stores around the country. Visit our website at kingtechnology.com frogproducts.com to learn more and find a retailer in your area.
Take A Fresh Look at {Brand} Mineral Water
See What Fresh Mineral Water[∞] Is All About!

[All text on this page is optional]

Fresh Mineral Water[∞] – That's More Like It!

It's like having an entire summer's worth of pool cleaning service in the palm of your hand!

{Hard} {Tough} {on} {Kills} bacteria,

Water, made mineral-fresh!

Beyond Chlorine

It's Pool Frog Mineral Reservoir Fresh!

Fresh-Water Fun!

Keeps water looking and feeling fresh!

{Using} {Uses} minerals to keep water looking {sparkling clean} and feeling fresh

If you just bought a{n} {above ground} pool, you NEED {this} {Pool Frog Mineral Reservoir} to make it work properly.

Chlorine is chlorine is chlorine. Everyone knows what it is and what it does. That doesn't mean everyone loves it! It's assumed using chlorine is what you do if you own a pool or {spa} {hot tub}. You put gloves on before using then hold your breath and hope you don't spill any on your clothes! Each time you ask yourself, is there another way to do this?

There is another way. It's called fresh mineral water[∞] and it will change the way you feel about your pool or {spa} {hot tub}. Mineral water that reduces chlorine use up to 50%* is easier on {skin} {suits}, helps protect surfaces and equipment and makes smelly pool or {spa} {hot tub} odors a thing of the past. Mineral water is refreshing and inviting because the level of chlorine in the water is greatly reduced.

Instead of a chlorine only treatment method, mineral water is a chlorine {enhancement} {alternative}. It takes what chlorine does like kill bacteria and provides what chlorine can't – soft water that's more enjoyable to swim and soak in

While chlorine has been a proven disinfectant in swimming pools and hot tubs since the 1920s, if left unchecked, it has a reputation for harshness. Anyone who has ever taken a dip in overly chlorinated water can tell you a few things about how it leaves their skin, their suits and the damage it can cause to surfaces or equipment. Most people say, "Oh well, that's just what you have to do, right?"

Wrong! There is {an alternative} {an easier way} that cuts chlorine use up to 50% so water feels silky soft without bleaching swimming suits and with far less of those smelly odors! We call it mineral water because it uses minerals to keep the water fresh and clean. The end result is sparkling water that feels as good as it looks with far less chlorine!

Water feels silky soft without bleaching swimsuits or damaging surfaces.

We call it a low chlorine {enhancement} {alternative} because when used with the EPA registered mineral formula, a low level of chlorine finishes the job without all the drawbacks. Your pool or {spa} {hot tub} experience is enhanced {with} {through} water that's clean and fresh with up to 50% less chlorine!

Fresh mineral water[∞] is only available in {Brand} brand products by King Technology, Inc. For {{more than 15} {many} {years}} {decades} we have {been helping} {helped} hundreds of thousands of people relax and enjoy their pool or {spa} {hot tub}.

Your Grand Mother thought using {all} {only} {just} chlorine was good

{Nothing but} {Just} {All} chlorine used to be the best thing but now there's {Brand} Fresh mineral water[∞]

Your Grandmother used {all} {only} {just} Chlorine. We know you love her, but {it's} time for a change

[All text on this page is optional]

Using chlorine alone has its drawbacks like faded swimsuits and smelly odors but not with Fresh Mineral Water[∞]

Time for the {all} {just} chlorine {only} challenge

Why not go {Brand} Fresh Mineral Water[∞] for a change

Replace your all chlorine pool with a Fresh Mineral Pool

Replace your "all chlorine pool" with Fresh Mineral Water[∞]

Water starts out fresh. Minerals help keep it fresh by destroying bacteria along with a low level of chlorine or bromine. This fresh approach {to water care} {is mineral water that} creates a pool or {spa} {hot tub} experience of relaxation and fun. Your skin is less irritated. Your suits stay bright and fresh and your pool or {spa} {hot tub} investment lasts longer by maintaining its fresh new look. Refresh your thinking about {pool} {or} {spa} {hot tub} water {care} with the proven, problem-free, EPA registered mineral water systems from {Brand}.

Pool FROG Mineral Reservoir – Fresh Mineral Water[∞] for pools up to {3000} {4000} {5000} {6000} {8000} 10,000} gallons. Simply floats in the pool and flips over when empty. Another repeat sale opportunity from {Brand}!

Pool FROG Mineral Reservoir {Above Ground} {25K Gallons} – Fresh Mineral Water[∞] for pools up to {15,000} {20,000} {25,000} gallons. Easy installation, convenient no-touch replacements drive 3 repeat sales every year!

Pool FROG Mineral Reservoir {In Ground} {40K Gallons} – Fresh Mineral Water[∞] for pools up to {30,000} {35,000} {40,000} gallons. Pool FROG XL PRO with a larger chlorine pac also available for greater satisfaction on larger pools.

{Brand} Mineral Floating System – Fresh Mineral Water[∞] for {spas} {hot tubs} up to 600 gallons. Simple and Effective. clean, soft and sparkling clear water. Prefilled and adjustable cartridges make it easy.

{Brand} Test Strips – The only way to ensure {fresh mineral water[∞] with lower} {the proper} chlorine or bromine levels {for {Brand} mineral water products} with the ease of Dip and Read! Tests for pH and Total Alkalinity too!

Mineral Water Test Strips

Fresh {mineral} water – clean, clear

Fresh feeling – soft not harsh

Fresh ingredients – not the same old chlorine but minerals with a low level of chlorine

Fresh approach - no touching, smelling or measuring chlorine

Fresh thinking – {Brand}'s got it covered. I can relax and enjoy

Amazing product helps you get in (and out) of your above ground pool with ease.

This system takes cleaning your {pool} {spa} {hot tub} to a whole new level

Responsible moms use {Brand}

Say no way to "All" chlorine

Say no to "All" Chlorine

{Brand} Fresh Mineral Story

Fresh Mineral Water[∞] Care

[All text on this page is optional]

The {Brand} Fresh Way – Revolutionary
Swim w/ Fresh Mineral Water[∞]
Floats & flips when empty
From Hey! Cool Pool comes a new product – Pool Frog Mineral Reservoir

[Dealer / Trade Copy]

{Brand} Makes Fresh
{Brand} Fresh Makes Smart
A fresh twist on pool care

Fresh Products – with patented technologies and a clever twist
Fresh Markets – identifying untapped opportunities and creating solutions to serve each niche
Fresh Friends – connecting pool and {spa} {hot tub} owners with dealers through social media

Fresh Refresh Success – today's sales refreshed with profitable replacements every year
Fresh Defense – protecting dealer's margins and customer retention through our MAP policy
Fresh Defense against resellers who would devalue the {Brand} brand

{Brand} Fresh has a whole new meaning. First, {Brand} doesn't sell minerals, it sells fresh mineral water[∞] made easy. And {Brand} Fresh is about a good times mindset. With {Brand} you're selling good times ahead in the fun zone. And if you don't sell {Brand}, this is a chance for a fresh start.

Every {Brand} product refreshes water and refreshes profits
Take a Fresh look at {Brand} Minerals
A clean win for your customers.
A clean break from the past.
Fresh {Products} {Strategies} {Thinking} {Focus} {Benefits} {Ideas} {Approach} {Feeling} {Financials}
{Profits} {Sales}

[Article Headlines]

Don't buy chlorine until you've read this first!
This plus 15 minutes per week will keep your pool water crystal
Before you buy a salt {water pool} {generator}, you should know {this first} {about mineral water pools}
What you need to know {about mineral water pools} before you choose {a} chlorine {pool}.
Thinking {salt water} {chlorine}? Think again.
Most pool owners only clean their pool with chlorine and miss this key ingredient
What new {above ground} pool owners don't know yet that could cost them dearly

If you just bought an {above ground} {easy set} {inflatable} pool, don't make these common mistakes
Common mistakes {above ground} pool owners make
The biggest mistake people make when they buy a new {above ground} pool is this (don't make the same mistake!)
What most people don't know about their new {above ground} pool (and how it will cost them dearly!)
What you need to know {if you just bought a{n} {above ground} pool} {before you make your pool a chlorine pool}
What you're missing if you only treat your pool with chlorine
Oops! You let your pool get too cloudy. Here's the fastest {and easiest} way to crystal clear water {again} {-easy!}.
Help! The water in my pool is green! Here's how to fix it.
Don't buy {just} chlorine for your pool until you've read this!
What sounds better to you? Chlorine water? Salt Water? or Fresh Mineral Water[∞]

[All text on this page is optional]

Which would you like better, 100% chlorine or fresh mineral water[∞] with up to 50% less chlorine*
What's a chlorine pool vs a mineral water pool?

See model number on top of box
Find the Cyclor model this fits on top of box
See your dealer for details

Use {53735-12 Brand Name} for easy {spa} {hot tub} start-up with a fizz!
{Try {53735-12 Brand Name}} {The} one dose {start-up} shock for {spas} {hot tubs} up to 500 gallons
Jump Start your {spa} {hot tub} with {53735-12 Brand Name}

Crystal Clear Pool Water {Easy}
3 Bonus Cartridges and Value Pack
Summer Value Pack with 3 Bonus Chlorine Cartridges

Specifically for {larger} {Intex style} {above ground} pools up to 10,000 gallons
Use Pool Frog Mineral Reservoir for pools {up to} {2000 to} 5000 gallons and Pool Frog Mineral
Reservoir for pools 5000 to 10,000 gallons
For {above ground} {in ground} pools {15' to 21' diameter} {(}5000 to 10,000 gallons{)}

Simply {pull} {snap} off the old cartridge and replace
Easy to replace chlorine cartridge – snap in, push the tabs to release
This mineral water solution has worked on big pools for over 15 years
You can get this proven effective pool care method for Intex style pools as small as 2000 gallons
Mineral water helps reduce the monitoring and adjusting you need to do to keep your water at the
right balance.

It is not your old fashioned chlorine floater. Pool Frog Mineral Reservoir provides a tested and EPA
registered alternative to chlorine alone.
Mineral water cuts back on the use of and exposure to chlorine because everything is pre-measured
and prefilled. No daily fussing with adding chlorine by hand.

The {key} {secret} {to {Brand}'s success} is fresh mineral water[∞] that {handles} {kills} tough bacteria,
creates a soft feel and a crystal clear shine – all with a minimal amount of chlorine added.
Mineral water has far less chlorine in it than standard pools
Experience refreshing mineral water that reduces chlorine use up to 50% so it's easier on skin, helps
maintain pool surfaces and makes pool care easy!

It all adds up to more fun for you and your family.
Mineral water feels as good as it looks because it feels fresh not harsh
It eliminates bacteria a whole different way – with a lot less chlorine

It's easy on your clothes and easy on your nose.
Hey! When your water smells like chlorine you smell like chlorine
And unlike salt pools, it doesn't corrode metal or eat stone
Why settle for ordinary water when you can have fresh mineral water[∞] – easy.

Mineral water protects your pool or {spa} {hot tub} investment because it's easier on surfaces
Just fresh mineral water[∞] – soft and crystal clear as a mountain stream
A strong chlorine odor does not smell fresh

[All text on this page is optional]

{53735-13 Brand Name} is a 3 step convenience pack for opening pools {in the spring} or closing pools {in the fall}.

- {Brand Name} is a non-chlorine shock that rids the water of contaminants
- {53735-13 Brand Name} is a chlorine shock that sets the chlorine residual in the pool
- {53735-9 Brand Name} is a 90 day algae preventative that is guaranteed to protect the pool against algae {prevents algae for 90 days – guaranteed}

Start by describing Fresh Mineral Water[∞] and the benefit of more fun times because:

Fresh Mineral Water[∞] feels softer and looks crystal clear.

Fresh Mineral Water[∞] doesn't fade suits or damage pool surfaces.

Fresh Mineral Water[∞] keeps the pH in line with less monitoring.

Fresh Mineral Water[∞] uses far less chlorine than standard pools.

And Fresh Mineral Water[∞] is not corrosive like salt systems.

In short, {Brand} Fresh Mineral Water[∞] is less hassle, allowing you to spend more time with family and friends.

The future of {pool} {spa} {hot tub} water

{Come} {You can} {feel} {see} {experience} the difference

Crystal clear and comfy

Have fun again

Water never felt this {good} {clean} {amazing}

Feel good about your {pool} {spa} {hot tub} water

The decision is clear

{Significantly} {dramatically} {reduces chlorine use} {less chlorine}

It's amazing how easy crystal clear {pool} {spa} {hot tub} water can be

Fresh Mineral Water[∞] {Easy} – {only from} {from} {by} {brought to you by} {Brand}

Easy crystal clear water

{Quality} {First Class} {pool} {spa} {hot tub} {fresh} {clean} {clear} {relaxing} {soft} water

{You} {Your kids} {Your family} will feel the difference

The difference you feel is clear

A difference you can {see and} feel

Splash, laugh and have fun

You can't have fresh mineral water[∞] without {Brand} {the Pool Frog Mineral Reservoir}

The only way to fresh mineral water[∞] is through the Pool Frog Mineral Reservoir

Want a mineral water pool – get {Brand}

Your pool should not be a weekend chemistry class

Pool maintenance should not be a weekend chemistry class

One small jump for {Brand}. One {Brand} for pool care

The water you've been waiting for

Time to Change How You Think About Pool Water

You're About to Become a Water Groupie

A Whole New Reason to Get Wet

You Will Feel the Difference

Oh Yeah! There's a Difference!

Yeah! It's a Big Deal!

[All text on this page is optional]

Soak in the Softness
Come On! This Isn't Hard!
Feeeeeeel the Difference!
Cleaner, Clearer, Softer

Your Pool Just Got Way More User Friendly
We Just Made Your Pool More User Friendly
Crystal Clear Water Only More User Friendly

The Water You've Been Wading For
It's a Love That Will Not Fade
Let the {Brand} fun begin

Fresh Mineral Water[∞] Easy is all about "er"....because with "er" you get water quality that only {Brand} Fresh Mineral Water[∞] delivers. With Fresh Mineral Water[∞] from {Brand}, you can be assured of cleaner, clearer, and softer water.

{Destroys} {Kills} bacteria {for} {to give you} crystal clear {pool} water
Intex is a registered trademark of Intex Corporation and {is} not affiliated with {Hey! Cool Pool} {King Technology, Inc.}

Plop Pool Frog Mineral Reservoir into {the} {your} pool and watch {your} ordinary tap water become fresh mineral water[∞] – cleaner, clearer and softer.
With less chlorine use, there's less cyanuric acid to build up in the water.

Up to 50% Less Chlorine means your CYA will build up to 50% slower
Child resistant bag
{Less exposure with} sealed packaging
Not your ordinary floater
Buy a better floater
Compulsive obsessive perfectionism for your {pool} {hot tub} {spa}

{Brand} Forecast: Cloudy today. Crystal clear tomorrow.
At {Brand} we're maniacal about quality and equally obsessed about making your life easier
If your memory is cloudy, your pool will be too. Don't forget to change your Pool Frog Mineral Reservoir.
Put {pool} {hot tub} {spa} bacteria on the endangered species list – change your Pool Frog Mineral Reservoir every {4} {6} months

{Brand} Smart Technology
35 years of water treatment innovation
Product shown is actual size

THE ALTERNATIVE WAY TO SANITIZE

A fresh approach to clean, clear water using mineral technology that uniquely offers these 4 advantages

{Cleaner because {it} {product}} {kills bacteria two {2} ways} – {with minerals} and {a low level of} {chlorine} {bromine}
Minerals help keep the pH balanced for Clearer water that shines
{Plus} Minerals condition the water for Softer {effects} {feel}
Cartridges are prefilled {for} {no mess, no guess, no stress} making maintenance Easier.

[All text on this page is optional for marketing in conjunction with 53735-14 Brand Name]

Mineral System with {53735-14 Brand Name}

For cleaner, clearer and softer water that cuts the use of chlorine by 75%*

Each {53735-14 Brand Name} molecule contains 2 chlorine atoms – one for immediate use and one left in reserve to release as {needed} {bather load varies}

The simple science of maintaining a consistent sanitizer level

No peak and valley sanitizing

{53735-14 Brand Name} creating a {reserve} {bank} of untapped chlorine that continually converts into active chlorine against bacteria

Floating {Sanitizer} {Sanitizing System} for {hot tubs} {spas}

Automatic All-in-One {Hot Tub} {Spa} Care

Complete {Hot Tub} {Spa} Care System

{Creates} Fresh Mineral Water[∞] with {53735-14 Brand Name}

{An} innovative slow dissolving mineral system {that destroys bacteria while using {up to 75%*} less chlorine – creating cleaner, clearer and softer water}

1 floating {spa} {hot tub} {sanitizer} {sanitizing system} + {plus} # Test Strips + {plus} {and} # {53735-12 Brand Name} {start-up shock}

Fresh Mineral Water[∞] {Easy}

An {exclusive} {unique} {proprietary} {innovative} {stand out} water care system from {Brand} that delivers 4 primary advantages

{Cleaner because it} kills bacteria two {2} ways – with minerals and {a low level of} {chlorine} {bromine}

Minerals help keep the pH balanced for Clearer water that shines

{Plus} Minerals condition the water for Softer {effects} {feel}

Cartridges are prefilled {for} {no mess, no guess, no stress} making maintenance Easier.

{Learn more at} {For more advantages see} kingtechnology.com frogproducts.com

{Uses} Up to 75%* less chlorine {with no {frustrating} yo-yo chlorine levels}

Cuts chlorine use up to 75%* while maintaining a constant level

Uses only 25% of normal chlorine levels

Chlorine lasts 3X longer with {53735-14 Brand Name} and {Brand} Minerals

Shock {only} once a {per} month

The unique {53735-14 Brand Name} technology does the work with far less shocking

Here's a shock – No need for weekly shocking your {hot tub} {spa}

The chlorine that automatically shocks the water for 4 weeks

Self {shocking} {refreshing} {chlorinating} water care system

So little shocking, it's shocking!

Takes the shock out of {hot tub} {spa} care

No shocking the {hot tub} {spa} after each use

{Hot Tub} {Spa} Water Care – for once you're not in for a shock

Making a little chlorine go a long way

Just what you need – and no more

Because less is more

Self regulates {chlorine levels} for continuous crystal clear water

The unique chlorine reserve goes into action only when needed

[All text on this page is optional for marketing in conjunction with 53735-14 Brand Name]

The two step chlorine that's time released to meet {hot tub} {spa} demand
When you hop in, {53735-14 Brand Name} goes to work keeping water clean and clear

Easy on {hot tub} {spa} surfaces with less odors
Using {much} {up to 75%} less chlorine*, {reduces} {minimizes} faded swimsuits and drying out skin or hair
Protects your {hot tub} {spa} investment while providing a more enjoyable experience
Easy on your nose
Single color match for easy reading – {exclusively with} {only from} {Brand} Test Strips
Test Strips – the only sure test for {53735-14 Brand Name}
Simple Go – No Go water testing only from {Brand} products
The easy test strips only from {Brand}

The innovation of {53735-14 Brand Name}
These benefits provided {brought to you} by {the breakthrough technology of} {53735-14 Brand Name} {Technology}.
The chlorine that {reacts} {responds} to {hot tub} {spa} use by maintaining a consistent chlorine level
Unlike normal chlorine that is used up when you get it, {53735-14 Brand Name} continues to maintain the same level
The {vigilant} {proactive} {responsive} {reactionary} chlorine that consistently protects {sanitizes your water} {keeps your water clean & clear}
When you get in, normal chlorine levels drop but {53735-14 Brand Name} remains constant
Fresh Mineral Water[∞] Cartridge Lasts 4 months
4 Months of Fresh
{53735-14 Brand Name} lasts {2} {3}-4 weeks
Floats in the {hot tub} {spa}
Flips over when the {53735-14 Brand Name} is empty

No adding chlorine daily
No more daily spoon fulls of chlorine
Ditch the daily dosing
Eliminates a cap full a day
No daily maintenance

Stop spoon-feeding your {hot tub} {spa}! {It can take care of itself} Sporks are for drive-ins, not {spa} {hot tub} care

No measuring, no math, no doubt.
Intelligent water care
You don't have to be a genius to see it's {working} {innovative} {amazing} {smart} {not your ordinary water care} {in a class by itself}

A real breakthrough in {hot tub} {spa} {water} care. A real break for you.
All the clean without all the chlorine
No guesswork. Just less work.
{Hot Tub} {Spa} {water} care doesn't have to be so hard

To find out how you can be more @ease visit kingtechnology.com frogproducts.com
Whew, the honey-do-list {your to do list} just got shorter

[All text on this page is optional for marketing in conjunction with 53735-14 Brand Name]

To find out how you can shorten your honey-do {to do} list visit kingtechnology.com frogproducts.com

{Brand} Mineral System at your service

Nicknamed “the butler” our innovative slow dissolving mineral system with {53735-14 Brand Name} for {hot tubs} {spas} will no doubt leave you more at ease

To find out how you can get your own butler visit kingtechnology.com frogproducts.com

Crystal clear {hot tub} {spa} – chemistry degree not required

{Brand} Mineral System is @utomatic

Minerals Destroy Bacteria for less chlorine use

{53735-14 Brand Name} slowly releases chlorine when needed

Together they create Fresh Mineral Water[∞] that’s Cleaner, Clearer, Softer and Easier

The Mineral Innovation

- Reduces chlorine use up to 75%*
- Conditions the water for softness
- Easy on {spa} {hot tub} surfaces with less odors
- Lasts four full months

The Breakthrough Science {Technology} of {53735-14 Brand Name}

- Maintains a consistent 0.5 ppm {sanitizer} {disinfectant} {chlorine} level
- Uniquely time released with a chlorine reserve ready when needed
- Easier to test with Test Strips and one color match
- Oxidizes contaminants so far less shocking is required

How {Brand/Product} Works

- The Fresh Mineral Water[∞] Cartridge snaps together with the {53735-14 Brand Name}
- It floats in the hot tub {spa} and flips over when the {53735-14 Brand Name} is empty
- Replace the {53735-14 Brand Name} (every {2} {3}-4 weeks) and recycle the empty one

Pool Frog Mineral Reservoir and {53735-14 Brand Name} completely sanitize any hot tub {spa} with no need for ozone, UV or other devices.

Compatible with ozone {UV} if desired

Start with a freshly filled {hot tub} {spa} or convert any {hot tub} {spa} to Fresh Mineral Water[∞] with {53735-14 Brand Name} Technology

No corrosion issues with {53735-14 Brand Name}

Hassle free {hot tub} {spa} sanitization {water care} {maintenance}

Water looks and feels luxurious

{53735-14 Brand Name} isn’t susceptible to big swings in sanitizer levels after use. It maintains a consistent level that just works!

{Welcome to the} spoon-free zone

Step into easy

{Hot tub-life} {Spa-life}. Made easy

Take it easy on yourself

Easy-does-it

Easy-to-tell

Easy-to-see

Easy-to-understand

[All text on this page is optional for marketing in conjunction with 53735-14 Brand Name]

Easy-to-follow
Easy-to-wow
Easy-to-read
Easy-to-decode
Easy-to-use
Relax & Enjoy

Yes, it does revolve around you
More innovation. Less stress.
More innovation. Less upkeep.
More wows. Less ughs.

The difference between {liking and loving your {spa} {hot tub} {perfect pH and pHew!}
The difference between green and clean
How can anything this hard on bacteria feel so soft
Feel the difference
For {Hot Tubs} {Spas}

{Plus} {Also} {Includes} {#} test strips and {#} Jump Start start-up shock
Contains, 1 Pool Frog Mineral Reservoir, 1 {53735-14 Brand Name}, 1 {53735-12 Brand Name}
start-up shock packet and 1 bottle of # Test Strips
Contains, {3} {4} {53735-14 Brand Name} Cartridges and {3} {4} {maintenance} {non-chlorine} shock
packets

Welcome to {Brand} Mineral System hot tub water care courtesy of {Brand} with Fresh Mineral
Water[∞] and {53735-14 Brand Name} Technology. To help you get the most from your {Brand}
Mineral System, we'd like to send you a few helpful start-up and basic maintenance tips via e-mail.
Simply complete this card and throw it in the mail or visit kingtechnology.com frogproducts.com
and click on Join our Newsletter. If you have any questions, please call our Customer Service
Department at 800-222-0169. Sign up for helpful e-mails today!

Creates Fresh Mineral Water[∞] {that's}

- Cleaner because it kills bacteria two ways
- Clearer because it helps keep pH {in an acceptable range} {balanced}
- Softer because {minerals condition the water for softness} {there's up to 50% less {chlorine} {bromine}}
- {Easier with} prefilled cartridges for no {touching} {mess,} {no guess, no stress} {or measuring} {bromine} {chlorine}

Easy {Spa} {Hot Tub} Start-up

{Brand} Test Strips

- It's the only strip with the ideal {chlorine} {bromine} range for {Brand} {spas} {hot tubs}
- Most test strips show this level as too low causing confusion
- {Brand} Test Strips help dial in the right setting for your {spa} {hot tub}
- The result: Your {53735-10 or 53735-16 Brand Name} will last up to 50% longer
- Using standard test strips can lead to over {chlorination} {bromination} and wasting money
- Accurately measures the reduced bromine level of 1.0 to 2.0 ppm
- Adjust your cartridge setting to maintain the ideal {Brand} {chlorine} {bromine} range.
- Get a longer life to your {chlorine} {bromine} {cartridge} {pac}

{53735-12 Brand Name}

- Start-up shock removes contaminants and sets the residual

[All text on this page is optional for marketing in conjunction with 53735-14 Brand Name]

Dichlor is difficult to maintain at consistent levels {and requires constant dosing}
{Take the pain out of hot tub care} {Make it easy} with {Brand} Mineral System
Stop doing things the hard way
Switch {from Dichlor} to {Brand} Mineral System and you'll never go back {to Dichlor}
Ease {up} {your hot tub care} {. Try} {with} {Brand} Mineral System
The easiest thing you'll ever do
Dichlor is a {drag} {chore}
{Dichlor is hard} {End the chore of Dichlor} {{Brand} Mineral System does everything Dichlor does but easier} with:

- {No} yo-yo chlorine levels
- {No} daily chlorine dosing
- {No} touching or spilling chlorine
- {No} wondering how much to add

[Optional language for marketing in conjunction with 53735-14 or 53735-16 Brand Name]

{Brand System} has no {cyanuric acid} {CYA} that can build-up quickly leaving chlorine ineffective and requiring you drain the water prematurely.
Dichlor adds {cyanuric acid} {CYA} to the hot tub with every dose. {Brand System} does not.
{Cyanuric acid} {CYA} too high? It's time to drain your hot tub. {Brand System} has no {cyanuric acid} {CYA} so you could still be enjoying your hot tub.

{Cyanuric acid} {CYA} protects the chlorine from sunlight's destruction} {from being burned off by the sun}. Since hot tubs are covered, there is no need to protect the water from the sun so there is no need for {Cyanuric acid} {CYA}.

When {cyanuric acid} {CYA} gets too high in a dichlor hot tub, the water is over stabilized. The result is:

- Dichlor becomes less effective, decreasing its bacteria-killing power
- The water becomes {hazy} {cloudy} or algae appears
- An unsafe hot tub for family and friends
- You have to drain your water and start again.

Did you know when you use dichlor, your {building up {cyanuric acid} {CYA}} {creating a {cyanuric acid} {CYA} bath} {asking for trouble with {cyanuric acid} {CYA} build up}?

The {53735-14 or -16 Brand Name} difference is what we don't put in {it} {53735-14 or -16 Brand Name}

With no {cyanuric acid} {CYA} in {53735-14 or -16 Brand Name}, you can {extend the life of your hot tub water} {{go longer between} {reduce the hassles of constant} draining and refilling}

[All text on this page is optional]

- Effervescent action helps the chlorine dissolve faster
- Takes the start-up load off the {53735-10 or 53735-16 Brand Name} so it lasts longer
- Use when draining and re-filling the {spa} {hot tub} – up to 500 gallons
- Use for easy {spa} {hot tub} start-up

[Copy on packaging for spa products – All text is optional]

2 Prefilled Cartridges Plus {Brand} Test Strips {and} {&} {53735-12 Brand Name} Shock

4 Prefilled Cartridges / 1 Pool Frog Mineral Reservoir 3 Bromine Cartridges

Proprietary blend of minerals {plus bromine} {with {53735-14 Brand Name} Technology} {for sanitizing hot tubs}

Adjust{s}{able} {for} up to 600 gallons

Replace bromine cartridge when system tilts in the water ({on average} {about every} {approximately every} {typically in} 2-4 weeks)

Replace Pool Frog Mineral Reservoir every four months

Reusable cartridge holder allows for easy cartridge replacement

EXPERIENCE THE DIFFERENCE

Our exclusive water care system works in a whole different way. The combination of {Brand} minerals and a low level of bromine allows you to enjoy these 4 advantages.

THE ALTERNATIVE WAY TO SANITIZE

A fresh approach to clean, clear water using mineral technology that uniquely offers these 4 advantages

THE WATER SANITIZING SOLUTION

Our water care system works differently to eliminate bacteria so you enjoy 4 advantages

AN ALTERNATIVE APPROACH TO WATER CARE

With {Brand} minerals and a low level of bromine, you'll experience fresh water with these 4 advantages

{Brand} introduces an exclusive water care system that delivers 4 primary advantages.

Lower your {chlorine} {or} {bromine} use up to 50% with minerals

Unlike chlorine, bromine slowly dissolves in hot water so it's easier to {manage} {regulate}. Plus far less odors

Bromine is less impacted by pH swings ensuring sanitizing effectiveness

Not just Clean, Serene.

{Replacement Cartridges} {Cartridge Kit} for {Brand} {Floating} [or] {In-Line} {Sanitizing} System

[Copy on insert card in several Pool Frog Mineral Reservoir products – all text is optional]

Connect with us for special offers and helpful tips. Provide your email to receive offers, helpful hints, product information and more. Sign up now and be entered in our monthly drawing to win a special {Brand} gift. These include {Brand} product, water bottles, towels, and more. Or register online at [company website]

Product Purchased: Flippin' FROG, Flippin' FROG XL, SPA FROG Floating System, Filter FROG, @ease Floating System, @ease In-Line System

Please Print: Name, email (please print carefully – you can opt out from receiving emails at any time., phone (home, mobile, work), Retailer (if known), city, state

[Copy on Pool Frog Mineral Reservoir website]

Using Pool Frog Mineral Reservoir, you can expect...

Consistent Sanitizing

Minerals are EPA registered as disinfectants so they are killing bacteria consistently for 6 months.

Up to 50% Less Chlorine Use

Because minerals are doing part of the sanitizing work, you can lower the chlorine level in the pool to 0.5 ppm. The combination of {Brand} minerals and 0.5 ppm chlorine is as effective as 1.0 ppm of chlorine alone.

Easier Weekly Visits and No Call Backs

No need to check Pool Frog Mineral Reservoir or add a booster. It continues to work as long as it's in the water. Pool Frog Mineral Reservoir keeps water crystal clear as it acts as an insurance policy against green or cloudy pools.

pH in the Proper Range

{Brand} minerals also absorb acids to guard against high pH which means less time testing and balancing the water. Another time saver!

50% Slower Build-up of CYA

With minerals reducing chlorine levels up to 50%, there is less cyanuric acid entering the pool in a season, therefore less build-up that can lead to chlorine inefficiency.

Reduction in Energy Use

Pool Frog Mineral Reservoir can even help cut down on energy bills by running the circulation system fewer hours per day. Between the minerals and low chlorine level, there is enough sanitizing potential that a 24 hour pump time is not needed. Add a timer to run during the day for enough hours to turn the water over 1.5 times per day. Your customers will thank you!

Improved Water Quality

With the conditioning power of minerals and less chlorine in the pool, the feel of the water is much softer. There is also far less odors and no bleaching of swimsuits. Because minerals reduce chlorine use, they actually protect the pool equipment and surfaces so the pool stays new looking longer.

Compatibility with Salt, Ozone or UV

Pool Frog Mineral Reservoir can work with any of these pools by providing an extra layer of protection against bacteria. Salt system users can turn their dial down and generate a lower chlorine level which helps prolong the life of their salt cell. Ozone and UV do not leave a residual in the pool so Pool Frog Mineral Reservoir provides a steady bacteria fighting presence.

Lower TDS levels

Minerals and 0.5 ppm of free chlorine make up a complete sanitizing system. The only other thing you need is a regular pool shock and some balancing chemicals. By not requiring borates, enzymes, clarifiers and other chemicals, you can greatly reduce TDS build up in the water.

6 Months of Protection

Pool Frog Mineral Reservoir mineral formula keeps working up to 6 months or one pool season whichever is shorter. During that time, no additional mineral doses are required which saves you money. Simply discard in the trash and replace with a new one.

[Additional Packaging Copy – All text on this page is optional]

{Pool Sanitizer} Replacement {for {Brand}}

Easy to Use - Lasts 6 months

Kills bacteria two ways {using} {with} minerals {plus} {and} {up to 50% less} chlorine

For pools up to x gallons only

The {Brand} System

The all-in-one pool sanitiz{ing}{er} {system}

Pool care that's care free

The total pool care package

The benefits of using our system:

Lower your chlorine use up to 50% with minerals

Cuts the chlorine habit by using up to 50% less

Up to 50% less chlorine for greater comfort

Precision performance – just set it and forget it

Count on {Brand} to perform continuously

Ends the chore of daily pool care

With {up to 50%} less chlorine* {it's} {Brand Name is} easier on skin and helps protect pool surfaces

Water feels soft and doesn't fade suits or damage surfaces

With {up to 50%} less chlorine* {it's} {Brand Name is} easier on all surfaces (including your suits and skin)

90 day algae protection guaranteed with {53735-9 Brand Name}

Stop algae before it starts – guaranteed for 90 days with {53735-9 Brand Name}

Your 90 day guarantee against green with {53735-9 Brand Name}

Dispenses in 90 minutes. Prevents algae for 90 days – guaranteed

{Lifetime} {10 year} warranty on {Brand}

Pool Sanitizer Replacement

Step 1: {This is the} minerals{!} Pool Frog Mineral Reservoir (included in this box). Lasts 6 months or 1 pool season (whichever is shorter)

Step {2} {3}: {This is the} chlorine{!} {53735-2 Brand Name} (sold separately). Replace every x-x weeks throughout your swim season

Make it even easier to open and close your pool!

Step {2} {3}: {53735-9 Brand Name} ({kit} sold separately) {Algae Protection}

Use once in the spring and again in the fall for optimal performance plus an algae protection guarantee!

Visit kingtechnology.com frogproducts.com or call 800-222-0169

Fits the following systems {list of brands}

Size {25K} {40K} - Up to {25K} {40K} gallons

Prefilled pacs eliminate stinky chlorine fumes

Swimsuit friendly because {chlorine} and {bromine} is 50% {lower} {less}*

Keeps swimsuits bright and noses happy

Pool care with a lower degree of difficulty

Makes cleaning your pool as easy as 1, 2, 3

Easy as 1-2-3-Ahh{...}{!}

{The Brand System -} Easy way to cleaner, clearer water

Adding minerals allows you to use less chlorine

[All text on this page is optional]

No more touching chlorine
No more measuring chlorine
No more pouring chlorine

The quick and easy way to sanitize!
Don't forget our special test strips for your {Brand} System
Tending to your pool has never been easier
The easy way to tend your pool
1-2-3 Hassle-Free

{Complete} {Routine} {pool} {water} care made easy
3-Step {pool care} {sanitizing system}
Start each season with new minerals
Must replace every 6 months {for Fresh Mineral Water[∞]} {wout minerals, it's not fresh!}
Download {the} free {Brand} {Water Care} App
Tap into the App – Watercare guide for {spas} {hot tubs} and pools

- Easy water testing advice Water care at your fingertips
- Helpful reminders and more

Expert advice, reminders & moreple water care at your fingertips
Our free app makes it easy

Contact your local FROG dealer
Contact Customer Service at 800-222-0169

New Look – Same great product
Fresh Mineral Water[∞] you love with a fresh new look
A confident clean with less chlorine – minerals make the difference

More Fun. Less Mess. Make water care easier with {Brand}
Fun Simplified. Ask about FROG Water Care Systems
Hop in for Fresh Mineral Water[∞]

Open your eyes to a fresher clean
Discover {a fresher approach to water care} {the fresh alternative to salt} {the difference {of} Fresh Mineral Water[∞]}

Make your pool care routine easier

Keep it clean. Keep it soft. Remember to replace your {minerals} {Brand}
Time to make the swap? Replace your {minerals} {Brand} every 6 months
Expert advice, reminders and more. Simple water care at your fingertips.

Put your mind and body at ease
Not just clean, Serene
Rediscover the simple joy of owning a hot tub

Powered by Fresh Mineral Water[∞]
Easier to manage with prefilled cartridges
Reduces shocking to only once a month

Same {great product} {innovative technology} – {new name} new look
Enjoy Spa Ease with {Brand}
Spa Ease: what you experience with {Brand} products

[All text on this page is optional]

Create Spa Ease in your {spa} {hot tub}
Sanitizing made easy – that’s Spa Ease
Spa Ease – as easy as 1, 2, Ahh

Prepare for pool envy
Water so clear and clean the neighbors will be {jealous} {envious}
A clean that sparkles...now that’s a pool to be proud of

Frog. Creating pool pride since 1997.
Paradise awaits. Float on.
Less work. More play.

STOP: Do not give one more thought to pool care
Getting to your happy place just got a lot easier.
You’re minutes away from your happy place.

My two favorite words: KER SPLASH!
C’mon in! The water’s ALWAYS {fine} {clear} {awesome} {ready}!
Clearer, cleaner, softer...only the pool boy knows for sure

The only thing you have to maintain is your suntan.
Get ready to sparkle!

Relax and enjoy. That’s basically all that you have to do.

Pool Rules: Laugh, Smile, Splash, Enjoy
Today’s forecast: sunny with clear water and loads of epic fun

ATTENTION: Sparkling Fresh Mineral Water[∞] may result in the following

- Oohs and ahhs from friends and family
- Lazy afternoons of floating
- Other pool owners asking for advice
- More games of Marco Polo
- Constantly wet children
- A more enjoyable life

Goodbye constant monitoring. Hello to being at ease.
Pure relaxation is within reach.

Say hello to easy-water-care.
Say hello to the “aahs.”
Say hello to simple.

Welcome to easy
Innovation meets simplicity
Ready. Set. Relax.

Relax. We’re here to help.
The only thing to measure: the number of “aahs.”
From ah-ha to aaahhh

[All text on this page is optional]

Congrats, you're seconds away from pure relaxation.
Woo-hoo, no daily chores. (Because you're already opening a hot-tub sanitizer package, no need to identify that's it's hot tub water cleaning chore.)

Welcome "aahs."
Welcome to the FROG-revolution
Innovation awaits...

Easy does it
Relax, you got this.
Open to innovation

Say hello to your hot tub butler
Relaxation starts here.
EXHALE

Be at ease. Be crystal clear.
Soak in simplicity

Chore be gone
Ease. Soak it in.
Relaxation: Dial in.

Drop n' Go Floater
It's Flippin' Foolproof

Secure, prefilled cartridges – never touch chemicals again
Tether included – secures to side of pool or ladder
Floats in pool – flips when empty. Simply replace chlorine cartridge

With less chlorine it's easier on skin, hair and {swim}suits – and no smelly odors
Flips over when chlorine needs replacing

Minerals + Chlorine – kills bacteria two ways
Lasts all season (6 months)
Here's the secret sauce behind all FROG Products. Fresh Mineral Water[∞] spells the end of itchy, scratchy, over-chlorinated water. It's pure bliss.

Easy installation into most skimmer baskets – no assembly
Set it and forget it convenient reminder dial for 6 months
Experience it for yourself

Easy to spot when to replace cartridge
Up to 4 months worth of "ahhhs
{Everything you need} {Complete water care} for up to 4 months
{Contains} Up to a 4-month supply included {inside}

{Package} {Bundle} {Kit} {Set} {contains} {includes}
'1 Pool Frog Mineral Reservoir (shown left)
'3 {53735-14 Brand Name}
'1 {53735-12 Brand Name}
'1 {Brand Name} Test Strips
'3 {Brand Name} Non-Chlorine Shock {packets} {pouches}

[Pool Frog Mineral Reservoir – Family of Products]

FROG HAS A... PRODUCT FOR EVERY POOL



POOL FROG®
for pools up to 40,000 gallons

POOL FROG®
for pools up to 25,000 gallons

POOL FROG® XL PRO
for pools up to 40,000 gallons



FROG BAM® 90-Day
Algae Protection

FROG® Test Strips
for pools and spas



Flippin' FROG® for pools 2,000-5,000 gallons

Flippin' FROG® XL™ for pools 5,000-10,000 gallons

PRODUCT FOR EVERY SPA



SPA FROG® Floating Mineral System
Floats in Any Spa



SPA FROG® In-Line Mineral System
Built In by the Spa Manufacturer for New Spas



FROG Jump Start®
shocks a freshly filled spa with an effervescent action.



FILTER FROG®
Fits in the Filter Core

U.S. Patent Numbers: D460,325; D460,664; 6,217,892; 6,383,507; 6,500,334; 6,551,609; 6,652,871; 7,014,780 and other U.S. and foreign patents pending.

Manufactured in the U.S.A. by **King Technology, Inc.**
530 11th Ave S, Hopkins, MN 55343
800-222-0169 • www.KingTechnology.com
20-44-2261 E032411553081343R5N



[Phone App Icon for Pool Frog Mineral Reservoir Family of Products]



{QR Code}