

I M P R O V E D

AIREACTOR DDG

(Contains the Dual Quaternary)

Active Ingredients:

n Alkyl (60% C ₁₂ , 30% C ₁₆ , 5% C ₁₂ , 5% C ₁₈) dimethyl benzyl ammonium chloride	2.50%
n Alkyl (68% C ₁₂ , 32% C ₁₄) dimethyl ethylbenzyl ammonium chloride	2.50%
Ethanol	1.25%
Sodium Nitrite	0.30%
Sodium Carbonate	0.25%
Tetrasodium ethylenediaminetetraacetate	0.20%
Essential Oils	1.00%
Isopropanol	9.90%
	17.90%

Inert Ingredients	82.10%
TOTAL	100.00%

DANGER:
KEEP OUT OF REACH OF CHILDREN.

See side panels for additional precautions.

DEODORIZER * DETERGENT * GERMICIDE
FOR THE
PEAK OF DISINFECTION

If surfaces to be treated have heavy soil deposits, these should be removed before the application of AIREACTOR DDG. May be used in all types of manufacturing and processing plants, washrooms, schools, hotels, buses, railroad cars, refrigerator trucks and vans.

DANGER: Keep out of reach of children. Corrosive. Causes eye damage and skin irritation. Do not get in eyes, on skin or on clothing. Wear goggles or face shield when handling. Harmful or fatal if swallowed. Avoid contamination of food.

FIRST AID: In case of contact, immediately flush eyes or skin with plenty of water for at least 15 minutes. For eyes, call a physician. Remove and wash contaminated clothing before reuse.

If swallowed, drink promptly a large quantity of milk, egg whites, or atin solution or, if these are not available, drink large quantities of water. Avoid alcohol. Call a physician immediately.

AIREACTOR CORPORATION

271 Madison Avenue
New York, N. Y. 10016

DIRECTIONS FOR USE:

For general cleaning, disinfecting and deodorizing, prepare a solution by diluting two ounces of AIREACTOR DDG for each gallon of water. Wet floor thoroughly with a CLEAN mop dipped into the solution.

Walls, windows, stoves, sinks, chairs, tables should be wiped with a clean cloth soaked in the DDG solution.

Rinse all food contact surfaces with potable water before reuse.

For highly resistant bacteria such as Pseudomonas aeruginosa or for extra cleaning action, use three ounces of AIREACTOR DDG to each gallon of water and follow the above procedure. This product is designed to clean, disinfect and deodorize — all in one operation. When container is empty, rinse thoroughly and discard.

ONE U.S. GALLON

E.P.A. Registration Number . . . 6095-3

Made in the U.S.A.

EXCLUSIVE EQUIPMENT
Developed For The Application of Aireactor

AIREACTOR CORPORATION
Products & Services

The **GYROSTATIC EVAPORATOR**

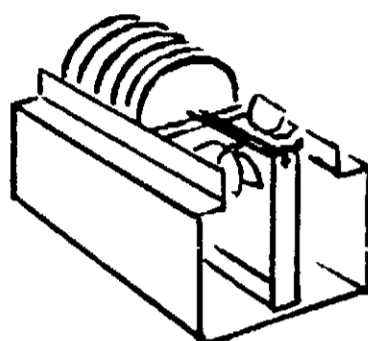

AIREACTOR® DDG (deodorizer, detergent germicide) contains a dirt removing detergent, a new patented dual quaternary ammonium chloride germicide and AIREACTOR'S unique deodorizer so all 3 functions are accomplished in one simple operation.



The **ODORMASTER®**

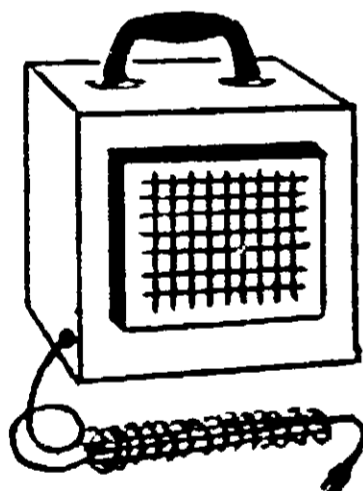

AIREACTOR® SKY BLUE ATMOSPHERIC CONDITIONER a semi-concentrate formulated with Aireactor Space Deodorizer and specific elements to make it hang in suspension when sprayed for extra-effective outdoor applications.



The **TRANSVAPORIZER**

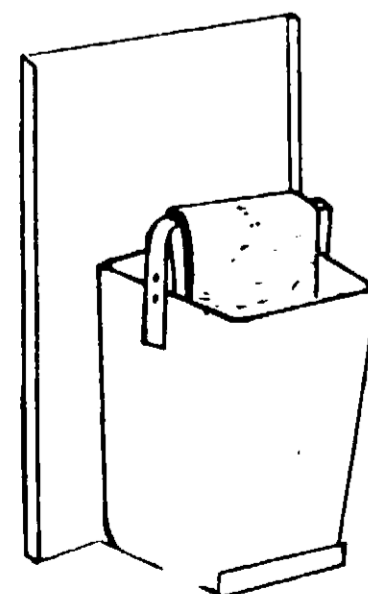

Scientific



SEP - 6 1972

Conceived and manufactured by the

Executive Offices
271 Madison Avenue, New York 16, N.Y.

Telephones:
(212) LE 2-1595 and 1377

Manufacturing and Warehouse:
Newark, New Jersey

ACCEPTED
SEP 1 1972
UNDER THE FEDERAL INSECTICIDE
FUNGICIDE AND RODENTICIDE ACT
FOR ECONOMIC POISON REGISTERED
ED UNDER NO. 6256-3 SUBJECT
TO ATTACHED COMMENTS.

Distributors in all major cities of the continental United States, Canada, Puerto Rico, Virgin Islands, United Kingdom, Europe, Thailand, Singapore, Australia, New Zealand, South Africa, Phillipines, Nigeria etc.

EXCLUSIVE EQUIPMENT

Developed For The Application of Aireactor

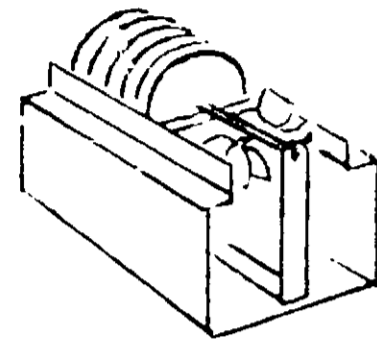

The GYROSTATIC EVAPORATOR

U.S. PATENT NO. 2879870

A revolutionary unit for evaporating AIREACTOR vapors in small areas.

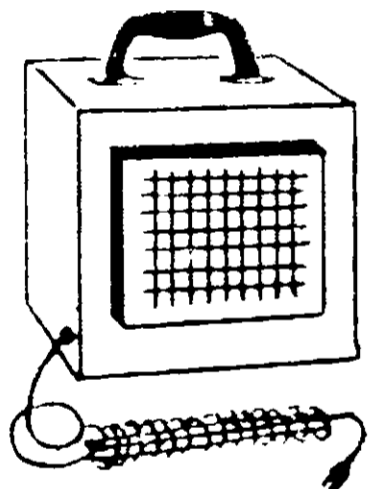

The ODORMASTER

A unique portable trouble-free unit with a fan to evaporate AIREACTOR vapors in small areas such as hospital rooms, board of directors' rooms, etc.

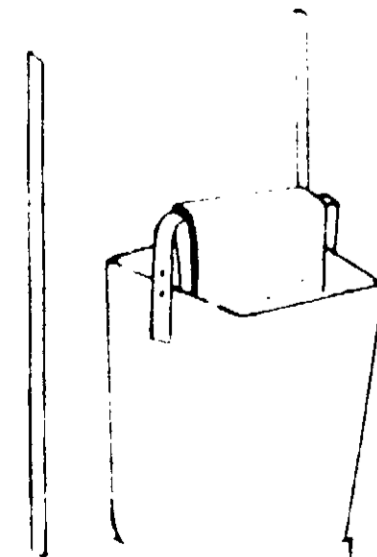

The TRANSVAPORIZER

An original evaporator with an extensive zone of influence for diffusing vapors.

AIREACTOR CORPORATION Products & Services



AIREACTOR® DDG (deodorizer, detergent germicide) contains a dirt removing detergent, a new patented dual quaternary ammonium chloride germicide and AIREACTOR'S unique deodorizer so all 3 functions are accomplished in one simple operation.



AIREACTOR® XX specifically for counteraction of smoke odors after fires. Embodies Aireactor's extraordinary odor counteracting qualities plus special adaptation for application to smoke. Not toxic, will not burn or stain. Listed with Underwriters Laboratories.



AIREACTOR® SKY BLUE ATMOSPHERIC CONDITIONER a semi-concentrate formulated with Aireactor Space Deodorizer and specific elements to make it hang in suspension when sprayed for extra-effective outdoor applications.



AIREACTOR® MIST an exclusive aerosol which dissipates odors by actually counteracting them in vapor phase. Will also eliminate the visual smoke. Non-toxic, will not burn.

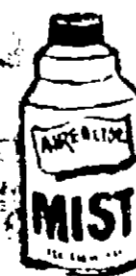

AIREACTOR ENGINEERS across the country supervise installations and put systems into successful operation.

Scientific



SEP - 6 1972

Conceived and manufactured by the

Executive Offices
271 Madison Avenue, New York 16, N. Y.

Telephones:
(212) LE 2-1595 and 1377

Manufacturing and Warehouse:
Newark, New Jersey

Distributors in all major cities of the continental United States, Canada, Puerto Rico, Virgin Islands, United Kingdom, Europe, Thailand, Singapore, Australia, New Zealand, South Africa, Phillipines, Nigeria etc.

EXCLUSIVE EQUIPMENT
Developed For The Application of Aireactor

AIREACTOR CORPORATION
Products & Services

U.S. PATENT NO. 2678810

A revolutionary principle for evaporating AIREACTOR into air conditioning systems, etc.

A unique portable trouble-free unit with a fan to evaporate AIREACTOR vapors in small areas such as hospital rooms, board of directors' rooms, etc.

An original evaporator with an extensive zone of influence for diffusing vapors.



AIREACTOR®SPACE DEODORIZER is not a cosmetic but a deodorizer scientifically formulated from elements of plant life that cancel odors in vapor phase much as green foliage does in nature.

AIREACTOR® is a unique deodorizer, deodorizing, disinfecting, and a cleaning detergent. It is a natural, non-toxic, and non-staining deodorizer. It is a unique deodorizer for all types of odors, including smoke, and is suitable for use in all types of buildings.



AIREACTOR® XX specifically for counteraction of smoke odors after fires. Embodies Aireactor's extraordinary odor counteracting qualities plus special adaptation for application to smoke. Not toxic, will not burn or stain. Listed with Underwriters Laboratories.



AIREACTOR® AIR PURIFIER - ATMOSPHERIC CONDITIONER - Formulated with Aireactor Space Deodorizer and other elements to make it have maximum effect for counteracting outdoor air pollution.



AIREACTOR® MIST an exclusive aerosol which dissipates odors by actually counteracting them in vapor phase. Will also eliminate the visual smoke. Non-toxic, will not burn.



AIREACTOR ENGINEERS across the country supervise installations and put systems into successful operation

Scientific

SEP - 6 1972

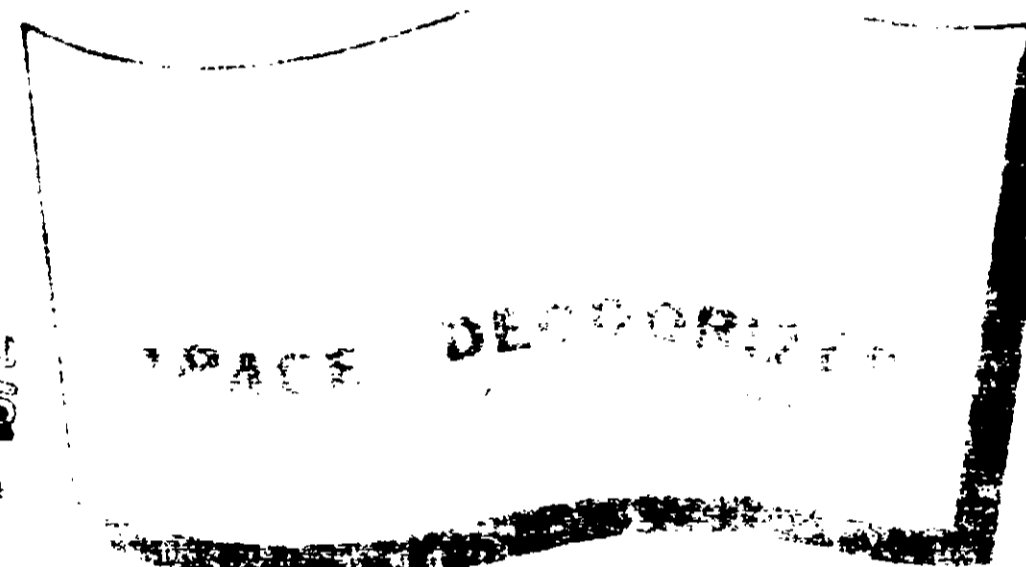

Contains 16 oz. net wt. per can

Executive Offices
271 Madison Avenue, New York 17, N. Y.

Telephones:
(212) LE 2 1595 and 1377

Manufacturing and Warehouse
Newark, New Jersey

Distributors in all major cities of the continental United States, Canada, Puerto Rico, Virgin Islands, and other foreign countries. For a complete list of distributors, write to Aireactor Corporation, 271 Madison Avenue, New York 17, N. Y.

INDUSTRIAL ODORS

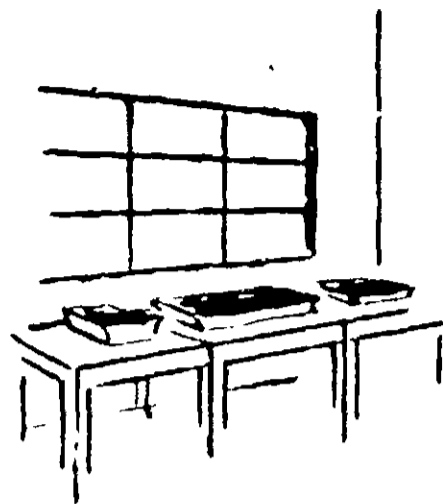

Rendering and fertilizer plants, fisheries, organic chemicals, dehydrating, pharmaceuticals, plastic plants, tallow, etc.

Create employment problems. AIREACTOR clears them all away increasing employment.

SMOKE ODORS

Millions of dollars saved every year by the application of AIREACTOR XX.

Only a few years ago, it was discovered the most persistent SMOKE odors could be neutralized.

The application of AIREACTOR XX by trained personnel permits re-occupancy in a matter of hours.

All trace of the clinging SMOKE ODOR IS REMOVED. Approved and used by major insurance companies and adjusters. Can be applied in all types of buildings, ships, trains, kitchen grease fires, automobile fires, chemical plants, cleaning establishments, etc.

AIREACTOR XX is not toxic, will not stain, corrode or burn. Listed with Underwriters Laboratories.



HOSPITALS, NURSING HOMES

Mental institutions, cancer, colostomy, orthopedic wards, laboratories, autopsy rooms, the morgue, kitchens, dining rooms, laundry, garbage in-continnency, medicines, etc.

All kept odor-free with Aireactor odor counteractants.

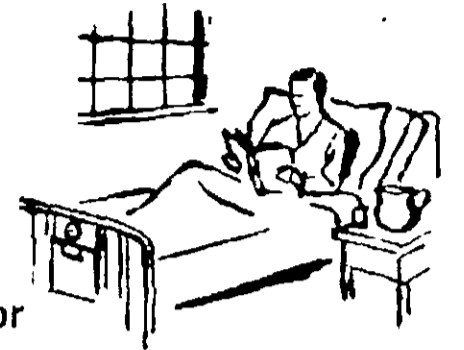

AIR POLLUTION

Industrial plants, stack treatment to neutralize effluent from all types of odorous processing including rubber, paint, glue, oil, refineries, smelters, etc.

Exuding odorous vapors create public relations difficulties, reduction of property values, aggravation for the entire community. AIREACTOR solves the problem.

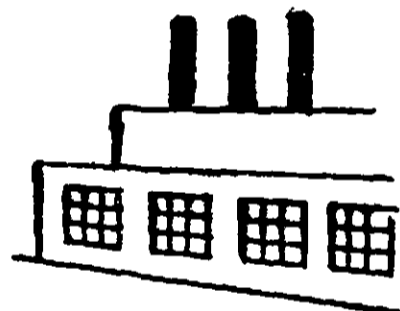

TRANSPORTATION

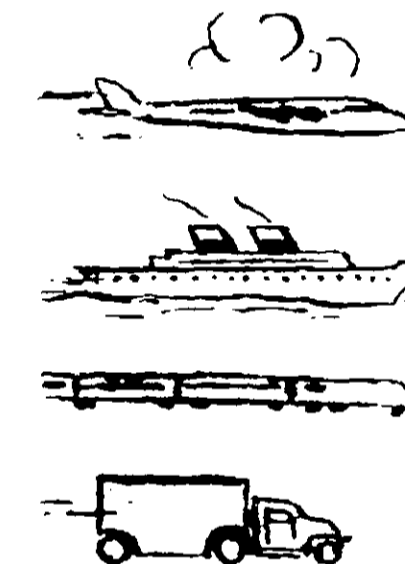

Aireactor prevents contamination of odors from one cargo to another, such as hides, petroleum, DDT, animals, fish meal fertilizer, etc. on ships, trucks, freight cars, enabling them to make quick return and substantial savings, also for warehouses, airplanes, railroads.

OFFICES, DEPARTMENT STORES, BANKS

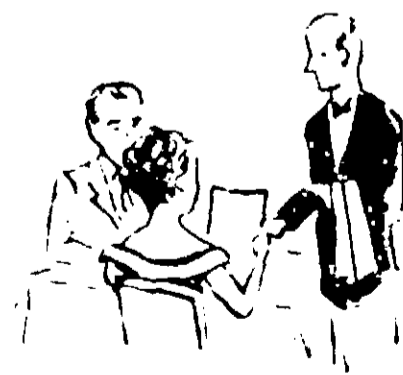

Restaurant, beauty parlors, luggage stores, dance studios, basements, dress houses, millinery. All walls, floors, give off odors which with occupancy, paper, ink, smoking, etc., create a depressive atmosphere. AIREACTOR makes it fresh, adds that "lift".

SANITARY MAINTENANCE

National health standards made scientific odor control a must for all sanitary maintenance. AIREACTOR DDG which will disinfect probably as well as any germicide will also clean more thoroughly and in addition will neutralize any odor, thus leaving the premises fresh, clear and odor-free.

All this in only one simple and economical operation.

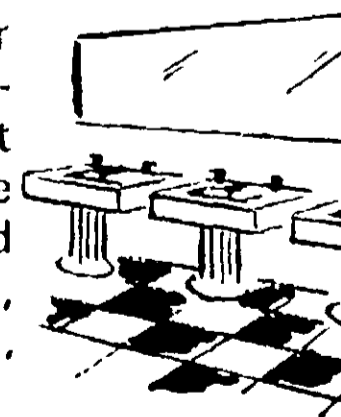

SEWAGE DISPOSAL

Many modern sewage plants, due to the city's growth, are now in their center and the majority are odorous. Installations with Aireactor neutralize these odors completely as well as those of garbage and incinerator plants, so no one is aware of their existence.

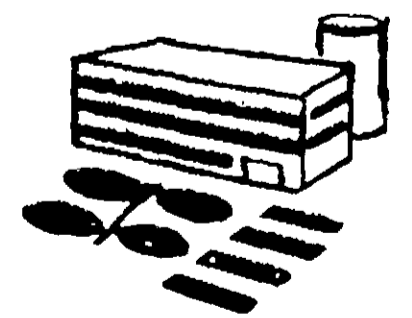

Aireactor

DDG DEODORIZER
DETERGENT
GERMICIDE

Contains the Dual Quaternary

Now—the greatest labor saver

YOU CAN DO IT ALL IN 1

AS A DEODORIZER — The deodorizer in Aireactor DDG actually changes the odor molecules in the atmosphere; so that unpleasant odors are completely eliminated, leaving the premises with a pleasant garden freshness. The Aireactor formula is a tested, proven and accepted method of odor control.

AS A GERMICIDE — Aireactor DDG is one of the most powerful and efficient dual quaternary ammonium germicides, meeting the highest standards of hospitals and institutions, to help control the transmission, via environmental surfaces, of many infectious organisms. For use in medical centers, schools, industrial plants, restaurants, auditoria, etc.

AS A DETERGENT — Aireactor DDG is an active non-ionic synthetic detergent with unusually effective dirt removing action on hard or delicate surfaces.

**An amazing new ALL-IN-ONE concentrate
that does MORE work for LESS money**

This powerful multi-action concentrate requires only three ounces per gallon of water to do an effective job. It may be used on practically all types of surfaces; painted, varnished, lacquered, porcelain, tile, glass, steel, chrome, wood, rubber, cork, linoleum, vinyl, asphalt tile, marble, textiles.

**AIREACTOR
ODOR COUNTERACTOR**

Aireactor

DDG DEODORIZER
DETERGENT
GERMICIDE

Contains the Dual Quaternary

Now—the greatest labor saver

YOU CAN DO IT ALL IN 1

AS A DEODORIZER — The deodorizer in Aireactor DDG actually changes the odor molecules in the atmosphere; so that unpleasant odors are completely eliminated, leaving the premises with a pleasant garden freshness. The Aireactor formula is a tested, proven and accepted method of odor control.

AS A GERMICIDE — Aireactor DDG is one of the most powerful and efficient dual quaternary ammonium germicides, meeting the highest standards of hospitals and institutions, to help control the transmission, via environmental surfaces, of many infectious organisms. For use in medical centers, schools, industrial plants, restaurants, auditoria, etc.

AS A DETERGENT — Aireactor DDG is an active non-ionic synthetic detergent with unusually effective dirt removing action on hard or delicate surfaces.

**An amazing new ALL-IN-ONE concentrate
that does MORE work for LESS money**

This powerful multi action concentrate requires only three ounces per gallon of water to do an effective job. It may be used on practically all types of surfaces; painted, varnished, lacquered, porcelain, tile, glass, steel, chrome, wood, rubber, cork, linoleum, vinyl, asphalt, tile, marble, textiles.

**AIREACTOR
ODOR COUNTERACTOR**