



UNITED STATES ENVIRONMENTAL PROTECTION AGENCY
WASHINGTON, DC 20460

OFFICE OF CHEMICAL SAFETY
AND POLLUTION PREVENTION

November 19, 2020

Joe Conti
Senior Director, Regulatory, R&D
The Hartz Mountain Corporation
400 Plaza Drive
Secaucus, NJ 07094

Subject: Label Amendment – Add CRP single blister language to label
Product Name: Hartz Reference #130
EPA Registration Number: 2596-165
Application Date: May 16, 2019
Decision Number: 551706

Dear Mr. Conti:

The amended label referred to above, submitted in connection with registration under the Federal Insecticide, Fungicide and Rodenticide Act, as amended, is acceptable. This approval does not affect any conditions that were previously imposed on this registration. You continue to be subject to existing conditions on your registration and any deadlines connected with them.

A stamped copy of your labeling is enclosed for your records. This labeling supersedes all previously accepted labeling. You must submit one copy of the final printed labeling before you release the product for shipment with the new labeling. In accordance with 40 CFR 152.130(c), you may distribute or sell this product under the previously approved labeling for 18 months from the date of this letter. After 18 months, you may only distribute or sell this product if it bears this new revised labeling or subsequently approved labeling. "To distribute or sell" is defined under FIFRA section 2(gg) and its implementing regulation at 40 CFR 152.3.

Should you wish to add/retain a reference to the company's website on your label, then please be aware that the website becomes labeling under the Federal Insecticide Fungicide and Rodenticide Act and is subject to review by the Agency. If the website is false or misleading, the product would be misbranded and unlawful to sell or distribute under FIFRA section 12(a)(1)(E). 40 CFR 156.10(a)(5) list examples of statements EPA may consider false or misleading. In addition, regardless of whether a website is referenced on your product's label, claims made on the website may not substantially differ from those claims approved through the registration process. Therefore, should the Agency find or if it is brought to our attention that a website contains false or misleading statements or claims substantially differing from the EPA approved registration, the website will be referred to the EPA's Office of Enforcement and Compliance.

Your release for shipment of the product constitutes acceptance of these conditions. If these conditions are not complied with, the registration will be subject to cancellation in accordance

Page 2 of 2
EPA Reg. No. 2596-165
Decision No. 551706

with FIFRA section 6. If you have any questions, please contact Vanessa Emerson by phone at 703-347-0360, or via email at emerson.vanessa@epa.gov.

Sincerely,

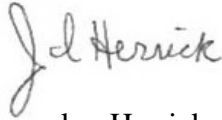
A handwritten signature in cursive script that reads "J. Herrick".

Jacquelyn Herrick, Product Manager 03
Invertebrate & Vertebrate Branch 1
Registration Division (7505P)
Office of Pesticide Programs

Enclosure

Hartz® Reference # 130

{Note to Reviewer: Text inside [] denotes optional language; text inside { } denotes location of text on packaging, notes to reviewer, and text that will not be on final label; text inside () appears on the label.}

{Primary Brand Name not to be used on any product labels. The word Dog will be included in all Alternate Brand Names and be at least 40% of the size of the largest letter in the Alternate Brand Name.}

{Alternate Brand Names listed at end of document}

{FRONT PANEL}

{Included on the front panel is a large, clear picture of a dog in the weight range for the product.}

{Each of the brands will be packaged in the weight classes designated below}

{A claim on the front panel will indicate which pests this product treats.}

- [Weighing 5 - 22 lbs., 8 weeks of age and older]
- [Weighing 23 - 44 lbs., 8 weeks of age and older]
- [Weighing 45 - 88 lbs., 8 weeks of age and older]
- [Weighing 89 - 132 lbs., 8 weeks of age and older]

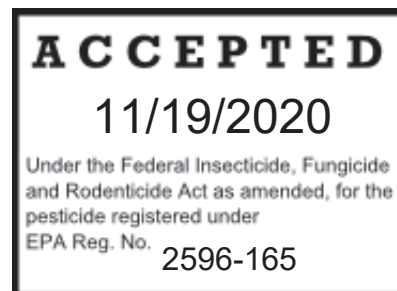

ACTIVE INGREDIENTS:

Fipronil.....	9.80%
[S]-Methoprene.....	8.80%
OTHER INGREDIENTS	81.40%
TOTAL	100.00%

KEEP OUT OF REACH OF CHILDREN

CAUTION: See back panel for First Aid and additional precautionary statements.

NET CONTENTS:

{For 1 tube, and each weight class noted is for separate tube text.}

{The following table will be placed prominently in a box on the front panel.}

ONLY for use on Dogs and Puppies 8 Weeks and Older Weighing:	Net Contents
5 - 22 lbs	0.023 fl oz [0.67 mL]
23 - 44 lbs	0.045 fl oz [1.34 mL]
45 - 88 lbs	0.091 fl oz [2.68 mL]
89 - 132 lbs	0.136 fl oz [4.02 mL]

{For 2 pack – Only CRP configurations that were tested and approved, using 2cc or 7.8cc tubes, will be used for this product.}

{The following table will be placed prominently in a box on the front panel.}

ONLY for use on Dogs and Puppies 8 weeks and older Weighing:	Net Contents:
5 - 22 lbs	0.046 fl oz [1.34 mL], Contains 2 [-] [tubes, each] 0.023 fl oz [0.67 mL][tubes]
23 - 44 lbs	0.09 fl oz [2.68 mL], Contains 2 [-] [tubes, each] 0.045 fl oz [1.34 mL][tubes]
45 - 88 lbs	0.182 fl oz [5.36 mL], Contains 2 [-] [tubes, each] 0.091 fl oz [2.68 mL][tubes]
89 – 132 lbs	0.272 fl oz [8.04 mL], Contains 2 [-] [tubes, each] 0.136 fl oz [4.02 mL] [tubes]

{For 3 pack – Only CRP configurations that were tested and approved, using 2cc or 7.8cc tubes, will be used for this product.}

{The following table will be placed prominently in a box on the front panel.}

ONLY for use on Dogs and Puppies 8 weeks and older Weighing:	Net Contents:
5 - 22 lbs	0.069 fl oz [2.01 mL], Contains 3 [-] [tubes, each] 0.023 fl oz [0.67 mL][tubes]
23 - 44 lbs	0.135 fl oz [4.02 mL], Contains 3 [-] [tubes, each] 0.045 fl oz [1.34 mL] [tubes]
45 - 88 lbs	0.273 fl oz [8.04 mL], Contains 3 [-] [tubes, each] 0.091 fl oz [2.68 mL][tubes]
89 – 132 lbs	0.408 fl oz [12.06 mL], Contains 3 [-] [tubes, each] 0.136 fl oz [4.02 mL][tubes]

{For 4 pack – Only CRP configurations that were tested and approved, using 2cc or 7.8cc tubes, will be used for this product.}

{The following table will be placed prominently in a box on the front panel.}

ONLY for use on Dogs and Puppies 8 weeks and older Weighing:	Net Contents:
5 - 22 lbs	0.092 fl oz [2.68 mL], Contains 4 [-] [tubes, each] 0.023 fl oz [0.67 mL] [tubes]
23 - 44 lbs	0.180 fl oz [5.36 mL], Contains 4 [-] [tubes, each] 0.045 fl oz [1.34 mL] [tubes]
45 - 88 lbs	0.364 fl oz [10.72 mL], Contains 4 [-] [tubes, each] 0.091 fl oz [2.68 mL] [tubes]
89 – 132 lbs	0.544 fl oz [16.08 mL], Contains 4 [-] [tubes, each] 0.136 fl oz [4.02 mL][tubes]

{For 6 pack – Only CRP configurations that were tested and approved, using 2cc or 7.8cc tubes, will be used for this product.}

{The following table will be placed prominently in a box on the front panel.}

ONLY for use on Dogs and Puppies 8 weeks and older Weighing:	Net Contents
5 - 22 lbs	0.138 fl oz [4.02 mL], Contains 6 [-] [tubes, each] 0.023 fl oz [0.67 mL][tubes]
23 - 44 lbs	0.27 fl oz [8.04 mL], Contains 6 [-] [tubes, each] 0.045 fl oz [1.34 mL] [tubes]
45 - 88 lbs	0.546 fl oz [16.08 mL], Contains 6 [-] [tubes, each] 0.091 fl oz [2.68 mL] [tubes]
89 – 132 lbs	0.816 fl oz [24.12 mL], Contains 6 [-] [tubes, each] 0.136 fl oz [4.02 mL][tubes]

{For 8 pack – Only CRP configurations that were tested and approved, using 2cc or 7.8cc tubes, will be used for this product.}

{The following table will be placed prominently in a box on the front panel.}

ONLY for use on Dogs and Puppies 8 weeks and older Weighing:	Net Contents
5 - 22 lbs	0.184 fl oz [5.36 mL], Contains 8 [-] [tubes, each] 0.023 fl oz [0.67 mL] [tubes]
23 - 44 lbs	0.36 fl oz [10.72 mL], Contains 8 [-] [tubes, each] 0.045 fl oz [1.34 mL] [tubes]
45 - 88 lbs	0.728 fl oz [21.44 mL], Contains 8 [-] [tubes, each] 0.091 fl oz [2.68 mL] [tubes]
89 – 132 lbs	1.088 fl oz [32.16 mL], Contains 8 [-] [tubes, each] 0.136 fl oz [4.02 mL][tubes]

[Hartz® and other trademarks are trademarks of The Hartz Mountain Corporation.]
 Made by The Hartz Mountain Corporation, 400 Plaza Drive, Secaucus, NJ 07094 [U.S.A.]

{Cat Warning: A cat prohibition icon in a box, 1.5 cm x 1.5cm, black image on a yellow background, will appear on the lower right hand corner of the front panel.}



DO NOT USE ON CATS

{BACK PANEL}

PRECAUTIONARY STATEMENTS

HAZARDS TO HUMANS.

CAUTION.

Harmful if swallowed or absorbed through the skin. Causes eye irritation. Avoid contact with skin, eyes or clothing. Wash hands thoroughly with soap and water after handling and before eating, drinking, chewing gum, using tobacco or using the toilet.

HAZARDS TO DOMESTIC ANIMALS.

For external use only. Do not use on puppies under 8 weeks of age and weighing less than *-{insert lowest weight of weight class}*. Sensitivities may occur after using **ANY** pesticide product for dogs. If signs of sensitivity occur bathe your dog with mild soap and rinse with large amounts of water. If signs continue, consult a veterinarian immediately. Dogs may experience some temporary irritation at the site of product application.

If your dog is exhibiting signs of, and/or is being treated for skin dermatitis, talk to your veterinarian before applying any topical flea and tick control product.

Consult a veterinarian before using this product on medicated, debilitated, or aged dogs. Call [1-800-275-1414] [1-XXX-XXX-XXXX] for 24-hour assistance.

PHYSICAL OR CHEMICAL HAZARDS

COMBUSTIBLE: Do not use or store near heat or open flame.

FIRST AID

IF SWALLOWED: Call a poison control center or doctor immediately for treatment advice. Have person sip a glass of water if able to swallow. Do not induce vomiting unless told to do so by a poison control center or doctor. Do not give anything by mouth to an unconscious person.

IF IN EYES: Hold eye open and rinse slowly and gently with water for 15-20 minutes. Remove contact lenses, if present, after the first 5 minutes, then continue rinsing eye. Call a poison control center or doctor for treatment advice.

IF ON SKIN OR CLOTHING: Take off contaminated clothing. Rinse skin immediately with plenty of water for 15 – 20 minutes. Call a poison control center or doctor for treatment advice.

HOT LINE NUMBER: Have the product container or label with you when calling a poison control center or doctor, or going for treatment. For additional information on this product (including health concerns, medical emergencies, or pesticide incidents), you may call [X-XXX-XXX-XXXX] [1-800-275-1414], twenty-four [24] hours per day, seven [7] days per week.

DIRECTIONS FOR USE

It is a violation of Federal law to use this product in a manner inconsistent with its labeling. Do not allow children to apply product.

READ ENTIRE LABEL BEFORE EACH USE

RESTRICTIONS

DO NOT USE ON DOGS OR PUPPIES LESS THAN 8 WEEKS OF AGE REGARDLESS OF WEIGHT

DO NOT USE ON DOGS OR PUPPIES WEIGHING LESS THAN [5][23][45][89] LBS.

DO NOT EXCEED LISTED DOSAGE AMOUNT FOR DOGS

DO NOT ALLOW YOUR DOG TO INGEST THIS PRODUCT

DO NOT USE ON RABBITS, CATS, KITTENS, OR OTHER ANIMALS

DO NOT REAPPLY {ALTERNATE BRAND NAME} FOR [ONE] [1] MONTH.

DO NOT APPLY MORE THAN ONE TUBE PER TREATMENT FOR ONE DOG, REGARDLESS OF WEIGHT

DO NOT BATHE YOUR DOG FOR 48 HOURS AFTER APPLICATION

{Note to Reviewer: CRP text and format will not change from that used in the testing.}

DIRECTIONS FOR USE {OPTION 1}

{ *Note to Reviewer: Option 1 tube has passed CRP as a tube and may be placed in tested CRP blister without additional testing.*

SAUE opening instructions apply to long-tip tube and will not change in text or format on the final printed label from that used in testing. See separate section on this document entitled CRP BLISTER ILLUSTRATIONS. Whenever this package is used, the term "applicator tube" or "tube" can be used, but whichever term is used, that term will be used consistently throughout the label.

Dog must be dry at the time of the application and remain dry for 48 hours after application. Dog must be standing at time of application. Avoid contact with treated area until dry.



1 Remove one applicator tube from the package and hold in an upright position pointed away from your face.



2 Twist dispensing tip clockwise about ½ turn while pushing down to break the tube's seal. Do not remove the dispensing tip.

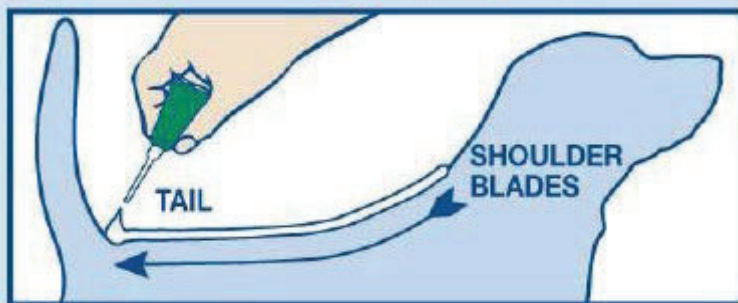

3 Position the dispensing tip on the dog's back between the shoulder blades. Use the dispensing tip of the tube to part the dog's hair so that the product will be applied at skin level. Begin squeezing out the contents of the tube to form a stripe as you move from the shoulder blades along the dog's back to the base of the tail.

4 Repeat every month.

DIRECTIONS FOR USE {OPTION 2}

{Directions for Cap Tube, through Step 5}:

{**Note to Reviewer:** *Option 2 tube is only for use in CRP blister. For CRP strip of 4 blister pack or 3 blister pack with applicator tubes and strip of 2 blister which is a strip of 3 blisters where the middle blister is empty. SAUE opening instructions are on the blister (CRP component) and will not change in text or format from that used in testing. See separate section on this document entitled CRP BLISTER ILLUSTRATIONS.. Whenever this package is used, the term “applicator tube” or “tube” can be used, but whichever term is used, that term will be used consistently throughout the label.*}

Dog must be dry at the time of the application and remain dry for 48 hours after application. Dog must be standing at time of application. Avoid contact with treated area until dry.



1. Remove one applicator tube from the package and hold in an upright position pointed away from your face.

2. Pull off cap. Turn the cap around and place on top of tube.

3. Simply press cap down to break the seal of the tube. Remove cap carefully.

4. Position the tip of the tube on the dog's back between the shoulder blades. Use the tip of the tube to part the dog's hair so that the product will be applied at skin level. Begin squeezing out the contents of the tube to form a stripe as you move from the shoulder blades along the dog's back to the base of the tail.

5 Repeat every month.

DIRECTIONS FOR USE {OPTION 3}

{Directions for Use with Screw-Top Cap}:

{Note to Reviewer: } Option 3 tube is a CRP tube and may be placed in a non-CRP blister but does not fit in the CRP blister tested. SAUE opening instructions apply to screw-top tube and will not change in text or format on the final printed label from that used in testing. Whenever this package is used, the term “tube” will be used consistently throughout the label.}

Dog must be dry at the time of the application and remain dry for 48 hours after application. Dog must be standing at time of application. Avoid contact with treated area until dry.

Remove inner tray from carton. Firmly grasp one tube and pull away from tray. Hold tube firmly in one hand. With the other hand, push down firmly on the cap and turn counter clockwise (to the left). Continue twisting cap until it comes off the tube. Turn the cap around and place opposite end of cap back on tube. Twist cap to break seal. Remove cap from tube.

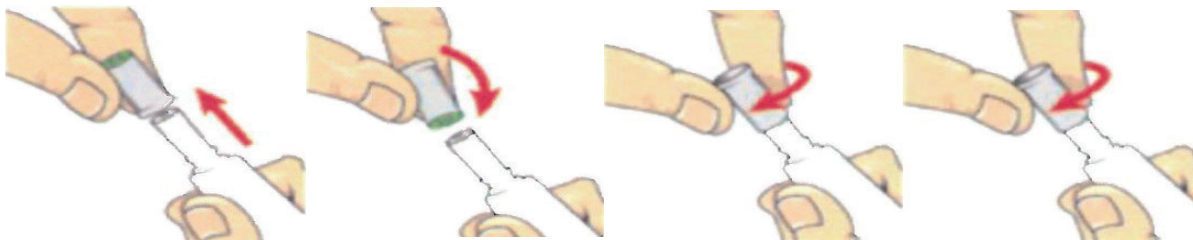

Do not bathe your dog for 48 hours after application.

Repeat [every][once a] month.

FREQUENCY OF APPLICATION

{Alternate Brand Name} kills ticks for one month. Re-apply every one month for tick control. [Do not re-apply for one month.]

{Alternate Brand Name} kills chewing lice for one month. Re-apply after one month for chewing lice control. [Do not reapply product for one month.]

{NOTE: The following paragraph enclosed in brackets is Optional Text for FREQUENCY OF APPLICATION section.}

Used monthly, {Alternate Brand Name} breaks the flea life cycle and controls tick and chewing lice infestations.] {Alternate Brand Name} [also] prevents development of all flea stages for one month.

STORAGE AND DISPOSAL

Do not contaminate water, food, or feed by storage or disposal. Do not use or store near heat or open flame.

PESTICIDE STORAGE: Keep this product in its tightly closed original container, when not in use. Store in a cool, dry (preferably locked) area that is inaccessible to children and animals.

PESTICIDE DISPOSAL: Wastes resulting from the use of this product may be disposed of on site or at an approved waste disposal facility.

CONTAINER HANDLING: Non-refillable container. Do not reuse or refill this container. *If empty:* Offer for recycling, if available or place in trash. *If partly filled:* Call your local solid waste agency for disposal instructions. Never place unused product down any indoor or outdoor drain.

SIDE EFFECTS *{Located in a box on product's back panel, immediately above the cat warning}*

Monitor your dog after application. Side effects may include signs of skin irritation such as redness, scratching, or other signs of discomfort. Gastrointestinal signs such as vomiting or diarrhea have also been reported. If these or other side effects occur, consult your veterinarian or call [x-xxx-xxx-xxxx] [1-800-275-1414].

{Cat Warning: A minimum 1.5 cm x 1.5cm cat prohibition icon and warning text will be in a box in the lower right hand corner of the back panel, in yellow with black images and text.}



DO NOT USE ON CATS. Keep cats away from treated dogs for 24 hours. If applied to or ingested by a cat, contact your veterinarian.

For more information, call our [flea and tick] experts at [1-XXX-XXX-XXXX] [1-800-275-1414] [weekdays, X am – X pm E.S.T.]

EPA Reg. No. 2596-165 EPA
Est. No. 2596-XX-X

[Hartz® and other trademarks are trademarks of The Hartz Mountain Corporation.]
Made by The Hartz Mountain Corporation, 400 Plaza Drive, Secaucus, NJ 07094 [U.S.A.]

{INDIVIDUAL TUBE TEXT}

{Text is for all individual applicator tubes and for applicator tubes found in the blister.}

{Alternate Brand Name}

[For use Only] [Only for use] on DOGS AND PUPPIES 8 WEEKS OR OLDER weighing
{insert from weight range list below} -

5 - 22 lbs – 0.023 fl oz [0.67 mL]

23 - 44 lbs – 0.045 fl oz [1.34 mL]

45 - 88 lbs – 0.091 fl oz [2.68 mL]

89 - 132 lbs – 0.136 fl oz [4.02 mL]

Contains Fipronil 9.8%, (S)-Methoprene 8.8%

Keep Out of Reach of Children

Caution

Read accompanying label before use

EPA Reg. No. 2596-165

EPA Est. No. 2596-XX-X

{Lot number to appear on tube crimp}

{A cat prohibition icon will appear on the tube and/or the immediate container for the tube itself.}



{CRP BLISTER ILLUSTRATIONS – SINGLE BLISTER}

*{Note to Reviewer: Only CRP configurations, including the corresponding tubes, that were tested and approved will be used for this product. Opening Instruction for **Single Blister**: A dashed line will be printed on the back of the blister package, accompanied by a scissor symbol indicating where to cut the blister package. The back of the blister package will be printed with an arrow with the words “PEEL BACK”, dictating where to peel in order to open the blister package.}*

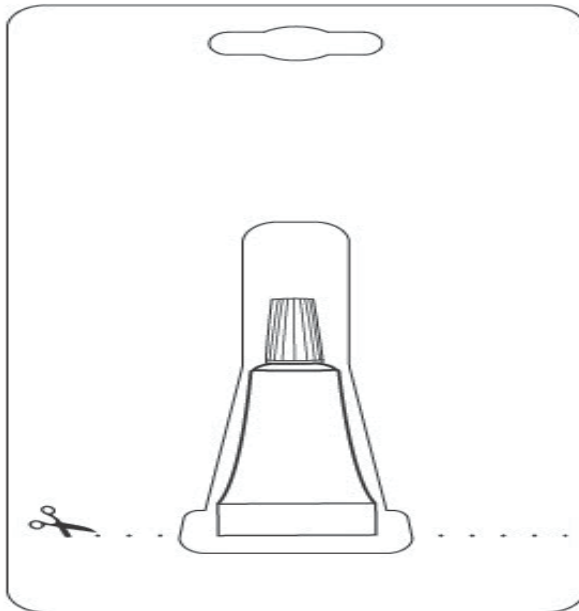

FORMING SIDE OF PACKAGE

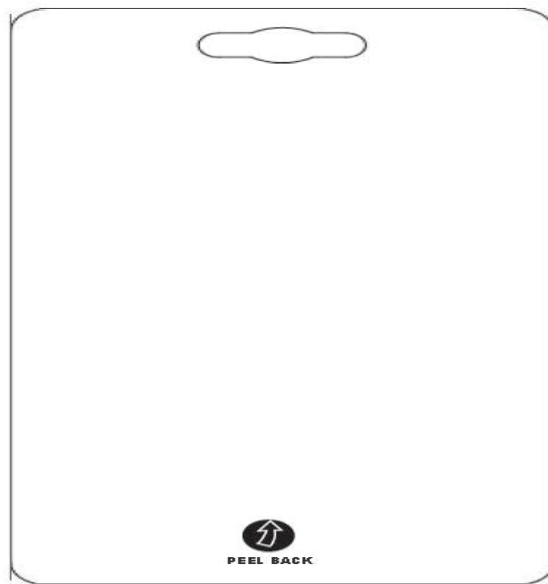

BACKING SIDE OF PACKAGE

{CRP BLISTER ILLUSTRATIONS 2, 3, 4, 6 AND 8 TUBE BLISTER PACK}

{Note to Reviewer: The appropriate size and fill volume will be correctly used on each applicable dog's weight category. Blister Text will appear on each blister that contains a tube.}

{The following SAUE graphic demonstrating dotted line with scissors icon and arrow to peel back, will appear on the 2, 3, 4, 6 and 8 tube CRP blister pack, with blister pack indicating the following package configurations: 2 tubes single blister, 3 tubes single blister, 4 tubes single blister, 6 tubes packaged as 2 blisters each containing 3 tubes, 8 tubes packaged as 2 blisters each containing 4 tubes.}

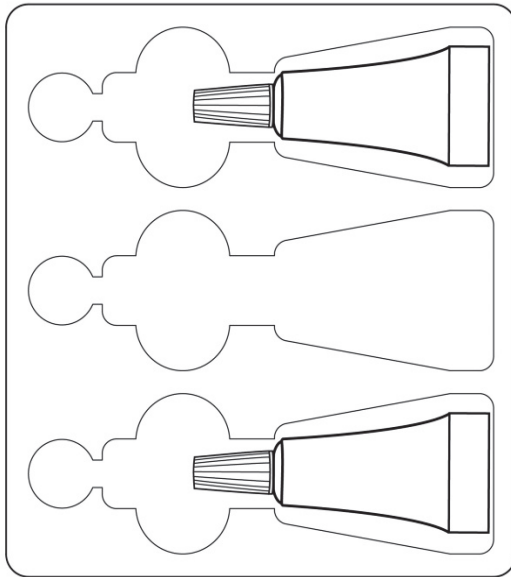

FORMING SIDE OF PACKAGE

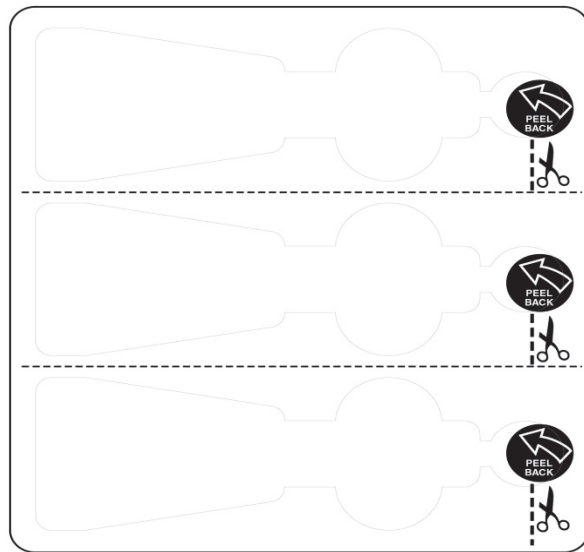

BACKING SIDE OF PACKAGE

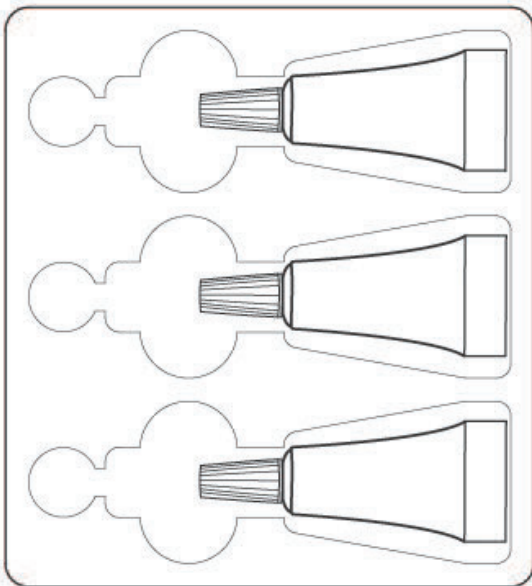

FORMING SIDE OF PACKAGE

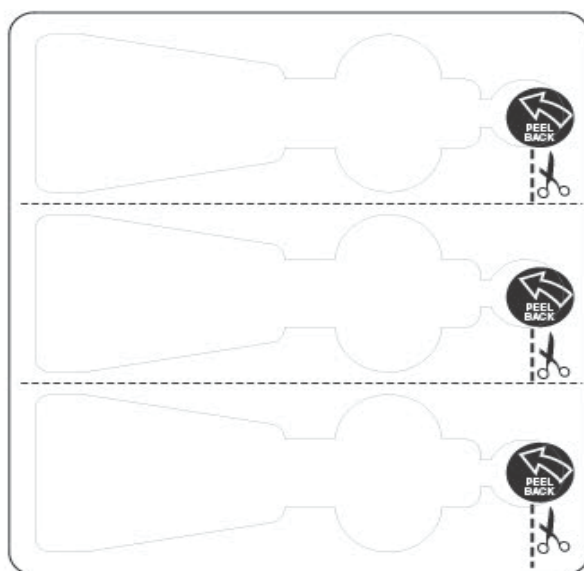

BACKING SIDE OF PACKAGE

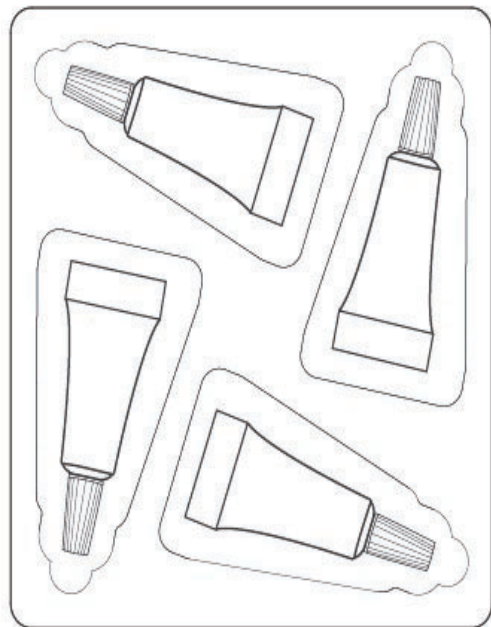

FORMING SIDE OF PACKAGE

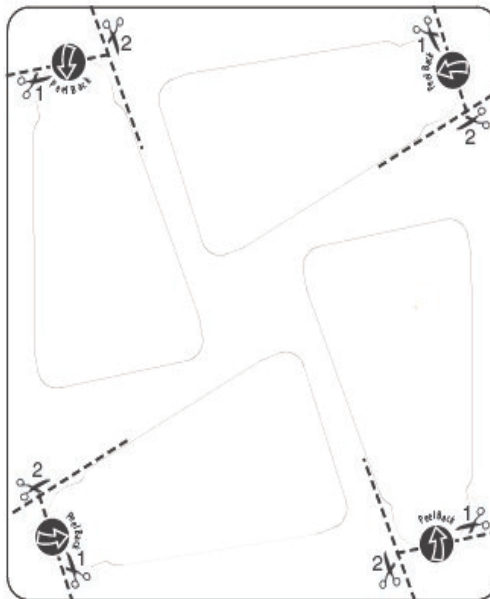

BACKING SIDE OF PACKAGE

{BLISTER TEXT}

{Alternate Brand Name}

ONLY for use on Dogs and Puppies 8 weeks and older:

Weighing: [5-22 lbs] [23-44 lbs] [45-88 lbs] [89-132 lbs]

Contains ____ fl. oz. (____) mL

Lot Code:

ACTIVE INGREDIENTS:

Fipronil.....9.80%

(S)-Methoprene....8.80%

Keep Out of Reach of Children

CAUTION

Read accompanying label before use

EPA Reg. No. 2596-165

EPA Est. No. 2596-XX-X



{OPTIONAL LABEL TEXT}

{Note to Reviewer: Bullets have been added to Optional Label Text and Non-Pesticide Related Claims & Other Optional Text sections whenever possible, to make it easier to itemize and review.}

[Adult Fleas]

- Kills Fleas [that may transmit tapeworm][for 1 month] on dogs and puppies older than 8 weeks and weighing [5–22 lbs] [23-44 lbs] [45-88 lbs] [89-132 lbs]
- Kills [Adult] Fleas
- [Kills][Controls] fleas that [which] may cause [flea allergy dermatitis] [and] [flea bite anemia for 1 month [on dogs]
- Kills newly emerged adult Fleas before they lay eggs
- Re-apply after 1 month for adult Flea control

Starts killing new fleas within 30 minutes*

*48 hours after initial application

{Both of the above statements must appear on the same panel. The qualifying statement is to be in close proximity with the same font, color and background, with font size being 40% or greater.}

[Flea Eggs]

- Kills Flea Eggs [and Flea Larvae] for 1 month.
- Prevents Flea Eggs from hatching

[[Ticks]

- Kills Ticks for 1 month
- Kills [all stages of] Brown Dog Ticks, American Dog Ticks, Lone Star Ticks and Deer Ticks for 1 month
- Kills Deer Ticks for 1 month
- Kills Deer Ticks for 1 month on dogs and puppies 8 weeks of age or older weighing [5–22 lbs] [23-44 lbs] [45-88 lbs] [89-132 lbs]
- Kills all stages of Deer Ticks for 1 month
- Kills all stages of Deer Ticks for 1 month on dogs and puppies 8 weeks of age or older weighing [5–22 lbs] [23-44 lbs] [45-88 lbs] [89-132 lbs]
- Kills Deer Ticks that may transmit Lyme disease for 1 month
- Kills Deer Ticks that may transmit Lyme disease for 1 month on dogs and puppies 8 weeks of age or older weighing [5–22 lbs] [23-44 lbs] [45-88 lbs] [89-132 lbs]
- Kills all stages of Deer Ticks that may transmit Lyme disease for 1 month

-
- Kills all stages of Deer Ticks that may transmit Lyme disease for 1 month on dogs and puppies 8 weeks of age or older weighing [5–22 lbs] [23-44 lbs] [45-88 lbs] [89-132 lbs]
 - Kills all stages of ticks [larva, nymph, and adult] [:] Brown Dog ticks [*R. sanguineous*], American dog ticks [*D. variabilis*], Lone Star ticks [*Amblyomma americanum*], Deer ticks [*Ixodes scapularis*] [which may transmit Lyme disease]
 - Kills all stages of Ticks, [including those that may transmit Lyme disease]
 - Kills [all stages of] Deer Ticks [that may transmit Lyme disease] for 1 month [on dogs]
 - Kills all biting stages of ticks
 - Kills adult [brown dog] [deer] ticks, nymphs and larvae
 - Kills Ticks including those that may transmit Lyme disease
 - Kills all stages of ticks [larva, nymph, and adult]

[Lice]

- Controls chewing lice infestations
- Controls infestations of chewing lice

[Multiple]

- Kills Fleas, Flea Eggs [and] Larvae [and][Chewing Lice]
- Kills Fleas, Ticks, Flea eggs, Chewing Lice, [Flea larvae]
- [Kills fleas, flea eggs [and] [&] larvae, [ticks], [and] [chewing lice]
- Kills Fleas, Ticks, Flea eggs, [Flea larvae], Chewing Lice
- Kills Fleas, Ticks, Flea eggs through contact for 1 month
- Kills Fleas, Ticks, Flea eggs, [Flea larvae] for 1 month
- Kills Fleas, Ticks, Flea eggs, [Flea larvae] [through contact] for 1 month
- Kills Fleas, Ticks, Flea Eggs, Flea larvae for 1 month
- Kills Fleas, Ticks, Flea Eggs, [Flea larvae] [through contact] for 1 month
- Kills Fleas, Ticks, Flea Eggs, Chewing lice for 1 month
- Kills Fleas, Ticks, Flea Eggs, Chewing lice through contact for 1 month
- Kills Fleas, Ticks, Flea Eggs, [Flea larvae], and Chewing lice [through contact] for 1 month
- Kills Fleas, Ticks, Flea eggs, [Flea larvae] [after contact] for 1 month
- Kills Fleas, Ticks, Flea eggs, after contact for 1 month
- Kills adult Fleas, Flea Eggs and Larvae
- Prevents Flea stages [eggs, larvae] from [hatching][developing]
- Kills Fleas, Brown Dog Ticks, Deer Ticks, Flea Eggs, Flea larvae after contact for 1 month
- Kills Fleas, Brown Dog Ticks, Deer Ticks, Flea Eggs, Flea larvae for 1 month
- Kills Fleas, Brown Dog Ticks, Deer Ticks, Flea Eggs, after contact for 1 month
- Kills Fleas, Brown Dog Ticks, Deer Ticks, Flea Eggs, [Flea larvae] [after contact] for 1 month
- Controls Flea and Tick infestations [on dogs] for 1 month

-
- Provides fast, effective and convenient treatment and control of fleas, [ticks] [and chewing lice] [for dogs and puppies 8 weeks and older weighing [5–22 lbs] [23-44 lbs] [45-88 lbs] [89-132 lbs], within 30 minutes, 48 hours after application.
 - Helps prevent re-infestation of fleas and ticks for 1 month
 - Helps prevent flea and tick re-infestation for 1 month
 - Kills flea eggs and flea larvae to help prevent future re-infestations
 - Kills stages of the flea life cycle
 - Breaks the flea life cycle
 - Prevents all flea stages [eggs, larvae] from developing
 - Controls flea and tick infestations
 - Once-a month Flea and Tick [Prevention] [Treatment] [Control] [Solution]
 - Monthly Flea and Tick [Prevention] [Treatment] [Control] [Solution]
 - Flea and Tick [Prevention] [Treatment] [Control] [Solution]
 - Prevents flea eggs from developing into biting adults for 1 month
 - Kills fleas for 1 month
 - Controls and prevents flea infestations
 - Prevents flea re-infestation
 - Prevents [and controls] flea re-infestation[s]
 - Effective and convenient topical treatment
 - Kills fleas [and ticks] through [after] contact
 - [With] patented applicator *{The term “applicator” will be not used for screw-top tubes.}*
 - [With] patent pending applicator *{The term “applicator” will be not used for screw-top tubes.}*
 - Effective after exposure to water
 - Waterproof
 - Easy spot on topical applicator
 - Remains effective even after bathing, [water immersion], [swimming,] [or] [exposure to sunlight]
 - {Alternate Brand Name} remains effective after bathing or exposure to sunlight.
 - {Alternate Brand Name} remains effective after bathing, water immersion or exposure to sunlight
 - {Alternate Brand Name} Can be used on breeding, pregnant and lactating bitches
 - {Alternate Brand Name} Contains Fipronil and the insect growth regulator [IGR] (S)-Methoprene.
 - {Alternate Brand Name} effectively targets all stages of fleas.
 - {Alternate Brand Name} is fast acting (within 30 minutes, 48 hours after application), long lasting (1 month), waterproof, [and] [&] [convenient] [easy] [to use].
-

{NON-PESTICIDE RELATED CLAIMS AND OTHER OPTIONAL TEXT}

{For any claims containing an “X”, the “X” will correspond to the net contents. The number of tubes will not exceed 24. Any “free” applications will be included in the net contents of the carton.}

- 1st dose, 2nd dose, 3rd dose [Xth* dose] {*X = 1 or 2 or 3 or 4 or 6 or 8}
- Value [6][8] Pack *{Value pack contains 6 tubes or 8 tubes}*
- [6][8] month supply when using 1 tube per month
- [1][2][3][4][6][8] monthly treatment[s]
- Fragrance-free
- Unscented
- Convenient [easy to use] applicator
- X Pro-cision Flo® Applicator[s]
- [Pro-cision Flo® Applicator]
- Easy [simple] to use [handle] [apply]
- Easy to use [tube]
- To help remind you when you last applied treatment, simply write in the date when each dose is applied:
First Dose _____
Second Dose _____
Third Dose _____
Xth Dose _____
- [Calendar] [Reminder] stickers [inside]
- [1] [2] [3] [4] [6] [8] [Dose][Doses] [Inside]
- [2 Pack] [2 tubes] [2 tubes] [2 Months Supply] [2 Doses]
- [3 Pack] [3 tubes] [3 tubes] [3 Months Supply] [3 Doses]
- [4 Pack] [4 tubes] [4 tubes] [4 Months Supply] [4 Doses]
- [6 Pack] [6 tubes] [6 tubes] [6 Months Supply] [6 Doses]
- [8 Pack] [8 tubes][8 tubes] [8 Months Supply] [8 Doses]
- [2] [3] [4] [6] [8] Dose Value Pack
- [1][2] [3] [4] [6] [8] [doses][tubes][month supply]
- Bonus [4][6][8] Pack *{Bonus Pack contains 4 or 6 or 8 tubes}*
- Buy 3 get 1 free
- 3 month supply
- 4 month supply
- 6 month supply
- 8 month supply

-
- Contains [1][2] [3] [4] [6] [8][tube][tubes]
 - The first time you treat your dog, place the First Application Sticker on your calendar. Apply Stickers [2 and 3] [2 through 4] [2 through 6] [2 through 8] to the calendar, each one month apart, starting with the first application to remind you it's time to reapply {Alternate Brand Name}.

[First Application Sticker:] Apply {Alternate Brand Name}

[Month 2 Sticker:] Apply {Alternate Brand Name}

[Month 3 Sticker:] Apply {Alternate Brand Name}

Month 4 Sticker:] Apply {Alternate Brand Name}

Month 5 Sticker:] Apply {Alternate Brand Name}

[Month 6 Sticker:] Apply {Alternate Brand Name}

[Month 7 Sticker:] Apply {Alternate Brand Name}

[Month 8 Sticker:] Apply {Alternate Brand Name}















- For Customer Service please call 1-xxx-xxxx
- Questions or comments about this product? Call [X-XXX-XXX-XXXX] [1-888-843-2596] Monday – Friday X am- X pm EST
- Hartz® and other trademarks are trademarks of The Hartz Mountain Corporation
- Fast acting – Starts killing within 30 minutes, 48 hours after application for fleas.
- Long lasting for 1 month
- Long lasting – effective for 1 month
- Convenient to use
- Easy to use
- For dogs and puppies 8 weeks of age or older weighing [5–22 lbs] [23-44 lbs] [45-88 lbs] [89-132 lbs]
- Formulated for dogs and puppies 8 weeks of age or older weighing [5–22 lbs] [23-44 lbs] [45-88 lbs] [89-132 lbs]

- ✓ Contains the same active ingredients Fipronil and (S)-methoprene found in Frontline® Plus for Dogs
- ✓ Contains Fipronil and (S)-Methoprene, the same active ingredients used in Frontline® Plus for Dogs
- ✓ Contains Fipronil and (S)-Methoprene [, the active ingredients used in Frontline® Plus for Dogs]
- ✓ Contains the same active ingredients as Frontline® Plus for Dogs

{Note to Reviewer: Whenever any of the four claims immediately above (check marked) are included on product labels, then the label will contain the appropriate disclaimers below (arrows). The disclaimers will be placed in the same area of the label as the optional claims so that both the check marked and the arrow items are viewed together.}

- {Alternate Brand Name} is not manufactured by or distributed by Merial Limited
- Frontline® is a registered trademark of Merial Limited
- Frontline® Plus is a registered trademark of Merial
- {Alternate Brand Name} is not manufactured by or distributed by Merial

{OPTIONAL MARKETING ICONS}

 	Adult Fleas	 	Flea Eggs
 	Adult Ticks	 	Flea Larvae
 	Flea Eggs	 	Flea Larvae
	Tick Larvae and Nymph		Tick Larvae and Nymph



Chewing Lice



{Alternate Brand Names}

Hartz® ForcePlus™ Dual Action™ Topical Treatment for Dogs [&] [and] [Puppies]

Hartz® FieldForcePlus™ Dual Action™ Topical Treatment for Dogs [&] [and] [Puppies]

Hartz® FirstDefensePlus™ Dual Action™ Topical Treatment for Dogs [&] [and] [Puppies]

Hartz® First Defense Plus™ Dual Active Topical Treatment for Dogs [&] [and] [Puppies]

Hartz® PlusForce™ for Dogs [&] [and] [Puppies]

Hartz® FieldForce Plus™ for Dogs [&] [and] [Puppies]

Hartz® First Defense Plus™ for Dogs [&] [and] [Puppies]

Hartz® Plus Force™ Dual Action™ Topical Solution for Dogs [&] [and] [Puppies]

Hartz® FieldForce Plus™ Dual Action™ Topical Solution for Dogs [&] [and] [Puppies]

Hartz® FirstDefensePlus™ Dual Action™ Topical Solution for Dogs [&] [and] [Puppies]

Hartz® FirstDefensePlus™ Dual Active Topical Solution for Dogs [&] [and] [Puppies]

FieldForce Plus™ Dual Action™ Topical Treatment for Dogs [&] [and] [Puppies]

FirstDefensePlus™ Dual Action™ Topical Treatment for Dogs [&] [and] [Puppies]

First Defense Plus™ Dual Active Topical Treatment for Dogs [&] [and] [Puppies]

FieldForce Plus™ for Dogs [&] [and] [Puppies] First Defense Plus™ for Dogs [&] [and] [Puppies]

FieldForce Plus™ Dual Action™ Topical Solution for Dogs [&] [and] [Puppies]

FirstDefensePlus™ Dual Action™ Topical Solution for Dogs [&] [and] [Puppies]

FirstDefensePlus™ Dual Active Topical Solution for Dogs [&] [and] [Puppies]

Hartz® Pet Defender Plus for Dogs [&] [and] [Puppies]

Hartz® PetDefender Plus for Dogs [&] [and] [Puppies]

Pet Defender Plus for Dogs [&] [and] [Puppies]

PetDefender Plus for Dogs [&] [and] [Puppies]