

2382-185

8/3/2011

10435



UNITED STATES ENVIRONMENTAL PROTECTION AGENCY
WASHINGTON, D.C. 20460

OFFICE OF
CHEMICAL SAFETY AND
POLLUTION PREVENTION
NOTIFICATION

AUG - 3 2011

Craig Parks, DVM
V.P. Research and Development
Virbac Animal Health
3200 Meacham Blvd.
Fort Worth, TX 76137

Subject: Application for Pesticide Notification
EPA Registration Number: 2382-185
Date of Submission: July 27, 2011

Dear Registrant:

The Agency is in receipt of your Application for Pesticide Notification under Pesticide Registration (PRN) 98-10 dated July 27, 2011, for the abovementioned product. The Registration Division (RD) has conducted a review of this request for its applicability under PRN 98-10 and finds that the actions requested fall within the scope of PRN 98-10. The label submitted with the application has been stamped "Notification" and will be placed in our records.

If you have any questions regarding this letter, please contact Clayton Myers at (703) 347-8874, or via email at myers.clayton@epa.gov.

Sincerely,

A handwritten signature in blue ink, appearing to read "Richard Gebken".

for Richard Gebken
Product Manager
Insecticide Branch
Registration Division (7505P)

Enclosures: Copy of Label Stamped "Notification"

Please read instructions on reverse before completing form

Form Approved, OMB No. 2070-0060, Approval expires 5-31-98

	United States	<input type="checkbox"/>	Registration	OPP Identifier Number
	Environmental Protection Agency	<input type="checkbox"/>	Amendment	
	Washington, DC 20460	<input checked="" type="checkbox"/>	Other	

Application for Pesticide – Section I

1. Company/Product Number Virbac Animal Health EPA Reg. No. 2382-185	2. EPA Product Manager Gebken	3. Proposed Classification <input checked="" type="checkbox"/> None <input type="checkbox"/> Restricted
4. Company/Product (Name) Effipro Topical Solution for Dogs	PM # 10	
5. Name and Address of Applicant (Include ZIP Code) Virbac Animal Health 3200 Meacham Blvd. • Fort Worth, TX 76137 <input type="checkbox"/> Check if this is a new address	6. Expedited Review. In accordance with FIFRA Section 3(c)(3) (b)(i), my product is similar or identical in composition and labeling to: EPA Reg No. _____ Product Name _____	

Section - II

<input type="checkbox"/> Amendment – Explain below	<input type="checkbox"/> Final printed labels in response to _____	NOTIFICATION AUG - 3 2011
<input type="checkbox"/> Resubmission in response to Agency letter dated _____	<input type="checkbox"/> Agency letter dated _____ "Me Too" Application	
<input checked="" type="checkbox"/> Notification – Explain below	<input type="checkbox"/> Other – Explain below	

Explanation: Use additional page(s) if necessary. (For Section I and Section II.)

Minor label amendment under PR 98-10. Please see cover letter for details.

Section III

1. Material This Product Will be Packaged in:				2. Type of Container	
Child-Resistant Packaging <input type="checkbox"/> Yes <input type="checkbox"/> No	Unit Packaging <input type="checkbox"/> Yes <input type="checkbox"/> No	Water Soluble Packaging <input type="checkbox"/> Yes <input type="checkbox"/> No	<input type="checkbox"/> Metal <input type="checkbox"/> Plastic, PETE <input type="checkbox"/> Glass <input type="checkbox"/> Paper <input type="checkbox"/> Other (Specify) _____		
*Certification must be submitted		If "Yes" Unit Packaging wgt.	No. per container	If "Yes" Package wgt.	No. per container
3. Location of Net Contents Information <input type="checkbox"/> Label <input type="checkbox"/> Container		4. Size(s) Retail Container		5. Location of label directions <input type="checkbox"/> On Label <input type="checkbox"/> On Label accompanying product	
6. Manner in Which Label is Affixed to Product			<input type="checkbox"/> Lithograph <input type="checkbox"/> Paper glued <input type="checkbox"/> Stenciled	<input type="checkbox"/> Other _____	

Section IV

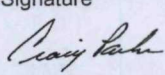
1. Contact Person (Complete items directly below for identification of individual to be contacted, if necessary, to process this application.)		
Name Craig Parks	Title V. P, Research and Development	Telephone No. (Include Area Code) (817) 831-5030
Certification I certify that the statements I have made on this form and all attachments thereto are true, accurate and complete. I acknowledge that any knowingly false or misleading statement may be punishable by fine or imprisonment or both under applicable law		6. Date Application Received (Stamped)
2. Signature 	3. Title V.P Research and Development	
4. Typed Name Craig Parks, DVM.	5. Date July 27, 2011	

30f35



July 27, 2011

NOTIFICATION

AUG - 3 2011

Richard Gebken, PM Team 10
Office of Pesticide Programs (7504P)
U.S. Environmental Protection Agency
Document Processing Desk
Room S-4900, One Potomac Yard
2777 South Crystal Dr.
Arlington, VA 22202

Re: 2382-185; Effipro Topical Solution for Dogs; Missing label pages: "3-applicator" labels for dogs 23-44.9 lb and 45-88.9 lb.

Dear Richard,

We are in receipt of the Agency's July 20, 2011 letter approving our application for amending the label of the above product dated February 1, 2011. We have not been able to locate in the stamped labeling returned to us by the Agency the two pages identified above as missing pages.

Based on a telephone conversation with the reviewer, Clayton Myers, on July 26, 2011, the missing labeling mentioned above was in fact reviewed and approved by the Agency.

Virbac Animal Health is hereby submitting under PR-98-10 a complete set of approved text and plate copy labeling for this product, including the missing pages. Please place this communication and label in the registration jacket and PPLS.

"This notification is consistent with the provisions of PR Notice 98-10 and EPA regulations at 40 CFR 152.46, and no other changes have been made to the labeling or the confidential statement of formula of this product. I understand that it is a violation of 18 U.S.C. Sec. 1001 to willfully make any false statement to EPA. I further understand that if this notification is not consistent with the terms of PR Notice 98-10 and 40 CFR 152.46, this product may be in violation of FIFRA and I may be subject to enforcement action and penalties under sections 12 and 14 of FIFRA."

Thank you,

Vice President, Research and Development
Enclosures

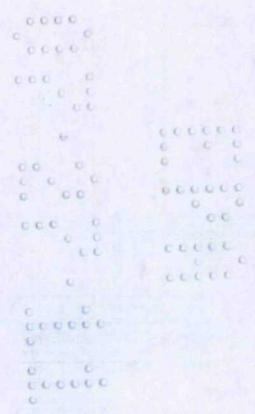

NOTIFICATION

AUG - 3 2011

{Master Label}

Virbac

EFFIPRO[®] TOPICAL SOLUTION FOR DOGS

FOR USE ONLY ON DOGS AND PUPPIES 8 WEEKS OLD OR OLDER (WEIGHING)(UP TO 22.9 LBS, [WEIGHING] 23 TO 44.9 LBS, [WEIGHING] 45 TO 88.9 LBS, [WEIGHING] 89 TO 132 lbs).

ACTIVE INGREDIENT:	
Fipronil	9.6%
OTHER INGREDIENTS:	90.4%
TOTAL:	100.0%

**KEEP OUT OF REACH OF CHILDREN
CAUTION
READ ENTIRE LABEL BEFORE EACH USE**

**PRECAUTIONARY STATEMENTS
HAZARDS TO HUMANS AND DOMESTIC ANIMALS**

HAZARDS TO HUMANS

Harmful if swallowed. Causes eye irritation. Avoid contact with skin, eyes, or clothing. Wash hands thoroughly with soap and water after handling and before eating, drinking, chewing gum, using tobacco, or using the toilet.

HAZARDS TO DOMESTIC ANIMALS

For external use only. Do not use on puppies under 8 weeks of age. Individual sensitivities, while rare, may occur after using ANY pesticide product. Possible temporary irritation may occur at the site where EFFIPRO[®] Topical Solution for Dogs was applied. Contact a veterinarian immediately if signs become persistent or become more severe during the first few days following application. If an unusual reaction is observed following initial application, a veterinarian should be consulted before repeating application. Certain medications can interact with pesticides. Consult a veterinarian before using on medicated, debilitated or aged dogs.

FIRST AID	
IF SWALLOWED:	<ul style="list-style-type: none"> • Call a poison control center or doctor immediately for treatment advice. • Have person sip a glass of water if able to swallow. • Do not induce vomiting unless told to do so by a poison control center or doctor. • Do not give anything by mouth to an unconscious person.
IF IN EYES:	<ul style="list-style-type: none"> • Hold eye open and rinse slowly and gently with water for 15-20 minutes. • Remove contact lenses, if present, after the first 5 minutes, then continue rinsing eye. • Call a poison control center or doctor for treatment advice.
IF ON SKIN OR CLOTHING:	<ul style="list-style-type: none"> • Take off contaminated clothing. • Rinse skin immediately with plenty of water for 15-20 minutes. • Call a poison control center or doctor for treatment advice.
<p>Have product container or label with you when calling a poison control center or doctor, or going for treatment.</p> <p>You may also contact the Hotline number 1-800-338-3659 for human and veterinary health concerns, emergency medical treatment information or pesticide incidents.</p>	

DIRECTIONS FOR USE

It is a violation of Federal law to use this product in any manner inconsistent with its labeling. Do not allow children to apply product. **TO PREVENT HARM TO YOU AND YOUR DOG, READ ENTIRE LABEL AND DIRECTIONS BEFORE EACH USE.** FOLLOW ALL DIRECTIONS AND PRECAUTIONARY STATEMENTS CAREFULLY. USE ON DOGS ONLY. DO NOT USE ON RABBITS. DO NOT USE ON OTHER ANIMALS.

For killing fleas, all stages of **Brown dog ticks, American dog ticks, Lone Star ticks, and Deer ticks** (that may [which may] transmit [carry] Lyme disease), mosquitoes and chewing lice; apply to **DOGS** or **PUPPIES** (8 weeks old or older) as follows:

APPLICATION DIRECTIONS

1. Remove one applicator from packaging.
Hold applicator upright and remove cap.
2. Invert cap and place other end back onto applicator tip.
Push cap down to break seal.
Remove cap prior to treatment application.
3. Part dog's hair between shoulder blades until skin is visible.
Place applicator tip directly against exposed skin.
Deposit entire contents by squeezing the applicator at a single site on dog's skin.
Ensure that EFFIPRO® Topical Solution for Dogs is not applied superficially on dog's hair.

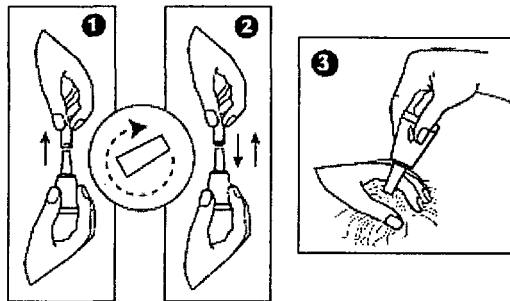

FREQUENCY OF APPLICATION

Research has shown that flea, tick and chewing lice infestations can be completely controlled with monthly applications of EFFIPRO® Topical Solution for Dogs.

Fleas: EFFIPRO® Topical Solution for Dogs can kill adult fleas for up to three months. Apply monthly if your dog has fleas that may cause Flea Allergy Dermatitis (FAD), or if reinfestation is likely.

Ticks: EFFIPRO® Topical Solution for Dogs can kill ticks for a month or longer. Apply monthly where tick control is consistently needed.

Chewing Lice: EFFIPRO® Topical Solution for Dogs can kill chewing lice for a month or longer. Apply monthly where chewing lice control is consistently needed.

Mosquitoes: When applied monthly, EFFIPRO® Topical Solution for Dogs can kill mosquitoes within 24 hours (for up to 7 days) and within 48 hours (for up to 28 days).

Notes: Wait at least 30 days before re-application of EFFIPRO® Topical Solution for Dogs. Avoid contact with treated area until dry.

STORAGE AND DISPOSAL

Do not contaminate water, food, or feed by storage and disposal.

STORAGE: Store unused product in original container only, out of reach of children and animals.

PESTICIDE/CONTAINER DISPOSAL: **If empty:** Nonrefillable container. Do not reuse or refill this container. Offer for recycling, if available. **If partially filled:** Call your local solid waste agency for disposal instructions. Never place unused product down any indoor or outdoor drain.

LIMITED WARRANTY AND DISCLAIMER

To the extent consistent with applicable law, buyer assumes all risks of use, storage, or handling of this product not in accordance with directions. Buyer and user assume all risks of use and handling of this material when such use and handling are contrary to label instructions. To the extent consistent with applicable law, any damage arising from a breach of this warranty shall be limited to direct damages and shall not include consequential commercial damages such as loss of profit or values.

How supplied: For easy and convenient application, EFFIPRO® Topical Solution for Dogs is available in sizes for small dogs and puppies 8 weeks old or older and up to 22.9 lbs (0.023 fl oz)/(0.67 mL), medium dogs 23-44.9 lbs (0.045 fl oz)/(1.34 mL), large dogs 45-88.9 lbs (0.091 fl oz)/(2.68 mL), and extra large dogs 89-132 lbs (0.136 fl oz)/(4.02 mL).

Net Contents:

1, 3, 6 or 36 single-dose applicator(s) per package. Each applicator contains 0.023 fl oz (0.67 mL), 0.045 fl oz (1.34 mL), 0.091 fl oz (2.68 mL), or 0.136 fl oz (4.02 mL) (of solution).

(Detachable) calendar (monthly application) reminder stickers (with illustration of dog or puppy)

EPA Reg. No. 2382-185

EPA Est. No. 2382-FRA-1

60f35

VIRBAC AH, INC.
PO BOX 162059
FORT WORTH, TX 76161
1-800-338-3659

Made in France
EFFIPRO® is a registered trademark of Virbac S.A.
Questions or comments?
Call: 1-800-338-3659

{Text for Front Panel, Back Panel and Side Panel}

See package insert(s) for directions for use and frequency of application
Open resealable label for directions for use
Open resealable label for directions for use and storage and disposal
See back panel for additional precautionary statements
See package insert(s) for frequency of application
See enclosed insert(s) for directions for use and storage and disposal
See enclosed insert(s) for directions for use

Photograph of dog or puppy

Lift here to open (LIFT HERE TO OPEN)
For Use on Dogs only
Use only on dogs

{Text for Foil of Blister package}

Virbac
EFFIPRO® Topical Solution for Dogs
Only for use (on dogs up to 22.9 lbs, on dogs 23-44.9 lbs, on dogs 45-88.9 lbs, on dogs 89-132 lbs) / (0.023 fl oz [0.67 mL], 0.045 fl oz [1.34 mL], 0.091 fl oz [2.68 mL], 0.136 fl oz [4.02 mL])
Contains fipronil (9.6%)
KEEP OUT OF REACH OF CHILDREN
CAUTION
See full label for additional directions
EPA Reg. No. 2382-185

{Text for Applicator Tube}

Virbac
EFFIPRO®
Topical Solution for Dogs
Only for use on dogs
up to 22.9 lbs (23-44.9 lbs, 45-88.9 lbs, 89-132 lbs)
0.023 fl oz [0.67 mL] (0.045 fl oz [1.34 mL], 0.091 fl oz [2.68 mL], 0.136 fl oz [4.02 mL])
Contains fipronil (9.6%)
KEEP OUT OF REACH OF CHILDREN
CAUTION
See full label for additional directions
EPA Reg. No. 2382-185

MARKETING CLAIMS

[Multiple infestations]

- For convenient, quick-acting, long-lasting, effective control of fleas, ticks, mosquitoes and chewing lice.
 - EFFIPRO® Topical Solution for Dogs contains the active ingredient fipronil, which controls infestations caused by fleas, ticks, mosquitoes and chewing lice (on dogs) (DOGS or PUPPIES) (8 weeks old or older) (weighing up to 22.9 lbs, weighing 23 to 44.9 lbs, weighing 45 to 88.9 lbs, weighing 89 to 132 lbs).
 - For easy and convenient application, EFFIPRO® Topical Solution for Dogs is available in sizes for small dogs and puppies 8 weeks old or older and up to 22.9 lbs (0.023 fl oz) (0.67 mL), medium dogs 23-44.9 lbs (0.045 fl oz) (1.34 mL), large dogs 45-88.9 lbs (0.091 fl oz) (2.68 mL), and extra large dogs 89-132 lbs (0.136 fl oz) (4.02 mL).
 - EFFIPRO® Topical Solution for Dogs is also approved for control of flea, tick, mosquito and chewing lice infestations in breeding, pregnant and lactating bitches.
 - For killing fleas, all stages of **Brown dog ticks, American dog ticks, Lone Star ticks, and Deer ticks** (that [which] may transmit [carry] Lyme disease), mosquitoes and chewing lice; apply to DOGS or PUPPIES (8 weeks old or older) as follows: (followed by application directions).
 - Persistent flea and tick efficacy for up to one month (4 weeks)
 - Prevents flea and tick (re-)infestation for up to one month (4 weeks)
 - Kills fleas and ticks for up to one month (4 weeks)
 - Apply monthly for control and prevention of fleas and ticks
 - Kills fleas and ticks that may transmit Lyme disease, Rocky Mountain Spotted Fever, babesiosis, ehrlichiosis, bartonellosis and hepatozoonosis.
 - Kills fleas and ticks that may transmit Lyme disease, Rocky Mountain Spotted Fever, babesiosis, ehrlichiosis, and bartonellosis.
 - Kills fleas, ticks, mosquitoes and chewing lice
 - Effective monthly control of fleas and ticks
 - Effective monthly application for fleas and ticks
 - Effective monthly application for dogs against fleas and ticks
 - Single application kills fleas and ticks
 - Single application lasts 4 weeks (one month)
 - Research has shown that flea, tick and chewing lice infestations can be completely controlled with monthly applications of EFFIPRO® Topical Solution for Dogs.
- Fleas:** EFFIPRO® Topical Solution for Dogs can kill adult fleas for up to three months. Apply monthly if your dog has fleas that may cause Flea Allergy Dermatitis (FAD), or if reinfestation is likely.
- Ticks:** EFFIPRO® Topical Solution for Dogs can kill ticks for a month or longer. Apply monthly where tick control is consistently needed.
- Chewing Lice:** EFFIPRO® Topical Solution for Dogs can kill chewing lice for a month or longer. Apply monthly where chewing lice control is consistently needed.
- Mosquitoes:** When applied monthly, EFFIPRO® Topical Solution for Dogs can kill mosquitoes within 24 hours (for up to 7 days) and within 48 hours (for up to 28 days).

[Fleas]

- Kills newly emerged adult fleas prior to egg laying
- Kills fleas that may transmit bartonellosis
- Kills fleas that may transmit bartonellosis, tularemia and tapeworm
- Kills fleas that may transmit diseases, including bartonellosis, tularemia and tapeworm infestations.
- Kills fleas that may transmit diseases, including bartonellosis and tularemia
- Kills fleas that may cause Flea Allergy Dermatitis (FAD) or flea-bite anemia
- Effective monthly application against fleas
- Effective monthly control of fleas
- Kills adult fleas for up to one month (4 weeks)
- Kills fleas
- Easy to apply, control of (for) fleas that lasts 1 month (4 weeks)
- East to apply, flea control that lasts up to 1 (one) month (4 weeks)
- EFFIPRO® Topical Solution for Dogs kills fleas on your dog
- Kills adult fleas which may cause Flea Allergy Dermatitis (FAD)
- Kills fleas which (that) may cause flea-bite anemia
- Fleas do not have to bite to die
- EFFIPRO® Topical Solution for Dogs rapidly kills fleas that may cause FAD (Flea Allergy Dermatitis)
- The successive feeding activity of fleas on dogs may elicit a hypersensitivity skin disorder known as Flea Allergy Dermatitis (FAD)

[Ticks]

- Kills all stages of Brown dog ticks, American dog ticks, Lone Star ticks, and Deer ticks (that may transmit Lyme disease, Rocky Mountain Spotted Fever, babesiosis, ehrlichiosis and anaplasmosis)
- Kills ticks including Deer ticks (that may transmit Lyme disease), American dog ticks (that may transmit Rocky Mountain Spotted Fever), Brown dog ticks (that may transmit ehrlichiosis), and Lone Star ticks (that may transmit hepatozoonosis) for up to one month (4 weeks).
- Kills ticks including Deer ticks (that may transmit Lyme disease), American dog ticks (that may transmit Rocky Mountain Spotted Fever), and Brown dog ticks (that may transmit ehrlichiosis) for up to one month (4 weeks).
- Kills Brown dog ticks (*Rhipicephalus* spp), American dog ticks (*Dermacentor variabilis*), Deer ticks (*Ixodes* spp) and Lone Star ticks (*Amblyomma americanum*) for up to one month (4 weeks).
- Kills *Amblyomma americanum* (Lone Star ticks) for 4 weeks (for up to one month).

- Effective monthly application against ticks

[Mosquitoes]

- Kills mosquitoes
- Kills mosquitoes for up to 28 days

[All others]

- EFFIPRO® Topical Solution for Dogs aids in (the) control of sarcoptic mange mite infestations.
- Aids in (the) control of sarcoptic mange mite infestations
- Elimination of mites may require multiple monthly applications.
- Chewing lice infestations are rapidly eliminated
- Can be used on breeding, pregnant and lactating bitches
- May be used on puppies from 8 weeks of age
- Only for dogs and puppies 8 weeks old or older (weighing up to 22.9 lbs, 23 to 44.9 lbs, weighing 45 to 88.9 lbs, weighing 89 to 132 lbs)
- Easy, spot on (topical) application
- Convenient topical application for dogs
- Easy to apply spot-on (topical) application
- Quick drying, non-greasy
- Convenient, easy to apply
- Easy and convenient application (applications)
- Convenient to use (easy to apply)
- Once monthly application
- Single application lasts 4 weeks (1 month) (one month)
- 1 (3, 6 or 36) applicator(s) [tube(s)] 0.023 fl oz (0.67 mL)
- 1 (3, 6 or 36) applicator(s) [tube(s)] 0.045 fl oz (1.34 mL)
- 1 (3, 6 or 36) applicator(s) [tube(s)] 0.091 fl oz (2.68 mL)
- 1 (3, 6 or 36) applicator(s) [tube(s)] 0.136 fl oz (4.02 mL)
- 1 (3, 6, 36) month(ly) dose(s) (applications)
- 1 (3, 6 or 36) applicator(s) [tube(s)] (each) containing 0.023 fl oz (0.67 mL)
- 1 (3, 6 or 36) applicator(s) [tube(s)] (each) containing 0.045 fl oz (1.34 mL)
- 1 (3, 6 or 36) applicator(s) [tube(s)] (each) containing 0.091 fl oz (2.68 mL)
- 1 (3, 6 or 36) applicator(s) [tube(s)] (each) containing 0.136 fl oz (4.02 mL)
- 1 applicator (tube) 1 month(ly) dose
- 3 applicators (tubes) 3 monthly doses (applications)
- 6 applicators (tubes) 6 monthly doses (applications)
- 36 applicators (tubes) 36 monthly doses (applications)
- 1 (3, 6, 36) applicator(s) containing 0.023 fl oz [0.67 mL], 0.045 fl oz [1.34 mL], 0.091 fl oz [2.68 mL], 0.136 fl oz [4.02 mL].
- Available from licensed veterinarians
- Remains effective after exposure to sunlight
- Remains effective after bathing and swimming
- Remains effective even after bathing, water immersion or exposure to rain or sunlight
- Remains effective even after bathing
- Remains effective after exposure to rain and sunlight
- Still works after bathing, swimming or exposure to sunlight
- Still works after exposure to sunlight
- Maintains residual efficacy after bathing and swimming
- EFFIPRO® Topical Solution for Dogs is effective after bathing, shampooing, water immersion, or sunlight exposure.
- Waterproof (remains effective after bathing and swimming)

Dog Final master label as submitted on March 4, 2011

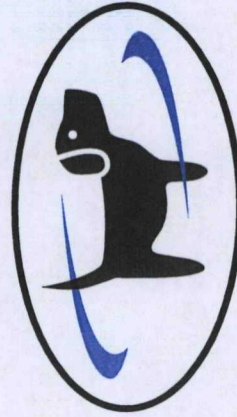
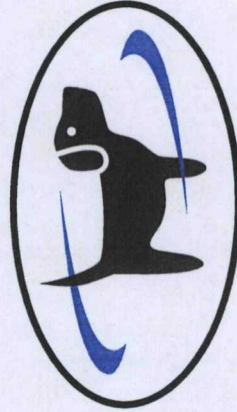
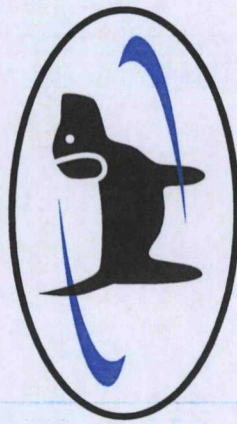



EFFIPRO®

Topical Solution for Dogs

FOR USE ONLY ON DOGS AND PUPPIES 8 WEEKS OLD OR OLDER

For convenient, quick-acting, long-lasting, effective control of fleas, ticks, mosquitoes and chewing lice.

- Easy and convenient application.
- Waterproof (remains effective after bathing and swimming).
- Kills newly emerged adult fleas prior to egg-laying.
- Kills fleas that may transmit bartonellosis.
- Kills fleas that may cause Flea Allergy Dermatitis (FAD) or flea-bite anemia.
- Kills all stages of Brown dog ticks, American dog ticks, Lone Star ticks, and Deer ticks (that may transmit Lyme disease, Rocky Mountain Spotted Fever, babesiosis, ehrlichiosis and anaplasmosis).
- Kills mosquitoes.
- Chewing lice infestations are rapidly eliminated.
- Can be used on breeding, pregnant and lactating bitches.

EFFIPRO® Topical Solution for Dogs contains the active ingredient fipronil, which controls infestations caused by fleas, ticks, mosquitoes and chewing lice. For easy and convenient application, EFFIPRO® Topical Solution for Dogs is available in sizes for small dogs and puppies 8 weeks old or older and up to 22.9 lbs (0.023 fl oz / 0.67 mL), medium dogs 23-44.9 lbs (0.045 fl oz / 1.34 mL), large dogs 45-88.9 lbs (0.091 fl oz / 2.68 mL), and extra large dogs 89-132 lbs (0.136 fl oz / 4.02 mL).

ACTIVE INGREDIENT:

Fipronil9.6%

OTHER INGREDIENTS:90.4%

TOTAL: 100.0%

KEEP OUT OF REACH OF CHILDREN

CAUTION

READ ENTIRE LABEL BEFORE EACH USE

PRECAUTIONARY STATEMENTS

HAZARDS TO HUMANS AND DOMESTIC ANIMALS

■ **HAZARDS TO HUMANS**

Harmful if swallowed. Causes eye irritation. Avoid contact with skin, eyes, or clothing. Wash hands thoroughly with soap and water after handling and before eating, drinking, chewing gum, using tobacco, or using the toilet.

■ **HAZARDS TO DOMESTIC ANIMALS**

For external use only. Do not use on puppies under 8 weeks of age. Individual sensitivities, while rare, may occur after using ANY pesticide product. Possible temporary irritation may occur at the site where EFFIPRO® Topical Solution for Dogs was applied. Contact a veterinarian immediately if signs become persistent or become more severe during the first few days following application. If an unusual reaction is observed following initial application, a veterinarian should be consulted before repeating application. Certain medications can interact with pesticides. Consult a veterinarian before using on medicated, debilitated or aged dogs.

FIRST AID	
IF SWALLOWED:	<ul style="list-style-type: none"> · Call a poison control center or doctor immediately for treatment advice. · Have person sip a glass of water if able to swallow. · Do not induce vomiting unless told to do so by a poison control center or doctor. · Do not give anything by mouth to an unconscious person.
IF IN EYES:	<ul style="list-style-type: none"> · Hold eye open and rinse slowly and gently with water for 15-20 minutes. · Remove contact lenses, if present, after the first 5 minutes, then continue rinsing eye. · Call a poison control center or doctor for treatment advice.
IF ON SKIN OR CLOTHING:	<ul style="list-style-type: none"> · Take off contaminated clothing. · Rinse skin immediately with plenty of water for 15-20 minutes. · Call a poison control center or doctor for treatment advice.
<p>Have product container or label with you when calling a poison control center or doctor, or going for treatment.</p> <p>You may also contact the Hotline number 1-800-338-3659 for human and veterinary health concerns, emergency medical treatment information or pesticide incidents.</p>	

110 of 355

■ DIRECTIONS FOR USE

It is a violation of Federal law to use this product in any manner inconsistent with its labeling. Do not allow children to apply product. TO PREVENT HARM TO YOU AND YOUR DOG, READ ENTIRE LABEL AND DIRECTIONS BEFORE EACH USE. FOLLOW ALL DIRECTIONS AND PRECAUTIONARY STATEMENTS CAREFULLY. USE ON DOGS ONLY. DO NOT USE ON RABBITS. DO NOT USE ON OTHER ANIMALS.

For killing fleas, all stages of **Brown dog ticks**, **American dog ticks**, **Lone Star ticks**, and **Deer ticks** (that may transmit Lyme disease), mosquitoes and chewing lice; apply to DOGS or PUPPIES (8 weeks old or older) as follows:

■ APPLICATION DIRECTIONS

1. Remove one applicator from packaging. Hold applicator upright and remove cap.
2. Invert cap and place other end back onto applicator tip. Push cap down to break seal. Remove cap prior to treatment application.
3. Part dog's hair between shoulder blades until skin is visible. Place applicator tip directly against exposed skin. Deposit entire contents by squeezing the applicator at a single site on dog's skin. Ensure that EFFIPRO® Topical Solution for Dogs is not applied superficially on dog's hair.

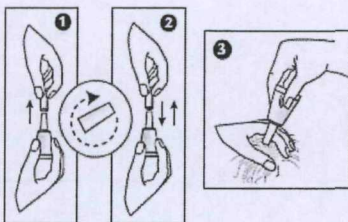

EFFIPRO® Topical Solution for Dogs is also approved for control of flea, tick, mosquito and chewing lice infestations in breeding, pregnant and lactating bitches. Aids in the control of sarcoptic mange mite infestations. Elimination of mites may require multiple monthly applications.

■ FREQUENCY OF APPLICATION

Research has shown that flea, tick and chewing lice infestations can be completely controlled with monthly applications of EFFIPRO® Topical Solution for Dogs.

Fleas: EFFIPRO® Topical Solution for Dogs can kill adult fleas for up to three months. Apply monthly if your dog has fleas that may cause Flea Allergy Dermatitis (FAD), or if reinfestation is likely.

Ticks: EFFIPRO® Topical Solution for Dogs can kill ticks for a month or longer. Apply monthly where tick control is consistently needed.

Chewing Lice: EFFIPRO® Topical Solution for Dogs can kill chewing lice for a month or longer. Apply monthly where chewing lice control is consistently needed.

Mosquitoes: When applied monthly, EFFIPRO® Topical Solution for Dogs can kill mosquitoes within 24 hours (for up to 7 days) and within 48 hours (for up to 28 days).

Notes: Wait at least 30 days before re-application of EFFIPRO® Topical Solution for Dogs. Avoid contact with treated area until dry.

EFFIPRO® Topical Solution for Dogs is effective after bathing, shampooing, water immersion, or sunlight exposure.

■ STORAGE AND DISPOSAL

Do not contaminate water, food, or feed by storage and disposal.

■ **STORAGE:** Store unused product in original container only, out of reach of children and animals.

■ **PESTICIDE/CONTAINER DISPOSAL:** If empty: Nonrefillable container. Do not reuse or refill this container. Offer for recycling, if available. If partially filled: Call your local solid waste agency for disposal instructions. Never place unused product down any indoor or outdoor drain.

■ LIMITED WARRANTY AND DISCLAIMER

To the extent consistent with applicable law, buyer assumes all risks of use, storage, or handling of this product not in accordance with directions. Buyer and user assume all risks of use and handling of this material when such use and handling are contrary to label instructions. To the extent consistent with applicable law, any damage arising from a breach of this warranty shall be limited to direct damages and shall not include consequential commercial damages such as loss of profit or values.

How supplied: For easy and convenient application, EFFIPRO® Topical Solution for Dogs is available in sizes for small dogs and puppies 8 weeks old or older and up to 22.9 lbs (0.023 fl oz / 0.67 mL), medium dogs 23-44.9 lbs (0.045 fl oz / 1.34 mL), large dogs 45-88.9 lbs (0.091 fl oz / 2.68 mL), and extra large dogs 89-132 lbs (0.136 fl oz / 4.02 mL).

Net Contents: 1, 3, 6 or 36 single-dose applicator(s) per package. Each applicator contains 0.023 fl oz (0.67 mL), 0.045 fl oz (1.34 mL), 0.091 fl oz (2.68 mL) or 0.136 fl oz (4.02 mL) of solution.

EPA Reg. No. 2382-185
EPA Est. No. 2382-FRA-1

VIRBAC AH, INC.
PO BOX 162059
FORT WORTH, TX 76161
1-800-338-3659

Made in France

EFFIPRO® is a registered trademark of Virbac S.A.

120435

Virbac
EFFIPRO®
Topical Solution for Dogs

1 applicator 0.023 fl oz (0.67 mL) Use only on dogs

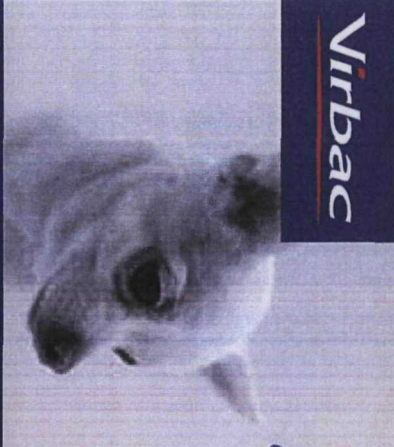

Virbac

**Only for dogs and puppies
8 weeks old or older weighing
up to 22.9 lbs**

Topical Solution for Dogs

FOR USE ONLY ON DOGS AND PUPPIES 8 WEEKS OLD OR OLDER

EFFIPRO® Topical Solution for Dogs contains the active ingredient fipronil, which controls infestations caused by fleas, ticks, mosquitoes and chewing lice on dogs 8 weeks old or older.

1 applicator 0.023 fl oz (0.67 mL)

KEEP OUT OF REACH OF CHILDREN
CAUTION
See back panel for additional precautionary statements.

EFFIPRO®

Topical Solution for Dogs

*Kills fleas, ticks,
mosquitoes and chewing lice*

ACTIVE INGREDIENT
Fipronil..... 9.6%
OTHER INGREDIENTS..... 90.4%
TOTAL..... 100.0%

**Only for dogs
and puppies
8 weeks old or
older weighing
up to 22.9 lbs**

EFFIPRO® Topical Solution for Dogs

**Only for dogs and puppies
8 weeks old or older weighing
up to 22.9 lbs**

Virbac

Virbac AH, INC., PO BOX 162059
FORT WORTH, TX 76161, 1-800-338-3659

Made in France

EPA Reg. No. 2382-185
EPA Est. No. 2382-FRA-1

1 applicator 0.023 fl oz (0.67 mL)

Lot No.:

KEEP OUT OF REACH OF CHILDREN
CAUTION

READ ENTIRE LABEL BEFORE EACH USE

PRECAUTIONARY STATEMENTS

HAZARDS TO HUMANS AND DOMESTIC ANIMALS

HAZARDS TO HUMANS: Harmful if swallowed. Causes eye irritation. Avoid contact with skin, eyes, or clothing. Wash hands thoroughly with soap and water after handling and before eating, drinking, chewing gum, using tobacco, or using the toilet.

HAZARDS TO DOMESTIC ANIMALS: For external use only. Do not use on puppies under 8 weeks of age. Individual sensitivities, while rare, may occur after using ANY pesticide product. Possible temporary irritation may occur at the site where EFFIPRO® Topical Solution for Dogs was applied. Contact a veterinarian immediately if signs become persistent or become more severe during the first few days following application. If an unusual reaction is observed following initial application, a veterinarian should be consulted before repeating application. Certain medications can interact with pesticides. Consult a veterinarian before using on medicated, debilitated or aged dogs.

See enclosed insert for directions for use and storage and disposal.

FIRST AID

IF SWALLOWED:	<ul style="list-style-type: none"> Call a poison control center or doctor immediately for treatment advice. Have person sip a glass of water if able to swallow. Do not induce vomiting unless told to do so by a poison control center or doctor. Do not give anything by mouth to an unconscious person. Hold eye open and rinse slowly and gently with water for 15-20 minutes. Remove contact lenses, if present, after the first 5 minutes, then continue rinsing eye. Call a poison control center or doctor for treatment advice.
IF IN EYES:	<ul style="list-style-type: none"> Take off contaminated clothing. Rinse skin immediately with plenty of water for 15-20 minutes. Call a poison control center or doctor for treatment advice.
IF ON SKIN OR CLOTHING:	<ul style="list-style-type: none"> Take off contaminated clothing. Rinse skin immediately with plenty of water for 15-20 minutes. Call a poison control center or doctor for treatment advice.

Have product container or label with you when calling a poison control center or doctor, or going for treatment. You may also contact the Hotline number 1-800-338-3659 for human and veterinary health concerns, emergency medical treatment information or pesticide incidents.



Virbac

EFFIPRO[®]

Topical Solution for Dogs

6.22 oz fl oz

Virbac Corp. Effipro is a subsidiary of Virbac

Kills fleas, ticks, mosquitoes and chewing lice

For convenient, quick-acting, long-lasting protection, simply apply Effipro to the back of your dog's neck. Kills fleas, ticks, mosquitoes and chewing lice.

Waterproof

Virbac

EFFIPRO[®]

Topical Solution for Dogs

3/6 applications (0.023 fl oz (0.67 ml))

Only for dogs and puppies 8 weeks old or older weighing up to 22.9 lbs



Virbac

EFFIPRO[®]

Topical Solution for Dogs

3/6 applications (0.023 fl oz (0.67 ml))

Only for dogs and puppies 8 weeks old or older weighing up to 22.9 lbs



Virbac

EFFIPRO[®]

Topical Solution for Dogs

3/6 applications (0.023 fl oz (0.67 ml))

Only for dogs and puppies 8 weeks old or older weighing up to 22.9 lbs



EFFIPRO[®]

Virbac Corp.

6.22 oz fl oz

Virbac Corp. Effipro is a subsidiary of Virbac

Waterproof

Kills fleas, ticks, mosquitoes and chewing lice

For convenient, quick-acting, long-lasting protection, simply apply Effipro to the back of your dog's neck. Kills fleas, ticks, mosquitoes and chewing lice.

Waterproof

Virbac

EFFIPRO[®]

Topical Solution for Dogs

3/6 applications (0.023 fl oz (0.67 ml))

Only for dogs and puppies 8 weeks old or older weighing up to 22.9 lbs



Virbac

EFFIPRO[®]

Topical Solution for Dogs

3/6 applications (0.023 fl oz (0.67 ml))

Only for dogs and puppies 8 weeks old or older weighing up to 22.9 lbs



Virbac

EFFIPRO[®]

Topical Solution for Dogs

3/6 applications (0.023 fl oz (0.67 ml))

Only for dogs and puppies 8 weeks old or older weighing up to 22.9 lbs



Virbac

EFFIPRO[®]

Topical Solution for Dogs

3/6 applications (0.023 fl oz (0.67 ml))

Only for dogs and puppies 8 weeks old or older weighing up to 22.9 lbs



Virbac

EFFIPRO[®]

Topical Solution for Dogs

3/6 applications (0.023 fl oz (0.67 ml))

Only for dogs and puppies 8 weeks old or older weighing up to 22.9 lbs



Virbac

EFFIPRO[®]

Topical Solution for Dogs

3/6 applications (0.023 fl oz (0.67 ml))

Only for dogs and puppies 8 weeks old or older weighing up to 22.9 lbs



Virbac

EFFIPRO[®]

Topical Solution for Dogs

3/6 applications (0.023 fl oz (0.67 ml))

Only for dogs and puppies 8 weeks old or older weighing up to 22.9 lbs



Virbac

EFFIPRO[®]

Topical Solution for Dogs

3/6 applications (0.023 fl oz (0.67 ml))

Only for dogs and puppies 8 weeks old or older weighing up to 22.9 lbs



Virbac

EFFIPRO[®]

Topical Solution for Dogs

3/6 applications (0.023 fl oz (0.67 ml))

Only for dogs and puppies 8 weeks old or older weighing up to 22.9 lbs



1100435

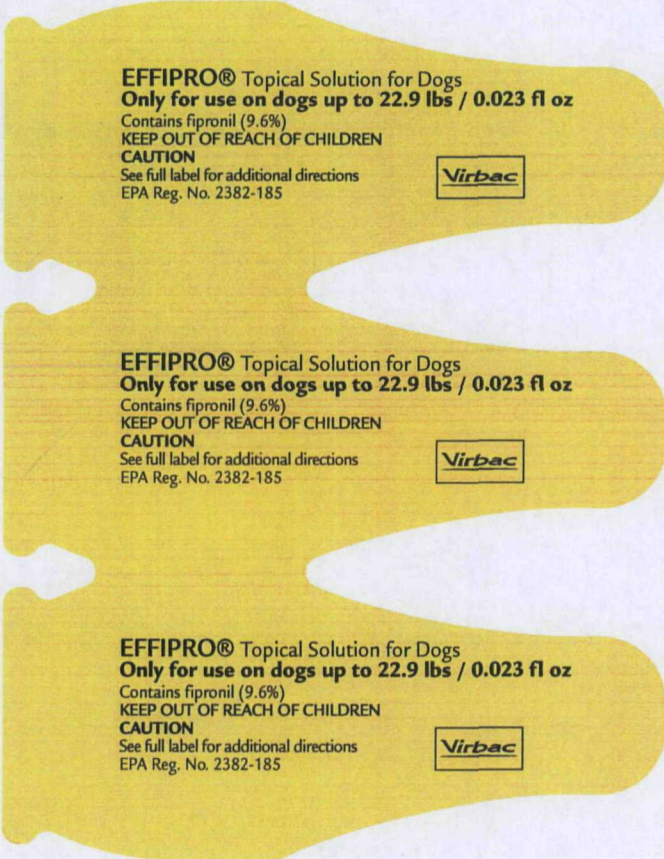

EFFIPRO® Topical Solution for Dogs
Only for use on dogs up to 22.9 lbs / 0.023 fl oz
Contains fipronil (9.6%)
KEEP OUT OF REACH OF CHILDREN
CAUTION
See full label for additional directions
EPA Reg. No. 2382-185



EFFIPRO® Topical Solution for Dogs
Only for use on dogs up to 22.9 lbs / 0.023 fl oz
Contains fipronil (9.6%)
KEEP OUT OF REACH OF CHILDREN
CAUTION
See full label for additional directions
EPA Reg. No. 2382-185



EFFIPRO® Topical Solution for Dogs
Only for use on dogs up to 22.9 lbs / 0.023 fl oz
Contains fipronil (9.6%)
KEEP OUT OF REACH OF CHILDREN
CAUTION
See full label for additional directions
EPA Reg. No. 2382-185



170435



EFFIPRO®
Topical Solution for Dogs
Only for use on dogs
up to 22.9 lbs
0.023 fl oz (0.67 mL)
Contains fipronil (9.6%)
KEEP OUT OF REACH
OF CHILDREN
CAUTION
See full label for
additional directions
EPA Reg. No. 2382-185



EFFIPRO®
Topical Solution for Dogs

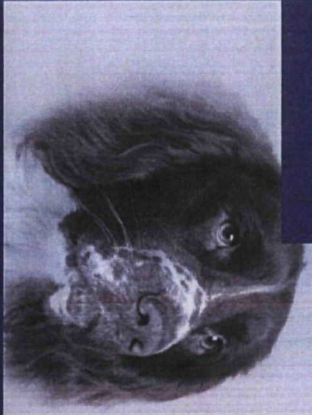

Virbac

EFFIPRO®
Topical Solution for Dogs

1 applicator 0.045 fl oz (1.34 mL) Use only on dogs

Only for dogs and puppies
8 weeks old or older weighing
23 to 44.9 lbs

Virbac Virbac AH, INC., PO BOX 162059
FORT WORTH, TX 76161, 1-800-338-3659
EFFIPRO® is a registered trademark of Virbac S.A. EPA Est. No. 2382-FRA-1

Made in France
EPA Reg. No. 2382-185
EPA Est. No. 2382-FRA-1

ACTIVE INGREDIENT
Fipronil 9.6%
OTHER INGREDIENTS 90.4%
TOTAL 100.0%

Topical Solution for Dogs
Kills fleas, ticks,
mosquitoes and chewing lice

EFFIPRO®
Topical Solution for Dogs

KEEP OUT OF REACH OF CHILDREN
CAUTION
See back panel for additional precautionary statements.

EFFIPRO®
Topical Solution for Dogs

FOR USE ONLY ON DOGS AND PUPPIES 8 WEEKS OLD OR OLDER

EFFIPRO® Topical Solution for Dogs contains the active ingredient fipronil, which controls infestations caused by fleas, ticks, mosquitoes and chewing lice on dogs 8 weeks old or older.

Only for dogs and puppies
8 weeks old or older weighing
23 to 44.9 lbs

KEEP OUT OF REACH OF CHILDREN
CAUTION

READ ENTIRE LABEL BEFORE EACH USE

PRECAUTIONARY STATEMENTS

HAZARDS TO HUMANS AND DOMESTIC ANIMALS

HAZARDS TO HUMANS: Harmful if swallowed. Causes eye

irritation. Avoid contact with skin, eyes, or clothing. Wash hands

thoroughly with soap and water after handling and before eating,

drinking, chewing gum, using tobacco, or using the toilet.

HAZARDS TO DOMESTIC ANIMALS: For external use only. Do not

use on puppies under 8 weeks of age. Individual sensitivities, while

rare, may occur after using ANY pesticide product. Possible temporary

irritation may occur at the site where EFFIPRO® Topical Solution for

Dogs was applied. Contact a veterinarian immediately if signs become

persistent or become more severe during the first few days following

application. If an unusual reaction is observed following initial

application, a veterinarian should be consulted before repeating

application. Certain medications can interact with pesticides. Consult

a veterinarian before using on medicated, debilitated or aged dogs.

Lot No.:

See enclosed insert for directions for use and storage and disposal.

FIRST AID	
IF SWALLOWED:	<ul style="list-style-type: none"> • Call a poison control center or doctor immediately for treatment advice. • Have person sip a glass of water if able to swallow. • Do not induce vomiting unless told to do so by a poison control center or doctor. • Do not give anything by mouth to an unconscious person.
IF IN EYES:	<ul style="list-style-type: none"> • Hold eye open and rinse slowly and gently with water for 15-20 minutes. • Remove contact lenses, if present, after the first 5 minutes, then continue rinsing eye. • Call a poison control center or doctor for treatment advice.
IF ON SKIN OR CLOTHING:	<ul style="list-style-type: none"> • Take off contaminated clothing. • Rinse skin immediately with plenty of water for 15-20 minutes. • Call a poison control center or doctor for treatment advice.

Have product container or label with you when calling a poison control center or doctor, or going for treatment. You may also contact the Hotline number 1-800-338-3659 for human and veterinary health concerns, emergency medical treatment information or pesticide incidents.



Topical Solution for Dogs

Lot No. _____

IF CONTAINS	IF CONTAINS	IF CONTAINS
<p>IF CONTAINS</p> <p>1. The off-commissioned solution contains the following active ingredients: Permethrin, Pyrethrin, and PIPROTHALIN.</p> <p>2. The off-commissioned solution contains the following active ingredients: Permethrin, Pyrethrin, and PIPROTHALIN.</p>	<p>IF CONTAINS</p> <p>1. The off-commissioned solution contains the following active ingredients: Permethrin, Pyrethrin, and PIPROTHALIN.</p> <p>2. The off-commissioned solution contains the following active ingredients: Permethrin, Pyrethrin, and PIPROTHALIN.</p>	<p>IF CONTAINS</p> <p>1. The off-commissioned solution contains the following active ingredients: Permethrin, Pyrethrin, and PIPROTHALIN.</p> <p>2. The off-commissioned solution contains the following active ingredients: Permethrin, Pyrethrin, and PIPROTHALIN.</p>

3 applications (0.045 fl oz (1.34 ml))

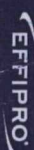

Topical Solution for Dogs

23 to 44.9 lbs

3 applications (0.045 fl oz (1.34 ml))



Virbac

Topical Solution for Dogs

EFFIPRO

Kills fleas, ticks, mosquitoes and chewing lice

For convenience, quick-acting, long-lasting, effective control of fleas, ticks, mosquitoes and chewing lice. Waterproof.

23 to 44.9 lbs

3 applications (0.045 fl oz (1.34 ml))

EFFIPRO

Topical Solution for Dogs

23 to 44.9 lbs

3 applications (0.045 fl oz (1.34 ml))

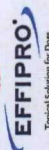

Topical Solution for Dogs

EFFIPRO

23 to 44.9 lbs

3 applications (0.045 fl oz (1.34 ml))

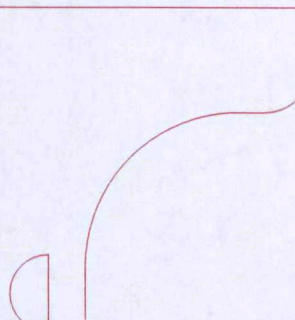

23 to 44.9 lbs

3 applications (0.045 fl oz (1.34 ml))

Directions for Use:

1. For the correct treatment with applicable flea, tick, and mosquito control, please refer to the label. Do not use other flea or tick treatments. DO NOT USE EFFIPRO ON CATS, DOGS, OR OTHER ANIMALS. READ DIRECTIONS CAREFULLY. DO NOT USE ON CATS, DOGS, OR OTHER ANIMALS. DO NOT USE ON CATS, DOGS, OR OTHER ANIMALS.

2. For killing fleas, all stages of fleas (eggs, larvae, pupae, and adults), American dog ticks, mosquitoes, and chewing lice, apply one (1) application of EFFIPRO to the back of the dog's neck (between the ears and the back of the neck).

3. For killing ticks, apply one (1) application of EFFIPRO to the back of the dog's neck (between the ears and the back of the neck).

4. For killing mosquitoes and chewing lice, apply one (1) application of EFFIPRO to the back of the dog's neck (between the ears and the back of the neck).

5. For killing fleas, apply one (1) application of EFFIPRO to the back of the dog's neck (between the ears and the back of the neck).

6. For killing ticks, apply one (1) application of EFFIPRO to the back of the dog's neck (between the ears and the back of the neck).

7. For killing mosquitoes and chewing lice, apply one (1) application of EFFIPRO to the back of the dog's neck (between the ears and the back of the neck).

8. For killing fleas, apply one (1) application of EFFIPRO to the back of the dog's neck (between the ears and the back of the neck).

9. For killing ticks, apply one (1) application of EFFIPRO to the back of the dog's neck (between the ears and the back of the neck).

10. For killing mosquitoes and chewing lice, apply one (1) application of EFFIPRO to the back of the dog's neck (between the ears and the back of the neck).

220P35

EFFIPRO® Topical Solution for Dogs
Only for use on dogs 23-44.9 lbs / 0.045 fl oz
Contains fipronil (9.6%)
KEEP OUT OF REACH OF CHILDREN
CAUTION
See full label for additional directions
EPA Reg. No. 2382-185

EFFIPRO® Topical Solution for Dogs
Only for use on dogs 23-44.9 lbs / 0.045 fl oz
Contains fipronil (9.6%)
KEEP OUT OF REACH OF CHILDREN
CAUTION
See full label for additional directions
EPA Reg. No. 2382-185

EFFIPRO® Topical Solution for Dogs
Only for use on dogs 23-44.9 lbs / 0.045 fl oz
Contains fipronil (9.6%)
KEEP OUT OF REACH OF CHILDREN
CAUTION
See full label for additional directions
EPA Reg. No. 2382-185

230A35

Virbac

EFFIPRO®

Topical Solution for Dogs

Only for use on dogs

23-44.9 lbs

0.045 fl oz (1.34 mL)

Contains fipronil (9.6%)

KEEP OUT OF REACH

OF CHILDREN

CAUTION

See full label for
additional directions

EPA Reg. No. 2382-185

24 of 35

PIPF

PIPF

EFFIPRO®
Topical Solution for Dogs

1 applicator 0.091 fl oz (2.68 mL) Use only on dogs

EFFIPRO®

Topical Solution for Dogs

Only for dogs and puppies
8 weeks old or older weighing
45 to 88.9 lbs

Virbac

Virbac AH, INC., PO BOX 162059
FORT WORTH, TX 76161, 1-800-338-3659

Made in France

EPA Reg. No. 2382-185
EFFIPRO® is a registered trademark of Virbac S.A. EPA Est. No. 2382-FRA-1

1 applicator 0.091 fl oz (2.68 mL)

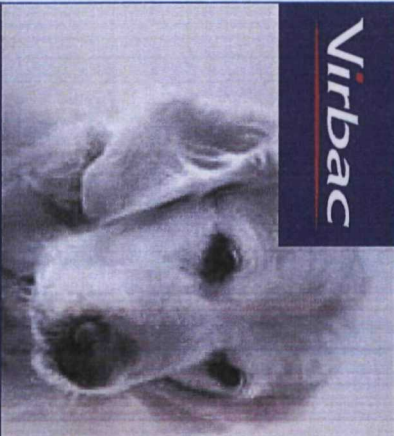

Virbac

Only for dogs and puppies
8 weeks old or older weighing
45 to 88.9 lbs

EFFIPRO®
Topical Solution for Dogs
Kills fleas, ticks,
mosquitoes and chewing lice

ACTIVE INGREDIENT
Fipronil..... 9.6%
OTHER INGREDIENTS..... 90.4%
TOTAL..... 100.0%

Only for dogs
and puppies
8 weeks old or
older weighing
45 to 88.9 lbs

KEEP OUT OF REACH OF CHILDREN
CAUTION

EFFIPRO®

Topical Solution for Dogs

FOR USE ONLY ON DOGS AND PUPPIES 8 WEEKS OLD OR OLDER

EFFIPRO® Topical Solution for Dogs contains the active ingredient fipronil, which controls infestations caused by fleas, ticks, mosquitoes and chewing lice on dogs 8 weeks old or older.

1 applicator 0.091 fl oz (2.68 mL)

KEEP OUT OF REACH OF CHILDREN
CAUTION

READ ENTIRE LABEL BEFORE EACH USE

PRECAUTIONARY STATEMENTS

HAZARDS TO HUMANS AND DOMESTIC ANIMALS

HAZARDS TO HUMANS: Harmful if swallowed. Causes eye irritation. Avoid contact with skin, eyes, or clothing. Wash hands thoroughly with soap and water after handling and before eating, drinking, chewing gum, using tobacco, or using the toilet.

HAZARDS TO DOMESTIC ANIMALS: For external use only. Do not use on puppies under 8 weeks of age. Individual sensitivities, while rare, may occur after using ANY pesticide product. Possible temporary irritation may occur at the site where EFFIPRO® Topical Solution for Dogs was applied. Contact a veterinarian immediately if signs become persistent or become more severe during the first few days following application. If an unusual reaction is observed following initial application, a veterinarian should be consulted before repeating application. Certain medications can interact with pesticides. Consult a veterinarian before using on medicated, debilitated or aged dogs.

See enclosed insert for directions for use and storage and disposal.

IF SWALLOWED:	FIRST AID • Call a poison control center or doctor immediately for treatment advice. • Have person sip a glass of water if able to swallow. • Do not induce vomiting unless told to do so by a poison control center or doctor. • Do not give anything by mouth to an unconscious person. • Hold eye open and rinse slowly and gently with water for 15-20 minutes. • Remove contact lenses, if present, after the first 5 minutes, then continue rinsing eye. • Call a poison control center or doctor for treatment advice.
IF IN EYES:	• Take off contaminated clothing. • Rinse skin immediately with plenty of water for 15-20 minutes. • Call a poison control center or doctor for treatment advice.
IF ON SKIN OR CLOTHING:	• Have product container or label with you when calling a poison control center or doctor, or going for treatment. You may also contact the Hotline number 1-800-338-3659 for human and veterinary health concerns, emergency medical treatment information or pesticide incidents.

Lot No.:

250235

EFFIPRO®
Topical Solution for Dogs

Virbac

Only for dogs and puppies 8 weeks old or older weighing 45 to 88.9 lbs (3 applicators 0.091 fl oz (2.68 ml))



EFFIPRO®
Topical Solution for Dogs

Virbac

Only for dogs and puppies 8 weeks old or older weighing 45 to 88.9 lbs (3 applicators 0.091 fl oz (2.68 ml))

Let No.:

EFFIPRO®
Topical Solution for Dogs

ACTIVE INGREDIENTS: ...
INERT INGREDIENTS: ...
TOTAL VOLUME: ...

PRECAUTIONS: ...
STORAGE AND DISPOSAL: ...
KEEP OUT OF REACH OF CHILDREN.

EFFIPRO®
Topical Solution for Dogs

45 to 88.9 lbs
3 applicators 0.091 fl oz (2.68 ml)

Only for dogs and puppies 8 weeks old or older weighing 45 to 88.9 lbs (3 applicators 0.091 fl oz (2.68 ml))

EFFIPRO®
Topical Solution for Dogs

3 applicators 0.091 fl oz (2.68 ml)

EFFIPRO®
Topical Solution for Dogs

Virbac

Only for dogs and puppies 8 weeks old or older weighing 45 to 88.9 lbs (3 applicators 0.091 fl oz (2.68 ml))

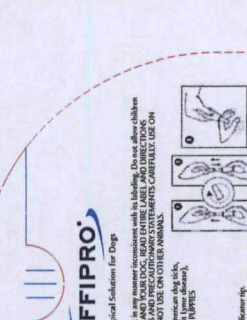

EFFIPRO®
Topical Solution for Dogs

Virbac

Only for dogs and puppies 8 weeks old or older weighing 45 to 88.9 lbs (3 applicators 0.091 fl oz (2.68 ml))

Let No.:

EFFIPRO®
Topical Solution for Dogs

ACTIVE INGREDIENTS: ...
INERT INGREDIENTS: ...
TOTAL VOLUME: ...

PRECAUTIONS: ...
STORAGE AND DISPOSAL: ...
KEEP OUT OF REACH OF CHILDREN.

EFFIPRO®
Topical Solution for Dogs

45 to 88.9 lbs
3 applicators 0.091 fl oz (2.68 ml)

Only for dogs and puppies 8 weeks old or older weighing 45 to 88.9 lbs (3 applicators 0.091 fl oz (2.68 ml))

EFFIPRO®
Topical Solution for Dogs

3 applicators 0.091 fl oz (2.68 ml)

EFFIPRO®
Topical Solution for Dogs

Virbac

Only for dogs and puppies 8 weeks old or older weighing 45 to 88.9 lbs (3 applicators 0.091 fl oz (2.68 ml))



EFFIPRO®
Topical Solution for Dogs

Virbac

Only for dogs and puppies 8 weeks old or older weighing 45 to 88.9 lbs (3 applicators 0.091 fl oz (2.68 ml))

Let No.:

EFFIPRO®
Topical Solution for Dogs

ACTIVE INGREDIENTS: ...
INERT INGREDIENTS: ...
TOTAL VOLUME: ...

PRECAUTIONS: ...
STORAGE AND DISPOSAL: ...
KEEP OUT OF REACH OF CHILDREN.

EFFIPRO®
Topical Solution for Dogs

45 to 88.9 lbs
3 applicators 0.091 fl oz (2.68 ml)

Only for dogs and puppies 8 weeks old or older weighing 45 to 88.9 lbs (3 applicators 0.091 fl oz (2.68 ml))

EFFIPRO®
Topical Solution for Dogs

3 applicators 0.091 fl oz (2.68 ml)

Virbac

EFFIPRO
Topical Solution for Dogs

Only for dogs and puppies
8 weeks old or older weighing
45 to 88.9 lbs

16 applications, 0.931 fl. oz. (2.68 mL)



Virbac

EFFIPRO
Topical Solution for Dogs

Only for dogs and puppies
8 weeks old or older weighing
45 to 88.9 lbs

16 applications, 0.931 fl. oz. (2.68 mL)



Virbac

EFFIPRO
Topical Solution for Dogs

Only for dogs and puppies
8 weeks old or older weighing
45 to 88.9 lbs

16 applications, 0.931 fl. oz. (2.68 mL)



EFFIPRO

Virbac

Topical Solution for Dogs

Only for dogs and puppies
8 weeks old or older weighing
45 to 88.9 lbs

16 applications, 0.931 fl. oz. (2.68 mL)



Virbac

EFFIPRO
Topical Solution for Dogs

Only for dogs and puppies
8 weeks old or older weighing
45 to 88.9 lbs

16 applications, 0.931 fl. oz. (2.68 mL)



Species	Weight	Volume
Dogs	45 to 88.9 lbs	0.931 fl. oz. (2.68 mL)
Puppies	8 weeks old or older	0.931 fl. oz. (2.68 mL)

280435

EFFIPRO® Topical Solution for Dogs
Only for use on dogs 45-88.9 lbs / 0.091 fl oz
Contains fipronil (9.6%)
KEEP OUT OF REACH OF CHILDREN
CAUTION
See full label for additional directions
EPA Reg. No. 2382-185



EFFIPRO® Topical Solution for Dogs
Only for use on dogs 45-88.9 lbs / 0.091 fl oz
Contains fipronil (9.6%)
KEEP OUT OF REACH OF CHILDREN
CAUTION
See full label for additional directions
EPA Reg. No. 2382-185



EFFIPRO® Topical Solution for Dogs
Only for use on dogs 45-88.9 lbs / 0.091 fl oz
Contains fipronil (9.6%)
KEEP OUT OF REACH OF CHILDREN
CAUTION
See full label for additional directions
EPA Reg. No. 2382-185



Virbac

EFFIPRO®

Topical Solution for Dogs

Only for use on dogs

45-88.9 lbs

0.091 fl oz (2.68 mL)

Contains fipronil (9.6%)

KEEP OUT OF REACH

OF CHILDREN

CAUTION

See full label for

additional directions

EPA Reg. No. 2382-185

30 of 35

1 applicator 0.136 fl oz (4.02 mL)



EFFIPRO®
Topical Solution for Dogs

1 applicator 0.136 fl oz (4.02 mL) Use only on dogs

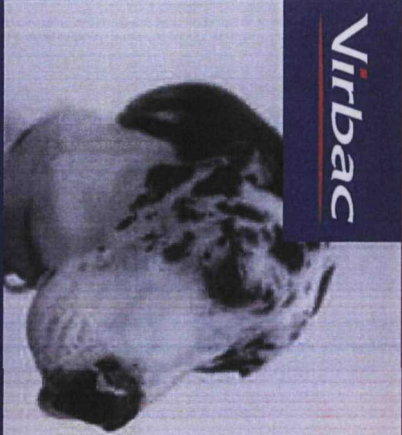

Virbac
Topical Solution for Dogs

EFFIPRO®
Topical Solution for Dogs
Kills fleas, ticks,
mosquitoes and chewing lice

**KEEP OUT OF REACH OF CHILDREN
CAUTION**

See back panel for additional precautionary statements.

EFFIPRO®
Topical Solution for Dogs

FOR USE ONLY ON DOGS AND PUPPIES 8 WEEKS OLD OR OLDER

EFFIPRO® Topical Solution for Dogs contains the active ingredient fipronil, which controls infestations caused by fleas, ticks, mosquitoes and chewing lice on dogs 8 weeks old or older.

1 applicator 0.136 fl oz (4.02 mL)

**Only for dogs and puppies
8 weeks old or older weighing
89 to 132 lbs**

**Only for dogs
and puppies
8 weeks old or
older weighing
89 to 132
lbs**

Virbac AH, Inc., PO BOX 162059
FORT WORTH, TX 76161 1-800-338-3659
EPA Reg. No. 2382-FRA-1

Made in France
EFFIPRO® is a registered trademark of Virbac S.A.
EPA Est. No. 2382-FRA-1

EFFIPRO®
Topical Solution for Dogs

**Only for dogs and puppies
8 weeks old or older weighing
89 to 132 lbs**

**KEEP OUT OF REACH OF CHILDREN
CAUTION**

READ ENTIRE LABEL BEFORE EACH USE

PRECAUTIONARY STATEMENTS
HAZARDS TO HUMANS AND DOMESTIC ANIMALS
HAZARDS TO HUMANS: Harmful if swallowed. Causes eye irritation. Avoid contact with skin, eyes, or clothing. Wash hands thoroughly with soap and water after handling and before eating, drinking, chewing gum, using tobacco, or using the toilet.
HAZARDS TO DOMESTIC ANIMALS: For external use only. Do not use on puppies under 8 weeks of age. Individual sensitivities, while rare, may occur after using ANY pesticide product. Possible temporary irritation may occur at the site where EFFIPRO® Topical Solution for Dogs was applied. Contact a veterinarian immediately if signs become persistent or become more severe during the first few days following application. If an unusual reaction is observed following initial application, a veterinarian should be consulted before repeating application. Certain medications can interact with pesticides. Consult a veterinarian before using on medicated, debilitated or aged dogs.

See enclosed insert for directions for use and storage and disposal.

FIRST AID	
IF SWALLOWED:	<ul style="list-style-type: none"> • Call a poison control center or doctor immediately for treatment advice. • Have person sip a glass of water if able to swallow. • Do not induce vomiting unless told to do so by a poison control center or doctor. • Do not give anything by mouth to an unconscious person.
IF IN EYES:	<ul style="list-style-type: none"> • Hold eye open and rinse slowly and gently with water for 15-20 minutes. • Remove contact lenses, if present, after the first 5 minutes, then continue rinsing eye. • Call a poison control center or doctor for treatment advice.
IF ON SKIN OR CLOTHING:	<ul style="list-style-type: none"> • Take off contaminated clothing. • Rinse skin immediately with plenty of water for 15-20 minutes. • Call a poison control center or doctor for treatment advice.

Have product container or label with you when calling a poison control center or doctor or going for treatment. You may also contact the Hotline number 1-800-338-3659 for human and veterinary health concerns, emergency medical treatment information or pesticide incidents.

Lot No.:

EFFIPRO®
Topical Solution for Dogs



Virbac

EFFIPRO®
Topical Solution for Dogs

Kills fleas, ticks, mosquitoes and chewing lice

For convenient, quick application, simply spray the solution on the back of your dog's neck, effective control of fleas, ticks, mosquitoes and chewing lice

Whisper!

Only for dogs 8 weeks of age or older. Apply to the back of the neck. 8 weeks of age or older. Apply to the back of the neck.

89 to 132 lbs

3 applicators (0.136 fl oz (4.07 mL))

EFFIPRO®
Topical Solution for Dogs

89 to 132 lbs

3 applicators (0.136 fl oz (4.07 mL))

EFFIPRO®
Topical Solution for Dogs

89 to 132 lbs

3 applicators (0.136 fl oz (4.07 mL))

Virbac

EFFIPRO®
Topical Solution for Dogs

89 to 132 lbs

3 applicators (0.136 fl oz (4.07 mL))

Virbac

Lot No. _____

ACTIVE INGREDIENT.....0.66%
OTHER INGREDIENTS.....99.34%
TOTAL.....100.00%

# FUR FLEAS	Apply to the back of the neck and rub gently into the fur. Do not wash or bat for 24 hours after application. Do not use on cats or other animals.
# TICKS	Apply to the back of the neck and rub gently into the fur. Do not wash or bat for 24 hours after application. Do not use on cats or other animals.
# CHewing LICE	Apply to the back of the neck and rub gently into the fur. Do not wash or bat for 24 hours after application. Do not use on cats or other animals.
# MOSQUITOES	Apply to the back of the neck and rub gently into the fur. Do not wash or bat for 24 hours after application. Do not use on cats or other animals.

CAUTION
Keep out of reach of children. Do not use on cats or other animals. Do not use on dogs with open wounds or skin irritation. Do not use on dogs with known hypersensitivity to any of the ingredients. Do not use on dogs with known hypersensitivity to any of the ingredients.

EFFIPRO®
Topical Solution for Dogs

89 to 132 lbs

3 applicators (0.136 fl oz (4.07 mL))

EFFIPRO®
Topical Solution for Dogs

89 to 132 lbs

3 applicators (0.136 fl oz (4.07 mL))

Virbac

Lot No. _____

ACTIVE INGREDIENT.....0.66%
OTHER INGREDIENTS.....99.34%
TOTAL.....100.00%

# FUR FLEAS	Apply to the back of the neck and rub gently into the fur. Do not wash or bat for 24 hours after application. Do not use on cats or other animals.
# TICKS	Apply to the back of the neck and rub gently into the fur. Do not wash or bat for 24 hours after application. Do not use on cats or other animals.
# CHewing LICE	Apply to the back of the neck and rub gently into the fur. Do not wash or bat for 24 hours after application. Do not use on cats or other animals.
# MOSQUITOES	Apply to the back of the neck and rub gently into the fur. Do not wash or bat for 24 hours after application. Do not use on cats or other animals.

CAUTION
Keep out of reach of children. Do not use on cats or other animals. Do not use on dogs with open wounds or skin irritation. Do not use on dogs with known hypersensitivity to any of the ingredients. Do not use on dogs with known hypersensitivity to any of the ingredients.

EFFIPRO®
Topical Solution for Dogs

89 to 132 lbs

3 applicators (0.136 fl oz (4.07 mL))

EFFIPRO®
Topical Solution for Dogs

89 to 132 lbs

3 applicators (0.136 fl oz (4.07 mL))

Virbac

DIRECTIONS FOR USE
Apply to the back of the neck and rub gently into the fur. Do not wash or bat for 24 hours after application. Do not use on cats or other animals.

APPLICATION DIRECTIONS
1. Remove cap applicator from packaging.
2. Insert cap applicator into the back of the neck and rub gently into the fur.
3. Repeat for the other side of the neck.

CAUTION
Keep out of reach of children. Do not use on cats or other animals. Do not use on dogs with open wounds or skin irritation. Do not use on dogs with known hypersensitivity to any of the ingredients. Do not use on dogs with known hypersensitivity to any of the ingredients.

EFFIPRO®
Topical Solution for Dogs

89 to 132 lbs

3 applicators (0.136 fl oz (4.07 mL))

Virbac

CAUTION
Keep out of reach of children. Do not use on cats or other animals. Do not use on dogs with open wounds or skin irritation. Do not use on dogs with known hypersensitivity to any of the ingredients. Do not use on dogs with known hypersensitivity to any of the ingredients.

EFFIPRO®
Topical Solution for Dogs

89 to 132 lbs

3 applicators (0.136 fl oz (4.07 mL))

Virbac

EFFIPRO

Topical Solution for Dogs

Only for Dogs and Puppies 8 weeks old and older. 89 to 132 lbs

36 applications (0.138 fl oz (4.02 mL))



Virbac

EFFIPRO

Topical Solution for Dogs

Only for Dogs and Puppies 8 weeks old and older. 89 to 132 lbs



Virbac

EFFIPRO

Topical Solution for Dogs

Only for Dogs and Puppies 8 weeks old and older. 89 to 132 lbs

36 applications (0.138 fl oz (4.02 mL))



Virbac

EFFIPRO

Topical Solution for Dogs

Only for Dogs and Puppies 8 weeks old and older. 89 to 132 lbs

36 applications (0.138 fl oz (4.02 mL))

CAUTION: Do not use on cats, horses, or other animals. Do not use on dogs with known hypersensitivity to any of the ingredients. Do not use on dogs with known hypersensitivity to any of the ingredients. Do not use on dogs with known hypersensitivity to any of the ingredients.

Weight	Volume	Number of Applications
89 to 132 lbs	0.138 fl oz (4.02 mL)	36

Virbac

EFFIPRO

Topical Solution for Dogs

Only for Dogs and Puppies 8 weeks old and older. 89 to 132 lbs

36 applications (0.138 fl oz (4.02 mL))



34 of 35

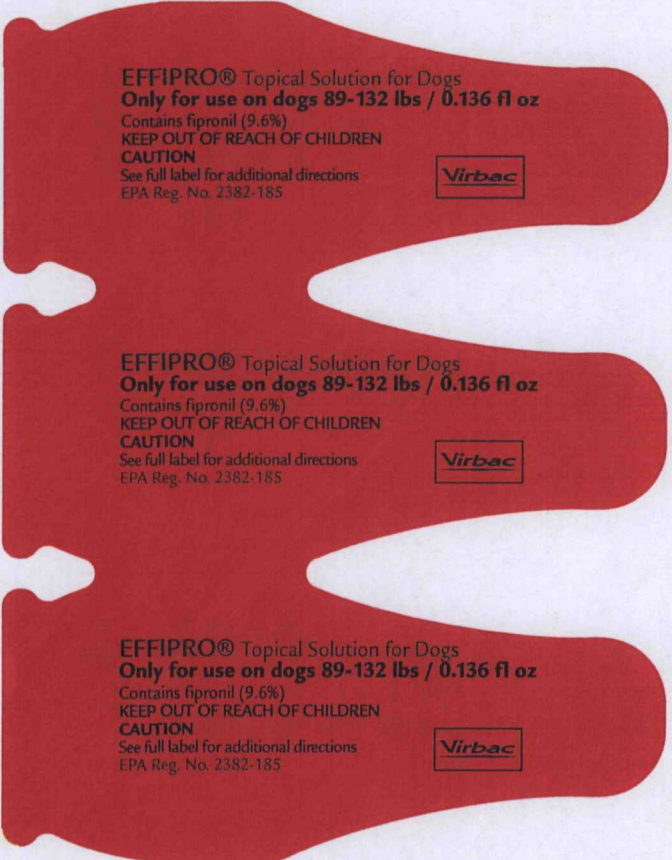

EFFIPRO® Topical Solution for Dogs
Only for use on dogs 89-132 lbs / 0.136 fl oz
Contains fipronil (9.6%)
KEEP OUT OF REACH OF CHILDREN
CAUTION
See full label for additional directions
EPA Reg. No. 2382-185



EFFIPRO® Topical Solution for Dogs
Only for use on dogs 89-132 lbs / 0.136 fl oz
Contains fipronil (9.6%)
KEEP OUT OF REACH OF CHILDREN
CAUTION
See full label for additional directions
EPA Reg. No. 2382-185



EFFIPRO® Topical Solution for Dogs
Only for use on dogs 89-132 lbs / 0.136 fl oz
Contains fipronil (9.6%)
KEEP OUT OF REACH OF CHILDREN
CAUTION
See full label for additional directions
EPA Reg. No. 2382-185



Virbac

EFFIPRO®

Topical Solution for Dogs

Only for use on dogs

89-132 lbs

0.136 fl oz (4.02 mL)

Contains fipronil (9.6%)

KEEP OUT OF REACH

OF CHILDREN

CAUTION

See full label for

additional directions

EPA Reg. No. 2382-185