

US EPA ARCHIVE DOCUMENT

**DRAFT**

**Coal Combustion Residue Impoundment  
Round 9 - Dam Assessment Report**

*Clinch River Power Plant*  
*Ash Pond Management Units*  
*Appalachian Power*  
*d/b/a American Electric Power*  
**Carbo, VA**

**Prepared for:**

United States Environmental Protection Agency  
Office of Resource Conservation and Recovery

**Prepared by:**

Dewberry & Davis, LLC  
Fairfax, Virginia



Under Contract Number: EP-09W001727

**April 2011**

# DRAFT

## INTRODUCTION, SUMMARY CONCLUSIONS AND RECOMMENDATIONS

The release of over five million cubic yards of coal combustion waste from the Tennessee Valley Authority's Kingston, Tennessee facility in December 2008 flooded more than 300 acres of land, damaging homes and property. In response the U.S. EPA is assessing the stability and functionality of coal combustion ash impoundments and other management units across the country and, as necessary, identifying any needed corrective measures.

This assessment of the stability and functionality of the Clinch River Power Station Ash Pond Management Units (Bottom Ash Pond 1A/1B and Bottom Ash Pond 2) is based on a review of available documents and site assessment conducted by Dewberry personnel on February 17, 2011. In general, we found the supporting technical documentation provided to be adequate for preparation of this report (Section 1.1.3). For the purpose of this report, Bottom Ash Pond 1A/1B is defined as Ash Pond 1 and Bottom Ash Pond 2 is defined as Ash Pond 2. In summary, Ash Pond 1 and Ash Pond 2 are FAIR for continued safe and reliable operation.

## PURPOSE AND SCOPE

The U.S. Environmental Protection Agency (EPA) is embarking on an initiative to investigate the potential for catastrophic failure of Coal Combustion Surface Impoundments (i.e., management unit) from occurring at electric utilities in an effort to protect lives and property from the consequences of a dam failure or the improper release of impounded slurry. The EPA initiative is intended to identify conditions that may adversely affect the structural stability and functionality of a management unit and its appurtenant structures (if present); to note the extent of deterioration (if present), status of maintenance and/or a need for immediate repair; to evaluate conformity with current design and construction practices; and to determine the hazard potential classification for units not currently classified by the management unit owner or by a state or federal agency. The initiative will address management units that are classified as having a Less-than-Low, Low, Significant or High Hazard Potential ranking. (For Classification, see pp. 3-8 of the 2004 Federal Guidelines for Dam Safety)

In early 2009 the EPA sent its first wave of letters to coal-fired electric utilities seeking information on the safety of surface impoundments and similar facilities that receive liquid-borne material that store or dispose of coal combustion residue. This letter was issued under the authority of the Comprehensive Environmental Response, Compensation, and Liability Act (CERCLA) Section 104(e), to assist the Agency in assessing the structural stability and functionality of such management units, including which facilities should be visited to perform a safety assessment of the berms, dikes, and dams used in the construction of these impoundments.

# DRAFT

EPA requested that utility companies identify all management units including surface impoundments or similar diked or bermed management units or management units designated as landfills that receive liquid-borne material used for the storage or disposal of residuals or by-products from the combustion of coal, including, but not limited to, fly ash, bottom ash, boiler slag, or flue gas emission control residuals. Utility companies provided information on the size, design, age and the amount of material placed in the units. The EPA used the information received from the utilities to determine preliminarily which management units had or potentially could have High Hazard Potential ranking.

The purpose of this report is **to evaluate the condition and potential of residue release from management units for hazard potential classification**. This evaluation included a site visit. Prior to conducting the site visit, a two-person team reviewed the information submitted to EPA, reviewed any relevant publicly available information from state or federal agencies regarding the unit hazard potential classification (if any) and accepted information provided via telephone communication with the management unit Owner (Appalachian Power d/b/a American Electric Power). Also, after the field visit, additional information was received by Dewberry & Davis LLC from the Owner about the Clinch River Ash Pond Management Units. The additional information was reviewed and also used in preparation of this report.

Factors considered in determining the hazard potential classification of the management units(s) included the age and size of the impoundment, the quantity of coal combustion residuals or by-products that were stored or disposed of in these impoundments, its past operating history, and its geographic location relative to down gradient population centers and/or sensitive environmental systems.

This report presents the opinion of the assessment team as to the potential of catastrophic failure and reports on the condition of the management unit(s).

## LIMITATIONS

The assessment of dam safety reported herein is based on field observations and review of readily available information provided by the owner/operator of the subject coal combustion residue management unit(s). Qualified Dewberry engineering personnel performed the field observations and review and made the assessment in conformance with the required scope of work and in accordance with reasonable and acceptable engineering practices. No other warranty, either written or implied, is made with regard to our assessment of dam safety.

# DRAFT

## Table of Contents

|  | <u>Page</u> |
|--|-------------|
| INTRODUCTION, SUMMARY CONCLUSIONS AND RECOMMENDATIONS.....                                     | ii          |
| PURPOSE AND SCOPE .....  | ii          |
| <b>1.0 CONCLUSIONS AND RECOMMENDATIONS .....</b>   | <b>1-1</b>  |
| 1.1 CONCLUSIONS .....  | 1-1         |
| 1.1.1 Conclusions Regarding the Structural Soundness of the Management Unit(s) .....           | 1-1         |
| 1.1.2 Conclusions Regarding the Hydrologic/Hydraulic Safety of the Management Unit(s) .....    | 1-1         |
| 1.1.3 Conclusions Regarding the Adequacy of Supporting Technical Documentation.....            | 1-1         |
| 1.1.4 Conclusions Regarding the Description of the Management Unit(s).....                     | 1-2         |
| 1.1.5 Conclusions Regarding the Field Observations .....                                       | 1-2         |
| 1.1.6 Conclusions Regarding the Adequacy of Maintenance and Methods of Operation .....         | 1-2         |
| 1.1.7 Conclusions Regarding the Adequacy of the Surveillance and Monitoring Program.....       | 1-2         |
| 1.1.8 Classification Regarding Suitability for Continued Safe and Reliable Operation .....     | 1-2         |
| 1.2 RECOMMENDATIONS .....  | 1-3         |
| 1.2.1 Recommendations Regarding the Structural Stability.....                                  | 1-3         |
| 1.2.2 Recommendations Regarding the Hydrologic/Hydraulic Safety.....                           | 1-3         |
| 1.2.3 Recommendations Regarding the Maintenance and Methods of Operation .....                 | 1-3         |
| 1.2.4 Recommendations Regarding Continued Safe and Reliable Operation.....                     | 1-4         |
| 1.3 PARTICIPANTS AND ACKNOWLEDGEMENT .....   | 1-4         |
| 1.3.1 List of Participants: .....  | 1-4         |
| 1.3.2 Acknowledgement and Signature.....   | 1-4         |
| <b>2.0 DESCRIPTION OF THE COAL COMBUSTION RESIDUE MANAGEMENT UNIT(S).....</b>                  | <b>2-1</b>  |
| 2.1 LOCATION AND GENERAL DESCRIPTION .....   | 2-1         |
| 2.2 COAL COMBUSTION RESIDUE HANDLING .....   | 2-2         |
| 2.2.1 Fly Ash.....   | 2-2         |
| 2.2.2 Bottom Ash .....   | 2-3         |
| 2.3 SIZE AND HAZARD CLASSIFICATION .....   | 2-3         |
| 2.4 AMOUNT AND TYPE OF RESIDUALS CURRENTLY CONTAINED IN THE UNIT(S) AND MAXIMUM CAPACITY ..... | 2-4         |
| 2.5 PRINCIPAL PROJECT STRUCTURES .....   | 2-4         |
| 2.5.1 Earth Embankment .....   | 2-4         |
| 2.5.2 Outlet Structures.....   | 2-5         |
| 2.6 CRITICAL INFRASTRUCTURE WITHIN FIVE MILES DOWN GRADIENT .....                              | 2-6         |
| <b>3.0 SUMMARY OF RELEVANT REPORTS, PERMITS, AND INCIDENTS .....</b>                           | <b>3-1</b>  |
| 3.1 SUMMARY OF LOCAL, STATE, AND FEDERAL ENVIRONMENTAL PERMITS.....                            | 3-1         |
| 3.2 SUMMARY OF SPILL/RELEASE INCIDENTS .....   | 3-1         |
| <b>4.0 SUMMARY OF HISTORY OF CONSTRUCTION AND OPERATION.....</b>                               | <b>4-1</b>  |
| 4.1 SUMMARY OF CONSTRUCTION HISTORY .....  | 4-1         |
| 4.1.1 Original Construction .....  | 4-1         |
| 4.1.2 Significant Changes/Modifications in Design since Original Construction.....             | 4-1         |
| 4.1.3 Significant Repairs/Rehabilitation since Original Construction .....                     | 4-2         |

# DRAFT

|            |   |            |
|------------|---|------------|
| 4.2        | SUMMARY OF OPERATIONAL PROCEDURES .....   | 4-2        |
| 4.2.1      | <i>Original Operational Procedures</i> .....                                    | 4-2        |
| 4.2.2      | <i>Significant Changes in Operational Procedures and Original Startup</i> ..... | 4-2        |
| 4.2.3      | <i>Current Operational Procedures</i> .....                                     | 4-3        |
| 4.2.4      | <i>Other Notable Events since Original Startup</i> .....                        | 4-3        |
| <b>5.0</b> | <b>FIELD OBSERVATIONS.....</b>  | <b>5-1</b> |
| 5.1        | PROJECT OVERVIEW AND SIGNIFICANT FINDINGS.....                                  | 5-1        |
| 5.2        | ASH POND 1 .....  | 5-1        |
| 5.2.1      | <i>Crest</i> .....  | 5-1        |
| 5.2.2      | <i>Upstream/Inside Slope</i> .....  | 5-2        |
| 5.2.3      | <i>Downstream/Outside Slope and Toe</i> .....                                   | 5-3        |
| 5.2.4      | <i>Abutments and Groin Areas</i> .....  | 5-5        |
| 5.3        | ASH POND 2 .....  | 5-7        |
| 5.3.1      | <i>Crest</i> .....  | 5-7        |
| 5.3.2      | <i>Upstream/Inside Slope</i> .....  | 5-9        |
| 5.3.3      | <i>Downstream/Outside Slope and Toe</i> .....                                   | 5-9        |
| 5.3.4      | <i>Abutments and Groin Areas</i> .....  | 5-11       |
| 5.4        | OUTLET STRUCTURES .....   | 5-11       |
| 5.4.1      | <i>Overflow Structure</i> .....   | 5-11       |
| 5.4.2      | <i>Outlet Conduit</i> .....   | 5-13       |
| <b>6.0</b> | <b>HYDROLOGIC/HYDRAULIC SAFETY .....</b>  | <b>6-1</b> |
| 6.1        | SUPPORTING TECHNICAL DOCUMENTATION .....  | 6-1        |
| 6.1.1      | <i>Flood of Record</i> .....  | 6-1        |
| 6.1.2      | <i>Inflow Design Flood</i> .....  | 6-1        |
| 6.1.3      | <i>Spillway Rating</i> .....  | 6-1        |
| 6.1.4      | <i>Downstream Flood Analysis</i> .....  | 6-1        |
| 6.2        | ADEQUACY OF SUPPORTING TECHNICAL DOCUMENTATION .....                            | 6-1        |
| 6.3        | ASSESSMENT OF HYDROLOGIC/HYDRAULIC SAFETY .....                                 | 6-1        |
| <b>7.0</b> | <b>STRUCTURAL STABILITY.....</b>  | <b>7-1</b> |
| 7.1        | SUPPORTING TECHNICAL DOCUMENTATION .....  | 7-1        |
| 7.1.1      | <i>Stability Analyses and Load Cases Analyzed</i> .....                         | 7-1        |
| 7.1.2      | <i>Design Parameters and Dam Materials</i> .....                                | 7-1        |
| 7.1.3      | <i>Uplift and/or Phreatic Surface Assumptions</i> .....                         | 7-2        |
| 7.1.4      | <i>Factors of Safety and Base Stresses</i> .....                                | 7-2        |
| 7.1.5      | <i>Liquefaction Potential</i> .....   | 7-3        |
| 7.1.6      | <i>Critical Geological Conditions</i> .....                                     | 7-3        |
| 7.2        | ADEQUACY OF SUPPORTING TECHNICAL DOCUMENTATION .....                            | 7-4        |
| 7.3        | ASSESSMENT OF STRUCTURAL STABILITY .....  | 7-4        |
| <b>8.0</b> | <b>ADEQUACY OF MAINTENANCE AND METHODS OF OPERATION .....</b>                   | <b>8-1</b> |
| 8.1        | OPERATING PROCEDURES .....  | 8-1        |
| 8.2        | MAINTENANCE OF THE DAM AND PROJECT FACILITIES .....                             | 8-1        |
| 8.3        | ASSESSMENT OF MAINTENANCE AND METHODS OF OPERATIONS .....                       | 8-1        |

# DRAFT

|            |  |            |
|------------|--|------------|
| 8.3.1      | <i>Adequacy of Operating Procedures</i> .....                | 8-1        |
| 8.3.2      | <i>Adequacy of Maintenance</i> .....                         | 8-1        |
| <b>9.0</b> | <b>ADEQUACY OF SURVEILLANCE AND MONITORING PROGRAM</b> ..... | <b>9-1</b> |
| 9.1        | SURVEILLANCE PROCEDURES .....                                | 9-1        |
| 9.2        | INSTRUMENTATION MONITORING .....                             | 9-1        |
| 9.3        | ASSESSMENT OF SURVEILLANCE AND MONITORING PROGRAM .....      | 9-1        |
| 9.3.1      | <i>Adequacy of Inspection Program</i> .....                  | 9-1        |
| 9.3.2      | <i>Adequacy of Instrumentation Monitoring Program</i> .....  | 9-1        |

# DRAFT

## EXHIBITS

- Exhibit 1: USGS Peak Streamflow, USGS 03524000 Clinch River at Cleveland, VA
- Exhibit 2: FEMA Russell County FIS Study, Table 1-Summary of Discharges.
- Exhibit 3: FEMA Russell County FIRM, Map Number 51167C0215C
- Exhibit 4: FEMA Russell County FIRM, Map Number 51167C0205C
- Exhibit 5: USGS Seismic-Hazard Map for Central/Eastern US, 2%/50Years, 2008

## APPENDIX A

- Document 1: Virginia DCR Inventory Number 16703 Certificate, Inventory Report and Operation & Maintenance Program
- Document 2: Virginia DCR Inventory Number 16702 Certificate, Inventory Report and Operation & Maintenance Program
- Document 3: DCR Inspection Email to AEP, 2008
- Document 4: Dam Safety Inspection Report, by Woodward-Clyde Consultants
- Document 5: Ash Pond 1 Stability Analysis, By AEP
- Document 6: Ash Pond 2 Design Summary for Final Closure, by BBC&M Engineering
- Document 7: Ash Pond 1 Construction of Cutoff Wall, by AEP
- Document 8: Clinch River Plant, Dike Inspection Checklist 2008
- Document 9: Clinch River Plant, Dike Inspection Checklist 2009
- Document 10: Clinch River Plant Ash Pond 1, Annual Dam & Dike Inspection Report, by AEP 2009
- Document 11: AEP Dam and Dike Inspection and Maintenance Program Summary
- Document 12: EPA Impoundment Inventory, in Response to February 2009 Letter
- Document 13: AEP's Annual Inspection Form & Report to VA DCR
- Document 14: Clinch River Plant Aerial Survey, Ash Pond 1
- Document 15: Clinch River Plant Aerial Survey, Ash Pond 2

## APPENDIX B

- Document 16: Ash Pond 1, Dam Inspection Check List Form
- Document 17: Ash Pond 2, Dam Inspection Check List Form



# DRAFT

## 1.0 CONCLUSIONS AND RECOMMENDATIONS

### 1.1 CONCLUSIONS

Conclusions are based on visual observations from a one-day site visit, February 17, 2011, and review of technical documentation provided by the Owner, which is provided in Appendix A.

#### 1.1.1 Conclusions Regarding the Structural Soundness of the Management Unit(s)

Ash Pond 1 and Ash Pond 2 did not show any areas of significant structural concern during the one-day site visit. The stability analysis report for Ash Pond 1 was prepared, signed and sealed by the Owner's engineers and indicates that the main perimeter dike for Ash Pond 1 is structurally sound. The stability analysis report for Ash Pond 2 was prepared, signed and sealed by BBC&M engineers and indicates that the main perimeter dike for Ash Pond 2 is structurally sound. It should be noted, however, that the stability analysis report for Ash Pond 2 assumed that only the ash in contact with the existing water table was saturated and not saturated to the top of the ash in the impoundment. This was assumed because at the time the Owner was considering a closure permit for Ash Pond 2 and that it would be capped and would function as a landfill. The Owner submitted the closure plan for Ash Pond 2 for regulatory approval in 2009 but has since retracted the plan.

#### 1.1.2 Conclusions Regarding the Hydrologic/Hydraulic Safety of the Management Unit(s)

Hydrologic/Hydraulic calculations were not provided for Ash Pond 1 or Ash Pond 2 so conclusions regarding hydrologic/hydraulic safety cannot be made at this time.

#### 1.1.3 Conclusions Regarding the Adequacy of Supporting Technical Documentation

The supporting technical documentation provided is adequate for preparation of this report. Data reviewed by Dewberry did not contain hydrologic/hydraulic calculations. Technical documentation reviewed in preparation of this report is provided in Appendix A.

# DRAFT

## 1.1.4 Conclusions Regarding the Description of the Management Unit(s)

The description of Ash Pond 1 and Ash Pond 2 provided by the Owner was an accurate representation of what Dewberry observed in the field.

## 1.1.5 Conclusions Regarding the Field Observations

Dewberry staff was provided adequate access to Ash Pond 1 and Ash Pond 2 to complete the field assessment. The visual assessment of the perimeter dikes for both ponds showed no significant signs of erosion, settlement or instability. Seepage was observed along the down slope of Ash Pond 1 but was well controlled with monitoring weirs. No seepage was observed at Ash Pond 2. The spillway for Ash Pond 1 appeared to be functioning properly and the spillway for Ash Pond 2 is currently not active.

During the field assessment it was noted that a large boulder had dislodged from the adjacent hillside and impacted one of the slurry pipes that conveys bottom ash to Ash Pond 1. This pipe showed no visible signs of leakage. Dewberry understands that the boulder would be removed and the pipe repaired as appropriate. No other indications of unsafe conditions or conditions needing immediate remedial action were noted during the one-day site visit.

## 1.1.6 Conclusions Regarding the Adequacy of Maintenance and Methods of Operation

Current operation and maintenance procedures appear adequate for Ash Pond 1. Operation and maintenance procedures were discontinued at Ash Pond 2 when it became inactive in 1998.

## 1.1.7 Conclusions Regarding the Adequacy of the Surveillance and Monitoring Program

Current surveillance and monitoring program procedures appear adequate for Ash Pond 1. Surveillance and monitoring procedures were discontinued at Ash Pond 2 when it became inactive in 1998.

## 1.1.8 Classification Regarding Suitability for Continued Safe and Reliable Operation

**Clinch River Ash Pond 1 and Ash Pond 2 are rated FAIR with acceptable performance expected under static and seismic loading**

# DRAFT

**conditions in accordance with applicable safety regulatory criteria. A hydrologic and hydraulic analysis is required for both facilities to demonstrate adequate hydrologic loading conditions. The Fair classification is based on the one-day visual assessment performed by Dewberry and supporting technical documentation provided in Appendix A of this report.**

## 1.2 RECOMMENDATIONS

### 1.2.1 Recommendations Regarding the Structural Stability

Maintain frequent inspections of Ash Pond 1 and resume inspections of Ash Pond 2 in accordance with Owner's current inspection program.

### 1.2.2 Recommendations Regarding the Hydrologic/Hydraulic Safety

A hydrologic and hydraulic analysis should be performed to evaluate the hydrologic/hydraulic safety of Ash Pond 1 and Ash Pond 2. The analysis should consider off-site drainage to Ash Pond 1 and Ash Pond 2 and should be in accordance with all requirements for such analyses as required by Virginia Department of Conservation and Recreation (VA DCR), Division of Dam Safety, including spillway capacity.

### 1.2.3 Recommendations Regarding the Maintenance and Methods of Operation

It is recommended that the Owner's inspection program be resumed for Ash Pond 2 until such a time the facility is formally closed through VA DCR, Division of Dam Safety.

It is recommended that all underbrush and trees be removed from the Ash Pond 2 perimeter dike in accordance with VA DCR, Division of Dam Safety requirements.

It is recommended that all animal burrows located along the perimeter dike of Ash Pond 1 and Ash Pond 2 be backfilled in accordance with standard geotechnical engineering practices for dams, and monitored for future reoccurrence.

It is recommended that the Owner perform an interior inspection of all outfall pipes from the Ash Pond 1 & 2 outlet structures to the reclaim pond as well as an interior inspection of the pipe systems that bypass off-site drainage through Ash Pond 1. Interior inspections should focus on the structural integrity of the pipes as well as seepage paths into and out of the

# DRAFT

pipes. The inspection report should summarize findings and remedial action required, if any.

## 1.2.4 Recommendations Regarding Continued Safe and Reliable Operation

No recommendations, other than the above studies and maintenance activities, appear warranted at this time.

## 1.3 PARTICIPANTS AND ACKNOWLEDGEMENT

### 1.3.1 List of Participants:

Gary Zych, American Electric Power,  
*Senior Engineer, Civil Engineering*  
Behrad Zand, American Electric Power  
*Engineer II, Geotechnical Engineering*  
Jim Saunders, American Electric Power  
*Glen Lynn Plant Director*  
Richard Chatin, American Electric Power  
Edwin Shelton, American Electric Power  
Thomas I. Roberts, PE, CFM, VA Dept. of Conservation & Recreation  
*Dam Safety Regional Engineer*  
Jim Kohler, United States Environmental Protections Agency  
*LCDR, Public Health Services*  
Patrick Kelly, United States Environmental Protections Agency  
*Public Health Services*  
Scott Clarke, P.E., Dewberry  
*Associate, Water Resources*  
Lorainne Ramos Nieves, P.E., CFM, Dewberry  
*Engineer III, Water Resources*

### 1.3.2 Acknowledgement and Signature

We acknowledge that the management units referenced herein was assessed on February 17, 2011.

---

Scott Clarke, P.E.

---

Lorainne Ramos Nieves, P.E.,CFM

# DRAFT

## 2.0 DESCRIPTION OF THE COAL COMBUSTION RESIDUE MANAGEMENT UNIT(S)

### 2.1 LOCATION AND GENERAL DESCRIPTION

The Clinch River Power Plant, owned and operated by Appalachian Power d/b/a American Electric Power, is located on the Clinch River in Russell County, Virginia off Route 665 near the town of Carbo, see Figure 2.1-1, Location Map and Figure 2.1-2, Aerial Photograph. The Plant functions as a coal-fired electric power station, operating since 1958, and consists of three 235 megawatt generator units.

The Plant contains two management units for storing CCR: Ash Pond 1 and Ash Pond 2. Ash Pond 1 is a multi-cell pond composed of Pond 1A and Pond 1B. Ash Pond 2 is a single-cell pond that is currently inactive and does not receive CCR. Table 2.1 provides some general dimensions of both Ash Ponds.

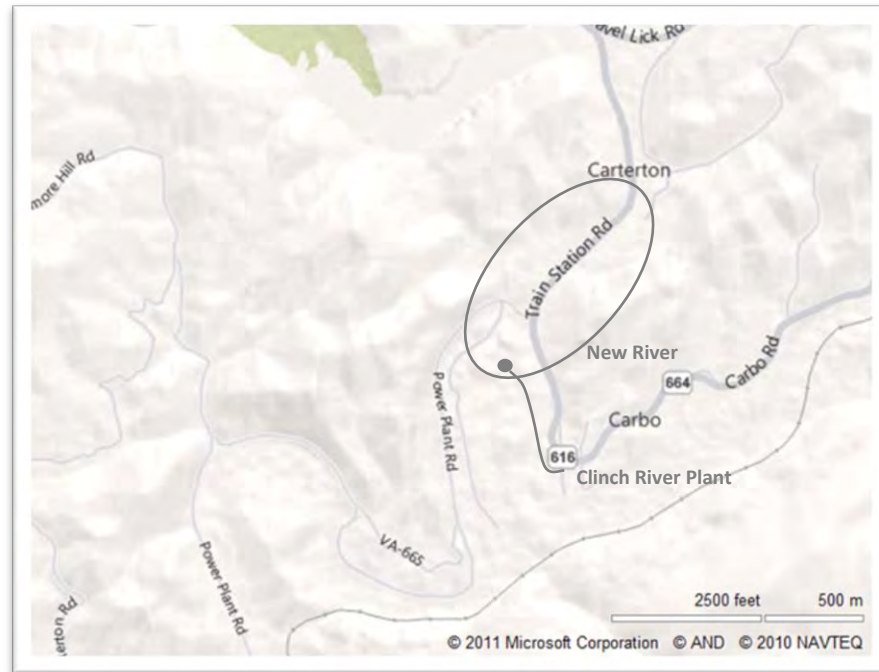

Figure 2.1-1: Location Map

# DRAFT



Figure 2.1-2: Aerial Photograph

|                              | Ash Pond 1<br>(Pond 1A/Pond 1B) | Ash Pond 2 |
|------------------------------|---------------------------------|------------|
| Dam Height (ft)              | 55                              | 56         |
| Crest Width (ft)             | 35                              | 20         |
| Length (ft)                  | 3150                            | 1650       |
| Side Slopes (upstream) H:V   | 1.75:1                          | 3:1        |
| Side Slopes (downstream) H:V | 2:1                             | 3:1        |

## 2.2 COAL COMBUSTION RESIDUE HANDLING

### 2.2.1 Fly Ash

Fly ash generated inside boilers at this facility is collected by electrostatic precipitators (ESPs) and moved by forced draft air fans through ducts and into hoppers. Any fly ash remaining on the ESP charged plates is removed through applied vibrations and knocking of the plates. Vacuum lines then carry dry ash collected inside hoppers to a concrete fly ash silo. The concrete silos at the plant are approximately 100 ft tall and 30 ft in diameter; each rests on a concrete pad. No secondary containment exists for either the hopper or concrete silos. Once in the silos, fly ash is

# DRAFT

conditioned with water to prevent dust emissions as well as to facilitate in transportation. Wet fly ash residuals are either sold for beneficial use or hauled in trucks for disposal at an approved offsite landfill.

## 2.2.2 Bottom Ash

Bottom ash and clinkers from boiler tubes are collected inside hoppers below the boilers. Once residuals reach the hopper, they are watered down and ground into slurry that falls into a sump. From this sump it is pumped to a tank. This tank is used to help equalize and control the solid content of the slurry. Slurry is pumped periodically through basalt-lined iron pipes to Ash Pond 1, a distance of about 1500 ft. Slurry pipes are primarily located above ground and have no secondary containment.

## 2.3 SIZE AND HAZARD CLASSIFICATION

According to the VA DCR, Division of Dam Safety inventory reports (Appendix A, Document 1) Ash Pond 1 has a maximum capacity of 1,240 acre-feet with a maximum design height for storage of 55 feet. Ash Pond 2 has a maximum capacity of approximately 126 acre-feet with a maximum design height of 56 feet (Appendix A, Document 2). Based on Table 2.2a, Ash Pond 1 and Ash Pond 2 are classified as intermediate size impoundments since dam height controls for both Ash Ponds.

| <b>Category</b> | <b>Impoundment</b>     |                    |
|-----------------|------------------------|--------------------|
|                 | <b>Storage (Ac-ft)</b> | <b>Height (ft)</b> |
| Small           | 50 and < 1,000         | 25 and < 40        |
| Intermediate    | 1,000 and < 50,000     | 40 and < 100       |
| Large           | > 50,000               | > 100              |

Ash Pond 1 and Ash Pond 2 are classified as **Significant** Hazard facilities, see Table 2.2b. If Ash Pond 1 and/or Ash Pond 2 were to fail, it is anticipated that there would be significant environmental losses along Clinch River and Dumps Creek. In addition, it is suspected that there would be damage to State Route 616, State Route 665 and potentially the Norfolk & Western railway. While loss of human life would not be expected, economic losses would be expected.

# DRAFT

|             | <b>Loss of Human Life</b>      | <b>Economic, Environmental, Lifeline Losses</b> |
|-------------|--------------------------------|---|
| Low         | None Expected                  | Low and generally limited to owner              |
| Significant | None Expected                  | Yes   |
| High        | Probable. One or more expected | Yes (but not necessary for classification)      |

## 2.4 AMOUNT AND TYPE OF RESIDUALS CURRENTLY CONTAINED IN THE UNIT(S) AND MAXIMUM CAPACITY

The volume of CCRs stored in Ash Pond 1 and Ash Pond 2 at the time of the one-day field assessment was not available by the Owner. Table 2.3 summarizes the storage capacity for Ash Pond 1 and Ash Pond 2.

|   | <b>Ash Pond 1<br/>(Pond 1A/Pond 1B)</b> | <b>Ash Pond 2<sup>1</sup></b> |
|---|---|-------------------------------|
| <b>Maximum Pool Surface Area (acre)</b> | 21.0                                    | 12.5                          |
| <b>Maximum Capacity (cubic yards)</b>   | 2,000,534                               | 203,280                       |
| <b>Maximum Capacity (acre-feet)</b>     | 1240                                    | 126                           |
| <b>EL Top Dam, min (ft)</b>             | 1570                                    | 1565                          |
| <b>Normal Pool (ft)</b>                 | 1568/1556                               | 1557                          |

<sup>1</sup>When pond was active.

## 2.5 PRINCIPAL PROJECT STRUCTURES

### 2.5.1 Earth Embankment

#### Ash Pond 1

According to the Dam Safety Inspection Report dated July 18, 1978 (Appendix A, Document 4), Ash Pond 1 was originally built as one large pond; a side hill dike creating an embankment that runs parallel to both Route 616 and Route 665. Subsequently, a splitter dike was constructed that divided the pond into Pond 1A and Pond 1B. The earthen embankment, built in 1955, was originally constructed of silty clay soil with a mixture of shale and sandstone fragments to an elevation of approximately 1540 feet. The original dike has been raised several times



# DRAFT

since, using the upstream method, to reach its current crest elevation of 1570 feet. The first raise of the dike was composed of fly ash and bottom ash material. All subsequent lifts to the dike have used shale rock (Appendix A, Document 5).

## Ash Pond 2

The design summary for the proposed final closure of Ash Pond 2, by BBC&M Engineering, indicates the original pond embankment was constructed in 1954 (Appendix A, Document 6). The embankment has since become a three-tiered dike system consisting of a lower, middle and upper dike. According to soil borings completed in 2006 and 2008, the dikes consist of shale fragments, silty clays, clayey silt and sand. The top of the upper dike has a crest elevation of 1565, although a portion of the dike was removed in 1998 to eliminate the potential of ponding water. The middle and lower dikes remain; each is filled with compacted ash to crest elevations of 1560 and 1535, respectively.

### 2.5.2 Outlet Structures

#### Ash Pond 1

The outlet structure for Ash Pond 1 is located in the north corner of cell Pond 1B. The outlet structure consists of an overflow drainage shaft and a 36-inch reinforced concrete pipe that directs water to a catch basin at the toe of the perimeter dike where it then flows through a 30-inch reinforced concrete pipe to an existing reclaim pond adjacent to Clinch River. The outlet structure serves as the principal and emergency spillway for Ash Pond 1.

#### Ash Pond 2

The outlet structure for Ash Pond 2 is located at the northeast side of the facility and is currently inactive. The outlet structure consists of an overflow drainage shaft and a 30-inch reinforced concrete pipe. The pipe conveyed flow over Dumps Creek via a pipe bridge and below State Route 616 and an existing railroad before combining with outflow from Ash Pond 1 in the existing reclaim pond adjacent to Clinch River. When it was active the outlet structure served as the principal and emergency spillway for Ash Pond 2.

# DRAFT

## 2.6 CRITICAL INFRASTRUCTURE WITHIN FIVE MILES DOWN GRADIENT

Immediately downstream of Ash Pond 1 and Ash Pond 2 is the Clinch River Power Plant on the opposite side of Clinch River as well as State Routes 616 and 665 and Norfolk & Western railway. The nearest downstream town is approximately 6 miles away at St. Paul, Virginia.

# DRAFT

## 3.0 SUMMARY OF RELEVANT REPORTS, PERMITS, AND INCIDENTS

### 3.1 SUMMARY OF LOCAL, STATE, AND FEDERAL ENVIRONMENTAL PERMITS

#### Ash Pond 1

VA DCR has a dam safety program under which Ash Pond 1 (Inventory Number 16703) and Ash Pond 2 (Inventory Number 16702) are state-regulated. Each pond was issued a six-year Regular Class III Operation and Maintenance Certificate on March 20, 2008 ( Appendix A, Document 1 and Document 2). Under the dam safety program, AEP is required to submit annual inspection reports to DCR as well as an engineer's inventory report and a renewal certification application at the conclusion of each six year term. Permitting is administered by DCR dependent on information provided by AEP regarding basic inventory of each pond, an emergency action plan and an operation and maintenance review.

#### Ash Pond 2

Ash Pond 2 is permitted by Virginia Department of Environmental Quality (VA DEQ). The seepage collected at the toe of perimeter dike is discharged directly into Dumps Creek. Seepage discharge is currently listed as Outfall 015 under the NPDES Permit No. VA0001015, issued September 15, 2009. Under this NPDES Permit, AEP is required to submit monthly Discharge Monitoring Reports (DMR) to VA DEQ for this permitted outfall.

### 3.2 SUMMARY OF SPILL/RELEASE INCIDENTS

#### Ash Pond 1

No documented spill/release incidents to the best of Dewberry's knowledge.

#### Ash Pond 2

In 1967, a failure of the lower dike of Ash Pond 2 occurred. SourceWatch documented that approximately 130 million gallons of coal ash slurry spilled into Dumps Creek; however, this figure could not be confirmed by the Owner.

It is alleged that the spill affected fish and benthic fauna on Dumps Creek and Clinch River as well as aquatic insects, snails and mussel populations. Dewberry requested information from the Owner regarding the failure but after further research by the Owner, no additional documentation was found regarding the incident.

# DRAFT

The cause of the failure or the extent of damages to the Plant, roads and railroad has not been documented to the best of Dewberry's knowledge. At the time of failure, the middle and upper dikes had not yet been built. Failure to the lower dike was repaired and Ash Pond 2 was put back in service.

# DRAFT

## 4.0 SUMMARY OF HISTORY OF CONSTRUCTION AND OPERATION

### 4.1 SUMMARY OF CONSTRUCTION HISTORY

#### 4.1.1 Original Construction

##### Ash Pond 1

Ash Pond 1 was built in 1955 as one facility consisting of one continuous side-hill dike.

##### Ash Pond 2

Ash Pond 2 was built in 1954 as one facility consisting of one continuous side-hill dike located in the old river valley of Dumps Creek, which required re-routing the creek to its current alignment (Appendix A, Document 6). The portion of the dike adjacent to Dumps Creek was armored with rip-rap along the toe of slope.

#### 4.1.2 Significant Changes/Modifications in Design since Original Construction

##### Ash Pond 1

A splitter dike was constructed in Ash Pond 1, dividing the pond into cells identified by the Owner as Pond 1A and Pond 1B. The original perimeter dike has been raised several times by placement of material directly over the crest of the dike. Toe drains (10-inch perforated pipes encased in gravel backfill) have been installed along the toe of the embankment to control seepage. Seepage discharge collects in a sump pump and in v-notched weirs at the toe of the embankment. All seepage flow is conveyed to the outfall pipe and into the reclaim pond adjacent to Clinch River.

During the period of November through December 1990 a cement-bentonite-fly ash (CBFA) cutoff wall was constructed within the perimeter dike of Ash Pond 1. The cutoff wall served to block potential seepage paths in the dike to improve downstream stability. The cutoff is approximately 2.5 ft wide, 2,150 ft long and reaches a depth of approximately 65ft. It was installed along the entire length of the perimeter dike and keyed into both abutments as well as the original dike material. Construction of the cutoff wall crossing the existing 68-ft deep, 36-inch diameter outfall pipe was limited to 60 ft deep and 10 ft on both sides of the estimated outfall pipe centerline (Appendix A, Document 7).

# DRAFT

## Ash Pond 2

The original Ash Pond 2 dike has been raised several times since it was first constructed in 1954. Since then the original dike has become a three-tiered system, consisting of a lower, middle and upper dike. The original dike was raised by constructing new dikes upslope of subsequently lower dikes and on top of existing fly ash fill. A 12-inch toe drain system encased in gravel was installed along the toe of the middle dike (Appendix A, Document 4). Seepage discharges via one outfall from the toe of the lower dike into Dumps Creek in accordance with an NPDES General Permit.

### 4.1.3 Significant Repairs/Rehabilitation since Original Construction

#### Ash Pond 1

There are seepage concerns from the dikes surrounding Ponds 1A and 1B (see more detailed discussion in Section 7.3). In 2006, the Owner commenced with a seepage control project that consisted of placing inverted filters with rip-rap cover along most of the downstream face of the perimeter dike of Ash Pond 1. This project was completed in 2009; however, the Owner has indicated that there are plans to extend the limits of the project to provide near-complete coverage to the downstream face.

#### Ash Pond 2

No significant repairs/rehabilitation since original construction except for repairs of the dike when it failed in 1967. No additional information was found regarding the repairs that resulted from this event. Section 3.2 elaborates further on the 1967 failure.

## 4.2 SUMMARY OF OPERATIONAL PROCEDURES

### 4.2.1 Original Operational Procedures

Data reviewed by Dewberry did not contain the original operational procedures for Ash Pond 1 or Ash Pond 2.

### 4.2.2 Significant Changes in Operational Procedures and Original Startup

Significant changes in operation procedures and original startup cannot be confirmed based on the data reviewed by Dewberry.

# DRAFT

## 4.2.3 Current Operational Procedures

Ash Pond 1 is the only active management unit at the Clinch River Power Plant. Ash Pond 2 is currently inactive and has been inactive since 1998. Ash Pond 1 is primarily used for handling all bottom ash residuals generated by plant operations. Fly ash residuals may also be sluiced to Ash Pond 1, though AEP has stated that this is on rare occasions, since nearly 100% of fly ash residuals are hauled off-site to an approved landfill or sold for other beneficial use. Ash Pond 1 is periodically dredged, residuals allowed to dry, and the CCR is trucked off-site to an approved landfill or for other beneficial use.

## 4.2.4 Other Notable Events since Original Startup

No additional information was provided to Dewberry concerning other notable events, except the 1967 failure of Ash Pond 2, that impacted the operation of either ash pond.

# DRAFT

## 5.0 FIELD OBSERVATIONS

### 5.1 PROJECT OVERVIEW AND SIGNIFICANT FINDINGS

Dewberry personnel, Scott Clarke, P.E. and Lorainne Ramos Nieves, P.E., CFM, performed a site visit on February 17, 2011 in company with the participants listed under Section 1.3.1.

The site visit began at 8:30 AM. The weather was clear and sunny. Photographs were taken of conditions observed and selected photographs are included in this report for visual reference. All pictures were taken by Dewberry personnel during the site visit. Appendix B includes two Coal Combustion Dam Inspection Checklist Forms, one for Ash Pond 1 and one for Ash Pond 2. These checklists provide a good summary and inventory of the items assessed during the site visit.

### 5.2 ASH POND 1

#### 5.2.1 Crest

The crest of the perimeter dike had no significant signs of depressions, tension cracks or other indications of settlement or shear failure. Figure 5.2.1-1 and Figure 5.2.1-2 shows the typical crest conditions along the perimeter dike.



**Figure 5.2.1-1:** Crest, West. Clinch River Power Plant to left not seen in this figure.



# DRAFT



**Figure 5.2.1-2:** Crest, Northeast. Route 616 and railroad to right.

## 5.2.2 Upstream/Inside Slope

The visible upstream slope of the perimeter dike, including all groins, had adequate and well maintained cover of grasses/weeds. The upstream slope below the permanent pool was not observed. There were no obvious signs of scarps, bulging cracks, depressions or other indications of slope instability. Rip-rap armoring was observed at operating pool elevations to mitigate wave erosion. Figure 5.2.2 shows a representative upstream slope section of the perimeter dike looking south.

# DRAFT



**Figure 5.2.2:** Upstream slope, South. Plant shown in background.

## 5.2.3 Downstream/Outside Slope and Toe

The visible downstream slope of the perimeter dike had adequate and well maintained cover of grasses/weeds as well as rip-rap armoring and inverted filter. A paved access road from Route 665 runs up the downstream slope of the perimeter dike to its crest. An animal burrow was observed along the downstream slope of the perimeter dike. The burrow hole was small in size and near the crest. No scarps, sloughs, bulging, cracks, depressions or other indications of slope instability were observed along the downstream slope. Figures 5.2.3-1 thru 5.2.3-3 show representative downstream slope sections of the perimeter dike.

# DRAFT



**Figure 5.2.3-1:** Downstream slope near access road entrance off Route 665. Note animal burrow near the crest.



**Figure 5.2.3-2:** Downstream slope along paved access road, Southwest. Note reclaim beyond the toe of the perimeter dike.

# DRAFT



**Figure 5.2.3-3:** Downstream slope, Southwest. The embankment runs parallel to Route 616. Note transit pipes along edge of riprap. Transit pipes carry offsite runoff through the ponds splitter dike and out to Dumps Creek.

#### 5.2.4 Abutments and Groin Areas

The perimeter dike has two abutments; the south and north abutments. Both abutment contacts consist of a drainage ditch. The south ditch shows some signs of erosion due to wet weather flow runoff from the adjacent hillside. The north ditch appeared in better condition with some stone and a v-notch weir that is used to monitor seepage, which was present on the day of the assessment. Apart from some minor erosion along the south abutment ditch, both abutments were well maintained. There were no observed scarps, sloughs, bulging, cracks, depressions or other indications of slope instability. Figures 5.2.4-1 and 5.2.4-2 show south and north abutment contacts.

# DRAFT



**Figure 5.2.4-1:** North abutment ditch. Note upstream riprap and v-notch weir used to monitor seepage.



**Figure 5.2.4-2:** South abutment ditch. Note downstream slope rip-rap used for seepage control and abutment ditch used to convey hillside drainage.

## 5.3 ASH POND 2

### 5.3.1 Crest

Portions of the upper dike have been removed and some re-grading has been completed near the crest of the middle dike. A small sized animal burrow was observed along the crest of the middle dike. No depressions, tension cracks or other indications of settlement or shear failure were observed on the crest of the middle or lower dike. Figure 5.3.1-1 and Figure 5.3.1-2 show typical crest conditions along the dike.

# DRAFT



**Figure 5.3.1-1:** Lower dike crest, South.



**Figure 5.3.1-2:** Middle dike crest, South.  
Note removed portions of upper dike and re-grading near crest of the middle dike.

# DRAFT

## 5.3.2 Upstream/Inside Slope

Upstream slopes for the middle and lower dikes of the embankment are not visible due to placement of fill material. The upstream slopes of the upper dike were visible. No slope maintenance appears to be in place (pond is currently inactive). Slopes are covered with sparse grass/weeds.

## 5.3.3 Downstream/Outside Slope and Toe

The downstream slopes of the dikes are covered in high grass/weeds. The upper dike had some areas of tree growth. Significant tree growth between the toe of the lower dike and Dumps Creek made visual observations difficult. Based on what could be observed there were no scarps, sloughs, bulging, cracks, depressions or other indications of slope instability along any portion of the dikes. Figures 5.3.3-1 thru 5.3.3-3 show representative sections of the downstream slopes and toe.



**Figure 5.3.3-1:** Remaining portion of upper dike, Southeast. Note tree growth on downstream slope.



# DRAFT



**Figure 5.3.3-2:** Downstream slope of lower dike, Southeast. Note significant tree growth along Dumps Creeks.



**Figure 5.3.3-3:** Downstream toe of lower dike. Note significant tree growth and rip-rap adjacent Dumps Creek.

# DRAFT

## 5.3.4 Abutments and Groin Areas

There were no observed scarps, sloughs, bulging, cracks, depressions or other indications of slope instability at dike abutments and groin areas of upper dike. Significant tree growth was observed along south abutment as shown in Figure 5.3.4.



**Figure 5.3.4:** South abutment. Note tree growth to the right along hillside; Ash Pond 2 is to the left.

## 5.4 OUTLET STRUCTURES

### 5.4.1 Overflow Structure

#### Ash Pond 1

The overflow spillway structure for Ash Pond 1 is located in the north corner of the facility (Figure 5.4.1-1). The structure appeared to be in satisfactory condition and operating as designed. There were no obvious signs of trash and/or debris around the intake. Water was observed entering the spillway but could not be seen exiting the spillway as the outfall pipe consists of a long storm sewer that outfalls into the existing reclaim pond below its permanent pool.

# DRAFT



**Figure 5.4.1-1:** Overflow spillway structure

## Ash Pond 2

The overflow spillway structure for Ash Pond 2 is located at the eastern midpoint of the facility (Figure 5.4.1-2). The structure appeared to be in poor condition with obvious signs of corrosion and encroaching vegetation. The spillway is currently inactive. Fissures/cracks were observed immediately west of the spillway where it appeared runoff had been migrating into existing ash residuals. The overflow spillway structure is located at an elevation significantly higher than the current finished grade around it. Discharge through the structure and outfall pipes is not possible at this time.



**Figure 5.4.1-2:** Ash Pond 2 overflow structure.

## 5.4.2 Outlet Conduit

### Ash Pond 1

The spillway outlet conduit for Ash Pond 1 consists of a 36-inch reinforced concrete pipe leading to a catch basin that subsequently outfalls to a 30-inch reinforced concrete pipe that drains to the existing reclaim pond. The 30-inch outfall was not visible as it is completely submerged below the permanent pool of the reclaim pond (Figure 5.4.2-1).

# DRAFT



**Figure 5.4.2-1:** Outlet conduit outfall, reclaim pond at intersection of Route 616 and 665.

## Ash Pond 2

The spillway outlet conduit for Ash Pond 2 consists of a 30-inch reinforced concrete pipe. The conduit connects to the same 30-inch reinforced concrete pipe Ash Pond 1 connects to prior to reaching the reclaim pond. The outlet conduit was not visible at the time of the site assessment.

# DRAFT

## 6.0 HYDROLOGIC/HYDRAULIC SAFETY

### 6.1 SUPPORTING TECHNICAL DOCUMENTATION

#### 6.1.1 Flood of Record

No documentation was provided to Dewberry regarding local flood records. USGS river gage (USGS 03524000) for the Clinch River, located approximately 4 miles upstream of the plant, shows the largest peak flows occurred during 1957 and 1977, (Exhibit 1). These peak flows are comparable to the Clinch River 1% annual chance (100-year) flood discharges found in the Russell County FIS Study (Exhibit 2). Therefore, the flood of record is comparable to the base flood elevation. The Russell County FEMA FIRM dated September 29, 2010, Map Number 51167C0215C and the FIRM dated September 29, 2010, Map Number 51167C0205C are provided for reference (Exhibits 3 and 4).

#### 6.1.2 Inflow Design Flood

Data reviewed by Dewberry did not contain Inflow Design Flood information.

#### 6.1.3 Spillway Rating

Data reviewed by Dewberry did not contain Spillway Rating information.

#### 6.1.4 Downstream Flood Analysis

Data reviewed by Dewberry did not contain a downstream flood analysis.

### 6.2 ADEQUACY OF SUPPORTING TECHNICAL DOCUMENTATION

Data reviewed by Dewberry did not contain the necessary documentation to make a proper determination on adequacy of hydrologic and hydraulic safety factors. There is also no information on whether hydrologic safety factors were considered in the design of Ash Pond 1 or Ash Pond 2.

### 6.3 ASSESSMENT OF HYDROLOGIC/HYDRAULIC SAFETY

An assessment of Hydrologic/Hydraulic Safety cannot be made at this time.

# DRAFT

## 7.0 STRUCTURAL STABILITY

### 7.1 SUPPORTING TECHNICAL DOCUMENTATION

#### 7.1.1 Stability Analyses and Load Cases Analyzed

##### Ash Pond 1

A stability analysis report was provided for Ash Pond 1 (Appendix A, Document 5). The stability analysis is based on geotechnical investigations completed by MACTEC in 2009 as well as various instrumentation reading summaries acquired from plant records. The slope stability analysis of the perimeter dike considered static and seismic conditions under steady-state seepage.

##### Ash Pond 2

A design summary was provided for final closure of Ash Pond 2 (Appendix A, Document 6). With this summary a stability analysis was included. However, this analysis was completed assuming the ash was saturated up to existing groundwater levels and not to the top of the existing ash.

#### 7.1.2 Design Parameters and Dam Materials

##### Ash Pond 1

A total of 12 boring logs were completed in 2009 by MACTEC. It was determined that the dike material for Ash Pond 1 was primarily composed of shale rock, with the exception of fly ash and bottom ash material that was found in a lower portion of the dike at a depth coincidental to the first raised section of the dike. Refer to Appendix A, Document 5 for more detail regarding design parameters considered in the slope stability analysis.

##### Ash Pond 2

A total of 8 boring logs were completed in 2008 by BBC&M Engineering and the Owner. It was determined that the dike material consisted of shale fragments, silty clays, clayey silt and sand.

# DRAFT

## 7.1.3 Uplift and/or Phreatic Surface Assumptions

### Ash Pond 1

As part of the 2009 geotechnical investigation, eight new piezometers were installed to complement twelve existing piezometers along the perimeter dike. Piezometers were used to determine phreatic surface elevations at the crest and toe for use in the slope stability analysis.

### Ash Pond 2

Groundwater observations were made at the beginning and completion of the eight borings drilled in 2008. Groundwater elevations were noted to generally decrease at borings located closer to Dumps Creek.

## 7.1.4 Factors of Safety and Base Stresses

### Ash Pond 1

Three critical sections were used in the slope stability analysis completed for Ash Pond 1. Seepage conditions at the pond were considered in determining phreatic water surfaces and hydraulic gradients along each section. Each section was analyzed considering steady state seepage using effective shear strength parameters.

Different failure modes were considered for each section under static loading. Analysis of slope stability under seismic conditions considered both drained and undrained shear strength for each section. A summary of the calculated safety factors is included in Table 7.1.4.

Table 7.1.4: Factors of Safety for Clinch River Plant, Ash Pond 1

| Section | Static Loading Safety Factor per Failure Mode |                     |               | Required Safety Factor (US Army Corp of Engineers) | Seismic Loading Safety Factor per Analysis Type |                          | Required Safety Factor (US Army Corp of Engineers) |
|---------|---|---------------------|---------------|--|---|--------------------------|--|
|         | Deep Failure                                  | Outer Shell Failure | Block Failure |  | Drained Shear Strength                          | Undrained Shear Strength |  |
| A       | 1.8   | 1.5                 | 1.9           | 1.5  | 1.3   | 1.3                      | 1.2  |
| B       | 1.7   | 1.7                 | 2.0           | 1.5  | 1.3   | 1.4                      | 1.2  |
| C       | 1.6   | 1.8                 |               | 1.5  | 1.3   | 1.2                      | 1.2  |



# DRAFT

## Ash Pond 2

As discussed in Section 7.1.1, safety factors from the slope stability analysis completed by BBC&M Engineering cannot be used for the purpose of this report based on design parameters used and inappropriate assumptions concerning saturated ash levels.

### 7.1.5 Liquefaction Potential

#### Ash Pond 1

Appendix A, Document 5 states that a liquefaction potential analysis was not performed for Ash Pond 1 but that based on other studies performed for similar facilities, including Ash Pond 2, that Ash Pond 1 is believed to have no potential for liquefaction under probable earthquakes that may occur in the region because the magnitude associated with them are not strong enough to impose cyclic stress ratios high enough to cause liquefaction.

#### Ash Pond 2

Appendix A, Document 6 states that a liquefaction potential analysis was performed for Ash Pond 2 assuming saturated fly ash conditions under long term conditions after closure of the facility. Under these conditions, the analysis concluded that liquefaction would not occur during the applied earthquake load, which was based on a synthetic seismograph record for the location of Ash Pond 2.

### 7.1.6 Critical Geological Conditions

Clinch River Power Plant is located on Lower Paleozoic sedimentary rock and near the vicinity of a thrust fault.

The Owner's stability analysis referenced a seismic force of 0.16 g at the Clinch River Power Plant, which matches well with the 2008 USGS Seismic-Hazard Maps for Central/Eastern United States, considering peak ground acceleration with a 2-percent probability of exceedance in 50-years (Exhibit 5).

Bedrock was encountered during bore drilling at Ash Pond 1 and Ash Pond 2. Based on descriptions obtained from the samples, bedrock was classified as very-soft to soft gray shale and hard gray limestone,

# DRAFT

exhibiting massive bedding with many diagonal fractures. The top of rock was determined to be relatively flat.

## 7.2 ADEQUACY OF SUPPORTING TECHNICAL DOCUMENTATION

The supporting technical documentation submitted to support the structural stability of Ash Pond 1 appears to be adequate.

The supporting technical documentation submitted to support the structural stability of Ash Pond 2 is marginally adequate. A structural stability loading that assumes full saturation of all ash in Ash Pond 2 should be evaluated in addition to the condition that was analyzed (i.e., assumed saturation of the ash up to the existing groundwater table).

## 7.3 ASSESSMENT OF STRUCTURAL STABILITY

### Ash Pond 1

The overall structural stability of the perimeter dike for Ash Pond 1 appears to be fair, based on a visual site assessment and review of documentation provided. The fair rating reflects continuing concerns of seepage from the pond dikes.

Signs of significant seepage have been recorded as far back as 1975. In 1980, seepage and a wet area were observed along a 150 ft stretch of the perimeter dike adjacent to the cell, Pond 1B, about 22 ft from the toe of the dike (Appendix A, Document 5). Conditions in this location did not notably change after the construction of the cutoff wall along the embankment in 1990. A boil at the toe of the perimeter dike adjacent to the cell, Pond 1A, just above the reclaim pond was also noted to remain after construction of the cutoff wall. Recent inspections in 2008 and 2009 indicate continual wet spots and seeps at different locations along the perimeter dike adjacent to the cell, Pond 1A (Appendix A, Documents 8-10). Based on the one-day site assessment it was evident that seepage is heavily monitored and controlled by the Owner. Close monitoring of seepage at this facility is strongly encouraged as it is necessary in identifying any drastic change in seepage patterns that could potentially affect the structural stability of the perimeter dike.

### Ash Pond 2

Based on a visual site assessment and review of documentation provided, the overall structural stability of the perimeter dikes for Ash Pond 2 appears to be fair. The rating reflects the inappropriate assumptions regarding groundwater elevations in the slope stability analysis and the previous dike failure, countered by the lack of

# DRAFT

standing water in this inactive pond. No documented signs of significant erosion damage, cracks, sloughs or releases of materials could be found. The facility was retired in 1998; however, it is encouraged that more frequent inspections and maintenance of the facility continue in accordance VA DCR, Division of Dam Safety regulations and requirements.

# DRAFT

## 8.0 ADEQUACY OF MAINTENANCE AND METHODS OF OPERATION

### 8.1 OPERATING PROCEDURES

Operating procedures are described in Section 4.2.3.

### 8.2 MAINTENANCE OF THE DAM AND PROJECT FACILITIES

In 1983, the Owner adopted a Dam and Dike Inspection and Maintenance Program (DIMP), where all earthen dams and dikes used for ash storage or disposal, waste water ponds, and large cooling water storage facilities under the Owner's management are routinely inspected, documented, and monitored. Under this program, there are four separate levels of inspection. First is to routinely make inspections by plant personnel to monitor visible changes; second is to make formal 'checklist type' inspections completed by plant personnel on a quarterly basis; third is to routinely schedule engineering inspections supervised by a professional engineer according to the risk classification of the dam; and, fourth are non routine inspections completed after heavy rains, seismic activity or other major events. The inspection and maintenance program continues today for Ash Pond 1 but was discontinued for Ash Pond 2 in 1998 when it became inactive.

### 8.3 ASSESSMENT OF MAINTENANCE AND METHODS OF OPERATIONS

#### 8.3.1 Adequacy of Operating Procedures

Operating procedures reviewed appear adequate for Ash Pond 1. This is also true for Ash Pond 2 before it became inactive in 1998.

#### 8.3.2 Adequacy of Maintenance

Maintenance procedures reviewed appear adequate for Ash Pond 1. Though currently inactive, further consideration to maintaining vegetation and tree growth on Ash Pond 2's upstream and downstream slopes should be addressed until the facility is formally closed through VA DCR, Division of Dam Safety and VA DEQ.

# DRAFT

## 9.0 ADEQUACY OF SURVEILLANCE AND MONITORING PROGRAM

### 9.1 SURVEILLANCE PROCEDURES

Appendix A, Documents 3, 4, 8, 9, 10, 11 and 13 show sample inspections reports and summaries submitted by the Owner in accordance with their adopted Dam and Dike Inspection and Maintenance Program as described under Section 8.2.

### 9.2 INSTRUMENTATION MONITORING

Ash Pond 1 and Ash Pond 2 are both instrumented. Ash Pond 1 has twenty working piezometers and staff gage present in each cell (Pond 1A and Pond 1B). Ash Pond 2 has approximately fourteen piezometers; however, a continuous record of readings has not been kept at Ash Pond 2 since it became inactive in 1998. Documentation provided by the Owner included reading summaries for Ash Pond 1 piezometers. Data collected from Ash Pond 1 and Ash Pond 2 piezometers was used to monitor phreatic surfaces and prepare stability analysis reports.

### 9.3 ASSESSMENT OF SURVEILLANCE AND MONITORING PROGRAM

#### 9.3.1 Adequacy of Inspection Program

Based on the data reviewed by Dewberry, including the observations during the site visit, the inspection program appears to be adequate, though inspections should resume for Pond 2 until the facility is formally closed through VA DCR, Division of Dam Safety and VA DEQ.

#### 9.3.2 Adequacy of Instrumentation Monitoring Program

Based on the data reviewed by Dewberry, including the observations during the site visit, the monitoring program appears to be adequate.

# DRAFT

## Exhibit 1: USGS Peak Streamflow, USGS 03524000 Clinch River at Cleveland, VA

US EPA ARCHIVE DOCUMENT

**USGS**  
science for a changing world

USGS Home  
Contact USGS  
Search USGS

National Water Information System: Web Interface

USGS Water Resources      Data Category: Surface Water      Geographic Area: Virginia      GO

[News](#) updated March, 2011

### Peak Streamflow for Virginia

- Additional information:
  - Annual Water Data Reports: [Water Years 2002-09](#)
  - Historical instantaneous flow data for Virginia: [Instantaneous Data Archive - IDA](#)
  - National Weather Service Advanced Hydrologic Prediction Service: [River forecasts](#)

### USGS 03524000 CLINCH RIVER AT CLEVELAND, VA

Available data for this site      Surface-water: Peak streamflow      GO

| Russell County, Virginia<br>Hydrologic Unit Code 06010205<br>Latitude 36°56'41", Longitude 82°09'18" NAD27<br>Drainage area 533 square miles<br>Gage datum 1,500.24 feet above NGVD29 |               |                    |                       | <b>Output formats</b>                    |               |                    |                   |
|---|---------------|--------------------|-----------------------|--|---------------|--------------------|-------------------|
|   |               |                    |                       | <a href="#">Table</a>                    |               |                    |                   |
|   |               |                    |                       | <a href="#">Graph</a>                    |               |                    |                   |
|   |               |                    |                       | <a href="#">Tab-separated file</a>       |               |                    |                   |
|   |               |                    |                       | <a href="#">peakfq (watstore) format</a> |               |                    |                   |
|   |               |                    |                       | <a href="#">Reselect output format</a>   |               |                    |                   |
| Water Year  | Date          | Gage Height (feet) | Stream-flow (cfs)     | Water Year                               | Date          | Gage Height (feet) | Stream-flow (cfs) |
| 1862  | Feb. 1862     | 22.80              | 27,500 <sup>7,B</sup> | 1963                                     | Mar. 12, 1963 | 22.70              | 27,200            |
| 1902  | Mar. 01, 1902 | 20.30              | 22,300 <sup>7</sup>   | 1964                                     | Mar. 05, 1964 | 10.03              | 6,900             |
| 1907  | Jun. 14, 1907 | 20.30              | 22,300 <sup>7</sup>   | 1965                                     | Mar. 27, 1965 | 14.00              | 11,700            |
| 1918  | Jan. 29, 1918 | 19.90 <sup>3</sup> | 21,500 <sup>7</sup>   | 1966                                     | May 02, 1966  | 10.27              | 7,260             |
| 1921  | Jan. 15, 1921 | 9.80 <sup>3</sup>  | 6,860                 | 1967                                     | Mar. 07, 1967 | 16.75              | 13,700            |
| 1922  | Mar. 10, 1922 | 12.00 <sup>3</sup> | 9,640                 | 1968                                     | Dec. 22, 1967 | 10.57              | 6,570             |
| 1923  | Jun. 13, 1923 | 17.20 <sup>3</sup> | 16,400                | 1969                                     | Feb. 02, 1969 | 8.55               | 4,600             |
| 1924  | Jan. 01, 1924 | 13.00 <sup>3</sup> | 11,400                | 1970                                     | Dec. 31, 1969 | 18.63              | 16,100            |

# DRAFT

|      |               |                    |        |      |               |       |        |
|------|---------------|--------------------|--------|------|---------------|-------|--------|
| 1925 | Dec. 09, 1924 | 10.70 <sup>3</sup> | 8,480  | 1971 | May 07, 1971  | 18.82 | 16,400 |
| 1926 | Feb. 15, 1926 | 11.00 <sup>3</sup> | 8,340  | 1972 | Apr. 15, 1972 | 16.77 | 13,700 |
| 1927 | Dec. 22, 1926 | 20.10 <sup>3</sup> | 20,400 | 1973 | Mar. 17, 1973 | 19.94 | 20,500 |
| 1928 | Apr. 30, 1928 | 8.43 <sup>3</sup>  | 5,200  | 1974 | Dec. 26, 1973 | 15.25 | 12,200 |
| 1929 | Mar. 06, 1929 | 11.40 <sup>3</sup> | 8,860  | 1975 | Mar. 30, 1975 | 18.88 | 18,400 |
| 1930 | Feb. 03, 1930 | 8.70 <sup>3</sup>  | 5,540  | 1976 | Jan. 01, 1976 | 9.68  | 5,680  |
| 1931 | Apr. 04, 1931 | 11.00 <sup>3</sup> | 8,340  | 1977 | Apr. 05, 1977 | 26.40 | 34,500 |
| 1932 | Jan. 30, 1932 | 14.38              | 11,700 | 1978 | Jan. 26, 1978 | 20.87 | 21,200 |
| 1933 | Dec. 28, 1932 | 11.82              | 8,830  | 1979 | Jan. 21, 1979 | 17.85 | 16,200 |
| 1934 | Mar. 03, 1934 | 11.62              | 8,610  | 1980 | Jan. 23, 1980 | 10.19 | 6,190  |
| 1935 | Apr. 01, 1935 | 14.12              | 11,400 | 1981 | May 29, 1981  | 8.66  | 4,700  |
| 1936 | Jan. 19, 1936 | 12.48              | 10,400 | 1982 | Feb. 04, 1982 | 11.90 | 8,100  |
| 1937 | Feb. 09, 1937 | 11.24              | 8,750  | 1983 | Dec. 16, 1982 | 8.64  | 5,060  |
| 1938 | Oct. 28, 1937 | 13.38              | 11,500 | 1984 | May 07, 1984  | 19.46 | 18,700 |
| 1939 | Feb. 03, 1939 | 12.58              | 10,500 | 1985 | Feb. 02, 1985 | 13.66 | 10,000 |
| 1940 | Aug. 14, 1940 | 20.60              | 22,500 | 1986 | Nov. 29, 1985 | 9.22  | 5,500  |
| 1941 | Mar. 12, 1941 | 8.92               | 6,000  | 1987 | Apr. 17, 1987 | 16.10 | 13,300 |
| 1942 | Aug. 09, 1942 | 9.92               | 7,190  | 1988 | Feb. 05, 1988 | 5.61  | 2,430  |
| 1943 | Dec. 30, 1942 | 12.01              | 9,710  | 1989 | May 06, 1989  | 13.01 | 9,290  |
| 1944 | Feb. 18, 1944 | 17.95              | 18,200 | 1990 | Feb. 10, 1990 | 11.40 | 7,590  |
| 1945 | Feb. 18, 1945 | 12.43              | 9,920  | 1991 | Mar. 30, 1991 | 10.56 | 6,770  |
| 1946 | Jan. 08, 1946 | 16.30              | 15,400 | 1992 | Dec. 02, 1991 | 13.66 | 10,000 |
| 1947 | Jan. 16, 1947 | 16.10              | 15,200 | 1993 | Mar. 24, 1993 | 14.04 | 10,400 |
| 1948 | Feb. 14, 1948 | 15.10              | 13,600 | 1994 | Feb. 11, 1994 | 18.54 | 17,100 |
| 1949 | Dec. 04, 1948 | 12.26              | 9,360  | 1995 | Jan. 16, 1995 | 12.97 | 9,240  |
| 1950 | Feb. 02, 1950 | 16.53              | 15,600 | 1996 | Jan. 27, 1996 | 15.21 | 12,100 |
| 1951 | Dec. 08, 1950 | 9.74               | 6,050  | 1997 | Mar. 03, 1997 | 13.43 | 9,750  |
| 1952 | Mar. 11, 1952 | 10.30              | 6,740  | 1998 | Apr. 17, 1998 | 16.19 | 13,800 |
| 1953 | May 20, 1953  | 16.66              | 16,000 | 1999 | Jan. 24, 1999 | 8.24  | 5,010  |
| 1954 | Jan. 23, 1954 | 10.47              | 6,980  | 2000 | Jul. 06, 2000 | 6.61  | 3,580  |
| 1955 | Mar. 07, 1955 | 16.35              | 15,500 | 2001 | Jul. 30, 2001 | 17.28 | 15,500 |
| 1956 | Apr. 16, 1956 | 15.38              | 14,000 | 2002 | Mar. 18, 2002 | 21.81 | 24,300 |
| 1957 | Jan. 30, 1957 | 24.40              | 31,000 | 2003 | Feb. 16, 2003 | 16.07 | 13,600 |
| 1958 | May 06, 1958  | 15.58              | 13,900 | 2004 | Nov. 20, 2003 | 17.85 | 16,500 |
| 1959 | Jan. 22, 1959 | 11.20              | 7,840  | 2005 | Dec. 10, 2004 | 10.76 | 7,490  |
| 1960 | Nov. 25, 1959 | 9.71               | 6,170  | 2006 | Apr. 08, 2006 | 10.46 | 7,180  |
| 1961 | Feb. 26, 1961 | 15.82              | 14,300 | 2007 | Apr. 15, 2007 | 7.58  | 4,410  |
| 1962 | Dec. 18, 1961 | 13.45              | 11,000 | 2008 | Mar. 05, 2008 | 10.46 | 7,180  |
|      |               |                    |        | 2009 | Jun. 18, 2009 | 11.49 | 8,650  |

# DRAFT

**Exhibit 2:** FEMA Russell County FIS Study, Table 2-Summary of Discharges.

| FLOODING<br>SOURCE<br>AND<br>LOCATION                                  | DRAINAGE<br>AREA*<br>(sq. miles) | PEAK DISCHARGES (cfs)            |                                 |                                 |                                   |  |
|--|----------------------------------|----------------------------------|---------------------------------|---------------------------------|-----------------------------------|--|
|  |                                  | 10-percent-<br>annual-<br>chance | 2-percent-<br>annual-<br>chance | 1-percent-<br>annual-<br>chance | 0.2-percent-<br>annual-<br>chance |  |
| <b>BIG CEDAR CREEK</b>   |                                  |                                  |                                 |                                 |                                   |  |
| At mile 6.68   | 50.1                             | 3,340                            | 3,950                           | 4,180                           | 4,710                             |  |
| At mile 7.08,<br>upstream of<br>confluence of Roaring<br>Spring Branch | 46.7                             | 3,140                            | 3,720                           | 3,940                           | 4,450                             |  |
| At mile 8.55,<br>downstream of<br>confluence of Burgess<br>Creek       | 46.3                             | 3,140                            | 3,720                           | 3,940                           | 4,450                             |  |
| <b>BIG CEDAR CREEK, Cont.</b>  |                                  |                                  |                                 |                                 |                                   |  |
| At mile 9.04   | 39.2                             | 2,700                            | 3,210                           | 3,410                           | 3,870                             |  |
| <b>CLINCH RIVER</b>  |                                  |                                  |                                 |                                 |                                   |  |
| At mile 256.0  | 528.3                            | 22,000                           | 33,000                          | 37,000                          | 51,000                            |  |
| At mile 271.0  | 468.5                            | 19,500                           | 29,000                          | 33,500                          | 45,500                            |  |
| At mile 273.0  | 463.7                            | 19,500                           | 29,000                          | 33,500                          | 45,500                            |  |
| <b>GRAVEL LICK CREEK</b>   |                                  |                                  |                                 |                                 |                                   |  |
| At confluence with<br>Lick Creek                                       | 2.80                             | 490                              | 790                             | 930                             | 1,340                             |  |
| At mile 1.30   | 1.90                             | 370                              | 610                             | 730                             | 1,050                             |  |

US EPA ARCHIVE DOCUMENT



**DRAFT**

Exhibit 3: FEMA Russell County FIRM, Map Number 51167C0215C

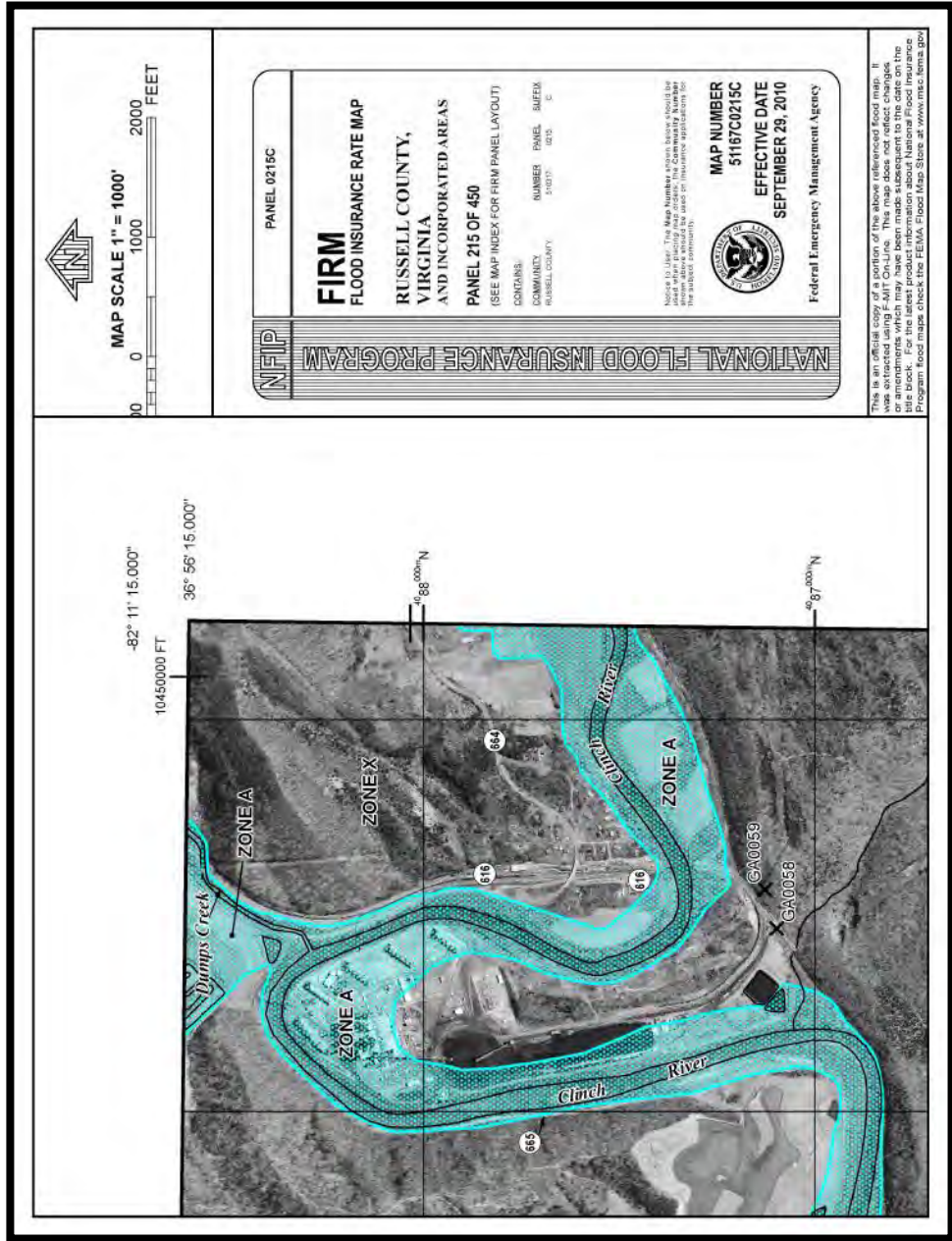

# DRAFT

Exhibit 4: FEMA Russell County FIRM, Map Number 51167C0205C

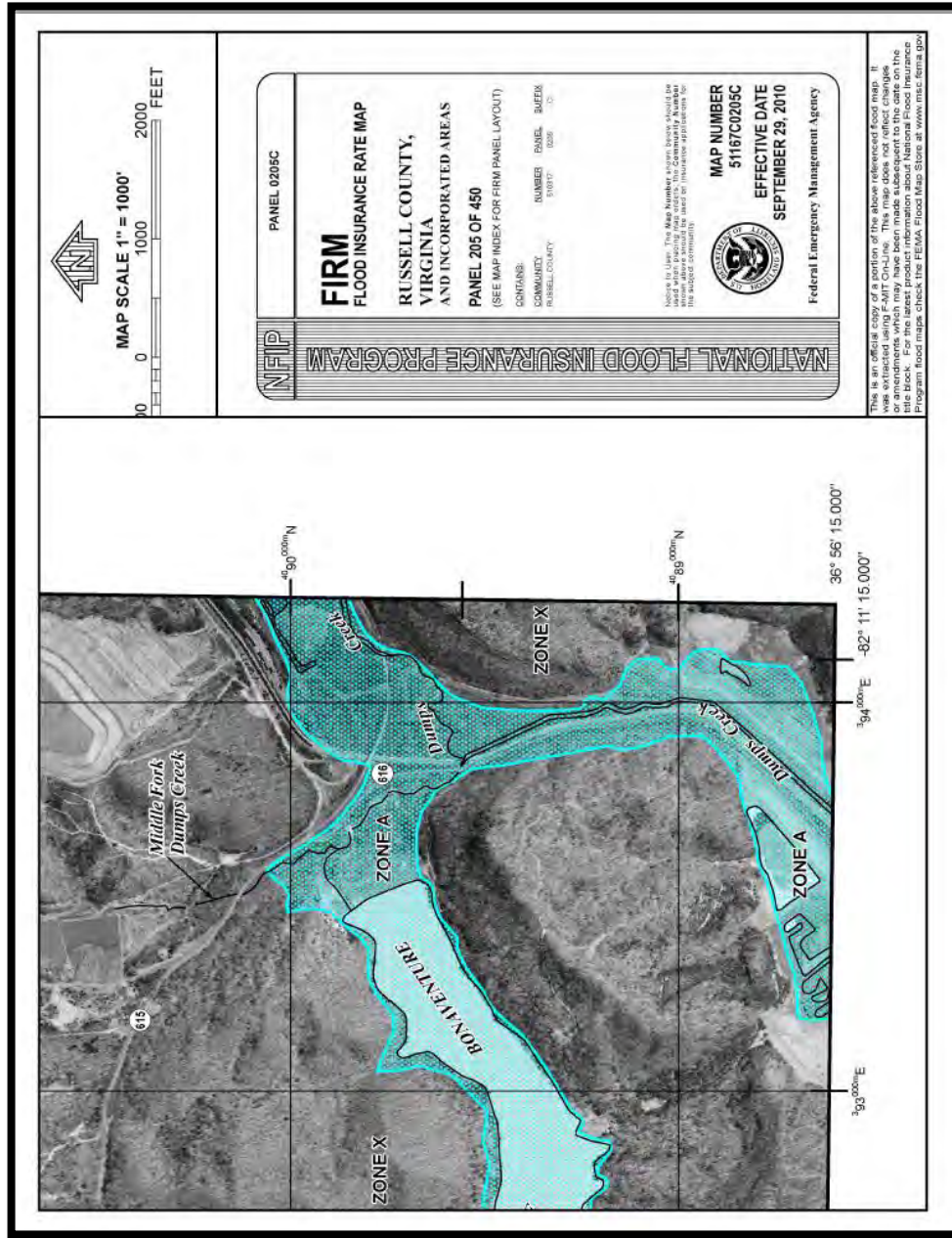

# DRAFT

Exhibit 5: USGS Seismic-Hazard Map for Central/Eastern US, 2%/50Years, 2008

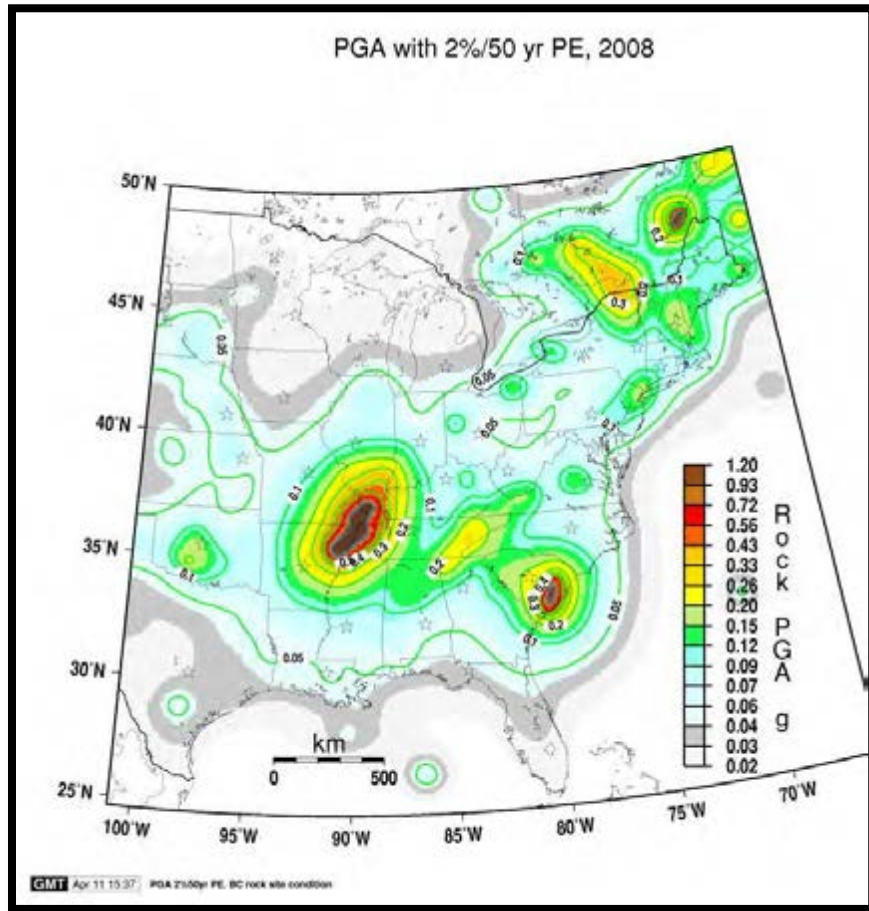

US EPA ARCHIVE DOCUMENT

# APPENDIX A

L. Preston Bryant, Jr.  
Secretary of Natural Resources



Joseph H. Mason  
Director

**COMMONWEALTH of VIRGINIA**  
**DEPARTMENT OF CONSERVATION AND RECREATION**

201 Governor Street, Suite 206  
Richmond, Virginia 23219-2010  
(804) 371-6095 Fax (804) 371-2630

April 4, 2008

Appalachian Power Company  
Attn: William Smith  
Post Office Box 2021  
Roanoke, VA 24022

RE: Clinch River Fly Ash Dam #1, Inventory Number 16703

Dear Mr. Smith:

The Operation and Maintenance Certificate Application for Clinch River Fly Ash Dam #1, Inventory Number 16703, and the required supporting documents have been reviewed for compliance with the provisions of the Code of Virginia, Dam Safety Act, (Section 10.1-604 et. seq.) and the regulations promulgated by the Virginia Soil and Water Conservation Board (Board). Based on this information, on March 20, 2008, the Board issued a six-year (03/20/2008 - 3/31/2014) Regular Class III Operation and Maintenance Certificate (Certificate). The Certificate and other pertinent data are enclosed.

The Dam Safety Act requires dam owners to maintain their dam in a condition to prevent unreasonable threats to life and property of others. The classification of your dam and the Certificate issued were based on the current known downstream hazard potential from upstream characteristics, a re-inspection report, operation and maintenance application, and an emergency action plan. The actions contained in the documents accompanying your Certificate Application must be adhered to for the duration of the terms contained in the Certificate. To assist you in adhering to the terms of the Certificate, the following table provides a schedule of dates to submit required documents.

| Annual Owner's Inspection Report | Owner's Engineer Inventory Report | Renewal Certification Six Year Application by Owner and Owner's Engineer |
|----------------------------------|-----------------------------------|--|
| 03/31/2009                       |                                   |  |
| 03/31/2010                       |                                   |  |
| 03/31/2011                       |                                   |  |
| 03/31/2012                       |                                   |  |
| 03/31/2013                       | 12/31/2013                        | 12/31/2013   |

Should you have questions, please direct them to Thomas I. Roberts, P.E., Dam Safety Regional Engineer, Department of Conservation and Recreation, Dam Safety and Floodplain Management Division, 8 Radford Street, Suite 203, Christiansburg, VA 24073, telephone 540-394-2550 or via e-mail at [Thomas.Roberts@dcr.virginia.gov](mailto:Thomas.Roberts@dcr.virginia.gov).

Sincerely,

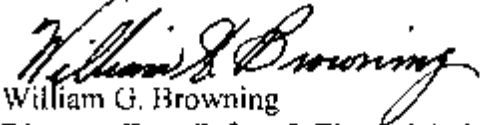

William G. Browning  
Director, Dam Safety & Floodplain Management Division

Enclosures as stated:

- c: James M. Robinson, P.E., Dam Safety Program Manager
- Thomas I. Roberts, P.E. Dam Safety Regional Engineer

**DATA SHEET - OPERATION AND MAINTENANCE CERTIFICATE**

Department of Conservation & Recreation  
Division of Dam Safety & Floodplain Management  
203 Governor Street, Suite 206  
Richmond, VA 23219-2094

|  |  |
|--|--|
| Name of Dam: <b>Clinch River Fly Ash Dam No. 1</b>   | Inventory Number: <b>16703</b>   |
| Location: <b>Offstream Dam Near New River</b>  | City/County: <b>Russell</b>  |
| Owner: <b>Appalachian Power Company</b><br>Attn: <b>William Smith</b><br>Address: <b>40 Franklin Road, P.O. Box 2021</b><br>City/Town/Zip: <b>Roanoke, VA 24022-2121</b> | Designed by: <b>Casa Grande Consultants</b><br>Constructed by: <b>Unknown</b><br>Year Constructed: <b>1964</b> |
| Type of Dam: <b>Rockfill</b>   | Purpose: <b>Sediment-Fly Ash</b>   |
| Drainage Area (Sq. Mi.): <b>0.03</b>   | Type of Watershed: <b>N/A</b>  |
| Total Height (Ft.): <b>55</b>  | Elevation: <b>1570</b>   |
| Normal Pool Height (Ft.): <b>53</b>  | Elevation: <b>1568</b>   |
| Maximum Capacity (Acre Ft.): <b>1240</b>   | Maximum Area (Acres): <b>21</b>  |
| Normal Capacity (Acre Ft.): <b>1200</b>  | Normal Area (Acres): <b>20</b>   |
| Size Classification: <b>Medium</b>   | Hazard Classification: <b>III</b>  |
| Required Spillway Design Flood: <b>22% PMF</b>   | Available Spillway Design Flood: <b>Impounds PMF</b>   |
| Type of Spillway: <b>N/A</b>   | <i>(Note if Section 130)</i>   |

Operation and Maintenance Plans & Schedule by:  
( ) Reinspection or (X) Inventory Report by:

**AEP/Pedro Jose Amaya-Trujillo, VA PE #036174**  
**AEP/Pedro Jose Amaya-Trujillo, VA PE #036174**

Emergency Action Plan filed with:

- (X) Virginia Dept. of Emergency Management
- (X) Local Coordinator of Emergency Services

City/County: **Russell County**

Application Reviewed and Recommended for: **Six-Year Regular O & M Certificate (3/20/2008-3/31/2014)**

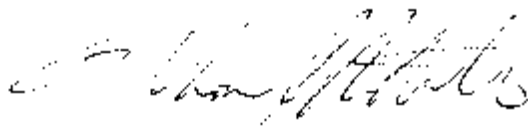

By: **Thomas I Roberts, PE # 19966**

Date: **March 17, 2008**

Concurrence with the Recommendation:



By: **William G. Browning, Director**

Date: **March 19, 2008**

US EPA ARCHIVE DOCUMENT



# COMMONWEALTH of VIRGINIA

DEPARTMENT OF CONSERVATION AND RECREATION  
DIVISION OF DAM SAFETY  
VIRGINIA SOIL AND WATER CONSERVATION BOARD

**DAM SAFETY CERTIFICATE  
REGULAR  
CLASS III OPERATION & MAINTENANCE CERTIFICATE NUMBER 16703**

Appalachian Power Company, owner of Clinch River Fly As Dam #1 in Russell County, is entitled to operate and maintain this dam pursuant to the provisions of the Dam Safety Act (Section 10.1-604 et seq., Code of Virginia) and Regulations promulgated thereunder.

This certificate is for a term of six years. It becomes effective March 20, 2008 and expires March 31, 2014. In accordance with §4VAC50-20-100F of the Regulations, the owner shall apply for a new certificate 90 days prior to its expiration.

*Joseph H. Mason*





Department of Conservation and Forestry  
 Environmental Sciences and Regulatory Services

### EMERGENCY ACTION PLAN FOR CLASS I, CLASS II AND CLASS III IMPOUNDING STRUCTURES

Reference: Impounding Structure Regulations, 4VAC52-20-00 et seq., Virginia Soil and Water Conservation Board

1. Name of Impounding Structure: Clinch River Fly Ash Dike No. 1  
 Inventory Number: 16703  
 Other Name (if any): Ash Area 1A & 1B

2. Hazard Potential Classification from Table I, Virginia Dam Safety Regulations:  
 Class I    Class II    Class III (Underline One)

3. Name of Owner: Appalachian Power Company  
 Address: 40 Franklin Road, PO Box 2021, Roanoke, VA 24022-2121  
 Telephone: (Business)( 800 ) 956-4237 (Residential)(      )

4. Name of Dam Operator: Appalachian Power Company / Clinch River Plant  
 Address: PO Box 370, Cleveland, VA 24225  
 Telephone: (Business)( 776 ) 889-1540 (Residential)(      )

Name of Alternate Operator: Operators are at the plant 24 hours per day  
 Telephone: (Business)(      ) SAME (Residential)(      )

5. Name of Rainfall or Staff Gage Observer for Dam: Team Leader  
 Address: c/o Clinch River Plant - address as above.  
 Telephone: (Business)(      ) (Residential)(      )

Name of Alternate Observer: N/A  
 Telephone: (Business)(      ) (Residential)(      )

6. 24-Hour Dispatch Center Nearest Dam-Police/Fire/Sheriff's

Departments: Russell County Sheriff's Department  
Address: Lebanon, VA 24266  
Telephone: (Business)( 276 ) 889-8033 (Residential)(      )     

7. Name of City/County Emergency Management Coordinator(s): Naomi Honaker

Address: 656 Clydesway Drive  
P.O. Box 997  
Lebanon, VA 24266  
Telephone: (Business)( 276 ) 889-8247 (Residential)( 276 ) 873-4508

8. Name, address and telephone number of all occupied dwellings that would be affected in the event of a dam failure, and/or inundation mapping of affected areas.

| Name  | Address | Telephone Number |
|---|---------|------------------|
| <u>NO occupied dwellings would be affected in the event of a dam failure.</u> |         |                  |
|   |         |                  |
|   |         |                  |
|   |         |                  |
|   |         |                  |
|   |         |                  |
|   |         |                  |
|   |         |                  |
|   |         |                  |
|   |         |                  |
|   |         |                  |
|   |         |                  |
|   |         |                  |

9. Name, address and telephone numbers of owners of all commercial or recreational establishments that would be affected in the event of dam failure, and/or an inundation mapping of affected areas.

| Name  | Address | Telephone Number |
|---|---------|------------------|
| Failure would effect only Virginia Department of Highways - See Item 11 |         |                  |
|   |         |                  |
|   |         |                  |
|   |         |                  |
|   |         |                  |
|   |         |                  |
|   |         |                  |
|   |         |                  |
|   |         |                  |
|   |         |                  |
|   |         |                  |
|   |         |                  |
|   |         |                  |
|   |         |                  |
|   |         |                  |
|   |         |                  |
|   |         |                  |
|   |         |                  |
|   |         |                  |
|   |         |                  |
|   |         |                  |

10. Name, address and telephone number of owners of property, land and unoccupied buildings that would be affected in the event of a dam failure, and/or an inundation mapping of the affected area.

| Name                        | Address | Telephone Number |
|-----------------------------|---------|------------------|
| See Attachment (Same as 15) |         |                  |
|                             |         |                  |
|                             |         |                  |
|                             |         |                  |
|                             |         |                  |
|                             |         |                  |
|                             |         |                  |
|                             |         |                  |
|                             |         |                  |
|                             |         |                  |
|                             |         |                  |
|                             |         |                  |
|                             |         |                  |
|                             |         |                  |
|                             |         |                  |
|                             |         |                  |
|                             |         |                  |
|                             |         |                  |
|                             |         |                  |
|                             |         |                  |
|                             |         |                  |

11. If there are public roads downstream from the impounding structure, identify by highway number and distance below dam:

Route # 616 , 0 Miles;                      Route # 665 , 0 Miles;  
 Route # \_\_\_\_\_ , \_\_\_\_\_ Miles;                      Route # \_\_\_\_\_ , \_\_\_\_\_ Miles.

Provide name of resident engineer, VA Dept. of Transportation, (or City/County engineer)

Mike Branham

Address: Virginia Department of Highways, Lebanon, VA 24266

Telephone: (Business)(276) 889-3131 (Residential)(276) 792-7235

NOTE: Items 12 and 13 should be provided from the Operation and Maintenance Application.

**Definitions:**

Stage I Condition-- A flood watch, or heavy continuous rain or excessive flow of water from ice or snow melt.

Stage II Condition-- A flood warning; or emergency spillway activated or dam overtopping/ breach may be possible.

Stage III Condition -- Emergency spillway activated, dam overtopping or imminent failure is probable.

12. Amount of rainfall that will initiate a:

|                     |  |
|---------------------|--|
| Stage II Condition  | <u>See Attachment</u> inches per 6 hrs.  |
|                     | <u>See Attachment</u> inches per 12 hrs. |
|                     | <u>See Attachment</u> inches per 24 hrs. |
| Stage III Condition | <u>See Attachment</u> inches per 6 hrs.  |
|                     | <u>See Attachment</u> inches per 12 hrs. |
|                     | <u>See Attachment</u> inches per 24 hrs. |

And/or the amount of flow in the emergency spillway that will initiate a:

|                     |                                 |
|---------------------|---------------------------------|
| Stage II Condition  | <u>N/A</u> feet (depth of flow) |
| Stage III Condition | <u>N/A</u> feet (depth of flow) |

Total depth of emergency spillway available before crest of dam is overtopped:  
N/A feet.

13. Frequency of observations by rainfall/staff gage observer during a:

|                   |            |                        |            |
|-------------------|------------|------------------------|------------|
| Stage I Condition | <u>N/A</u> | Stage II               | <u>N/A</u> |
| Stage III         | <u>N/A</u> | (recommend continuous) |            |

Please identify access route and means of travel during flood conditions.

N/A

Note: It is recommended that the Observer remain on post until pool elevation starts to recede.

#### 14. Surveillance and Notification

- a. The dam owner/operator **IS RESPONSIBLE** for notifying local government of any problem or potential problem at the dam site.
- b. The dam owner/operator **WILL INITIATE** dam surveillance under Stage I conditions, ie, when a flood watch is issued.
- c. The dam owner/operator **WILL NOTIFY** the 24-hour dispatch center and the local Emergency Services Coordinator when Stage II conditions are met in order to alert them to review actions that may be required for the safety and protection of people and property.
- d. The dam owner/operator **WILL NOTIFY** the 24-hour dispatch center and the local Emergency Services Coordinator to initiate warning of residents when Stage III conditions or imminent dam failure are probable.
- e. The owner/operator **WILL BE RESPONSIBLE** for operating such devices as spillway gates and low level outlets such as to cause the dam to function effectively. Attach narrative if required.
- f. 24-hour dispatch center should prepare Standard Operating Procedures (SOP's) to implement dam overtopping/failure evacuation plans.

#### 15. Evacuation Procedures:

Note: The dam owner/operator should notify the City/County 24-hour Dispatch Center, as required in paragraph 14d above. Phone # should be listed in [a (1)].

Note: Once the local government has been notified of any problem at a dam site, it should take appropriate protective measures in accordance with the local Emergency Operations Plan and accompanying Emergency Action Plan and Standing Operations Procedures. Other local government actions might include:

- (1) Notify the individuals who are directly downstream and in immediate danger. A list of the names, addresses, and telephone numbers of these individuals should be listed in [a (2)].
- (2) Monitoring the situation and, if time permits, review of evacuation plans.
- (3) Begin Alert, Notification, and Warning
- (4) Immediately evacuating the inundation areas, if conditions warrant.
- (5) Expanding Direction and Control as well as beginning Emergency Public Information and operating shelters.
- (6) Provide Situation Reports to the State Emergency Operations Center (804-674-2400 or 800-468-8892)

a. Once the local government has been notified of a condition requiring evacuation, the dam owner/operator and local government are mutually responsible for effecting evacuation.

(1) The dam owner/operator will: Notify the Russell County 24-hour Dispatch Center, Telephone (276) 889-8833 and the Emergency Management Coordinator, Telephone (276) 889-8247 home(276) 889-4508 or cell (276) 971-7147.

(2) Local government will: Monitor the situation, begin alert notification and warnings, immediately evacuate the inundation areas, if conditions warrant, expand directions and control as well as beginning Emergency Public Information. Provide situation reports to the State Emergency Operations Center. (804) 674-2400 OR (800) 468-8892.

Individuals who are directly downstream and in immediate danger include:

| NAME                  | ADDRESS | TELEPHONE |
|-----------------------|---------|-----------|
| <u>See Attachment</u> |         |           |
|                       |         |           |
|                       |         |           |
|                       |         |           |
|                       |         |           |
|                       |         |           |
|                       |         |           |
|                       |         |           |

b. Methods for notification and warning to evacuate include:

Check appropriate method(s)

- (1) Telephone
- (2) Police/fire/sheriff radio dispatch vehicles with loudspeakers, bullhorns, etc.
- (3) Personal runners for door-to-door alerting
- (4) Radio/television broadcasts for area involved

16. Certification of Coordination between Owner/Operator and Local Government

**Certification by Owner/Operator**

I certify that procedures for implementation of this plan have been coordinated with

Russell County (City/County) and the local Emergency Management Coordinator.

Also, that a copy of this Form has been filed with the State Department of Emergency Management; that this plan shall be adhered to during the life of the project; and that the information contained herein is current and correct to the best of my knowledge.

*Ricky Chafin*  
(Signature of Owner/Operator)

This 6<sup>th</sup> day of February, 2008.

Printed Name Ricky Chafin

**Certification by Local Government**

I certify that procedures for the warning and evacuation of Russell County

(City/County) residents as required in the event of actual or impending failure of the

Clinch River Fly Ash Dike No. 1 (name of dam) have been coordinated with the dam owner/operator.

*Naomi Honater*  
(Signature of City/County Official)

This February day of 11<sup>th</sup>, 2008.

Printed Name Naomi Honater

Position Hazmat/E.M. Coordinator

Please fill out and mail to:

Virginia Department of Emergency Management  
Emergency Services  
10501 Trade Ct.  
Richmond, Virginia 23236-3713

Dept. of Conservation and Recreation  
Division of Dam Safety  
203 Governor Street  
Richmond, Virginia 23219-2094

**EMERGENCY ACTION PLAN WORK/DATA SHEET**

1. Name of Impounding Structure: Clinch River Fly Ash Dike No. 1
2. Inventory #: 16793 Other Name (if any): Ash Storage area JA & 19
3. Total Height: 55' feet (Measured vertically from top of structure to streambed at downstream toe).
4. Total Impoundment Capacity at top of structure: 1246 acre-feet.
5. Size Classification (Circle one): Large Medium Small
6. Hazard Classification (Circle one): Class I Class II Class III
7. Spillway Design (Circle one): PMF  $\frac{1}{2}$ PMF 100-YR 50-YR
8. Downstream Foundation Area determined by (Mark one):
  - (1) Judgement
  - (2) Empirical Formulas Type used: \_\_\_\_\_
  - (3) Computer Programs Type used: \_\_\_\_\_
9. Critical Conditions used for structure failure (Mark one):
  - (1) Failure due to overtopping using:
    - PMF
    - % PMF
    - 100-YR
    - Other
  - (2) Failure not due to flooding
 

Describe: Embankment instability or failure due to piping or erosion.

\_\_\_\_\_

\_\_\_\_\_

\_\_\_\_\_



**Attachment I**

**Item No. 12**

The ash ponds do not receive large quantities of stormwater runoff; therefore, storm event would not result in an overtopping. Water falling directly on the pond will not generate flows which will overtop the structures unless the discharge and emergency overflow systems are not operating simultaneously.

**Item No. 15**

City of St. Paul Water Plant  
P.O. Box 66  
St. Paul, Virginia 24283

Earl Carter  
Office: (276) 762-9683  
Home: (276) 762-7161

St. Paul Police Department  
16531 Russell Street  
St. Paul, Virginia 24283

Office: (276) 762-5022

Wise County PSA Waterworks \*  
Carfax Plant  
Rt. 3, Box 7368  
Coeburn, Virginia 24230

Roy Markham  
Office: (276) 762-0159  
Home: (276) 359-5880

Virginia Department of Environmental Quality  
P.O. Box 976  
Abingdon, Virginia 24210

Michael Overstreet  
Office: (276) 676-4800

Southeast Railroad Contractors, Inc.  
1235 Ohio Avenue  
Salem, Virginia 24153

James P. Aldridge  
Office: (540) 387-1620

\* If unable to contact Wise County PSA Waterworks, please contact the Wise County Sheriff's Department at (276) 328-3566

**Emergency Action Plan**



# DCR

Department of Conservation & Forestry  
DIVISION OF RESOURCES & RECREATION SERVICES

## INVENTORY REPORT FOR CLASS III AND CLASS IV IMPOUNDING STRUCTURES

Reference: Impounding Structure Regulations, 4VAC50-20-00 et seq., Virginia Soil and Water Conservation Board

### 1. Project Information:

- a. Name of Impounding Structure Clinch River Fly Ash Dike No. 1
- b. Inventory Number 16703 Other Name (if any) ---
- c. Name of Reservoir Clinch River Plant Bottom Ponds 1A & 1B
- d. Purpose of Reservoir Sedimentation of Bottom Ash

### 2. Location of Impounding Structure:

- a. City/County Russell County Magisterial District Cleveland
- b. Located adjacent to feet/miles upstream/downstream of Highway No. 665
- c. Name of River or Stream Does not impound, but is near Clinch River
- d. Latitude N36 55' 30" Longitude W82 11' 20"

### 3. Ownership:

- a. Owner's Name Appalachian Power Company
- b. Mailing Address 40 Franklin Road; P.O. Box 2021  
Roanoke, VA 24022-2121
- c. Telephone (800) 956-4237

### 4. Owner's Engineer:

- a. Engineering Firm/Engineer American Electric Power Service Corporation
- b. Professional Engineer Virginia Number Pedro Jose Amaya-Trujillo, VA#036174
- c. Mailing Address 1 Riverside Plaza; Columbus, OH 43215
- d. Telephone (614) 223-1000 OR (614) 223-2926

(DCR 199-104) (12/01)

US EPA ARCHIVE DOCUMENT

AFPC000062

5. Impounding Structure Data (All elevations NGVD unless noted):

a. Type of Material earth   x   concrete        masonry         
 Other       

Design Configuration

b. Top of Dam   1570   Elev. (if known)  
 c. Downstream Toe (Lowest)   1515   Elev. (if known)  
 d. Height of Dam   55   Feet  
 e. Crest Length (Exclusive of Spillway)   3150   Feet  
 f. Crest Width   35   Feet  
 g. Upstream Slope   1.75   H:   1   V  
 h. Downstream Slope   2   H:   1   V

6. Reservoir Data

Design Configuration

a. Maximum Capacity   1240   Acre-feet  
 b. Maximum Pool   1568   Elev. (if known)  
 c. Maximum Pool Surface Area   21   Acres  
 d. Normal Capacity   1115   Acre-feet  
 e. Normal Pool   1A 1568; 1B 1556   Elev. (if known)  
 f. Normal Pool Surface Area   16   Acres  
 g. Freeboard (Normal Pool to Top)   1A 3ft; 1B 14   Feet  
 h. Freeboard (Normal Pool to Emergency)   N/A   Feet

7. Spillway Data

|                       | <u>Type</u>          | <u>Construction Material</u> | <u>Maximum Capacity</u> |
|-----------------------|----------------------|------------------------------|-------------------------|
| a. Low Level Drain    | <u>N/A</u>           | <u>      </u>                | <u>      </u>           |
| b. Principal Spillway | <u>Variable Weir</u> | <u>Steel</u>                 | <u>180 cfs</u>          |
| c. Emergency Spillway | <u>N/A</u>           | <u>      </u>                | <u>      </u>           |

Design Configuration

d. Low Level Drain   None   Elev. (if known)  
 e. Principal Spillway   variable 1555-1568   Elev. (if known)  
 f. Emergency Spillway   None   Elev. (if known)

g. Briefly describe the low level drain and principal spillway to include dimensions, materials of construction, trash guards, location in reservoir and through dam, and orientation of intake and discharge to dam if looking downstream: There is no low level drain because it would become clogged with bottom ash or would discharge bottom ash. Principal spillway is a variable elevation side hill structure with remote control gate valve.

b. Describe the emergency spillway to include dimensions, whether the spillway is an earth channel or other construction, spillway surface protection, and orientation to dam if looking downstream: None - This is an upground reservoir which is filled by pumping.

8. Watershed Data (Class III only):
- a. Drainage Area 22 acres (including pond surface)  
OR .034 Sq. Miles
  - b. Type and Extent of Watershed Development ---
  - c. Time of Concentration --- Method ---
  - d. Spillway Design Flood used (mark appropriate box)
    - PMF, source ---
    - 1/2 PMF, source ---
    - 100 Year, source ---
    - 50 Year, source ---
    - Other, source Not Applicable - upground reservoir
  - e. Design inflow hydrograph: Volume --- acre-feet;  
Peak inflow --- C.F.S.;  
Rainfall duration of design inflow hydrograph --- hours
  - f. Freeboard during passage of spillway design flood --- feet
9. Impounding Structure History
- a. Date construction completed 1964, modified 1971
  - b. Design by Casagrande Consultants Date: unknown
  - c. Built by Unknown Date: 1964

- d. Inspection dates 1978, 1980, 1982, annually from 1984-2005 and 2007
- e. Inspections by Woodward-Clyd Consultants, AEP and Geosytec Consultants
- f. Description of repairs Toe drain rebuilt in 1988. Drainage blanket constructed on d/s slope in 1984. Slurry trench cutoff wall in 1990. North end of toe drain rebuilt in 1991. Drainage blanket to cover most sections of the slope started  
 g. Has the impounding structure ever been overtopped? Yes  No  in 2005.

10. Impounding Structure Assessment:

a. Provide brief descriptions for each item:

- i. Condition of the impounding structure Good
- ii. Condition of the reservoir Good
- iii. Condition of the upstream area Good
- iv. Condition of the downstream area Good

b. Provide a narrative describing any recent changes in the impounding structure, reservoir, upstream area, and downstream area: Continue placement of drainage blanket on d/s slope until the low third is entirely covered.

c. Recommendations for remedial measures: continue routine brush cutting and piezometer readings; fill gullies and rodent burrows if they develop; maintain proper operation of seepage control features.

11. Provide a sketch of the impounding structure.

See Attached Sketch.

CERTIFICATION BY OWNER'S ENGINEER (Class III only)

I hereby certify that the information provided in this Inventory Report has been examined by me and found to be true and correct in my professional judgment.

Signed Pedro J. Araya  
(Professional Engineer)

Virginia Number 036174

This 19<sup>th</sup> day of February, 20 08

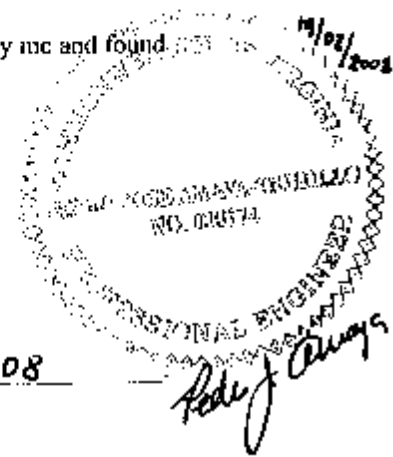

CERTIFICATION BY OWNER (Class IV only)

I hereby certify that the information provided in this Inventory Report is true and correct.

Signed [Signature]  
(Owner)

This 1<sup>st</sup> day of February, 20 08

Please fill out and mail to:  
Department of Conservation and Recreation  
Division of Dam Safety  
203 Governor Street  
Richmond, Virginia 232192094

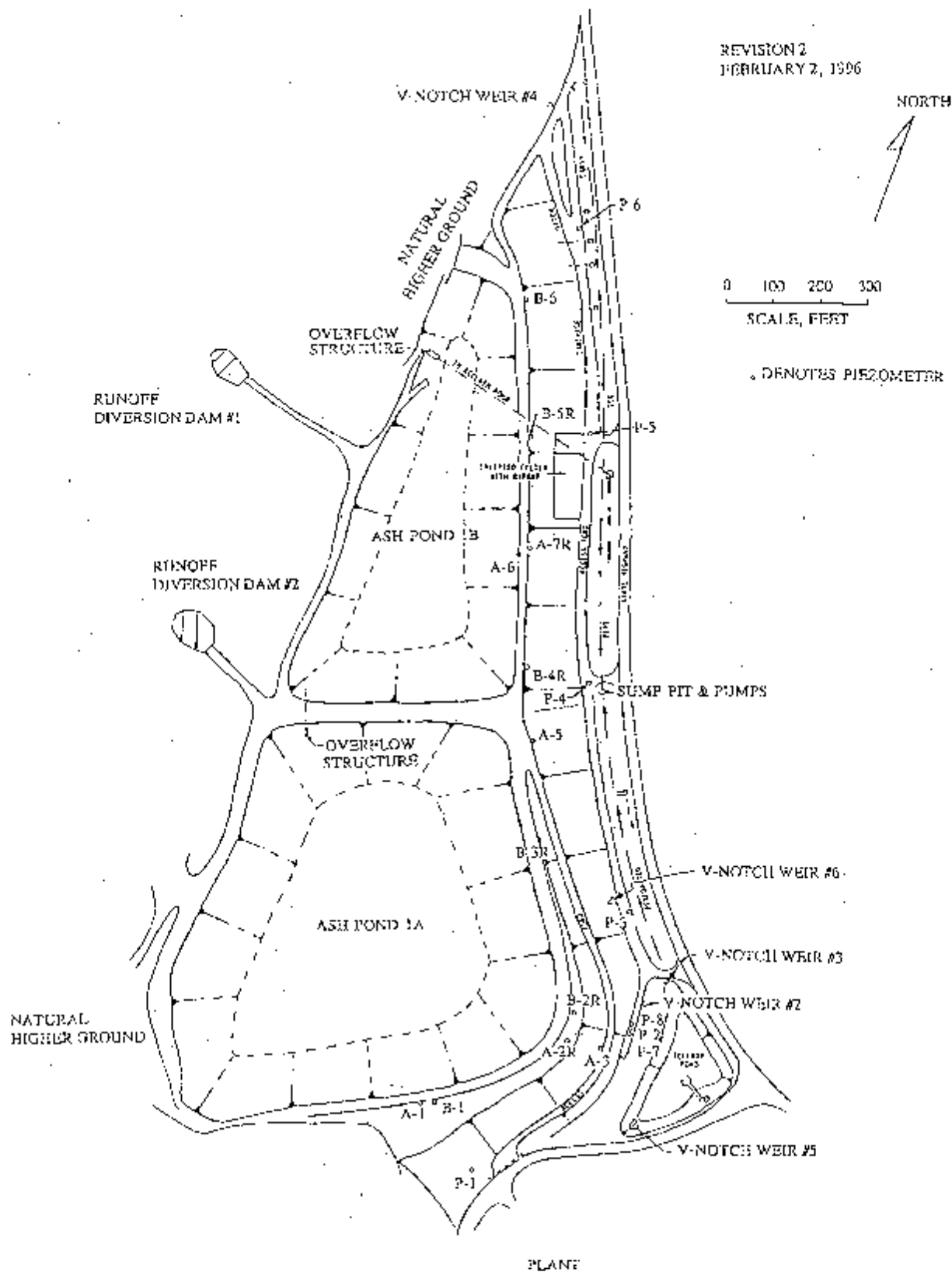



Department of Conservation & Recreation  
100 N. VA. HWY. 211, P.O. BOX 1000, CHARLOTTESVILLE, VA 22902

### OPERATION AND MAINTENANCE APPLICATION CLASS I, II AND III IMPOUNDING STRUCTURES

Reference: Impounding Structures Regulations, 4VAC 50-20-00 et seq., Virginia Soil and Water Conservation Board

1. Name of Impounding Structure: Clinch River Fly Ash Dike No. 1  
Inventory Number: 16703 Other Name (if any) Ash Storage Area 1A & 1B

2. Hazard Potential Classification from Table 1, Impounding Structure Regulations:

(Circle One) Class I Class II Class III

3. Name of Owner: Appalachian Power Company

Address: 40 Franklin Road, P.O. Box 2021, Roanoke, VA 24022-2121

Telephone: (Business) (609) 956-4237 (Residential) ( )

4. Operating Plan and Schedule.

Provide a narrative for each item:

a. Operation of control gates and spillways: See Attachment I

b. Operation of Reservoir Drain (not to exceed 1/2 foot drawdown per day on embankment dams).

See Attachment I

5. Maintenance Plan and Schedule

Provide a narrative for each item:

a. Embankment Dams:

(1) embankment: See Attachment I

(2) principal spillway: See Attachment I

(3) emergency spillway: See Attachment I

(4) low level outlet: See Attachment I

(5) reservoir area: See Attachment I

(6) downstream channel: See Attachment I

(7) other: See Attachment I

b. Concrete dams (including masonry and others):

(1) upstream face: Not Applicable

(DCR 199-099) (12/01)

US EPA ARCHIVE DOCUMENT



- (2) downstream face: \_\_\_\_\_ N/A \_\_\_\_\_
- (3) crest: \_\_\_\_\_ N/A \_\_\_\_\_
- (4) galleries: \_\_\_\_\_ N/A \_\_\_\_\_
- (5) tunnels, etc.: \_\_\_\_\_ N/A \_\_\_\_\_
- (6) abutments: \_\_\_\_\_ N/A \_\_\_\_\_
- (7) spillways: \_\_\_\_\_ N/A \_\_\_\_\_
- (8) gates and outlets: \_\_\_\_\_ N/A \_\_\_\_\_
- (9) other: \_\_\_\_\_ N/A \_\_\_\_\_

6. Inspection schedule (attach schedule and checklist):

- (1) operator inspection (daily, weekly, etc.) Weekly - No Checklist
- (2) maintenance inspection (monthly, quarterly, semi-annual, annual) Quarterly - Checklist Attached
- (3) technical safety reinspection by a professional engineer. (required for certification update: Class I dams every two years, Class II dams every three years. All dams inspected after overtopping). Inspected annually by a professional engineer and submitted to the state.

7. Emergency Action Plan Schedule.

Provide the information that initiates the Emergency Action Plan:

- a. rainfall amounts and/or: This is an upground reservoir with little or no drainage area beyond its own perimeter.
- b. spillway flows: water in-flow is controlled by pumping of ash/water slurry. EAP would be triggered by embankment instability or failure due to piping or erosion.
- c. frequency of observation: \_\_\_\_\_

8. For a newly constructed impounding structure, provide certification from a Professional Engineer who has inspected the impounding structure during construction that, to the best of the engineer's judgment, knowledge and belief, the impounding structure and all appurtenances have been constructed in conformance with the plans, specifications and drawings submitted to the Department of Conservation and Recreation.

Not Applicable

OPERATION AND MAINTENANCE PERMIT APPLICATION

OPERATION AND MAINTENANCE SCHEDULES  
CERTIFICATION BY OWNER

I hereby certify that the operation and maintenance plans and schedules provided herewith will be adhered to during the life of the project except in cases of unanticipated emergency requiring departure therefrom in order to mitigate hazards to life and property, at which time my engineer and the Department of Conservation and Recreation will be notified.

Signed: Paul L. Clark  
(Owner)

This 1st day of February, 2008

CERTIFICATE BY OWNER'S ENGINEER

I hereby certify that the information provided in this form has been examined by me and found in my professional judgment to be appropriate to operation and maintenance considerations for this dam.

Signed: Pedro J. Amaya Virginia Number: 036174  
Professional Engineer

This 19<sup>th</sup> day of February, 2008

Remarks: This upground reservoir has been operated successfully for many years for the purpose of sedimentation of bottom ash. We intend to continue our program of careful operation with frequent periodic inspections and we will continue to perform remedial repairs and maintenance as required by field conditions.

Please fill out and mail this form to:  
Department of Conservation and Recreation  
Division of Dam Safety  
203 Governor Street  
Richmond, Virginia 23219-2094

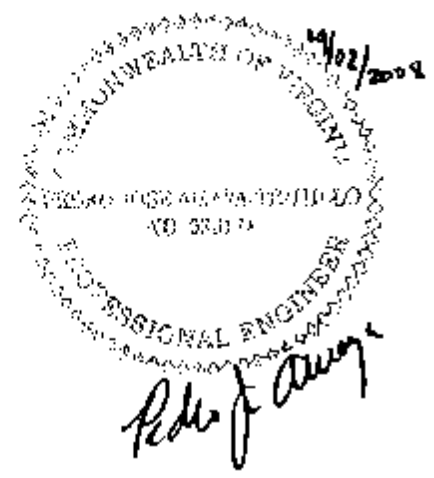

**Attachment I**

- 4a. Operation of control gates and spillways: The discharge structure for this pond consists of a variable elevation vertical drainage shaft connected to a 36-inch diameter reinforced concrete pipe. The overflow elevation of the spillway may be changed by inserting or removing steel plates. Flow is controlled by a pneumatic piston activated slide gate which responds to water level sensors at the recirculation pond. Freeboard is sufficient to store the Probable Maximum Flood.
- 4b. Operation of Reservoir Drain: There is no reservoir drain of this facility because such a drain would either become clogged with bottom ash or would discharge it from the pond. The pond can be drained by pumping, if desired.
- 5a. (1) Embankment: The upstream and downstream slopes are visually inspected by plant personnel several times each week. Items checked for include signs of instability, seepage, rodent burrows, erosion features and vegetative cover. Grass, brush and tree cutting is done as needed. Rodent burrows and erosion gullies are filled in when they are found.
- (2) Principal Spillway: The principal spillway for this upground reservoir consists of a variable elevation side-hill overflow structure connected to a 30-inch diameter discharge pipe. It is inspected visually by plant personnel several times each week, and would be repaired promptly by plant personnel or contract forces if necessary.
- (3) Emergency Spillway: Not applicable – see 4a above.
- (4) Low Level Outlet: Not Applicable
- (5) Reservoir Area: Since this is an upground reservoir, the reservoir area is checked when the upstream slopes are inspected.
- (6) Downstream Channel: The pond's 36-inch diameter discharge pipe terminates at a concrete sump box, where the discharge waters are collected and pumped to a recirculation pond.
- (7) Other: No comment.

**Operation and Maintenance Application**

CLINCH RIVER PLANT  
DIKE INSPECTION CHECKLIST

1. GENERAL INFORMATION

Date of Inspection \_\_\_\_\_  
Inspected by \_\_\_\_\_  
Weather \_\_\_\_\_  
Temperature \_\_\_\_\_  
Rainfall During Past 7 Days \_\_\_\_\_  
Reservoir elevations at  
time of inspection:  
Pond 1A \_\_\_\_\_  
Pond 1B \_\_\_\_\_  
Pond 2 \_\_\_\_\_

2. EMBANKMENT CONDITION AT PONDS 1A & 1B

Please refer to the Ash Area 1 Dike Inspection Location Plan which is found on Page 8. Place a number and a descriptive sketch on the location plan at each problem area. Place the same number(s) next to the appropriate description(s) below.

| <u>DESCRIPTION</u> | <u>LOCATION NUMBERS</u> |
|--------------------|-------------------------|
| Cracks             | _____                   |
| Bulges             | _____                   |
| Sliding            | _____                   |
| Erosion            | _____                   |
| Soft Soil          | _____                   |

Leaking Pipe \_\_\_\_\_  
 Seepage/Wetness \_\_\_\_\_  
 Vegetative Cover \_\_\_\_\_  
 Trees on Slope \_\_\_\_\_  
 Hillside Runoff Drain #1 \_\_\_\_\_  
 Hillside Runoff Drain #2 \_\_\_\_\_  
 Rodent Burrows \_\_\_\_\_  
 Other (Please Specify) \_\_\_\_\_

3. PIEZOMETERS READINGS AT PONDS 1A & 1B

| <u>PIEZ. NO.</u> | <u>ELEV., TOP OF TUBE</u> | <u>DEPTH TO WATER FROM TOP OF TUBE</u> | <u>WATER ELEVATION</u> | <u>COMMENTS</u> |
|------------------|---------------------------|--|------------------------|-----------------|
| A-1              | 1571.0                    | _____                                  | _____                  | _____           |
| A-2R             | 1569.5                    | _____                                  | _____                  | _____           |
| A-3              | 1535.0                    | _____                                  | _____                  | _____           |
| A-5              | 1572.2                    | _____                                  | _____                  | _____           |
| A-6              | 1571.3                    | _____                                  | _____                  | _____           |
| A-7R             | 1572.0                    | _____                                  | _____                  | _____           |
| B-1              | 1571.2                    | _____                                  | _____                  | _____           |
| B-2R             | 1571.1                    | _____                                  | _____                  | _____           |
| B-3R             | 1570.9                    | _____                                  | _____                  | _____           |
| B-4R             | 1571.1                    | _____                                  | _____                  | _____           |
| B-5R             | 1571.4                    | _____                                  | _____                  | _____           |
| B-6              | 1571.8                    | _____                                  | _____                  | _____           |
| P-1              | 1529.9                    | _____                                  | _____                  | _____           |

|     |        |       |       |       |
|-----|--------|-------|-------|-------|
| P-2 | 1520.6 | _____ | _____ | _____ |
| P-3 | 1519.9 | _____ | _____ | _____ |
| P-4 | 1518.6 | _____ | _____ | _____ |
| P-5 | 1512.6 | _____ | _____ | _____ |
| P-6 | 1517.0 | _____ | _____ | _____ |
| P-7 | 1523.2 | _____ | _____ | _____ |
| P-8 | 1521.2 | _____ | _____ | _____ |

4. V-NOTCH WEIRS

Please determine the flow rate in gallons per minute for each of the V-notch weirs. This can be done by measuring the head H of water above the apex of the V-notch to the nearest 1/4 inch and comparing it to the chart below.

| HEAD, H,<br>INCHES | FLOW RATE, GPM |           | HEAD, H,<br>INCHES | FLOW RATE, GPM |           |
|--------------------|----------------|-----------|--------------------|----------------|-----------|
|                    | 90° WEIR       | 22½° WEIR |                    | 90° WEIR       | 22½° WEIR |
| 1                  | 2              | 0.75      | 3                  | 37             | 7.2       |
| 1 1/4              | 4              | 1         | 3 1/4              | 45             | 8.9       |
| 1 1/2              | 6              | 1.4       | 3 1/2              | 53             | 10.8      |
| 1 3/4              | 9              | 1.9       | 3 3/4              | 65             | 12.5      |
| 2                  | 12             | 2.6       | 4                  | 76             | 14.5      |
| 2 1/4              | 17             | 3.4       | 4 1/4              | 88             | 16.8      |
| 2 1/2              | 24             | 4.6       | 4 1/2              | 100            | 19        |
| 2 3/4              | 30             | 5.9       | 4 3/4              | 114            | 21.6      |

V-notch Weir #1: \_\_\_\_\_ gallons per minute  
 V-notch Weir #2: \_\_\_\_\_ gallons per minute  
 V-notch Weir #3: \_\_\_\_\_ gallons per minute  
 V-notch Weir #4: \_\_\_\_\_ gallons per minute  
 V-notch Weir #5: \_\_\_\_\_ gallons per minute  
 V-notch Weir #6: \_\_\_\_\_ gallons per minute

5. SEEPAGE COLLECTION SUMP

Please determine the flow rate, in gallons per minute, of the two branches of the French drain at the 8 foot diameter seepage collection sump. This can be done by measuring how much the water

level rises while recording the time during a period when both pumps are off. Flow rate is given by the following formula:

$$\text{FLOW RATE,} = \frac{(3.1416)(16)(7.48)(60)H}{t}$$

in which H = rise of water level in feet during the unpumped time interval t, in seconds.

FLOW RATE = \_\_\_\_\_ GALLONS PER MINUTE

6. DISCHARGE STRUCTURE AT POND 1B

Please note the conditions with regard to the following:

Condition of concrete \_\_\_\_\_

Are stoplogs available? \_\_\_\_\_

Obstructions \_\_\_\_\_

Foreign object in pond? \_\_\_\_\_

Pedestrian access O.K.? \_\_\_\_\_

Erosion Problems \_\_\_\_\_

Other (Please specify) \_\_\_\_\_

7. MISCELLANEOUS AT PONDS 1A & 1B

Is seepage repair area O.K.? \_\_\_\_\_

What is condition of French drain? Is white precipitate building up impeding drainage? \_\_\_\_\_

What is the overall condition of the discharge structure from Pond 1A to Pond 1B? \_\_\_\_\_

Are seepage sump pumps O.K.? \_\_\_\_\_  
\_\_\_\_\_

Is entrance to 24" seepage overflow pipe clear of  
obstructions? \_\_\_\_\_  
\_\_\_\_\_

8. PONDS 1A & 1B NOTES AND COMMENTS INCLUDING JOB ORDERS  
WRITTEN AND REPAIRS/MAINTENANCE SINCE LAST INSPECTION:

\_\_\_\_\_  
\_\_\_\_\_  
\_\_\_\_\_  
\_\_\_\_\_  
\_\_\_\_\_

9. EMBANKMENT CONDITION AT POND 2 AREA

Please refer to the Ash Area 2 Dike Inspection Location Plan which is found on Page 9. Place a number and a descriptive sketch on the location plan at each problem area. Place the same number(s) next to the appropriate description(s) below.

| <u>DESCRIPTION</u> | <u>LOCATION NUMBERS</u> |
|--------------------|-------------------------|
| Cracks             | _____                   |
| Bulges             | _____                   |
| Sliding            | _____                   |
| Erosion            | _____                   |
| Soft Soil          | _____                   |
| Leaking Pipe       | _____                   |
| Seepage/Wetness    | _____                   |



| <u>DESCRIPTION</u>     | <u>LOCATION NUMBERS</u> |
|------------------------|-------------------------|
| Vegetative Cover       | _____                   |
| Trees on Slope         | _____                   |
| Rodent Burrows         | _____                   |
| Other (Please Specify) | _____                   |

10. PIEZOMETER READINGS AT PCND 2 AREA

| <u>PIEZ.</u><br><u>NO.</u> | <u>ELEV., TOP</u><br><u>OF TUBE</u> | <u>DEPTH TO</u><br><u>WATER FROM</u><br><u>TOP OF TUBE</u> | <u>WATER</u><br><u>ELEVATION</u> | <u>COMMENTS</u> |
|----------------------------|-------------------------------------|--|----------------------------------|-----------------|
| P-1                        | 1557.0                              | _____  | _____                            | _____           |
| P-2                        | 1555.8                              | _____  | _____                            | _____           |
| P-3                        | 1536.7                              | _____  | _____                            | _____           |
| P-4                        | 1557.4                              | _____  | _____                            | _____           |
| P-5                        | 1557.7                              | _____  | _____                            | _____           |
| P-6                        | 1557.4                              | _____  | _____                            | _____           |
| P-7                        | 1557.9                              | _____  | _____                            | _____           |
| P-8                        | 1557.4                              | _____  | _____                            | _____           |
| P-9                        | 1558.2                              | _____  | _____                            | _____           |
| U-1                        | 1560.0                              | _____  | _____                            | _____           |
| U-2                        | 1561.1                              | _____  | _____                            | _____           |
| U-3                        | 1560.0                              | _____  | _____                            | _____           |
| U-4                        | 1560.0                              | _____  | _____                            | _____           |
| L-5                        | 1532.0                              | _____  | _____                            | _____           |
| L-6                        | 1532.0                              | _____  | _____                            | _____           |
| L-7                        | 1535.3                              | _____  | _____                            | _____           |
| L-8                        | 1534.7                              | _____  | _____                            | _____           |

11. IS PERFORATED DRAIN PIPE BETWEEN LOWER LEVEL AND MIDDLE LEVEL  
DIKES WORKING PROPERLY AND IN GOOD CONDITION?

---

---

---

12. DISCHARGE STRUCTURE AT POND 2

Please note the conditions with regard to the following:

Condition of concrete 

---

Gates/valves operational? 

---

Obstructions 

---

Is access clear? 

---

Erosion problems 

---

Other (Please specify) 

---

13. POND 2: NOTES AND COMMENTS INCLUDING JOB ORDERS WRITTEN AND  
REMEDIAL WORK DONE SINCE LAST INSPECTION

---

---

---

---

---

---

---

---

---

---

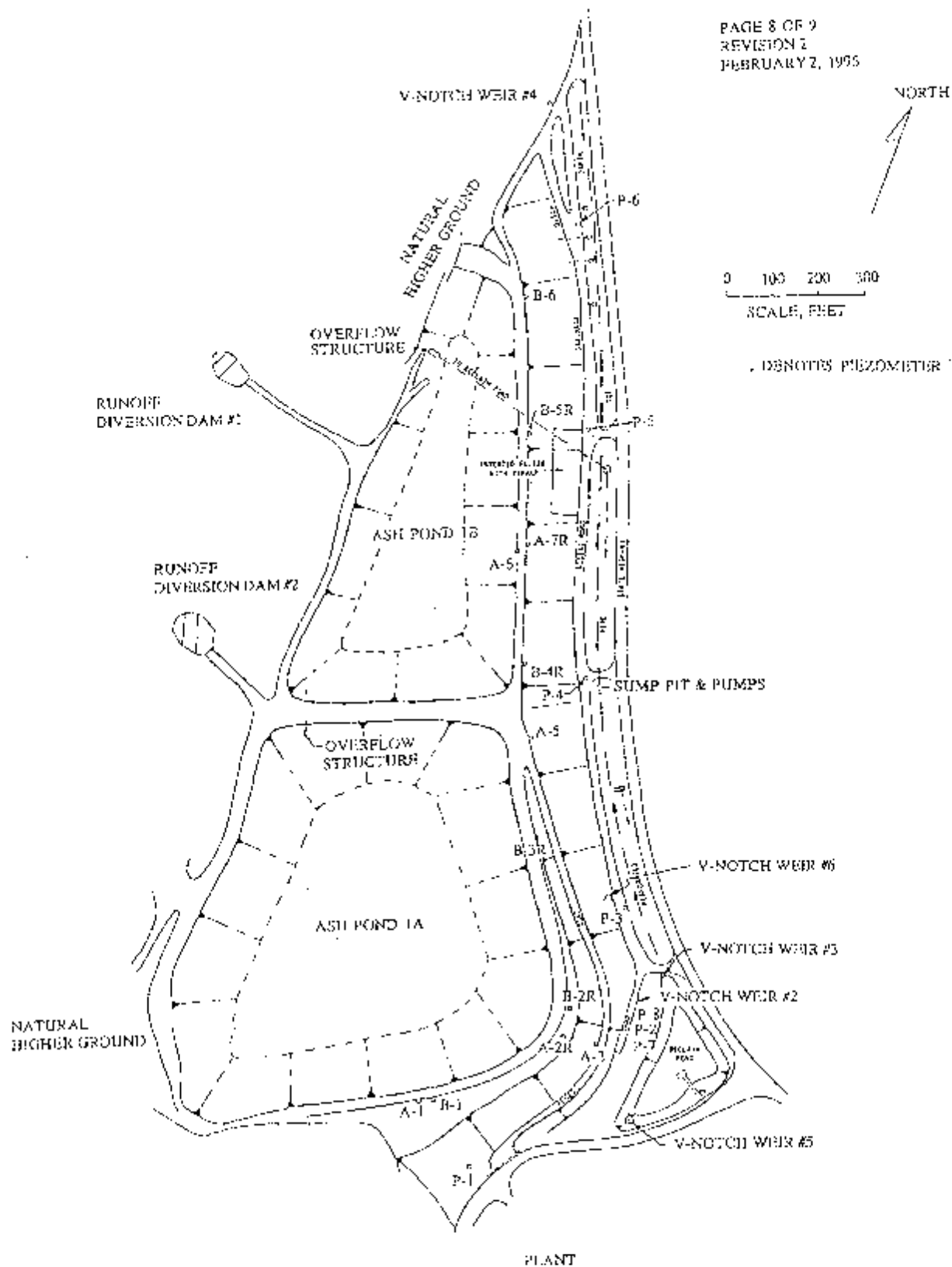

CINCINNATI RIVER PLANT - ASH POND 1 DIKE INSPECTION LOCATIONS PLAN



L. Preston Bryant, Jr.  
Secretary of Natural Resources



Joseph H. Maroon  
Director

**COMMONWEALTH of VIRGINIA**  
**DEPARTMENT OF CONSERVATION AND RECREATION**

203 Governor Street, Suite 206  
Richmond, Virginia 23219-2010  
(804) 371-6095 Fax (804) 371-2630

April 4, 2008

Appalachian Power Company  
Attn: William Smith  
Post Office Box 2021  
Roanoke, VA 24022

RE: Clinch River Fly Ash Dam #2, Inventory Number 16702

Dear Mr. Smith:

The Operation and Maintenance Certificate Application for Clinch River Fly Ash Dam #2, Inventory Number 16702, and the required supporting documents have been reviewed for compliance with the provisions of the Code of Virginia, Dam Safety Act, (Section 10.1-604 et. seq.) and the regulations promulgated by the Virginia Soil and Water Conservation Board (Board). Based on this information, on March 20, 2008, the Board issued a six-year (03/20/2008 - 3/31/2014) Regular Class III Operation and Maintenance Certificate (Certificate). The Certificate and other pertinent data are enclosed.

The Dam Safety Act requires dam owners to maintain their dam in a condition to prevent unreasonable threats to life and property of others. The classification of your dam and the Certificate issued were based on the current known downstream hazard potential from upstream characteristics, a re-inspection report, operation and maintenance application, and an emergency action plan. The actions contained in the documents accompanying your Certificate Application must be adhered to for the duration of the terms contained in the Certificate. To assist you in adhering to the terms of the Certificate, the following table provides a schedule of dates to submit required documents.

| Annual Owner's Inspection Report | Owner's Engineer Inventory Report | Renewal Certification Six Year Application by Owner and Owner's Engineer |
|----------------------------------|-----------------------------------|--|
| 03/31/2009                       |                                   |  |
| 03/31/2010                       |                                   |  |
| 03/31/2011                       |                                   |  |
| 03/31/2012                       |                                   |  |
| 03/31/2013                       | 12/31/2013                        | 12/31/2013   |

Should you have questions, please direct them to Thomas I. Roberts, P.E., Dam Safety Regional Engineer, Department of Conservation and Recreation, Dam Safety and Floodplain Management Division, 8 Radford Street, Suite 203, Christiansburg, VA 24073, telephone 540-394-2550 or via e-mail at [Thomas.Roberts@dcr.virginia.gov](mailto:Thomas.Roberts@dcr.virginia.gov).

Sincerely,



William G. Browning  
Director, Dam Safety & Floodplain Management Division

Enclosures as stated:

- c: James M. Robinson, P.E., Dam Safety Program Manager
- Thomas I. Roberts, P.E. Dam Safety Regional Engineer

US EPA ARCHIVE DOCUMENT

**DATA SHEET - OPERATION AND MAINTENANCE CERTIFICATE**

Department of Conservation & Recreation  
 Division of Dam Safety & Floodplain Management  
 203 Governor Street, Suite 206  
 Richmond, VA 23219-2094

|                                |  |                                 |                         |
|--------------------------------|--|---------------------------------|-------------------------|
| Name of Dam                    | Clinch River Fly Ash Dam No. 2                   | Inventory Number                | 16702                   |
| Location                       | Offstream Dam Near New River                     | City/County                     | Russell                 |
| Owner                          | Appalachian Power Company<br>Attn: William Smith | Designed by                     | Casa Grande Consultants |
| Address                        | 40 Franklin Road, P.O. Box 2021                  | Constructed by                  | Unknown                 |
| City/Town/Zip                  | Roanoke, VA 24022-2121                           | Year Constructed                | 1964                    |
| Type of Dam                    | Rockfill   | Purpose                         | Sediment-Fly Ash        |
| Drainage Area (Sq. Mi.)        | 0.02   | Type of Watershed               | N/A                     |
| Total Height (Ft.)             | 65   | Elevation                       | 1560                    |
| Normal Pool Height (Ft.)       | 62   | Elevation                       | 1557                    |
| Maximum Capacity (Acre Ft.)    | 157  | Maximum Area (Acres)            | 11                      |
| Normal Capacity (Acre Ft.)     | 82   | Normal Area (Acres)             | 10                      |
| Size Classification            | Medium   | Hazard Classification           | III                     |
| Required Spillway Design Flood | 28% PMF  | Available Spillway Design Flood | Impounds PMF            |
| Type of Spillway               | N/A  | <i>(Note if Section 130)</i>    |                         |

Operation and Maintenance Plans & Schedule by AEP/Pedro Jose Amaya-Trujillo, VA PE #036174  
 ( ) Reinspection or (X) Inventory Report by AEP/Pedro Jose Amaya-Trujillo, VA PE #036174

Emergency Action Plan filed with  
 (X) Virginia Dept. of Emergency Management  
 (X) Local Coordinator of Emergency Services  
 City/County: Russell County

Application Reviewed and Recommended for: Six-Year Regular O & M Certificate (3/20/2008-3/31/2014)



By: Thomas I Roberts, PE # 19966 Date: March 18, 2008

Concurrence with the Recommendation:

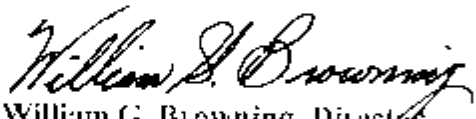

By: William G. Browning, Director Date: March 19, 2008

US EPA ARCHIVE DOCUMENT



# COMMONWEALTH of VIRGINIA

DEPARTMENT OF CONSERVATION AND RECREATION  
DIVISION OF DAM SAFETY  
VIRGINIA SOIL AND WATER CONSERVATION BOARD

**DAM SAFETY CERTIFICATE  
REGULAR  
CLASS III OPERATION & MAINTENANCE CERTIFICATE NUMBER 16702**

Appalachian Power Company, owner of Clinch River Fly Ash Dam #2 in Russell County, is entitled to operate and maintain this dam pursuant to the provisions of the Dam Safety Act (Section 10.1-604 et seq., Code of Virginia) and Regulations promulgated thereunder.

This certificate is for a term of six years. It becomes effective March 20, 2008 and expires March 31, 2014. In accordance with §4VAC50-20-100F of the Regulations, the owner shall apply for a new certificate 90 days prior to its expiration.

*Joseph H. Mason*





Department of Conservation & Recreation  
1000 COMMONWEALTH AVENUE, SUITE 1000  
RICHMOND, VA 23260-0001

### EMERGENCY ACTION PLAN FOR CLASS I, CLASS II AND CLASS III IMPOUNDING STRUCTURES

Reference: Impounding Structure Regulations, 4VAC52-20-00 et seq., Virginia Soil and Water Conservation Board

1. Name of Impounding Structure: Clinch River Fly Ash Dike No. 2  
Inventory Number: 16702  
Other Name (if any): Ash Area #2

2. Hazard Potential Classification from Table I, Virginia Dam Safety Regulations:  
Class I    Class II    Class III (Underline One)

3. Name of Owner: Appalachian Power Company  
Address: 40 Franklin Road, PO Box 2021, Roanoke, VA 24022 2121  
Telephone: (Business)(800) 958-4237 (Residential)( )

4. Name of Dam Operator: Appalachian Power Company / Clinch River Plant  
Address: PO Box 370, Cleveland, VA 24225  
Telephone: (Business)(275) 889-1540 (Residential)( )

Name of Alternate Operator: Operators are at the plant 24 hours per day  
Telephone: (Business)( ) same (Residential)( )

5. Name of Rainfall or Staff Gage Observer for Dam: Team Leader  
Address: c/o Clinch River Plant - address as above  
Telephone: (Business)( ) (Residential)( )

Name of Alternate Observer: N/A  
Telephone: (Business)( ) (Residential)( )

US EPA ARCHIVE DOCUMENT

6 24-Hour Dispatch Center Nearest Dam-Police/Fire/Sheriffs

Departments: Russell County Sheriff's Department

Address: Lebanon, VA 24266

Telephone: (Business)( 575 ) 889-9033 (Residential)(     )    

7. Name of City/County Emergency Management Coordinator(s): Wanda Horaker

Address: 556 Clydeway Drive Suite A

P.O. Box 997

Lebanon, VA 24266

Telephone: (Business)( 275 ) 883-8247 (Residential)( 275 ) 873-4309

8. Name, address and telephone number of all occupied dwellings that would be affected in the event of a dam failure, and/or inundation mapping of affected areas

| Name   | Address | Telephone Number |
|--|---------|------------------|
| NO occupied dwellings would be affected in the event of a dam failure. |         |                  |
|  |         |                  |
|  |         |                  |
|  |         |                  |
|  |         |                  |
|  |         |                  |
|  |         |                  |
|  |         |                  |
|  |         |                  |
|  |         |                  |

9. Name, address and telephone numbers of owners of all commercial or recreational establishments that would be effected in the event of dam failure, and/or an inundation mapping of affected areas.

| Name  | Address | Telephone Number |
|---|---------|------------------|
| Failure would affect only Virginia Department of Highways - See item 11 |         |                  |
|   |         |                  |
|   |         |                  |
|   |         |                  |
|   |         |                  |
|   |         |                  |
|   |         |                  |
|   |         |                  |
|   |         |                  |
|   |         |                  |
|   |         |                  |

10. Name, address and telephone number of owners of property, land and unoccupied buildings that would be affected in the event of a dam failure, and/or an inundation mapping of the affected area.

| Name                        | Address | Telephone Number |
|-----------------------------|---------|------------------|
| See Attachment (Same as 15) |         |                  |
|                             |         |                  |
|                             |         |                  |
|                             |         |                  |
|                             |         |                  |
|                             |         |                  |
|                             |         |                  |
|                             |         |                  |
|                             |         |                  |
|                             |         |                  |

11. If there are public roads downstream from the impounding structure, identify by highway number and distance below dam:

Route # 616 , 0 Miles;      Route # 595 , 0.25 Miles;  
 Route # \_\_\_\_\_ , \_\_\_\_\_ Miles;      Route # \_\_\_\_\_ , \_\_\_\_\_ Miles

Provide name of resident engineer, VA Dept. of Transportation, (or City/County engineer)

Mike Branchum

Address: Virginia Department of Highways, Lebanon, VA 24266

Telephone: (Business)( 275 ) 880 3131 (Residential)( 275 ) 754-7235

NOTE: items 12 and 13 should be provided from the Operation and Maintenance Application.

**Definitions:**

Stage I Condition - A flood watch, or heavy continuous rain or excessive flow of water from ice or snow melt.

Stage II Condition - A flood warning; or emergency spillway activated or dam overtopping/ breach may be possible

Stage III Condition - Emergency spillway activated, dam overtopping or imminent failure is probable.

12. Amount of rainfall that will initiate a:

|                     |   |
|---------------------|---|
| Stage II Condition  | <u>See Attachment</u> inches per 6 hrs  |
|                     | <u>See Attachment</u> inches per 12 hrs |
|                     | <u>See Attachment</u> inches per 24 hrs |
| Stage III Condition | <u>See Attachment</u> inches per 6 hrs. |
|                     | <u>See Attachment</u> inches per 12 hrs |
|                     | <u>See Attachment</u> inches per 24 hrs |

And/or the amount of flow in the emergency spillway that will initiate a:

|                     |                                 |
|---------------------|---------------------------------|
| Stage II Condition  | <u>N/A</u> feet (depth of flow) |
| Stage III Condition | <u>N/A</u> feet (depth of flow) |

Total depth of emergency spillway available before crest of dam is overtopped:

N/A feet

13. Frequency of observations by rainfall/staff gage observer during a:

Stage I Condition N/A      Stage II N/A

Stage III N/A (recommend continuous)

Please identify access route and means of travel during flood conditions

N/A

Note: It is recommended that the Observer remain on post until pool elevation starts to recede

#### 14. Surveillance and Notification

- a. The dam owner/operator IS RESPONSIBLE for notifying local government of any problem or potential problem at the dam site
- b. The dam owner/operator WILL INITIATE dam surveillance under Stage I conditions, i.e. when a flood watch is issued
- c. The dam owner/operator WILL NOTIFY the 24-hour dispatch center and the local Emergency Services Coordinator when Stage II conditions are met in order to alert them to review actions that may be required for the safety and protection of people and property
- d. The dam owner/operator WILL NOTIFY the 24-hour dispatch center and the local Emergency Services Coordinator to initiate warning of residents when Stage III conditions or imminent dam failure are probable.
- e. The owner/operator WILL BE RESPONSIBLE for operating such devices as spillway gates and low level outlets such as to cause the dam to function effectively Attech narrative if required
- f. 24-hour dispatch center should prepare Standard Operating Procedures (SOP's) to implement dam overtopping/failure evacuation plans.

#### 15. Evacuation Procedures:

Note: The dam owner/operator should notify the City/County 24-hour Dispatch Center, as required in paragraph 14d above. Phone # should be listed in [a (1)].

Note: Once the local government has been notified of any problem at a dam site, it should take appropriate protective measures in accordance with the local Emergency Operations Plan and accompanying Emergency Action Plan and Standing Operations Procedures. Other local government actions might include:

- (1) Notify the individuals who are directly downstream and in immediate danger. A list of the names, addresses, and telephone numbers of these individuals should be listed in [a (2)]
- (2) Monitoring the situation and, if time permits, review of evacuation plans
- (3) Begin Alert, Notification, and Warning
- (4) Immediately evacuating the inundation areas, if conditions warrant.
- (5) Expanding Direction and Control as well as beginning Emergency Public Information and operating shelters.
- (6) Provide Situation Reports to the State Emergency Operations Center (804-674-2400 or 800-468-8892)

- a. Once the local government has been notified of a condition requiring evacuation, the dam owner/operator and local government are mutually responsible for effecting evacuation.

(1) The dam owner/operator will notify the Russell County 24-hour Dispatch Center, Telephone (276) 889-8033 and the Emergency Management Coordinator, Telephone (276) 889-8247 home(276) 869-1508 or cell (276) 977-7147

(2) Local government will monitor the situation, begin alarm notification and warnings, immediately evacuate the inundation areas, if conditions warrant. Expand directions and control as well as beginning Emergency Public Information. Provide situation reports to the State Emergency Operations Center, (904) 674-2400 OR (850) 468 8082.

Individuals who are directly downstream and in immediate danger include:

| NAME | ADDRESS | TELEPHONE |
|------|---------|-----------|
|------|---------|-----------|

See Attachment

- b. Methods for notification and warning to evacuate include:

Check appropriate method(s)

- (1) Telephone
- (2) Police/fire/sheriff radio dispatch vehicles with loudspeakers, bullhorns, etc.
- (3) Personal runners for door-to-door alerting
- (4) Radio/television broadcasts for area involved

16. Certification of Coordination between Owner/Operator and Local Government

**Certification by Owner/Operator**

I certify that procedures for implementation of this plan have been coordinated with

Russell County (City/County) and the local Emergency Management Coordinator

Also, that a copy of this form has been filed with the State Department of Emergency Management; that this plan shall be adhered to during the life of the project; and that the information contained herein is current and correct to the best of my knowledge

*Ricky Chatfield*  
(Signature of Owner/Operator)

This 6<sup>th</sup> day of February, 2008

Printed Name Ricky Chatfield

**Certification by Local Government**

I certify that procedures for the warning and evacuation of Russell County

(City/County) residents as required in the event of actual or impending failure of the

Glinch River Fly Ash Dike No. 2 (name of dam) have been coordinated with the dam owner/operator

*Naomi Hanater*  
(Signature of City/County Official)

This February day of 11<sup>th</sup>, 2008

Printed Name Naomi Hanater

Position Hazmat/E.M. Coordinator

Please fill out and mail to:

Virginia Department of Emergency Management  
Emergency Services  
10501 Trade Ct.  
Richmond, Virginia 23236-3713

Dept. of Conservation and Recreation  
Division of Dam Safety  
203 Governor Street  
Richmond, Virginia 23219-2094

EMERGENCY ACTION PLAN WORK/DATA SHEET

1. Name of Impounding Structure: Clinch v/vor Fly Ash Dike

2. Inventory #: 16/92 Other Name (if any): Ash Storage Area #2 (inactive)

3. Total Height: 56' feet (Measured vertically from top of structure to streambed at downstream toe)

4. Total Impoundment Capacity at top of structure: 326 acre-feet

5. Size Classification (Circle one): Large Medium Small

6. Hazard Classification (Circle one): Class I Class II Class III

7. Spillway Design (Circle one): PMI 1/2 PMI-100-YR 50-YR

8. Downstream foundation Area determined by (Mark one):

(1) Judgment

(2) Empirical Formulas Type used: \_\_\_\_\_

(3) Computer Programs Type used: \_\_\_\_\_

9. Critical Conditions used for structure failure (Mark one):

(1) Failure due to overtopping using:

PMF

% PMI

100-YR

Other

(2) Failure not due to flooding

Describe: Subsidence instability or failure due to piping or erosion.

\_\_\_\_\_  
\_\_\_\_\_  
\_\_\_\_\_

US EPA ARCHIVE DOCUMENT



**Attachment I**

**Item No. 12**

The ash ponds do not receive large quantities of stormwater runoff, therefore, storm event would not result in an overtopping. Water falling directly on the pond will not generate flows which will overtop the structures unless the discharge and emergency overflow systems are not operating simultaneously. The facility has been inactive since November 1995. The upper Dike was removed in 1998 with permission from the Department of Conservation & Recreation - Dam Safety.

**Item No. 15**

City of St. Paul Water Plant  
P.O. Box 66  
St. Paul, Virginia 24283

Earl Carter  
Office: (276) 762-9683  
Home: (276) 762-7161

St. Paul Police Department  
16531 Russell Street  
St. Paul, Virginia 24283

Office: (276) 762-5022

Wise County PSA Waterworks<sup>\*</sup>  
Carfax Plant  
Rt. 3, Box 7368  
Coeburn, Virginia 24230

Roy Mankham  
Office: (276) 762-0159  
Home: (276) 359-5880

Virginia Department of Environmental Quality  
P.O. Box 976  
Abingdon, Virginia 24210

Michael Overstreet  
Office: (276) 676-4800

Southeast Railroad Contractors, Inc.  
1235 Ohio Avenue  
Salem, Virginia 24153

James P. Aldridge  
Office: (540) 387-1620

<sup>\*</sup> If unable to contact Wise County PSA Waterworks, please contact the Wise County Sheriff's Department at (276) 328-3566

**Emergency Action Plan**



Department of Conservation & Recreation  
SUPPORTING BUSINESS, NATURE & RECREATION RESOURCES

### OPERATION AND MAINTENANCE APPLICATION CLASS I, II AND III IMPOUNDING STRUCTURES

Reference: Impounding Structures Regulations, 4VAC 50-20-01 et seq., Virginia Soil and Water Conservation Board

1. Name of Impounding Structure: Clinch River Fly Ash Dike No. 7  
Inventory Number: 18702 Other Name (if any): \_\_\_\_\_

2. Hazard Potential Classification from Table I, Impounding Structures Regulations:

(Circle One) Class I Class II Class III

3. Name of Owner: Appalachian Power Company

Address: 40 Franklin Road, P.O. Box 2021, Roanoke, VA 24021-2121

Telephone: (Business) (804) 356-4232 (Residential) ( ) \_\_\_\_\_

4. Operating Plan and Schedule

Provide a narrative for each item:

a. Operation of control gates and spillways: See Attachment I

b. Operation of Reservoir Drain (not to exceed 1/8 foot drawdown per day on embankment dams):

See Attachment I

5. Maintenance Plan and Schedule

Provide a narrative for each item:

a. Embankment Dams:

(1) embankment: See Attachment I

(2) principal spillway: See Attachment I

(3) emergency spillway: See Attachment I

(4) low level outlet: See Attachment I

(5) reservoir area: See Attachment I

(6) downstream channel: See Attachment I

(7) other: See Attachment I

b. Concrete dams (including masonry and others):

(1) upstream face: Not Applicable

- (2) downstream face: \_\_\_\_\_ N/A \_\_\_\_\_
- (3) crest: \_\_\_\_\_ N/A \_\_\_\_\_
- (4) galleries: \_\_\_\_\_ N/A \_\_\_\_\_
- (5) tunnels, etc.: \_\_\_\_\_ N/A \_\_\_\_\_
- (6) abutments: \_\_\_\_\_ N/A \_\_\_\_\_
- (7) spillways: \_\_\_\_\_ N/A \_\_\_\_\_
- (8) gates and outlets: \_\_\_\_\_ N/A \_\_\_\_\_
- (9) other: \_\_\_\_\_ N/A \_\_\_\_\_

6. Inspection schedule (attach schedule and checklist):

- (1) operator inspection (daily, weekly, etc) Weekly - No Checklist
- (2) maintenance inspection (monthly, quarterly, semi-annual, annual) Quarterly - Checklist Attached
- (3) technical safety reinspection by a professional engineer. (required for certification update: Class I dams every two years, Class II dams every three years. All dams inspected after overtopping)

Inspected annually by a professional engineer and submitted to the state.

7. Emergency Action Plan Schedule

Provide the information that initiates the Emergency Action Plan:

- a. rainfall amounts and/or: This is an unground reservoir with little or no drainage area beyond its own perimeter
- b. spillway flows: water in-flow is controlled by pumping of ash/water slurry. EAP would be triggered by embankment instability or failure due to piping or erosion
- c. frequency of observation: \_\_\_\_\_

8. For a newly constructed impounding structure, provide certification from a Professional Engineer who has inspected the impounding structure during construction that, to the best of the engineer's judgment, knowledge and belief, the impounding structure and all appurtenances have been constructed in conformance with the plans, specifications and drawings submitted to the Department of Conservation and Recreation.

OPERATION AND MAINTENANCE PERMIT APPLICATION

OPERATION AND MAINTENANCE SCHEDULES  
CERTIFICATION BY OWNER

I hereby certify that the operation and maintenance plans and schedules provided herewith will be adhered to during the life of the project except in cases of unanticipated emergency requiring departure therefrom in order to mitigate hazards to life and property, at which time my engineer and the Department of Conservation and Recreation will be notified

Signed: [Signature] \_\_\_\_\_  
(Owner)

This 1st day of February, 2008

CERTIFICATE BY OWNER'S ENGINEER

I hereby certify that the information provided in this form has been examined by me and found in my professional judgment to be appropriate to operation and maintenance considerations for this dam

Signed: [Signature] \_\_\_\_\_ Virginia Number: 036174  
Professional Engineer

This 1st day of February, 2008

Remarks: This upground reservoir has been operated successfully for many years for the purpose of sedimentation of bottom ash. We intend to continue our program of careful operation with frequent periodic inspections and we will continue to perform remedial repairs and maintenance as required by field conditions. This facility has been inactive since 1995

Please fill out and mail this form to:  
Department of Conservation and Recreation  
Division of Dam Safety  
205 Governor Street  
Richmond, Virginia 23219-2094

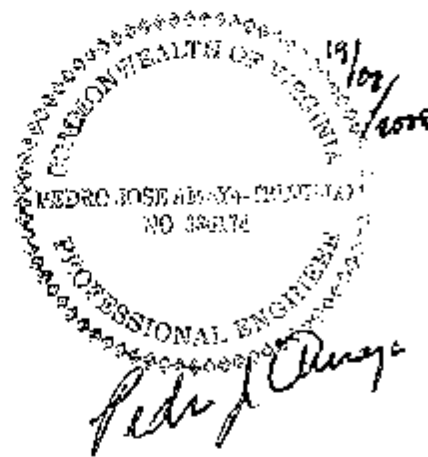

## Attachment I

- 4a Operation of control gates and spillways: Clinch River Plant last used Pond No. 2 in November, 1995 the discharge for this pond consists of a variable elevation side-hill drainage shaft connected to a 30-inch diameter reinforced concrete pipe. The overflow elevation of the spillway may be changed by inserting or removing steel plates. Flow is controlled by a pneumatic piston activated slide gate which responds to water level sensors at the recirculation pond. Freeboard is sufficient to store the Probable Maximum Flood.
- 4b Operation of Reservoir Drain: There is no reservoir drain of this facility because such drain would either become clogged with bottom ash or would discharge it from the pond.
- 5a. (1) Embankment: the upstream and downstream slopes are visually inspected by plant personnel. Items checked for include signs of invisibility, seepage, rodent burrows, erosion features and vegetative cover. Grass, brush and tree cutting is done as needed. Rodent burrows and erosion gullies are filled in when they are found.
- (2) Principal Spillway: The principal spillway for this upground reservoir consists of a variable elevation side-hill overflow structure connected to a 30-inch diameter discharge pipe.
- (3) Emergency Spillway: Not Applicable - See 4a above
- (4) Low Level Outlet: Not Applicable
- (5) Reservoir Area: Since this is an upground reservoir, the reservoir area is checked when the upstream slopes are inspected.
- (6) Downstream Channel: The pond's 30-inch diameter discharge pipe terminates at a concrete sump box, where the discharge waters are directed to a recirculation pond.
- (7) Other: No Comment.

Since the pond has not operated since 1995, a thorough inspection would be necessary before the pond is returned to service.

**Operation and Maintenance Application**

CLINCH RIVER PLANT  
DIKE INSPECTION CHECKLIST

1. GENERAL INFORMATION

Date of Inspection \_\_\_\_\_

Inspected by \_\_\_\_\_

Weather \_\_\_\_\_

Temperature \_\_\_\_\_

Rainfall During Past 7 Days \_\_\_\_\_

Reservoir elevations at  
 time of inspection:

    Pond 1A \_\_\_\_\_

    Pond 1B \_\_\_\_\_

    Pond 2 \_\_\_\_\_

2. EMBANKMENT CONDITION AT PONDS 1A & 1B

Please refer to the Ash Area 1 Dike Inspection Location Plan which is found on Page 3. Place a number and a descriptive sketch on the location plan at each problem area. Place the same number(s) next to the appropriate description(s) below.

| <u>DESCRIPTION</u> | <u>LOCATION NUMBERS</u> |
|--------------------|-------------------------|
| Cracks             | _____                   |
| Bulges             | _____                   |
| Sliding            | _____                   |
| Erosion            | _____                   |
| Soft Soil          | _____                   |

Leaking Pipe \_\_\_\_\_  
 Seepage/Watness \_\_\_\_\_  
 Vegetative Cover \_\_\_\_\_  
 Trees on Slope \_\_\_\_\_  
 Hillside Runoff Drain #1 \_\_\_\_\_  
 Hillside Runoff Drain #2 \_\_\_\_\_  
 Rodent Burrows \_\_\_\_\_  
 Other (Please Specify) \_\_\_\_\_

3. PIEZOMETERS READINGS AT PONDS 1A & 1B

| <u>PIEZ. NO.</u> | <u>ELEV., TOP OF TUBE</u> | <u>DEPTH TO WATER FROM TOP OF TUBE</u> | <u>WATER ELEVATION</u> | <u>COMMENTS</u> |
|------------------|---------------------------|--|------------------------|-----------------|
| A-1              | 1571.0                    | _____                                  | _____                  | _____           |
| A-2R             | 1569.5                    | _____                                  | _____                  | _____           |
| A-3              | 1535.0                    | _____                                  | _____                  | _____           |
| A-5              | 1572.2                    | _____                                  | _____                  | _____           |
| A-6              | 1571.3                    | _____                                  | _____                  | _____           |
| A-7R             | 1572.0                    | _____                                  | _____                  | _____           |
| B-1              | 1571.2                    | _____                                  | _____                  | _____           |
| B-2R             | 1571.2                    | _____                                  | _____                  | _____           |
| B-3R             | 1570.9                    | _____                                  | _____                  | _____           |
| B-4R             | 1571.2                    | _____                                  | _____                  | _____           |
| B-5R             | 1571.4                    | _____                                  | _____                  | _____           |
| B-6              | 1571.8                    | _____                                  | _____                  | _____           |
| F-1              | 1529.9                    | _____                                  | _____                  | _____           |

|     |        |       |       |       |
|-----|--------|-------|-------|-------|
| P-2 | 1520.6 | _____ | _____ | _____ |
| P-3 | 1519.9 | _____ | _____ | _____ |
| P-4 | 1518.6 | _____ | _____ | _____ |
| P-5 | 1512.6 | _____ | _____ | _____ |
| P-6 | 1517.0 | _____ | _____ | _____ |
| P-7 | 1523.2 | _____ | _____ | _____ |
| P-8 | 1521.2 | _____ | _____ | _____ |

4. V-NOTCH WEIRS

Please determine the flow rate in gallons per minute for each of the V-notch weirs. This can be done by measuring the head H of water above the apex of the V-notch to the nearest 1/4 inch and comparing it to the chart below.

| HEAD, H,<br>INCHES | FLOW RATE, GPM |           | HEAD, H,<br>INCHES | FLOW RATE, GPM |           |
|--------------------|----------------|-----------|--------------------|----------------|-----------|
|                    | 30° WEIR       | 22½° WEIR |                    | 90° WEIR       | 22½° WEIR |
| 1                  | 2              | 0.75      | 3                  | 37             | 7.2       |
| 1 1/4              | 4              | 1         | 3 1/4              | 45             | 9.9       |
| 1 1/2              | 6              | 1.4       | 3 1/2              | 53             | 10.3      |
| 1 3/4              | 9              | 1.9       | 3 3/4              | 65             | 12.5      |
| 2                  | 12             | 2.6       | 4                  | 76             | 14.5      |
| 2 1/4              | 17             | 3.4       | 4 1/4              | 88             | 16.8      |
| 2 1/2              | 24             | 4.6       | 4 1/2              | 100            | 19        |
| 2 3/4              | 30             | 5.9       | 4 3/4              | 114            | 21.6      |

V-notch Weir #1: \_\_\_\_\_ gallons per minute  
 V-notch Weir #2: \_\_\_\_\_ gallons per minute  
 V-notch Weir #3: \_\_\_\_\_ gallons per minute  
 V-notch Weir #4: \_\_\_\_\_ gallons per minute  
 V-notch Weir #5: \_\_\_\_\_ gallons per minute  
 V-notch Weir #6: \_\_\_\_\_ gallons per minute

5. SEEPAGE COLLECTION SUMP

Please determine the flow rate, in gallons per minute, of the two branches of the French drain at the 3 foot diameter seepage collection sump. This can be done by measuring how much the water



level rises while recording the time during a period when both pumps are off. Flow rate is given by the following formula:

$$\text{FLOW RATE,} = \frac{(3.1416)(19)(7.43)(60)H}{t}$$

in which H = rise of water level in feet during the unpumped time interval t, in seconds.

FLOW RATE = \_\_\_\_\_ GALLONS PER MINUTE

6. DISCHARGE STRUCTURE AT POND 1B

Please note the conditions with regard to the following:

Condition of concrete \_\_\_\_\_

Are stoplogs available? \_\_\_\_\_

Obstructions \_\_\_\_\_

Foreign object in pond? \_\_\_\_\_

Pedestrian access O.K.? \_\_\_\_\_

Erosion Problems \_\_\_\_\_

Other (Please specify) \_\_\_\_\_

7. MISCELLANEOUS AT PONDS 1A & 1B

Is seepage repair area O.K.? \_\_\_\_\_

What is condition of French drain? Is white precipitate building up impeding drainage? \_\_\_\_\_

What is the overall condition of the discharge structure from Pond 1A to Pond 1B? \_\_\_\_\_

Are seepage sump pumps O.K.? \_\_\_\_\_

Is entrance to 24" seepage overflow pipe clear of  
obstructions? \_\_\_\_\_

8. PONDS 1A & 1B NOTES AND COMMENTS INCLUDING JOB ORDERS  
WRITTEN AND REPAIRS/MAINTENANCE SINCE LAST INSPECTION:

\_\_\_\_\_  
\_\_\_\_\_  
\_\_\_\_\_  
\_\_\_\_\_  
\_\_\_\_\_

9. EMBANKMENT CONDITION AT POND 2 AREA

Please refer to the Ash Area 2 Dike Inspection Location Plan which is found on Page 9. Place a number and a descriptive sketch on the location plan at each problem area. Place the same number(s) next to the appropriate description(s) below.

| <u>DESCRIPTION</u> | <u>LOCATION NUMBERS</u> |
|--------------------|-------------------------|
| Cracks             | _____                   |
| Bulges             | _____                   |
| Sliding            | _____                   |
| Erosion            | _____                   |
| Soft Soil          | _____                   |
| Leaking Pipe       | _____                   |
| Seepage/Wetness    | _____                   |

| <u>DESCRIPTION</u>     | <u>LOCATION NUMBERS</u> |
|------------------------|-------------------------|
| Vegetative Cover       | _____                   |
| Trees on Slope         | _____                   |
| Rodent Burrows         | _____                   |
| Other (Please Specify) | _____                   |

10. PIEZOMETER READINGS AT POND 2 AREA

| <u>PIEZ. NO.</u> | <u>ELEV., TOP OF TUBE</u> | <u>DEPTH TO WATER FROM TOP OF TUBE</u> | <u>WATER ELEVATION</u> | <u>COMMENTS</u> |
|------------------|---------------------------|--|------------------------|-----------------|
| P-1              | 1557.0                    | _____                                  | _____                  | _____           |
| P-2              | 1555.8                    | _____                                  | _____                  | _____           |
| P-3              | 1556.7                    | _____                                  | _____                  | _____           |
| P-4              | 1557.4                    | _____                                  | _____                  | _____           |
| P-5              | 1557.7                    | _____                                  | _____                  | _____           |
| P-6              | 1557.4                    | _____                                  | _____                  | _____           |
| P-7              | 1557.9                    | _____                                  | _____                  | _____           |
| P-8              | 1557.4                    | _____                                  | _____                  | _____           |
| P-9              | 1558.2                    | _____                                  | _____                  | _____           |
| U-1              | 1560.0                    | _____                                  | _____                  | _____           |
| U-2              | 1561.1                    | _____                                  | _____                  | _____           |
| U-3              | 1560.0                    | _____                                  | _____                  | _____           |
| U-4              | 1560.0                    | _____                                  | _____                  | _____           |
| L-5              | 1532.0                    | _____                                  | _____                  | _____           |
| L-6              | 1532.0                    | _____                                  | _____                  | _____           |
| L-7              | 1535.3                    | _____                                  | _____                  | _____           |
| L-8              | 1534.7                    | _____                                  | _____                  | _____           |

US EPA ARCHIVE DOCUMENT

11. IS PERFORATED DRAIN PIPE BETWEEN LOWER LEVEL AND MIDDLE LEVEL  
DIKES WORKING PROPERLY AND IN GOOD CONDITION?

.....  
.....  
.....

12. DISCHARGE STRUCTURE AT FOND 2

Please note the conditions with regard to the following:

|                           |       |
|---------------------------|-------|
| Condition of concrete     | _____ |
| Gates/valves operational? | _____ |
| Obstructions              | _____ |
| Is access clear?          | _____ |
| Erosion problems          | _____ |
| Other (Please specify)    | _____ |

13. POND 2: NOTES AND COMMENTS INCLUDING JOB ORDERS WRITTEN AND  
REMEDIAL WORK DONE SINCE LAST INSPECTION

.....  
.....  
.....  
.....  
.....  
.....  
.....  
.....  
.....

PAGE 3 OF 9  
REVISION 2  
FEBRUARY 2, 1995

NORTH



0 100 200 300  
SCALE, FEET

DENOTES ELEVATION, BR

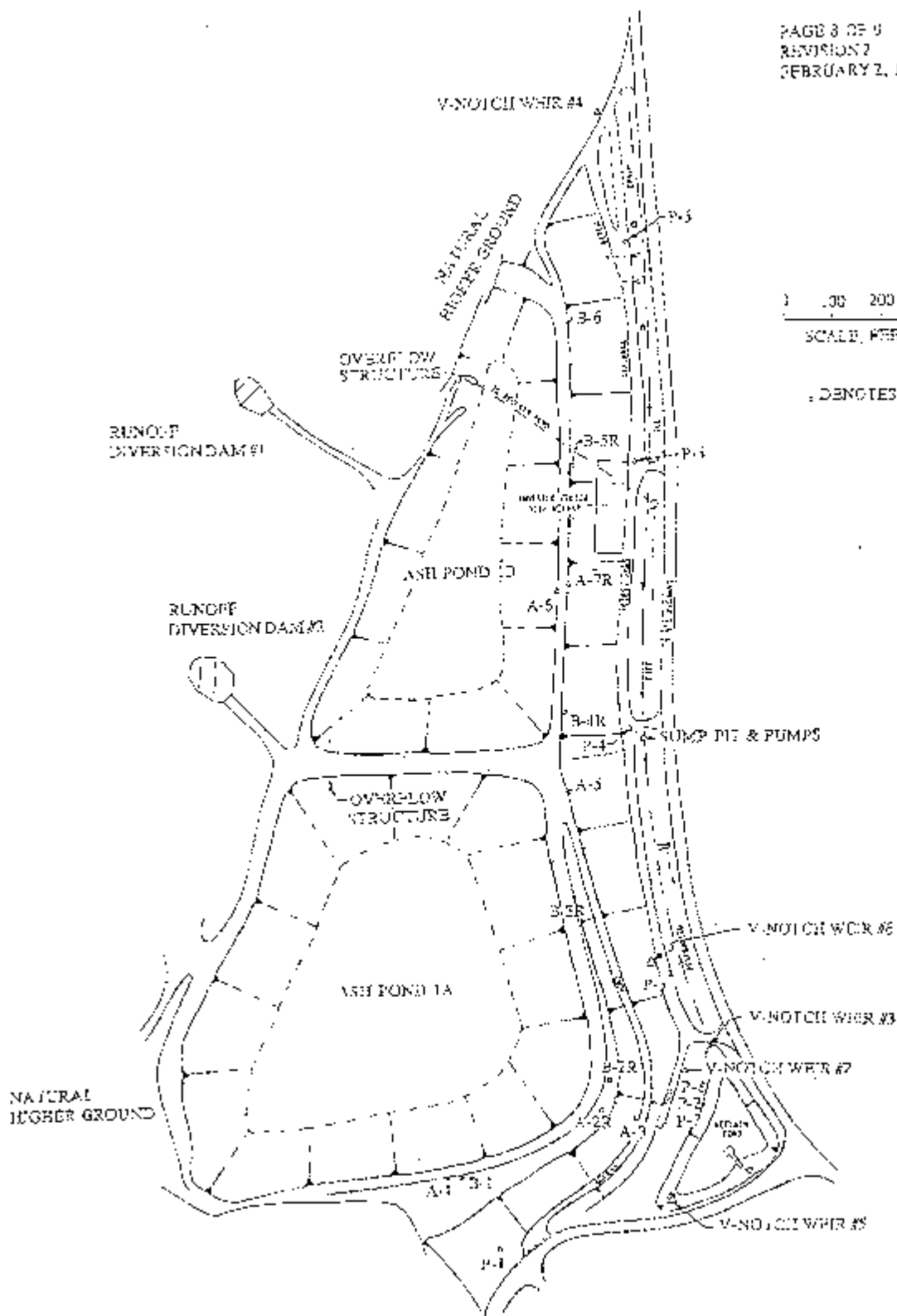

PLAN 1

CLINCH RIVER PLAN 1 - ASH AREA 1, DIKE INSPECTION LOCATION PLAN

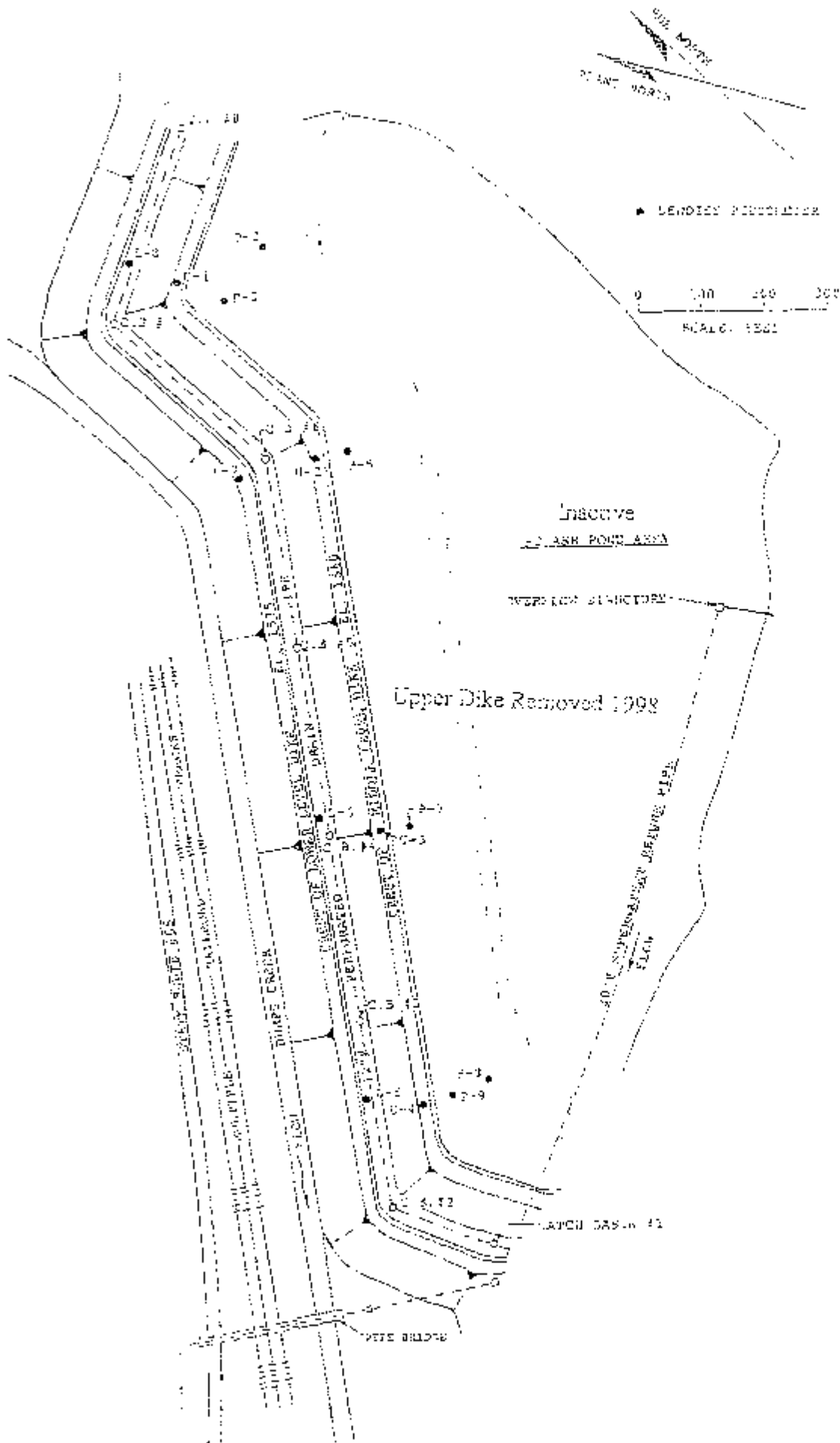

CLINCH RIVER PLANT: ASH AREA 2 DIKE INSPECTION LOCATION PLAN



Department of Conservation & Recreation  
UNIVERSITY OF VIRGINIA, P.O. BOX 800805

**INVENTORY REPORT FOR CLASS III AND CLASS IV IMPOUNDING STRUCTURES**

Reference: Impounding Structure Regulations, 4VAC50-20-00 et seq., Virginia Soil and Water Conservation Board

1. Project Information:

- a. Name of Impounding Structure Clinch River Fly Ash Dike No. 2
- b. Inventory Number 14702 Other Name (if any) ---
- c. Name of Reservoir Clinch River Plant Bottom Ponds #2
- d. Purpose of Reservoir Sedimentation of Bottom Ash

2. Location of Impounding Structure:

- a. City/County Russell Magisterial District Cleveland
- b. Located 300 feet/miles upstream/downstream of Highway No. 316
- c. Name of River or Stream Does not impound, but is near Dump Creek  
tributary of the Clinch River
- d. Latitude N36 55' 30" Longitude W82 11' 24"

3. Ownership:

- a. Owner's Name Appalachian Power Company
- b. Mailing Address 40 Franklin Road, P.O. Box 2021  
Roanoke, VA 24022-2121
- c. Telephone (309) 955-1237

4. Owner's Engineer:

- a. Engineering Firm/Engineer American Electric Power Service Corporation
- b. Professional Engineer Virginia Number Jedro Jose Amaya-Trujillo, VA#036174
- c. Mailing Address 1 Riverside Plaza, Columbus, OH 43215
- d. Telephone (614) 223-1000 OR (514) 223-2926

US EPA ARCHIVE DOCUMENT

5. Impounding Structure Data (All elevations NGVD unless noted):

a. Type of Material earth  concrete  masonry

Other \_\_\_\_\_

Design Configuration

b. Top of Dam 1555 Elev. (if known)

c. Downstream Toe (Lowest) 1509 Elev. (if known)

d. Height of Dam 46 Feet

e. Crest Length (Exclusive of Spillway) 1650 Feet

f. Crest Width 20 Feet

g. Upstream Slope 1 H: 1 V

h. Downstream Slope 3 H: 1 V

\*This facility consists of 2 dikes impoundments arranged as terraces. This facility has been inactive since 1995. Downstream toe elevation given for lowest point of lowest dike. (See Diagram)

6. Reservoir Data

Design Configuration

a. Maximum Capacity 125 Acre-feet

b. Maximum Pool 1569 Elev. (if known)

c. Maximum Pool Surface Area 12.5 Acres

d. Normal Capacity 82 Acre-feet

e. Normal Pool 1557 Elev. (if known)

f. Normal Pool Surface Area 11.7 Acres

g. Freeboard (Normal Pool to Top) 3 Feet

h. Freeboard (Normal Pool to Emergency) N/A Feet

7. Spillway Data

Type

Construction Material

Maximum Capacity

a. Low Level Drain N/A Concrete ---

b. Principal Spillway Variable Weir Stone 200 cfs

c. Emergency Spillway N/A --- ---

Design Configuration

d. Low Level Drain None Elev. (if known)

e. Principal Spillway 1557 Elev. (if known)

f. Emergency Spillway None Elev. (if known)



g. Briefly describe the low level drain and principal spillway to include dimensions, materials of construction, trash guards, location in reservoir and through dam, and orientation of intake and discharge to dam if looking downstream: There is no low level drain because it would become clogged with bottom ash or would discharge bottom ash. Principal spillway is a variable elevation side hill structure with remote control gate valve.

h. Describe the emergency spillway to include dimensions, whether the spillway is an earth channel or other construction, spillway surface protection, and orientation to dam if looking downstream: None - this is an upground reservoir which is filled by pumping

8. Watershed Data (Class III only):
- a. Drainage Area 13 acres (including pond surface) Sq Miles
  - b. Type and Extent of Watershed Development \_\_\_\_\_
  - c. Time of Concentration \_\_\_\_\_ Method \_\_\_\_\_
  - d. Spillway Design Flood used (mark appropriate box)
    - PMF, source \_\_\_\_\_
    - 1/2 PMF, source \_\_\_\_\_
    - 100 Year, source \_\_\_\_\_
    - 50 Year, source \_\_\_\_\_
    - Other, source Not Applicable - upground reservoir
  - e. Design inflow hydrograph: Volume \_\_\_\_\_ acre-feet;
    - Peak inflow \_\_\_\_\_ CFS;
    - Rainfall duration of design inflow hydrograph \_\_\_\_\_ hours
  - f. Freeboard during passage of spillway design flood, \_\_\_\_\_ feet

9. Impounding Structure History
- a. Date construction completed 1964, modified 1970 & 1975
  - b. Design by Casagrande Consultants Date: 1963
  - c. Built by Unknown Date: 1964

- d. Inspection dates 1978, 1980, 1982, and annually from 1984-2001
- e. Inspections by Woodward-Clyde Consultants, AEP and Geosyntec Consultants
- f. Description of repairs A 75-ft length of this dike breached in 1957; repairs included placement of additional filter material and rip rap at d/s toe  
Since then, routine maintenance based on recommendations from annual inspections
- g. Has the impounding structure ever been overtopped? Yes  No

10. Impounding Structure Assessment:

a. Provide brief descriptions for each item:

- i. Condition of the impounding structure Good
- ii. Condition of the reservoir Good
- iii. Condition of the upstream area Good
- iv. Condition of the downstream area Good

b. Provide a narrative describing any recent changes in the impounding structure, reservoir, upstream area, and downstream area: In 1998, the upper dike was removed in order to reclaim the bottom ash for sales. Permission was received from Duncan McGeogher for the Division of Dam Safety prior to beginning.

c. Recommendations for remedial measures: continue routine brush cutting and piezometer readings; fill gullies and rodent burrows if they develop; maintain proper operation of seepage control features.

11 Provide a sketch of the impounding structure

See Attached Sketch

CERTIFICATION BY OWNER'S ENGINEER (Class III only)

I hereby certify that the information provided in this Inventory Report has been examined by me and found to be true and correct in my professional judgment.

Signed Peter J. Amaya  
(Professional Engineer)

Virginia Number 036174

This 19<sup>th</sup> day of February, 2008

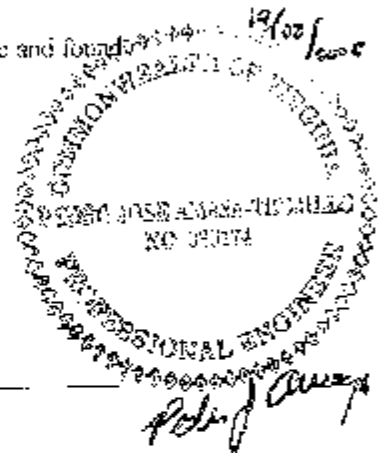

CERTIFICATION BY OWNER (Class IV only)

I hereby certify that the information provided in this Inventory Report is true and correct

Signed [Signature]  
(Owner)

This 1<sup>st</sup> day of February, 2008

Please fill out and mail to:  
Department of Conservation and Recreation  
Division of Dam Safety  
203 Governor Street  
Richmond, Virginia 232192094

Revised 4/29/98

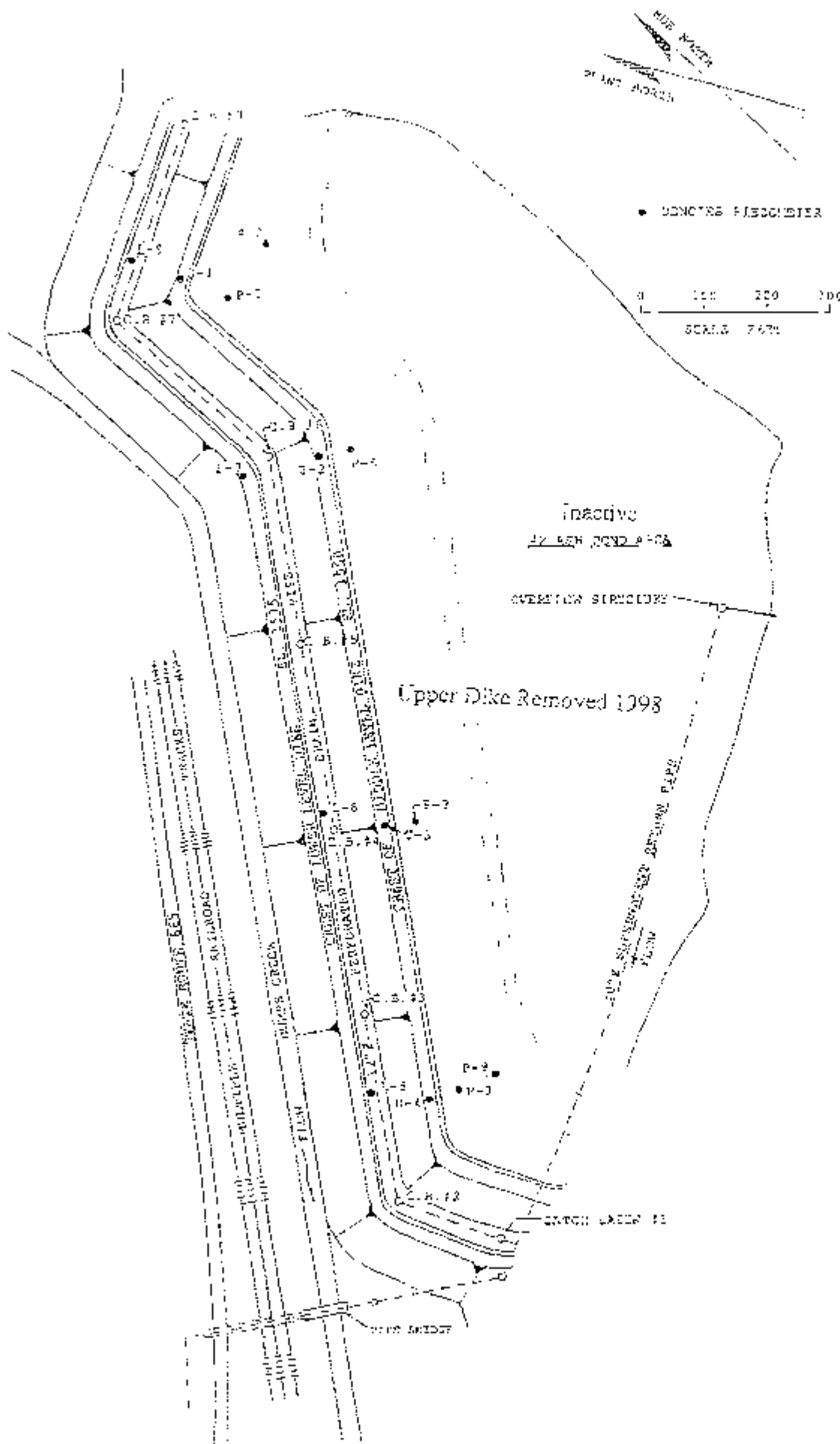

CLANCH RIVER PLANT: ASH AREA 2 DAM INSPECTION LOCATION PLAN



"Thomas Roberts"  
 <Thomas.Roberts@dcr.virginia.gov>

03/20/2008 05:37 PM

To <wsmith@aep.com>

cc <rapeppler@aep.com>, "Thomas Roberts"  
 <Thomas.Roberts@dcr.virginia.gov>

bcc

Subject 16702 Clinch River Flyash Dam #2, 16703 Clinch River  
 Flyash Dam #1

History: This message has been forwarded.

Mr. Smith-

Visited the AEP site in Carbo yesterday with Rex A. Peppler and Monty D. Guy. A couple of quick observations:

1. It does not look like the data provided on the "Inventory Report" was up to date on the Clinch River Flyash Dam #2, for volume of normal pool and maximum pool, for normal surface area etc. Looks like the numbers provided are 15 years or more out of date. When convenient, please revise the numbers (ie normal pool = 0 acre feet) and send me a corrected copy for the file.
2. It appears that there is no dam here at all made for the impounding of water, just a plateau with a few berms here and there. By the vegetation it appears that there is not even ponding during heavy rainfall events. As far as I could tell, this area has not been used for many years. You might consider having your engineer review this to determine if you have the volume needed (at least 15 acre feet for dams over 25' high) to justify keeping this as a regulated dam. If you determine that it is no longer of a size to be regulated, please forward a letter from your Professional Engineer indicating the reasons and we will close out this dam as a regulated dam.
3. If #2 is still a dam and is still continue to be regulated, all brush on the dams and within 25' of the dams must be removed and maintained. This dam does not appear to be a hazard class other than Class III.
4. The same information needs to be updated on the Inventory Report for Dam #1.
5. Dam #1 looks like it has been divided with a permanent dike road through the former dam volume. The dike road is at the same elevation as the top of the dam. Effectively the area to the South West of the dike road has a separate volume from the area to the North East. With some measurements, I think it is possible for your engineer to show that neither of these volumes exceed 15 acre feet of water + ash to be removed.
6. If Dam #1 does turn out to still be regulatable, then you will need to have your engineer review the hazard class with respect to the roadway just below the dam. Essentially, if the dam did fail, would it wash over the road. If so, it is likely that this is a Class II hazard dam rather than a class I.
7. If Dam #1 does turn out to still be regulatable, then all trees and brush within 25' of the dam embankment, toe, top, etc, must be removed. Mr. Peppler indicated that he would be taking care of removing the trees.

There is no rush on the above items, but they should be addressed in the next 6 months. I left both of these dams on the list for Regular Certificates.

Please call me if you have questions or comments.

Tom Roberts

Thomas I. Roberts P.E. - Regional Engineer - Dam Safety  
 Virginia Department of Conservation and Recreation  
 Dam Safety and Floodplain Management  
 8 Radford Street, Suite 201  
 Christiansburg, Virginia 24073 - 3341  
 Phone - 540 394 2550

US EPA ARCHIVE DOCUMENT

**DAM SAFETY INSPECTION  
POND 1 AND POND 2  
1978**

Report On  
Dam Safety Inspection  
ASE PONDS 1, 1A, & 2  
CLINCH RIVER POWER PLANT  
Carbo, Virginia

Prepared by  
Woodward-Clyde Consultants  
Clifton, New Jersey

For  
AMERICAN ELECTRIC POWER SERVICE CORPORATION  
Two Broadway  
New York, New York

18 July 1978

77C110

## TABLE OF CONTENTS

|     |                                       | <u>Page</u> |
|-----|---------------------------------------|-------------|
| 1.0 | INTRODUCTION                          | 1           |
| 2.0 | PROJECT DESCRIPTION                   | 1           |
| 3.0 | SITE GEOLOGY                          | 5           |
| 4.0 | SUMMARY OF ENGINEERING DATA AVAILABLE | 5           |
| 5.0 | RESULTS OF VISUAL INSPECTION          | 6           |
| 6.0 | OPERATIONAL PROCEDURES                | 9           |
| 7.0 | HYDROLOGIC AND HYDRAULIC EVALUATION   | 10          |
| 8.0 | OVERALL EVALUATION                    | 10          |

### TABLES

### FIGURES

APPENDIX A - PHOTOGRAPHS

APPENDIX B - VISUAL INSPECTION CHECKLIST

APPENDIX C - DATA COLLECTION FORM



## CLINCH RIVER POWER PLANT

### 1.0 INTRODUCTION

The results of a dam safety inspection of Ash Ponds No. 1A, 1B and 2 at the Clinch River Power Plant are presented in this report. The purposes of the investigation were to gather and evaluate available data on the design and construction of the dams at the power plant and to complete a visual inspection of the integrity of the dikes so that an evaluation could be made of the need for additional investigation and/or remedial action.

The investigation was performed in accordance with our proposal dated 11 October 1977. It consisted of review of data concerning the Clinch River Dikes available in AEP's files, field inspection of the dikes, engineering evaluation and the preparation of this report. The field inspection was performed on 2 June 1978 by Messrs. John H. Frederick, Jr. and Ray Lambart.

### 2.0 PROJECT DESCRIPTION

The location of the Clinch River Power Plant is shown in Figure 1. There are two diked areas (Ponds No. 1 and No. 2) for mixed ash storage (fly ash and bottom ash combined) currently in service at the Clinch River Power Plant. Pond No. 1 is located north of Dumps Creek and Pond No. 2 is located south of Dumps Creek. Pond No. 1, originally built as one large impoundment, was subsequently divided into two separate ponds, 1A and 1B.

The dikes were designed by Casagrande Consultants and constructed in 1964. Since the initial construction, the dikes of Ponds 1A, 1B and 2 have been raised a number of times. The sequence of construction as determined from AEP Drawing No. 13-10585-3107-4 dated 9/19/69 and from conversations with plant personnel at the Clinch River Plant, is shown in Table 1.

## 2.1 DIKE SECTIONS

The dikes are constructed primarily of compacted rock, shale and earth fill obtained from locally available borrow sources. At Ponds 1A and 1B, compacted fly ash and bottom ash were used for one of the additions to the crest of the dikes. Subsequent additions are indicated on the drawings to be composed of locally available shale material.

The dikes forming Ponds 1A and 1B were raised by placing additional material on the crest of the existing dike. At Pond 2 however, increased storage capacity was achieved by constructing new dikes on top of the flyash sediment. There are currently three tiers of dikes referred to herein as the lower, middle and upper level dikes. The layout of the dikes and typical cross sections for Ponds 1A, 1B and 2 are shown on Drawing No. 13-10585-3107-4, reproduced as Figure 2.

As shown on Figure 2 the crest of the dikes surrounding Ponds 1A, 1B and 2 is at approximately el 1570 ft.\*

---

\*USGS DATUM

The face of the dikes is sloped typically at 2H:1V. However, the upper level dike of Pond 2 is sloped at 3H:1V. The downstream slope of the lower level dike of Pond 2 is protected by riprap.

In 1967 a sudden failure of the lower dike of Pond 2 was reported as having occurred. At that time, the middle and upper level dikes were not yet built. The failure was repaired and the dike placed back in service.

## 2.2 OUTLET WORKS

The piping network at Clinch River serves three functions:

1. Removal of overflow water from within the pond areas
2. Seepage control;
3. Control of surface run-off from sloped areas to the north of Ponds 1A, 1B.

### 2.2.1 POND OVERFLOW

Overflow structures are located at the northeast corner of Pond 1A, the northwest corner of Pond 1B and the southern portion of Pond No. 2 at a point approximately midway between the two abutments. Overflow from Pond 1A passes through a 30 inch diam pipe to Pond 1B. Water overflow from Ponds 1B and 2 discharges into a

common 30 inch reinforced concrete pipe through which it flows to the recirculating basin.

2.2.2 SEEPAGE CONTROL

All three ponds have had a history of obvious seepage at the downstream toe of the dikes.

Toe drains, consisting of perforated pipe within gravel backfill, have been installed along the toe of dikes 1A and 1B (10 inch pipe) and at the toe of the middle level dike in Pond 2 (12 inch pipe). Water flowing to the toe drains is collected in a sump and pumped into the 30 inch RCP which carries the pond overflow to the recirculating basin.

Despite the toe drains, seepage is still occurring. Approximately three years ago, a boil was noted near the downstream toe of Pond 1B. At the recommendation of Mr. D. Casagrande of Casagrande Consultants, an inverted filter was placed over the boil. Also at the recommendation of Casagrande Consultants, a number of piezometers were installed in the area of Pond 2 and along the downstream slope of Pond 1A. Readings of water levels in some of these piezometers were obtained during our site inspection and are described later in this report.

Seeps observed during our inspection are described in Section 5.0.

2.2.3 RUN-OFF CONTROL

Surface run-off from the steeply sloped borrow area north of Ponds 1A and 1B is channeled into an 18 inch transite pipe and is discharged into Dumps Creek.

3.0 SITE GEOLOGY

The Clinch River Steam Plant is located in the Appalachian Mountain section of the Valley and Ridge physiographic province. Bedrock consists of shale, sandstone, and minor dolomite of the Rome formation of Cambrian age. The area is characterized by northeast-southwest trending folds. The course of the Clinch River is within the Rome formation.

Bedrock exposed in the area was seen to be fractured. If the slurry contained in Ash Ponds 1A, 1B and 2 has communication with the underlying bedrock, seepage would be expected to occur through the fractured rock. However, none of our observations suggest that this is in fact occurring.

4.0 SUMMARY OF ENGINEERING DATA AVAILABLE

The drawings made available to us by AEP for use in this investigation are listed in Table 2. Reference is made on these drawings to other drawings containing additional details on the dikes. However,

the referenced drawings were not available at AEP's office.

The design data found in the AEP files is summarized on the data collection form contained in Appendix C of this report. There were no design calculations available in AEP's Clinch River file.

## 5.0 RESULTS OF VISUAL INSPECTION

The inspection consisted of a visual survey of the dikes and outlet structures. The results of the visual inspection of Ponds 1A, 1B and 2 are described in the Visual Inspection Check List contained in Appendix B and are summarized below. Photos of the dikes are presented in Appendix A.

### 5.1 PONDS 1A AND 1B

1. At the time of the inspection, Pond 1A was filled to within one foot of the crest and Pond 1B was filled to within 12 feet of the crest. We were told that Ponds 1A and 1B have been out of service since some time in April 1978. They are currently used only for emergencies; most of the ash from the plant is now handled dry and is sent to a landfill area located near the plant.
2. No evidence of surface cracks or of unusual movement at or beyond the toe of the dikes was found during the inspection. The vertical and horizontal

alignment of the crest appeared to the eye to be normal. Exposed portions of the slopes appeared stable with no evidence of sloughing or erosion.

3. There is an abundant growth of straw grass and weeds on the downstream slopes of Ponds 1A and 1B. This growth suggests ready access to moisture.
4. Two seeps, producing a concentrated wet area (but no free water) were noted at the downstream toe of the dike of Pond 1A at a point near the plant entrance.
5. Water collected by the toe drainage pipes was observed entering the sump pit. The water appeared to be clear. There was no evidence of sediment build-up at the bottom of the sump.

#### 5.2 POND 2

1. At the time of the inspection, Ash Pond 2 formed by the upper level dike was in active service. The pool level in the pond was almost at the level of the crest.
2. No evidence of surface cracks or of unusual movement at or beyond the toe was found during the inspection. The vertical and horizontal alignment of the crest appeared to the eye to be normal. There was no evidence of instability, sloughing or erosion on the slopes of the dike.

3. Riprap at the downstream toe of the dike adjacent to Dumps Creek appeared in good condition.
4. There was no evidence of seepage in any of the dikes comprising Ash Pond 2.
5. Near the right abutment, the area north of the downstream toe appeared to be in a swampy condition. The established growth of swamp reeds and cat-tails suggests that this condition is long-standing. No concentrated flow was observed. Ponded water was also noted on the dried fly ash at the middle level of the storage pond near the right abutment area.

### 5.3 PIEZOMETER READINGS

The locations of the piezometers in which water level readings were obtained are shown in Figure 3. At each location, the depth of water below the ground surface is shown.

Readings were not obtained in the piezometers installed in the downstream slope of Pond 1A. As seen in Figure 3, readings in the piezometers located in the right abutment area indicate water levels 7 to 15 feet below the surface of the ash compared to 20 to 25 feet near the left abutment area. The cause of the relatively high water levels in the right abutment area is not known.



6.0 OPERATIONAL PROCEDURES

6.1 MAINTENANCE AND OPERATION

We understand that a plant engineer, Mr. Marshall Stevenson, is assigned full-time to operation and maintenance of the ash ponds. However, there are no documented operation or maintenance procedures established for the ash pond storage areas.

6.2 MONITORING AND WARNING SYSTEM

As mentioned earlier, piezometers have been installed in the downstream slopes of both Ponds 1A and 2. The original purpose of the piezometer installation was to obtain information on the nature of the seepage problem so that remedial measures could be designed. Initially, readings were taken on a regular basis. However, we understand that, prior to our site inspection, the piezometers had not been read for a number of years. In view of the history of seeps at these ash ponds, it is our opinion that piezometer readings should be obtained and evaluated on a regular basis. The frequency of the readings should be adjusted to reflect the plant operations in progress at the time. For example, readings should be obtained at more frequent intervals at the beginning of each filling cycle than later in the cycle.

Although plant personnel inspect the dikes daily to review their condition, there is no documentation of

procedures for response to damage or deterioration of the dikes. In the past, without documentation, response to emergency conditions has consisted of immediately notifying Casagrande Consultants and requesting their evaluation.

7.0 HYDROLOGIC AND HYDRAULIC EVALUATION

7.1 HYDROLOGY

The ash ponds are enclosed impoundments. As such there is no natural drainage into the reservoir. Flow is piped in under controlled conditions. The only source of in-flow, other than the piped in slurry, is rainfall. The maximum one hour precipitation for the 100 year storm in this portion of Virginia is approximately 3 1/2 inches.

7.2 HYDRAULIC CONSIDERATIONS

The AEP Directory indicates that the discharge capacity for the overflow structures is 180 cfs to 200 cfs. It is unlikely that flows even from a large rainstorm will exceed this capacity. Even if the overflow structure were not present, the 100 yr storm would result in only a small increase in pool level.

8.0 OVERALL EVALUATION

The dikes which comprise Ponds 1A, 1B and 2 appear to be in good condition with no evidence of sloughing,

lateral displacement or settlement. Although the dikes appear visually to be adequate, there are a number of aspects of their construction and performance for which further evaluation is warranted.

#### 9.1 DIKE STABILITY

The method of construction of portions of the dikes of Ponds 1 and 2 is illustrated in the sections shown in Figure 3. This technique is known as the upstream method. As seen in Figure 3, the alignment of the downstream face of the dam is maintained and the addition to the dam is constructed in the upstream direction. Part of the addition to the dam rests on the sedimented ash. As indicated in Table 1, the dikes were raised a number of times over a period of 8 years. Although some of the dike extensions are shown in Figure 3 to have been constructed in the downstream direction, most of the extensions were in the upstream direction.

As the dike is raised using the upstream method, an increasingly larger portion of the dike is underlain by sedimented ash and the strength properties of the sedimented ash become increasingly important for the overall stability of the dike. The effect of earthquake conditions on the strength of the sedimented ash also becomes an important consideration.

Although the stability of the dikes at the Clinch River plant appears adequate, (based on the visual inspections) we have not made nor reviewed any calculations of dike stability. We believe it would be prudent to evaluate the stability of the dikes. The evaluation should consider the stability of the dikes for both static and reasonable earthquake conditions.

8.2 SEEPAGE CONDITIONS

8.2.1 POND 1

The seeps observed on the downstream face of the dike forming Pond 1A were described in subsection 5.0. In our judgement, the presence of these seeps suggests that piping may be occurring. We recognize that failure has not occurred and that the overall impression of the dikes is one of stability. Nevertheless, we believe an evaluation of the seepage condition should be made.

Although the pond is currently not in repair service, we understand it is used for emergencies.

8.2.2 POND 2

The cause of the relatively high water levels measured in the piezometers located near the right (east) abutment of Pond 2 needs to be evaluated. The possibility of a relationship between these water levels and the wet condition present at the downstream toe near the right abutment should be investigated.

TABLE 1

SEQUENCE OF DIKE CONSTRUCTION  
CLINCH RIVER POWER PLANT

PONDS 1A & 1B

| <u>DATE</u> | <u>ELEVATION OF TOP<br/>OF DIKE</u> |
|-------------|-------------------------------------|
| 1964        | 1540                                |
| Unknown     | 1550                                |
| Unknown     | 1560                                |
| 1971        | 1570                                |

POND 2

|                           |      |
|---------------------------|------|
| 1964                      | 1525 |
| 1968                      | 1535 |
| Unknown                   | 1545 |
| 1970                      | 1560 |
| 1972 - 1973 (not certain) | 1575 |

TABLE 2

LIST OF DRAWINGS AVAILABLE FROM AEP  
 CLINCH RIVER POWER PLANT  
 MIXED ASH STORAGE PONDS

| <u>DRAWING NO.</u> | <u>DATE</u> | <u>DATE OF<br/>LAST REVISION</u> | <u>TITLE</u>                                  |
|--------------------|-------------|----------------------------------|---|
| 13-10796-3107A-2   | 6/14/71     | 9/16/77                          | General Plan and Sections<br>Ash Storage Area |
| 13-10796-3107C     | 6/14/71     | - - -                            | No. 13 Ash Dike Extension                     |
| 13-10585-3107-4    | 9/19/69     | 11/21/73                         | Ash Storage Areas                             |
| 13-10733-3106-3    | 9/3/70      | 9/16/77                          | Ash Storage Areas -<br>Manholes               |
| 13-11365-3107C-1   | 9/16/77     | 9/23/77                          | Ash Storage Areas -<br>Sections & Details     |



KEY MAP

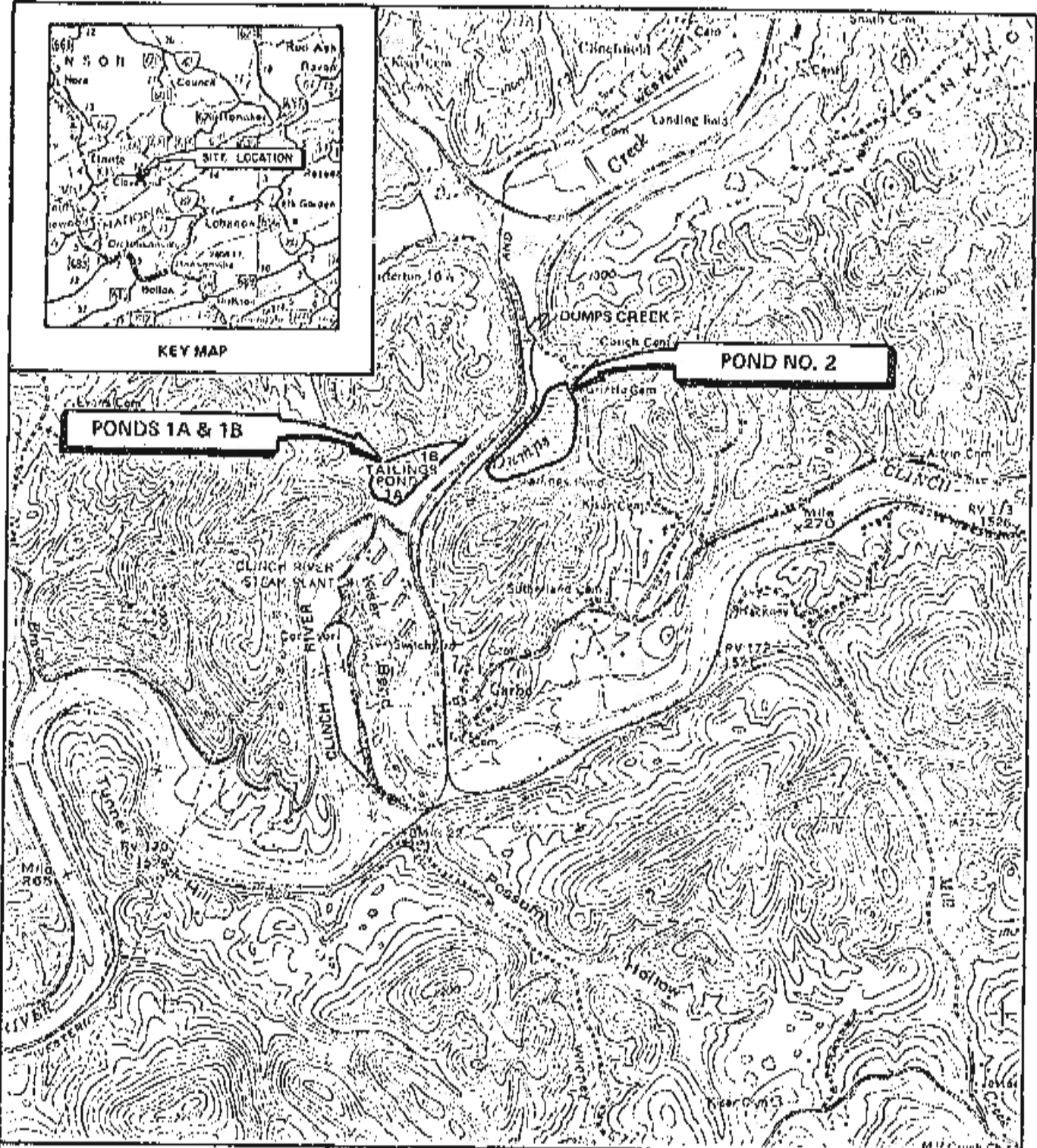

**REFERENCE DRAWINGS**

1. MAP SOURCE FOR KEY MAP IS COMMONWEALTH OF VIRGINIA HIGHWAY MAP, DATED 1978
2. MAP SOURCE FOR SITE LOCATION MAP IS USGS 7.5 MINUTE SERIES (TOPOGRAPHIC) CARBO QUADRANGLE, CARBO, VA., 1969 EDITION

**SITE LOCATION PLAN  
CLINCH RIVER POWER PLANT  
PONDS NO. 1A, 1B AND 2**

**WOODWARD CLYDE CONSULTANTS**

CONSULTING ENGINEERS, GEOLOGISTS AND ENVIRONMENTAL SCIENTISTS  
CLIFTON, NEW JERSEY

DR. BY: ORS

SCALE: 1" = 2000'

PROJ. NO.: 77C110

CK'D. BY: SAL

DATE: 6 JULY 1978

FIG. NO.: 1

# CLINCH RIVER POWER PLANT BOTTOM ASH DISPOSAL FACILITY

Pond 1

Stability Analysis

December 2010



American Electric Power Service Corporate  
1 Riverside Plaza  
Columbus, Ohio 43215



**STABILITY ASSESSMENT REPORT**

**BOTTOM ASH POND**

**CLINCH RIVER POWER STATION  
CARBO, VA**

**PREPARED BY** *B. Zand* **Date** *12/6/2010*  
Behrad Zand, Engineer

**REVIEWED BY** *Pedro J. Amaya* **Date** *12/16/2010*  
Pedro J. Amaya, P.E.

**APPROVED BY** *Gary F. Zych* **Date** *12/6/2010*  
Gary F. Zych, P.E.  
Section Manager - Geotechnical Engineering

**QA/QC DOCUMENT NO.**  
GERS-10-023

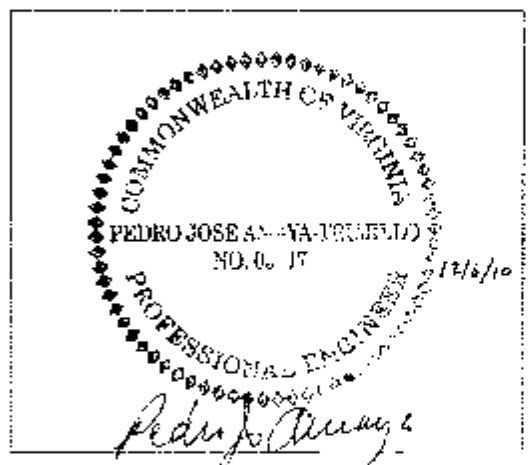

**PROFESSIONAL ENGINEER**

**SEAL & SIGNATURE**

**TABLE OF CONTENT**

---

Stability Assessment Report ..... i

1. Summary ..... 1

2. Introduction ..... 2

3. Previous Study and Subsurface Conditions ..... 3

4. Identification of Soil Layers and Material Properties ..... 5

5. Seepage Analysis ..... 12

6. Stability Analysis ..... 21

7. Warning and Critical Piezometric Levels ..... 23

8. Liquefaction Potential ..... 24

9. Conclusions ..... 25

10. References ..... 26

Appendix 1: Facility Layout Drawings

Appendix 2: Geotechnical Data Report

Appendix 3: Piezometer Data

Appendix 4: Seepage and Stability Model Inputs

Appendix 5: Stability Analysis Results

**LIST OF FIGURES**

---

Figure 1. Idealized dike section A of Pond 1A.

Figure 2. Idealized dike section B of Pond 1B.

Figure 3. Idealized dike section C of Pond 1B.

Figure 4. Computed total head distribution in Section A before construction of the cut-off wall.

Figure 5. Historical piezometer records near Section A together with readings from newly installed piezometers P-0908S, P-0908D, and P-0909.

Figure 6. Computed total head distribution in Section A after construction of the cut-off wall.

Figure 7. Computed hydraulic gradients for Section A after construction of the cut-off wall (a) at retention pond, and (b) at the embankment toe.

Figure 8. Computed total head distribution in Section B before installation of the cut-off wall.

Figure 9. Historical piezometer records near Section B along with the readings from newly installed piezometers P-0904 and P-0905.

Figure 10. Computed total head distribution in Section B after installation of the cut-off wall.

Figure 11. Computed hydraulic gradients at the toe of Section B at after installation of the cut-off wall.

Figure 12. Computed total head distribution in Section C before installation of the cut-off wall.

Figure 13. computed total head distribution in Section C after installation of the cut-off wall.

Figure 14. Piezometer water levels near Section C.

Figure 15. Computed hydraulic gradients at the toe of Section C at after installation of the cut-off wall.

## LIST OF TABLES

---

Table 1. Material parameters for Section A.

Table 2. Material parameters for Section B.

Table 3. Material parameters for Section C.

Table 4. Steady-state condition slope stability safety factors.

Table 5. Seismic condition slope stability safety factors.



## 1. SUMMARY

An assessment of the stability of the main dams that form the bottom ash disposal areas Pond I at the Clinch River Power Station is presented in this report. In 2009 a geotechnical investigation was conducted by MACTEC in behalf of AEP to investigate subsurface conditions of the dike and its foundation. This study included drilling of 12 borings to identify soil strata, perform standard proctor test, and extrude split spoon and Shelby tube samples for laboratory testing. The laboratory testing program included eight 3-point triaxial compression (consolidated undrained), four 2-point triaxial compression, twelve hydraulic conductivity, three consolidation, twenty gradation, twenty Atterberg limits, and 25 moisture content tests.

Three idealized sections were developed for the numerical analysis to represent the existing condition of the main dike that forms the 1A and 1B ponds. Seepage through each dike section was analyzed to numerically determine phreatic water surfaces and the maximum hydraulic gradients across each section. Hydraulic properties of the material were evaluated through field explorations and laboratory testing of undisturbed samples recovered from several boreholes, as well as back analyses of the recorded water levels in the piezometer that exists around the facility. Stability analyses were performed for downstream slopes of each section under static and earthquake (quasi-static) conditions with steady-state seepage. The subsurface earthen zones of each dike construction were determined based on available design drawings and subsurface investigations. Material properties used in the stability analyses were selected based on the findings of geotechnical investigations (N-value and index properties) as well as laboratory testing. The calculated factors of safety were found to be 1.5 or higher under static conditions and 1.2 or higher under seismic conditions. The calculated hydraulic gradients at the toe of the three sections were determined to be within acceptable range. As such, the facility is believed to be in safe and stable condition.

## 2. INTRODUCTION

The Clinch River Plant is located in Russell county Virginia off of Route 664 and near the town of Carbo. The plant has three units with the total generation capacity of 705 MW. Units 1 and 2 started operation in 1958 and unit three in 1961.

The ash disposal facilities at the plant consist of a bottom ash pond and a fly ash landfill. Bottom ash material produced in the three units of the plant is sluiced into the bottom ash pond facility near and to the East of the plant. While most of the fly ash produced by the plant is placed dry in the landfill, occasionally some fly ash is sluiced into the bottom ash pond. The pond facilities at the Clinch River plant, constructed between 1955 and 1956, consist of two separate ponds, named Pond 1 and Pond 2. Pond 2 was dewatered in 1998 and has been out of service since then, thus it has not been included in this study. Ash ponds 1A and 1B are located at the intersection of Dump Creek and the Clinch River. They are separated by a splitter dike as shown in the facility lay-out plan (Appendix 1). The main dike that forms ponds 1A and 1B has been raised several times between 1955 and 1971. The current crest elevation of the main dike is approximately 1570 ft.

The original 1955 dike was made of relatively impervious silty clay soil with a mixture of shale and sandstone fragments to a crest elevation of 1540 ft. A mixture of fly ash and bottom ash material was used in the first raising to a crest elevation of 1550 ft. Shale rock fill was used in subsequent raisings to the current crest elevation 1570. The second and third dikes (first and second raises) were constructed above and behind the original dike following the upstream construction method. The last raising was constructed on the downstream side of the previous dike raisings with a downstream slope graded to 2 horizontal to 1 vertical. In a letter from Casagrande Consultants on July 14, 1973, the ash mixture used for the first raising and the shale fill used for the raising of the dikes up to the elevation of 1560 ft were evaluated to have a low permeability, while the shale fill beyond elevation 1560 ft was estimated to have a relatively high permeability.

The operating pool levels at Pond 1A and Pond 1B are 1565 ft and 1558 ft respectively. The ash mixture is currently being sluiced into Pond 1A and overflow water flows from Pond 1A to Pond

1B through a decant structure and a 30 in diameter spillway pipe. The overflow from Pond 1B is directed to a catch basin at the toe of the dike through a 36 in spillway pipe, from which it flows by gravity to a Reclaim Pond. Pond 1A is used to sluice and excavate the ash produced at the plant, while Pond 1B primarily functions as a clear water pond. Both the ponds are dredged on a regular basis and the excavated ash is hauled to a landfill near the plant.

Ponds 1A and 1B had a history of seepage and boils at the toe area and on the downstream face since before 1978. To control these seeps a toe drain, consisting of 10 in diameter perforated pipe buried in a gravel blanket, was installed along the toe in the 1980s. In the late 80s a new seepage and saturated area was reported along a 150 ft long region on the downstream face of Pond 1B at approximate elevation of 1533 ft (about 22 ft above the toe). A stability study performed in 1990 [1] by AEP geotechnical engineering revealed low safety factors for the main dike (1.16). It was recommended that a cut-off wall be installed at the crest and be extended to the foundation soil. As such, in 1991 a 65 ft deep bentonite slurry cut-off wall was installed along the crest of the dike and into the abutments [2]. The cut-off wall was extended into the original 1955 dike that possesses a low permeability. In 2009 an inverted filter with a riprap revetment was placed on the lower half of the downstream slope to control seepage and provide protection against piping.

### 3. PREVIOUS STUDY AND SUBSURFACE CONDITIONS

AEP Geotechnical Engineering conducted a stability analysis in 1990, before the construction of the cut-off wall, to study the condition of the slopes of Pond 1 and Pond 2 [1]. This study included drilling of 7 exploratory borings on the main dike, some of which were continued into the bedrock to explore the conditions of the foundation soil. Shelby tube samples were obtained from the soil layers and direct shear tests as well as triaxial compression tests were conducted to evaluate shear strength of the material. Phreatic water surface was estimated based on the available data from the piezometers and the observed seepage on the downstream slope at elevation of 1533 ft. A set of stability analyses were performed to calculate safety factors against slope instability for the dikes and minimum factors of safety of 1.17 and 1.16 were calculated at the time for Pond 1A and Pond 1B, respectively.

The 1990 report recommended that a cut-off wall be installed along the crest of Pond 1A and Pond 1B to lower the phreatic water levels and improve the stability of the dikes. It was predicted that a cut-off wall would increase the safety factors to at least 1.45 by dissipating the phreatic level. A cement-bentonite-fly ash cut-off wall, 65 feet deep, was installed throughout the crest in the winter of 1991. Readings from the piezometer A-7R located on the downstream of the wall (Appendix 2), indicate that the maximum recorded water level dropped by about 8ft after the installation of the wall, while the water levels recorded at piezometer A-6, located on the upstream side of the wall, increased by about 10 feet. These readings confirm that the cut-off wall has been performing as intended: to decrease the phreatic level on the downstream side of the wall. Nonetheless, subsequent site inspections revealed that the seepage has been steady at the elevation of 1533 ft on the downstream slope of Pond 1B. Furthermore, water level in piezometer A-7 has consistently been recorded at about elevation of 1533 ft, the same level at which seepage is observed on the slope of Pond 1B.

The detailed construction report of the cut-off wall by Woodward-Clyde Consultant [2] states that, on the basis of visual inspection, seepage quantities decreased after the wall was placed. One boil area at the downstream toe near the reclaim pond was reported to be continued after the construction. This area was covered with a riprap over fabric blanket to minimize piping potential and it appears to have remained stable since then.

In 2009, a geotechnical investigation was conducted by MACTEC. In this study 12 borings were drilled on the crest and toe area of the dike at three sections to explore subsurface conditions and extrude split spoon and Shelby tube samples for laboratory testing. A boring location plan is provided in the Geotechnical Data Report (Appendix 2). Eight new piezometers, namely P-0901S, P-0901D, P0902, P0904, P0906, P-0908S, P-0908D, and P-0909 were installed in the boreholes to complement the existing piezometers. The new piezometers were installed in the crest and the toe area of the dikes to monitor water levels in the embankment, the foundation soil, and the bedrock. Details of the subsurface investigation and laboratory testing program are included in Appendix 2.

#### 4. IDENTIFICATION OF SOIL LAYERS AND MATERIAL PROPERTIES

Locations of the three sections selected for this study are presented in Appendix 1. The geometry of each section was based on the 2006 Photography Map presented in Appendix 1. The earthen zones of the dike at the selected section were based on AEP's drawing 13-10585-3107-4 and the 2009 boring logs (Appendix 2). Figures 1 through 3 present the idealized section developed for the seepage and stability analyses. Shear strength parameters (friction angle and cohesion) and hydraulic conductivity for each zone were primarily determined through field and laboratory testing (Appendix 2). Hydraulic conductivities of the material were adjusted to match the calculated phreatic levels with the measured piezometric levels before and after the installation of the slurry wall. Review of historical piezometric data (Appendix 3) shows that the water levels in the piezometers generally exhibit minor fluctuations that are the result of changes in the pool level, seasonal variations in the ground water regime, and measurement errors. Hydraulic conductivities were back-calculated by conservatively using the maximum recorded water levels in each piezometer. Tables 1 through 3 present material properties for the three sections, respectively.



- 1. Silty Sand with Shale Fragments -  
last raising
- 2. Silty Sand - second raising
- 3. Compacted Ash - first raising
- 4. Clay with Gravel - original dike
- 5. Clayey Silty Gravel with Sand
- 6. Stucced Fly Ash - Bottom Ash  
Mix
- 7. Sandy Lean Clay - original dike
- 8. Clayey Silt - foundation
- 9. Silty Sand - foundation
- 10. Sandy silt - foundation
- 11. Lean clay with sand -  
foundation
- 12. Weathered Shale
- 13. Bed Rock
- 14. Cutoff Wall

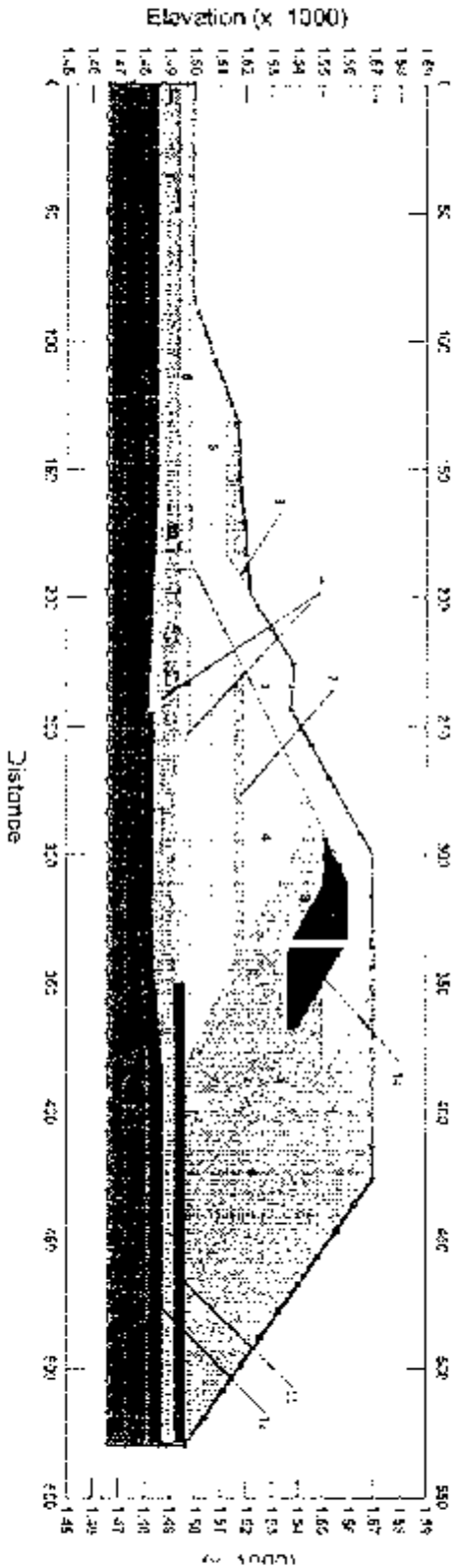

Figure 1. Idealized dike section A of Pond 1A.

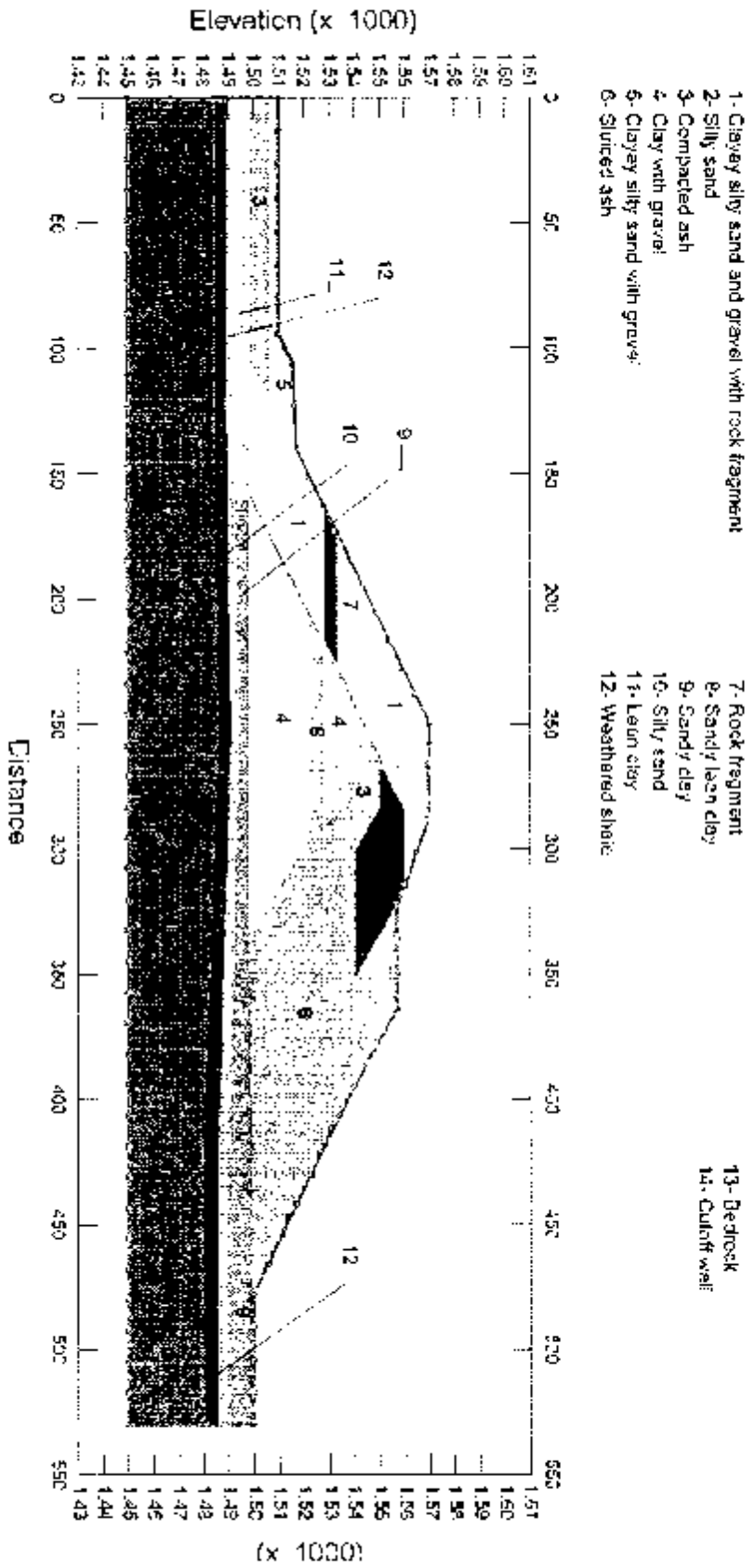

Figure 2. Idealized dike section B of Pond 1B.

- 1- Clayey silty sand and gravel with rock fragment
- 2- Silty sand
- 3- Compacted ash
- 4- Clay with gravel
- 5- Clayey silty sand with gravel
- 6- Sluiced ash
- 7- Clayey sand
- 8- Silty sand
- 9- silty clay
- 10- Weathered shale
- 11- Bedrock
- 12- Cutoff wall

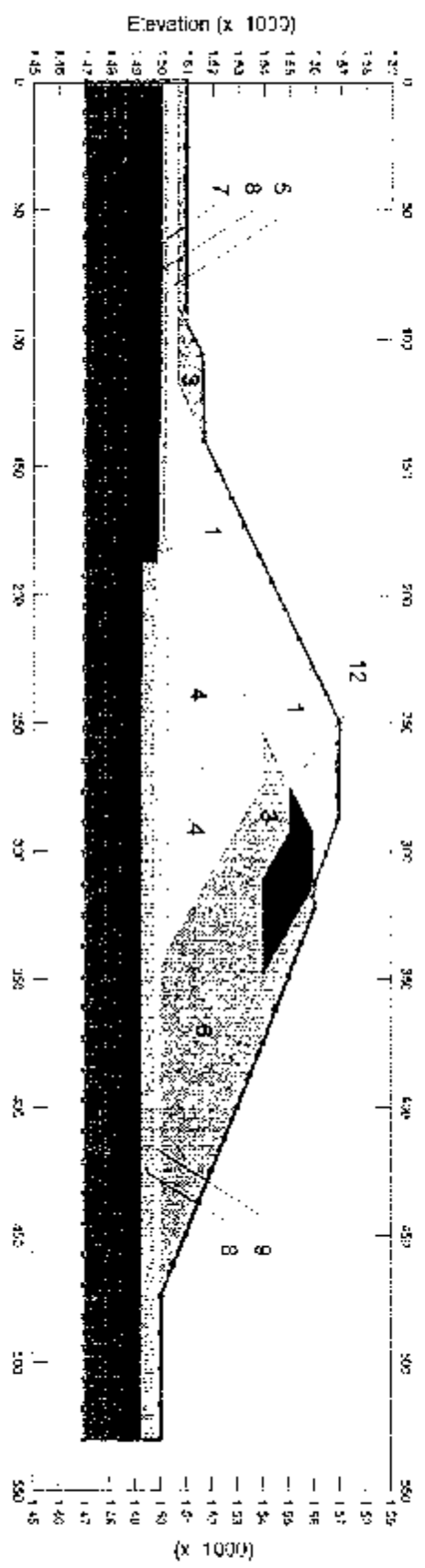

Figure 3. Idealized dike section C of Pond 1B.

|    | Soil Type                                      | Location                           | $\gamma_{sat}$<br>(pcf) | $\phi$<br>(deg) | C<br>(psf) | $\phi'$<br>(psf) | C'<br>(psf) | Saturation<br>k (ft/hr) |
|----|--|------------------------------------|-------------------------|-----------------|------------|------------------|-------------|-------------------------|
| 1  | Clayey silty sand and gravel w/ shale fragment | Outer shell                        | 136                     | 36              | 0          | 36               | 0           | 0.05                    |
| 2  | Silty sand                                     | Second raising                     | 136                     | 31              | 1006       | 36               | 0           | 5.0E-4                  |
| 3  | Compacted ash                                  | First raising                      | 100                     | 30              | 0          | 30               | 0           | 0.069                   |
| 4  | Clay w/ gravel                                 | Original dike                      | 134                     | 12              | 1810       | 25               | 700         | 3.5E-6                  |
| 5  | Clayey silty sand w/ gravel                    | Fill at toe                        | 135                     | 29              | 580        | 34               | 0           | 0.07                    |
| 6  | Sluiced ash                                    | Impoundment                        | 97                      | 22              | 0          | 22               | 0           | 0.069                   |
| 7  | Sandy lean clay                                | Original Dike                      | 140                     | 21              | 1270       | 32               | 850         | 3.5E-6                  |
| 8  | Clayey silt                                    | Foundation                         | 98                      | 20              | 400        | 39               | 0           | 1.58E-5                 |
| 9  | Silty sand                                     | Foundation                         | 91.5                    | 15              | 1800       | 31               | 700         | 5.8E-3                  |
| 10 | Sandy silt                                     | Foundation                         | 100                     | 20              | 400        | 28               | 0           | 2.13E-5                 |
| 11 | Lean clay w/ sand                              | Foundation                         | 88                      | 18              | 200        | 30               | 0           | 3.46E-6                 |
| 12 | Weathered shale                                | Foundation                         | 140                     | 35              | 1000       | 35               | 1000        | 2.1E-5                  |
| 13 | Bedrock  | Bedrock                            | NA                      | NA              | NA         | NA               | NA          | 1E-4                    |
| 14 | Cutoff wall                                    | Middle of crest into original dike | 150                     | NA              | 1200       | NA               | NA          | 6E-4                    |

Table 1. Material parameters for Section A.

|    | Soil Type                                      | Location                           | $\gamma_{sat}$<br>(pcf) | $\phi$<br>(deg) | C<br>(psf) | $\phi'$<br>(psf) | C'<br>(psf) | Saturation<br>k (ft/hr) |
|----|--|------------------------------------|-------------------------|-----------------|------------|------------------|-------------|-------------------------|
| 1  | Clayey silty sand and gravel w/ shale fragment | Outer shell                        | 136                     | 36              | 0          | 36               | 0           | 0.05                    |
| 2  | Silty sand                                     | Second raising                     | 136                     | 31              | 1006       | 36               | 0           | 5E-4                    |
| 3  | Compacted ash                                  | First raising                      | 100                     | 30              | 0          | 30               | 0           | 0.08                    |
| 4  | Clay w/ gravel                                 | Original dike                      | 134                     | 12              | 1810       | 25               | 700         | 3.5E-6                  |
| 5  | Clayey silty sand w/ gravel                    | Fill at toe                        | 135                     | 29              | 580        | 34               | 0           | 5.0E-5                  |
| 6  | Sluiced ash                                    | Impoundment                        | 97                      | 22              | 0          | 22               | 0           | 0.069                   |
| 7  | Rock fragments                                 | Outer shell at elevation 1533 ft   | 136                     | 35              | 0          | 35               | 0           | 0.8                     |
| 8  | Sandy lean clay                                | Original Dike                      | 140                     | 21              | 1270       | 32               | 850         | 1.2E-5                  |
| 9  | Sandy clay                                     | Foundation                         | 98                      | 20              | 400        | 35               | 400         | 2.0E-6                  |
| 10 | Silty sand                                     | Foundation                         | 90                      | 28              | 0          | 28               | 0           | 5.08E-3                 |
| 11 | Weathered shale                                | Foundation                         | 140                     | 35              | 1000       | 35               | 1000        | 2.1E-5                  |
| 12 | Lean clay                                      | Foundation                         | 92                      | 12              | 1800       | 25               | 0           | 4.72E-4                 |
| 13 | Bedrock  | Bedrock                            | NA                      | NA              | NA         | NA               | NA          | 1.0E-4                  |
| 14 | Cutoff wall                                    | Middle of crest into original dike | 150                     | NA              | 1200       | NA               | NA          | 6.0E-4                  |

Table 2. Material parameters for Section B.

|    | Soil Type                                      | Location                           | $\gamma_{sat}$<br>(pcf) | $\phi$<br>(deg) | C<br>(psf) | $\phi'$<br>(psf) | C'<br>(psf) | Saturation<br>k (ft/hr) |
|----|--|------------------------------------|-------------------------|-----------------|------------|------------------|-------------|-------------------------|
| 1  | Clayey silty sand and gravel w/ shale fragment | Outer shell                        | 136                     | 36              | 0          | 36               | 0           | 0.05                    |
| 2  | Silty sand                                     | Second raising                     | 136                     | 31              | 1006       | 36               | 0           | 5.0E-4                  |
| 3  | Compacted ash                                  | First raising                      | 100                     | 30              | 0          | 30               | 0           | 0.08                    |
| 4  | Clay w/ gravel                                 | Original dike                      | 134                     | 12              | 1810       | 25               | 700         | 3.5E-6                  |
| 5  | Clayey silty sand w/ gravel                    | Fill at toe                        | 135                     | 29              | 580        | 34               | 0           | 5.0E-5                  |
| 6  | Sliced ash                                     | Impoundment                        | 97                      | 22              | 0          | 22               | 0           | 0.069                   |
| 7  | Clayey sand                                    | Foundation                         | 97                      | 22              | 900        | 36               | 100         | 6.08E-6                 |
| 8  | Silty sand                                     | Foundation                         | 90                      | 6               | 400        | 18               | 400         | 5.0E-3                  |
| 9  | Silty clay                                     | Foundation                         | 110                     | 22              | 900        | 36               | 100         | 3.26E-6                 |
| 10 | Weathered shale                                | Foundation                         | 140                     | 35              | 1000       | 35               | 1000        | 2.1E-5                  |
| 11 | Bedrock  | Bedrock                            | NA                      | NA              | NA         | NA               | NA          | 1.0E-4                  |
| 12 | Cutoff wall                                    | Middle of crest into original dike | 150                     | NA              | 1200       | NA               | NA          | 0.0006                  |

Table 3. Material parameters for Section C.

US EPA ARCHIVE DOCUMENT

## 5. SEEPAGE ANALYSIS

Several seepage analyses were performed Using Geo-Studio Seep/W program to study the seepage behavior of the dikes and obtain the hydraulic gradient and pore pressure distributions across each dike sections. All the analyses were performed under two-dimensional transient conditions to establish the phreatic water surface and velocity field. The model inputs for a transient analysis include volumetric moisture content versus soil suction; and hydraulic conductivity versus soil suction curves. Seep/W has several built-in functions to estimate such functions based on soil type or grain size distribution, saturated hydraulic conductivity, and saturated volumetric moisture content (soil porosity). For more detail on the in-built functions and the estimation methods consult the user's manual of Seep/W [3]. The hydraulic conductivity of the cut-off wall was determined in laboratory as indicated in the Woodward-Clyde report. Operational pool levels used in the analyses were taken to be 1565 ft and 1558 ft for Pond 1A and Pond 1B, respectively.

Each analysis was performed in two stages. In stage one the pool levels were raised from the bottom of each pond to the operational pool levels without the cut-off wall, and in stage 2 the cut-off wall was activated by changing the material type of the elements that defined the wall. Figure 4 presents the computed total head distribution across Section A together with the seepage flow rates per unit length of the dike before the installation of the cut-off wall. The predicted phreatic surface can be seen to be in a reasonable agreement with the historical records of piezometer A-2 and A-3. To achieve such agreement the hydraulic conductivity of the outer shell was adjusted to 0.05 ft/hr. Depicted in Figure 5 are plots of historical readings of all the piezometers that are at or near Section A, including the piezometers installed in 2009. More information on the locations and screening depths of the piezometers has been included Appendix 3. The model predicts seepage at the toe that is confirmed by history of seepage and boils at this area of the dike. In general the model predictions are in reasonable agreement with the field observations and piezometric readings, indicating that the values of hydraulic conductivities and the boundary conditions used in the analysis were well selected.

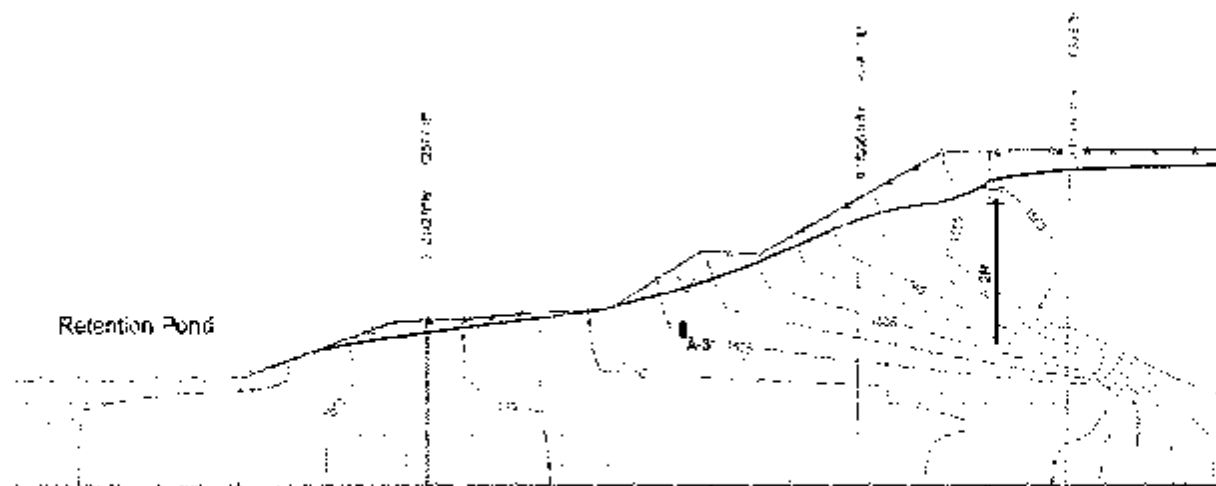

Figure 4. Computed total head distribution in Section A before construction of the cut-off wall.

Figure 6 shows similar results for the second stage of the analysis after the cut-off wall was activated. It can be seen that the computed phreatic surface is in reasonable agreement with the recorded piezometric water levels in piezometers P-0908S, P-0908D, and A-2R. Figure 7 shows the predicted hydraulic gradients (xy-gradient) at the toe and the retention pond. The maximum predicted gradient on the ground surface is about 0.3 that is within the acceptable range for this type of structure. The analysis showed that installation of the cut-off wall can lower the phreatic water levels and significantly decrease seepage flow rates through the embankment. These outcomes were expected and are consistent with field observations and monitoring data. The seepage analysis did not conclude any adverse condition that could be considered as a potential hazard to the safety and stability of the structure. The seepage areas that exist on the toe of the structure are, thereby, believed to be through permeable layers of the foundation soil, a normal phenomenon that occurs in majority of earthen structures and does not pose a threat on the stability. It has to be emphasized that this analysis is not a substitute for the regular inspections and monitoring program that is performed by the plant on quarterly basis. The inspection and monitoring program has to be continued and any unusual condition should be immediately reported to AEP Geotechnical Engineering.



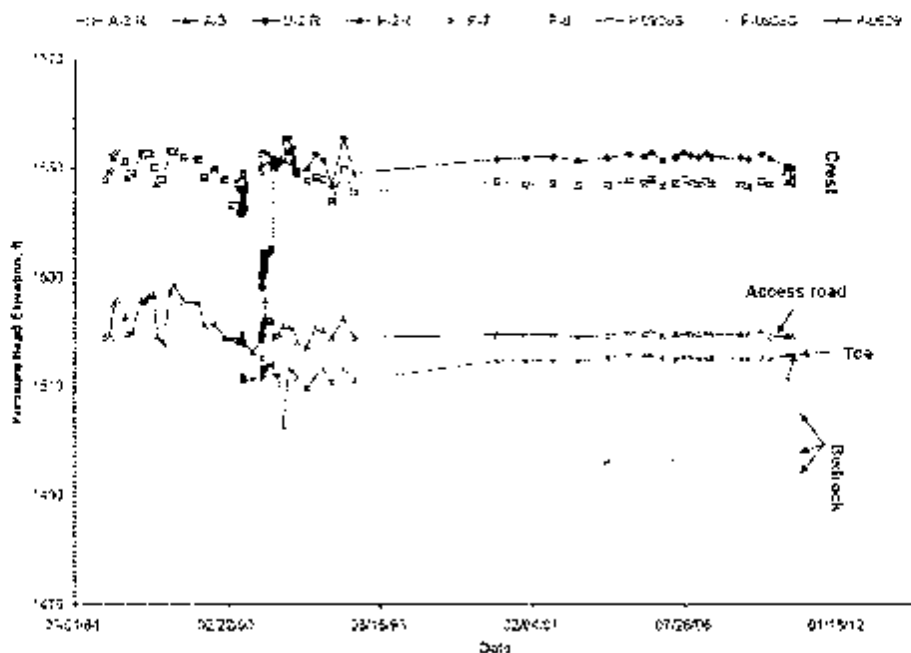

Figure 5. Historical piezometer records near Section A together with readings from newly installed piezometers P-0908S, P-0908D, and P-0909.

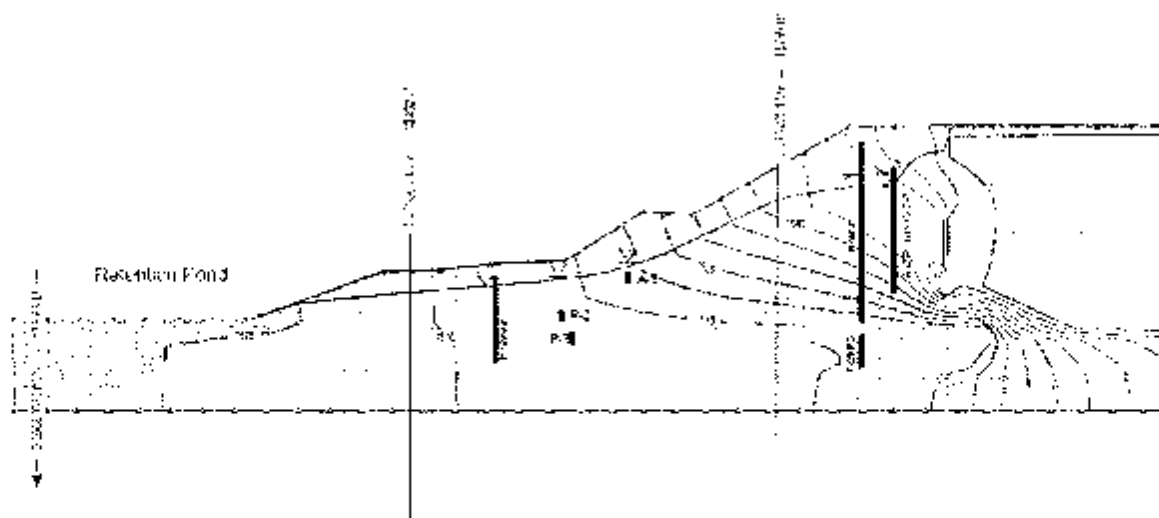

Figure 6. Computed total head distribution in Section A after construction of the cut-off wall.

US EPA ARCHIVE DOCUMENT

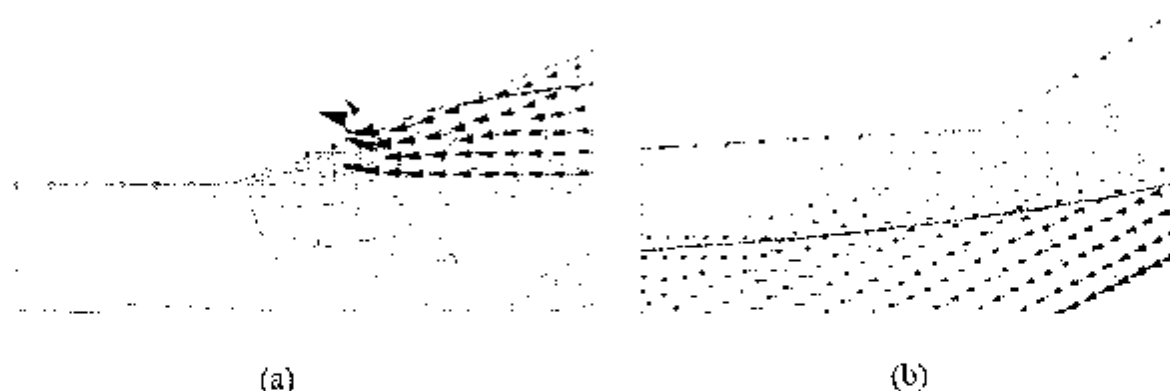

Figure 7. Computed hydraulic gradients for Section A after construction of the cut-off wall (a) at retention pond, and (b) at the embankment toe.

For the portion of the dike that is represented by Section B, the reported seepage at elevation 1533 ft continued even after construction of the cut-off wall. Furthermore, the observed piezometric level on the downstream side of the wall from piezometer A-7R has been at about the same elevation (1533 ft) since the construction of the wall. Water elevations in the piezometer B-4R and P-0904 have been at (approximately) elevation 1542 ft and 1546 ft, respectively. These observations suggest that a relatively permeable horizontal layer exists at about elevation 1533 ft, which acts as a conduit to transfer water to the slope face. Such a structure could have been formed by segregation of fine and coarse portions of the shale rockfill during placement. A high permeable layer over a low permeable layer within the outer shell is incorporated into the analytical model of Section B, as depicted in Figure 2. Figure 8 shows the computed total head distribution across the cross-section of the dike along with the seepage flow rates per unit length of the dike. A saturated hydraulic conductivity of 0.05 ft/hr was used for the outer shell at this section. The computed water levels for piezometers A-6 and A-7R are in agreement with the recorded water levels that are marked on this figure and also presented in Figure 9. The readings from the piezometers varied with the pool level, however, the maximum water levels (Figure 9), most likely corresponding to the maximum experienced pool level, were used to back-calculate the hydraulic conductivity. The computed levels are within few feet of field observations.

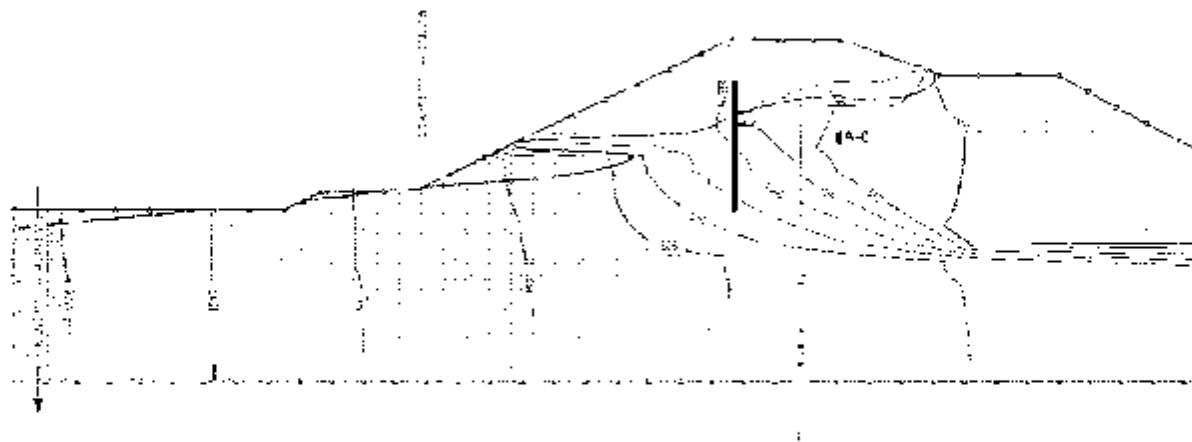

Figure 8. Computed total head distribution in Section B before installation of the cut-off wall.

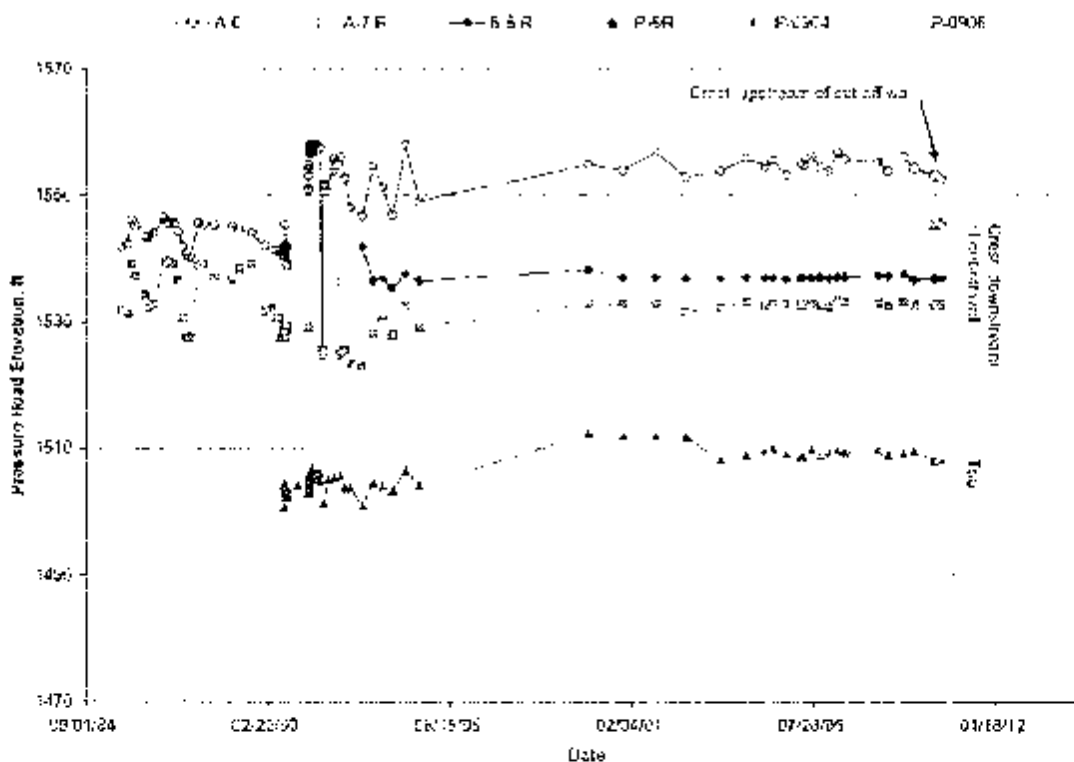

Figure 9. Historical piezometer records near Section B along with the readings from newly installed piezometers P-0904 and P-0905.

US EPA ARCHIVE DOCUMENT

Figure 10 illustrates computed total head distribution across the section after construction of the cut-off wall. The model predicted a 5 ft raise in the piezometric levels on the upstream side of the wall and a 5 ft drop on the downstream side, presenting consistency with the readings from piezometers A-6 and A-7R. Furthermore, the computed phreatic water level is in agreement with the readings from piezometers P-0906, P-5 and P-0904. Piezometer B-5R, located in the crest of Pond 1B between Section B and Section C, have a water level of about 1537 ft since 1992 (Figure 9), that is within the predicted levels on the downstream side of the cut-off wall.

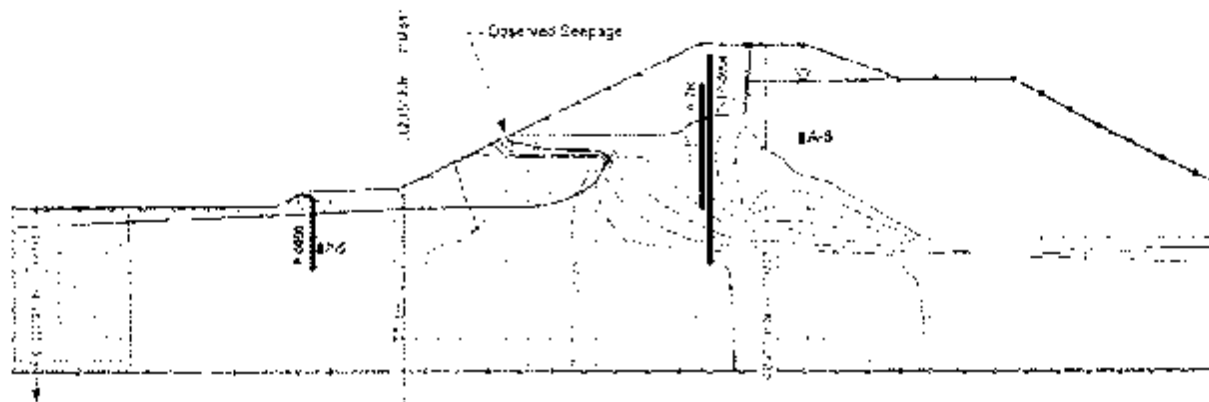

Figure 10. Computed total head distribution in Section B after installation of the cut-off wall.

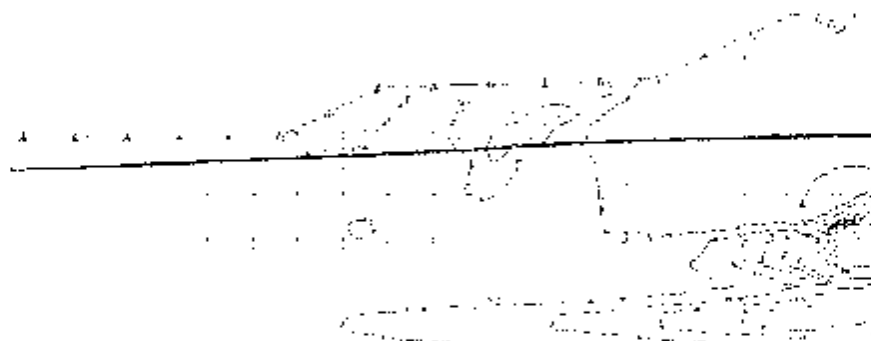

Figure 11. Computed hydraulic gradients at the toe of Section B after installation of the cut-off wall.

Figure 11 presents predicted hydraulic gradients at the toe of the section after construction of the cut-off wall. The maximum computed hydraulic gradient at the ground surface is less than 0.1 under the existing condition, an acceptable hydraulic gradient for this type of structure. Thus, no potential for piping failure due to internal erosion is believed to exist. The toe drain and inverted filter on the slope face was constructed to prevent future increases in the hydraulic gradients. Any unexplained raise in the piezometric levels at the toe area is an indication of pore pressure built up. Such condition can occur if the toe drain or inverted filter becomes clogged and it can be corrected by replacing the drain and filter layers.

A thin layer of ash on the slope of the original dike was not included in the seepage model for Section C, as analysis of Section A and B suggested a hydraulic conductivity of 0.05 ft/day for the outer shell that is very close to that of the compacted ash layer (0.08 ft/hr). Figure 12 shows the computed total head distribution across Section C before the construction of the cut-off wall. All the existing piezometers near this section were installed after the construction of the cut-off wall, thus no piezometric data are available to confirm the predicted phreatic surface. A hydraulic conductivity of 0.05 ft/hr back-calculated from analysis of Sections A and B was used for this section. The analysis predicts some seepage at the toe of the embankment before the construction of the cut-off wall, in agreement with the field observations made before 1991.

Figure 13 shows similar results for Section C after the construction of the cut-off wall. The predicted phreatic water levels are in agreement with the data from piezometers P-0901 and P-0902. Water level in Piezometer B-6 has not been shown on this figure because the screening depth of this piezometer is unknown. Figure 14 presents plots of recorded piezometric water levels for B-6, P-0901S, P-0901D, and P-0902. Figure 15 presents predicted hydraulic gradients at the toe of the section after construction of the cut-off wall. The maximum predicted gradient at the ground surface is about 0.2. No potential for piping failure due to internal erosion is believed to exist.

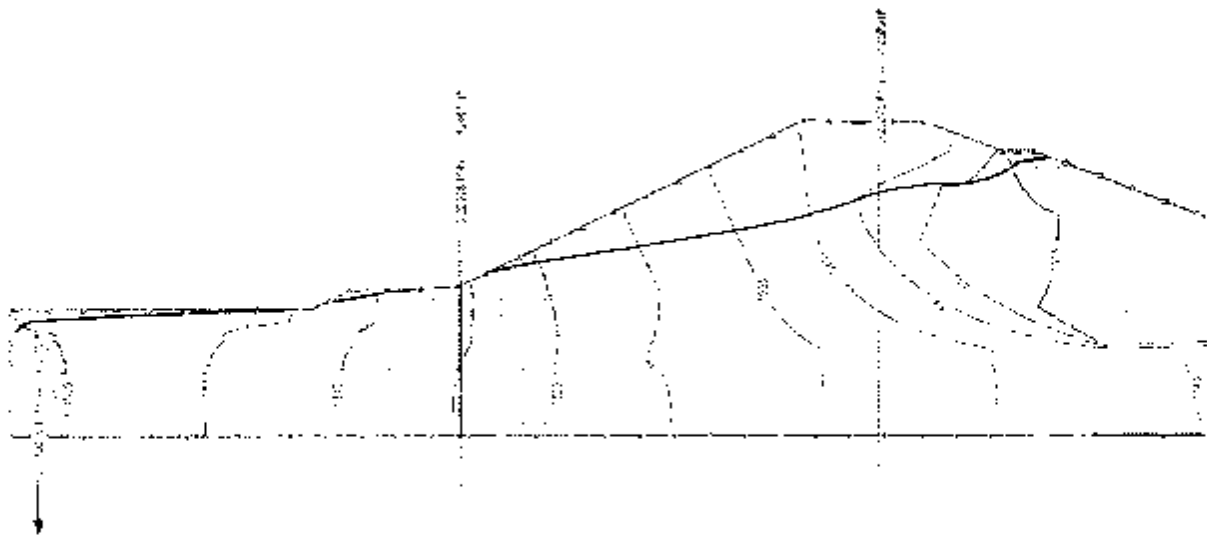

Figure 12. Computed total head distribution in Section C before installation of the cut-off wall.

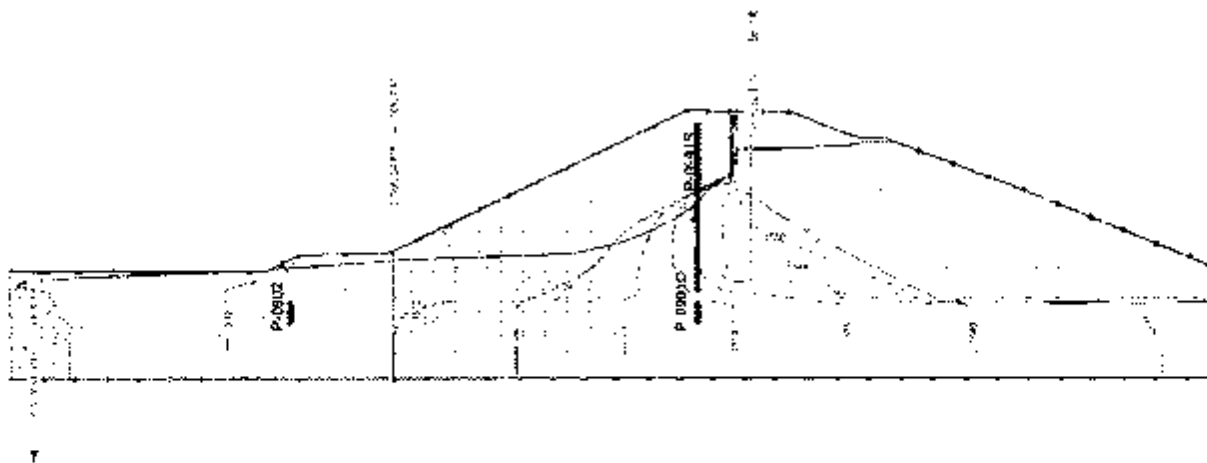

Figure 13. computed total head distribution in Section C after installation of the cut-off wall.

US EPA ARCHIVE DOCUMENT

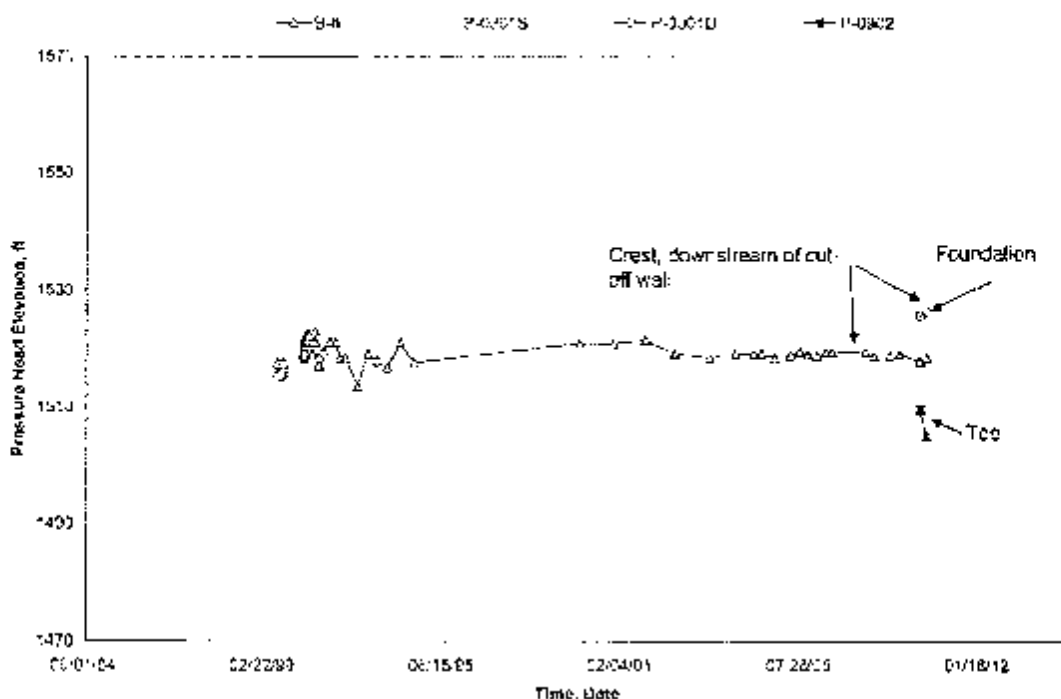

Figure 14. Piezometer water levels near Section C.

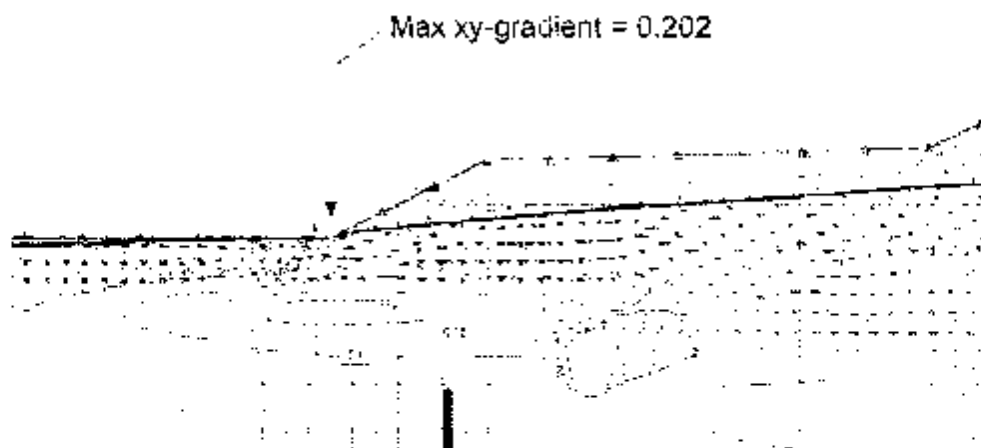

Figure 15. Computed hydraulic gradients at the toe of Section C at after installation of the cut-off wall.

US EPA ARCHIVE DOCUMENT

## 6. STABILITY ANALYSIS

The current stability analyses were performed using the Geo-Slope software developed by Geo-Slope International. This program can utilize various limit equilibrium solution methods to compute safety factors against slope instability. In these methods the failure wedge is divided up into several slices and each slice is assumed to be under limit equilibrium condition. In order to make the whole assembly of slices a statistically determined structure different theories utilize a different simplifying assumption to estimate the induced forces on the sides of each slice. In this study the limit equilibrium theory of Morgenstern-Price was used that can satisfy the equilibrium equations of both forces and moments.

The facility has been in its current operational condition for several years. Therefore the analyses for static stability of the slopes were performed for steady state seepage condition using effective shear strength parameters. Pore water pressure distributions calculated in the seepage analyses were imported into the model and used to calculate effective stresses along the failure surface. In all the stability analyses the minimum depth for the failure surface was set to be 10 ft. Any failure surface less than 10 feet deep is considered to be a surface sloughing that can be prevented by the existing riprap revetment, or be easily repaired. The inverted filter system was not directly built into the model; instead, a vertical surcharge load was applied to the lower portion of the downstream slope to simulate its effect. Safety factors were calculated for the downstream slope of each section. A uniaxial compressive strength of 1200 lb/ft<sup>2</sup> was used for the cut-off wall. Upstream slopes of the sections are not susceptible to sliding because both the ponds are filled with sluiced ash all the way up to the maximum normal operating elevations. Ash excavation operation in Pond ID is performed with care as not to excavate areas near the perimeter dikes. Thus, a berm is always maintained by the upstream slope of the dikes.

Three different failure modes were considered for each section under static loading. A deep failure starting at the crest and penetrating into the foundation soil, a shallow failure surface that enters and exits on the downstream face, and a block failure through the ash layer on the slope of the original dike (Sections A and B only). A summary of the computed safety factors for the three sections is presented in Table 4. It was determined that for Section A the critical failure mode was failure of the outer shell with a factor of safety of 1.5. For Section B and Section C



the critical mode was determined to be deep failure with computed safety factors of 1.7 and 1.6, respectively. Block failure mode was not considered for Section C because the geometry of the embankment and the material shear strengths are similar to those of Section B. Thus, the factor of safety associated with block failure mode is expected to be the same as that of Section B, that is 2.0. All the calculated factor of safeties are equal or higher than the minimum acceptable factor of safety of 1.5 [4] under steady-state seepage condition. The graphical outputs that show the critical failure surface for each analysis are included in Appendix 5.

| Section | Failure Mode |                     |               |
|---------|--------------|---------------------|---------------|
|         | Deep Failure | Outer Shell Failure | Block Failure |
| A       | 1.8          | 1.5                 | 1.9           |
| B       | 1.7          | 1.7                 | 2.0           |
| C       | 1.6          | 1.8                 |               |

Note: for each failure mode a systematic search was performed to find the critical failure surface and the associated factor of safety

Table 4. Steady-state condition slope stability safety factors.

Stability analyses under seismic loadings were performed following the pseudostatic method. In this method the effect of the design earthquake is simulated by imposing a lateral acceleration to the failure wedge. USGS seismic hazard maps published in 2008 [5] for this geographic region recommends the peak acceleration,  $a_{max}$ , of 0.16g corresponding to 2-percent probability of exceedance in 50 years. There are different methods to determine a design lateral acceleration coefficient,  $a_h$ , for the slope stability analysis [6]. Application of Newmark sliding block analysis has shown that earth dams with a safety factor greater than 1.0 using  $a_h > 0.5a_{max}$  are not expected to experience any large deformation during an earthquake [6]. Furthermore, the 1970 version of the Army Corps of Engineers Manual for the Engineering and design, Stability of earthen and rock fill dams [7] recommended  $a_h = 0.1g$  for this geographical region. Therefore the current analyses was based on a lateral acceleration,  $a_h$ , of 0.1g. This value is higher than  $0.5a_{max} = 0.08g$  calculated following Newmark's method. Stability of the sections

was assessed using drained and consolidated undrained shear strength parameters. Table 5 presents a summary of the stability analysis results for seismic condition with drained and undrained shear strengths.

| Section | Analysis Type          |                          |
|---------|------------------------|--------------------------|
|         | Drained shear strength | Undrained shear strength |
| A       | 1.3                    | 1.3                      |
| B       | 1.3                    | 1.4                      |
| C       | 1.3                    | 1.2                      |

Table 5. Seismic condition slope stability safety factors.

#### 7. WARNING AND CRITICAL PIEZOMETRIC LEVELS

The stability and safety of this facility highly depends on the proper performance of the cut-off wall and the toe drain in maintaining pore water pressures in the embankment within the design range. If the pore pressure begin to build-up in the embankment for example due to a crack in the cut-off wall the stability of the dike will need to be reviewed. The main purpose of the quarterly monitoring program is to detect any unexplained change in the groundwater regime so that any malfunctioning of the system can be corrected. The piezometric levels and seepage flow rates are reviewed by Geotechnical Engineering to assure that appropriate action will be taken if any unexplained behavior is recorded.

In this section, warning and critical piezometric levels have been established for the three critical sections studied. The warning and critical levels were determined by raising the phreatic surface in each stability model and calculating the corresponding safety factor. Warning level is defined as a water level sufficiently high that can lower safety factor of the dike section to values less than 1.5. The safety factors for Section A is already 1.5, thus any modest increase in the piezometric levels near this section above their maximum historical levels will raise a warning

note. Warning levels for Sections B and C were determined to be 7 ft increase from the maximum historical water levels in the crest or toe piezometers. If water level in a number of piezometers triggers the warning level, it may become necessary to conduct a new seepage and stability assessment for dike sections near those piezometers to attain a more specific assessment of the condition.

A critical water level is a water level sufficiently high to reduce safety factors below 1.2 for any portion of the dike. Such condition indicates that failure of the dike may be imminent and therefore, the Geotechnical Engineering Section has to assess the condition immediately. The increase in the piezometric levels should be measured with reference to the historical maximum water level of a piezometer. Critical level for Section A was determined to be a 7 ft increase in a piezometric level beyond its historical maximum level. The critical levels for Section B were determined to be 12 ft increase in water level for a piezometer located on the crest (downstream of the cut-off wall) or 10 ft increase in water level for a piezometer located at the toe. The critical levels for Section C were calculated to be 28 ft increase in water levels on the crest (downstream of the cut-off wall) or 9 ft increase in water levels at the toe. Graphical outputs of the stability analyses of this section are presented in Appendix 5.

Besides improper functioning of the cut-off wall and toe drain system other factor can influence piezometric levels, including heavy precipitation, changes in the ground water regime, human error, and malfunctioning of a piezometer. Simultaneous increase of water levels in multiple piezometers that continues or persists for a period of time is usually an indication of a problem that needs to be closely monitored and immediately assessed. If a warning or critical condition is detected by plant personnel Geotechnical Engineering Section shall be informed immediately, and monitoring of the piezometers and flow rate measurements shall be continued daily until instructed otherwise by Geotechnical Engineering.

#### 8. LIQUEFACTION POTENTIAL

No liquefaction potential assessment has been performed for Pond 1. However, based on other studies performed on similar facilities [8 and 9] and a site specific liquefaction study performed for Pond 2 [10] at Clinch River Plant, this facility is believed to have no potential for liquefaction

under the probable earthquakes that may affect this region because the magnitude of the expected earthquake is not sufficiently strong to impose cyclic stress ratios high enough to produce liquefaction.

## 9. CONCLUSIONS

In this study, a series of seepage and stability analyses were performed to assess the condition of the main dike that forms the bottom ash pond 1 at the Clinch River Plant. The subsurface stratigraphy and material parameters were selected based on the data from the 2009 and 1990 subsurface investigations as well as available design documents from AEP's archives. The hydraulic conductivity of the outer shell of the dike sections was calculated based on actual static water levels observed in the piezometers.

Three idealized dike sections were developed, one for Pond 1A and two for Pond 1B. It was concluded that a relatively permeable horizontal layer exists in the downstream shell of the Pond 1B dike in the area modeled in Section B. This horizontal layer, most likely formed as a result of segregation of fine and coarse materials during construction, can direct water toward the slope face and cause the observed seepage on the face of the dike at elevation 1533 ft. Calculated phreatic surface from the seepage analyses for all the three sections showed that the cut-off wall installed in 1991 has been effective in reducing static water levels and water pressures near the downstream slopes.

Steady-state factors of safety calculated for the dike sections were found to be 1.5 or higher. The calculated factors of safety under seismic condition were found to be 1.2 or higher. Under seismic loadings, the literature recommends a minimum factor of safety of 1.0 when a coefficient of lateral acceleration of  $a_x = 0.5a_{max}$  is used [6]. In this study a coefficient of lateral acceleration of  $0.62a_{max}$  was used, thus the calculated factor of safety of 1.2 is acceptable. The computed hydraulic gradients near the ground surface were found to be less than 0.5 for all the three sections. In conclusion, based on the outcomes of the seepage and stability analyses performed, slope failures, piping, or liquefaction at this facility is believed to be unlikely.

## 10. REFERENCES

- [1] Clinch River Plant, Stability analysis of ash pond dikes, American Electric Power Service Corporation, 1990.
- [2] Summary Report, Construction of cutoff wall. Ash pond 1A and 1B dikes, Clinch River Plant, Woodward – Clyde Consultant, December 1991.
- [3] Geo Studio 2007 Help, Seep / W, 2007.
- [4] US Army Corps of Engineers, Engineering and Design, Slope Stability, EM-1110-2-1902, October 2003.
- [5] USGS, Documentation for the 2008 update of the united states national seismic hazard maps, Open file report 2008-1128.
- [6] Kramer, S. L., Geotechnical earthquake engineering, Prentice Hall, 1996.
- [7] US Army Corps of Engineers, Engineering and Design, Stability of earth and rockfill dams, EM-1110-2-1902, 1970.
- [8] Zand, B., Tu, W., Amaya, P.J., Wolfe, W.E., and Butalia, T. S., An experimental investigation on liquefaction potential and post-liquefaction shear strength of impounded fly ash, Fuel, Vol 88, No. 7, July 2009.
- [9] Gandhi, S. R. and Dey, A. K., Liquefaction analysis of pond ash, Proceedings of the 15<sup>th</sup> international conference on solid waste technology management, Philadelphia, PA, Dec. 12-15, 1999.
- [10] Clinch River Pond 2 Closure, Appalachian Power Company, Clinch River Plant, Final closure subsurface investigations and design calculations, January 2009.

APPENDIX I

**FACILITY LAYOUT DRAWINGS**



**AIR SURVEY**  
Photogrammetric Mapping Services

This also compiled by:  
AIR SURVEY  
42100 BUSINESS COURT  
DALES, VIRGINIA  
20156-8705

Digital Ortho and Planimetric Mapping has been completed in accordance with procedures that have been demonstrated to comply with the National Standard for Spatial Data Accuracy (NSDA), for a target horizontal mapping scale of 1 inch = 100 feet and a specified contour interval of 2 feet.

Grid based on Virginia State Plane Coordinate System South Zone NAD 1983. Vertical datum based on NAVD 1928.

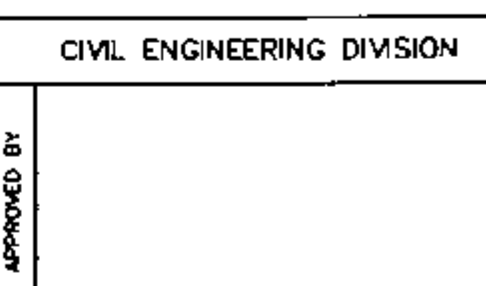
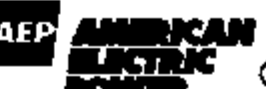
| DATE  | NO. | DESCRIPTION   | APPROV. |
|---|-----|---|---------|
| REVISIONS   |     |   |         |
| <p>THIS DRAWING IS THE PROPERTY OF THE AMERICAN ELECTRIC POWER SERVICE CORP. AND IS LOANED UPON CONDITION THAT IT IS NOT TO BE REPRODUCED OR COPIED, IN WHOLE OR IN PART, OR USED FOR FURNISHING INFORMATION TO ANY PERSON WITHOUT THE WRITTEN CONSENT OF THE AEP SERVICE CORP. OR FOR ANY PURPOSE DETRIMENTAL TO THEIR INTEREST, AND IS TO BE RETURNED UPON REQUEST.</p> |     |   |         |
| CLINCH RIVER LANDFILL AND PONDS<br>RUSSELL COUNTY, VIRGINIA   |     |   |         |
|    |     | DATE OF PHOTOGRAPHY: 3-04-06<br>SCALE: 1" = 100'  |         |
| DWG. NO.  |     | 1 OF 1  |         |
| SCALE:  |     | CIVIL ENGINEERING DIVISION  |         |
| DR:   |     | APPROVED BY<br><br>DATE: |         |
| ENGR:   |     |   |         |
| PRCL:   |     |   |         |
| ENGR:   |     |   |         |
| DATE:   |     |   |         |
|    |     | RIVERSIDE PLAZA<br>COLUMBUS, OH 43215   |         |

APPENDIX 2  
GEOTECHNICAL DATA REPORT



# GEOTECHNICAL DATA REPORT

AEP CLINCH RIVER DIKE DRILLING  
CAIRO, VIRGINIA

Prepared For:

**AMERICAN ELECTRIC POWER**

Columbus, Ohio

Prepared By:

**MACTEC ENGINEERING AND CONSULTING, INC.**

Abingdon, Virginia

MACTEC Project 3050090131

January 26, 2010





# MACTEC

engineering and constructing a better tomorrow

January 26, 2010

Mr. Gary F. Zych  
American Electric Power  
1 Riverside Plaza  
Columbus, Ohio 43215

Phone: 614-516-2917

Subject: **Geotechnical Data Report  
AEP Clinch River Dike Drilling  
Carbo, Virginia  
MACTEC Project# 3050090131**

Dear Mr. Zych:

MACTEC Engineering and Consulting, Inc. (MACTEC) is pleased to submit our results for soil and rock sampling, piezometer installation, and laboratory testing at the AEP Clinch River site in Carbo, Va. Our services, as authorized by Mr. Timothy A. Randolph of AEP, were provided in general accordance with our proposal number PR0P09ABIN.030 dated July 30, 2009.

This report reviews the project information provided to us, discusses the site and subsurface conditions encountered, and presents our laboratory results. The Appendices contain the Field Exploratory Procedures, a Key Sheet, Test Boring Logs and Piezometer Construction Logs, and the Laboratory Test Procedures and Test Results.

MACTEC appreciates this opportunity to provide our services to you and we look forward to serving as your geotechnical consultant throughout this project. Please contact us if you have questions regarding the information presented.

For Brian Owens  
with permission

Sincerely,  
MACTEC ENGINEERING AND CONSULTING, INC.

Ryan D. Rasnake, P.E.  
Engineering Services Manager

Brian D. Owens, P.E.  
Principal Engineer  
Office Manager

RDR:BDO:mss

## TABLE OF CONTENTS

|   | <u>Page</u> |
|---|-------------|
| LIST OF TABLES .....                      | iv          |
| LIST OF FIGURES .....                     | v           |
| 1.0 INTRODUCTION AND OBJECTIVES .....     | 6           |
| 2.0 SUBSURFACE EXPLORATION SUMMARY .....  | 7           |
| 3.0 LABORATORY SOIL TESTING SUMMARY ..... | 9           |
| 4.0 PIEZOMETER INSTALLATION SUMMARY ..... | 14          |

### TABLES

### FIGURES

APPENDIX A: FIELD EXPLORATORY PROCEDURES

APPENDIX B: KEY TO SYMBOLS AND DESCRIPTIONS/TEST BORING RECORDS

APPENDIX C: PIEZOMETER INSTALLATION LOGS

APPENDIX D: LABORATORY SOIL TEST RESULTS

## LIST OF TABLES

### Table

- 1 Table 2-1 – Test Boring Summary
- 2 Table 3-1 – Summary of Laboratory Testing Program
- 3 Table 4-1 – Piezometer Installation Summary

## LIST OF FIGURES

### Figure

- 1 Figure 1 – Site Location Map
- 2 Figure 2 – Doring Location Plan

## 1.0 INTRODUCTION AND OBJECTIVES

This report presents the findings of our subsurface exploration and laboratory testing recently performed for the existing Ash Dike at the American Electric Power (AEP) Clinch River Plant in Carbo, Virginia. We were selected by Mr. Timothy A. Randolph on behalf of American Electric Power (AEP) to perform a subsurface exploration at the existing Ash Dike at the AEP Clinch River Plant.

The objectives of our subsurface exploration was to gather information including field test data and laboratory test data about the site and subsurface conditions that could be used by AEP in their analysis of the existing Ash Dike at the Clinch River Plant. An assessment of site environmental conditions or an assessment for the presence or absence of pollutants in the soil, bedrock, surface water, or ground water of the site was beyond the proposed objectives of our exploration. Therefore, any statements in this report or attachments regarding color, odor, or unusual items or conditions are for information purposes only.

## 2.0 SUBSURFACE EXPLORATION SUMMARY

Subsurface conditions were explored with twelve widely spaced test borings drilled at predetermined locations at the site in general accordance with the procedures presented in Appendix A. The boring locations and depths were determined according to information provided by Mr. Gary Zych of AEP. Our geotechnical engineer established the actual boring locations in the field by taping distances and estimating angles relative to on-site landmarks. Therefore, the boring locations shown on the Boring Location Plan (Figure 2) should be considered approximate.

Subsurface conditions encountered at the boring locations are shown on the Test Boring Records in Appendix B. These Test Boring Records represent our interpretation of the subsurface conditions based on the field logs and visual examination of the field samples by one of our engineers. The lines designating the interfaces between various strata on the Test Boring Records represent the approximate interface locations.

The refusal materials in eight of the borings were explored using NQ rock coring procedures. The Recovery Ratio and Rock Quality Designation (RQD) of the recovered rock core samples were estimated in the laboratory during visual classification. The Recovery Ratio is defined as the percentage ratio between the length of core recovered and the length of core drilled on a given core run. RQD is defined as the percentage ratio between the sum of lengths of moderately hard or better core recovered that are at least 4 inches in length to the length of core drilled on a given core run. Recovery Ratios and RQD values are shown on the Test Boring Records in Appendix B. The recovery ratios ranged from 0 to 98 percent and the RQD values ranged from 0 to 92 percent.

A summary of the total depth, depth of fill/ash soils, depth of residual/alluvial soils and depth to bedrock encountered in the borings is shown below in Table 2-1.

Table 2-1  
 Test Boring Summary

| Boring Number   | Date Completed | Top of Ground Elev. (feet) | Total Depth (feet) | Depth of Fill Soils (feet)                                | Thickness of Residual/Alluvial Soils (feet) | Depth to Top of Rock (feet) | Elevation of Top of Rock (feet) |
|---|----------------|----------------------------|--------------------|---|---|-----------------------------|---------------------------------|
| B-0901  | 9/2/2009       | 1569.66                    | 83.9               | 79.0  | 8.0   | 73.8                        | 1490.86                         |
| B-0902  | 9/14/2009      | 1514.81                    | 29.0               | 7.6   | 16.4  | 24.0                        | 1490.81                         |
| B-0903  | 8/31/2009      | 1560.0                     | 80.1               | 79.8  | 4.3   | 75.1                        | 1484.90                         |
| B-0904  | 9/16/2009      | 1569.14                    | 88.8               | 75.0  | 3.8   | 78.8                        | 1490.34                         |
| B-0905  | 9/14/2009      | 1569.14                    | 30.0               | 30.0  | NE  | NE                          | NE                              |
| B-0905A   | 9/22/2009      | 1569.14                    | 80.0               | 80.0  | NE  | NE                          | NE                              |
| B-0906  | 9/3/2009       | 1518.15                    | 35.0               | 21.4  | 6.5   | 33.0                        | 1488.15                         |
| B-0907  | 9/13/2009      | 1567.0                     | 83.5               | 78.0  | 10.5  | 80.5                        | 1486.50                         |
| B-0908  | 9/11/2009      | 1567.63                    | 89.5               | 71.5  | 12.9  | 84.6                        | 1483.03                         |
| B-0908A   | 9/8/2009       | 1567.63                    | 21.8               | 21.8  | NE  | NE                          | NE                              |
| B-0908B   | 9/8/2009       | 1567.63                    | 19.5               | 19.5  | NE  | NE                          | NE                              |
| B-0909  | 9/11/2009      | 1519.35                    | 38.8               | 20.5  | 13.3  | 33.8                        | 1585.55                         |
| Note: Depths are in feet below ground surface.<br>Locations and elevations for borings 5, 5A, 7, 8A and 8B were estimated based on borings 0904 and 0908.<br><br>NE - Not Encountered |                |                            |                    | Prepared by JDR on 12/11/09<br>Checked by DDO on 12/11/09 |   |                             |                                 |



### 3.0 LABORATORY TESTING SUMMARY

Samples obtained during drilling were transported back to the MACTEC Abingdon, VA laboratory for testing. Laboratory testing was performed on soil samples selected by AEP. The laboratory testing program consisted of natural moisture tests, plasticity index tests, gradation tests with hydrometers, permeability tests, consolidation tests, triaxial compression tests and dry density tests. The results of the laboratory testing are presented in Appendix D and summarized in Table 3-1 below.

Table 3-1 – Summary of Laboratory Testing Program

| Test Type                       | Test Standard | No. Tests | Test Results                                |              |
|---------------------------------|---------------|-----------|---|--------------|
|                                 |               |           | Value Range                                 | Type (Units) |
| Moisture Content                | ASTM D 2216   | 25        | 31.5 – 31.9                                 | (%)          |
| Atterberg Limits - Liquid Limit | ASTM D 4318   | 12        | 31.0 – 46.0                                 | (%)          |
| Plastic Limit                   | ASTM D 4318   | 12        | 20.0 – 26.0                                 | (%)          |
| Plastic Index                   | ASTM D 4318   | 12        | 7.0 – 21.0                                  | (%)          |
| Gradation Analysis w/Hydrometer | ASTM D 422    | 11        | See Appendix C                              |              |
| Permeability of Soils           | ASTM D 5084   | 3         | $5.8 \times 10^{-4}$ – $2.9 \times 10^{-5}$ | (cm/s)       |
| Consolidation Tests             | ASTM D 2435   | 3         | 0.08 – 0.19                                 | $C_c$        |
|                                 | ASTM D 2435   | 3         | .81   | $C_u$        |
|                                 | ASTM D 2435   | 3         | 1.79 – 5.25                                 | $P_c$ (ksf)  |
| Triaxial Compression Tests      | ASTM D 4767   | 5         | 0.00-0.85                                   | $C$ (ksf)    |
|                                 | ASTM D 4767   | 5         | 17.70 – 36.50                               | $\Phi$ (deg) |
| Dry Density of Fly Ash          | ASTM D 7263   | 2         | 59.77 – 69.02                               | (pcf)        |

Prepared By: RDR 12/11/2009

Checked By: BDO 12/11/2009

#### 4.0 PIEZOMETER INSTALLATION SUMMARY

Eight groundwater piezometers were installed under the supervision of a MACTEC professional during September 2009 at the AEP Clinch River Site in Carbo, Virginia. Piezometers were installed after the completion of drilling activities. All piezometers were constructed using a sand pack consisting of DSI GP#2 sand extending approximately one foot below the screened interval and approximately two feet above the screened interval. ENVIROPLUG medium bentonite pellet seals were placed approximately two feet above the sand pack and below the surface of bedrock. Annular space was grouted with Volclay grout to ground surface for each well. In borings containing two piezometers an ENVIROPLUG medium bentonite pellet seal of approximately five feet was placed two feet above the lower screen to approximately one foot of the bottom of the upper screen. A summary of the well installation and screen length is presented in Table 1. Piezometer installation logs are included in Appendix C.

Table 4-1  
 PIEZOMETER Installation Summary

| Boring Number                             | Date Installed | Total Depth (feet) | Top of Screen (feet) | Bottom of Screen (feet)                                   | Elevation of Top of Screen (feet) | Elevation of Bottom of Screen (feet) | Elevation of 24-HR Groundwater Level (feet) |
|---|----------------|--------------------|----------------------|---|-----------------------------------|--------------------------------------|---|
| B-0901                                    | 9/2/2009       | 66.5               | 7.0                  | 66.0  | 1562.66                           | 1503.66                              | 1547.66                                     |
| B-0901                                    | 9/2/2009       | 78.9               | 73.5                 | 78.4  | 1496.16                           | 1491.26                              | 1547.66                                     |
| B-0902                                    | 9/14/2009      | 23.0               | 7.0                  | 22.0  | 1507.81                           | 1492.81                              | 1509.51                                     |
| B-0904                                    | 9/16/2009      | 77.8               | 6.0                  | 77.8  | 1563.14                           | 1491.34                              | 1561.14                                     |
| B-0906                                    | 9/3/2009       | 29.0               | 6.0                  | 29.0  | 1512.15                           | 1489.15                              | 1506.85                                     |
| B-0908                                    | 9/11/2009      | 67.0               | 7.0                  | 67.0  | 1560.63                           | 1500.63                              | 1518.23                                     |
| B-0908                                    | 9/11/2009      | 83.4               | 76.0                 | 83.4  | 1491.63                           | 1484.23                              | 1518.23                                     |
| B-0909                                    | 9/11/2009      | 32.0               | 7.0                  | 32.0  | 1512.35                           | 1487.35                              | 1491.75                                     |
| Note: Depths in feet below ground surface |                |                    |                      | Prepared by RDR on 12/10/09<br>Checked by BDO on 12/11/09 |                                   |                                      |   |

Lockable, steel well casing protective caps were installed at each location. Well caps were extended approximately 3 feet above ground surface and set in concrete cement. One protective bollard was set approximately 3 feet from each well in general accordance with ASTM D5787.

**FIGURES**

### Location of AEP Clinch River Dike Drilling Project

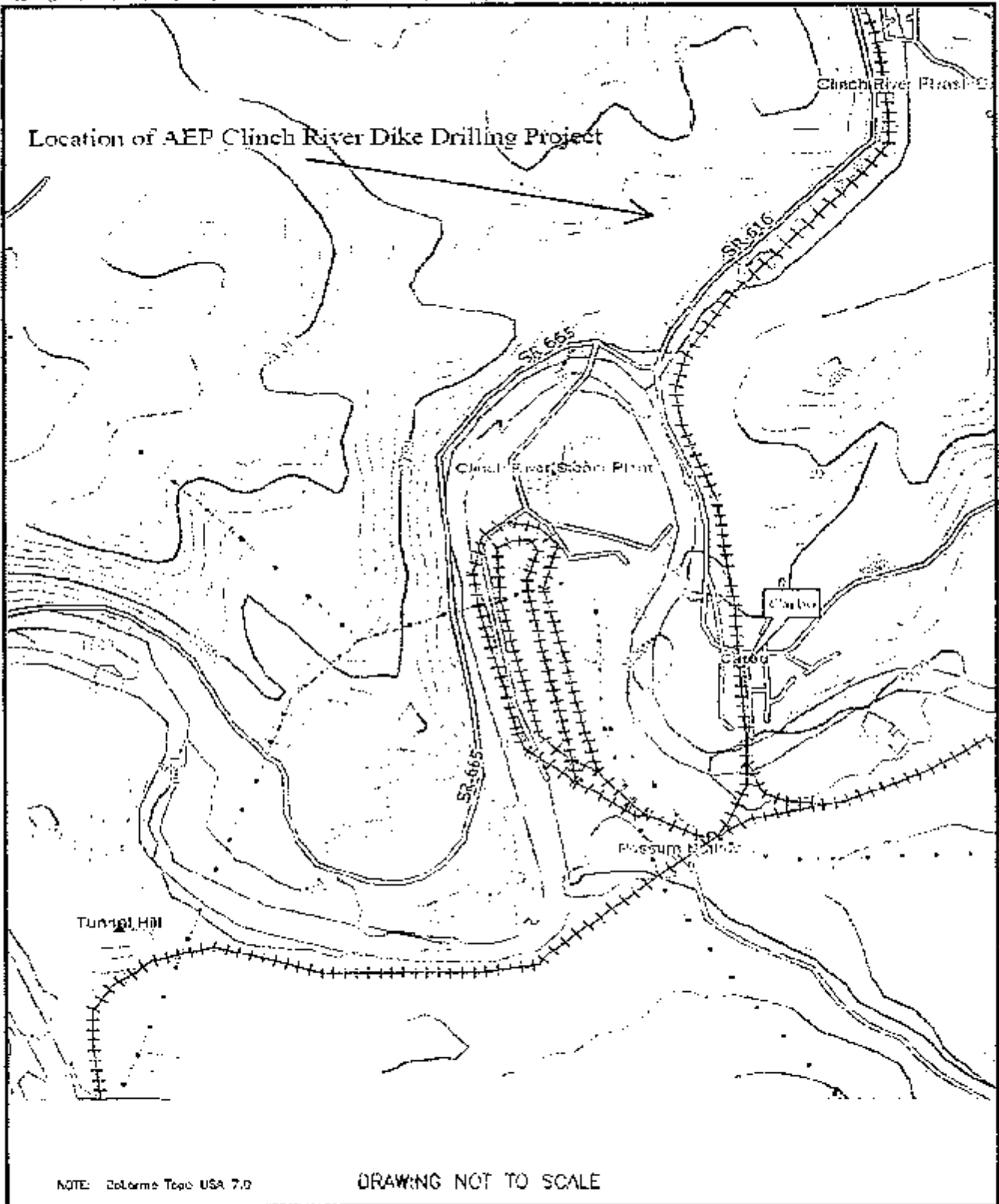

NOTE: conforms to: USA 7.0

DRAWING NOT TO SCALE

AEP Dike Drilling  
Carbo, VA

# MACTEC

MACTEC Engineering and Consulting, Inc.  
1070 West Main Street, Suite 5  
Abingdon, Virginia 24210

SITE LOCATION  
PLAN

PROJECT NO.  
3050-09-0131

FIGURE 1

US EPA ARCHIVE DOCUMENT

US EPA ARCHIVE DOCUMENT

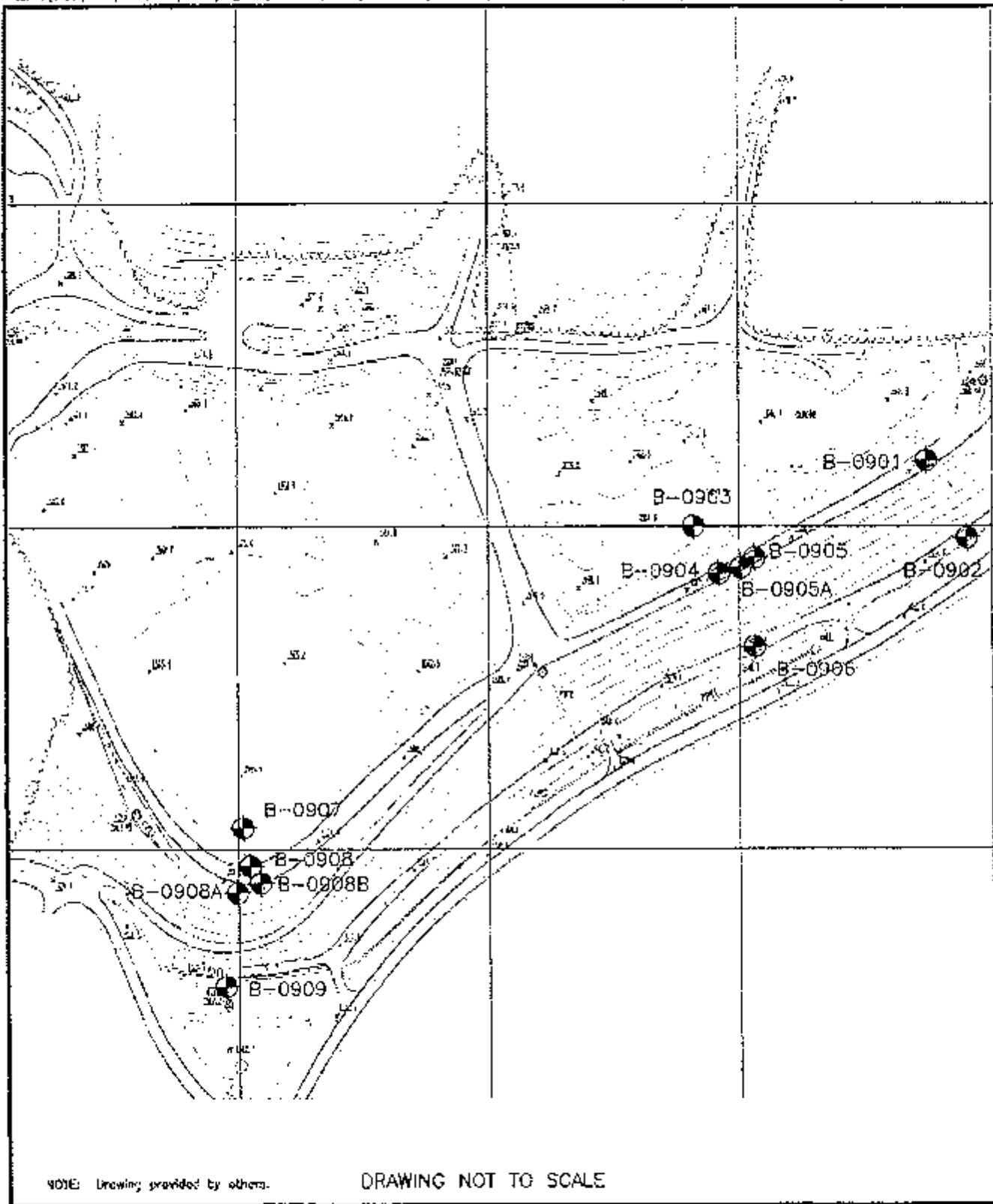

NOTE: Drawing provided by others.

DRAWING NOT TO SCALE

AEP Dike Grilling  
Carbo, VA



**MACTEC**  
 MACTEC Engineering and Consulting, Inc.  
 1070 West Main Street, Suite 5  
 Albemarle, Virginia 24210

BORING LOCATION  
PLAN

PROJECT NO.  
3050-09-0131

FIGURE 2

**APPENDIX A**

**FIELD EXPLORATORY PROCEDURES**

## FIELD EXPLORATORY PROCEDURES

### Soil Test Boring

All boring and sampling operations were conducted in general accordance with ASTM D 1586. The borings were advanced by mechanically turning continuous steel hollow-stem auger flights into the ground. At regular intervals, soil samples were obtained with a standard 2.25-inch I.D., 2-inch O.D., split-tube sampler. The sampler was first seated 6 inches to penetrate any loose cuttings and then driven an additional foot with blows of a 140-pound hammer falling 30 inches. The number of hammer blows required to drive the sampler the final foot of penetration was recorded and is designated the "standard penetration test (SPT) resistance." Proper evaluation of the penetration resistance provides an index to the soil's strength, density, and ability to support foundations.

Representative portions of the soil samples obtained from the split-tube sampler were sealed in glass jars and transported to our laboratory, where they were examined by our engineer to verify the driller's field classifications. Test Boring Records are attached, graphically showing the soil descriptions and penetration resistances.

### Undisturbed Sampling

For quantitative testing, relatively undisturbed samples are obtained by pushing sections of thin-walled steel or brass tubing (Sheehy tube) into the soil at the desired sampling levels. This procedure is described by ASTM Specification D 1587. Each tube is carefully removed from the ground, sealed, and transported to the laboratory for specialized testing. Locations and depths of undisturbed samples are shown on the Test Boring Records.

### Rock Coring

Prior to coring, casing is set in the hole drilled through the overburden soils, if necessary, to keep the hole from caving. Refusal materials are then cored according to ASTM D 2113, using a diamond-studded bit fastened to the end of a hollow, double-tube core barrel. This device is rotated at high speeds, and the cuttings are brought to the surface by circulating water. Core samples of the material penetrated are protected and retained in the swivel-mounted inner tube. Upon completion of each core

run, the core barrel is brought to the surface, the core recovery is measured, the samples are removed, and the core is placed in boxes for transportation and storage.

The core samples are returned to the laboratory where the refusal material is identified, and the percent core recovery and rock quality designation are determined by a soils engineer or geologist. The percent core recovery is the ratio of the sample length obtained to the depth drilled, expressed as a percent. The rock quality designation (RQD) is obtained by summing up the length of core recovered, including only the pieces of core that are 4 inches or longer, and divided by the total length drilled.

The percent core recovery and RQD are related to the soundness and continuity of the refusal material. Refusal material descriptions, recoveries, and the bit size used are shown on the "Test Boring Records."

The NQ and NX sizes designate bits that obtain rock cores 1-7/8 and 2-1/8 inches in diameter, respectively.

#### **Water Level Measurements**

Water level readings and cased depths are measured in completed borings as noted on the Test Boring Records. These water level readings indicate the approximate location of the ambient ground-water table at the time of our field investigation. In some instances, the cased depths may possibly indicate ground-water activity.

The time of boring water level reported on the Test Boring Records is determined by field crews as the drilling tools are advanced. Additional water table readings are generally obtained approximately one day after the borings are completed. The time lag is used to permit stabilization of the ground-water table that has been disrupted by the drilling operations. The readings are taken by dropping a weighted line down the boring or using an electrical probe to detect the water level surface.



**APPENDIX B**

**KEY TO SYMBOLS AND DESCRIPTIONS**

**TEST BORING RECORDS**

| MAJOR DIVISIONS   | GROUP SYMBOLS | TYPICAL NAMES   | Undisturbed Sample              | Auger Cuttings             |
|---|---------------|---|---------------------------------|----------------------------|
| GRAVELS<br>(More than 50% of coarse fraction is larger than the No. 4 sieve size)     | GW            | Well graded gravels, gravel - sand mixtures, little or no fines.  | Standard Penetration Test       | Soils Sample               |
|   | GP            | Poorly graded gravels or gravel - sand mixtures, little or no fines.  | Rock Core                       | Crandall Sampler           |
| COARSE GRAINED SOILS<br>(More than 50% of material is larger than No. 200 sieve size) | GM            | Silty gravels, gravel - sand - silt mixtures.   | Dilatometer                     | Pressure Meter             |
|   | GC            | Clayey gravels, gravel - sand - clay mixtures.  | Packer                          | No Recovery                |
| SANDS<br>(More than 50% of coarse fraction is smaller than the No. 4 Sieve Size)      | SW            | Well graded sands, gravelly sands, little or no fines.  | Water Table at time of Drilling | Water Table after 24 hours |
|   | SP            | Poorly graded sands or gravelly sands, little or no fines.  |                                 | Caved Level after 24 Hours |
| SANDS WITH FINES<br>(Appreciable amount of fines)                                     | SM            | Silty sands, sand - silt mixtures.  |                                 |                            |
|   | SC            | Clayey sands, sand - clay mixtures.   |                                 |                            |
| FINE GRAINED SOILS<br>(More than 50% of material is smaller than No. 200 sieve size)  | ML            | Inorganic silts and very fine sands, weak flow, silty or clayey fine sand or clayey silts and with slight plasticity. |                                 |                            |
|   | CL            | Inorganic silts and clays, silty clays, lean clay.  |                                 |                            |
|   | OL            | Organic silts and organic silty clays of low plasticity.  |                                 |                            |
| SILTS AND CLAYS<br>(Liquid limit greater than 50)                                     | MH            | Inorganic silts, micaceous or diatomaceous fine sandy or silty soils, elastic silts.                                  |                                 |                            |
|   | CH            | Inorganic clays of high plasticity, fat clays.  |                                 |                            |
| HIGHLY ORGANIC SOILS  | OIT           | Organic clays of medium to high plasticity, organic silts.  |                                 |                            |
|   | PT            | Peat and other highly organic soils.  |                                 |                            |

| CORRELATION OF DYNAMIC CONE PENETRATION RESISTANCE WITH RELATIVE DENSITY AND CONSISTENCY (PLEISTOCENE RESIDUAL SOILS) |                  | SILT & CLAY  |             |
|---|------------------|--------------|-------------|
| No. of Blows  | Relative Density | No. of Blows | Consistency |
| 0 - 4   | Very Loose       | 0 - 2        | Very Soft   |
| 5 - 10  | Loose            | 3 - 4        | Soft        |
| 11 - 30   | Firm             | 5 - 8        | Firm        |
| 31 - 50   | Dense            | 9 - 15       | Stiff       |
| Over 50   | Very Dense       | 16 - 30      | Very Stiff  |
|   |                  | 31 - 50      | Hard        |
|   |                  | Over 50      | Very Hard   |

## KEY TO SYMBOLS AND DESCRIPTIONS



  

| SILT OR CLAY |        | SAND   |        | GRAVEL |        | BOULDERS |          |
|--------------|--------|--------|--------|--------|--------|----------|----------|
| Fine         | Coarse | Medium | Coarse | Fine   | Coarse | Cobbles  | Boulders |
| No. 200      | No. 40 | No. 40 | No. 20 | No. 20 | No. 4  | No. 4    | No. 4    |

U.S. STANDARD SIEVE SIZE

BOUNDARY CLASSIFICATIONS: Soils possessing characteristics of two groups are designated by combinations of group symbols.

Reference: The Unified Soil Classification System, Corps of Engineers, U.S. Army Technical Memorandum No. 3-557, Vol. 1, March, 1953 (Revised April, 1950)

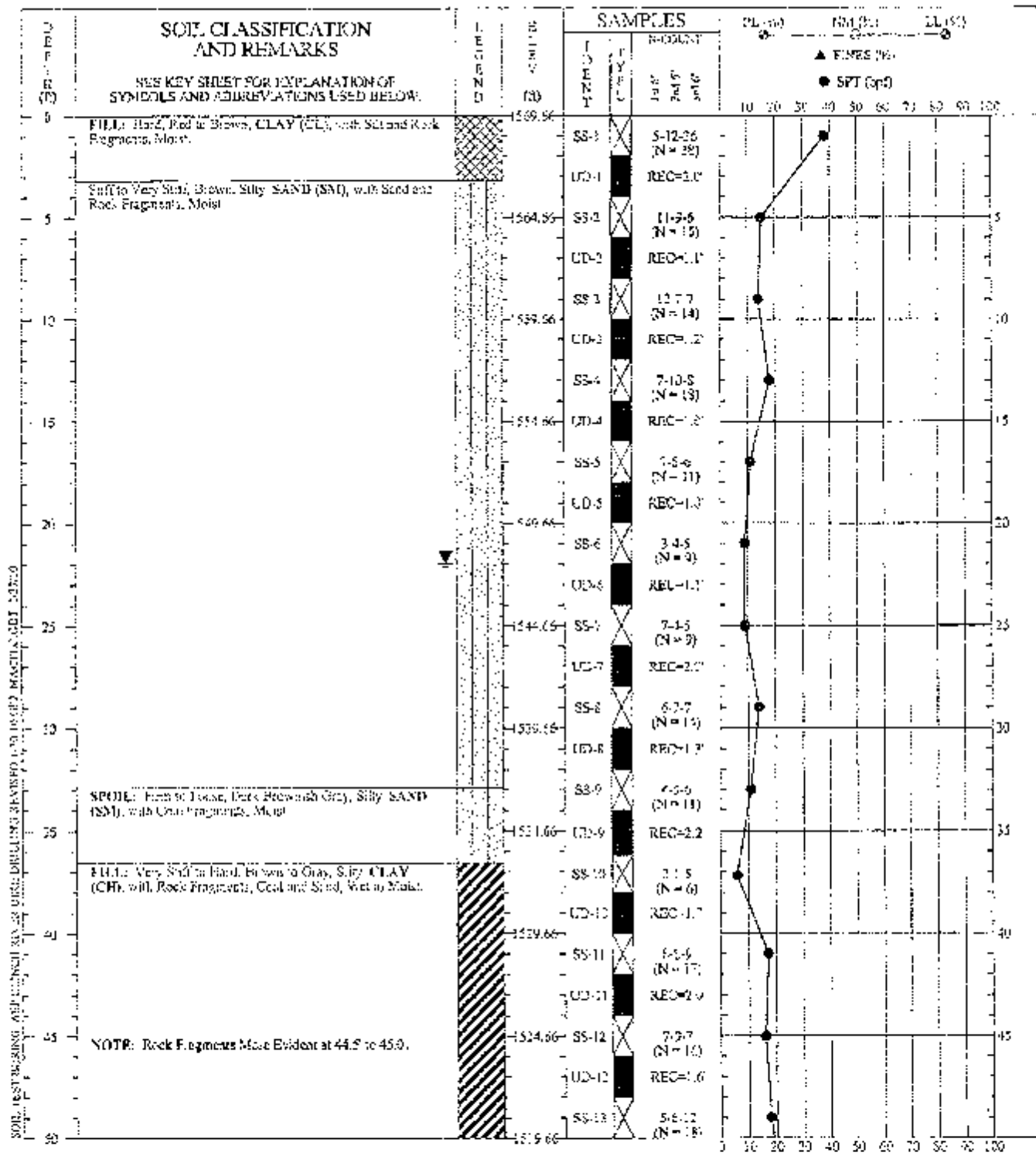

SOIL TEST BORING AEP CLINCH RIVER DIKE DRILLING REVISED 1-10-09? MACTEC A01 10/20/09

DRILLER: Tri-State Drilling  
 EQUIPMENT: CME 75 Truck Rig  
 METHOD: 12" HSA  
 NORTHING: 352740.982  
 EASTING: 1042375.283  
 LOGGED BY: Ian McDaniel  
 CHECKED BY: Ryan Ramirez *EDR*

**SOIL TEST BORING RECORD**

BORING NO.: B-0901  
 PROJECT: AEP Clinch River Dike Drilling  
 LOCATION: Carbo, Virginia  
 DRILLED: September 2, 2009  
 PROJECT NO.: 3050-09-0131



THIS RECORD IS A REASONABLE INTERPRETATION OF SUBSURFACE CONDITIONS AT THE EXPLORATION LOCATION. SUBSURFACE CONDITIONS AT OTHER LOCATIONS AND AT OTHER TIMES MAY DIFFER. INTERFACES BETWEEN STRATA ARE APPROXIMATE. TRANSITIONS BETWEEN STRATA MAY BE GRADUAL.

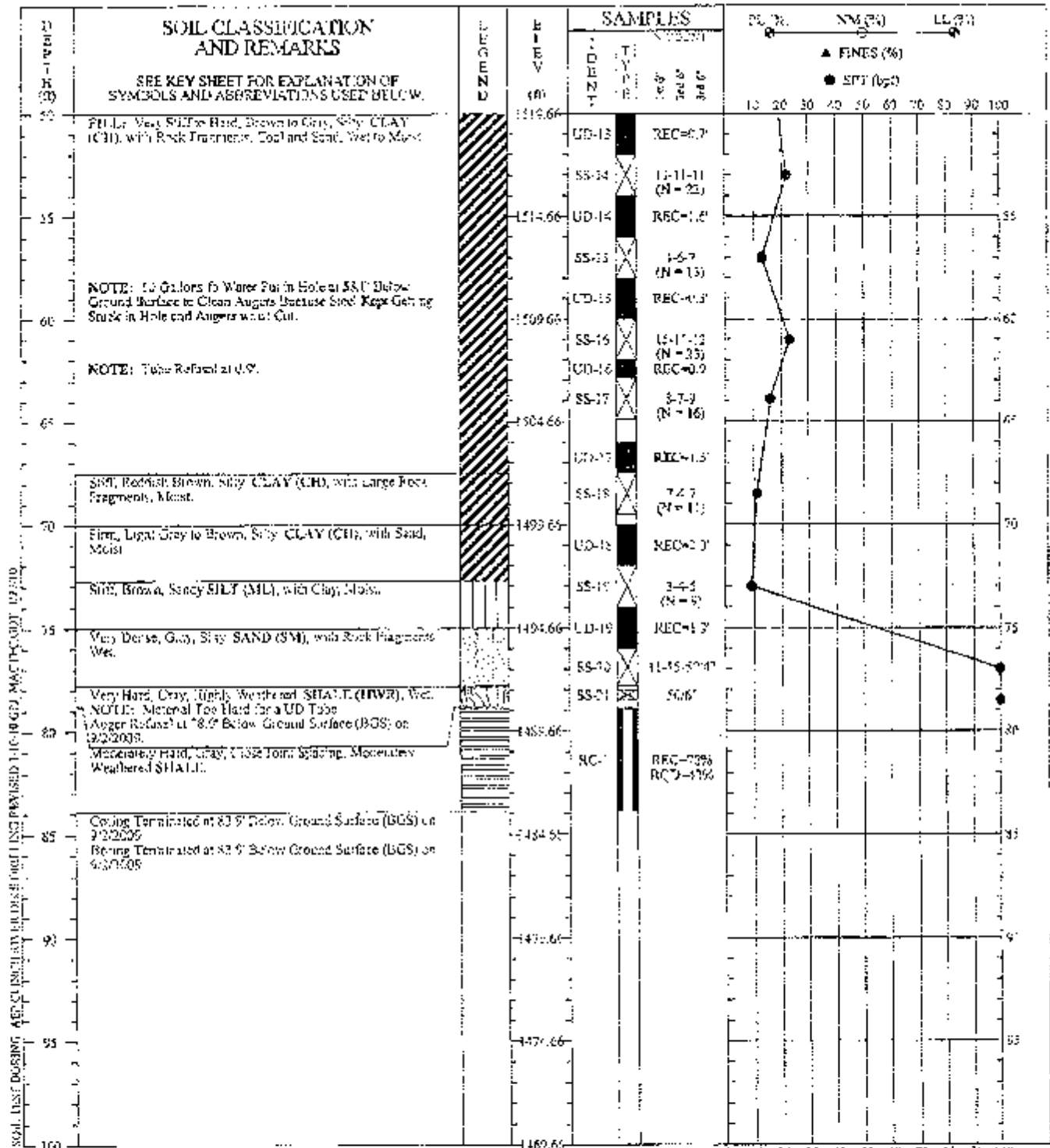

DRILLER: Tri-State Drilling  
 EQUIPMENT: CMB 75 Track Rig  
 METHOD: 3.25" HSA  
 NORTHING: 3525445.992  
 EASTING: 11417737.283  
 LOGGED BY: Jon McDaniel  
 CHECKED BY: Ryan Parake *RDP*

**SOIL TEST BORING RECORD**

BORING NO.: B-0901  
 PROJECT: AEP Clinch River Dike Drilling  
 LOCATION: Carbo, Virginia  
 DRILLED: September 2, 2009  
 PROJECT NO.: 3050-09-013

THIS RECORD IS A REASONABLE INTERPRETATION OF SUBSURFACE CONDITIONS AT THE EXPLORATION LOCATION. SUBSURFACE CONDITIONS AT OTHER LOCATIONS AND AT OTHER TIMES MAY DIFFER. INTERFACES BETWEEN STRATA ARE APPROXIMATE. TRANSITIONS BETWEEN STRATA MAY BE GRADUAL.



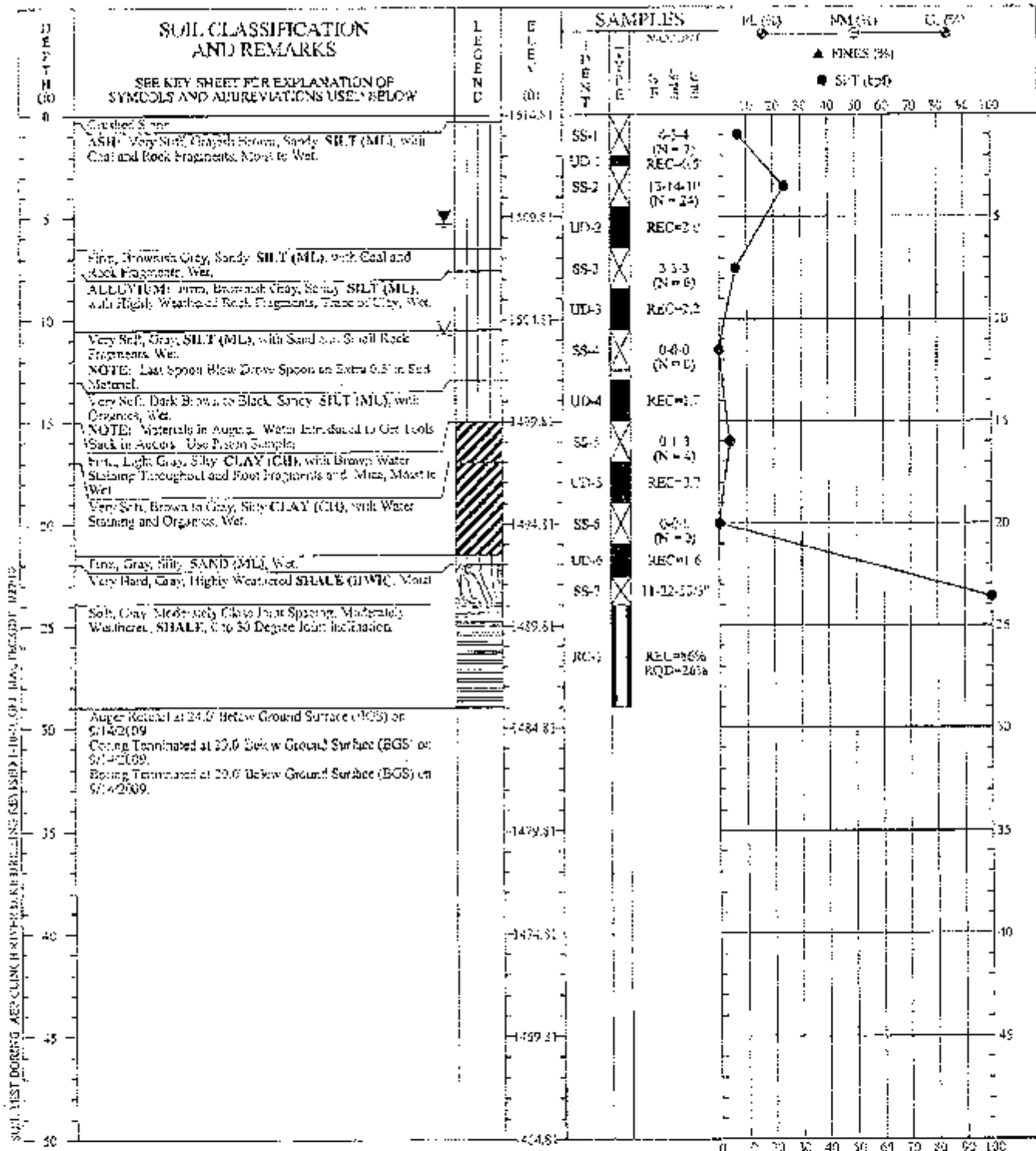

DRILLER: Tri-State Drilling  
 EQUIPMENT: CME 75 Truck Rig  
 METHOD: 3.05" HSA  
 NORTHING: 332283.515  
 EASTING: 1946874.905  
 LOGGED BY: Jim McDaniel  
 CHECKED BY: Ryan Kazanicki *RDR*

**SOIL TEST BORING RECORD**

**BORING NO.:** B-0902  
**PROJECT:** ASP Clinch River Dike Drilling  
**LOCATION:** Carbo, Virginia  
**DRILLED:** September 14, 2009  
**PROJECT NO.:** 3050-09 0131

PAGE 1 OF 1

**MACTEC**

THIS RECORD IS A REASONABLE INTERPRETATION OF SUBSURFACE CONDITIONS AT THE EXPLORATION LOCATION. SUBSURFACE CONDITIONS AT OTHER LOCATIONS AND AT OTHER TIMES MAY DIFFER. INTERFACES BETWEEN STRATA ARE APPROXIMATE. TRANSITIONS BETWEEN STRATA MAY BE GRADUAL.

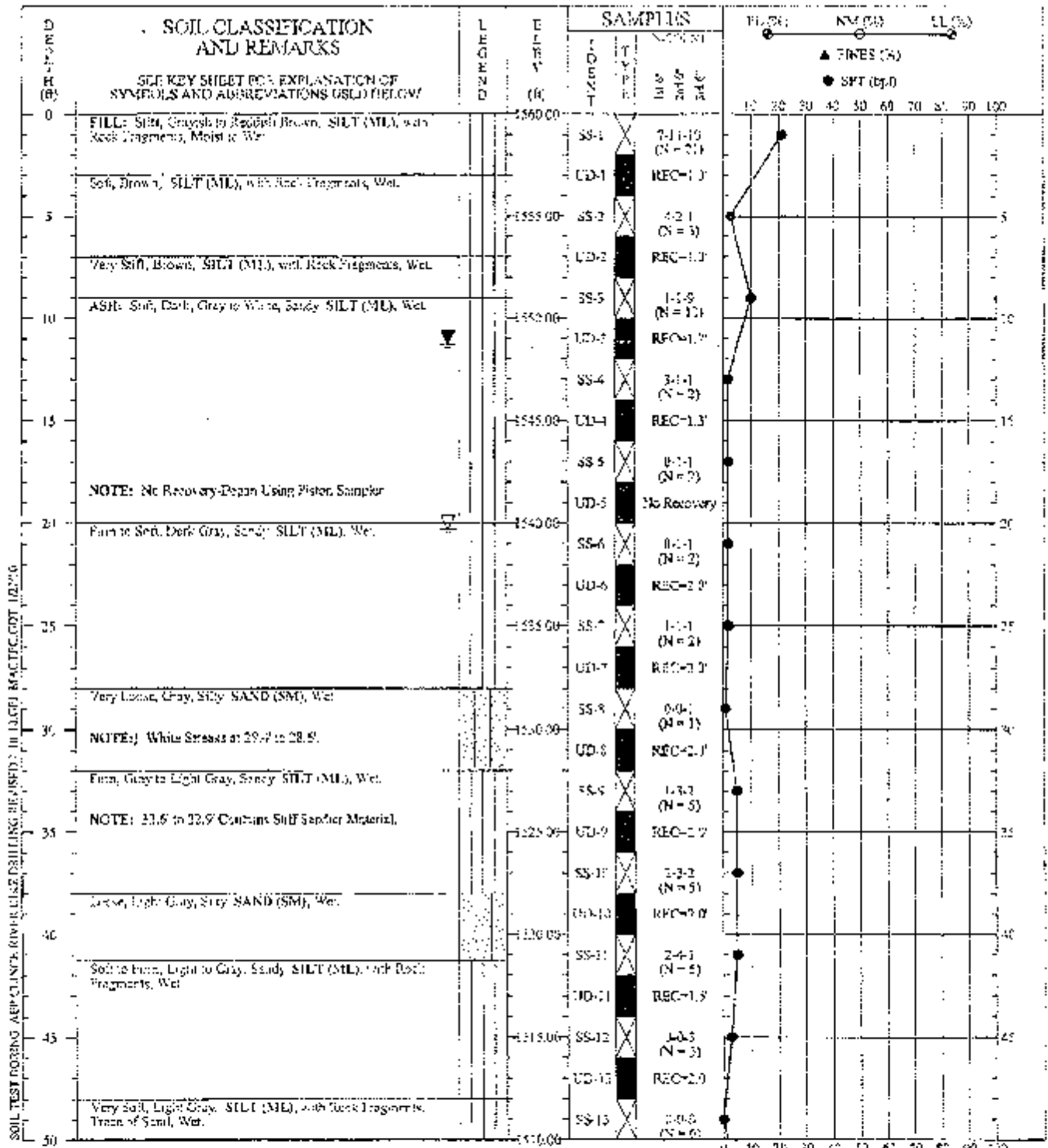

DRILLER: Tri-State Drilling  
 EQUIPMENT: CME 75 Truck Rig  
 METHOD: 3.25" HSA  
 NORTHING: 352219.29  
 EASTING: 10403292.98  
 LOGGED BY: Jon McDaniel  
 CHECKED BY: Ryan Restivo *ZDR*

| SOIL TEST BORING RECORD |                                |
|-------------------------|--------------------------------|
| BORING NO.:             | B-0903                         |
| PROJECT:                | AEP Church River Dike Drilling |
| LOCATION:               | Carbo, Virginia                |
| DRILLED:                | August 31, 2009                |
| PROJECT NO.:            | 3050-09-0131                   |
| PAGE 1 OF 2             |                                |
|                         |                                |

THIS RECORD IS A REASONABLE INTERPRETATION OF SUBSURFACE CONDITIONS AT THE EXPLORATION LOCATION. SUBSURFACE CONDITIONS AT OTHER LOCATIONS AND AT OTHER TIMES MAY DIFFER. INTERFACES BETWEEN STRATA ARE APPROXIMATE. TRANSITIONS BETWEEN STRATA MAY BE GRADUAL.

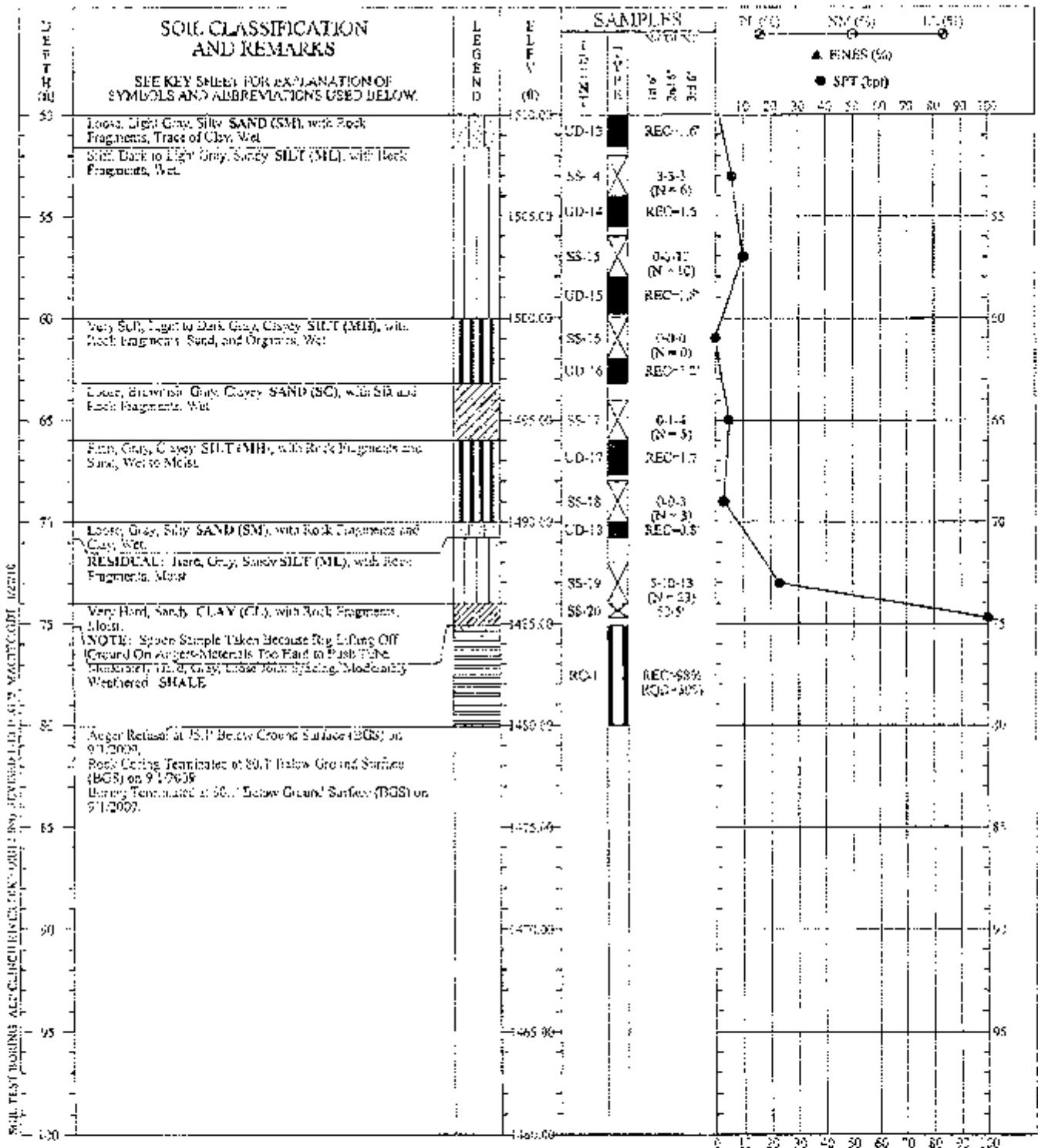

DRILLER: Tri-State Drilling  
 EQUIPMENT: CME 75 Truck Rig  
 METHOD: 1.2" HSA  
 NORTHING: 3523219.29  
 EASTING: 1943322.98  
 LOGGED BY: Jon McDaniel  
 CHECKED BY: Ryan Rosinski *ROR*

| SOIL TEST BORING RECORD |                                |
|-------------------------|--------------------------------|
| BORING NO.:             | B-3903                         |
| PROJECT:                | AEP Clinch River Dike Drilling |
| LOCATION:               | Carbo, Virginia                |
| DRILLED:                | August 31, 2009                |
| PROJECT NO.:            | 3050-09-0131                   |
| PAGE 2 OF 2             |                                |
|                         |                                |

THIS RECORD IS A REASONABLE INTERPRETATION OF SUBSURFACE CONDITIONS AT THE EXPLORATION LOCATION. SUBSURFACE CONDITIONS AT OTHER LOCATIONS AND AT OTHER TIMES MAY DIFFER. INTERFACES BETWEEN STRATA ARE APPROXIMATE. TRANSITIONS BETWEEN STRATA MAY BE GRADUAL.

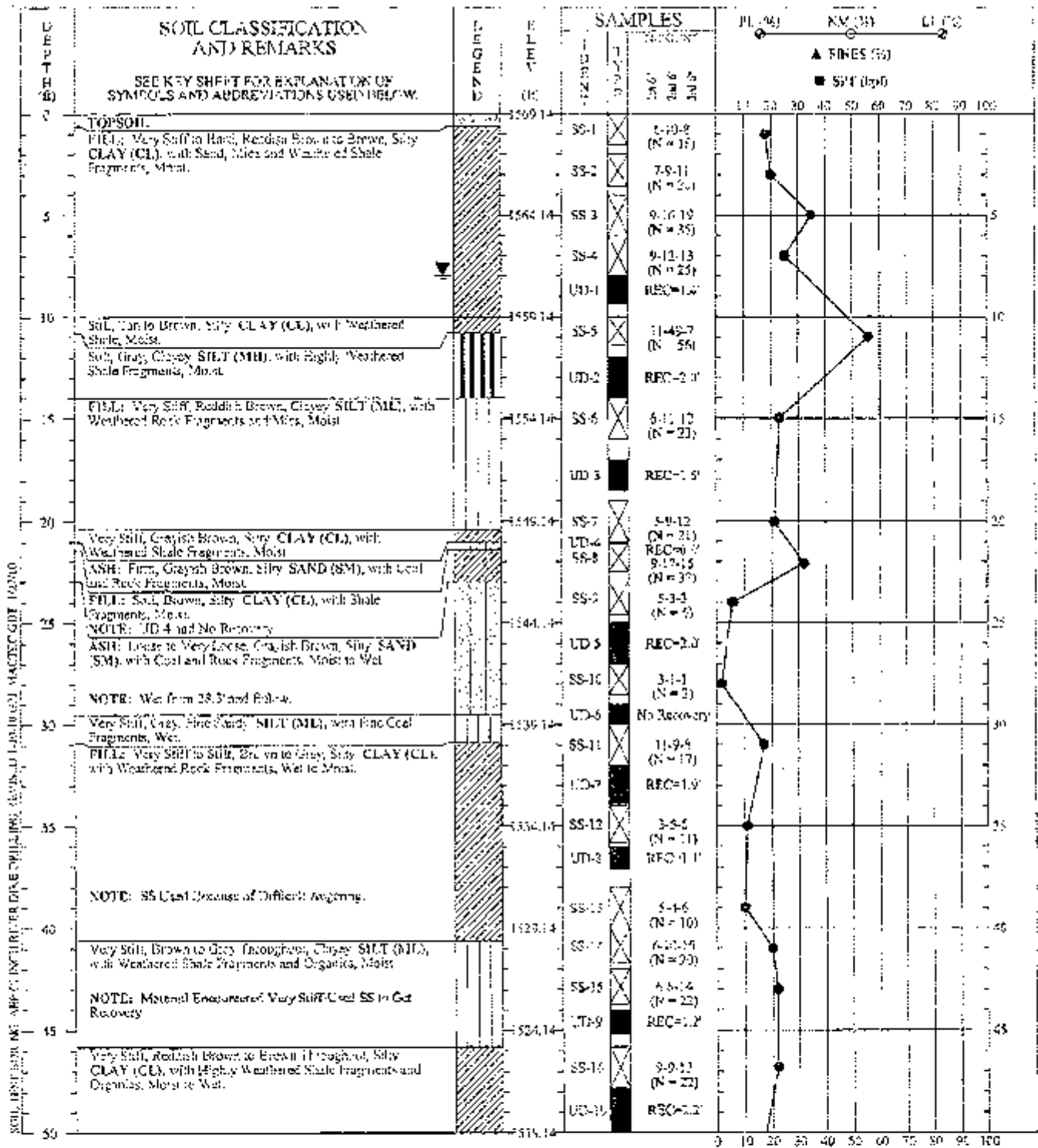

DRILLER: In-State Drilling  
EQUIPMENT: CMR 75 Trac Rig  
METHOD: 3.25" HSA  
NO. BING: 3570130379  
EASTING: 1040322.416  
LOGGED BY: Jen McDaniel  
CHECKED BY: Ryan Rustake RDR

**SOIL TEST BORING RECORD**

BORING NO.: H-0954  
PROJECT: AEP Clinch River Dike Drilling  
LOCATION: Carbo, Virginia  
DRILLED: September 16, 2009  
PROJECT NO.: 3050-09-0131

PAGE 1 OF 2



THIS RECORD IS A REASONABLE INTERPRETATION OF SUBSURFACE CONDITIONS AT THE EXPLORATION LOCATION. SUBSURFACE CONDITIONS AT OTHER LOCATIONS AND AT OTHER TIMES MAY DIFFER. INTERACTIONS BETWEEN STRATA ARE APPROXIMATE. TRANSITIONS BETWEEN STRATA MAY BE GRADUAL.



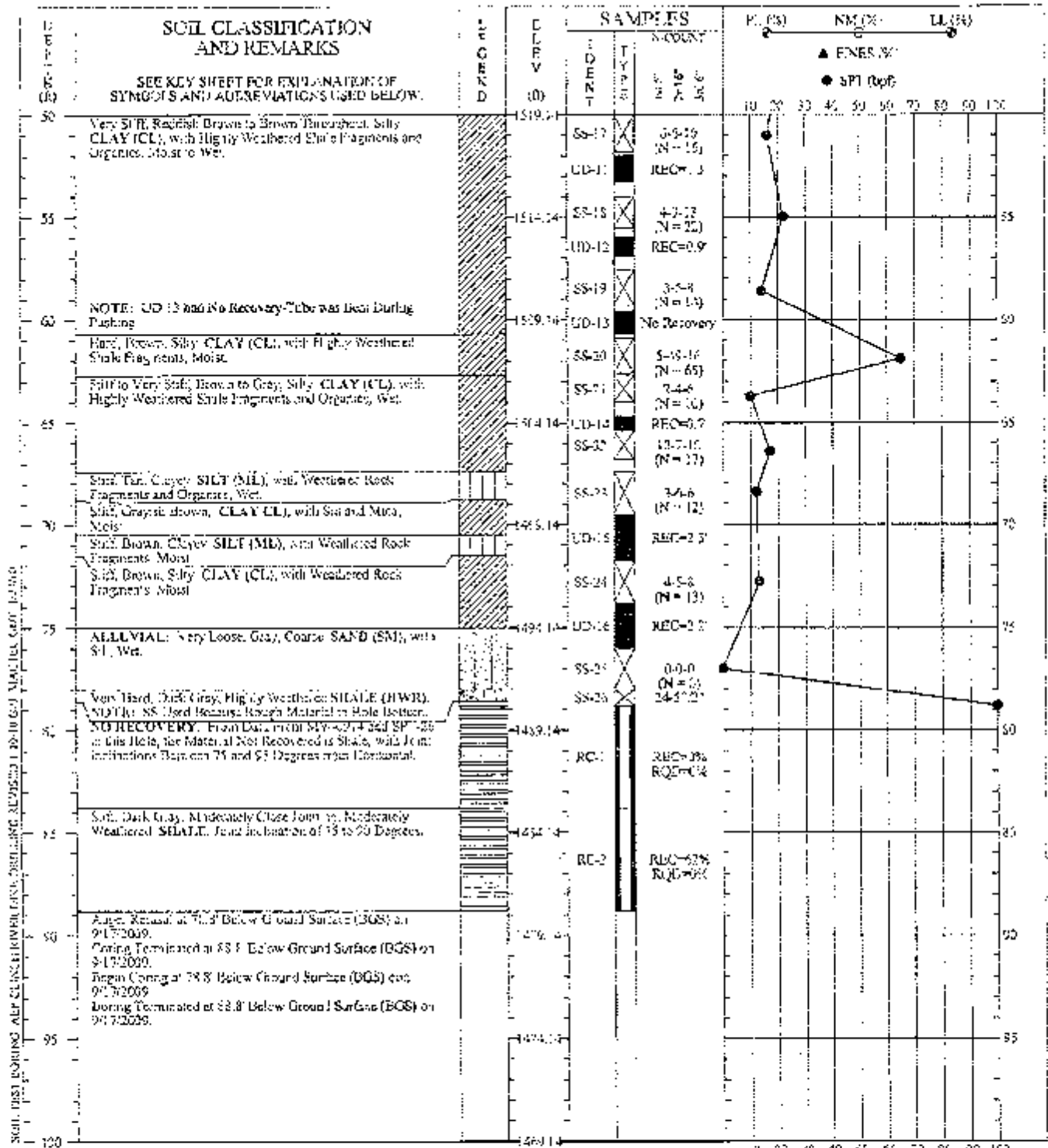

DRILLER: Tri-State Drilling  
 EQUIPMENT: CMR 75 Back Rig  
 METHOD: 3.25" HSA  
 BORING: 353211-379  
 EASTING: 1040332.815  
 LOGGED BY: Joe McDermid  
 CHECKED BY: Ryan Rasmussen *RDR*

**SOIL TEST BORING RECORD**

**BORING NO.:** 3-0904  
**PROJECT:** AEP Clinch River Dike Drilling  
**LOCATION:** Carlin, Virginia  
**DRILLED:** September 16, 2009  
**PROJECT NO.:** 3050-09-0131

PAGE 2 OF 2

MACTEC

THIS REPORT IS A PUBLIC DOCUMENT AND IS THE PROPERTY OF MACTEC. IT IS TO BE USED ONLY FOR THE PROJECT AND LOCATION SPECIFICALLY IDENTIFIED HEREIN. IT IS NOT TO BE REPRODUCED, COPIED, OR TRANSMITTED IN ANY FORM OR BY ANY MEANS, ELECTRONIC OR MECHANICAL, INCLUDING PHOTOCOPYING, RECORDING, OR BY ANY INFORMATION STORAGE AND RETRIEVAL SYSTEM, WITHOUT THE WRITTEN PERMISSION OF MACTEC.

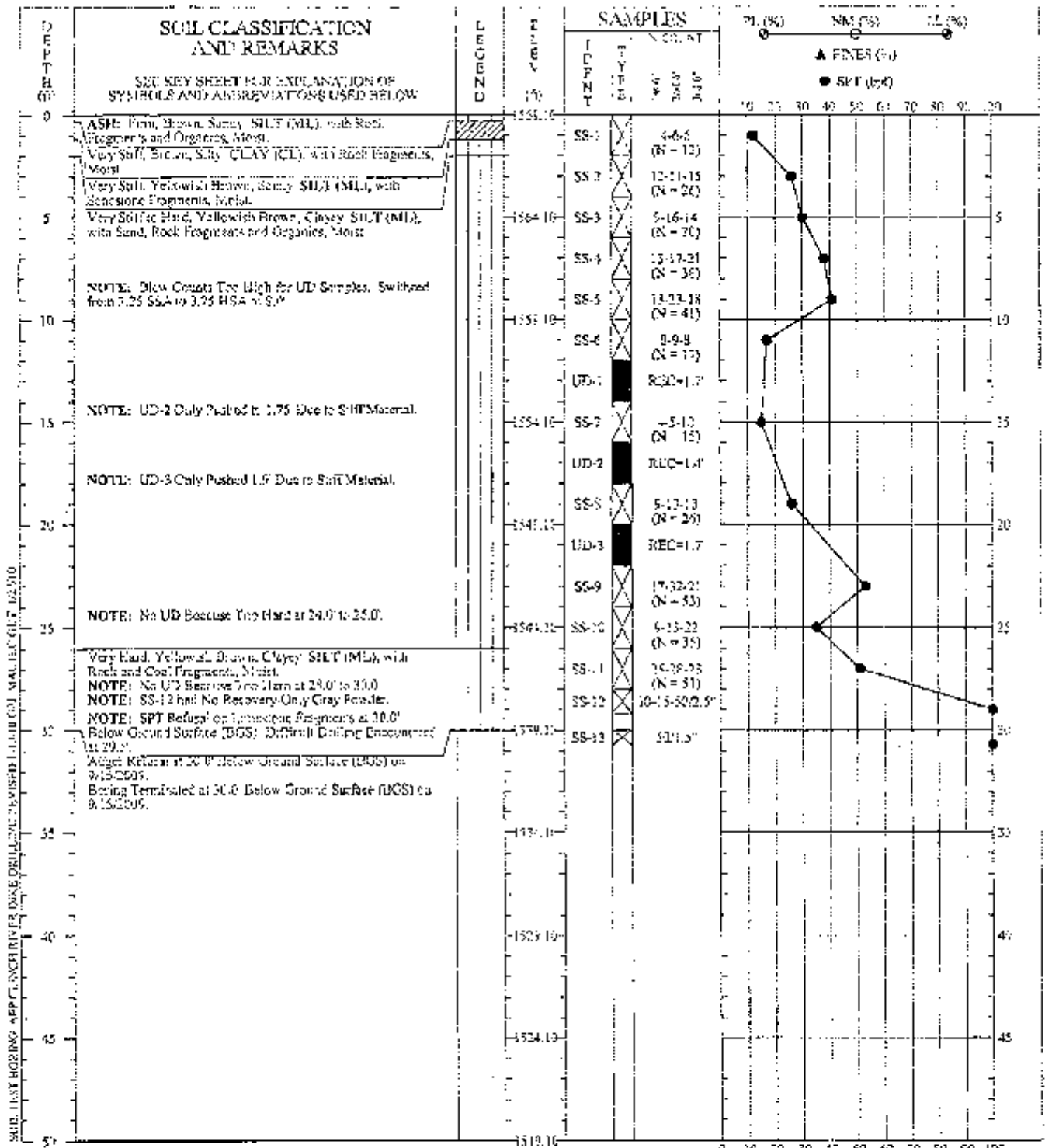

DRILLER: Tri-State Drilling  
 EQUIPMENT: C-400 550X Truck Bore  
 METHOD: 2.25" SSA 0.0 to 5.0' 3.25" HSA 5.0' to 30.0'  
 NOISE/HEAVY: 3522131.779  
 TESTING: 10425552.618  
 LOGGED BY: Nick Smith  
 CHECKED BY: Ryan Ruzsike *RDR*

| SOIL TEST BORING RECORD |                                |
|-------------------------|--------------------------------|
| BORING NO.:             | P-0905                         |
| PROJECT:                | AEP Clinch River Dike Drilling |
| LOCATION:               | Carbo, Virginia                |
| DRILLED:                | September 14, 2009             |
| PROJECT NO.:            | 3050-09-0131                   |
| PAGE 1 OF 1             |                                |
|                         |                                |

THIS RECORD IS A REASONABLE INTERPRETATION OF SUBSURFACE CONDITIONS AT THE EXPLORATION LOCATION. SUBSURFACE CONDITIONS AT OTHER LOCATIONS AND AT OTHER TIMES MAY DIFFER. INTERFACES BETWEEN STRATA ARE APPROXIMATE. TRANSITIONS BETWEEN STRATA MAY BE GRADUAL.

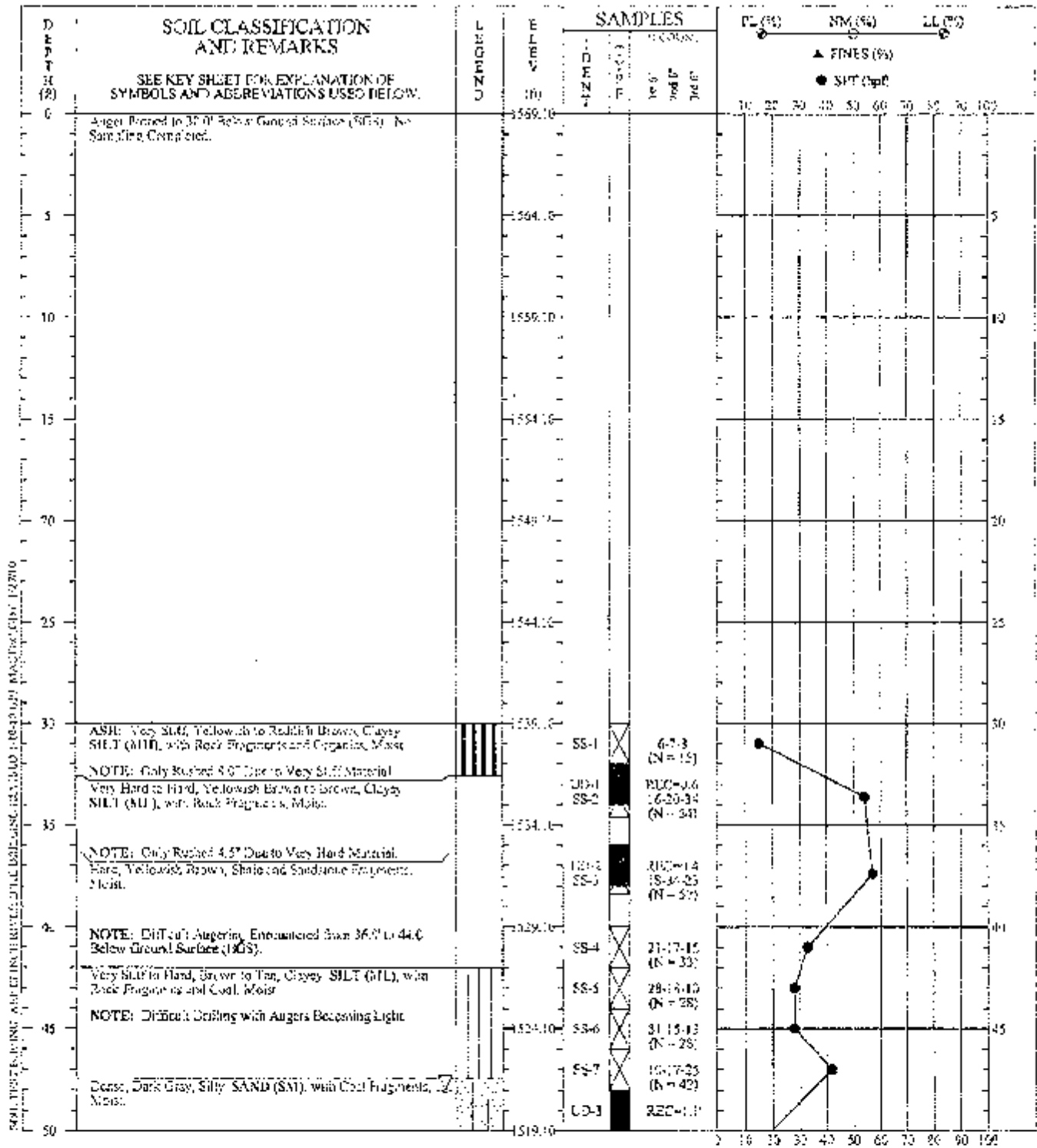

DRILLER: Tri-Site Drilling  
EQUIPMENT: CME 350X Truck Rig  
METHOD: 2.75" SSA 0.0 to 0.7" 3.25" HSA 1.0 to 2.0"  
NORTHING: 352130.319  
EASTING: 1040330.318  
LOGGED BY: Nick Smith  
CHECKED BY: Ryan Ruzicka *RDR*

**SOIL TEST BORING RECORD**

BORING NO.: B-0905A  
PROJECT: AEP Clinch River Dike Drilling  
LOCATION: Carbo, Virginia  
DRILLED: September 22, 2009  
PROJECT NO.: 3050-09-0131

PAGE 1 OF 2

THIS RECORD IS A REASONABLE INTERPRETATION OF SUBSURFACE CONDITIONS AT THE EXPLORATION LOCATION. SUBSURFACE CONDITIONS AT OTHER LOCATIONS AND AT OTHER TIMES MAY DIFFER. INTERFACES BETWEEN STRATA ARE APPROXIMATE. TRANSITIONS BETWEEN STRATA MAY BE GRADUAL.



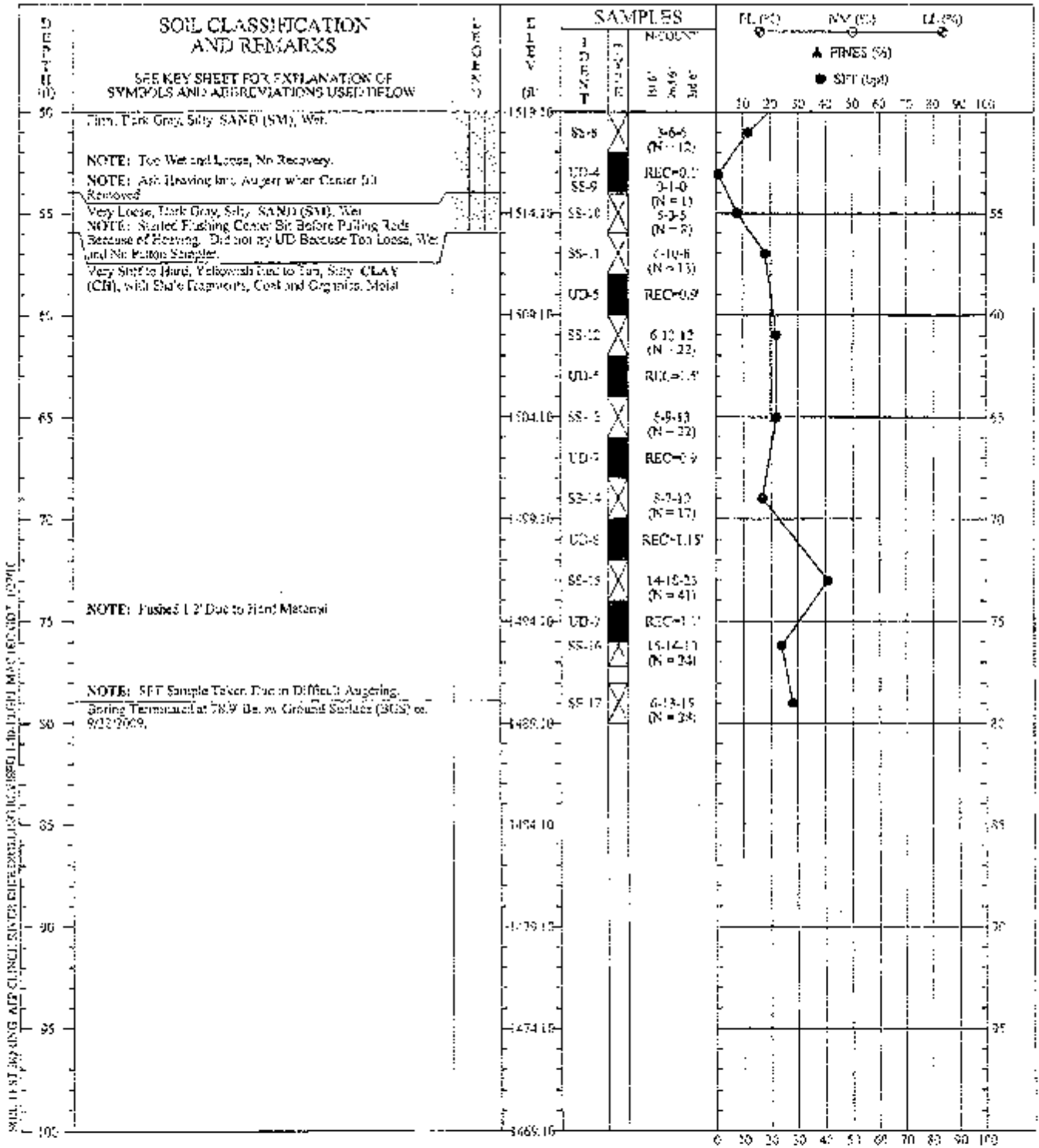

DRILLER: Tri State Drilling  
 EQUIPMENT: CME 550X Truck Rig  
 METHOD: 2.25" SSA 6.0' to 9.0' 3.25" HSA 6.0' to 80.0'  
 NORTHING: 3523112.373  
 EASTING: 1940322.515  
 LOGGED BY: Rick Smith  
 CHECKED BY: Ryan Resnick *RDR*

**SOIL TEST BORING RECORD**

**BORING NO.:** B-0905A  
**PROJECT:** AEP Clinch River Dike Drilling  
**LOCATION:** Carbo, Virginia  
**DRILLED:** September 22, 2009  
**PROJECT NO.:** 3659-09-0132

PAGE 2 OF 2

THIS RECORD IS A REASONABLE INTERPRETATION OF SUBSURFACE CONDITIONS AT THE EXPLORATION LOCATION. SUBSURFACE CONDITIONS AT OTHER LOCATIONS AND AT OTHER TIMES MAY DIFFER. INTERFACES BETWEEN STRATA ARE APPROXIMATE. TRANSITIONS BETWEEN STRATA MAY BE GRADUAL.

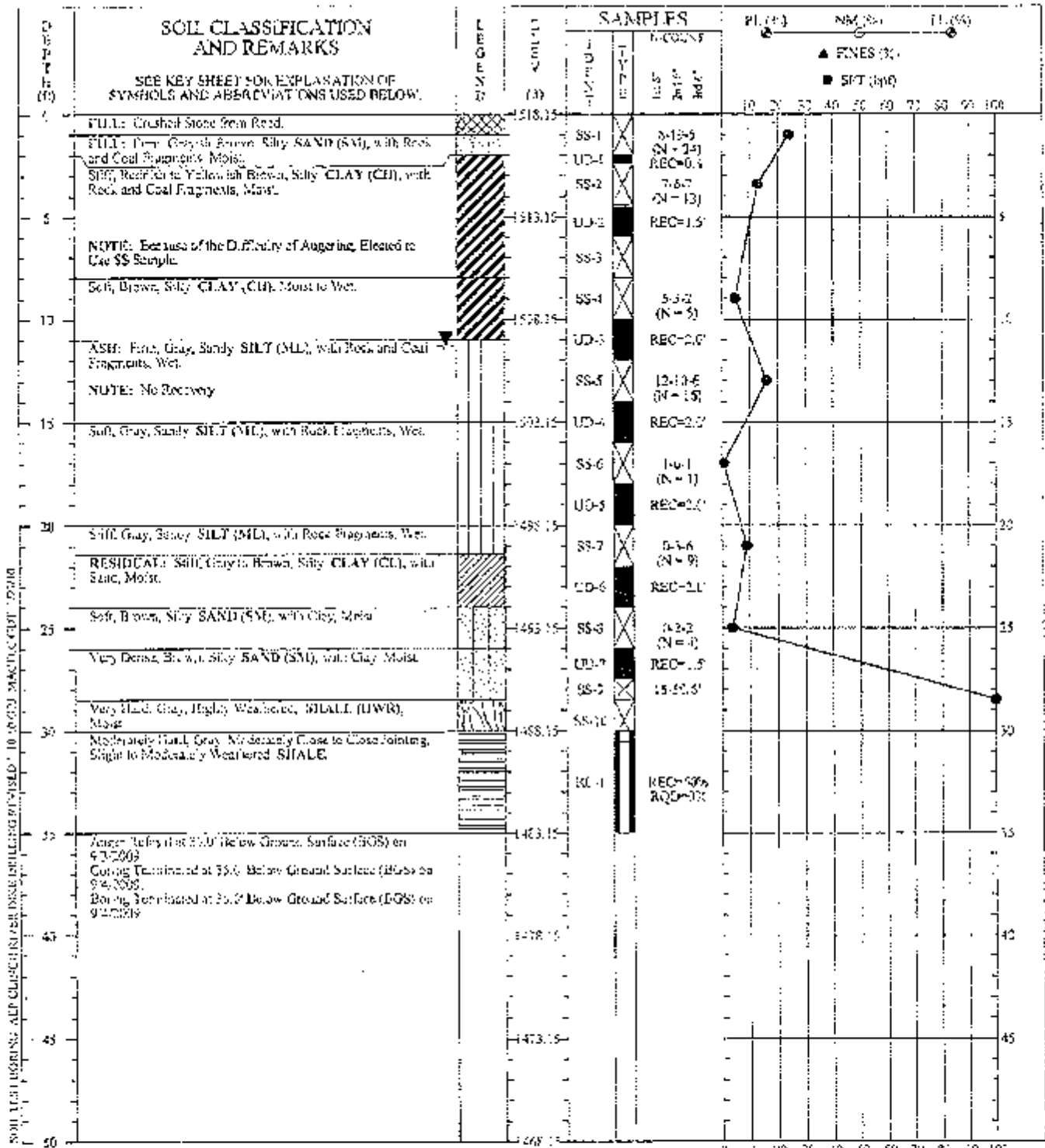

DRILLER: Tri-State Drilling  
EQUIPMENT: OME 75 Truck Rig  
METHOD: 3 3/8 HSA  
NORTHING: 5525+33957  
EASTING: 10423014 543  
LOGGED BY: Jon McDaniel  
CHECKED BY: Ryan Ruzsako *RJR*

THIS REPORT IS A SUMMARY OF THE INFORMATION SUBMITTED TO MACTEC BY THE CLIENT AND IS NOT A GUARANTEE OF ACCURACY. MACTEC SHALL NOT BE RESPONSIBLE FOR ANY ERRORS OR OMISSIONS IN THIS REPORT. THE CLIENT SHALL BE RESPONSIBLE FOR OBTAINING NECESSARY PERMITS AND APPROVALS. MACTEC SHALL NOT BE RESPONSIBLE FOR ANY DELAYS OR DISRUPTIONS IN THE WORK DUE TO CLIENT ACTIONS. MACTEC SHALL NOT BE RESPONSIBLE FOR ANY DAMAGE TO PROPERTY OR PERSONS DURING THE WORK. MACTEC SHALL NOT BE RESPONSIBLE FOR ANY INADEQUACIES IN THE DATA PROVIDED BY THE CLIENT.



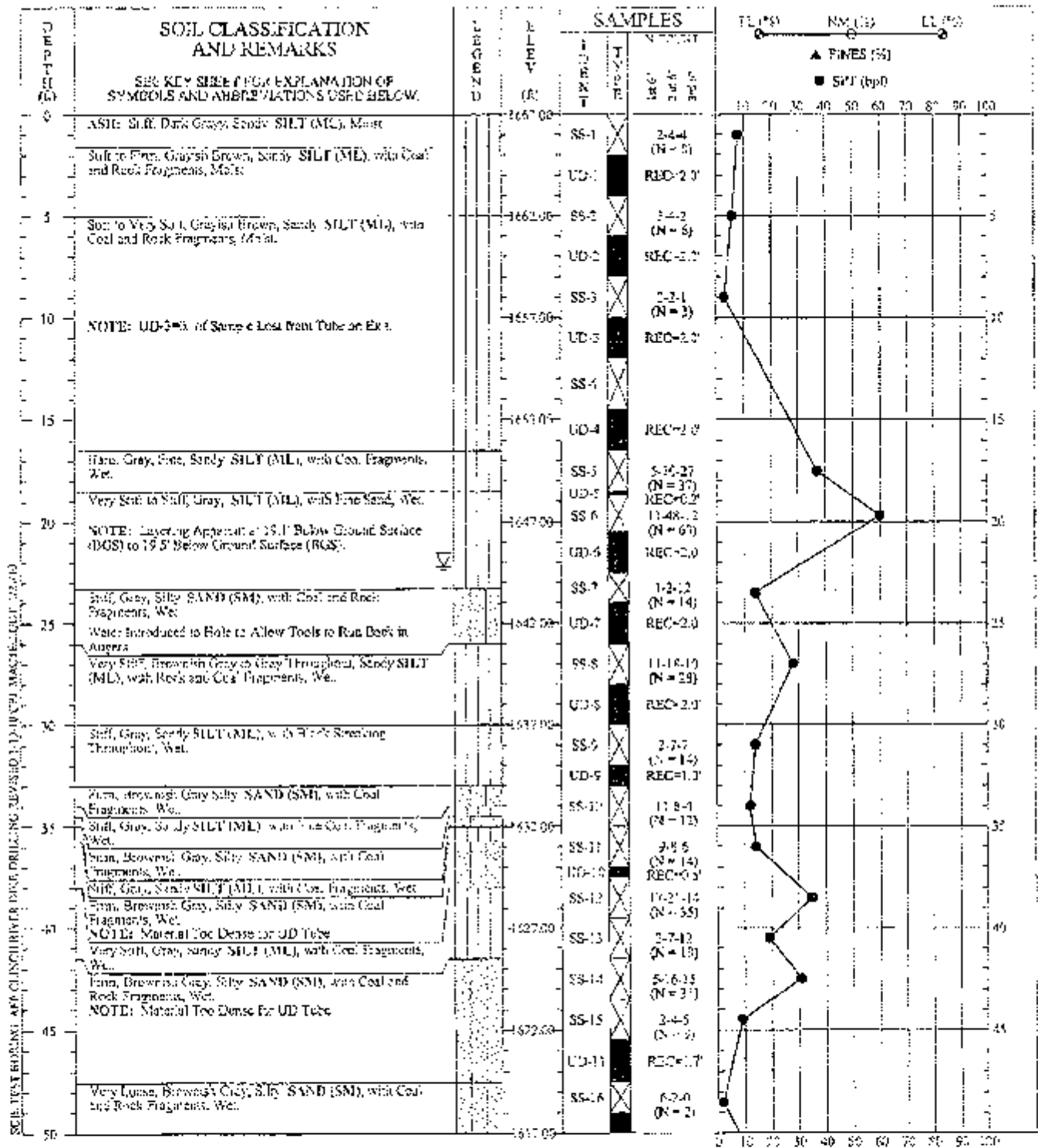

DRILLER: Tri-Blade Drilling  
 EQUIPMENT: CME 75 Truck Rig  
 METHOD: 3.25" ASA  
 NORTHING: 352,561.16  
 EASTING: 10442679.31  
 LOGGED BY: Jen McDowell  
 CHECKED BY: Ryan Rasmussen *RDR*

| SOIL TEST BORING RECORD |                               |
|-------------------------|-------------------------------|
| BORING NO.:             | H-09-7                        |
| PROJECT:                | AEP Clack River Dike Drilling |
| LOCATION:               | Calbe, Virginia               |
| DRILLED:                | September 15, 2009            |
| PROJECT NO.:            | 3050-09-0133                  |
| PAGE 1 OF 2             |                               |
|                         |                               |

THIS RECORD IS A CLASSIFIED INSTRUMENTATION OF  
 SUBSURFACE CONDITIONS AT THE LOCATION  
 LOCATION. BUREAU OF RECONSTRUCTION (BOR) IS  
 NOT RESPONSIBLE FOR THE ACCURACY OF THE  
 INFORMATION REPORTED HEREIN. THE INFORMATION  
 REPORTED HEREIN IS FOR INFORMATIONAL PURPOSES  
 ONLY. THE INFORMATION REPORTED HEREIN IS NOT  
 TO BE USED FOR ANY OTHER PURPOSE.

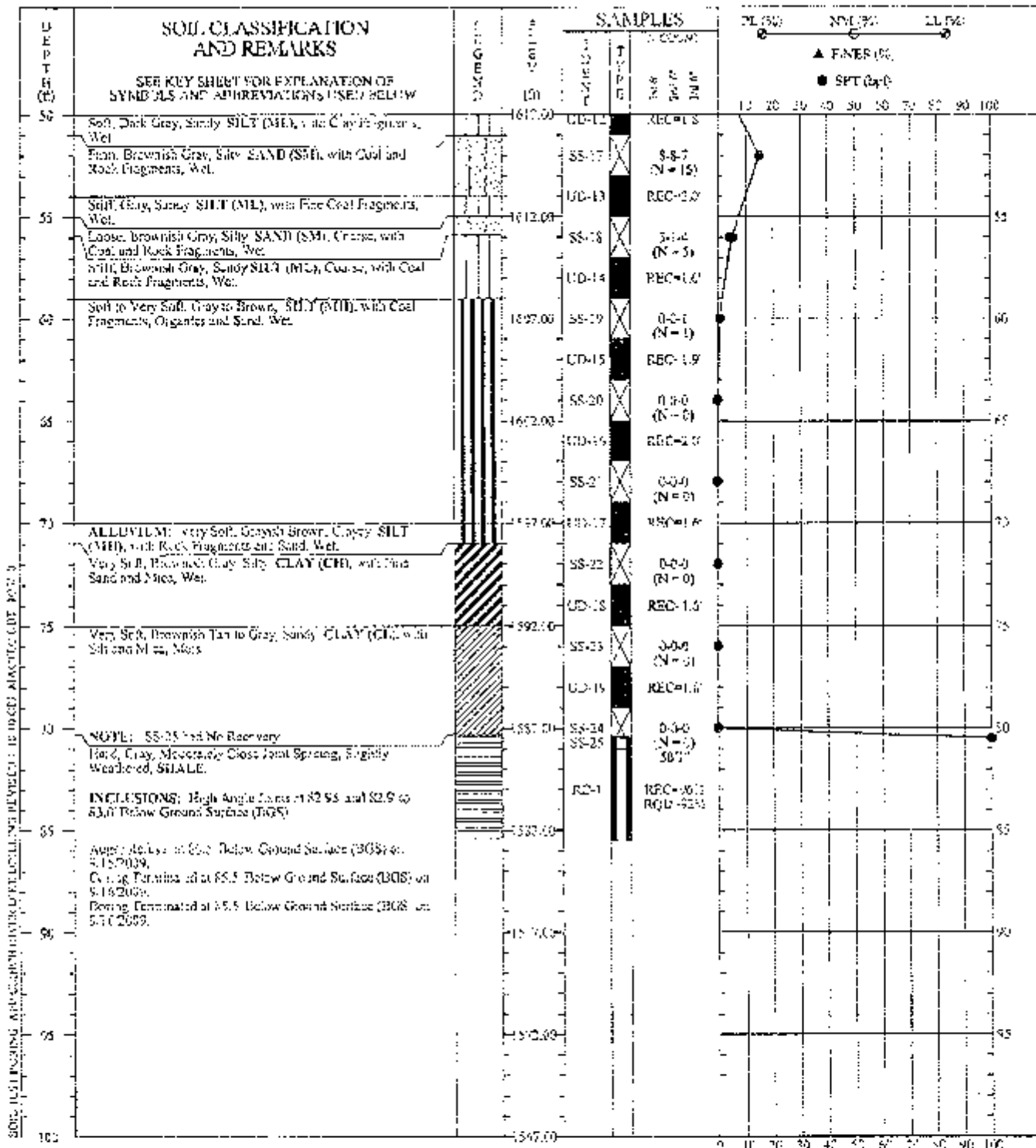

DRILLER: Tri-Scan Drilling  
 EQUIPMENT: CME 75 Truck Rig  
 METHOD: 1.25" HSA  
 NORTHING: 1521591.16  
 EASTING: 1041257.31  
 LOGGED BY: Joe McDaniel  
 CHECKED BY: Ryan Rasmussen *RDR*

**SOIL TEST BORING RECORD**

**BORING NO.:** B-0907  
**PROJECT:** AEP Clinch River Dike Drilling  
**LOCATION:** Carbo, Virginia  
**DRILLED:** September 15, 2009  
**PROJECT NO.:** 3050-09-0131

PAGE 2 OF 2

**MACTEC**

THIS REPORT IS A REASONABLE INTERPRETATION OF SURFACE CONDITIONS AT THE EXPLORATION LOCATION. SUBSURFACE CONDITIONS AT OTHER LOCATIONS AND AT OTHER TIMES MAY DIFFER. INTERFACES BETWEEN STRATA ARE APPROXIMATE. TRANSITIONS BETWEEN STRATA MAY BE GRADUAL.

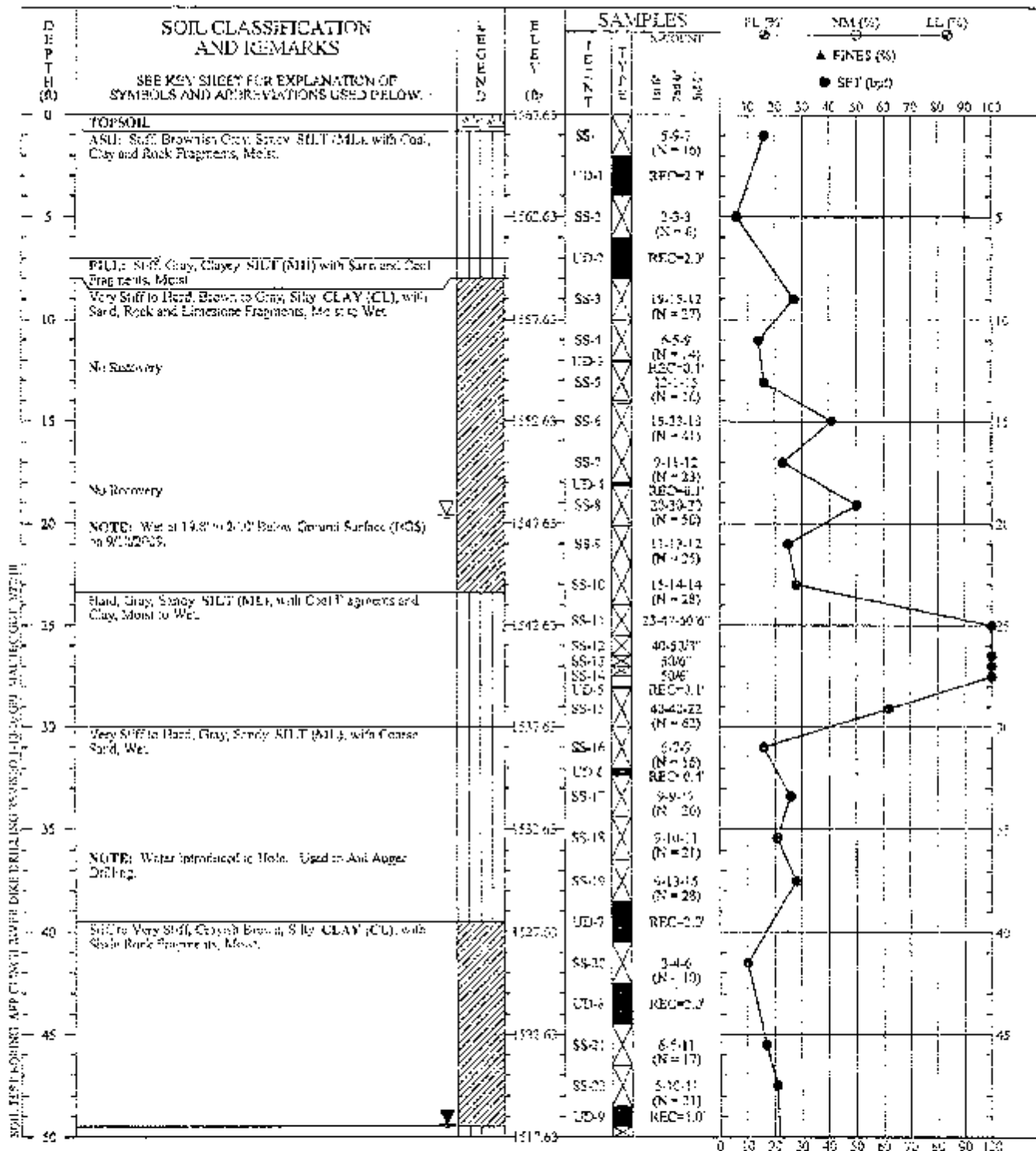

DRILLER: Tri-State Drilling  
 EQUIPMENT: CM6 75' Erickson  
 METHOD: 3.25' HSA  
 NORTHING: 3521467.07  
 EASTING: 1002559.02  
 LOGGED BY: Tom McDaniel  
 CHECKED BY: Ryan Rozema

| SOIL TEST BORING RECORD |                                |
|-------------------------|--------------------------------|
| BORING NO.:             | B-3908                         |
| PROJECT:                | AEP Clinch River Dike Drilling |
| LOCATION:               | Carbo, Virginia                |
| DRILLED:                | September 11, 2009             |
| PROJECT NO.:            | 3050 39 0121                   |
| PAGE 1 OF 2             |                                |
|                         |                                |

THIS RECORD IS A REASONABLE INTERPRETATION OF SUBSURFACE CONDITIONS AT THE EXPLORATION LOCATION. SUBSURFACE CONDITIONS AT OTHER LOCATIONS AND AT OTHER TIMES MAY DIFFER. INTERFACES BETWEEN STRATA ARE APPROXIMATE. TRANSITIONS BETWEEN STRATA MAY BE GRADUAL.



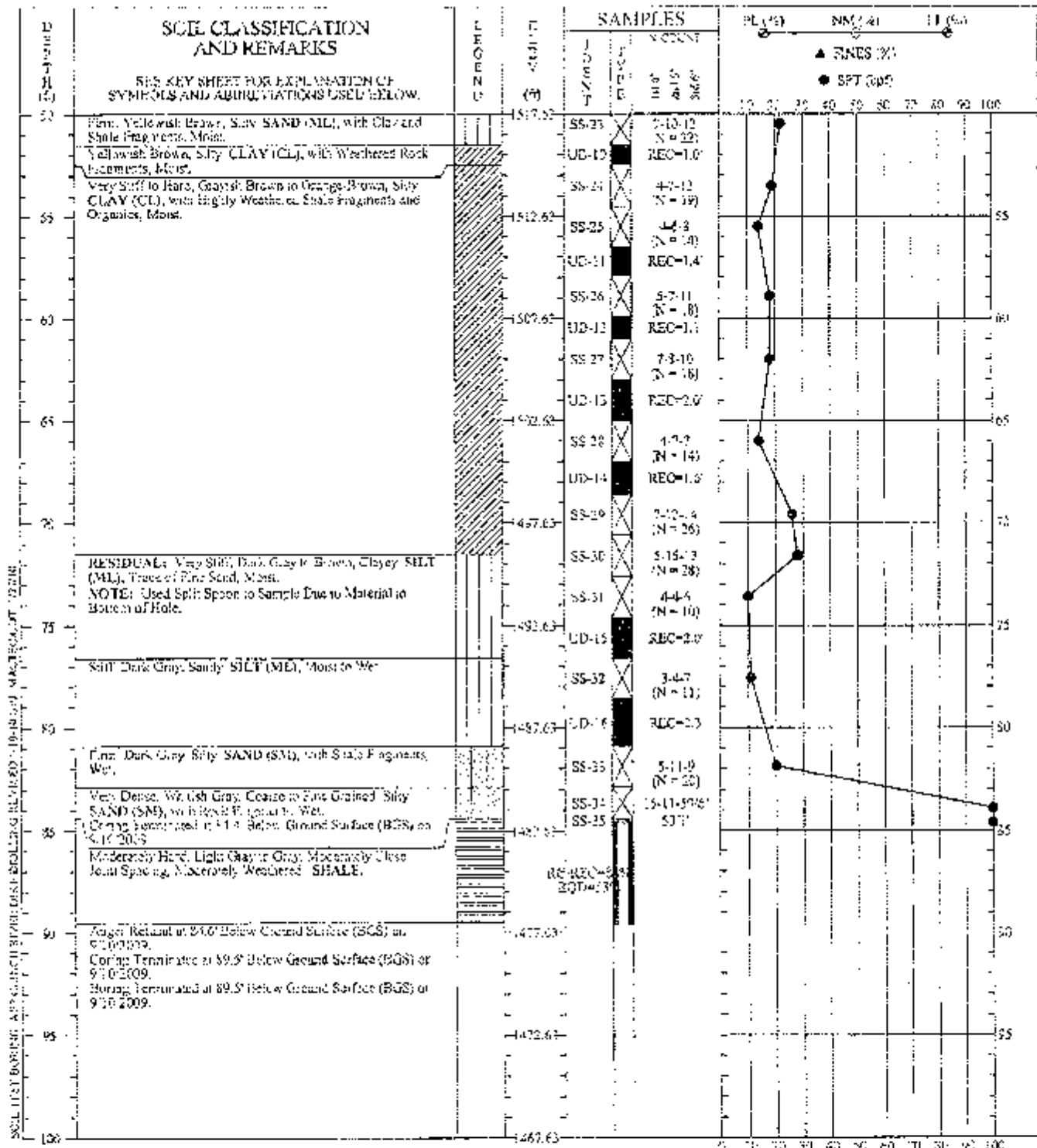

DRILLER: Uni-State Drilling  
 EQUIPMENT: CME 75 Truck Rig  
 METHOD: 3 1/2" HSA  
 NORTHING: 3521467 007  
 EASTING: 10442599 492  
 LOGGED BY: Jon McDaniel  
 CHECKED BY: Ryan Brasuke *RBR*

| SOIL TEST BORING RECORD |                                |
|-------------------------|--------------------------------|
| BORING NO.:             | B-3908                         |
| PROJECT:                | AEP Clinch River Dike Drilling |
| LOCATION:               | Carbo, Virginia                |
| DRILLED:                | September 11, 2009             |
| PROJECT NO.:            | 3050-09-0131                   |
| PAGE 2 OF 2             |                                |
|                         |                                |

THIS REPORT IS A PRELIMINARY REPORT AND SHOULD NOT BE USED FOR LEGAL OR FINANCIAL PURPOSES. THE DATA AND INFORMATION CONTAINED HEREIN ARE THE PROPERTY OF MACTEC AND SHOULD NOT BE REPRODUCED OR TRANSMITTED IN ANY FORM OR BY ANY MEANS, ELECTRONIC OR MECHANICAL, INCLUDING PHOTOCOPYING, RECORDING, OR BY ANY INFORMATION STORAGE AND RETRIEVAL SYSTEM. MACTEC SHALL NOT BE RESPONSIBLE FOR ANY ERRORS OR OMISSIONS.

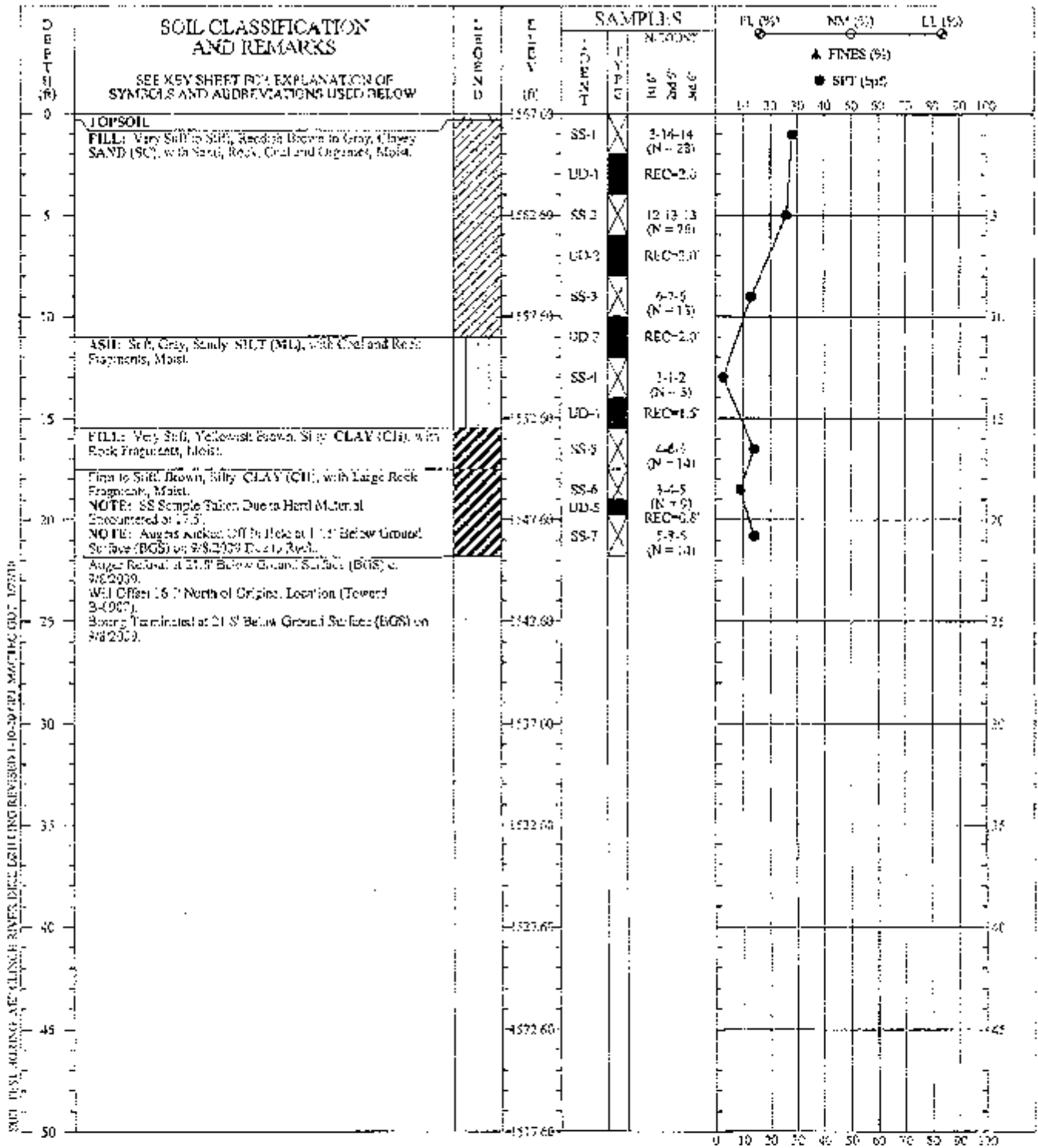

DRILLER: Tri-State Drilling  
 EQUIPMENT: CME 15' Truck Rig  
 METHOD: 2 3/4" HSA  
 NORTHING: 352,457.907  
 EASTING: 1040259.492  
 LOGGED BY: Jim McJannet  
 CHECKED BY: Ryan Tasmak *RDR*

| SOIL TEST BORING RECORD |                                |
|-------------------------|--------------------------------|
| <b>BORING NO.:</b>      | B-0908A                        |
| <b>PROJECT:</b>         | AEP Clinch River Dike Drilling |
| <b>LOCATION:</b>        | Carbo, Virginia                |
| <b>DRILLED:</b>         | September 8, 2009              |
| <b>PROJECT NO.:</b>     | 3050-09-0131                   |
| PAGE 1 OF 1             |                                |
|                         |                                |

THIS RECORD IS A MEANS OF INTERPRETING THE INFORMATION CONTAINED HEREIN. THE INFORMATION IS FOR INFORMATIONAL PURPOSES ONLY. NO WARRANTY IS MADE AS TO THE ACCURACY OF THE INFORMATION. THE INFORMATION IS NOT TO BE USED FOR ANY OTHER PURPOSES WITHOUT THE WRITTEN CONSENT OF MACTEC. MACTEC SHALL NOT BE RESPONSIBLE FOR ANY ERRORS OR OMISSIONS IN THIS REPORT.

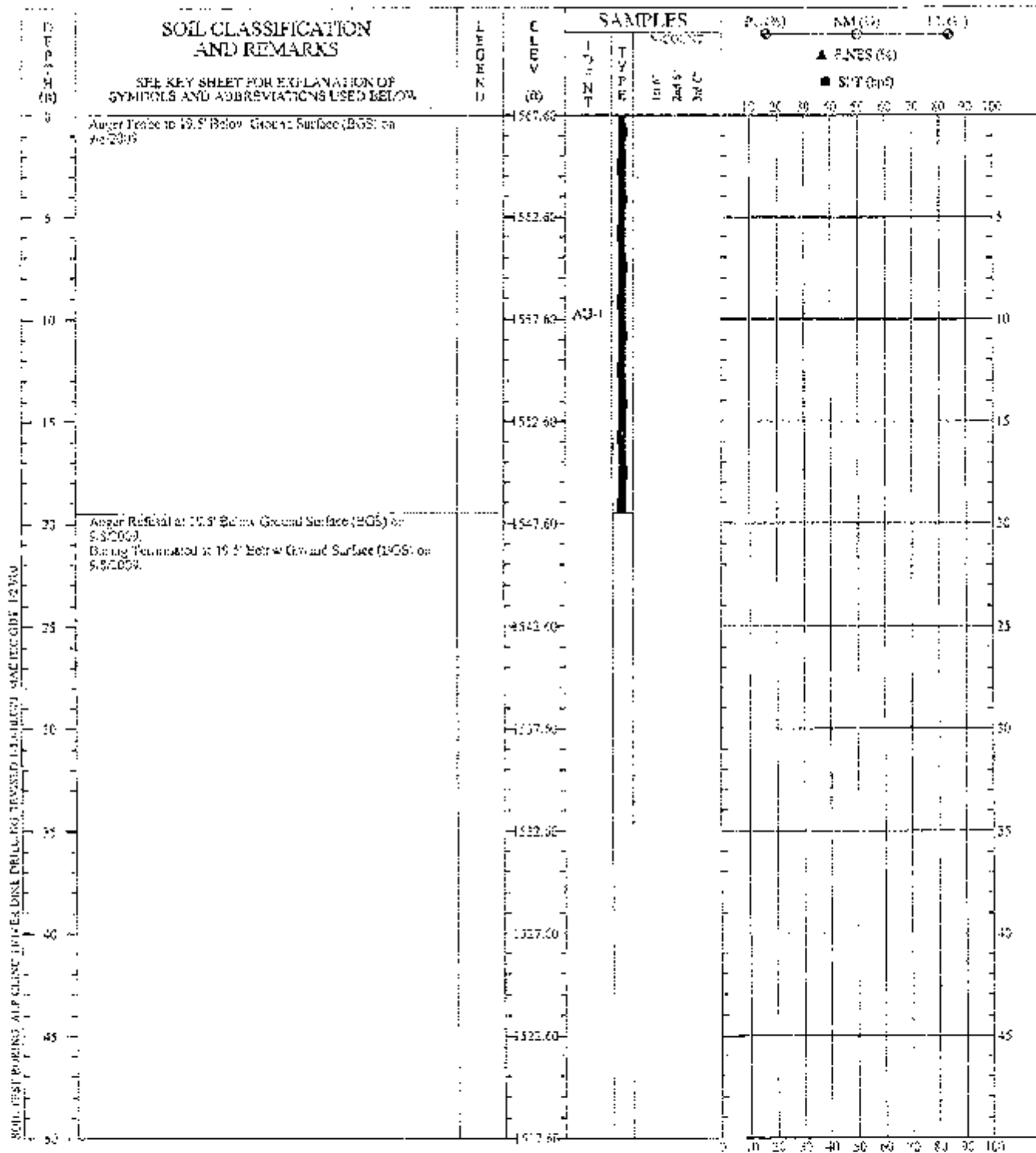

DRILLER: Tri-State Drilling  
 EQUIPMENT: CNS 75 Truck Log  
 METHOD: 1.25" HSA  
 WORKING NO.: 1521-457-201  
 EASTING: 10401566.492  
 LOGGED BY: Jon McDowell  
 CHECKED BY: Ryan Asanovic *RDR*

| SOIL TEST BORING RECORD |                                |
|-------------------------|--------------------------------|
| BORING NO.:             | D-0908B                        |
| PROJECT:                | AEP Clinch River Dike Drilling |
| LOCATION:               | Carbe, Virginia                |
| DRILLED:                | September 8, 2009              |
| PROJECT NO.:            | 3050-09-0131                   |
| PAGE 1 OF 1             |                                |
|                         |                                |

THIS RECORD IS A REASONABLE INTERPRETATION OF ALL DATA OBTAINED AT THE LOCATION INDICATED. SURFACE CONDITIONS AT THE TIME OF TESTING AND ALL OTHER DATA MAY VARY. ALL INTERFACES BETWEEN SURFACES ARE APPROXIMATE. TRANSFER OF STRESS BETWEEN SURFACES IS NOT GUARANTEED.

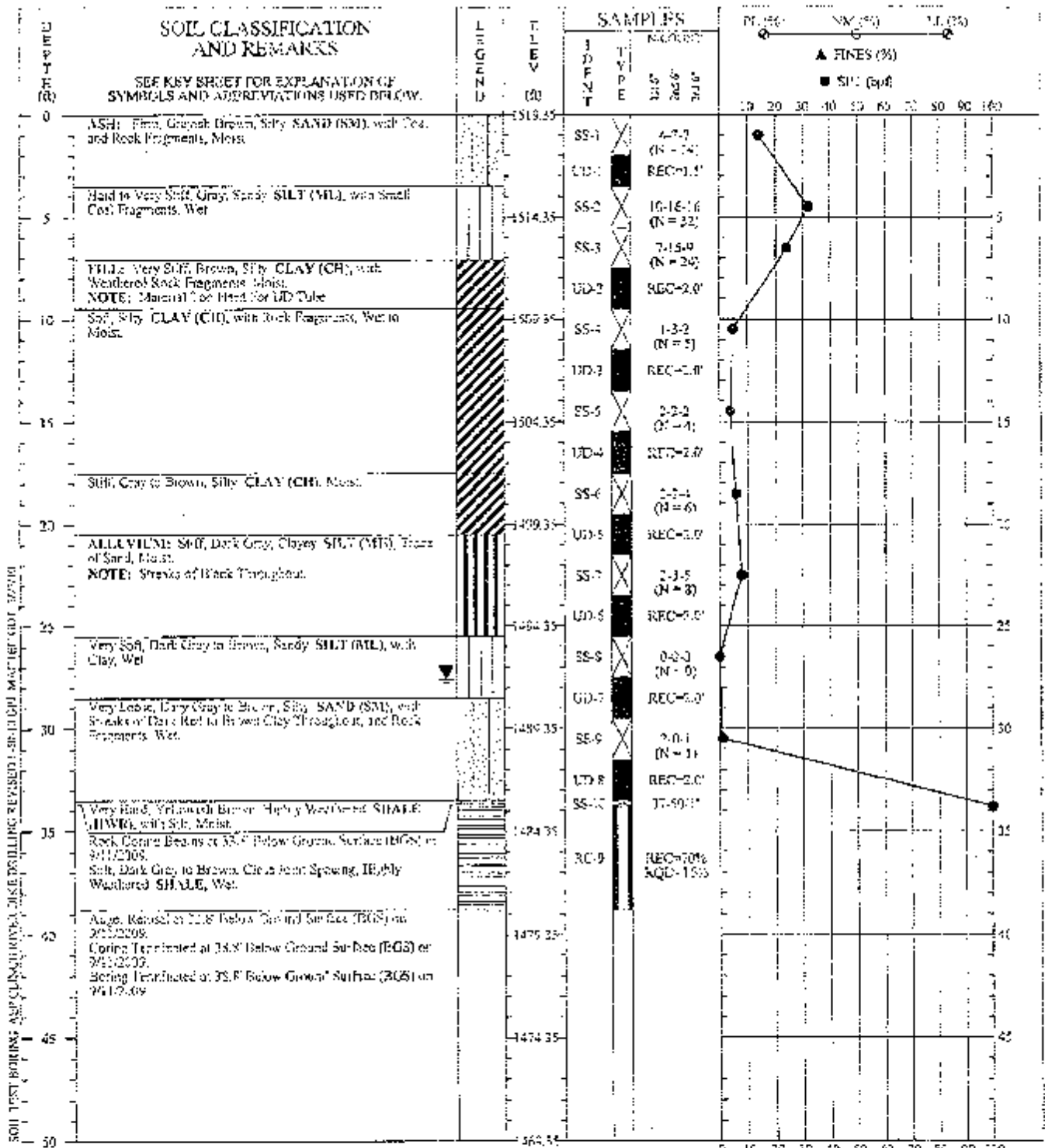

DRILLER: Tri-State Drilling  
 EQUIPMENT: CME 75 Truck Rig  
 METHOD: 2.25" HSA  
 NOODLING: 3521314.623  
 BASTING: 14922694.533  
 LOGGED BY: Jen McDaniel  
 CHECKED BY: Ryan Kaska: *RDR*

**SOIL TEST BORING RECORD**

BORING NO.: B-3909  
 PROJECT: AEP Clinch River Dike Drilling  
 LOCATION: Carbo, Virginia  
 DRILLED: September 11, 2009  
 PROJECT NO.: 3059-09-0131

PAGE 1 OF 1

THIS RECORD IS A REASONABLE INTERPRETATION OF SUBSURFACE CONDITIONS AT THE EXPLORATION LOCATION. SUBSURFACE CONDITIONS AT OTHER LOCATIONS AND AT OTHER TIMES MAY DIFFER. INTERFACES BETWEEN STRATA ARE APPROXIMATE. TRANSITIONS BETWEEN STRATA MAY BE GRADUAL.



APPENDIX C

PIEZOMETER INSTALLATION LOGS

MACTEC Engineering and Consulting, Inc.

BORING NO. **B-0901** SHEET **1 OF 2**  
 PROJECT **AEP Clinch River Dike Drilling**  
 LOCATION **Carbo, Virginia**  
 PROJECT NO **3050-09-0131**  
 LOGGED BY **Jon McDaniel** CHECKED BY **Ryan Rasnake**

A QUANTITY OF CORE AND WELL LOG COPY OF AEP CLINCH RIVER DIKE DRILLING PROVIDED TO ALL WELLS ON 1/29/10

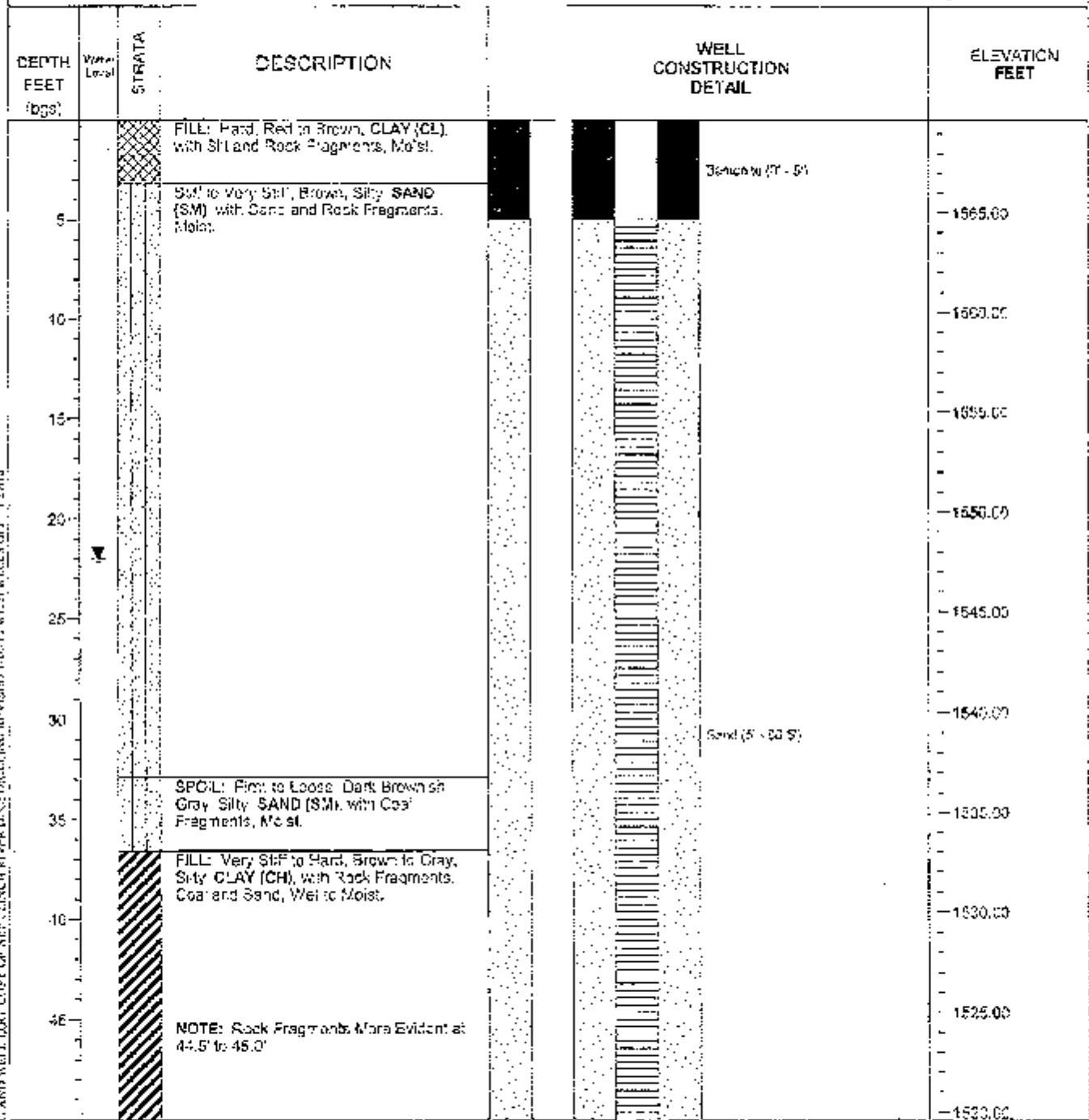

DRILLING CONTRACTOR **Tri-State Drilling**  
 DRILLING METHOD **3.25" HSA**  
 DRILLING EQUIPMENT **CME 75 Truck Rig**  
 DATE DRILLED **9/2/2009**

Northing: **3522486.902**  
 Easting: **10403707.203**

MACTEC Engineering and Consulting, Inc.

LOG NO. B-0901

SHEET 2 OF 2

PROJECT AEP Clinch River Dike Drilling

LOCATION Carbo, Virginia

PROJECT NO 3050-09-0131

LOGGED BY Jon McDaniel

CHECKED <sup>RDR</sup> Ryan Rasnake

ADMINISTRATIVE AND WELL LOG COPY OF AEP CLINCH RIVER DIKE BY LEUNG SERVICES FOR 40 WELLS (S1) - 2010

| DEPTH- FEET (logs) | Water Level | STRATA | DESCRIPTION  | WELL CONSTRUCTION DETAIL  |         |
|--------------------|-------------|--------|--|---------------------------|---------|
| 55                 |             |        | FILL: Very Stiff to Hard, Brown to Gray, Silty CLAY (CH), with Rock Fragments, Coal and Sand, Wet to Moist.  |                           | 1515.00 |
| 60                 |             |        | NOTE: 15 Gallons of Water Put in Hole at 56.0' below Ground Surface to Clean Augers Because Steel kept Getting Stuck in Hole and Augers won't Cut.<br>NOTE: Tube Refusal at 63'  |                           | 1510.00 |
| 65                 |             |        |  |                           | 1505.00 |
| 70                 |             |        | Stiff, Reddish Brown, Silty CLAY (CH), with Large Rock Fragments, Moist.<br>Firm, Light Gray to Brown Silty CLAY (CH), with Sand, Moist.   | Bentonite (66.9' - 71.5') | 1500.00 |
| 75                 |             |        | Soft, Brown, Sandy SILT (ML), with Clay, Moist.  |                           | 1455.00 |
|                    |             |        | Very Dense, Gray, Silty SAND (SM), with Rock Fragments, Wet.   | Sand (71.5' - 73.5')      |         |
| 90                 |             |        | Very Hard, Gray, Highly Weathered SHALE (HWR), Wet.<br>NOTE: Material Too Hard for a UD Tube.<br>Auger Refusal at 73.9' Below Ground Surface (BGS) on 9/2/2009.<br>Moderately Hard, Gray, Close Joint Spacing, Moderately Weathered SHALE.<br>Coring Terminated at 83.5' Below Ground Surface (BGS) on 9/2/2009.<br>Boring Terminated at 83.9' Below Ground Surface (BGS) on 9/2/2009. | Bentonite (70.3' - 83.5') | 1400.00 |

MACTEC Engineering and Consulting, Inc.

BORING NO. **B-0902** SHEET 1 OF 1  
 PROJECT **AEP Clinch River Dike Drilling**  
 LOCATION **Carbo, Virginia**  
 PROJECT NO. **3050-09-0131**  
 LOGGED BY **Jon McDaniel** CHECKED BY *RDR* **Ryan Rasnake**

| DEPTH FEET (bgs) | Water Level | STRATA | DESCRIPTION   | WELL CONSTRUCTION DETAIL | ELEVATION FEET |
|------------------|-------------|--------|---|--------------------------|----------------|
| 5                | ▼           |        | Crushed Stone<br>ASH: Very Soft, Grayish Brown, Sandy SILT (ML) with Coal and Rock Fragments, Moist to Wet.   | Bentonite (0' - 5')      | 1570.00        |
| 10               |             | K1     | Firm, Brownish Gray, Sandy SILT (ML) with Coal and Rock Fragments, Wet.<br>ALLUVIUM: Firm, Brownish Gray, Sandy SILT (ML), with Highly Weathered Rock Fragments, Trace of Clay, Wet.  |                          | 1505.00        |
| 15               |             |        | Very Soft, Gray, SILT (ML) with Sand and Sma. Rock Fragments, Wet.<br>NOTE: Last Spoon Blow Drove Spoon an Extra 0.5' in Soft Material.   | Sand (5' - 24')          | 1500.00        |
| 20               |             |        | Very Soft, Dark Brown to Black, Sandy SILT (ML) with Organics, Wet.<br>NOTE: Materials in Augers. Water Introduced to Gel Tools Back in Augers. Use Piston Sampler  |                          | 1425.00        |
|                  |             |        | Firm, Light Gray, Silty CLAY (CH) with Brown Water Staining Throughout and Root Fragments and Mica, Moist to Wet.   |                          |                |
|                  |             |        | Very Soft, Brown to Gray, Silty CLAY (CH) with Water Staining and Organics, Wet.  |                          |                |
|                  |             |        | Firm, Gray, Silty SAND (ML), Wet.<br>Very Hard, Gray, Highly Weathered SHALE (HWR), Moist   | Granite (24' - 29')      |                |
|                  |             |        | Soft, Gray, Moderately Close Joint Spacing, Moderately Weathered, SHALE, 0 to 20 Degree Joint Inclination.<br>Auger Refusal at 24.0' Below Ground Surface (BGS) on 9/14/2009.<br>Boring Terminated at 25.0' Below Ground Surface (BGS) on 9/14/2009.<br>Boring Terminated at 29.0' Below Ground Surface (BGS) on 9/14/2009. |                          |                |

DRILLING CONTRACTOR **Tri-State Drilling**  
 DRILLING METHOD **3.25" HSA**  
 DRILLING EQUIPMENT **CME 75 Truck Rig**  
 DATE DRILLED **9/14/2009**

Northing: **3522383.510**  
 Easting: **10493874.400**

ASB-0902-01-01 AND WELL LOG: COPY OF AEP CLINCH RIVER DIKE DRILLING REPORT FILE WITH RWB US-02-0000



MACTEC Engineering and Consulting, Inc.

BORING NO. **B-0904**  
 PROJECT **AEP Clinch River Dike Drilling**  
 LOCATION **Carbo, Virginia**  
 PROJECT NO. **3050-09-0131**  
 LOGGED BY **Jon McDaniel**

SHEET **1 OF 2**

CHECKED BY **Ryan Rasnake**

| DEPTH FEET (DGS) | STRATA | DESCRIPTION  | WELL CONSTRUCTION DETAIL | ELEVATION FEET |
|------------------|--------|--|--------------------------|----------------|
| 0                |        | <b>TOPSOIL</b><br>FILL: Very Stiff to Hard, Reddish Brown to Brown, Silty CLAY (CL), with Sand, Mica and Weathered Shale Fragments, Moist.   |                          | 1365.00        |
| 5                |        |  |                          | 1360.00        |
| 10               |        | Stiff, Tan to Brown, Silty CLAY (CL), with Weathered Shale, Moist.<br>Soft Gray, Clayey SILT (MH), with Highly Weathered Shale Fragments, Moist.   |                          | 1355.00        |
| 15               |        | FILL: Very Stiff, Reddish Brown, Clayey SILT (ML), with Weathered Rock Fragments and Mica, Moist.  |                          | 1350.00        |
| 20               |        |  |                          | 1345.00        |
| 25               |        | Very Stiff, Grayish Brown, Silty CLAY (CL), with Weathered Shale Fragments, Moist.<br>ASH: Firm, Grayish Brown, Silty SAND (SM), with Coal and Rock Fragments, Moist.  |                          | 1340.00        |
| 30               |        | FILL: Soft, Brown, Silty CLAY (CL) with Shale Fragments, Moist.<br>NOTE: UD 4 had No Recovery.<br>ASH: Loose to Very Loose, Grayish Brown, Silty SAND (SM), with Coal and Rock Fragments, Moist to Wet.<br>NOTE: Wet from 28.3' and Below. |                          | 1335.00        |
| 35               |        | Very Stiff, Gray, Fine Sandy SILT (ML), with Fine Coal Fragments, Wet.<br>FILL: Very Stiff to Soft, Brown to Gray, Silty CLAY (CL), with Weathered Rock Fragments, Wet to Moist.   |                          | 1330.00        |
| 40               |        | NOTE: SS Used Because of Difficult Augering.   |                          | 1325.00        |
| 45               |        | Very Stiff, Brown to Gray Throughout, Clayey SILT (ML), with Weathered Shale Fragments and Organics, Moist.<br>NOTE: Material Encountered Very Stiff-Used SS to Get Recovery   |                          | 1320.00        |
| 50               |        | Very Stiff, Reddish Brown to Brown Throughout, Silty CLAY (CL) with Highly Weathered Shale Fragments and Organics, Moist to Wet.   |                          | 1315.00        |

ARRANGED, BORED LOG AND WELL LOG. COPY OF AEP CLINCH RIVER DIKE DRILLING REVISED LOG TO WELL LOG, 200912

DRILLING CONTRACTOR **Tri-State Drilling**  
 DRILLING METHOD **3.25" HSA**  
 DRILLING EQUIPMENT **CME 75 Truck Rig**  
 DATE DRILLED **9/16/2009**

Northing: **3522130.379**  
 Easting: **10403332.818**

MACTEC Engineering and Consulting, Inc.

BORING NO. B-0904  
 PROJECT AEP Clinch River Dike Drilling  
 LOCATION Carbo, Virginia  
 PROJECT NO. 3050-09-0131  
 LOGGED BY Jon McDaniel

SHEET 2 OF 2

CHECKED BY <sup>RJR</sup> Ryan Rasnake

| DEPTH FEET (hgs) | SYMBOL | DESCRIPTION   | WELL CONSTRUCTION DETAIL |         |
|------------------|--------|---|--------------------------|---------|
| 35               |        | Very Stiff, Reddish Brown to Brown Throughout, Silty CLAY (CL), with Highly Weathered Shale Fragments and Organics, Moist to Wet.   |                          | 1515.00 |
| 60               |        | NOTE: UD 13 had No Recovery-Tube was Bent During Pushing.<br>Hard, Brown, Silty CLAY (CL), with Highly Weathered Shale Fragments, Moist.  |                          | 1510.00 |
| 65               |        | Stiff to Very Stiff, Brown to Gray, Silty CLAY (CL), with Highly Weathered Shale Fragments and Organics, Wet.   |                          | 1505.00 |
| 70               |        | Soft, Tan, Clayey SILT (ML), with Weathered Rock Fragments and Organics, Wet.   |                          | 1500.00 |
| 72               |        | Soft, Grayish Brown, CLAY (CL), with Silt and Mica, Moist.  |                          |         |
| 73               |        | Stiff, Brown, Clayey SILT (ML), with Weathered Rock Fragments, Moist.   |                          |         |
| 74               |        | Soft, Brown, Silty CLAY (CL), with Weathered Rock Fragments, Moist.   |                          | 1495.00 |
| 75               |        | ALLUVIAL: Very Loose, Gray, Coarse SAND (SM), with Silt, Wet.   |                          |         |
| 80               |        | Very Hard, Dark Gray, Highly Weathered SHALE (HWK).<br>NOTE: SS Used Because Rough Material in Hole Bottom.<br>NO RECOVERY: From Data From SW 0914 and SPT 36 in this Hole, the Material not Recovered is Shale, with Joint Inclinations Between 75 and 95 Degrees from Horizontal. |                          | 1490.00 |
| 85               |        | Soft, Dark Gray, Moderately Dense Jointing, Moderately Weathered SHALE. Joint Inclination of 75 to 90 Degrees.  | Perforate (75' - 89.0')  | 1485.00 |
|                  |        | Auger Refusal at 79.8' Below Ground Surface (BGS) on 8/17/2009.<br>Casing Terminated at 38.8' Below Ground Surface (BGS) on 6/17/2009.<br>Begin Casing at 78.8' Below Ground Surface (BGS) on 8/7/2009.<br>Boring Terminated at 85.8' Below Ground Surface (BGS) on 8/17/2009.      |                          |         |

ADDITIONS, DELETIONS, AND WELLS LOG COPY OF AEP CLINCH RIVER DIKE DRILLING (REVISED 1.16.10 WITH WELLS CITY) (17804)

MACTEC Engineering and Consulting, Inc.

BORING NO. B-0906

SHEET 1 OF 1

PROJECT AEP Clinch River Dike Drilling

LOCATION Carbo, Virginia

PROJECT NO. 3050-09-0131

LOGGED BY Jon McDaniel

CHECKED BY <sup>RDR</sup>Ryan Rasnake

ATTENTION BORING CONTRACTOR: PLEASE FILE ORIGINAL COPY OF MACTEC INFO RIVER DIKE DRILLING REVISION 1.0 WITH WELLS CT-10700

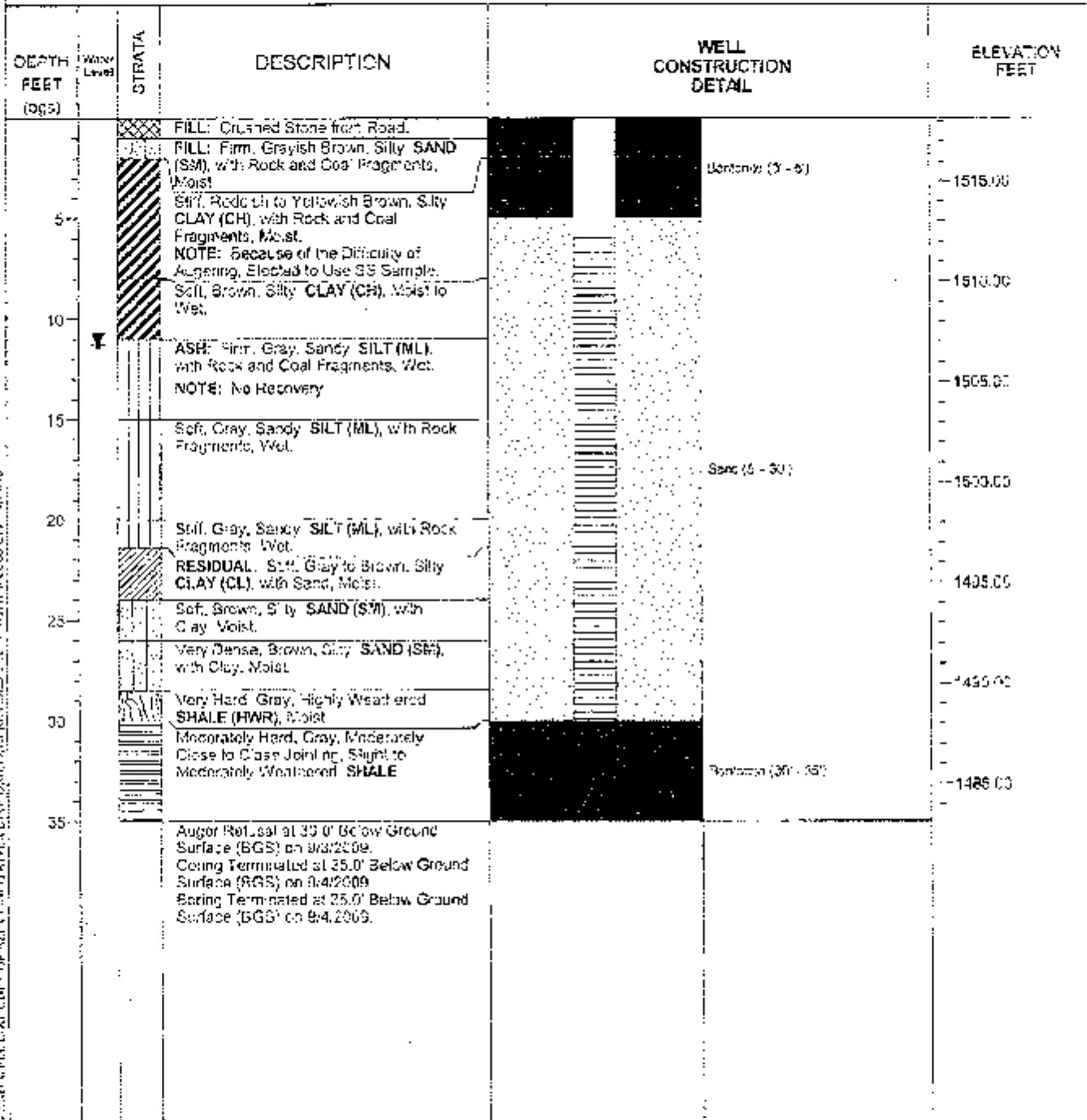

DRILLING CONTRACTOR: Tri-State Drilling  
 DRILLING METHOD: 3.25" HSA  
 DRILLING EQUIPMENT: CME 75 Truck Rig  
 DATE DRILLED: 9/3/2009

Northing: 3522030.937  
 Easting: 13403414.543

MACTEC Engineering and Consulting, Inc.

BORING NO. B-0908

SHEET 1 OF 2

PROJECT AEP Clinch River Dike Drilling

LOCATION Carbo, Virginia

PROJECT NO. 3050-09-0131

LOGGED BY Jon McDaniel

CHECKED BY <sup>RDR</sup> Ryan Rasnake

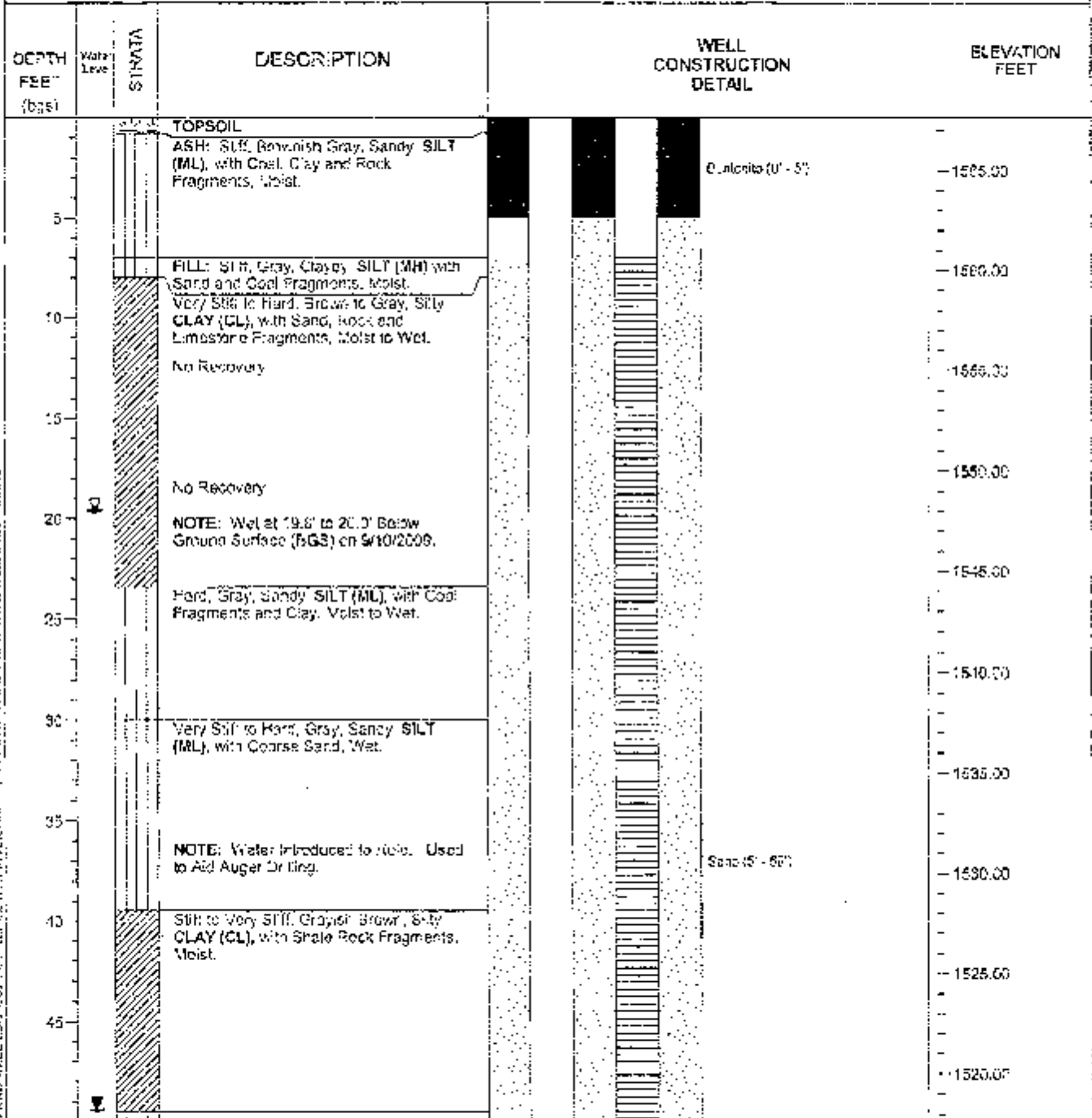

AUBURN DRILLING AND WELL LOG COMPANY, 11111 CLINCH RIVER DRIVE, CLINCH RIVER, VA 22615

DRILLING CONTRACTOR: Tri-State Drilling  
 DRILLING METHOD: 3.25" HSA  
 DRILLING EQUIPMENT: CME 75 Truck Rig  
 DATE DRILLED: 9/11/2009

Northing: 3521457.007  
 Easting: 10702599.492

MACTEC Engineering and Consulting, Inc.

BORING NO. B-0908

SHEET 2 OF 2

PROJECT AEP Clinch River Dike Drilling

LOCATION Carbo, Virginia

PROJECT NO. 3050-09-0131

LOGGED BY Jon McDaniel

CHECKED BY <sup>RDR</sup> Ryan Rasnake

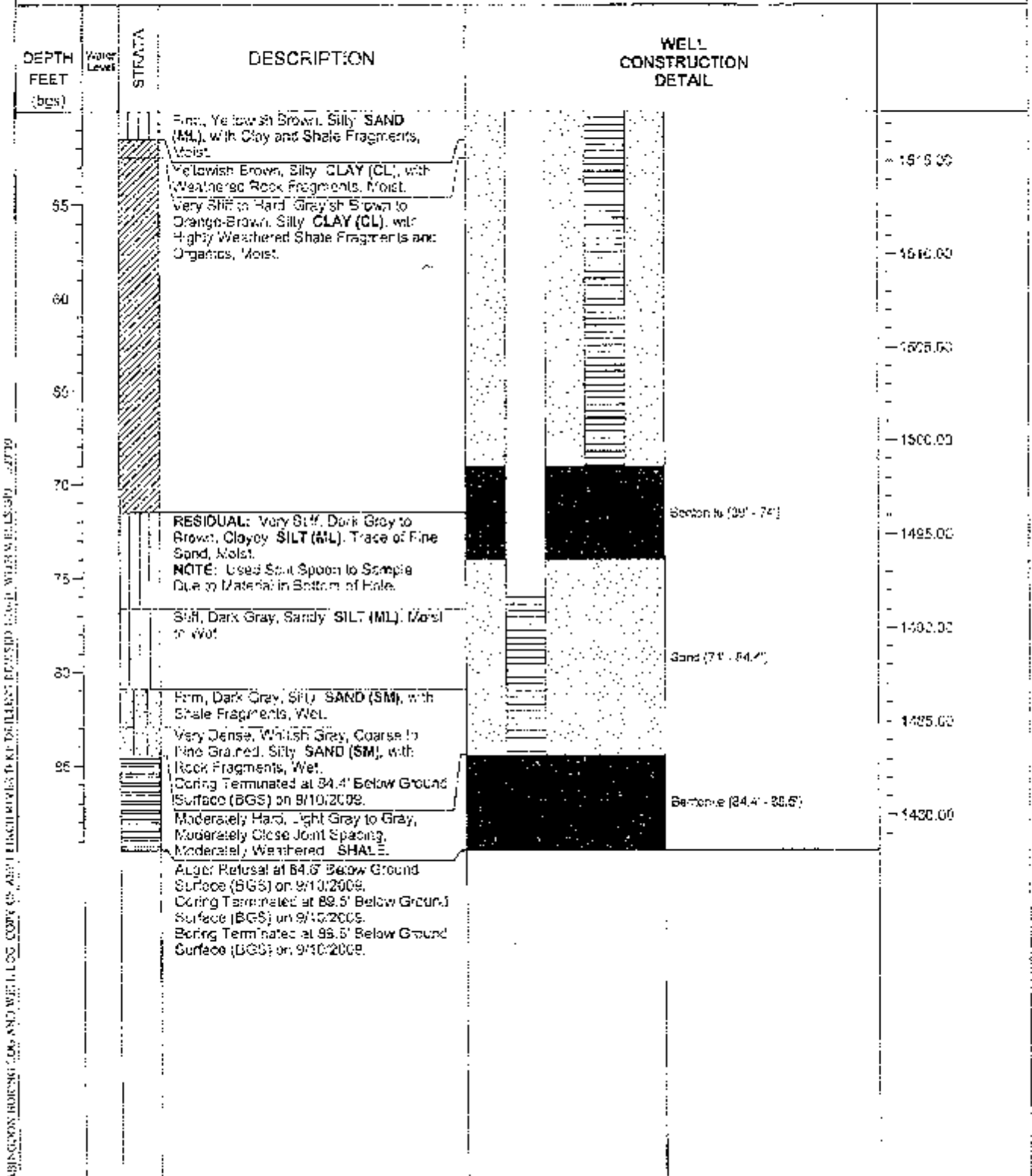

MACTEC Engineering and Consulting, Inc.

BORING NO. B-0909

SHEET 1 OF 1

PROJECT AEP Clinch River Dike Drilling

LOCATION Carbo, Virginia

PROJECT NO. 3050-09-0131

LOGGED BY Jon McDaniel

CHECKED BY <sup>RDP</sup> Ryan Rasnake

| DEPTH FEET (bgs)  | Water Level | STRATA  | DESCRIPTION   | WELL CONSTRUCTION DETAIL | ELEVATION FEET |
|---|-------------|---|---|--------------------------|----------------|
|   |             |   | ASH: Firm, Grayish Brown, Silty SAND (SM), with Coal and Rock Fragments, Moist.   | Concrete (0 - 5)         |                |
| 5   |             |   | Hard to Very Stiff, Gray, Sandy SILT (ML), with Small Coal Fragments, Wet.  |                          | 1515.00        |
| 10  |             |   | FILL: Very Stiff, Brown, Silty CLAY (CH), with Weathered Rock Fragments, Moist.<br>NOTE: Material Too Hard For UD Tube.<br>Soft, Silty CLAY (CH), with Rock Fragments, Wet to Moist.  |                          | 1510.00        |
| 15  |             |   |   |                          | 1505.00        |
| 20  |             |   | Stiff, Gray to Brown, Silty CLAY (CH) Moist.  | Sand (5 - 33.5)          | 1500.00        |
| 25  |             |   | ALLUVIUM: Stiff, Dark Gray, Clayey SILT (MH), Trace of Sand, Moist.<br>NOTE: Streaks of Black Throughout.   |                          | 1495.00        |
| 30  |             |   | Very Soft, Dark Gray to Brown, Sandy SILT (ML), with Clay, Wet.   |                          | 1490.00        |
| 35  |             |   | Very Loose, Dark Gray to Brown, Silty SAND (SM), with Streaks of Dark Red to Brown Clay Throughout, and Rock Fragments, Wet.  |                          | 1485.00        |
|   |             |   | Very Hard, Yellowish Brown, Highly Weathered SHALE (HWR), with Silt, Moist.<br>Rock Casing Begins at 33.8' Below Ground Surface (BGS) on 9/11/2009.<br>Soft, Dark Gray to Brown, Close Joint Spacing, Highly Weathered SHALE, Wet.<br>Auger Refusal at 35.8' Below Ground Surface (BGS) on 9/11/2009.<br>Coring Terminated at 38.8' Below Ground Surface (BGS) on 9/11/2009.<br>Boring Terminated at 38.8' Below Ground Surface (BGS) on 9/11/2009. | Concrete (33.8' - 38.8') | 1480.00        |
| <p>DRILLING CONTRACTOR <b>Tri-State Drilling</b></p> <p>DRILLING METHOD <b>3.25" HSA</b></p> <p>DRILLING EQUIPMENT <b>CME 75 Truck Rig</b></p> <p>DATE DRILLED <b>9/11/2009</b></p> |             | <p>Northing: <b>3521314.823</b></p> <p>Easting: <b>10492004.531</b></p> |   |                          |                |

ALL INFORMATION CONTAINED HEREIN IS UNCLASSIFIED EXCEPT WHERE SHOWN OTHERWISE DATE 12/20/09 BY 60322 UCBAW/STP

**APPENDIX D**

**LABORATORY SOIL TEST RESULTS**

## LABORATORY TEST PROCEDURES

### Soil Classification

Soil classifications provide a general guide to the engineering properties of various soil types and enable the engineer to apply past experience to current situations. Samples obtained during drilling operations are examined in our laboratory and visually classified by an engineer. The soils are classified according to consistency (based on number of blows from standard penetration tests), color and texture. These classification descriptions are included on our Test Boring Records.

The classification system discussed above is primarily qualitative. A detailed soil classification requires two laboratory tests: grain size tests and plasticity tests. Using these test results the soil can be classified according to the AASHTO or Unified Classification Systems (ASTM D2487). Each of these classification systems and the in-place physical soil properties provide an index for estimating the soil's behavior. The soil classification and physical properties determined are presented in this report.

### Moisture Content

The moisture content in a given mass of soil is the ratio, expressed as a percentage, of the weight of the water to the weight of the solid particles. This test was conducted in accordance with ASTM D 2716.

### Grain Size Distribution

Grain Size Tests are performed to aid in determining the soil classification and the grain size distribution. The soil samples are prepared for testing according to ASTM D 421 (dry preparation) or ASTM D 2217 (wet preparation). If only the grain size distribution of soils coarser than a number 200 sieve (0.075-mm opening) is desired, the grain size distribution is determined by washing the sample over a number 200 sieve and, after drying, passing the samples through a standard set of nested sieves. If the grain size distribution of the soils finer than the number 200 sieve is also desired, the grain size distribution of the soils coarser than the number 10 sieve is determined by passing the sample through a set of nested sieves. Materials passing the number 10 sieve are dispersed with a dispersing agent and suspended in water, and the grain size distribution calculated



from the measured settlement rate of the particles. These tests are conducted in accordance with ASTM D 422.

### **Atterberg Limits**

Portions of the samples are taken for Atterberg limits testing to determine the plasticity characteristics of the soil. The plasticity index (PI) is the range of moisture content over which the soil deforms as a plastic material. It is bracketed by the liquid limit (LL) and the plastic limit (PL). The liquid limit is the moisture content at which the soil becomes sufficiently "wet" to flow as a heavy viscous fluid. The plastic limit is the lowest moisture content at which the soil is sufficiently plastic to be manually rolled into tiny threads. The liquid limit and plastic limit are determined in accordance with ASTM D4318.

### **Consolidation Tests**

One-dimensional consolidation tests are conducted to determine the compression characteristics of soils under applied vertical stresses. Test results may provide information including the magnitude of settlement, the time-rate effects, and the past stress history of the soil.

Tests are conducted in general accordance with ASTM D 2435. A soil sample 2.5 inches in diameter and 1.0 inch thick is fitted into a stainless steel ring, with porous stones above and below the soil. The sample is then placed in a loading device and subjected to a series of increasing vertical stresses under conditions of no lateral strain. Time-deformation readings are recorded for each applied stress, and the resultant strain or void ratio is calculated.

Typically, test results include a plot of void ratio or percent strain versus the log of the applied stress. The virgin compression index ( $C_c$ ), the rebound or swelling index ( $C_s$ ), the coefficient of consolidation ( $C_v$ ), the constrained modulus ( $M=1/m_v$ ), and the preconsolidation stress ( $P_c$ ) are all important parameters obtained from this test.

### **Triaxial Shear Tests**

Triaxial shear tests are used to measure the stress-strain characteristics and strength of soils under various loading conditions expected in the field. Tests may be undrained, semi-drained or fully-drained to simulate field behavior. Triaxial shear tests are performed in accordance with ASTM D 4767.

Triaxial shear tests are conducted either on relatively undisturbed samples or on remolded/compacted specimens of soil. Diameters of specimens range between 1.4 and 6.0 inches and a minimum length/diameter ratio of 2 is standard. Either stress-controlled or strain-controlled tests are performed. Loads are measured using proving rings or electronic load cells, deformations are monitored using electronic LVDTs or dial indicators, and pore water pressure is measured with transducers. Normally, samples are saturated, consolidated and sheared to failure under compression loading, although extension loading is also possible.

Various consolidation conditions may be implemented in the triaxial apparatus. Stress and deformation occur in three dimensions under triaxial conditions. The three most common types of triaxial compression tests in routine use include:

CU = isotropically-consolidated undrained (i.e., CIU)

CD = isotropically-consolidated drained (i.e., CID)

UU = unconsolidated-undrained shear tests

The results of the tests are presented in terms of stress-strain curves and stress paths to failure. Alternatively, the strength may be represented by Mohr-Coulomb circles at failure. Short-term undrained strengths may be represented by total stress parameters ( $\phi$  and  $C$ ) or by undrained shear strengths ( $S_u$ ). The long-term drained strengths (condition of zero excess pore pressure response) are described by the effective stress parameters ( $\phi$  and  $C'$ ).

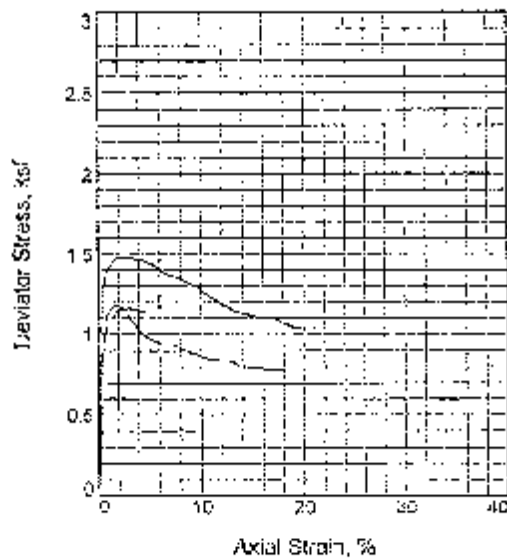
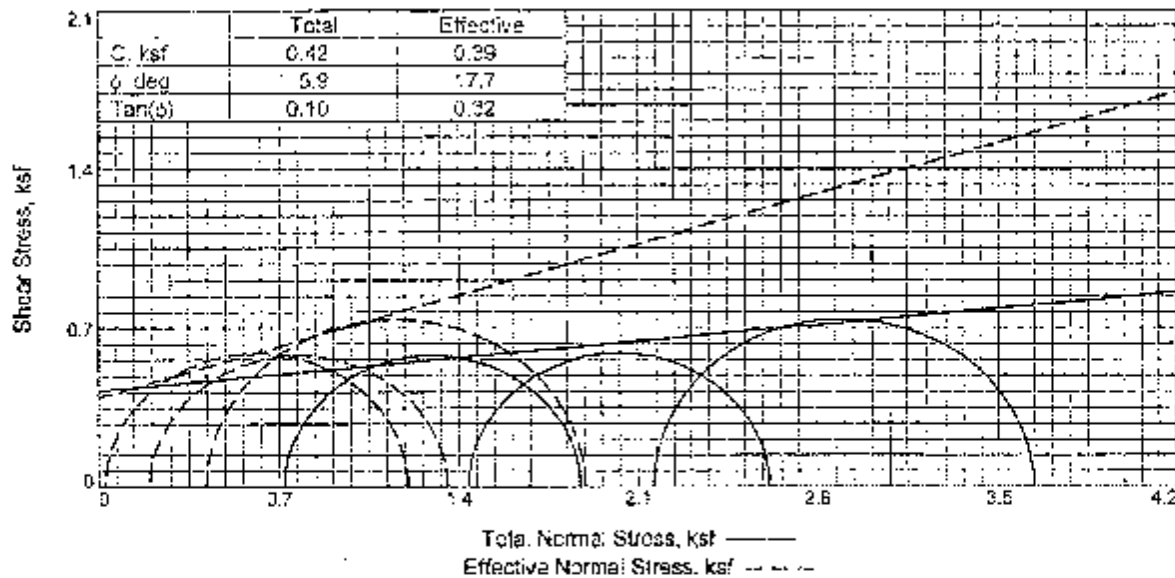

| Sample No.              | 1      | 2      | 3      |
|-------------------------|--------|--------|--------|
| <b>Initial</b>          |        |        |        |
| Water Content, %        | 72.1   | 45.7   | 72.1   |
| Dry Density, pcf        | 50.3   | 59.1   | 52.5   |
| Saturation, %           | 92.5   | 76.0   | 99.0   |
| Void Ratio              | 1.6915 | 1.2903 | 1.5787 |
| Diameter, in.           | 2.85   | 2.74   | 2.83   |
| Height, in.             | 5.56   | 5.59   | 5.32   |
| <b>At Test</b>          |        |        |        |
| Water Content, %        | 75.8   | 55.2   | 68.4   |
| Dry Density, pcf        | 51.2   | 61.6   | 54.5   |
| Saturation, %           | 100.0  | 100.0  | 100.0  |
| Void Ratio              | 1.5450 | 1.1978 | 1.4850 |
| Diameter, in.           | 2.81   | 2.70   | 2.79   |
| Height, in.             | 5.53   | 5.52   | 5.35   |
| Strain rate, in./min.   | 0.01   | 0.01   | 0.01   |
| Back Pressure, psi      | 60.00  | 60.00  | 60.00  |
| Cell Pressure, psi      | 65.00  | 70.00  | 75.00  |
| Fail. Stress, ksf       | 1.16   | 1.18   | 1.48   |
| Total Pore Pr., ksf     | 9.16   | 10.05  | 10.38  |
| <b>Ult. Stress ksf</b>  |        |        | 1.09   |
| Total Pore Pr., ksf     |        |        | 9.62   |
| $\sigma_1$ Failure, ksf | 1.36   | 1.20   | 1.39   |
| $\sigma_3$ Failure, ksf | 0.20   | 0.03   | 0.2    |

**Type of Test:**  
 CU with Pore Pressures  
**Sample Type:** UD  
**Description:** Gray Sandy SILT

Specific Gravity = 2.170  
 Remarks: Percent passing no. 200 sieve - pills 1 & 3:  
 86.7%; pill 2: 59.1%  
 Note: pills 1 & 3 were stage loaded

JAX, FL. \_\_\_\_\_

**Client:** American Electric Power  
**Project:** Dike Drilling  
**Source of Sample:** B-0902      **Depth:** 13.0' - 15.0'  
**Sample Number:** UD 4  
 Proj. No. 10602013-02      **Date Sampled:** 9-14-09  
**TRIAXIAL SHEAR TEST REPORT**  
**MACTEC ENGINEERING AND CONSULTING, INC.**

Tested By: FB *Lajmi Subhanshi*

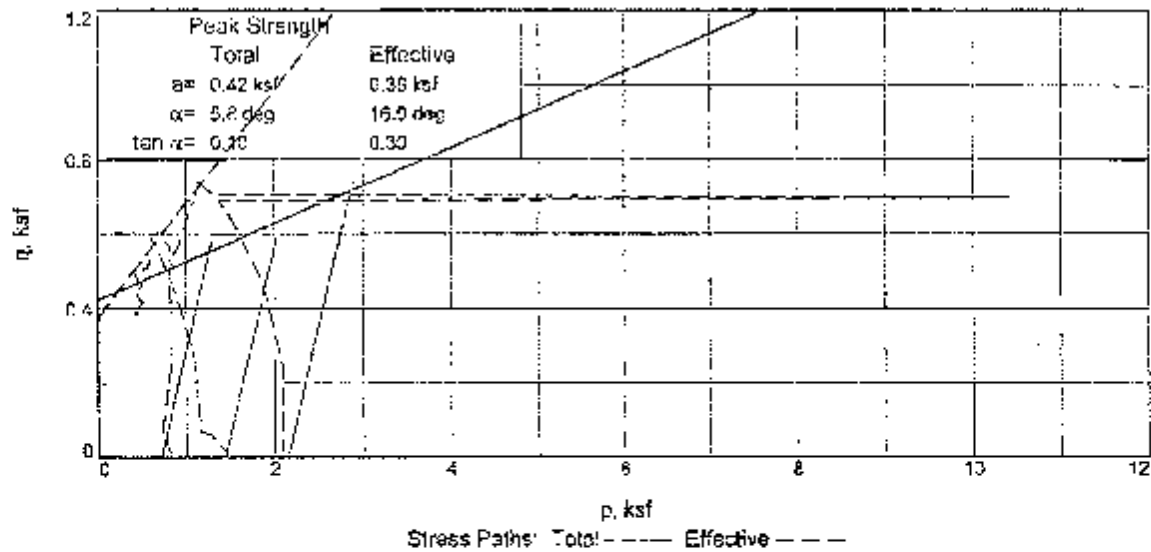
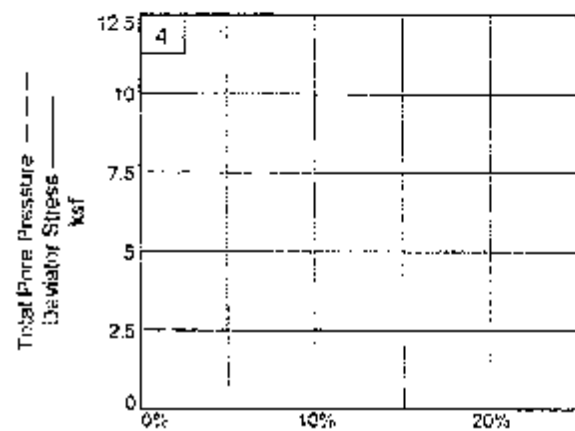
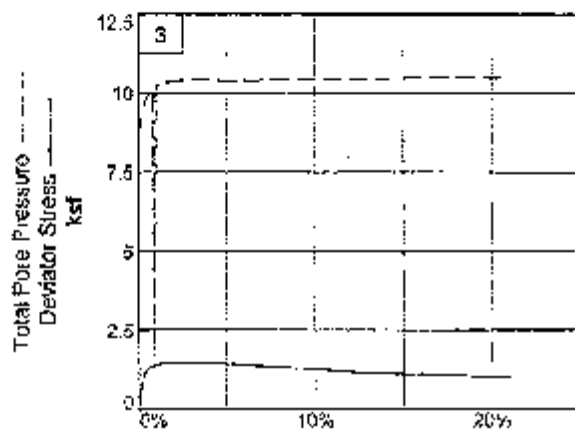
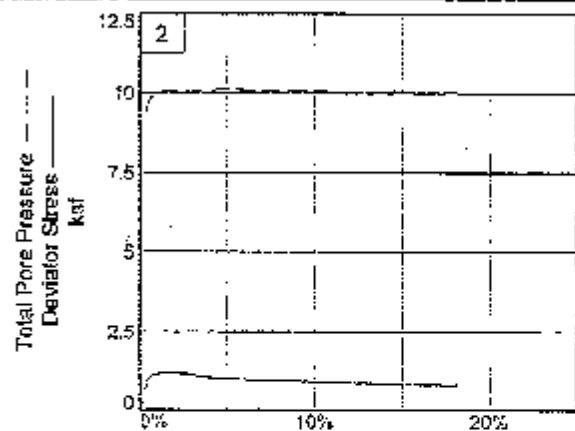
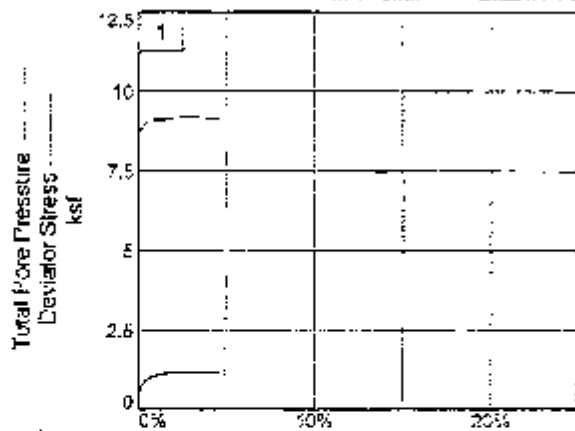

Client: American Electric Power

Project: Dike Drilling

Source of Sample: B-0902

Depth: 13.0-15.7

Sample Number: UD 4

Project No.: 3050090131.02

JAX, FL.

MACTEC Engineering and Consulting, Inc.

Tested By: FB

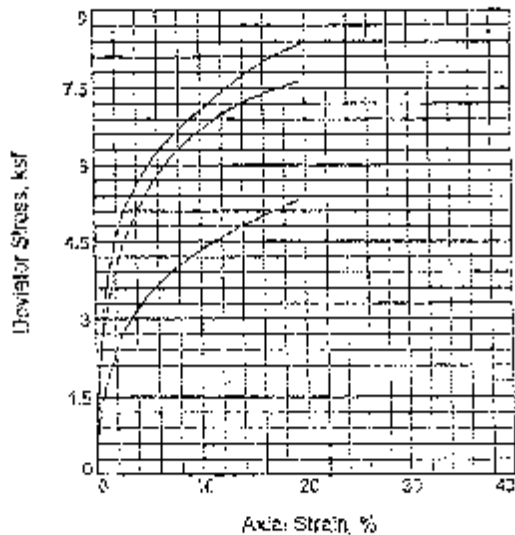
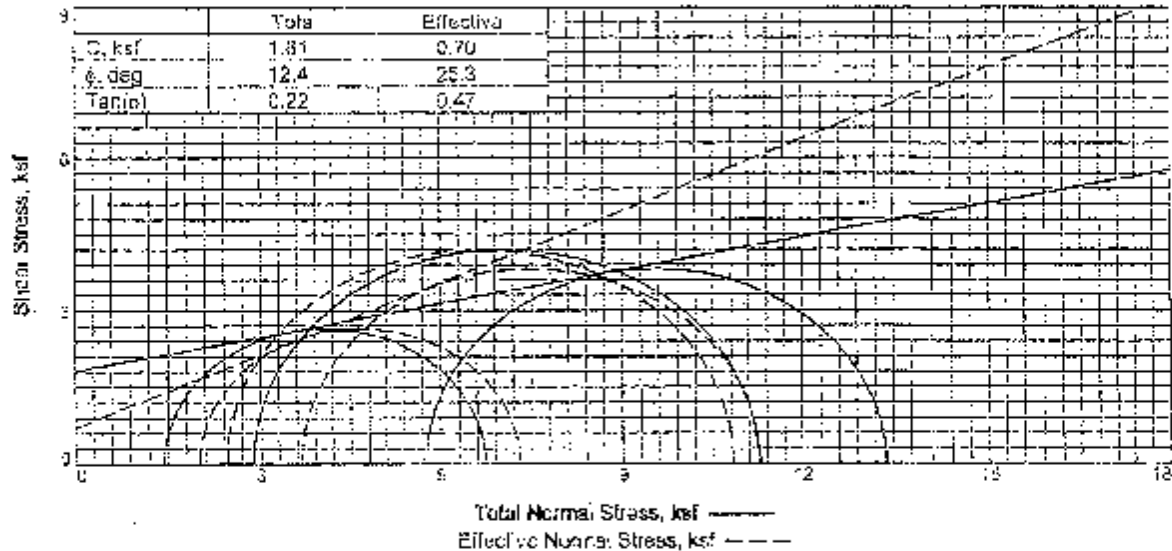

| Sample No.                    | 1      | 2      | 3      |
|-------------------------------|--------|--------|--------|
| <b>Initial</b>                |        |        |        |
| Water Content, %              | 11.9   | 6.5    | 14.5   |
| Dry Density, pcf              | 123.5  | 131.0  | 120.2  |
| Saturation, %                 | 86.7   | 51.4   | 96.1   |
| Void Ratio                    | 0.3725 | 0.2935 | 0.4109 |
| Diameter, in.                 | 2.83   | 2.85   | 2.64   |
| Height, in.                   | 5.61   | 5.57   | 5.61   |
| <b>At Test</b>                |        |        |        |
| Water Content, %              | 12.2   | 10.0   | 12.2   |
| Dry Density, pcf              | 127.2  | 133.2  | 127.3  |
| Saturation, %                 | 100.0  | 100.0  | 100.0  |
| Void Ratio                    | 0.3320 | 0.2723 | 0.3314 |
| Diameter, in.                 | 2.60   | 2.83   | 2.79   |
| Height, in.                   | 5.55   | 5.54   | 5.51   |
| Strain rate, in./min.         | 0.01   | 0.01   | 0.01   |
| Back Pressure, psf            | 50.00  | 50.00  | 50.00  |
| Cell Pressure, psi            | 70.00  | 60.00  | 90.00  |
| Fail. Stress, ksf             | 8.4    | 5.3    | 7.6    |
| Total Pore Pr., ksf           | 7.6    | 6.6    | 9.3    |
| Ut. Stress, ksf               |        |        |        |
| Total Pore Pr., ksf           |        |        |        |
| $\bar{\sigma}$ , Failure, ksf | 10.8   | 7.3    | 11.3   |
| $\bar{\sigma}$ , Failure, ksf | 2.4    | 2.0    | 3.7    |

Type of Test:  
 CU with Pore Pressures  
 Sample Type:  
 Description: Brown sandy lean clay with gravel  
 LL= 42      PL= 22      PI= 20  
 Specific Gravity= 2.715  
 Remarks: All pills were found to contain rock  
 fragments larger than 1/2" diameter

Client: American Electric Power  
 Project: Dike Drilling  
 Source of Sample: S-0904      Depth: 92.0'-94.0'  
 Sample Number: UD-7  
 Date Sampled: 9-16-79  
**TRIAXIAL SHEAR TEST REPORT**  
**MACTEC ENGINEERING AND CONSULTING, INC.**

Jax: FL  
 Tested By: EB *Romi Subhramani*

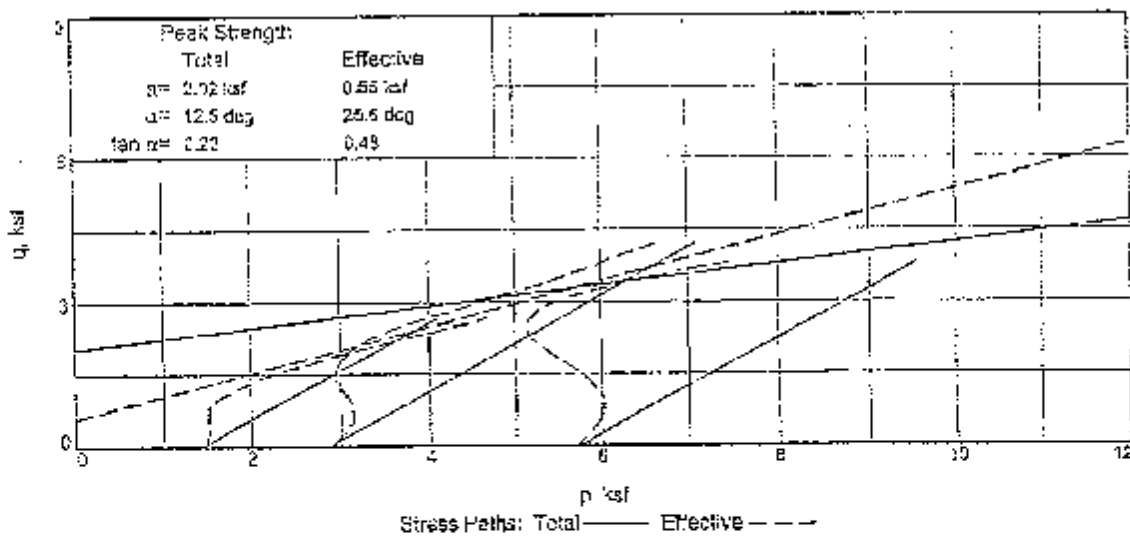
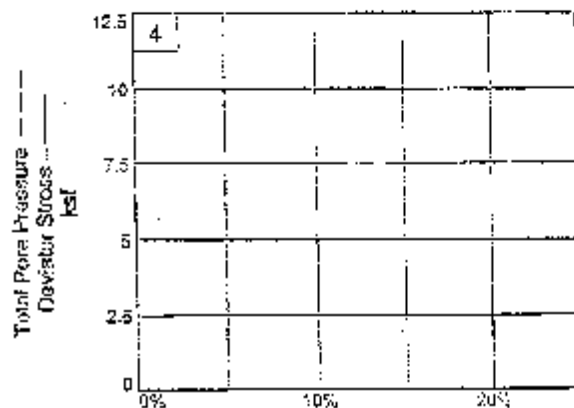
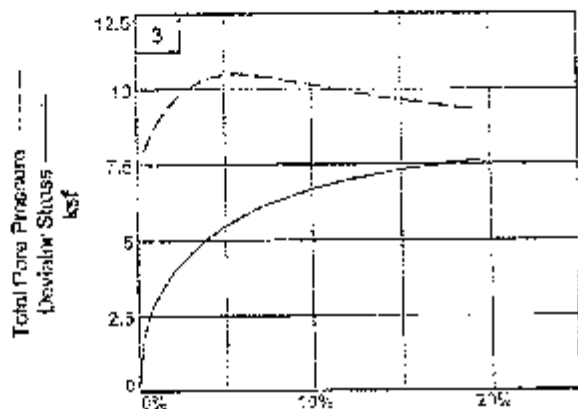
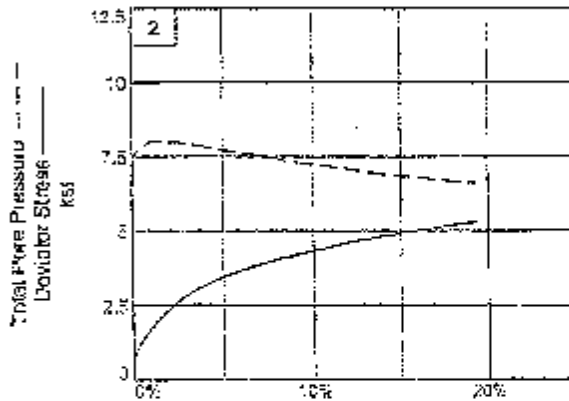
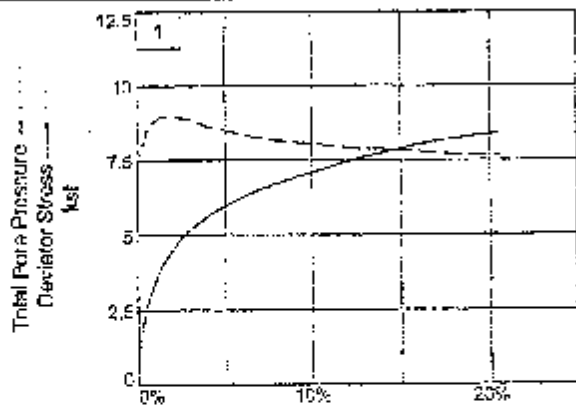

Client: American Electric Power

Project: Dike Drilling

Source of Sample: B-3924

Depth: 32.0'-34.0'

Sample Number: UD-7

Project No.: 3050090131.02

Jax FL

MACTEC Engineering and Consulting, Inc.

Tested By: FB

*Raimi Subhasini*  
1

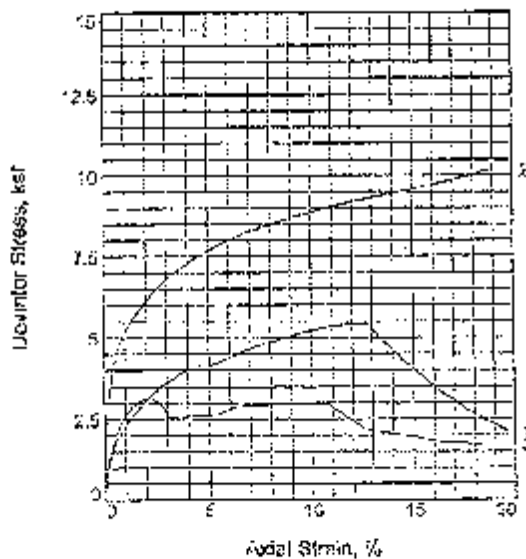
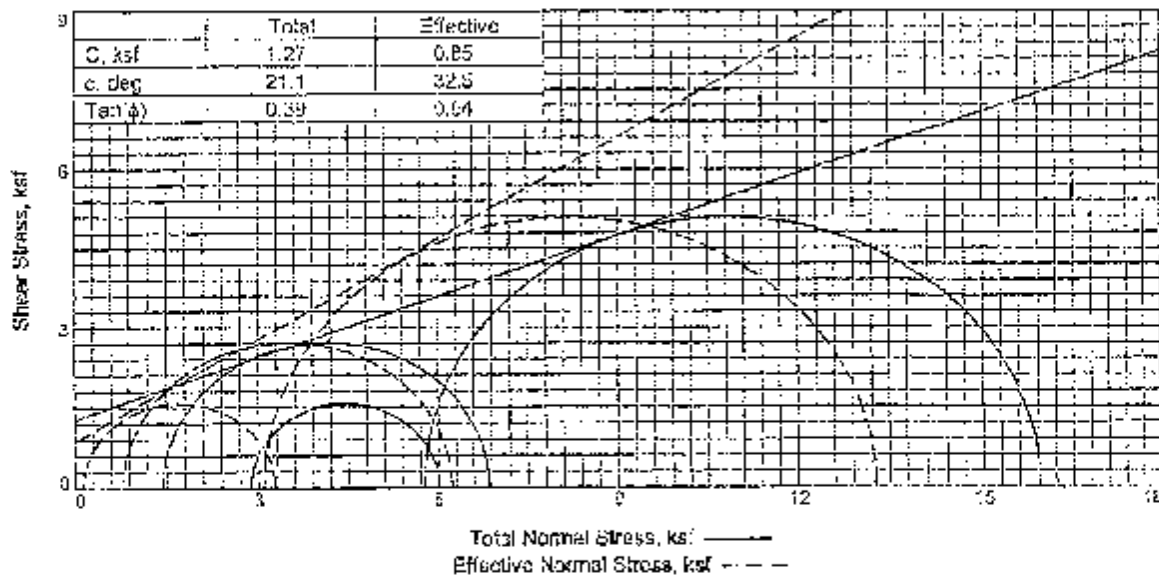

| Sample No.              | 1      | 2      | 3      |
|-------------------------|--------|--------|--------|
| <b>Initial:</b>         |        |        |        |
| Water Content, %        | 16.8   | 15.4   | 16.1   |
| Dry Density, pcf        | 122.5  | 119.8  | 122.5  |
| Saturation, %           | 100.0  | 96.9   | 100.0  |
| Void Ratio              | 0.4911 | 0.4382 | 0.4504 |
| Diameter, in.           | 2.83   | 2.65   | 2.83   |
| Height, in.             | 5.56   | 5.59   | 5.64   |
| <b>At Test:</b>         |        |        |        |
| Water Content, %        | 15.8   | 13.2   | 14.2   |
| Dry Density, pcf        | 124.9  | 126.3  | 127.0  |
| Saturation, %           | 100.0  | 100.0  | 100.0  |
| Void Ratio              | 0.4622 | 0.3647 | 0.4030 |
| Diameter, in.           | 2.80   | 2.86   | 2.80   |
| Height, in.             | 5.53   | 5.49   | 5.57   |
| Strain rate, in./min.   | 0.01   | 0.01   | 0.01   |
| Back Pressure, psi      | 50.00  | 50.00  | 50.00  |
| Cell Pressure, psi      | 60.00  | 60.00  | 60.00  |
| Fail. Stress, ksf       | 5.4    | 10.2   | 3.1    |
| Total Pore Pr., ksf     | 7.8    | 9.9    | 9.9    |
| $\sigma_1$ Stress, ksf  |        |        |        |
| Total Pore Pr., ksf     |        |        |        |
| $\sigma_3$ Failure, ksf | 0.2    | 13.3   | 3.3    |
| $\sigma_2$ Failure, ksf | 0.8    | 3.1    | 0.1    |

Type of Test: CU with Pore Pressures  
 Sample Type: Description: Gray-brown sandy loam clay  
 LL= 35      PL= 22      PI= 13  
 Specific Gravity= 2.925  
 Remarks: All pills were found to contain rock fragments larger than 1/2" diameter

Client: American Electric Power  
 Project: Dike Drilling  
 Source of Sample: B-6904      Depth: 47.5'-50.0'  
 Sample Number: UD-10  
 Date Sampled:  
 TRIAXIAL SHEAR TEST REPORT  
 MACTEC ENGINEERING AND CONSULTING, INC.

Jax FL \_\_\_\_\_ *Roger Kishner*

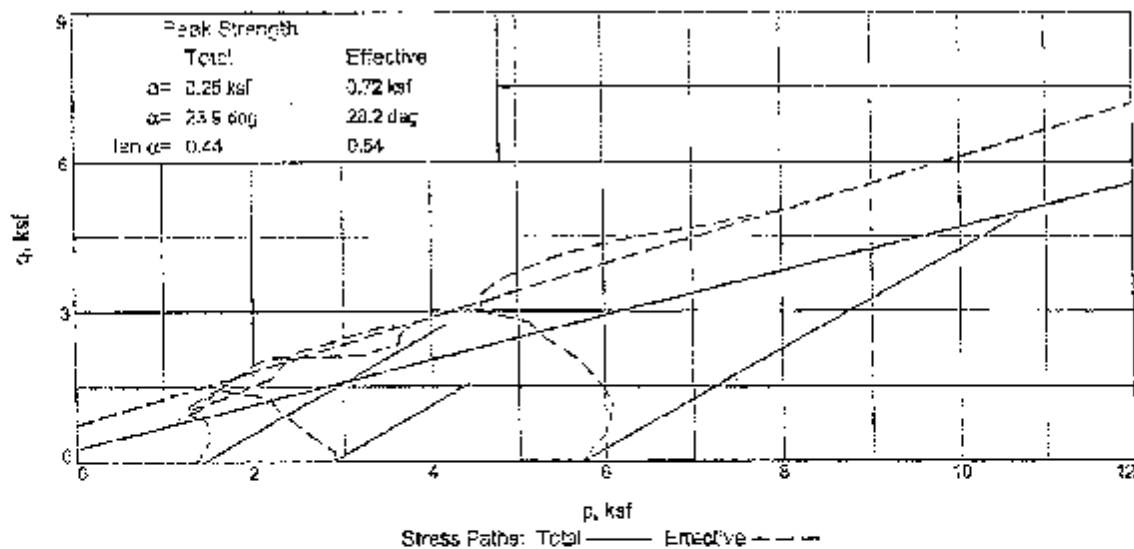
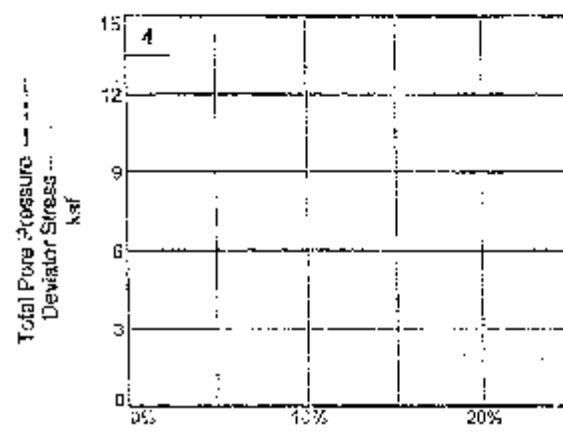
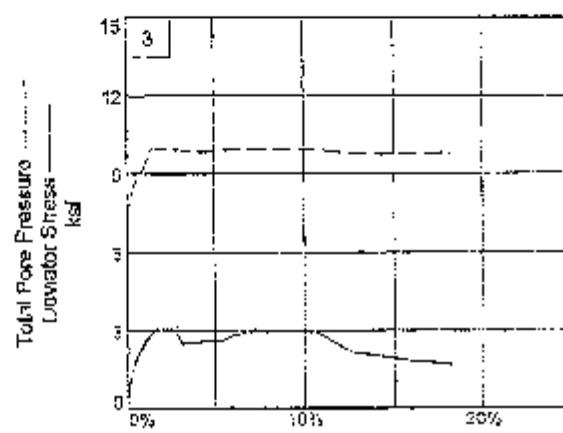
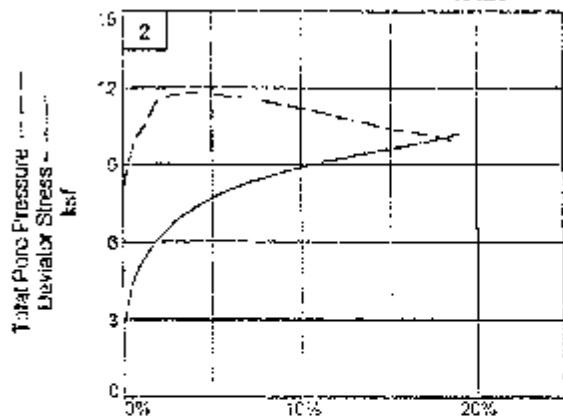
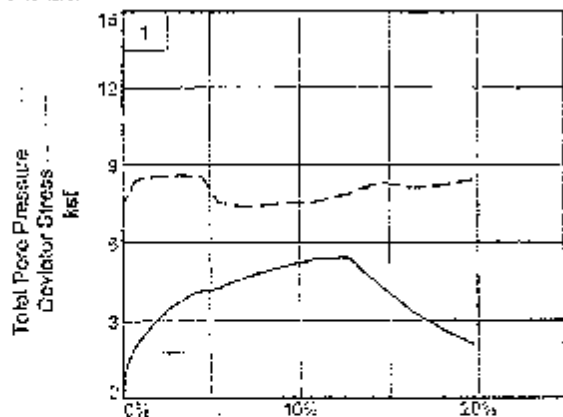

Client: American Electric Power

Project: Dike Drilling

Source of Sample: B-0904

Depth: 47.8-50.0'

Sample Number: UD 10

*Tom Luchiani*

Project No.: 3050090131.02

Jax FL

MACTEC Engineering and Consulting, Inc.



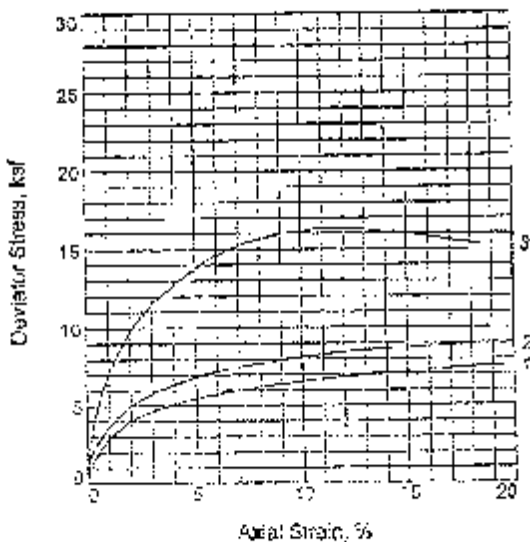
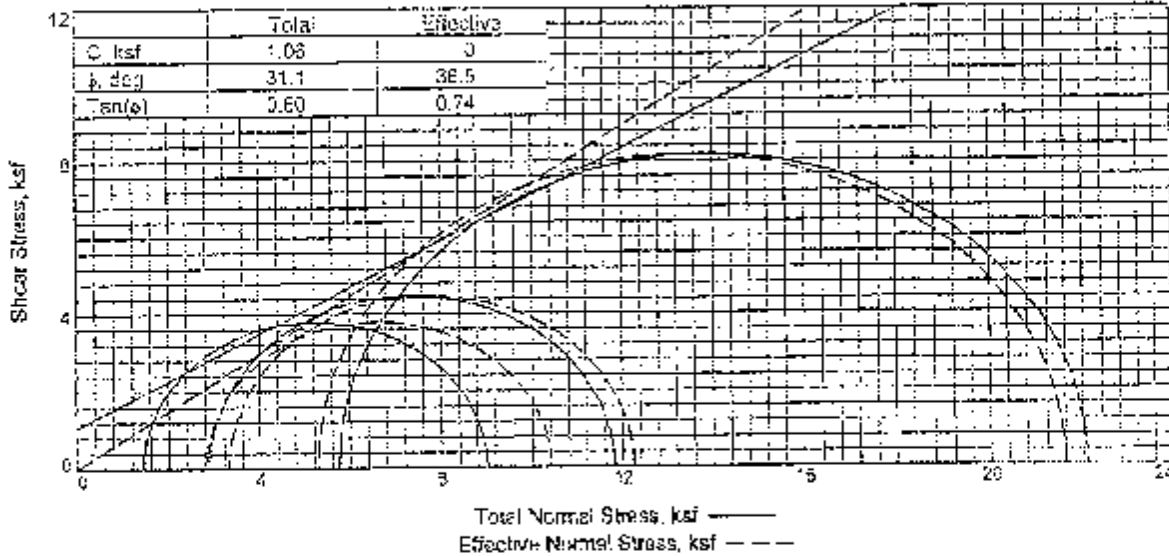

| Sample No.                    | 1      | 2      | 3      |
|-------------------------------|--------|--------|--------|
| <b>Initial</b>                |        |        |        |
| Water Content, %              | 15.9   | 10.9   | 11.5   |
| Dry Density, pcf              | 114.2  | 119.3  | 123.2  |
| Saturation, %                 | 96.9   | 71.5   | 77.7   |
| Void Ratio                    | 0.4719 | 0.4098 | 0.3983 |
| Diameter, in.                 | 2.87   | 2.88   | 2.87   |
| Height, in.                   | 5.66   | 5.58   | 5.58   |
| <b>At Test</b>                |        |        |        |
| Water Content, %              | 16.7   | 13.5   | 11.0   |
| Dry Density, pcf              | 115.9  | 123.2  | 129.8  |
| Saturation, %                 | 100.0  | 100.0  | 100.0  |
| Void Ratio                    | 0.4507 | 0.3546 | 0.2955 |
| Diameter, in.                 | 2.85   | 2.85   | 2.79   |
| Height, in.                   | 5.62   | 5.52   | 5.44   |
| Strain rate, in./min.         | 0.01   | 0.01   | 0.01   |
| Back Pressure, psi            | 50.00  | 50.00  | 50.00  |
| Cell Pressure, psi            | 50.00  | 70.00  | 90.00  |
| Fail. Stress, ksf             | 7.6    | 8.9    | 15.3   |
| Total Pore Pr., ksf           | 5.8    | 6.8    | 7.7    |
| Ult. Stress, ksf              |        |        |        |
| Total Pore Pr., ksf           |        |        |        |
| $\bar{\sigma}_1$ Failure, ksf | 10.4   | 12.3   | 21.0   |
| $\bar{\sigma}_3$ Failure, ksf | 2.8    | 3.3    | 5.3    |

**Type of Test:**  
 CU with Pore Pressures  
**Sample Type:** UD  
**Description:** Brown clayey sand with gravel  
 LL= 35      PL= 24      PI= 11  
 Specific Gravity= 2.693  
 Remarks: P11 A is sampled from B-0905 UD-3 (20.0'-22.0')

Client: American Electric Power  
 Project: Dike Drilling  
 Source of Sample: B-0905      Depth: 12.0'-14.0'  
 Sample Number: UD-1  
 Date Sampled:  
 TRIAXIAL SHEAR TEST REPORT  
 MACTEC ENGINEERING AND CONSULTING, INC.

Jax FL  
 Tested By: EB *Rajni. Subramaniam*

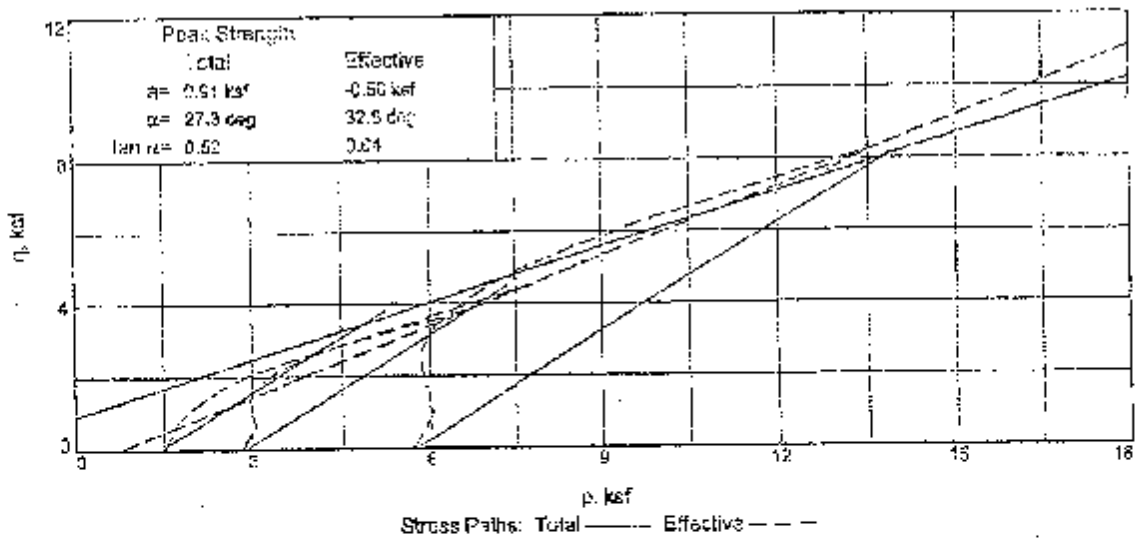
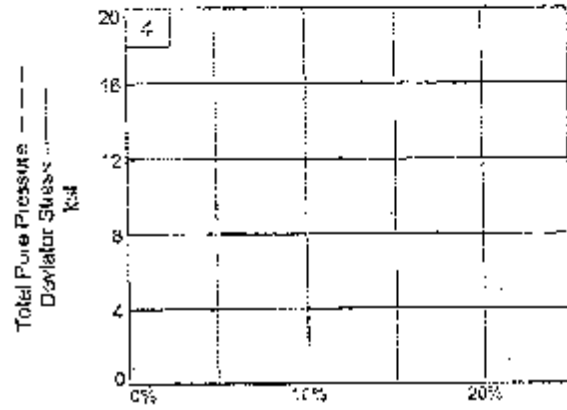
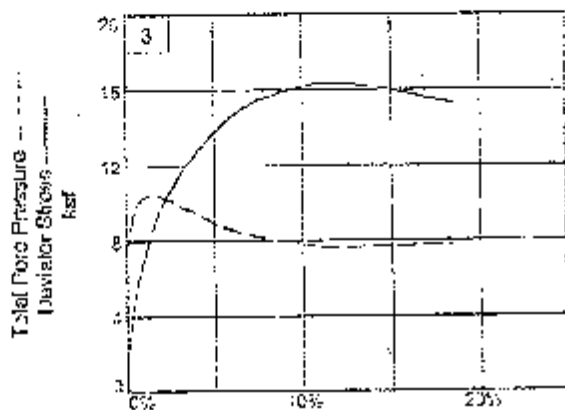
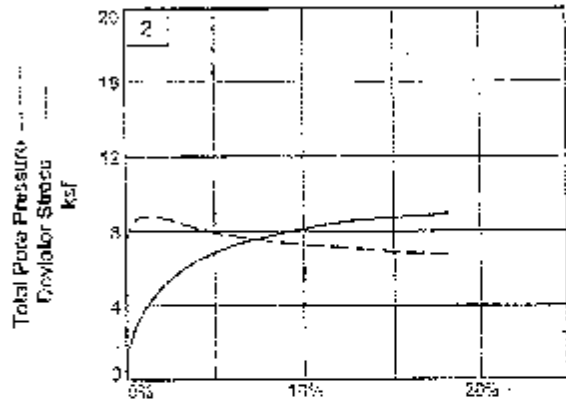
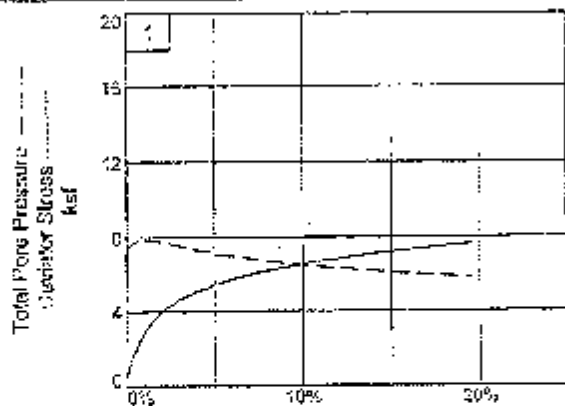

Client: American Electric Power

Project: Dike Drilling

Source of Sample: B-0305

Depth: (2.0'-14.0')

Sample Number: UD-1

Project No.: 2050090131.07

Jax FL. \_\_\_\_\_

MACTEC Engineering and Consulting, Inc.

Tested By: EB

*Kavir Vitharana*

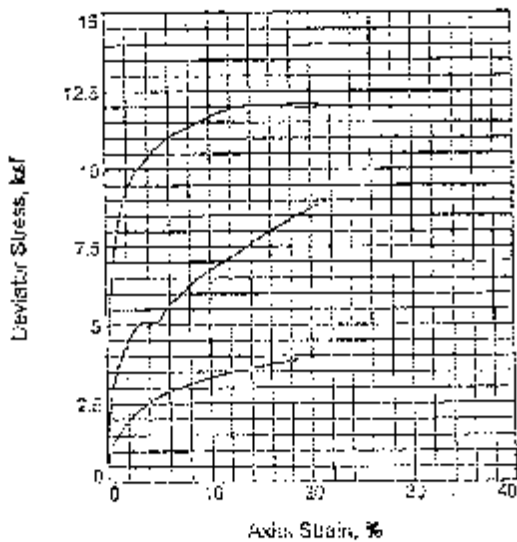
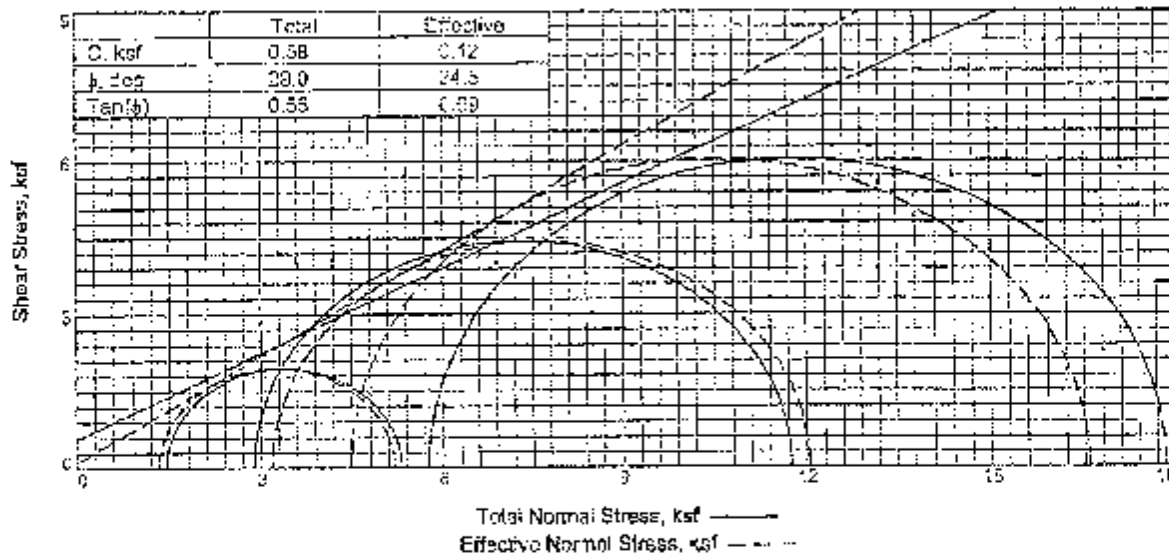

| Sample No.                    | 1      | 2      | 3      |
|-------------------------------|--------|--------|--------|
| Initial                       |        |        |        |
| Water Content, %              | 17.3   | 17.3   | 17.3   |
| Dry Density, pcf              | 113.3  | 115.4  | 118.4  |
| Saturation, %                 | 94.3   | 99.9   | 100.0  |
| Void Ratio                    | 0.4999 | 0.4717 | 0.4895 |
| Diameter, in.                 | 2.90   | 2.91   | 2.87   |
| Height, in.                   | 5.50   | 5.03   | 4.95   |
| At Test                       |        |        |        |
| Water Content, %              | 16.7   | 15.3   | 14.8   |
| Dry Density, pcf              | 116.7  | 120.0  | 124.3  |
| Saturation, %                 | 100.0  | 100.0  | 102.0  |
| Void Ratio                    | 0.4555 | 0.4160 | 0.4189 |
| Diameter, in.                 | 2.37   | 2.88   | 2.82   |
| Height, in.                   | 5.49   | 4.96   | 4.87   |
| Strain rate, in./min.         | 0.03   | 0.01   | 0.01   |
| Back Pressure, psi            | 50.00  | 50.00  | 50.00  |
| Cell Pressure, psi            | 60.00  | 70.00  | 90.00  |
| Fail. Stress, ksf             | 9.9    | 8.5    | 12.1   |
| Total Pore Pr., ksf           | 7.3    | 6.9    | 9.5    |
| Lit. Stress, ksf              |        |        |        |
| Total Pore Pr., ksf           |        |        |        |
| $\bar{\sigma}_1$ Failure, ksf | 5.2    | 12.1   | 16.6   |
| $\bar{\sigma}_3$ Failure, ksf | 1.3    | 3.2    | 4.5    |

Type of Test:  
 CU with Pore Pressures  
 Sample Type: UD  
 Description: Clayey silty gravel with sand  
 LL= 35      PL= 25      PI= 10  
 Specific Gravity= 2.721  
 Remarks:

Client: American Electric Power  
 Project: Dike Drilling  
 Source of Sample: B-0509      Depth: 11.5-13.5'  
 Sample Number: UD-3  
 Date Sampled:  
 TRIAXIAL SHEAR TEST REPORT  
 MACTEC ENGINEERING AND CONSULTING, INC.

Jax FL.  
 Tested By: FB *Karin [Signature]*

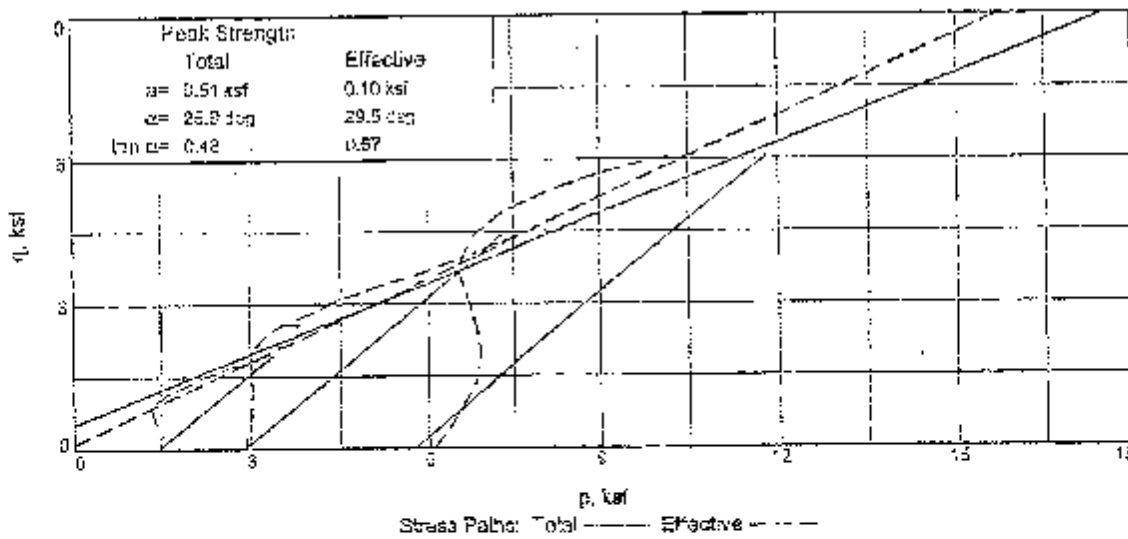
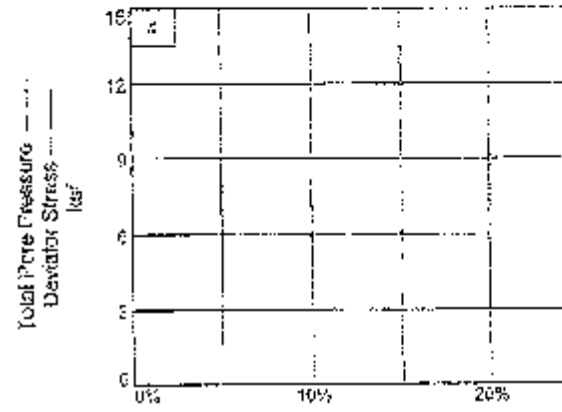
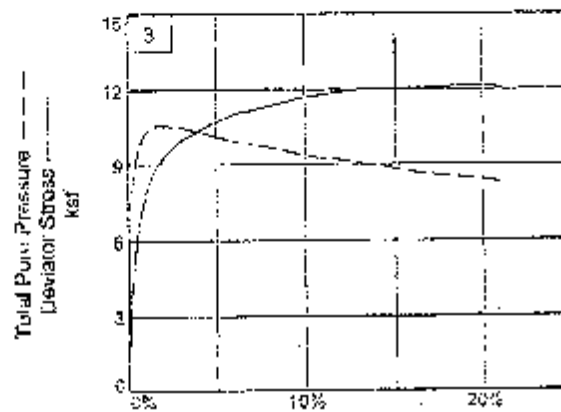
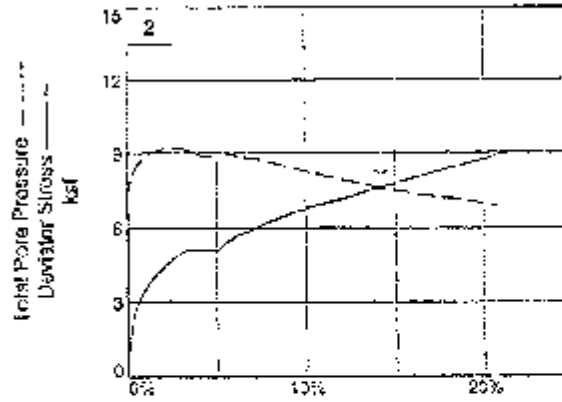
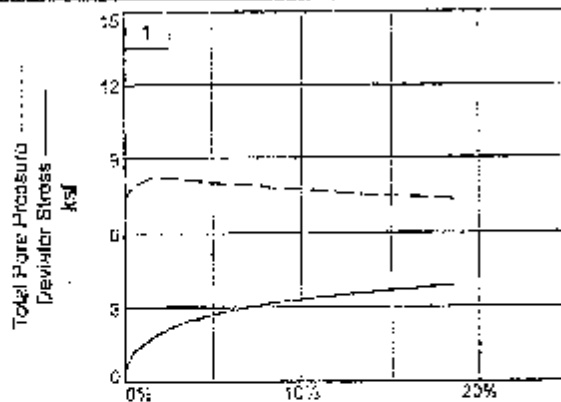

Client: American Electric Power

Project: Duke Drilling

Source of Sample: A-0905

Depth: 11.5'-13.5'

Sample Number: UD-3

Project No.: 3050090131-02

Jax FL

MACTEC Engineering and Consulting, Inc.

Tested By: EB

*Handwritten signature: Raji Sankaranarayanan*



MACTEC ENGINEERING AND CONSULTING, INC  
 22010 Comstock Drive  
 Abingdon, Virginia 24211  
 (276) 676-0426

Project Name: AEP Dike Drilling  
 Project Number: 3050-09-0131  
 Report Date: 11/09/09

Washed Particle Size/Gradation Test Report  
 ASTM D422

Sample Number: UD-6 Location: B-0901

Percent Finer than No. 200: 37.7 % (from washing)

| Sieve Size    | Cumulative (g) | Wt. Retained Each Sieve (g) | Cumulative % Passing | Cumulative % Passing w/ Wash 200 |
|---------------|----------------|-----------------------------|----------------------|----------------------------------|
| 1 in.         | 26.47          | 26.47                       | 33.9                 | 36.5                             |
| 3/4 in.       | 36.86          | 10.35                       | 91.5                 | 94.7                             |
| 3/8 in.       | 117.88         | 81.02                       | 75.0                 | 81.1                             |
| # 4           | 212.55         | 94.67                       | 51.3                 | 69.4                             |
| # 10          | 296.73         | 84.18                       | 32.0                 | 57.3                             |
| # 20          | 355.25         | 58.52                       | 18.5                 | 48.9                             |
| # 40          | 387.02         | 31.77                       | 11.2                 | 44.4                             |
| # 60          | 404.09         | 17.07                       | 7.3                  | 41.9                             |
| # 100         | 417.48         | 13.39                       | 4.3                  | 40.0                             |
| # 200         | 433.17         | 15.69                       | 3.7                  | 37.7                             |
| Pass          | 456.05         | 2.88                        |                      |                                  |
| Wt. of Sub, g | 695.72         |                             |                      |                                  |

Particle Size Analysis  
 U.S. Standard Sieve Sizes  
 No. 40 No. 200

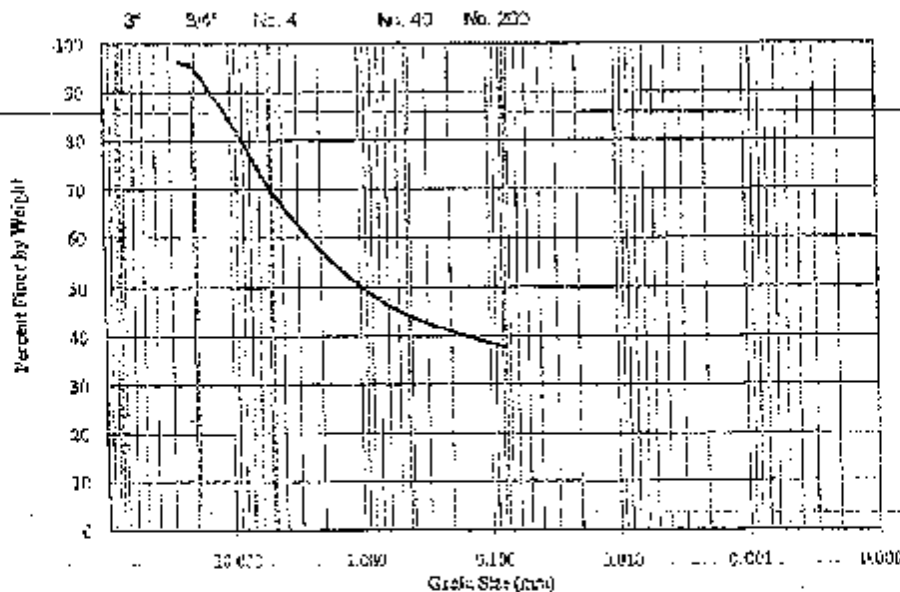

Performed By: MEH 11-11-09

Checked By: EDK 11-11-09

5-0921 (Rev. 5-04)

US EPA ARCHIVE DOCUMENT



MACTEC ENGINEERING AND CONSULTING, INC.  
 22013 Commerce Drive  
 Arlington, VA 22211

Sieve Analysis Test Report  
 Hydrometer Sieve  
 ASTM D422

Project Name: AEP Dike Drilling  
 Project Number: SC5D-03-0133  
 Report Date: 11/09/2008  
 Sample Number: E-0901 UD-6

Sieve and Hydrometer

| Particle Size | Units | Standard No. | Wt. Retained (g) | Wt. Retained Each Sieve (g) | Percentage Passing |
|---------------|-------|--------------|------------------|-----------------------------|--------------------|
| 20.0          | mm    | 20.47        | 26.9             | 26.9                        | 90.3               |
| 15.0          | mm    | 36.86        | 13.4             | 13.4                        | 94.7               |
| 7.5           | mm    | 117.38       | 31.0             | 31.0                        | 87.1               |
| 4.0           | mm    | 212.55       | 16.7             | 16.7                        | 83.4               |
| 2.0           | mm    | 293.75       | 8.2              | 8.2                         | 77.9               |
| 850           | um    | 25.525       | 55.5             | 55.5                        | 49.9               |
| 425           | um    | 127.02       | 31.9             | 31.9                        | 46.4               |
| 250           | um    | 62.505       | 17.1             | 17.1                        | 41.0               |
| 150           | um    | 40.048       | 10.4             | 10.4                        | 33.6               |
| 75            | um    | 20.017       | 5.7              | 5.7                         | 32.7               |
| 45            | um    | 10.009       | 3.2              | 3.2                         | 32.1               |
| 30            | um    | 6.006        | 2.1              | 2.1                         | 28.1               |
| 25            | um    | 5.005        | 1.9              | 1.9                         | 28.4               |
| 18            | um    | 3.003        | 1.3              | 1.3                         | 23.3               |
| 15            | um    | 2.502        | 1.0              | 1.0                         | 20.6               |
| 9.5           | um    | 1.501        | 0.4              | 0.4                         | 14.3               |
| 5.5           | um    | 0.850        | 0.2              | 0.2                         | 12.0               |
| 30            | um    | 3.003        | 0.2              | 0.2                         | 6.8                |
| 1.0           | um    | 0.750        | 0.2              | 0.2                         | 5.3                |
| Wt. of Solids |       |              | 126.72           |                             |                    |

Particle Size Analysis  
 U.S. Standard Sieve Sizes

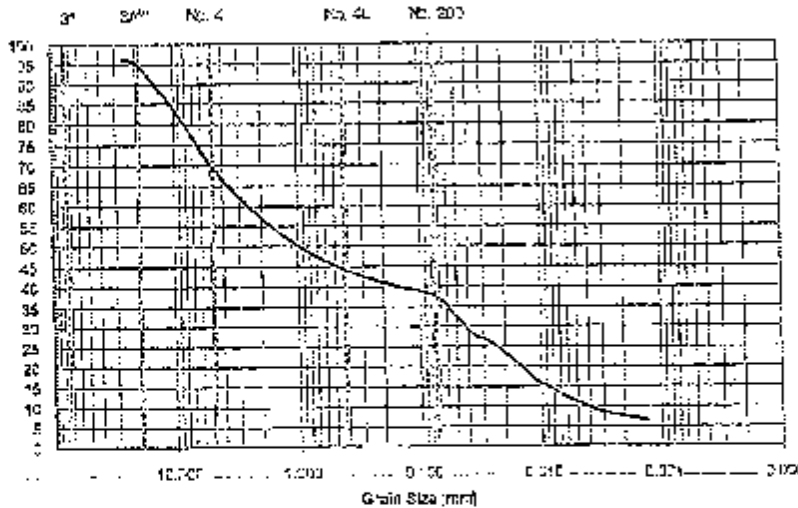

Performed by: WHA 11-11-09  
 Checked by: RDR 11-11-09

3-0171 UD-6, Hydromer

### Grain Size Distribution Report

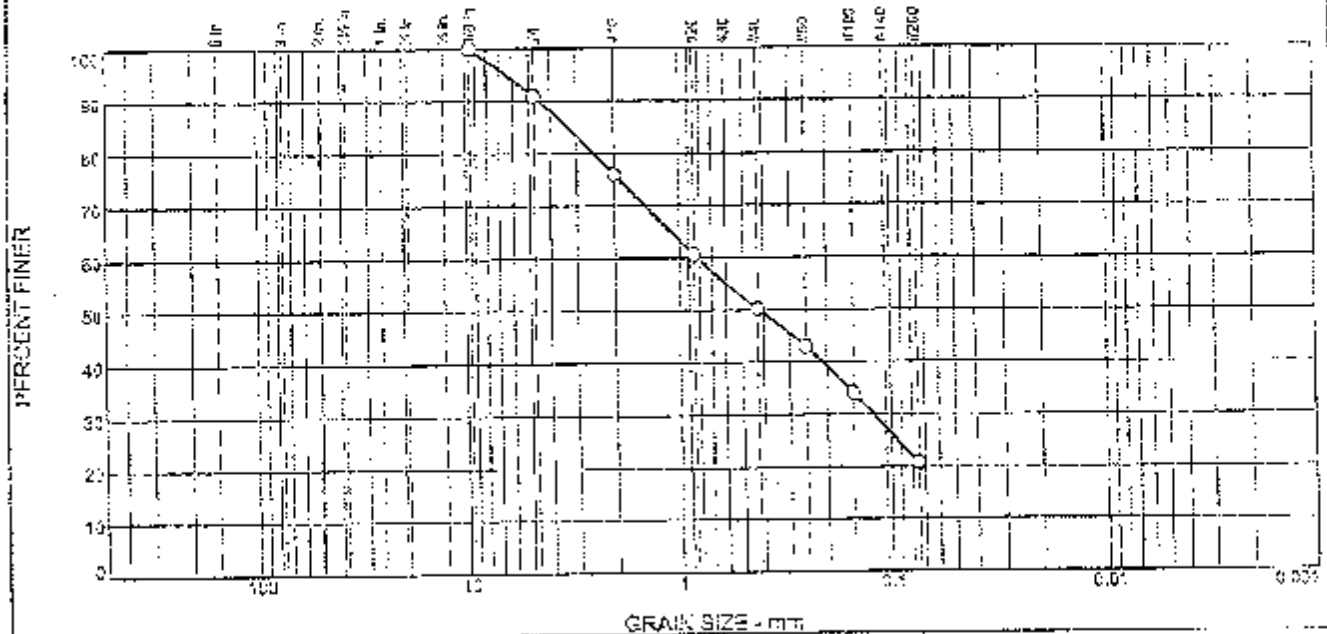

| % #20 | % Gravel |      | % Sand |        |      | % Fines | Clay |
|-------|----------|------|--------|--------|------|---------|------|
|       | Coarse   | Fine | Coarse | Medium | Fine |         |      |
| 0.0   | 0.0      | 5.1  | 14.9   | 25.8   | 29.5 | 20.7    |      |

| Test Results (ASTM D 422 w/ hyd & ASTM D 140) |               |                 |                |
|---|---------------|-----------------|----------------|
| Opening Size                                  | Percent Finer | Spec. (Percent) | Pass? (X=Fail) |
| 3/8"  | 100.0         |                 |                |
| #4  | 90.9          |                 |                |
| #10   | 76.0          |                 |                |
| #20   | 60.6          |                 |                |
| #40   | 50.2          |                 |                |
| #60   | 42.9          |                 |                |
| #100  | 34.0          |                 |                |
| #200  | 20.7          |                 |                |

**Material Description**  
brown medium to fine silty clayey SAND

**Atterberg Limits (ASTM D 4318)**  
 PL = \_\_\_\_\_ LI = \_\_\_\_\_ PI = \_\_\_\_\_

**Classification**  
 USCS (D 2487) = SC-SM      AASHTO (M 145) = \_\_\_\_\_

**Coefficients**  
 D<sub>60</sub> = 4.4875      D<sub>50</sub> = 3.2989      D<sub>30</sub> = 0.8183  
 U<sub>60</sub> = 0.4197      C<sub>u</sub> = 6.1214      C<sub>g</sub> = \_\_\_\_\_

**Remarks**  
 Moisture content: 18.6 %

Date Received: \_\_\_\_\_ Date Tested: 10-16-09  
 Tested By: FB  
 Checked By: Rajni Sukhwani  
 Title: \_\_\_\_\_

Source of Sample: U-0904      Depth: 25.0-27.0      Date Sampled: \_\_\_\_\_  
 Sample Number: UD-5

|  |   |  |
|--|---|--|
| <b>MACTEC ENGINEERING AND CONSULTING, INC.</b> | Client: American Electric Power<br>Project: Pike Drilling | Project No: 3050-09-0131-02<br>Jax, FL |
|--|---|--|

Checked By: PDR 11-13-09

### Grain Size Distribution Report

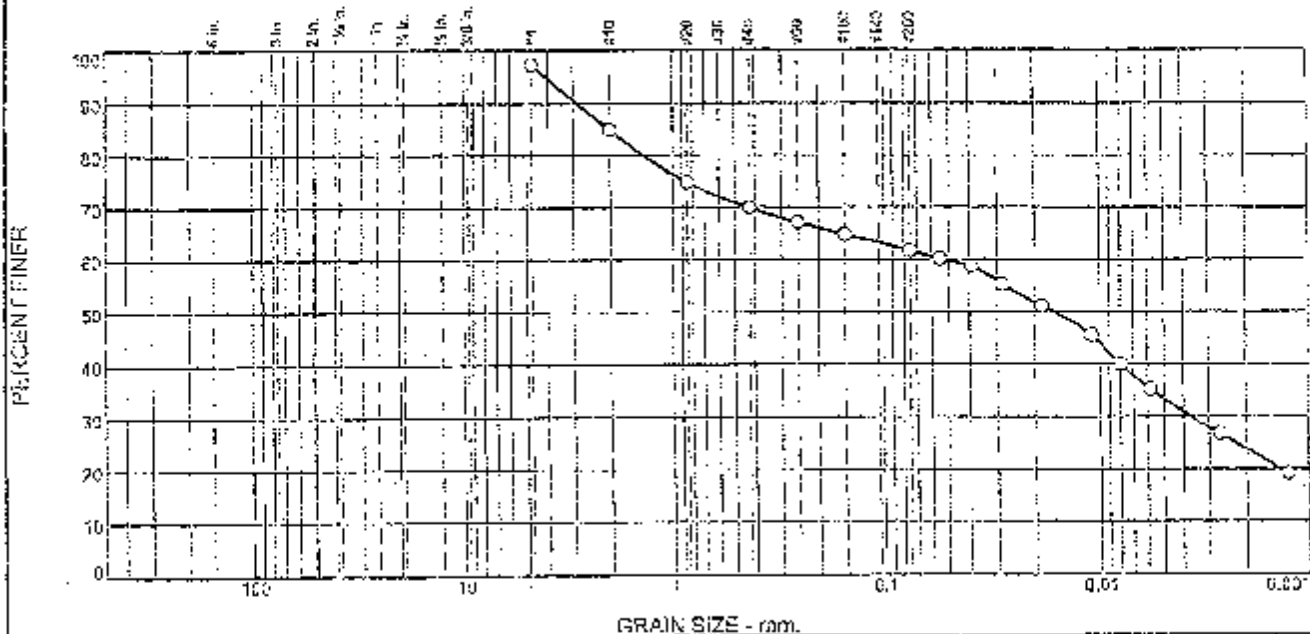

| % #3* | % Gravel |      | % Sand |        |      | % Fines |      |
|-------|----------|------|--------|--------|------|---------|------|
|       | Coarse   | Fine | Coarse | Medium | Fine | Silt    | Clay |
|       |          |      | 12.4   | 14.9   | 8.4  | 28.1    | 33.3 |

| TEST RESULTS (ASTM D 422) |               |                 |                |
|---------------------------|---------------|-----------------|----------------|
| Opening Size              | Percent Finer | Spec. (Percent) | Pass? (X=Fail) |
| #4                        | 97.3          |                 |                |
| #10                       | 84.9          |                 |                |
| #20                       | 74.9          |                 |                |
| #40                       | 70.0          |                 |                |
| #60                       | 67.1          |                 |                |
| #100                      | 64.7          |                 |                |
| #200                      | 61.5          |                 |                |
| 0.0542 mm.                | 60.1          |                 |                |
| 0.0391 mm.                | 58.7          |                 |                |
| 0.0283 mm.                | 55.3          |                 |                |
| 0.0182 mm.                | 51.1          |                 |                |
| 0.0109 mm.                | 45.5          |                 |                |
| 0.0080 mm.                | 40.0          |                 |                |
| 0.0058 mm.                | 35.2          |                 |                |
| 0.0027 mm.                | 26.8          |                 |                |
| 0.0019 mm.                | 19.2          |                 |                |

(no specification provided)

**Material Description**

Brown sandy lean clay with gravel

**Atterberg Limits (ASTM D 4318)**

PL= 21      LL= 42      PI= 20

**Classification**

USCS (D 2487)= CL      AASHTO (M 145)= A-7-5(10)

**Coefficients**

D<sub>60</sub>= 2.8725      D<sub>85</sub>= 2.0118      D<sub>100</sub>= 0.0535  
 D<sub>50</sub>= 0.0762      C<sub>u</sub>= 0.0057      D<sub>30</sub>=  
 D<sub>10</sub>=      C<sub>c</sub>=

**Remarks**

Moisture Content: 14.5%

---

Date Received: 10-15-09      Date Tested: 10-15-09

Tested By: FB

Checked By: *Rami Subhramanian*

Title: \_\_\_\_\_

Source of Sample: B-0904      Depth: 32.0-34.0'      Date Sampled: 9-16-09  
 Sample Number: UD-7

|  |                                 |
|--|---------------------------------|
| <b>MACTEC ENGINEERING AND CONSULTING, INC.</b> | Client: American Electric Power |
|  | Project: Dike Drilling          |
| Project No: 3350490-3-02                       | Jax, FL.                        |

Checked By: RDR 11-13-09



### Grain Size Distribution Report

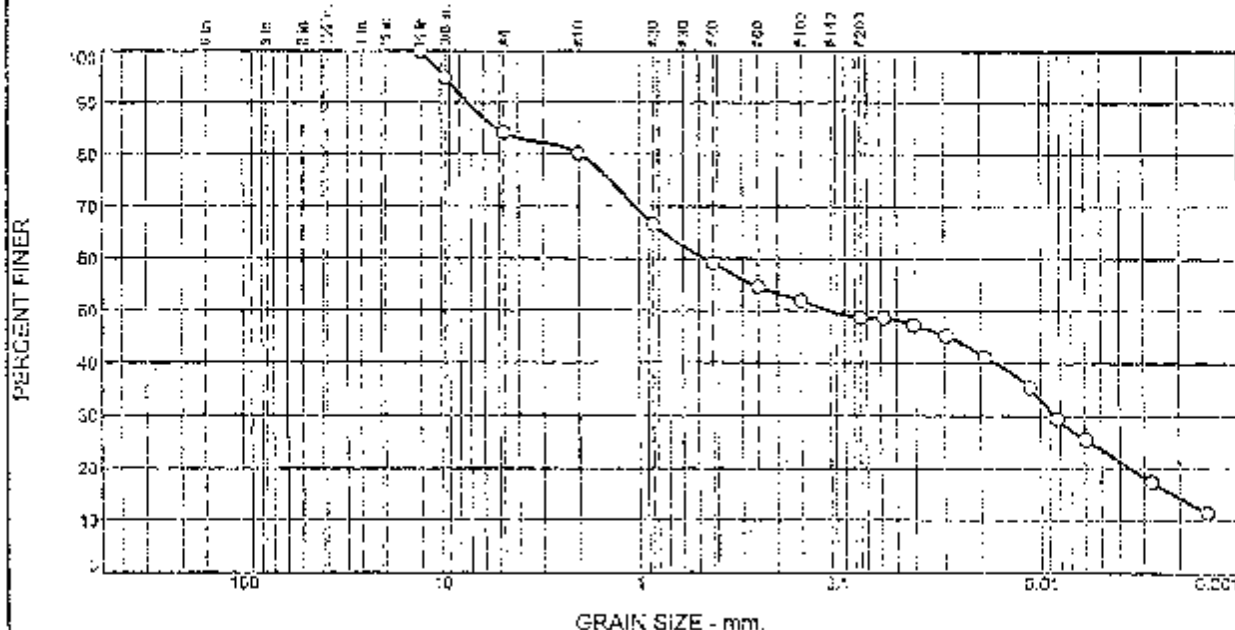

| % #3' | % Gravel |      | % Sand |        |      | % Fines |      |
|-------|----------|------|--------|--------|------|---------|------|
|       | Coarse   | Fine | Coarse | Medium | Fine | Silt    | Clay |
| 0.0   | 0.0      | 15.8 | 4.0    | 21.1   | 10.5 | 24.3    | 23.8 |

| TEST RESULTS (ASTM D 422) |               |                 |                |
|---------------------------|---------------|-----------------|----------------|
| Opening Size              | Percent Finer | Spec. (Percent) | Pass? (X=Fail) |
| 1/2"                      | 100.0         |                 |                |
| 3/8"                      | 94.9          |                 |                |
| #4                        | 84.2          |                 |                |
| #10                       | 79.2          |                 |                |
| #20                       | 66.6          |                 |                |
| #40                       | 59.1          |                 |                |
| #60                       | 54.5          |                 |                |
| #100                      | 51.8          |                 |                |
| #200                      | 45.6          |                 |                |
| 0.075 mm.                 | 48.6          |                 |                |
| 0.041 mm.                 | 47.3          |                 |                |
| 0.025 mm.                 | 45.3          |                 |                |
| 0.019 mm.                 | 41.3          |                 |                |
| 0.013 mm.                 | 35.4          |                 |                |
| 0.0085 mm.                | 29.5          |                 |                |
| 0.0060 mm.                | 25.6          |                 |                |
| 0.0027 mm.                | 17.4          |                 |                |
| 0.0014 mm.                | 11.5          |                 |                |

**Material Description**

Brown clayey fine sand with little fine gravel

---

**Afterberg Limits (ASTM D 4315)**

PL=                      LL=                      PI=

**Classification**

USCS (D 2407)= SC-SM    AASHTO (M 145)=

---

**Coefficients**

$D_{90}$  = 7.2367       $D_{85}$  = 5.1425       $D_{60}$  = 0.4707  
 $D_{50}$  = 0.1093       $D_{30}$  = 0.0085       $D_{15}$  = 0.0021  
 $D_{10}$  =               $C_u$  =               $C_c$  =

**Remarks**

Moisture Content: 11.5%  
P.M.: 1.97

---

Date Received: 10-15-09      Date Tested: 10-15-09  
 Tested By: FB  
 Checked By: *Kopri Subhawan*  
 Title: \_\_\_\_\_

(no specification provided)

Source of Sample: B-0904      Depth: 36.0'-38.0'      Date Sampled: \_\_\_\_\_  
 Sample Number: UD-8

|   |  |
|---|--|
| <p><b>MACTEC ENGINEERING AND CONSULTING, INC.</b></p> | <p>Client: American Electric Power<br/>                 Project: Dike Drilling<br/>                 Project No: 3050090131.07      Jax, FL</p> |
|---|--|

Checked By: *ZDR 11-18-09*

### Grain Size Distribution Report

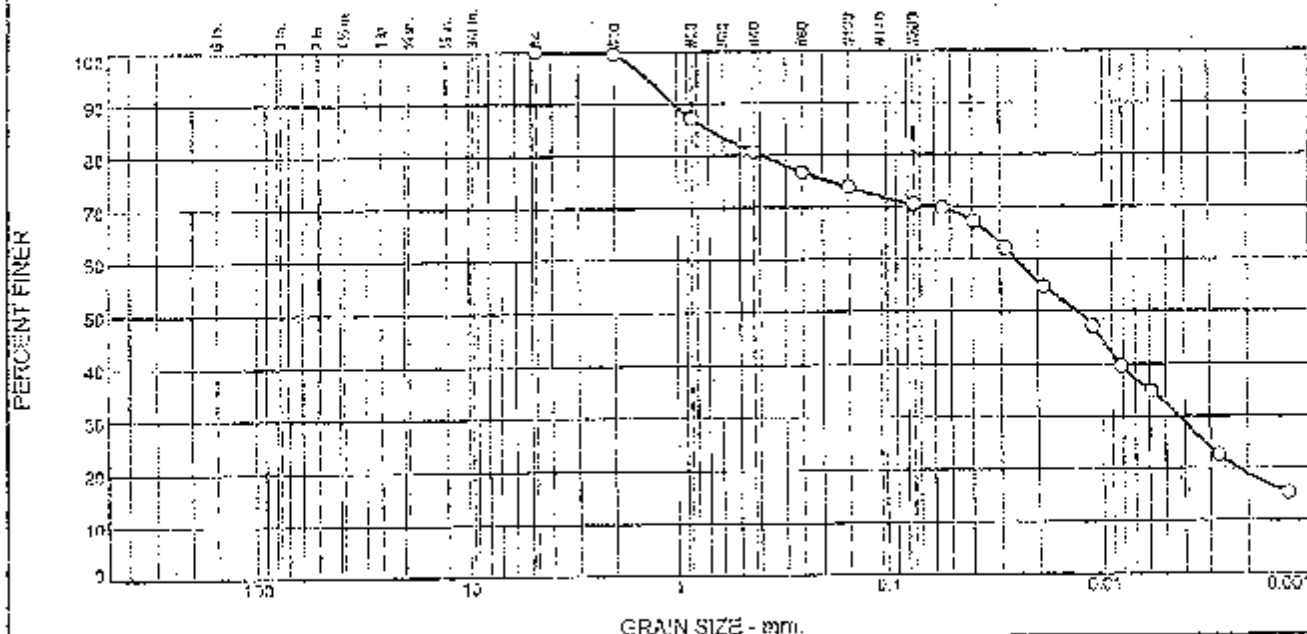

| % #20 | % Gravel |      | % Sand |        |      | % Fines |      |
|-------|----------|------|--------|--------|------|---------|------|
|       | Coarse   | Fine | Coarse | Medium | Fine | Silt    | Clay |
| 0.0   | 0.0      | 0.0  | 0.5    | 18.8   | 10.2 | 36.0    | 32.5 |

| TEST RESULTS (ASTM D 422) |               |                 |                |
|---------------------------|---------------|-----------------|----------------|
| Opening Size              | Percent Finer | Spec. (Percent) | Pass? (X=Fail) |
| #4                        | 100.0         |                 |                |
| #10                       | 99.5          |                 |                |
| #20                       | 87.2          |                 |                |
| #40                       | 80.7          |                 |                |
| #60                       | 76.7          |                 |                |
| #100                      | 73.8          |                 |                |
| #200                      | 71.5          |                 |                |
| 0.075 mm.                 | 69.7          |                 |                |
| 0.15 mm.                  | 67.2          |                 |                |
| 0.3 mm.                   | 62.2          |                 |                |
| 0.6 mm.                   | 54.7          |                 |                |
| 1.2 mm.                   | 47.2          |                 |                |
| 2.5 mm.                   | 39.6          |                 |                |
| 5.0 mm.                   | 34.6          |                 |                |
| 10.0 mm.                  | 22.7          |                 |                |
| 20.0 mm.                  | 15.5          |                 |                |

**Material Description**

Gray-brown sandy lean clay

**Atterberg Limits (ASTM D 4318)**

PL = 22      LL = 35      PI = 13

**Classification**

USCS (D 2487) = CL      AASHTO (M 145) = A-5(8)

**Coefficients**

$D_{60} = 1.0280$        $D_{45} = 0.7850$        $D_{30} = 0.6254$   
 $D_{50} = 0.8131$        $D_{30} = 0.0043$        $D_{10} =$   
 $D_{10} =$        $C_u =$        $C_c =$

Moisture Content: 16.8%

Remarks

---

Date Received: 10-15-09      Date Tested: 10-15-09

Tested By: EB

Checked By: Rajni Sukhrajani

Title: J

(no specification provided)

Source of Sample: B-0904      Depth: 47.8'-50.0'      Date Sampled:

Sample Number: 1D-10

|  |  |
|--|--|
| <b>MACTEC ENGINEERING AND CONSULTING, INC.</b> | Client: American Electric Power        |
|  | Project: Dits Drilling                 |
|  | Project No: 0050000131.02      Jax, FL |

Checked By: RDE 11-13-09

### Grain Size Distribution Report

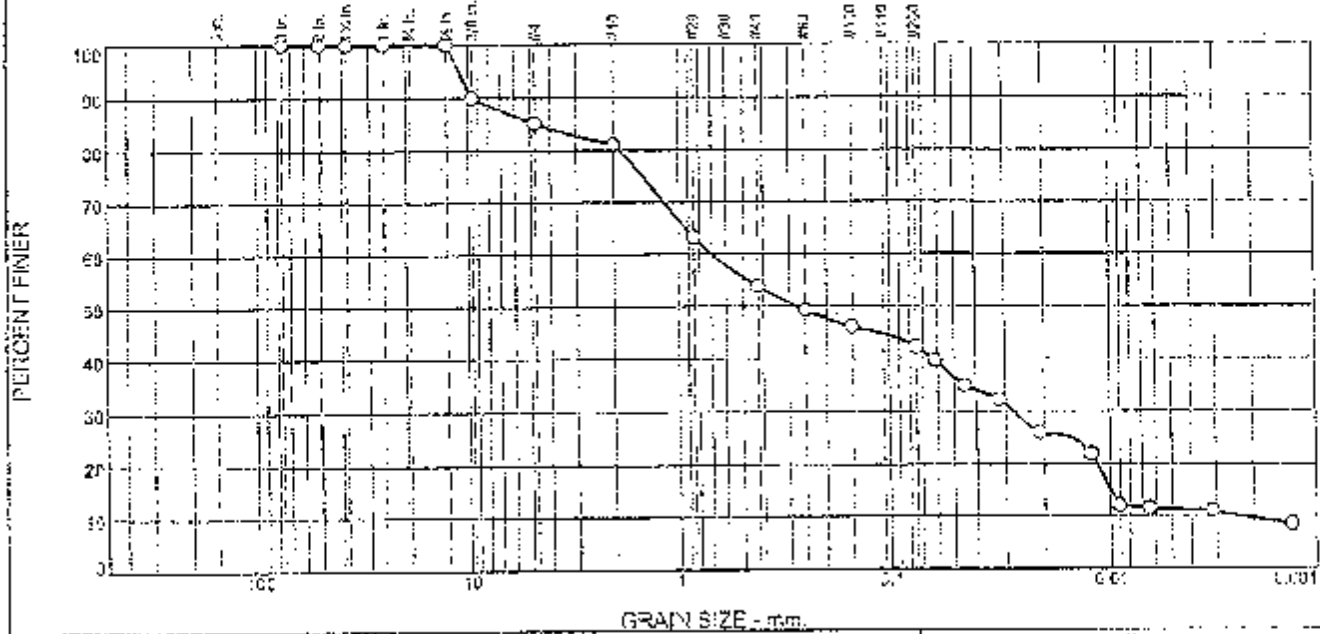

| % > 3" | % Gravel |      | % Sand |        |      | % Fines |      |
|--------|----------|------|--------|--------|------|---------|------|
|        | Coarse   | Fine | Coarse | Medium | Fine | Silt    | Clay |
| 0.0    | 0.0      | 4.9  | 4.0    | 27.2   | 11.7 | 30.9    | 11.3 |

| Opening Size | Percent Finer | Spec. (Percent) | Pass? (X=Fail) |
|--------------|---------------|-----------------|----------------|
| 3"           | 100.0         |                 |                |
| 2"           | 100.0         |                 |                |
| 1.5"         | 100.0         |                 |                |
| 1"           | 100.0         |                 |                |
| .75"         | 100.0         |                 |                |
| .6"          | 99.0          |                 |                |
| .5"          | 95.1          |                 |                |
| .425"        | 81.1          |                 |                |
| .375"        | 63.3          |                 |                |
| .3"          | 53.9          |                 |                |
| .25"         | 49.2          |                 |                |
| .20"         | 46.1          |                 |                |
| .15"         | 41.2          |                 |                |
| 0.075 mm     | 35.6          |                 |                |
| 0.0425 mm    | 30.9          |                 |                |
| 0.025 mm     | 22.2          |                 |                |
| 0.020 mm     | 26.1          |                 |                |
| 0.015 mm     | 27.1          |                 |                |
| 0.0075 mm    | 12.0          |                 |                |
| 0.004 mm     | 11.5          |                 |                |
| 0.0025 mm    | 11.7          |                 |                |
| 0.0015 mm    | 1.4           |                 |                |

(no specification provided)

**Material Description**

Brown clayey sand with gravel

**Atterberg Limits (ASTM D 4318)**

PL = 24      LL = 35      PI = 11

**Classification**

USCS (D 2487) = SC      AASHTO (M 145) = A-5(1)

**Coefficients**

D<sub>90</sub> = 9.5420      D<sub>85</sub> = 4.6338      D<sub>60</sub> = 0.7934  
 D<sub>50</sub> = 0.2702      D<sub>30</sub> = 0.0276      D<sub>15</sub> = 0.0180  
 D<sub>10</sub> = 0.0524      C<sub>u</sub> = 295.45      C<sub>c</sub> = 0.65

**Remarks**

Moisture content: 15.5%

---

Date Received: 10-14-09      Date Tested: 10-18-09

Tested By: PK

Checked By: Rajni Sukhwani

Title: \_\_\_\_\_

Source of Sample: E-0905      Depth: 12.0-14.0'      Date Sampled: \_\_\_\_\_  
 Sample Number: 10-1

|  |   |                                     |
|--|---|-------------------------------------|
| <b>MACTEC ENGINEERING AND CONSULTING, INC.</b> | Client: American Electric Power<br>Project: Dike Drilling | Project No: 3080298131-02<br>Jax FL |
|--|---|-------------------------------------|

Checked By: RDR 11-13-09



**MACTEC ENGINEERING AND CONSULTING, INC**  
 22010 Commerce Drive  
 Arlington, Virginia 22211  
 (703) 676-0426

Project Name: AFT Dike Drilling  
 Project Number: 3050-09-0131  
 Report Date: 11/09/09

**Washed Particle Size/Gradation Test Report**

**ASTM D422**

Sample Number: UD-3 Location: B-0905A

Percent Finer than No. 200: **12.7** % (from washing)

| Sieve Size    | Cumulative (g) | Wt. Retained Each Sieve (g) | Cumulative % Passing | Cumulative % Finer w/ Wash 200 |
|---------------|----------------|-----------------------------|----------------------|--------------------------------|
| 1 in.         | 3.03           | 0.00                        | 100.0                | 100.0                          |
| 3/4 in.       | 3.03           | 0.00                        | 100.0                | 100.0                          |
| 3/8 in.       | 34.46          | 34.46                       | 96.1                 | 96.1                           |
| # 20          | 129.31         | 94.85                       | 87.2                 | 87.2                           |
| # 40          | 370.59         | 241.24                      | 63.3                 | 63.3                           |
| # 60          | 546.13         | 175.58                      | 45.8                 | 45.8                           |
| # 100         | 663.38         | 117.25                      | 25.4                 | 25.4                           |
| # 200         | 732.04         | 68.66                       | 11.7                 | 11.7                           |
| # 425         | 805.38         | 73.34                       | 9.4                  | 9.4                            |
| # 600         | 881.92         | 76.54                       | 8.8                  | 8.8                            |
| PAN           | 885.05         | 7.14                        |                      |                                |
| Wt. of Solids | 1310.15        |                             |                      |                                |

**Particle Size Analysis**

U.S. Standard Sieve Sizes

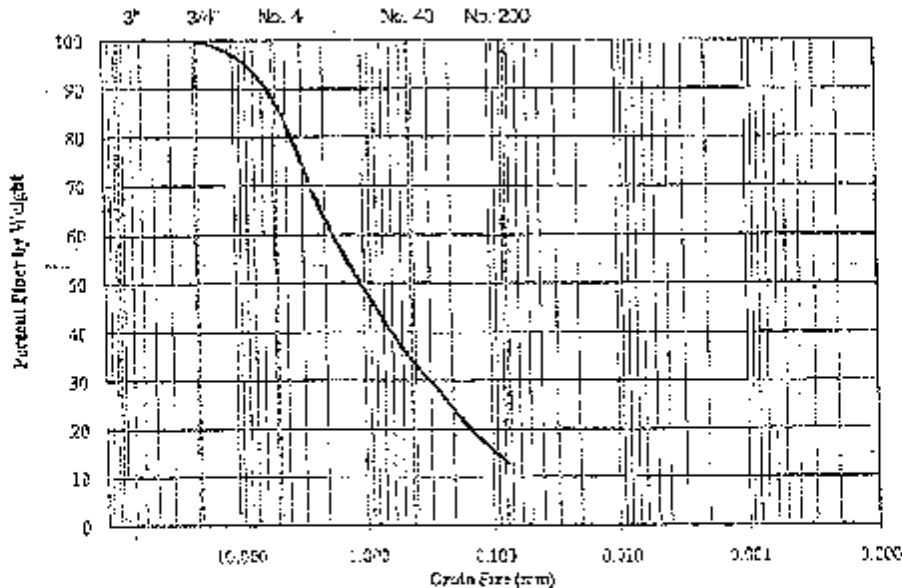

Performed By: NCH 11-11-09

Checked By: RDP 11-11-09

2-0905A UD-3, 3/09

US EPA ARCHIVE DOCUMENT



MACTEC ENGINEERING AND CONSULTING, INC.  
22110 Commerce Drive  
Arlington, VA 22211

Sieve Analysis Test Report  
Hydrometer/Sieve  
ASTM D422

Project Name: AEP Dike Drilling  
Project Number: SC50-19-0131  
Report Date: 11/9/09  
Sample Number: 9-CE05A UD-3

Sieve and Hydrometer

| Particle Size             | Units | Cumulative<br>Wt. Retained<br>(%) | Wt. Retained<br>(g) | Cumulative<br>% Passing |
|---------------------------|-------|-----------------------------------|---------------------|-------------------------|
| 25.0                      | mm    | 0.00                              | 0.0                 | 100.0                   |
| 15.0                      | mm    | 0.00                              | 0.0                 | 100.0                   |
| 9.5                       | mm    | 34.45                             | 34.5                | 65.5                    |
| 4.75                      | mm    | 128.01                            | 128.0               | 71.5                    |
| 2.0                       | mm    | 373.32                            | 373.2               | 83.5                    |
| 80                        | um    | 543.12                            | 543.0               | 49.5                    |
| 425                       | um    | 865.33                            | 865.3               | 34.5                    |
| 250                       | um    | 973.64                            | 973.7               | 27.5                    |
| 150                       | um    | 1016.33                           | 1016.3              | 20.5                    |
| 75                        | um    | 1081.32                           | 1081.3              | 12.5                    |
| 60                        | um    | 1095.33                           | 1095.3              | 12.0                    |
| 48                        | um    | 1105.33                           | 1105.3              | 7.5                     |
| 38                        | um    | 1115.33                           | 1115.3              | 5.7                     |
| 30                        | um    | 1125.33                           | 1125.3              | 3.5                     |
| 25                        | um    | 1135.33                           | 1135.3              | 2.2                     |
| 20                        | um    | 1145.33                           | 1145.3              | 1.5                     |
| 15                        | um    | 1155.33                           | 1155.3              | 1.3                     |
| 12                        | um    | 1165.33                           | 1165.3              | 0.6                     |
| 7.5                       | um    | 1175.33                           | 1175.3              | 0.0                     |
| Wt. of Sol <sup>n</sup> g |       | 1019.43                           |                     |                         |

Particle Size Analysis  
U.S. Standard Sieve Sizes  
No. 40 No. 200

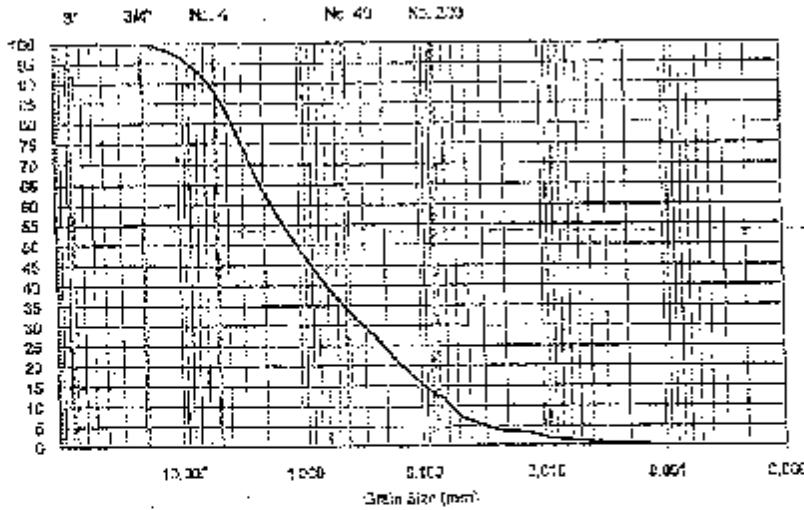

Performed by: NCH 11-11-09  
Checked by: MDR 11-11-09

DSC010-13 Hydrometer

### Grain Size Distribution Report

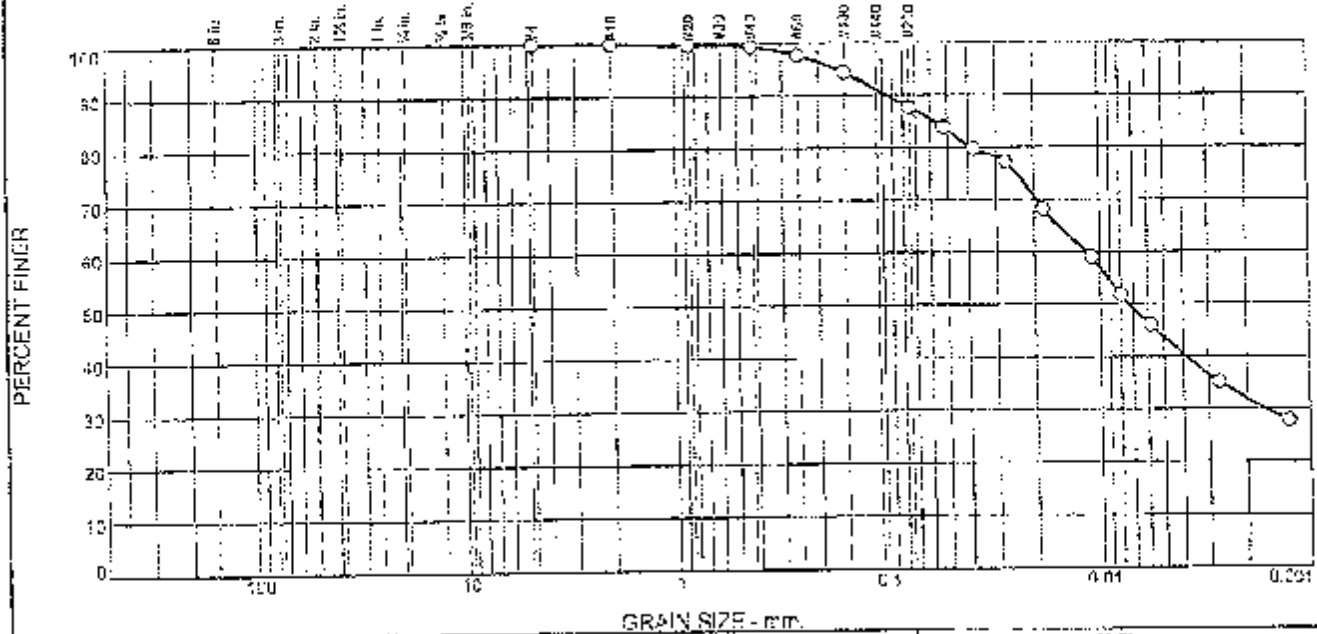

| % > 3" | % Gravel |      | % Sand |        |      | % Fines |      |
|--------|----------|------|--------|--------|------|---------|------|
|        | Coarse   | Fine | Coarse | Medium | Fine | Silt    | Clay |
| 0.0    | 0.0      | 0.0  | 0.0    | 0.6    | 11.7 | 43.0    | 42.3 |

| TEST RESULTS (ASTM D 422) |               |                 |                |
|---------------------------|---------------|-----------------|----------------|
| Opening Size              | Percent Finer | Spec. (Percent) | Pass? (X=Fail) |
| #4                        | 100.0         |                 |                |
| #10                       | 100.0         |                 |                |
| #20                       | 99.7          |                 |                |
| #40                       | 95.4          |                 |                |
| #60                       | 97.7          |                 |                |
| #100                      | 94.5          |                 |                |
| #200                      | 87.7          |                 |                |
| 0.075 mm                  | 83.8          |                 |                |
| 0.075 mm                  | 79.7          |                 |                |
| 0.075 mm                  | 77.2          |                 |                |
| 0.075 mm                  | 68.2          |                 |                |
| 0.075 mm                  | 59.0          |                 |                |
| 0.075 mm                  | 51.7          |                 |                |
| 0.075 mm                  | 46.0          |                 |                |
| 0.075 mm                  | 35.1          |                 |                |
| 0.075 mm                  | 27.8          |                 |                |

Material Description

Gray and brown lean clay

Atterberg Limits (ASTM D 4318)

PL= 25      LL= 46      PI= 21

Classification

USCS (D 2487)= CL      AASHTO (M 145)= A-7-6(2/)

Coefficients

D<sub>50</sub>= 0.0950      D<sub>60</sub>= 0.0572      D<sub>10</sub>= 0.0114  
 D<sub>80</sub>= 0.0075      D<sub>70</sub>= 0.0016      D<sub>15</sub>=  
 D<sub>10</sub>=      C<sub>u</sub>=      C<sub>c</sub>=

Remarks

Moisture Content: 31.9%

---

Date Received: 10-15-09      Date Tested: 10-15-09

Tested By: RS

Checked By: Pamela J. Johnson

Title: \_\_\_\_\_

Source of Sample: B-0905      Depth: 22.0'-24.0'      Date Sampled: \_\_\_\_\_  
 Sample Number: U22

|  |                                 |
|--|---------------------------------|
| <b>MACTEC ENGINEERING AND CONSULTING, INC.</b> | Client: American Electric Power |
|  | Project: Dike Drilling          |
| Project No: 303090131.01                       | Jax, FL                         |

Checked By: RDR 11-13-09



**MACTEC ENGINEERING AND CONSULTING, INC**  
 22010 Commerce Drive  
 Abingdon, Virginia 24211  
 (276) 676-0426

Project Name: **ASP Dike Drilling**  
 Project Number: **3050-09-0231**  
 Report Date: **11/09/09**

**Washed Particle Size/Gradation Test Report**

**ASTM D422**

Sample Number: **UD-13** Location: **B-0908**

Percent Finer than No. 200: **10.3** % (from washing)

| Sieve Size     | Cumulative (g) | Wt. Retained Each Sieve (g) | Cumulative % Passing | Cumulative % Passing w/ Wash 200 |
|----------------|----------------|-----------------------------|----------------------|----------------------------------|
| 1 in.          | 5.00           | 0.00                        | 100.0                | 100.0                            |
| 3/4 in.        | 0.00           | 0.00                        | 100.0                | 100.0                            |
| 3/8 in.        | 13.17          | 13.17                       | 85.9                 | 91.0                             |
| # 4            | 26.64          | 13.49                       | 69.5                 | 94.0                             |
| # 10           | 44.64          | 17.98                       | 49.0                 | 89.9                             |
| # 20           | 60.72          | 16.08                       | 30.6                 | 85.3                             |
| # 40           | 72.45          | 11.73                       | 17.2                 | 83.7                             |
| # 60           | 78.74          | 6.29                        | 10.1                 | 82.3                             |
| # 100          | 83.09          | 4.35                        | 5.1                  | 81.3                             |
| #200           | 87.26          | 4.17                        | 0.3                  | 80.3                             |
| FAN            | 87.34          | 0.08                        |                      |                                  |
| Wt. of Soil, g | 444.85         |                             |                      |                                  |

**Particle Size Analysis**  
 U.S. Standard Sieve Sizes

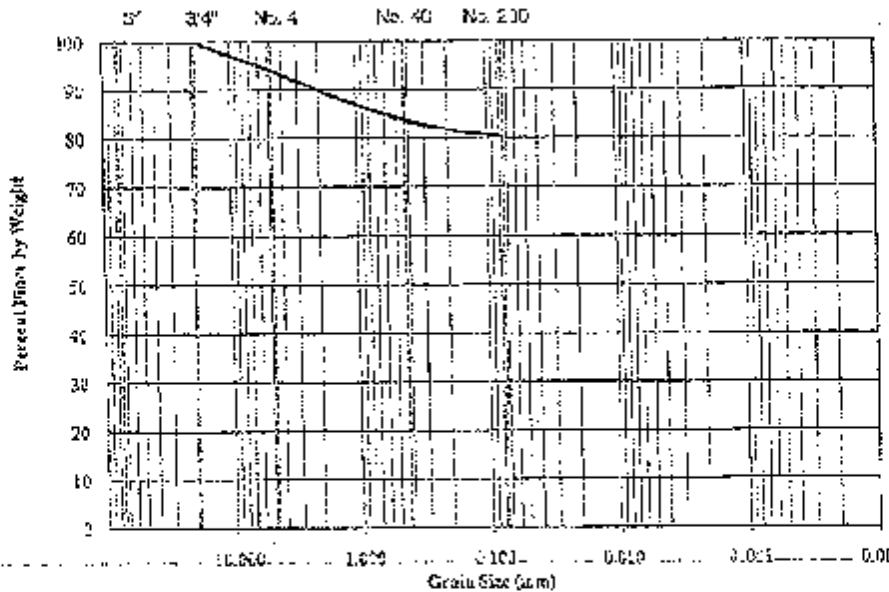

Performed By: NGH 11-11-09

Checked By: RDR 11-11-09 90528, US18, Sieve

US EPA ARCHIVE DOCUMENT

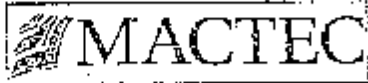

MACTEC ENGINEERING AND CONSULTING, INC.  
 22010 Commerce Drive  
 Abingdon, VA 24211

Sieve Analysis Test Report  
 Hydrometer/Sieve  
 ASTM D422

Project Name: ACP Dike Drilling  
 Project Number: 3050-06-0131  
 Report Date: 11/9/2009  
 Sample Number: 3-0508 UD-13

Sieve and Hydrometer

| Particle Size   | Unit | Cumulative Wt. Retained |                |                      |
|-----------------|------|-------------------------|----------------|----------------------|
|                 |      | Wt. Retained (g)        | Each Sieve (g) | Cumulative % Passing |
| 25.0            | mm   | 4.03                    | 3.0            | 100.0                |
| 18.0            | mm   | 3.09                    | 3.0            | 100.0                |
| 3.0             | mm   | 13.17                   | 13.2           | 97.3                 |
| 4.8             | mm   | 30.66                   | 15.5           | 94.0                 |
| 3.0             | mm   | 44.64                   | 18.0           | 89.9                 |
| 150             | um   | 117.21                  | 16.1           | 88.3                 |
| 425             | um   | 124.45                  | 11.7           | 83.7                 |
| 250             | um   | 136.74                  | 6.3            | 82.3                 |
| 150             | um   | 143.09                  | 4.4            | 81.3                 |
| 75              | um   | 147.28                  | 4.2            | 80.3                 |
| 60              | um   | 148.28                  | 3.0            | 74.7                 |
| 37              | um   | 154.27                  | 3.0            | 75.3                 |
| 28              | um   | 156.28                  | 3.0            | 71.9                 |
| 17              | um   | 157.28                  | 3.0            | 67.9                 |
| 10              | um   | 157.28                  | 3.0            | 60.0                 |
| 7.5             | um   | 157.28                  | 3.0            | 56.7                 |
| 5.3             | um   | 157.28                  | 3.0            | 43.8                 |
| 3.0             | um   | 157.28                  | 3.0            | 36.7                 |
| 1.5             | um   | 157.28                  | 3.0            | 23.6                 |
| Wt. of Sol. (g) |      | 244.60                  |                |                      |

Particle Size Analysis  
 U.S. Standard Sieve Sizes

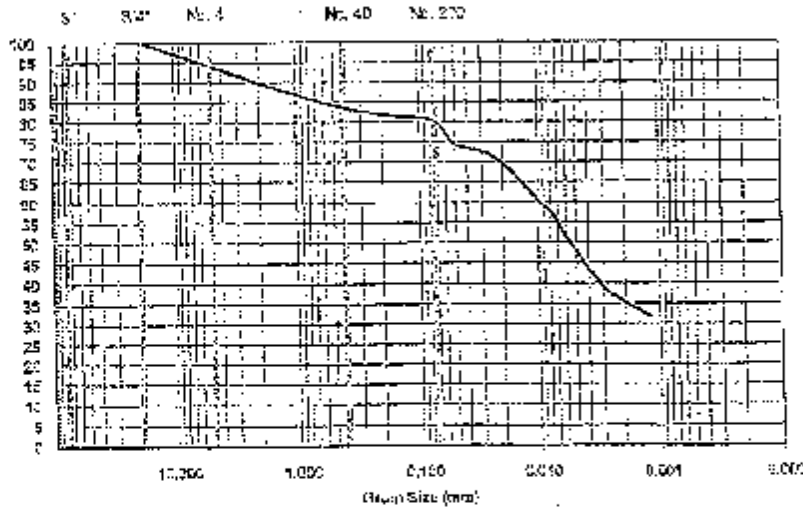

Performed by: NCH 11-11-09  
 Checked by: ROR 11-11-09

D-3030 UD-13 Hydrometer



## Grain Size Distribution Report

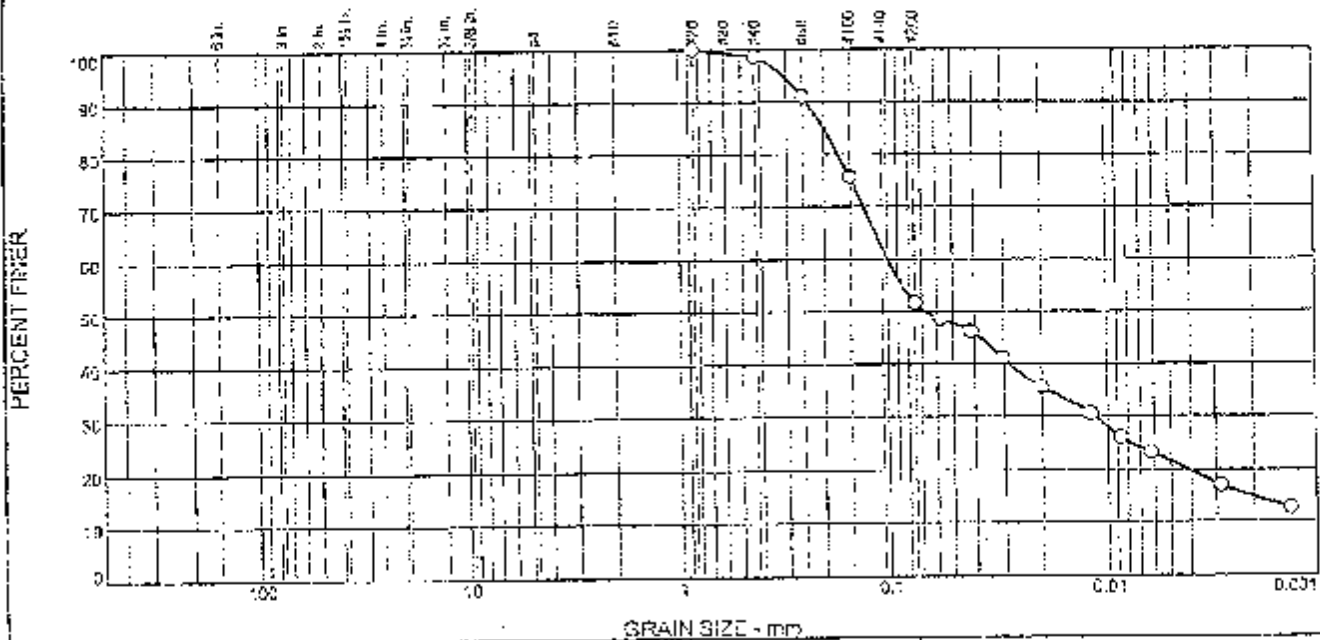

| % +2" | % Gravel |      | % Sand |        |      | % Fines |      |
|-------|----------|------|--------|--------|------|---------|------|
|       | Coarse   | Fine | Coarse | Medium | Fine | Silt    | Clay |
| 0.0   | 3.6      | 0.0  | 0.0    | 1.2    | 47.2 | 29.9    | 21.7 |

### TEST RESULTS (ASTM D 422)

| Opening Size | Percent Finer | Spec. (Percent) | Pass? (X=Fail) |
|--------------|---------------|-----------------|----------------|
| #20          | 100.0         |                 |                |
| #40          | 99.5          |                 |                |
| #60          | 71.1          |                 |                |
| #100         | 75.6          |                 |                |
| #200         | 51.2          |                 |                |
| 0.075 mm.    | 48.4          |                 |                |
| 0.150 mm.    | 46.2          |                 |                |
| 0.300 mm.    | 41.1          |                 |                |
| 0.600 mm.    | 35.5          |                 |                |
| 1.18 mm.     | 30.5          |                 |                |
| 2.0 mm.      | 25.1          |                 |                |
| 4.75 mm.     | 23.4          |                 |                |
| 9.5 mm.      | 17.1          |                 |                |
| 19.0 mm.     | 12.5          |                 |                |

(No specification provided)

### Material Description

Gray brown lean CLAY with sand

### Atterberg Limits (ASTM D 4318)

PL = \_\_\_\_\_ LL = \_\_\_\_\_ PI = \_\_\_\_\_  
 USCS (D 2487) = **CL** AASHTO (M 145) = \_\_\_\_\_

### Coefficients

D<sub>50</sub> = 0.2357 D<sub>60</sub> = 0.1981 D<sub>90</sub> = 0.1022  
 F<sub>50</sub> = 0.0519 F<sub>60</sub> = 3.0115 F<sub>90</sub> = 9.0621  
 C<sub>u</sub> = \_\_\_\_\_ C<sub>c</sub> = \_\_\_\_\_

### Remarks

Moisture Content: 23.8%

Date Received: 10-15-09 Date Tested: 10-15-09

Tested By: FB

Checked By: *Loni Johnson*

Title: \_\_\_\_\_

Date Sampled: \_\_\_\_\_

Source of Sample: B-0905  
 Sample Number: D-16

**MACTEC ENGINEERING AND CONSULTING, INC.**

Client: American Electric Power  
 Project: Dike Drilling

Project No: 305090131.02

Jax FL

Checked By: *PDR 11-13-09*

## Grain Size Distribution Report

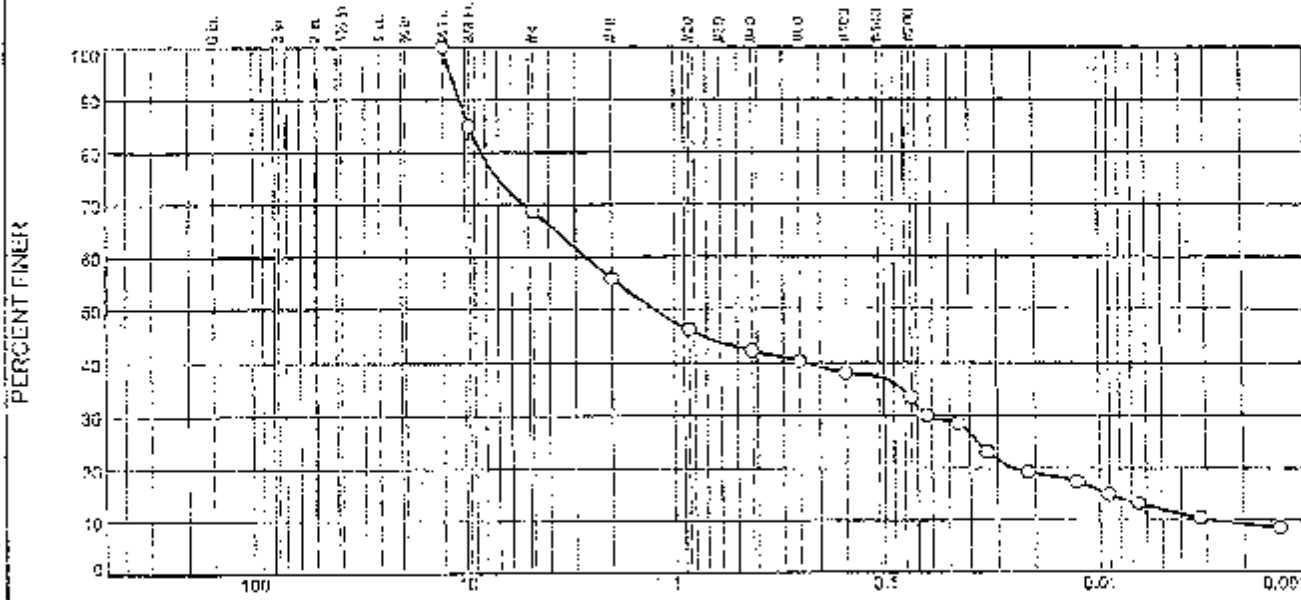

GRAIN SIZE - mm

| % 48" | % Gravel |      | % Sand |        |      | % Finer |      |
|-------|----------|------|--------|--------|------|---------|------|
|       | Coarse   | Fine | Coarse | Medium | Fine | Silt    | Clay |
| 0.0   | 0.0      | 31.3 | 12.8   | 15.7   | 9.7  | 21.4    | 12.1 |

| TEST RESULTS (ASTM D 422) |               |                 |                |
|---------------------------|---------------|-----------------|----------------|
| Opening Size              | Percent Finer | Spec. (Percent) | Pass? (X=Fail) |
| 1 1/2"                    | 100.0         |                 |                |
| 3/8"                      | 75.0          |                 |                |
| #4                        | 68.7          |                 |                |
| #10                       | 55.9          |                 |                |
| #20                       | 46.1          |                 |                |
| #40                       | 42.2          |                 |                |
| #60                       | 40.3          |                 |                |
| #100                      | 35.1          |                 |                |
| #200                      | 33.5          |                 |                |
| 0.063 mm                  | 30.0          |                 |                |
| 0.045 mm                  | 28.5          |                 |                |
| 0.030 mm                  | 23.2          |                 |                |
| 0.021 mm                  | 19.3          |                 |                |
| 0.015 mm                  | 17.4          |                 |                |
| 0.009 mm                  | 15.0          |                 |                |
| 0.006 mm                  | 13.2          |                 |                |
| 0.003 mm                  | 10.4          |                 |                |
| 0.001 mm                  | 8.5           |                 |                |

(no specification provided)

| Material Description             |  |
|----------------------------------|--|
| Brown clayey sand with gravel    |  |
| Atterberg Limits (ASTM D 4310)   |  |
| PL = 30                          | LL = 32      PI = 12                                   |
| Classification                   |  |
| USCS (D 2487) = SC               | AASHTO (M 149) = A-2-5(0)                              |
| Coefficients                     |  |
| D <sub>60</sub> = 10.3802        | D <sub>30</sub> = 0.5286      D <sub>15</sub> = 2.6520 |
| D <sub>50</sub> = 1.2417         | D <sub>10</sub> = 0.0631      D <sub>5</sub> = 0.0090  |
| D <sub>10</sub> = 0.0028         | C <sub>u</sub> = 950.65      C <sub>c</sub> = 0.54     |
| Remarks                          |  |
| Moisture content 14.1%           |  |
| Date Received: 10-15-09          | Date Tested: 10-15-09                                  |
| Tested By: [Signature]           |  |
| Checked By: <i>Rami Luberman</i> |  |
| Title: _____                     |  |

Source of Sample: R-0908A  
Sample Number: L2-2

Date Sampled:

**MACTEC ENGINEERING,  
AND CONSULTING, INC.**

Client: American Electric Power  
Project: Dike Drilling  
Project No: 005092013102

Jax FL

Checked By: *RDR 11-13-09*

## Grain Size Distribution Report

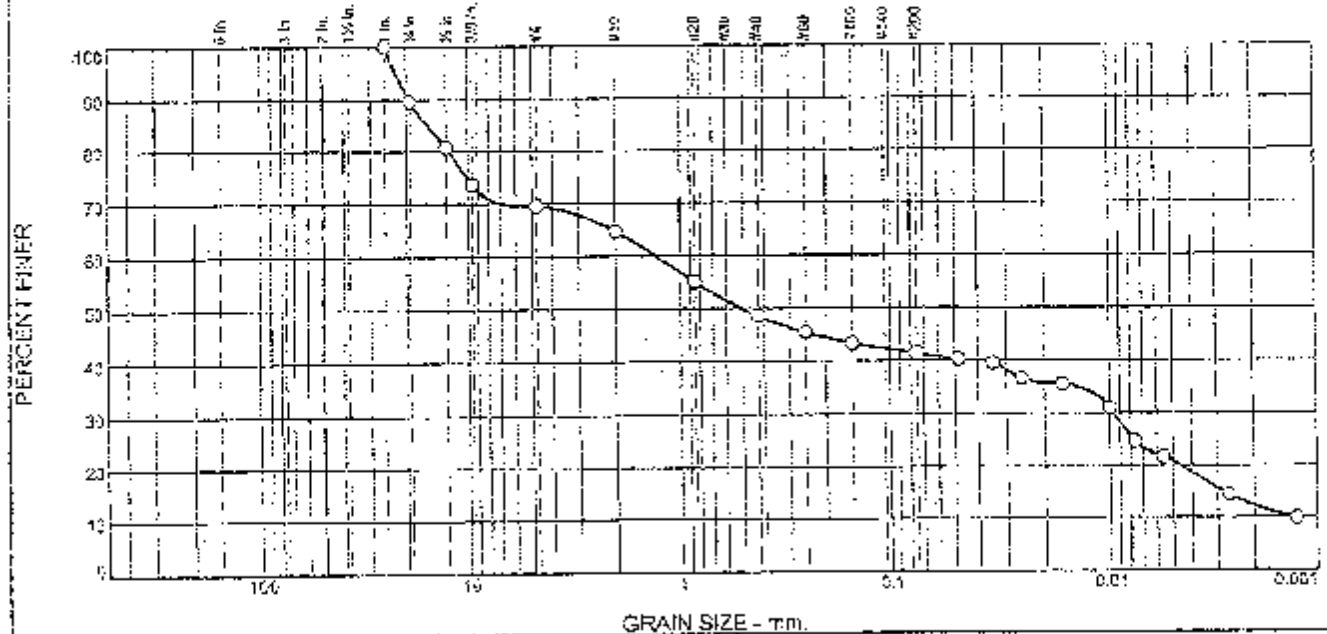

| % +3" | % Gravel |      | % Sand |        |      | % Fines |      |
|-------|----------|------|--------|--------|------|---------|------|
|       | Coarse   | Fine | Coarse | Medium | Fine | Silt    | Clay |
| 0.0   | 10.4     | 20.1 | 4.9    | 16.1   | 7.1  | 20.5    | 20.5 |

| TEST RESULTS (ASTM D 422) |               |                 |                |
|---------------------------|---------------|-----------------|----------------|
| Opening Size              | Percent Finer | Spec. (Percent) | Pass? (X=Fail) |
| 1"                        | 100.0         |                 |                |
| 3/4"                      | 89.6          |                 |                |
| 1/2"                      | 80.7          |                 |                |
| 3/8"                      | 73.6          |                 |                |
| #4                        | 69.3          |                 |                |
| #10                       | 64.6          |                 |                |
| #20                       | 55.0          |                 |                |
| #40                       | 48.5          |                 |                |
| #60                       | 45.5          |                 |                |
| #100                      | 43.3          |                 |                |
| #200                      | 43.4          |                 |                |
| 0.0475 mm.                | 40.4          |                 |                |
| 0.0343 mm.                | 39.6          |                 |                |
| 0.0250 mm.                | 36.6          |                 |                |
| 0.0180 mm.                | 35.5          |                 |                |
| 0.0150 mm.                | 31.0          |                 |                |
| 0.0075 mm.                | 24.7          |                 |                |
| 0.0055 mm.                | 21.7          |                 |                |
| 0.0026 mm.                | 14.4          |                 |                |
| 0.0019 mm.                | 9.9           |                 |                |

**Material Description**

Clayey silty gravel with sand

**Atterberg Limits (ASTM D 4318)**

PL= 25      LL= 35      PI= 10

**Classification**

USCS (D 2487)= GM      AASHTO (M 145)= A-4(1)

**Coefficients**

D<sub>90</sub>= 19.3229      D<sub>65</sub>= 15.0615      C<sub>60</sub>= 1.3088  
D<sub>50</sub>= 0.5131      D<sub>30</sub>= 0.0095      L<sub>15</sub>= 0.0020  
D<sub>10</sub>= 0.0013      C<sub>u</sub>= 1620.02      C<sub>c</sub>= 9.35

**Remarks**

Moisture Content: 17.3%

---

Date Received: 10-21-03      Date Tested: 10-21-03

Tested By: RS

Checked By: \_\_\_\_\_

Title: \_\_\_\_\_

Source of Sample: B-0909      Depth: 11.5'-13.5'      Date Sampled: \_\_\_\_\_  
Sample Number: UT-3

|  |                                 |
|--|---------------------------------|
| <b>MACTEC ENGINEERING AND CONSULTING, INC.</b> | Client: American Electric Power |
|  | Project: Dike Drilling          |
|  | Project No.: 005089/131/02      |
|  | Jay FL                          |

Checked By: Rajni Sukhmani



22010 Commerce Drive  
 Abingdon, Va. 24211  
 (276) 676-0426  
 (276) 676-0781

Moisture Content, %

Project Name: Aes Dike Drilling  
 Project Number: 305C-08-0131  
 Date: 11/9/2009

|                |        |        |        |        |        |        |
|----------------|--------|--------|--------|--------|--------|--------|
| Boring #       | B-0901 | B-0904 | B-0905 | B-0908 | B-0908 | B-0908 |
| Sample #       | UD-6   | UD-15  | UD-1   | UD-8   | UD-13  | UD-15  |
| Depth          |        |        |        |        |        |        |
| Tare + Wet     | 111.35 | 232.49 | 189.20 | 272.70 | 315.70 | 222.60 |
| Tare + Dry     | 93.70  | 166.22 | 103.05 | 239.14 | 261.45 | 178.53 |
| Water (w/w)    | 17.65  | 66.27  | 86.15  | 33.56  | 54.25  | 44.07  |
| Tare           | 8.13   | 7.97   | 8.20   | 8.44   | 8.38   | 8.38   |
| Dry Soil (w/s) | 85.57  | 158.25 | 94.85  | 230.70 | 253.07 | 168.15 |
| Moisture, %    | 16.5   | 26.6   | 16.9   | 14.5   | 21.4   | 27.4   |

|                |  |  |  |  |  |  |
|----------------|--|--|--|--|--|--|
| Boring #       |  |  |  |  |  |  |
| Sample #       |  |  |  |  |  |  |
| Depth          |  |  |  |  |  |  |
| Tare + Wet     |  |  |  |  |  |  |
| Tare + Dry     |  |  |  |  |  |  |
| Water (w/w)    |  |  |  |  |  |  |
| Tare           |  |  |  |  |  |  |
| Dry Soil (w/s) |  |  |  |  |  |  |
| Moisture, %    |  |  |  |  |  |  |

|                |  |  |  |  |  |  |
|----------------|--|--|--|--|--|--|
| Boring #       |  |  |  |  |  |  |
| Sample #       |  |  |  |  |  |  |
| Depth          |  |  |  |  |  |  |
| Tare + Wet     |  |  |  |  |  |  |
| Tare + Dry     |  |  |  |  |  |  |
| Water (w/w)    |  |  |  |  |  |  |
| Tare           |  |  |  |  |  |  |
| Dry Soil (w/s) |  |  |  |  |  |  |
| Moisture, %    |  |  |  |  |  |  |

|                |  |  |  |  |  |  |
|----------------|--|--|--|--|--|--|
| Boring #       |  |  |  |  |  |  |
| Sample #       |  |  |  |  |  |  |
| Depth          |  |  |  |  |  |  |
| Tare + Wet     |  |  |  |  |  |  |
| Tare + Dry     |  |  |  |  |  |  |
| Water (w/w)    |  |  |  |  |  |  |
| Tare           |  |  |  |  |  |  |
| Dry Soil (w/s) |  |  |  |  |  |  |
| Moisture, %    |  |  |  |  |  |  |

Performed By: NCH 11-13-09 Checked By: RDF 11-9-09

US EPA ARCHIVE DOCUMENT



REPORT OF SOIL PERMEABILITY TESTING

Project: AEP Dike Drilling

Project Number: 3050-03-0131.02

Client: AEP

Date Completed: October 22, 2009

Sample Number: B-0904 UD-5

Sample Information:

|                   |      |                      |      |                   |       |
|-------------------|------|----------------------|------|-------------------|-------|
| Dia. (in.)        | 4.00 | Length (in)          | 2.84 | Weight (gr)       | 604.3 |
| Wet Density (pcf) | 64.6 | Moisture Content (%) | 16.0 | Dry Density (pcf) | 54.7  |

Test Parameters

|                                    |                       |                                    |               |
|------------------------------------|-----------------------|------------------------------------|---------------|
| Test Method Used:                  | ASTM D-5084, method A | Permeant Fluid:                    | Deaired water |
| Maximum Hydraulic Gradient:        | 2.9                   | Minimum Hydraulic Gradient:        | 1.3           |
| Maximum Consolidation Stress (psi) | 5                     | Minimum Consolidation Stress (psi) | 5             |

Permeability Rate

5.8E-04

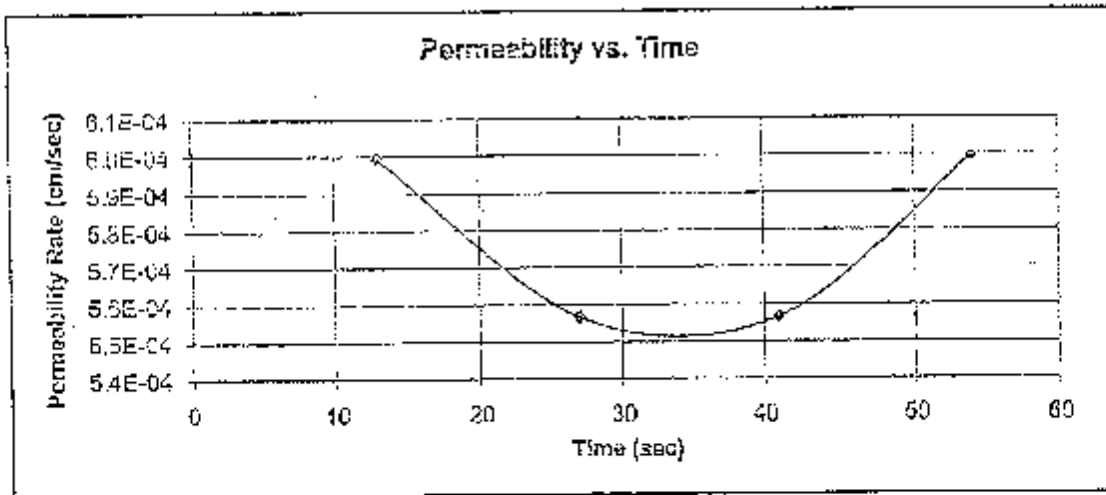

Reviewed By:

*Rajni Sukhram*

MACTEC Engineering and Consulting, Inc.  
3901 Garnichael Avenue  
Jacksonville, Florida

US EPA ARCHIVE DOCUMENT



REPORT OF SOIL PERMEABILITY TESTING

Project: AEP Dike Drilling

Project Number: 3350-03-0131.02

Client: AEP

Date Completed: October 22, 2003

Sample Number: B-3904 JD-3

Sample Information:

|                   |       |                      |      |                   |       |
|-------------------|-------|----------------------|------|-------------------|-------|
| Dia. (in.)        | 2.84  | Length (in)          | 3.86 | Weight (gr)       | 898.6 |
| Wet Density (pcf) | 151.0 | Moisture Content (%) | 11.5 | Dry Density (pcf) | 117.4 |

Test Parameters

|                                    |                       |                                    |                |
|------------------------------------|-----------------------|------------------------------------|----------------|
| Test Method Used:                  | ASTM D-5084, method A | Permeant Fluid:                    | De-aired water |
| Maximum Hydraulic Gradient:        | 15.5                  | Minimum Hydraulic Gradient         | 3.3            |
| Maximum Consolidation Stress (psi) | 5                     | Minimum Consolidation Stress (psi) | 5              |

Permeability Rate

2.9E-05

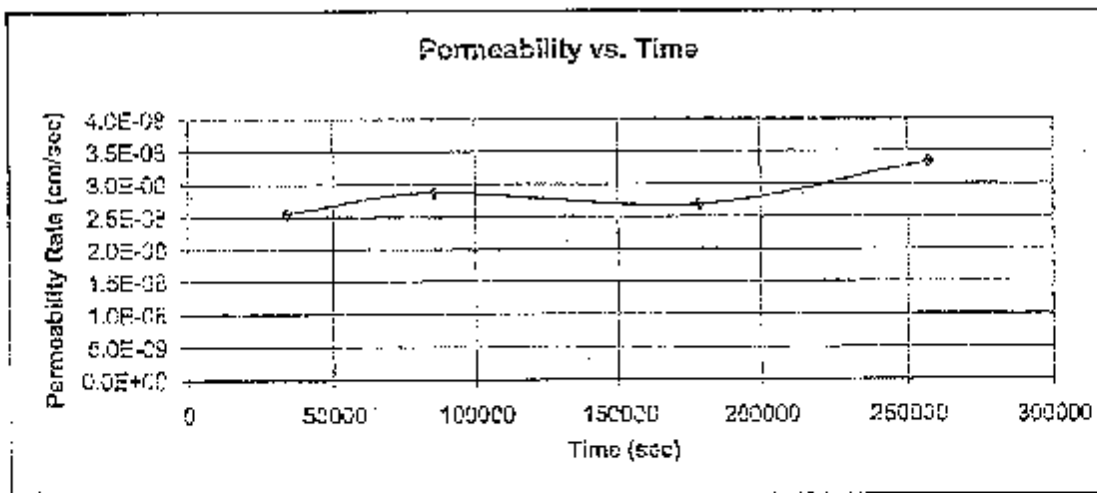

Reviewed By:

*Rajni Subhramani*

MACTEC Engineering and Consulting, Inc.  
3901 Carmichael Avenue  
Jacksonville, Florida



REPORT OF SOIL PERMEABILITY TESTING

Project: AEP Dike Drilling

Project Number: 3050-09-0131.02

Client: AEP

Date Completed: October 22, 2009

Sample Number: B-0908 UD-16

Sample Information:

|                   |       |                      |      |                   |       |
|-------------------|-------|----------------------|------|-------------------|-------|
| Dia. (in.)        | 2.85  | Length (in)          | 4.56 | Weight (gr)       | 939.1 |
| Wet Density (pcf) | 123.2 | Moisture Content (%) | 23.8 | Dry Density (pcf) | 99.5  |

Test Parameters

|                                    |                       |                                    |                |
|------------------------------------|-----------------------|------------------------------------|----------------|
| Test Method Used:                  | ASTM D-5024, method A | Permeant Fluid:                    | De-aired water |
| Maximum Hydraulic Gradient:        | 1.9                   | Minimum Hydraulic Gradient         | 0.9            |
| Maximum Consolidation Stress (psi) | 5                     | Minimum Consolidation Stress (psi) | 5              |

Permeability Rate

1.8E-07

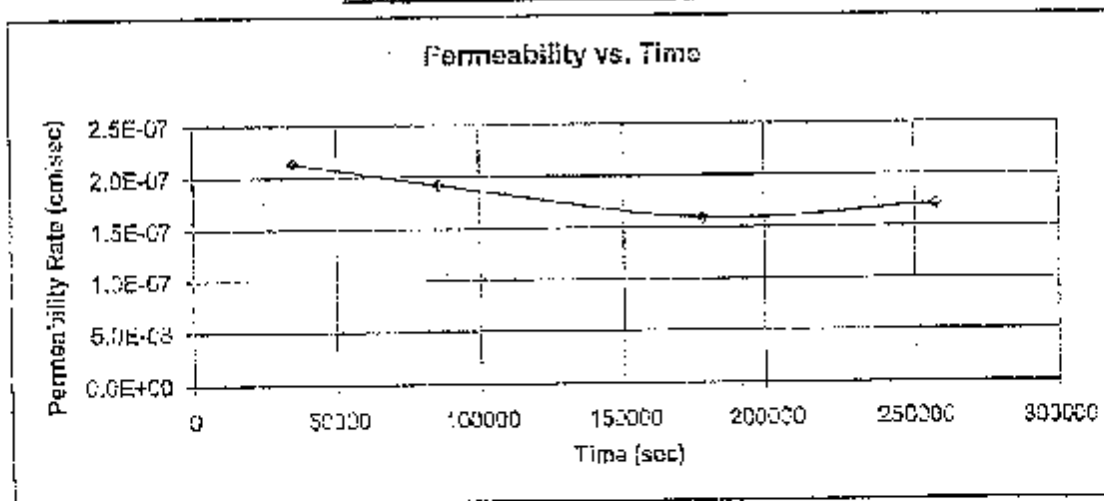

Reviewed By:

*Rajni Sukhwan*  
Rajni Sukhwan, EIT

MACTEC Engineering and Consulting, Inc  
3901 Carmichael Avenue  
Jacksonville, Florida



# MACTEC

22210 Commerce Drive  
 Alexandria, Virginia 22211  
 Telephone: 276-875-0626 ~ Facsimile: 276-875-0761

Project Name: AEP Dike Drilling  
 Project Number: 3050-09-0131  
 Report Date: 11/09/09

Soil Description: Yellowish Brown Silty SAND (SM)  
 10% S/M

Atterberg Limits AASHTO T90-00 (2004)  
 (Three Points)

Sample Number: B-0901  
 Depth (ft): UD-6 21.0' - 24.0'

| Blows | % Moisture |
|-------|------------|
| 35    | 28.8       |
| 27    | 31.0       |
| 20    | 32.6       |

| Liquid Limit | Plastic Limit | Plasticity Index |
|--------------|---------------|------------------|
| 31           | 24            | 7                |

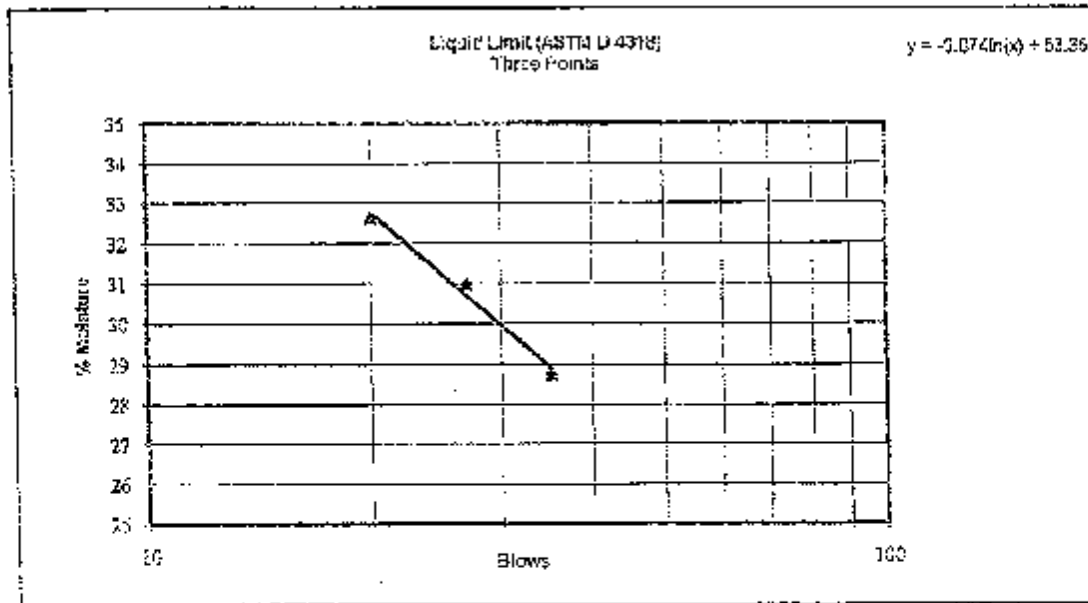

Performed by: AGM 11-11-09

Checked by: RDR 11-11-09





22010 Commerce Drive  
Abingdon, Virginia 24211

Telephone: 270-676-0426 ~ Facsimile: 270-676-0751

Project Name: AEP Dike Drilling  
Project Number: 3050-09-0131  
Report Date: 11/09/09

Soil Description: Light Olive Brown Clayey Sandy  
SILT (ML) 2.5y 5.3

Atterberg Limits AASHTO T90-00 (2004)  
(Three Points)

Sample Number: B-0904  
Depth (ft): UD-15 69.5' - 71.8'

| Blows | % Moisture |
|-------|------------|
| 35    | 39.2       |
| 24    | 41.3       |
| 16    | 43.1       |

| Liquid Limit | Plastic Limit | Plasticity Index |
|--------------|---------------|------------------|
| 41           | 26            | 15               |

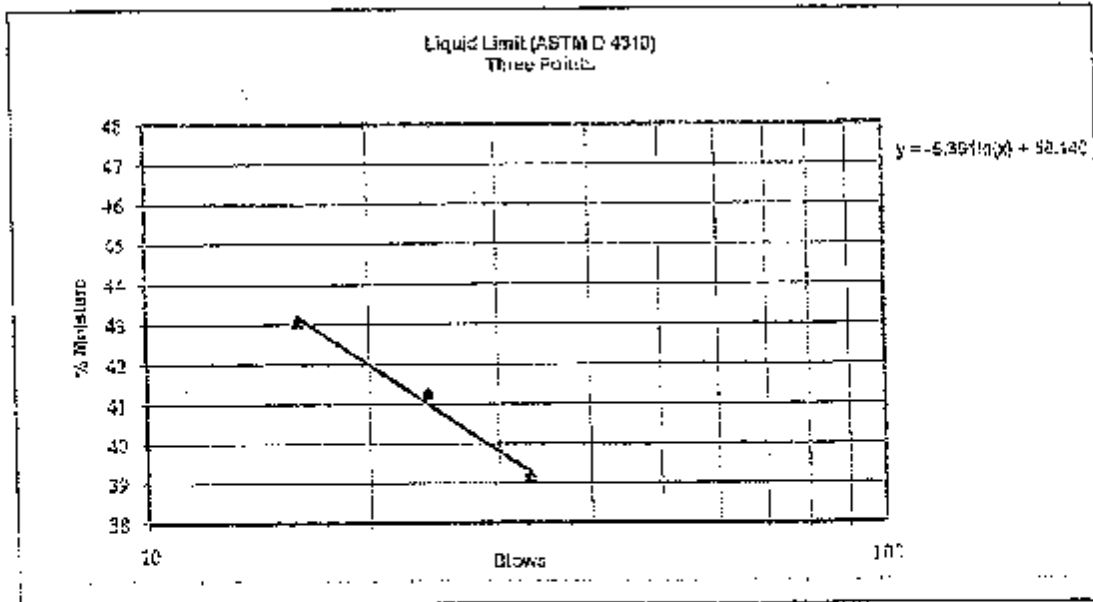

Performed by: MLH 11-11-09

Checked by: RDR 11-11-09

## LIQUID AND PLASTIC LIMITS TEST REPORT

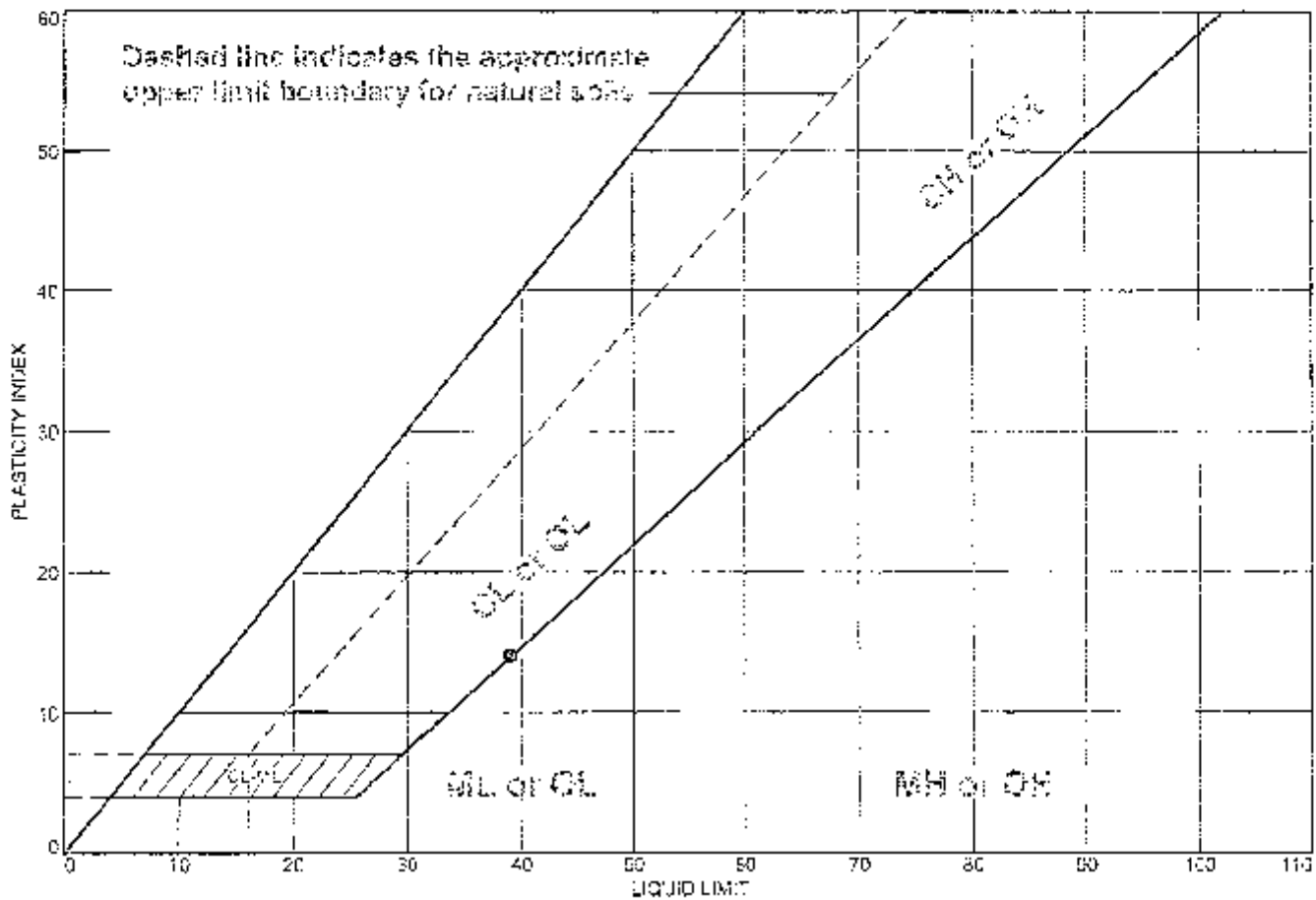

| MATERIAL DESCRIPTION | LL | PL | PI | %<#40 | %<#200 | USCS |
|----------------------|----|----|----|-------|--------|------|
| Gray Clayey SAND     | 39 | 25 | 14 | 57.0  | 26.0   | SC   |
|                      |    |    |    |       |        |      |
|                      |    |    |    |       |        |      |

Project No. 3050090131.02 Client: American Electric Power  
 Project: Dike Drilling  
 Source of Sample: B-0905 Depth: 20.0-22.0 Sample Number: UD-3

Remarks:  
 Moisture Content: 15.2%

**MACTEC ENGINEERING AND CONSULTING, INC.**

Jax FL.

Tested By: ES Checked By: Rajni Subhramani



# MACTEC

22010 Commerce Drive

Abingdon, Virginia 24211

Telephone: 276-676-0429 ~ Facsimile: 276-676-6751

Project Name: ABP Dike Drilling

Project Number: 3050-09-0131

Report Date: 11/09/09

Soil Description: Very Dark Grayish Brown Lean

CLAY with Sand (CL) 10%R 3/2

Atterberg Limits AASHTO T90-00 (2004)

(Three Points)

Sample Number: D-0908

Depth (ft): U13-B 42.5' - 44.5'

| Blows | % Moisture |
|-------|------------|
| 35    | 35.3       |
| 24    | 35.3       |
| 15    | 37.4       |

| Liquid Limit | Plastic Limit | Plasticity Index |
|--------------|---------------|------------------|
| 35           | 23            | 12               |

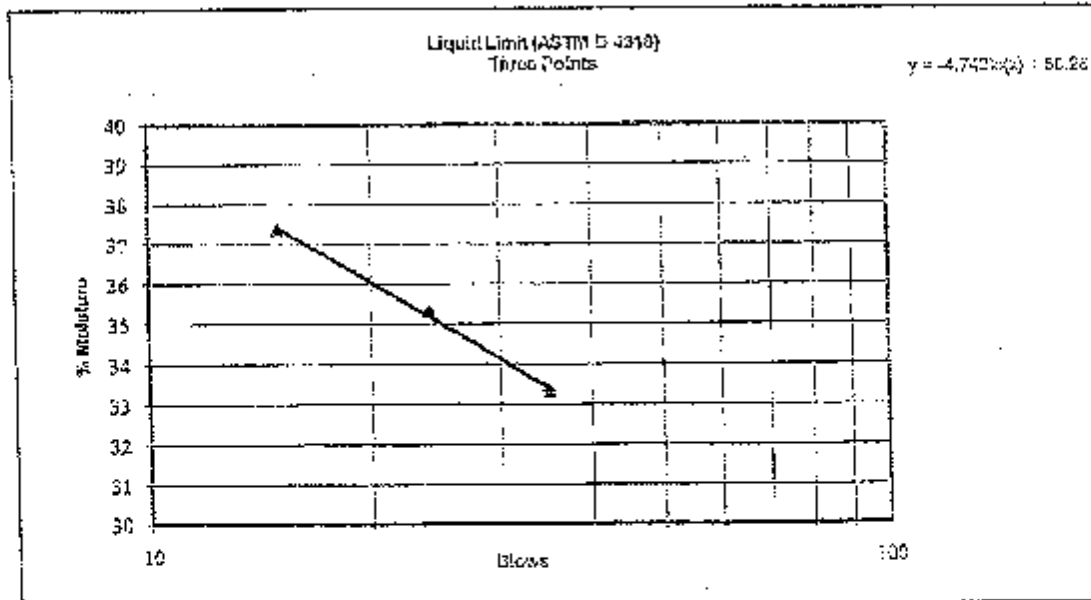

Performed by: J/CA 11-11-09

Checked by: RDE 11-11-09



# MACTEC

22010 Commerce Drive  
 Abingdon Virginia 24211  
 Telephone: 276-676-0426 ~ Facsimile: 276-676-0761

Project Name: AEP Dike Drilling  
 Project Number: 3050-09-013  
 Report Date: 11/19/09

Soil Description: Grayish Brown Lean CLAY with  
 Sand (CL) 2.5Y 5/2

Atterberg Limits AASHTO T90-08 (2004)  
 (Three Points)

Sample Number: B-0908  
 Depth (ft): UD-13 63.0' - 65.0'

| Blows | % Moisture |
|-------|------------|
| 35    | 34.2       |
| 19    | 37.5       |
| 13    | 39.6       |

| Liquid Limit | Plastic Limit | Plasticity Index |
|--------------|---------------|------------------|
| 36           | 24            | 12               |

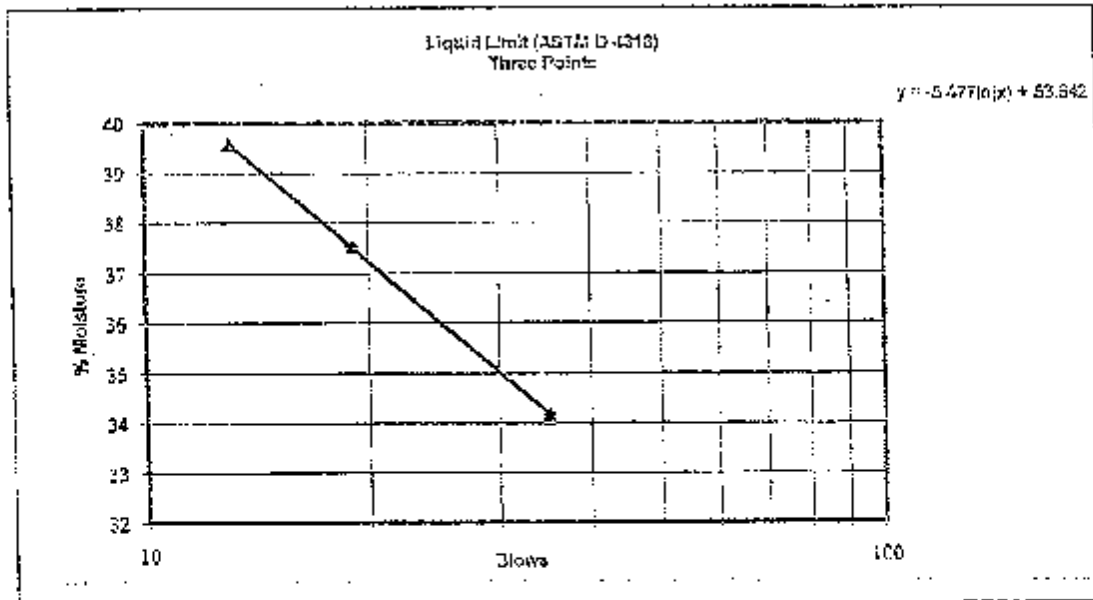

Performed by: AGH 11-11-09

Checked by: RDR 11-11-09



22010 Commerce Drive  
Abingdon, Virginia 24211  
Telephone: 276-676-0426 - Facsimile: 276-676-0761

Project Name: AEP Dike Drilling  
Project Number: 3050-09-0131  
Report Date: 11/09/09

Soil Description: Dark Gray SILT with sand (ML)  
2.5Y 4/1

Atterberg Limits AASHTO T90-00 (2004)  
(Three Points)

Sample Number: B-0908  
Depth (ft): U1D-15 78.0 - 80.5'

| Blows | % Moisture |
|-------|------------|
| 33    | 37.0       |
| 22    | 38.2       |
| 15    | 39.8       |

| Liquid Limit | Plastic Limit | Plasticity Index |
|--------------|---------------|------------------|
| 38           | 26            | 12               |

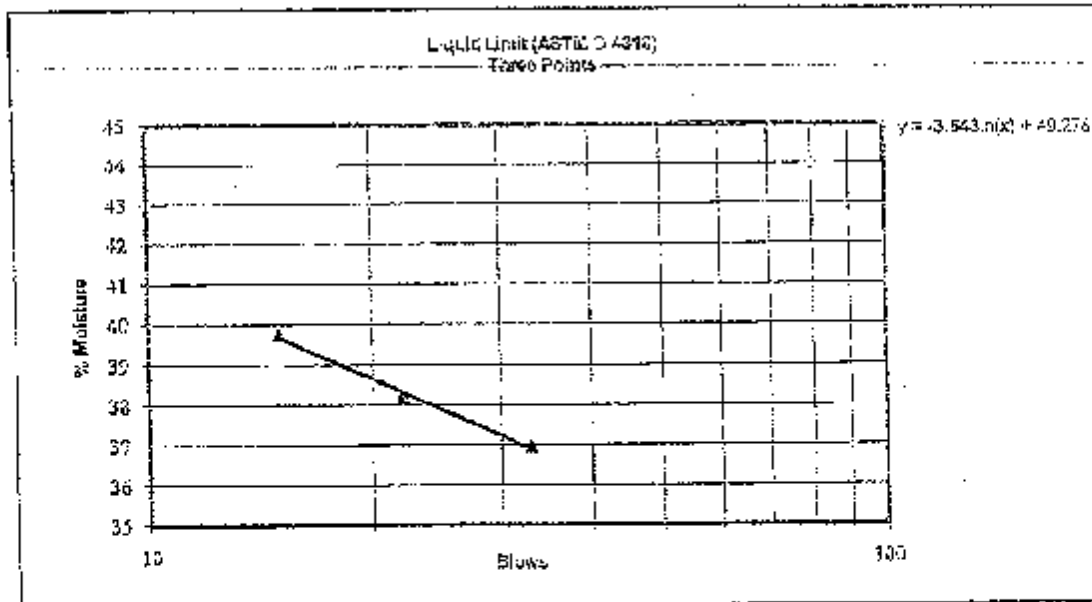

Performed by: NOE 11-11-09

Checked by: RDK 11-11-09

### CONSOLIDATION TEST REPORT

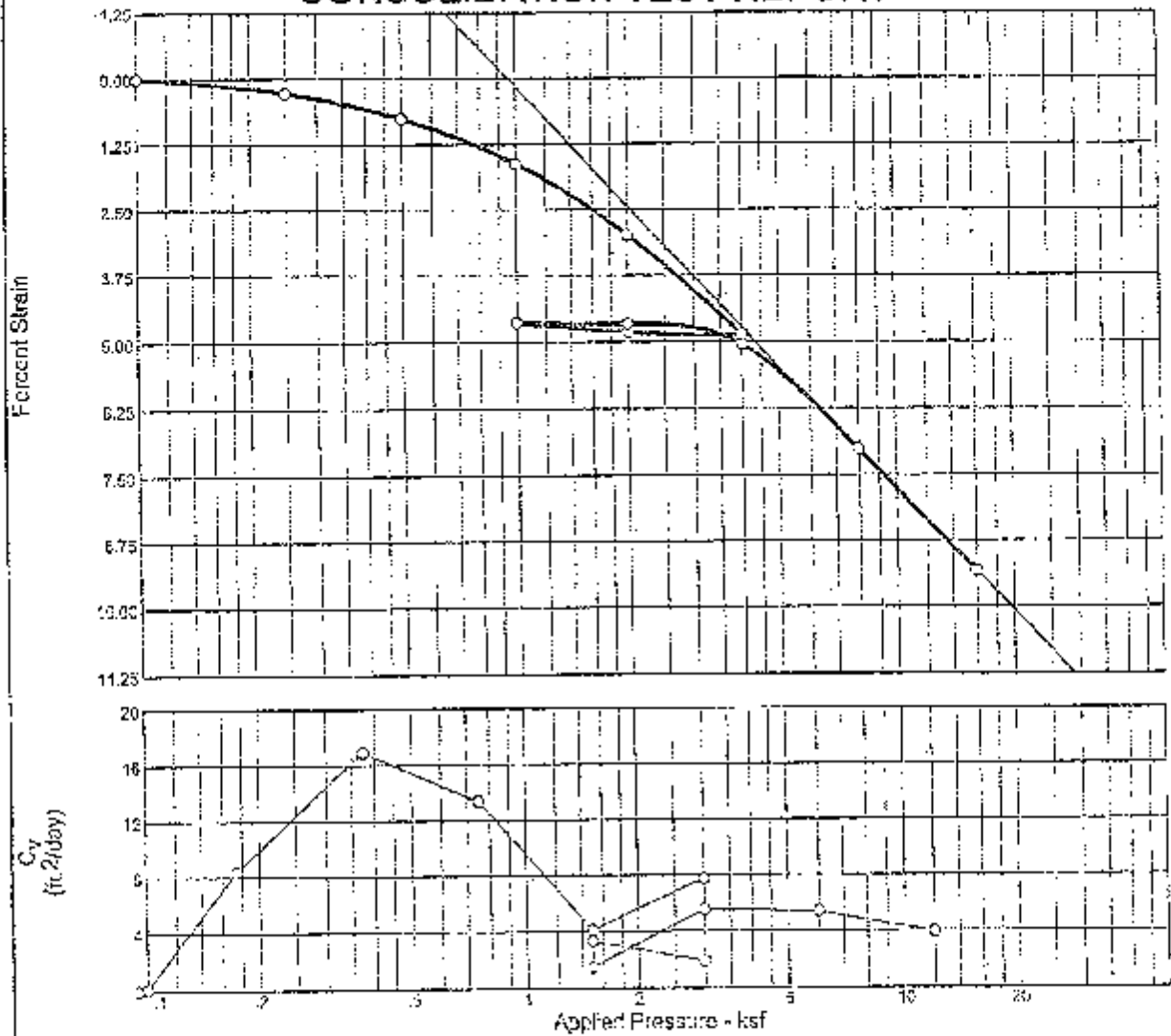

| MATERIAL DESCRIPTION  |    |         |                  |                 |       |          |        |            |         | USCS  |                | AASHTO               |                |
|---|----|---------|------------------|-----------------|-------|----------|--------|------------|---------|---|----------------|----------------------|----------------|
| Brown clay with gravel                                      |    |         |                  |                 |       |          |        |            |         |   |                |                      |                |
| LL  | PI | Sp. Gr. | Overburden (ksf) | Dry Dens. (pcf) |       | Moisture |        | Saturation |         | Void Ratio                                    |                | F <sub>o</sub> (ksf) | C <sub>c</sub> |
|   |    |         |                  | Init.           | Final | Init.    | Final  | Init.      | Final   | Init.   | Final          |                      |                |
|   |    | 2.765   |                  | 117.4           |       | 11.5 %   | 15.0 % | 63.5 %     | 100.0 % | 0.459   | 0.323          | 1.79                 | 0.11           |
| Preparation Process: Trained using cylindrical cutting ring |    |         |                  |                 |       |          |        |            |         | D2435 Method                                  | C <sub>r</sub> | Swal Press. (ksf)    | Heave %        |
| Condition of Test: Natural moisture, undrained at 0.05 ksf  |    |         |                  |                 |       |          |        |            |         | D   | 0.01           |                      |                |
| Project No. 3250090131.02 Client: American Electric Power   |    |         |                  |                 |       |          |        |            |         | Remarks:<br>Percent passing #200 sieve: 51.1% |                |                      |                |
| Project: Lake Drilling                                      |    |         |                  |                 |       |          |        |            |         |   |                |                      |                |
| Source: B-0904 Sample No.: U/D-8 Elev./Depth: 36.0'-38.0'   |    |         |                  |                 |       |          |        |            |         | Checked By:<br>Title: <i>Rajni Subhawan</i>   |                |                      |                |
| MACTEC ENGINEERING AND CONSULTING, INC.                     |    |         |                  |                 |       |          |        |            |         | Jax FL  |                |                      |                |

### Dial Reading vs. Time

Project No.: 3050-09-0131-02  
 Project: Dike Drilling

Source: B-0904

Sample No.: UD-8

Elev. Depth: 36.0-38.0'

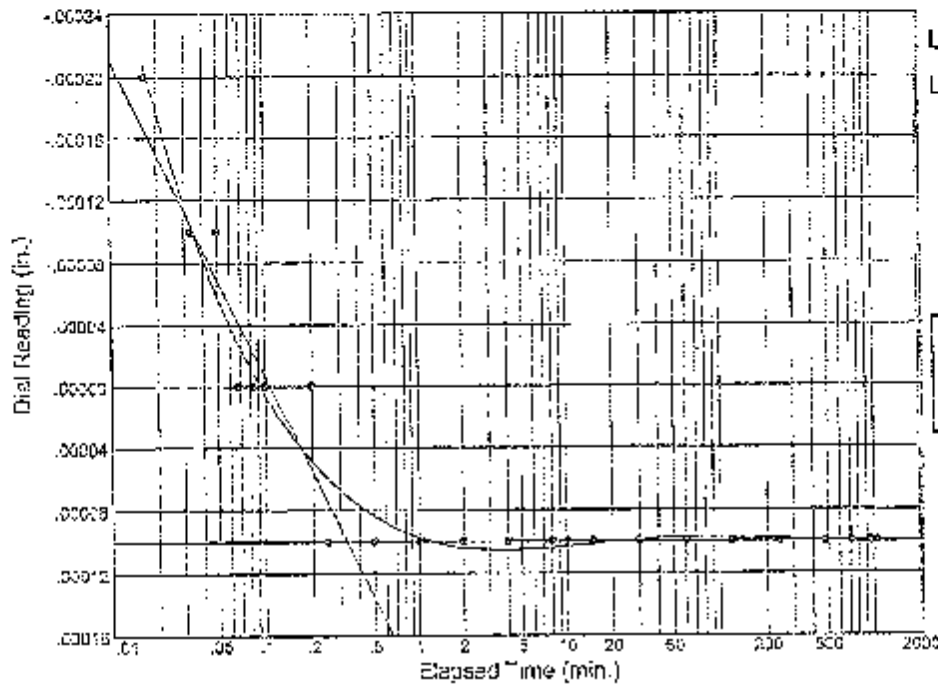

Load No. = 1  
 Load = 0.10 ksf  
 $D_0 = 0.00000$   
 $D_{50} = 0.00005$   
 $D_{100} = 0.00010$   
 $T_{50} = 4.19 \text{ min.}$

$C_v @ T_{50}$   
 0.07 ft.2/day

$C_\alpha = 0.000$

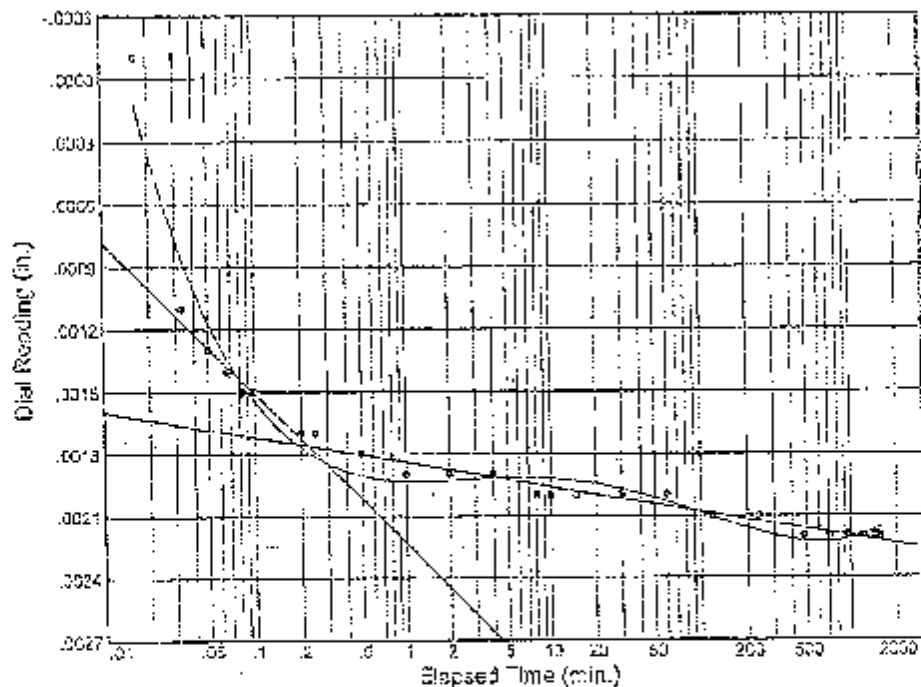

Load No. = 2  
 Load = 0.25 ksf  
 $D_0 = 0.00010$   
 $D_{50} = 0.00093$   
 $D_{100} = 0.00176$   
 $T_{50} = 0.03 \text{ min.}$

$C_v @ T_{50}$   
 8.35 ft.2/day

$C_\alpha = 0.000$

MACTEC Engineering and Consulting, Inc.

Jax FL

### Dial Reading vs. Time

Project No.: 3050-09-0131-02  
 Project: Dike Drilling

Source: B-0904

Sample No.: UD-3

Elev./Depth: 35.3-38.7'

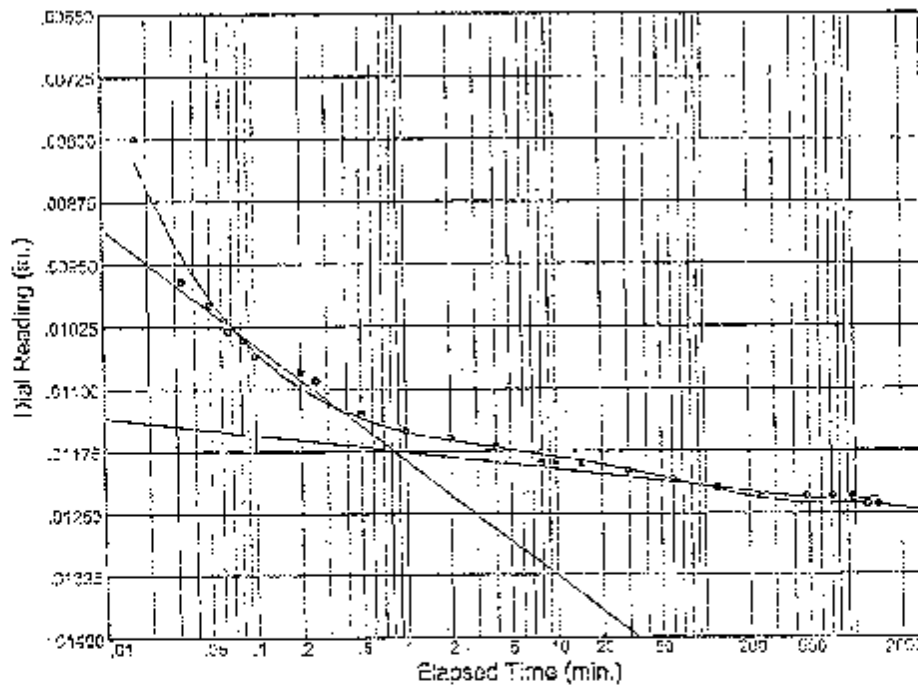
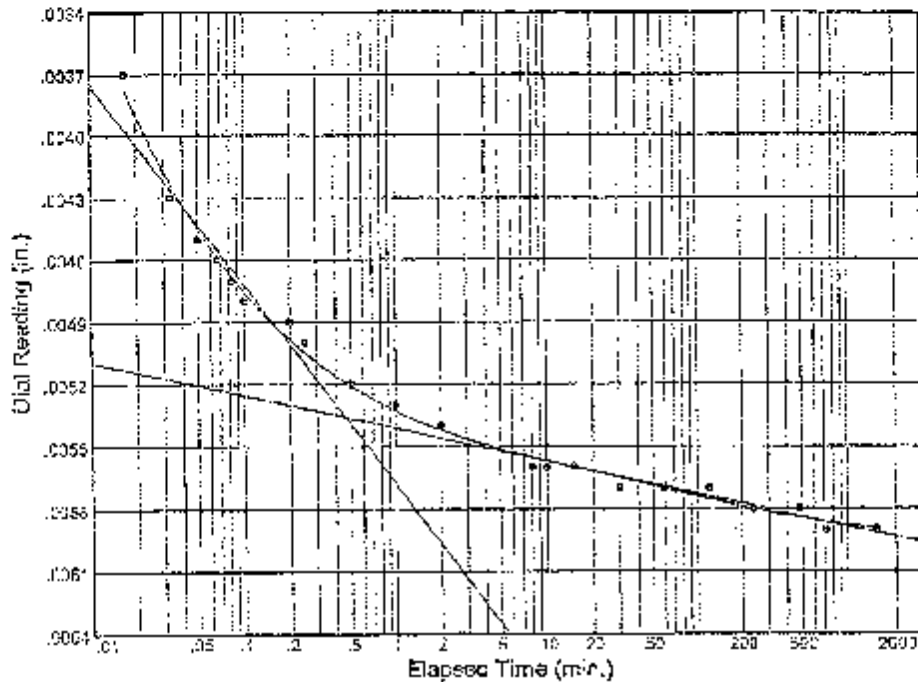

MACTEC Engineering and Consulting, Inc.

Jax FL



### Dial Reading vs. Time

Project No.: 3050-09-0101-02  
 Project: Dike Drilling

Source: B-0904

Sample No.: 6D-8

Elev./Depth: 30.0-38.0'

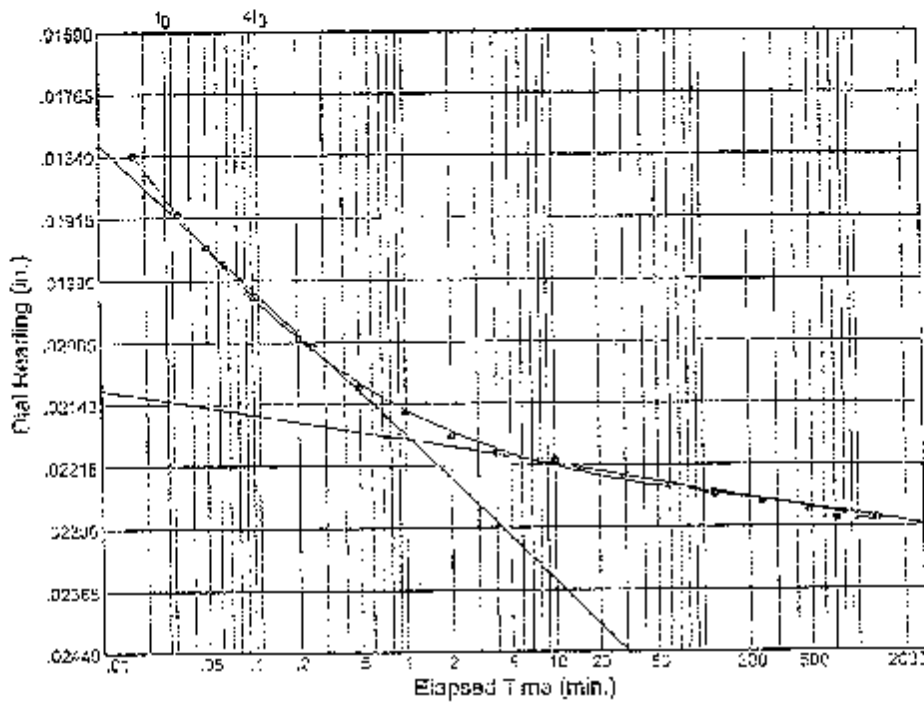

Load No. = 5  
 Load = 2.00 ksf  
 $D_0 = 0.01766$   
 $D_{50} = 0.01975$   
 $D_{100} = 0.02185$   
 $T_{50} = 0.07 \text{ min.}$

$C_v @ T_{50}$   
 4.10 ft.<sup>2</sup>/day

$C_{\alpha} = 0.006$

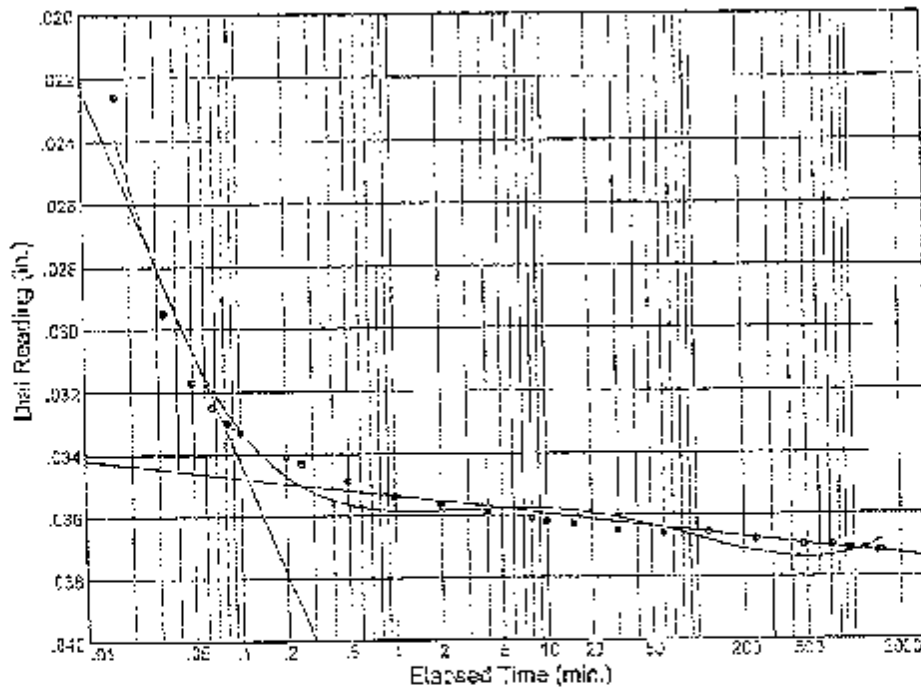

Load No. = 6  
 Load = 4.00 ksf  
 $D_0 = 0.02280$   
 $D_{50} = 0.02881$   
 $D_{100} = 0.03481$   
 $T_{50} = 0.03 \text{ min.}$

$C_v @ T_{50}$   
 7.75 ft.<sup>2</sup>/day

$C_{\alpha} = 0.001$

MACTEC Engineering and Consulting, Inc.

Jax FL

### Dial Reading vs. Time

Project No.: 3050-89-0131-02  
 Project: Dike Drilling

Source: D-0904

Sample No.: UD-3

Elev./Depth: 36.0-38.0

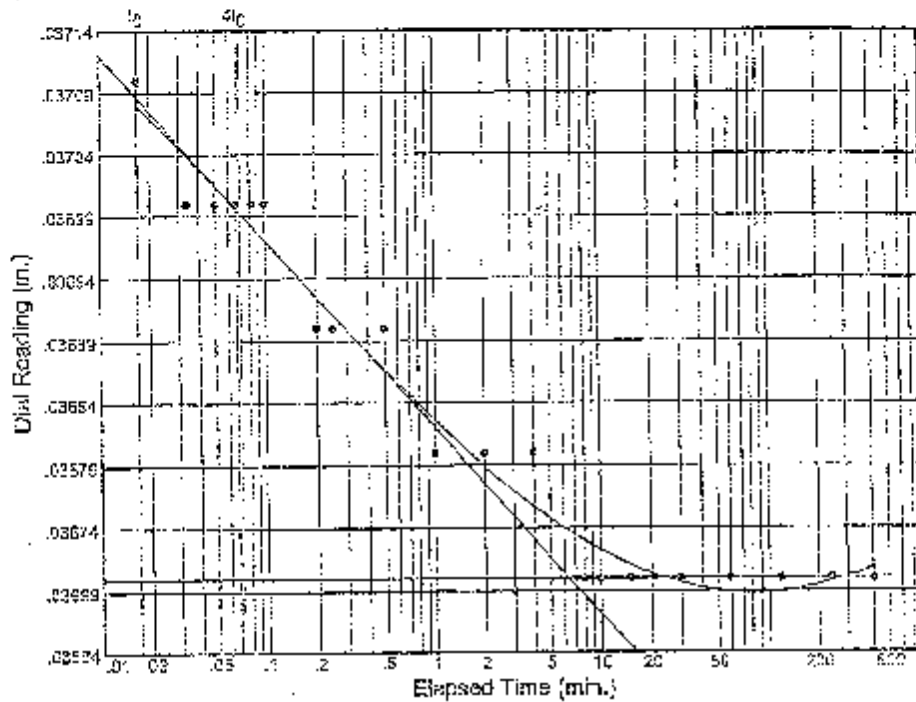

Load No. = 7  
 Load = 2.00 ksf  
 $D_0 = 0.03720$   
 $D_{50} = 0.03695$   
 $D_{100} = 0.03670$   
 $T_{50} = 0.14 \text{ min.}$

$C_v @ T_{50}$   
 1.90 ft<sup>2</sup>/day

$C_a = 0.336$

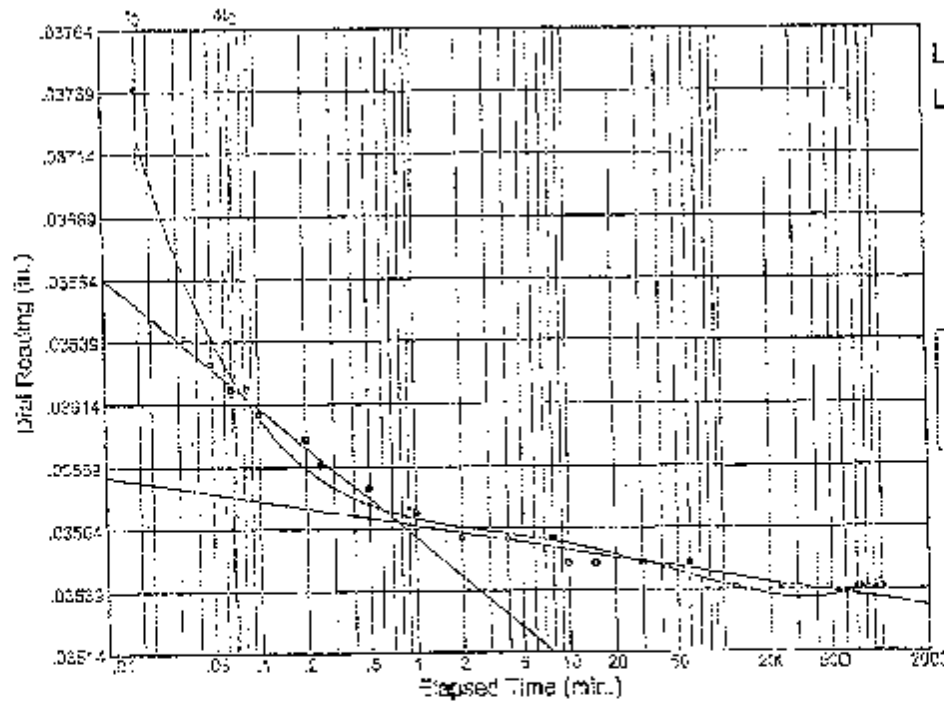

Load No. = 8  
 Load = 1.00 ksf  
 $D_0 = 0.03670$   
 $D_{50} = 0.03618$   
 $D_{100} = 0.03566$   
 $T_{50} = 0.08 \text{ min.}$

$C_v @ T_{50}$   
 3.32 ft<sup>2</sup>/day

MACTEC Engineering and Consulting, Inc.

Jax Fla.

### Dial Reading vs. Time

Project No.: 3050-09-0131-02  
 Project: Dike Drilling

Source: B-0904

Sample No.: LD-2

Elev. Depth: 36.0-38.0'

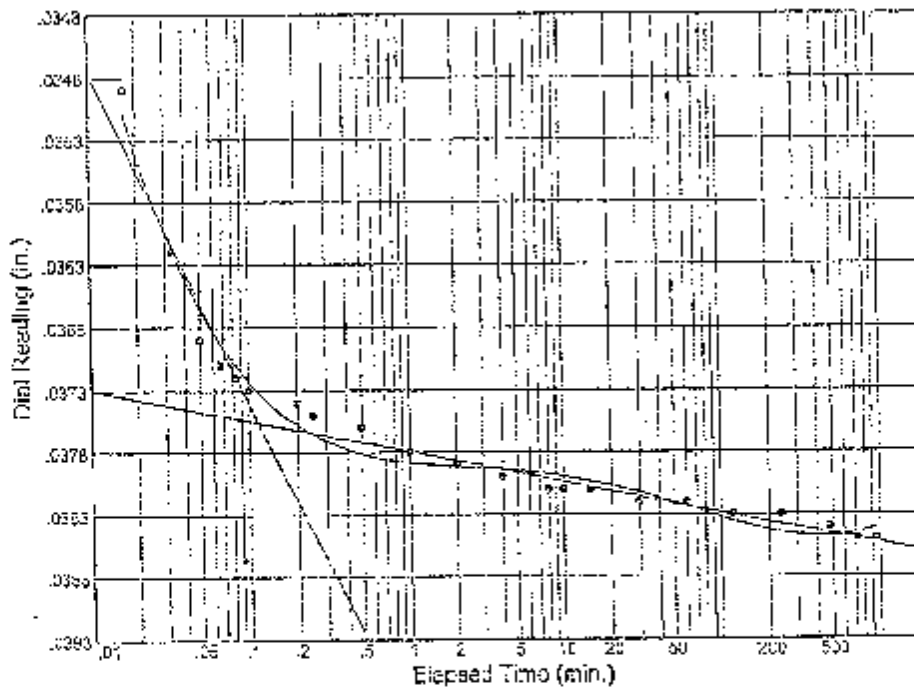
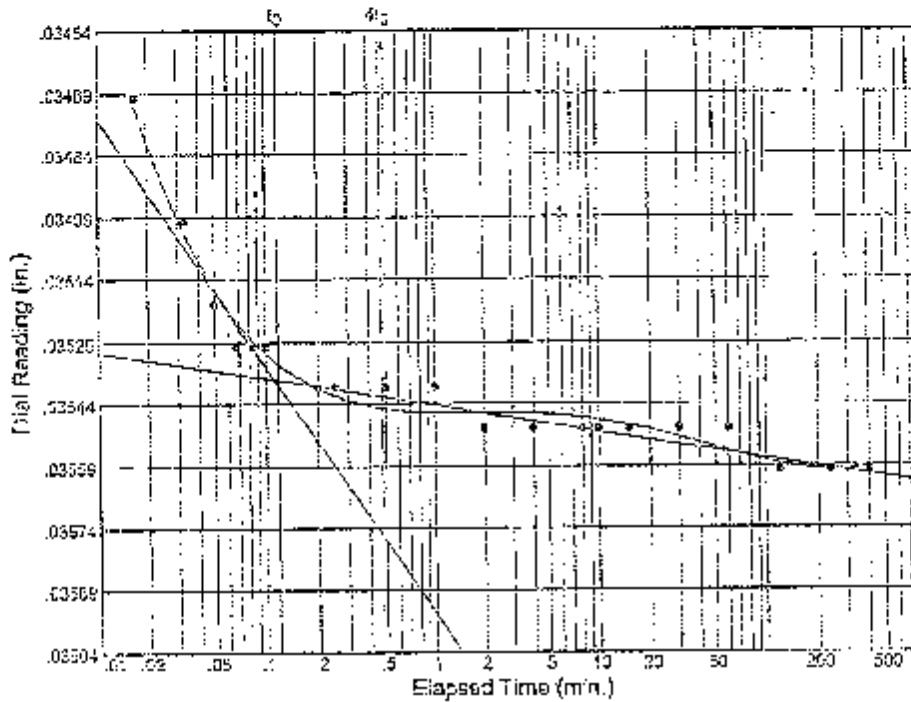

MACTEC Engineering and Consulting, Inc.

Jax FL

### Dial Reading vs. Time

Project No.: 3050-09-0131-02  
 Project: Dike Drilling

Source: B-0934

Sample No.: UD-4

Elev./Depth: 36.0'-36.0'

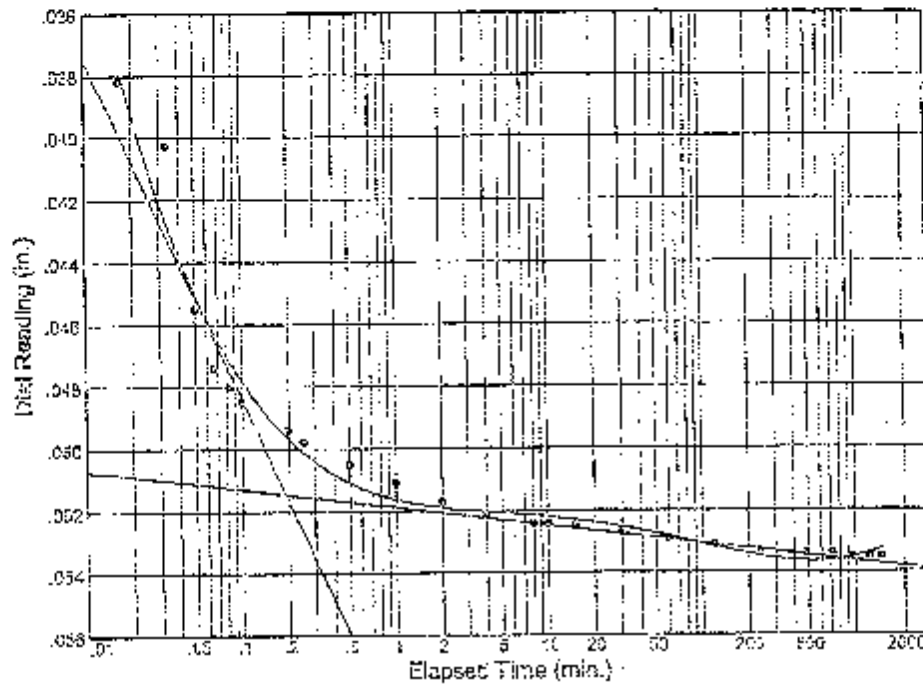

Load No. = 11  
 Load = 8.00 ksf  
 $D_0 = 0.03780$   
 $D_{50} = 0.04463$   
 $D_{100} = 0.05145$   
 $T_{50} = 0.05 \text{ min.}$

$C_v @ T_{50}$   
 5.40 ft./day

$C_{\alpha} = 0.001$

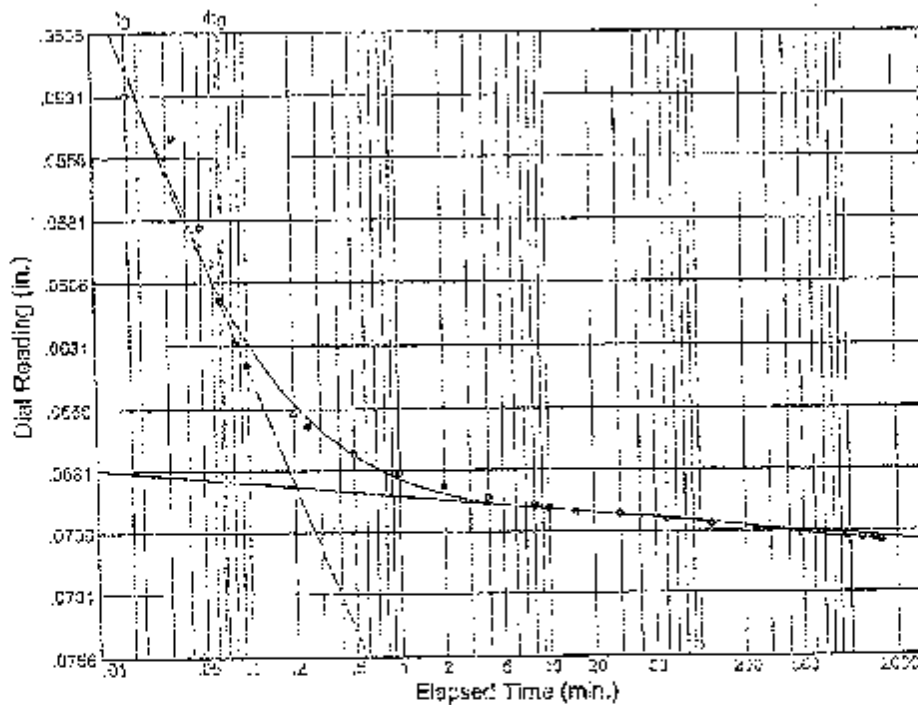

Load No. = 12  
 Load = 16.00 ksf  
 $D_0 = 0.08250$   
 $D_{50} = 0.06068$   
 $D_{100} = 0.06877$   
 $T_{50} = 0.06 \text{ min.}$

$C_v @ T_{50}$   
 3.95 ft./day

$C_{\alpha} = 0.001$

Jax FL

MACTEC Engineering and Consulting, Inc.

### CONSOLIDATION TEST REPORT

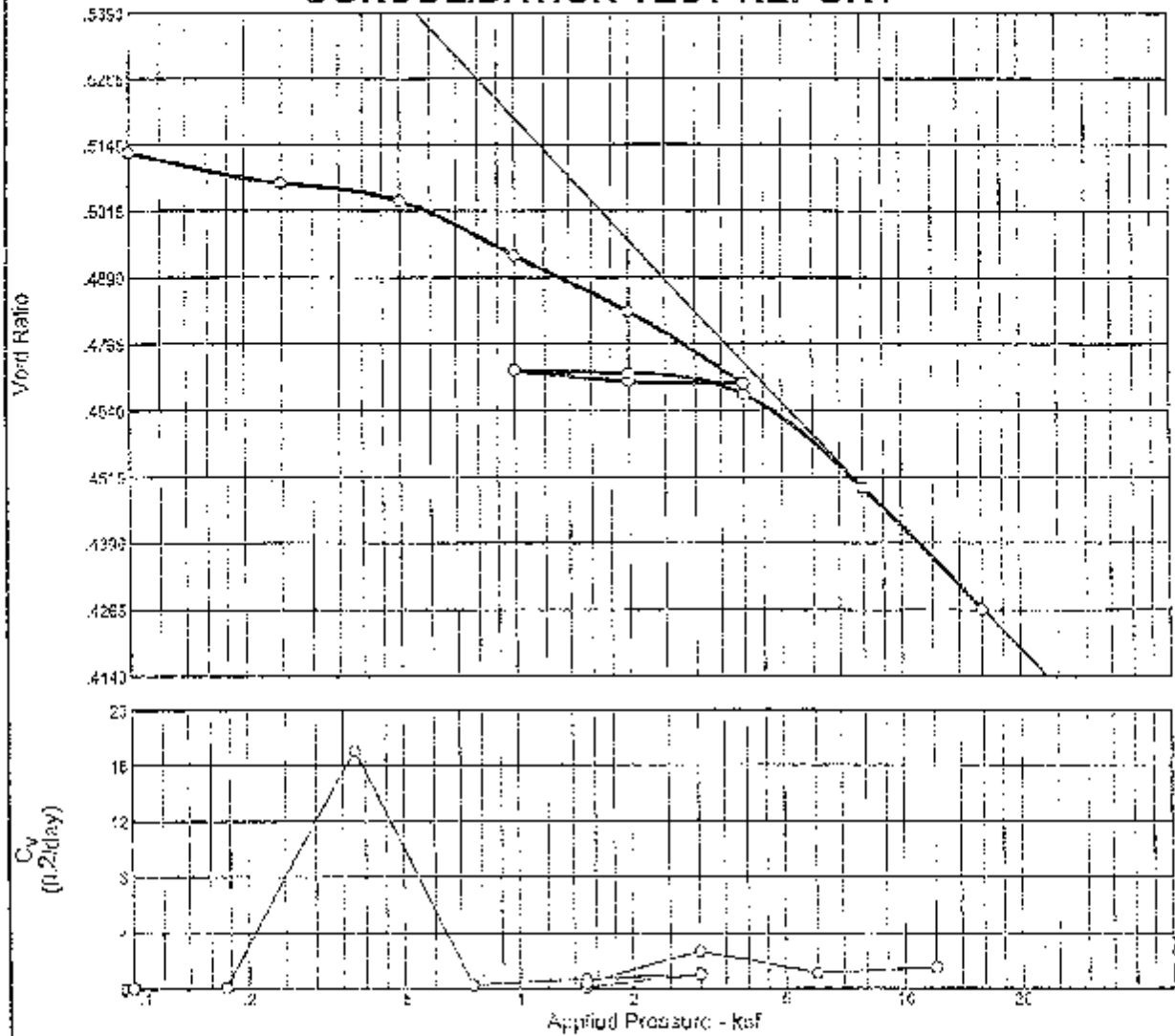

| MATERIAL DESCRIPTION  |    |         |                  |                 |       |          |       |            |        | USCS  |       | AASHTO             |         |
|---|----|---------|------------------|-----------------|-------|----------|-------|------------|--------|---|-------|--------------------|---------|
| Brown clay with gravel                                      |    |         |                  |                 |       |          |       |            |        |   |       |                    |         |
| LL  | PI | Sp. Gr. | Overburden (ksf) | Dry Dens. (pcf) |       | Moisture |       | Saturation |        | Void Ratio                                    |       | Pc (ksf)           | Cc      |
|   |    |         |                  | Init.           | Final | Init.    | Final | Init.      | Final  | Init.   | Final |                    |         |
|   |    | 2.656   |                  | 110.7           |       | 19.2%    | 6.9%  | 100.0%     | 100.0% | 0.515   | 0.427 | 1.95               | 0.08    |
| Preparation Process: Trimmed using cylindrical cutting ring |    |         |                  |                 |       |          |       |            |        | D2435 Method                                  | Cr    | Swell Press. (ksf) | Heave % |
| Condition of Test: Natural moisture, inundated at 0.05 ksf  |    |         |                  |                 |       |          |       |            |        | B   | 0.01  |                    |         |
| Project No. 3050000131.02 Client: American Electric Power   |    |         |                  |                 |       |          |       |            |        | Remarks:<br>Percent passing #300 sieve: 75.5% |       |                    |         |
| Project: Dike Drilling                                      |    |         |                  |                 |       |          |       |            |        |   |       |                    |         |
| Source: B-0904 Sample No.: UD-11 Elev./Depth: 52.0'-54.0'   |    |         |                  |                 |       |          |       |            |        | Checked By: <i>Kyri Suthusan</i>              |       |                    |         |
| CONSOLIDATION TEST REPORT                                   |    |         |                  |                 |       |          |       |            |        | Title: <i>Kyri Suthusan</i>                   |       |                    |         |
| MACTEC ENGINEERING AND CONSULTING, INC.                     |    |         |                  |                 |       |          |       |            |        | Jax FL.                                       |       |                    |         |

### CONSOLIDATION TEST REPORT

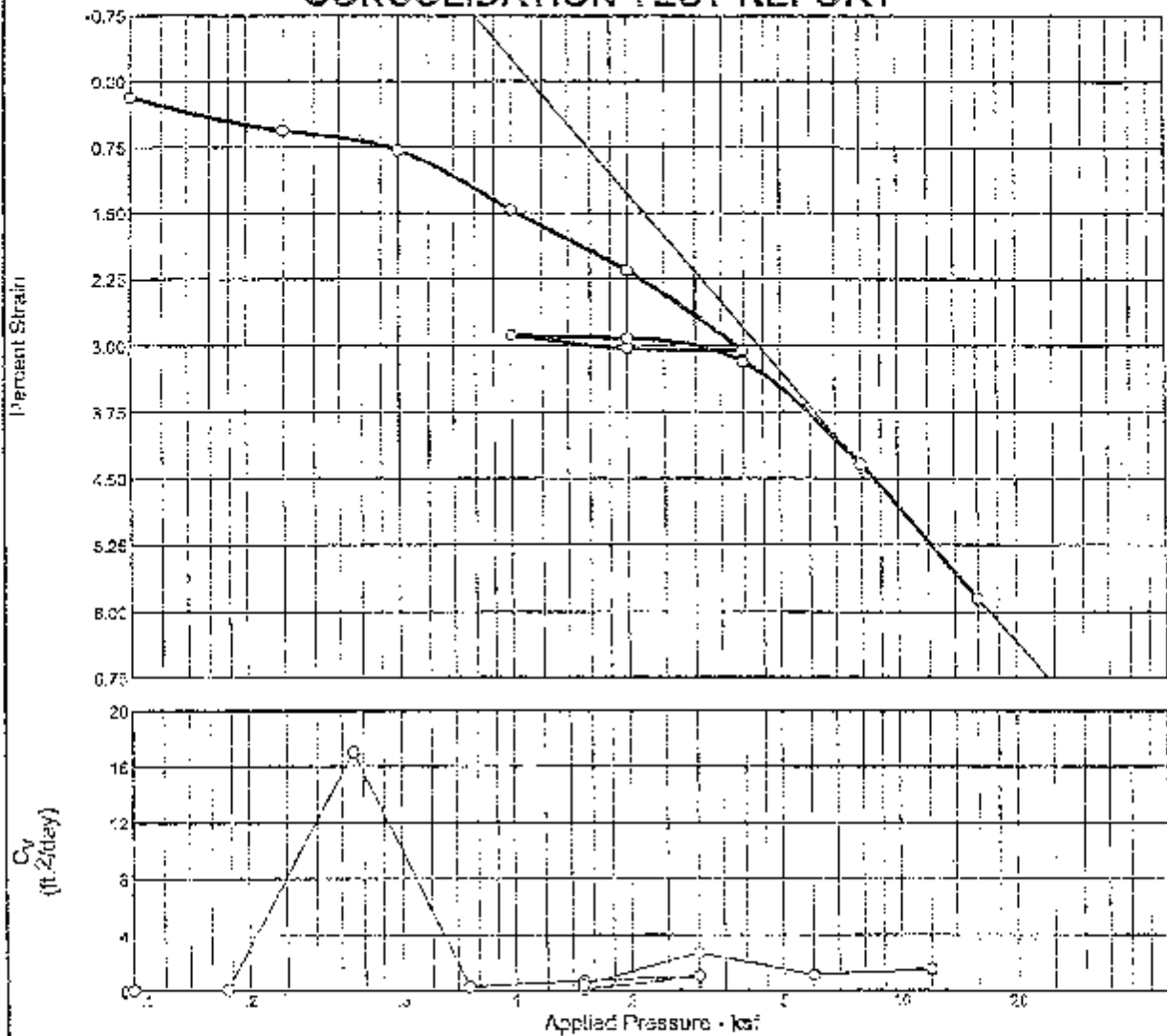

| MATERIAL DESCRIPTION   |    |         |                  |                 |       |          |        |            |         | USCS  |                | AASHTO            |         |
|--|----|---------|------------------|-----------------|-------|----------|--------|------------|---------|---|----------------|-------------------|---------|
| Drown clay with gravel   |    |         |                  |                 |       |          |        |            |         |   |                |                   |         |
| LL   | PI | Sp. Gr. | Overburden (ksf) | Dry Dens. (pcf) |       | Moisture |        | Saturation |         | Void Ratio                                    |                | Fc (ksf)          | Cc      |
|  |    |         |                  | Init.           | Final | Init.    | Final  | Init.      | Final   | Init.   | Final          |                   |         |
|  |    | 2.686   |                  | 110.7           |       | 12.5 %   | 16.5 % | 100.0 %    | 100.0 % | 0.515   | 0.427          | 1.96              | 0.98    |
| Preparation Process: Trimmed using cylindrical cutting ring                            |    |         |                  |                 |       |          |        |            |         | D2435 Method                                  | C <sub>r</sub> | Swel Press. (ksf) | Heave % |
| Condition of Test: Natural moisture, inundated at 0.05 ksf                             |    |         |                  |                 |       |          |        |            |         | H   | 0.51           |                   |         |
| Project No. 1050080151.02 Client: American Electric Power                              |    |         |                  |                 |       |          |        |            |         | Remarks:<br>Percent passing #200 sieve: 75.5% |                |                   |         |
| Project: 24k Drilling  |    |         |                  |                 |       |          |        |            |         |   |                |                   |         |
| Source: B-0904 Sample No.: UD-11 Elev./Depth: 52.0'-54.0'                              |    |         |                  |                 |       |          |        |            |         | Checked By: <i>Kapri Subhina</i>              |                |                   |         |
| <p>CONSOLIDATION TEST REPORT</p> <p><b>MACTEC ENGINEERING AND CONSULTING, INC.</b></p> |    |         |                  |                 |       |          |        |            |         | Title: <i>Kapri Subhina</i><br>Jax FL.        |                |                   |         |

### Dial Reading vs. Time

Project No.: 3050390131.02  
 Project: Dike Drilling

Source: E-0004

Sample No.: UT-11

Elev./Depth: 52.0'-54.0'

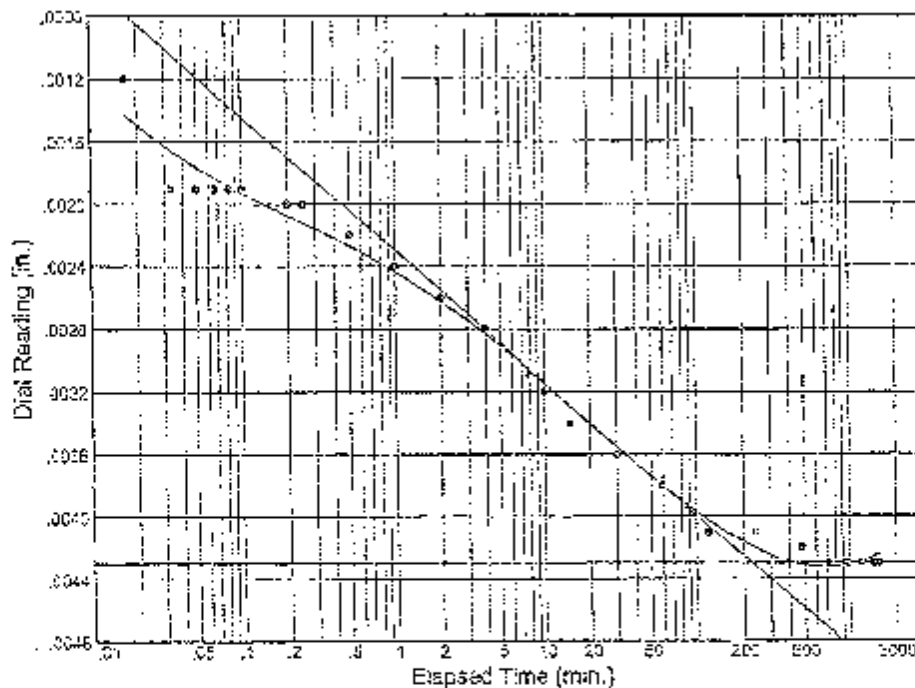
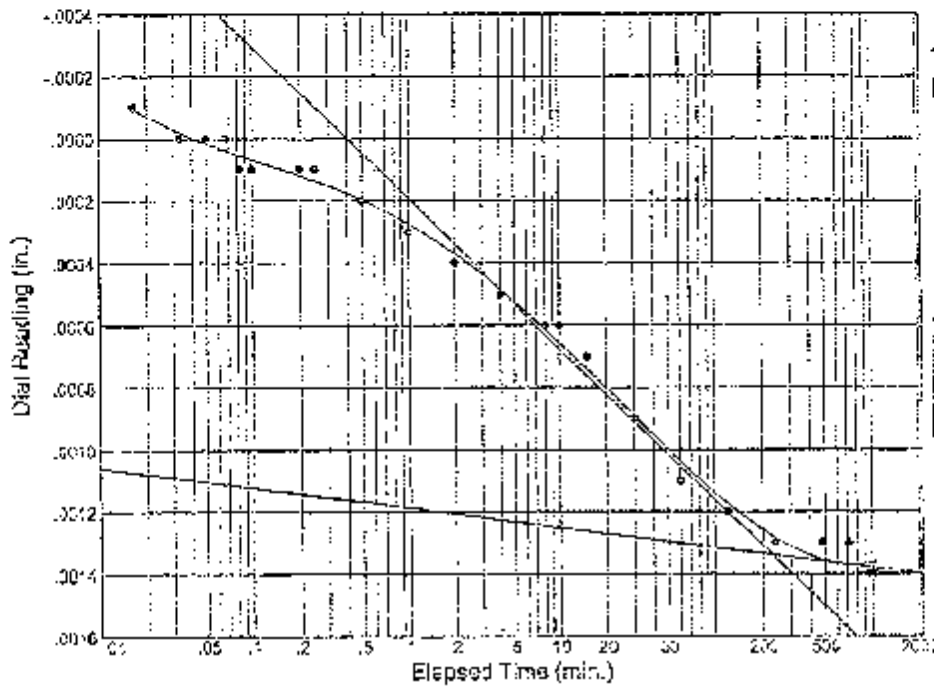

MACTEC Engineering and Consulting, Inc.

Jax FL

### Dial Reading vs. Time

Project No.: 3050090131.02  
 Project: Dike Drilling

Source: B-0904

Sample No.: UD-11

Elev./Depth: 52.0'-54.0'

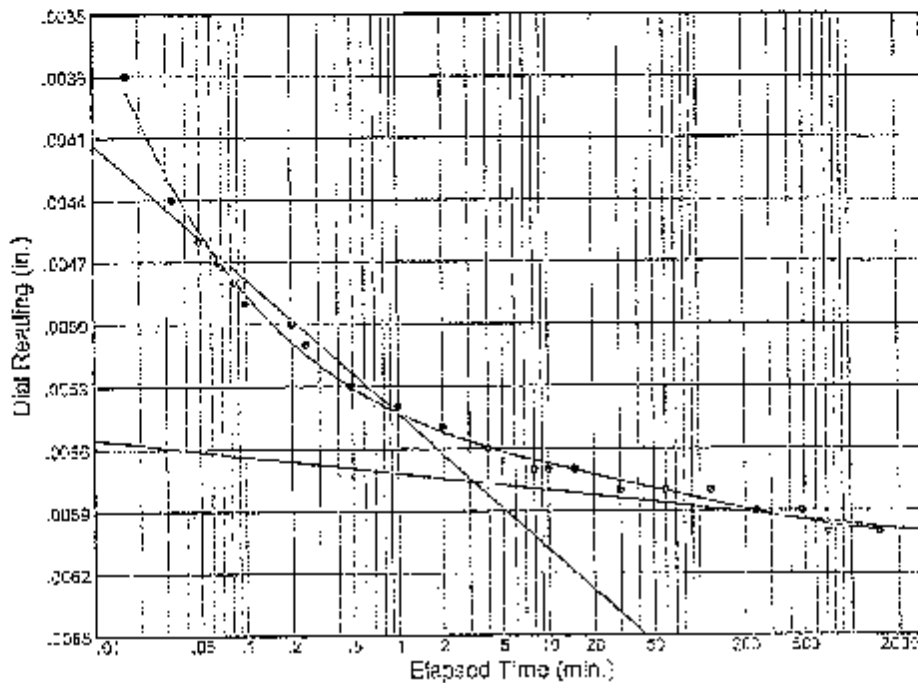

Load No.= 3

Load= 0.50 ksf

$D_0 = 0.00200$

$D_{50} = 0.00588$

$D_{100} = 0.00576$

$T_{50} = 0.02 \text{ min.}$

$C_v @ T_{50}$

17.03 ft.<sup>2</sup>/day

$C_{\alpha} = 0.000$

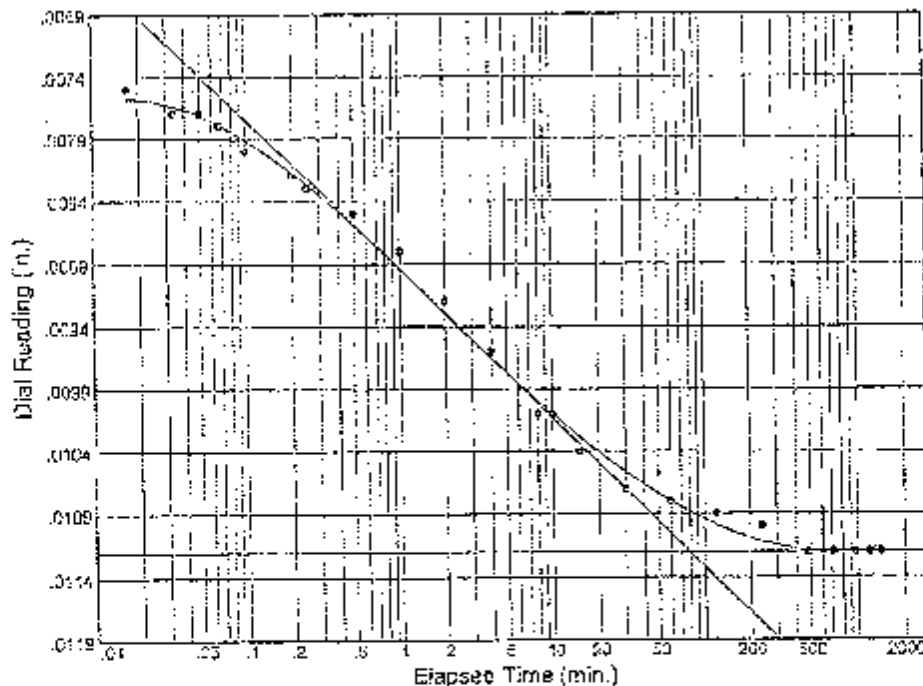

Load No.= 4

Load= 1.00 ksf

$D_0 = 0.00680$

$D_{50} = 0.00900$

$D_{100} = 0.01120$

$T_{50} = 1.13 \text{ min.}$

$C_v @ T_{50}$

0.25 ft.<sup>2</sup>/day

$C_{\alpha} = 0.000$

MACTEC Engineering and Consulting, Inc.

Jax FL



### Dial Reading vs. Time

Project No.: 3050090131.02  
 Project: Dike Drilling

Source: B-0904

Sample No.: LD-11

Elev./Depth: 52.0'-54.0'

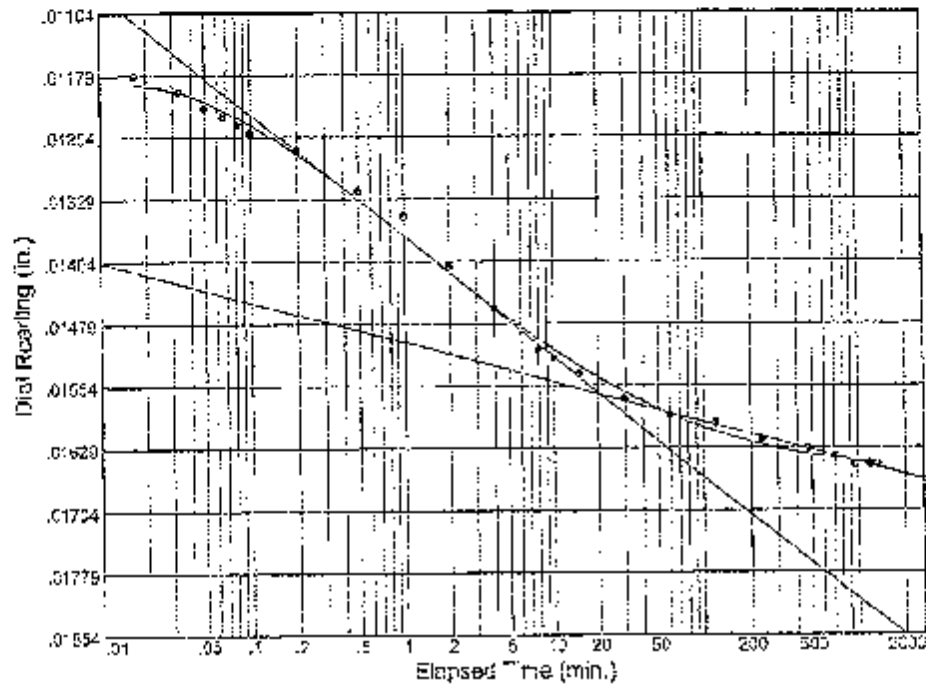

Load No. = 5  
 Load = 2.00 ksf  
 $D_0 = 0.01070$   
 $D_{50} = 0.01318$   
 $D_{100} = 0.01565$   
 $T_{50} = 0.41 \text{ min.}$

$C_v @ T_{50}$   
 0.08 ft.<sup>2</sup>/day  
 $C_\alpha = 0.001$

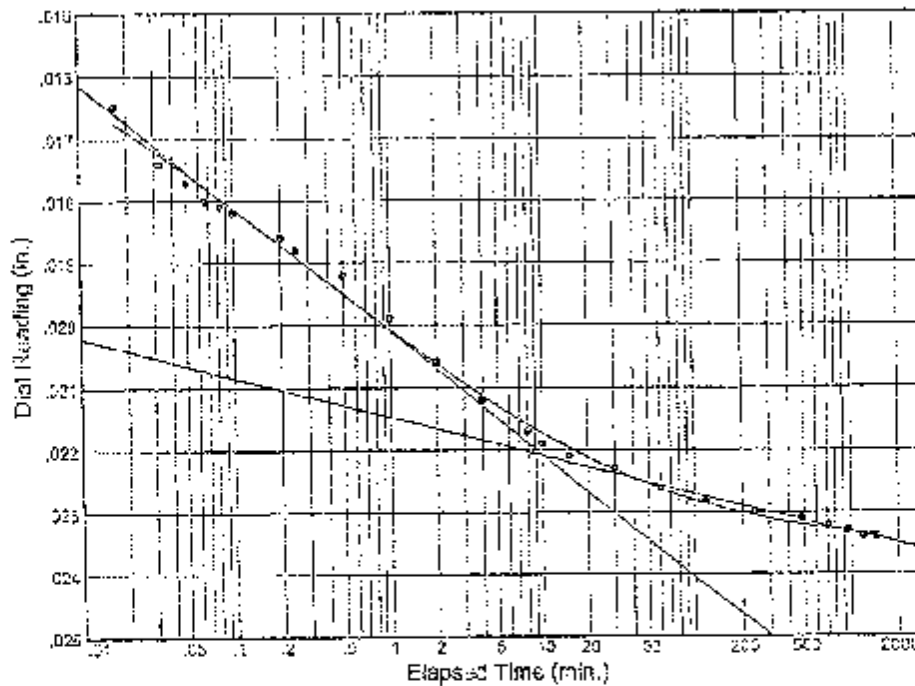

Load No. = 6  
 Load = 4.00 ksf  
 $D_0 = 0.01586$   
 $D_{50} = 0.01894$   
 $D_{100} = 0.02289$   
 $T_{50} = 0.26 \text{ min.}$

$C_v @ T_{50}$   
 1.05 ft.<sup>2</sup>/day  
 $C_\alpha = 0.001$

MACTEC Engineering and Consulting, Inc.

Jax FL.

### Dial Reading vs. Time

Project No.: 3050090131.02  
 Project: Dike Drilling

Source: B-0904

Sample No.: 5D-11

Elev./Depth: 52.0-54.0'

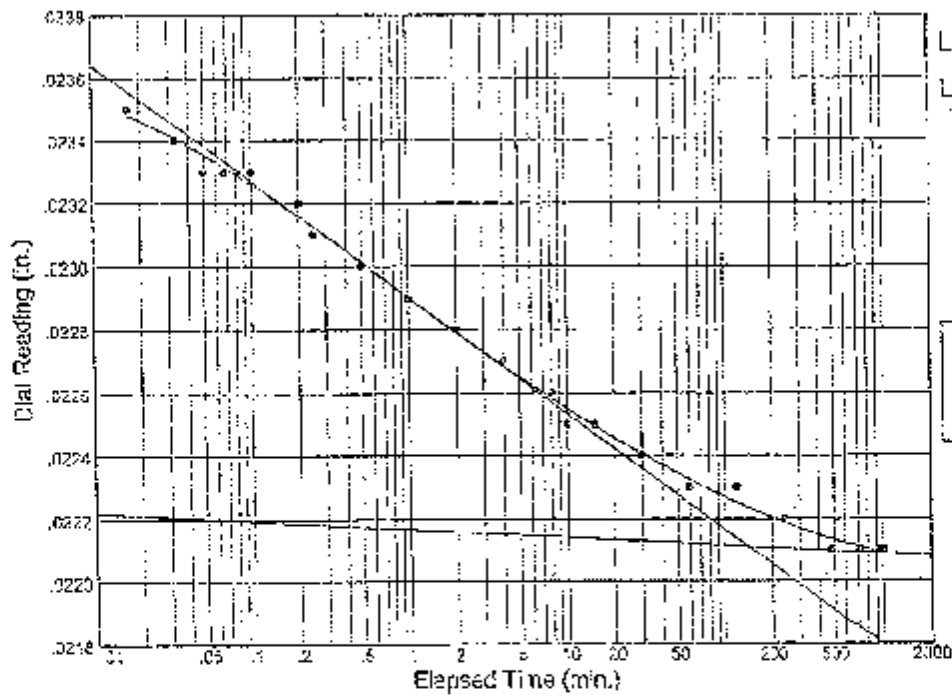
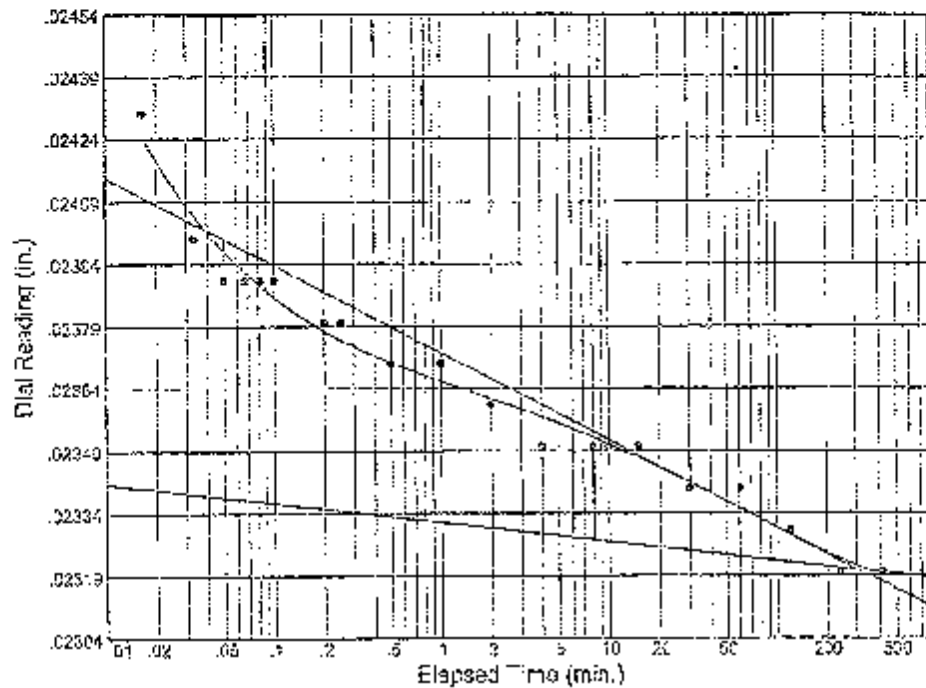

MACTEC Engineering and Consulting, Inc.

Max. FL.

### Dial Reading vs. Time

Project No.: 3350099131.02  
 Project: Dike Drilling

Source: B-6904

Sample No.: UD-11

Elev./Depth: 52.0'-54.0'

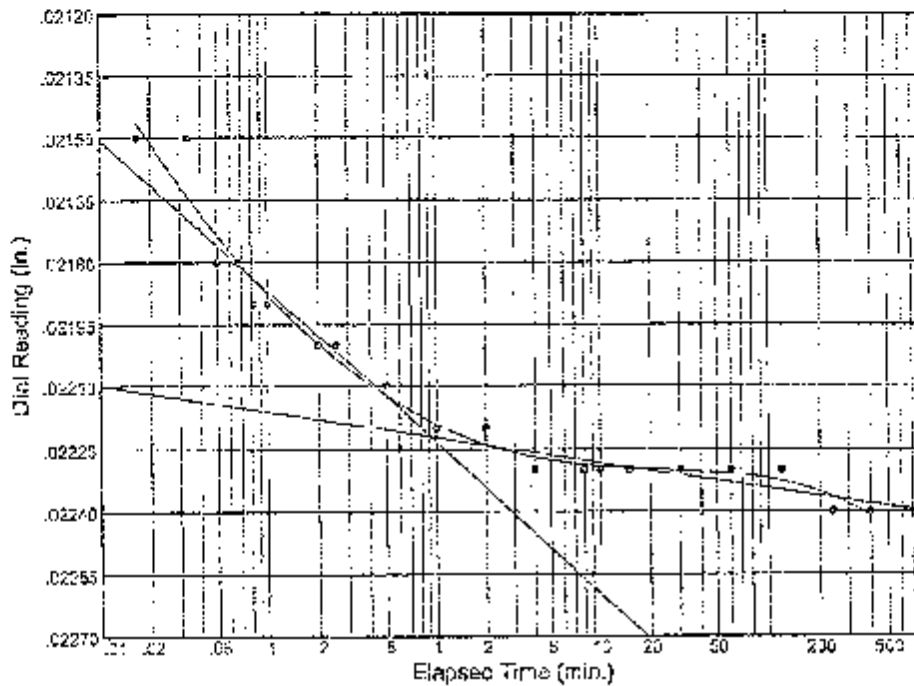

Load No. = 9  
 Load = 2.00 ksf  
 $D_0 = 0.02210$   
 $D_{50} = 0.02216$   
 $D_{100} = 0.02222$   
 $T_{50} = 0.71 \text{ min.}$

$C_v @ T_{50}$   
 0.38 ft./day

$C_\alpha = 0.000$

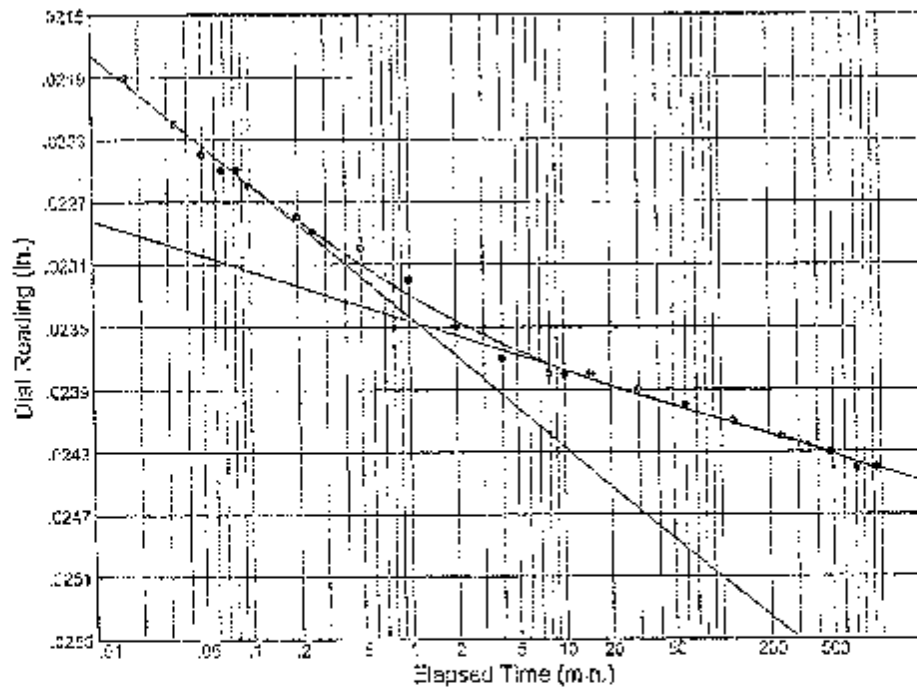

Load No. = 10  
 Load = 4.00 ksf  
 $D_0 = 0.02170$   
 $D_{50} = 0.02259$   
 $D_{100} = 0.02348$   
 $T_{50} = 0.10 \text{ min.}$

$C_v @ T_{50}$   
 2.69 ft./day

$C_\alpha = 0.000$

Jax FL.

### Dial Reading vs. Time

Project No.: 3C50090131.02  
 Project: Dike Drilling

Source: B-0904

Sample No.: UD-11

Elev./Depth: 52.9-54.7

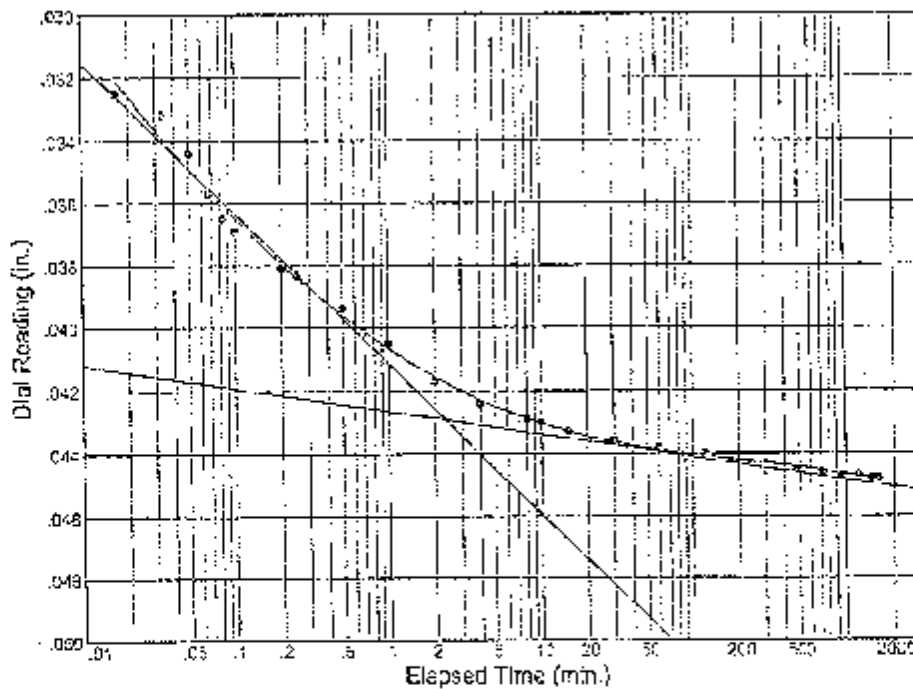
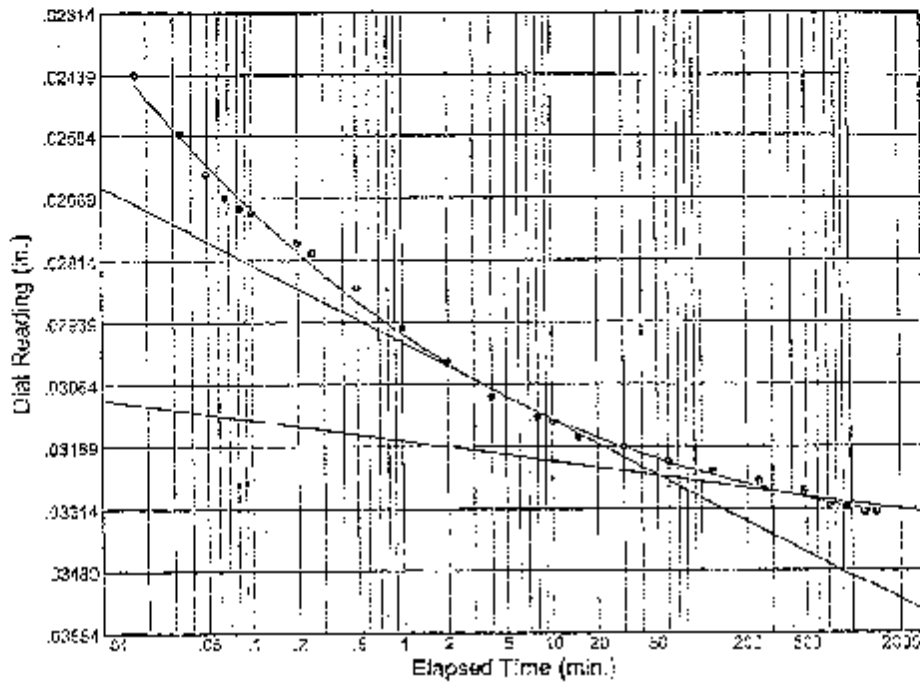

MACTEC Engineering and Consulting, Inc.

Jax FL.

### CONSOLIDATION TEST REPORT

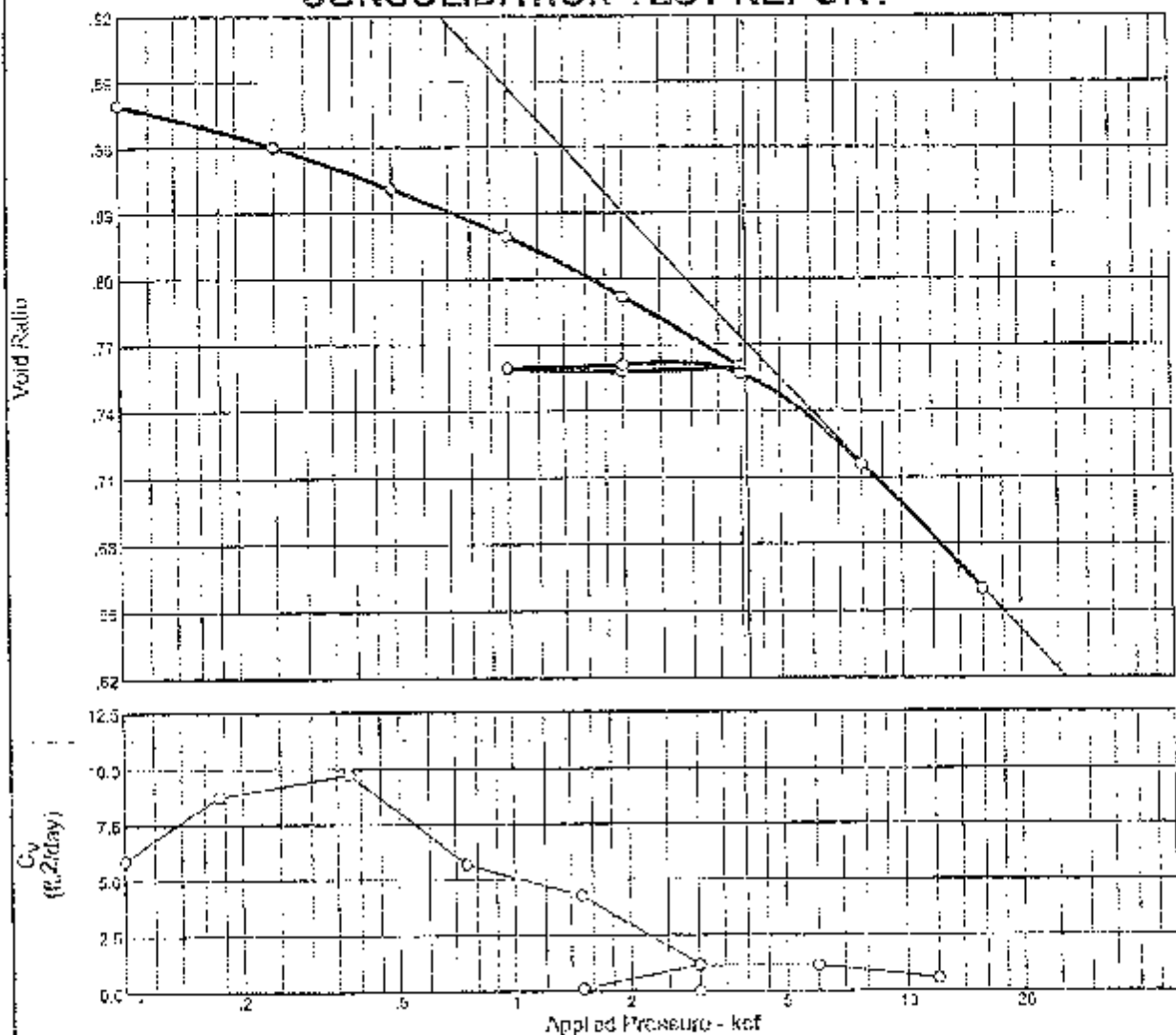

| MATERIAL DESCRIPTION  |    |         |                  |                  |       |                          |        | USCS                              | AASHTO    |              |                |                       |         |
|---|----|---------|------------------|------------------|-------|--------------------------|--------|-----------------------------------|-----------|--------------|----------------|-----------------------|---------|
| Gray and brown lean clay                                    |    |         |                  |                  |       |                          |        | CL                                | A-7-5(20) |              |                |                       |         |
| L   | P  | Sp. Gr. | Overburden (ksf) | Dry Dens. (pcf)  |       | Moisture                 |        | Saturation                        |           | Void Ratio   |                | Pc (ks <sup>2</sup> ) | Cc      |
|   |    |         |                  | Init.            | Final | Init.                    | Final  | Init.                             | Final     | Init.        | Final          |                       |         |
| 46  | 21 | 2.778   |                  | 97.0             |       | 31.9 %                   | 28.3 % | 100.0 %                           | 100.0 %   | 0.355        | 0.360          | 5.25                  | 0.19    |
| Preparation Process: Trimmed using cylindrical cutting ring |    |         |                  |                  |       |                          |        |                                   |           | D2435 Method | C <sub>r</sub> | Swell Press. (ksf)    | Heave % |
| Condition of Test: Natural moisture, inundated at 0.05 ksf  |    |         |                  |                  |       |                          |        |                                   |           | II           | 0.0            |                       |         |
| Project No. 203C09C131.02 Client: Amerian Electric Power    |    |         |                  |                  |       |                          |        | Remarks:                          |           |              |                |                       |         |
| Project: Dike Drilling                                      |    |         |                  |                  |       |                          |        | Percent Passing #200 sieve, 43.2% |           |              |                |                       |         |
| Source: E-6906  |    |         |                  | Sample No.: UD-6 |       | Elev./Depth: 22.0'-24.0' |        | Checked By: <i>Rami Subhwan</i>   |           |              |                |                       |         |
| CONSOLIDATION TEST REPORT                                   |    |         |                  |                  |       |                          |        | Title: <i>Rami Subhwan</i>        |           |              |                |                       |         |
| MACTEC ENGINEERING AND CONSULTING, INC.                     |    |         |                  |                  |       |                          |        | Jax FL                            |           |              |                |                       |         |

### Dial Reading vs. Time

Project No.: 3050090131.02  
 Project: Dike Drilling

Source: B-0906

Sample No.: UD-6

Elev./Depth: 22.0/24.0'

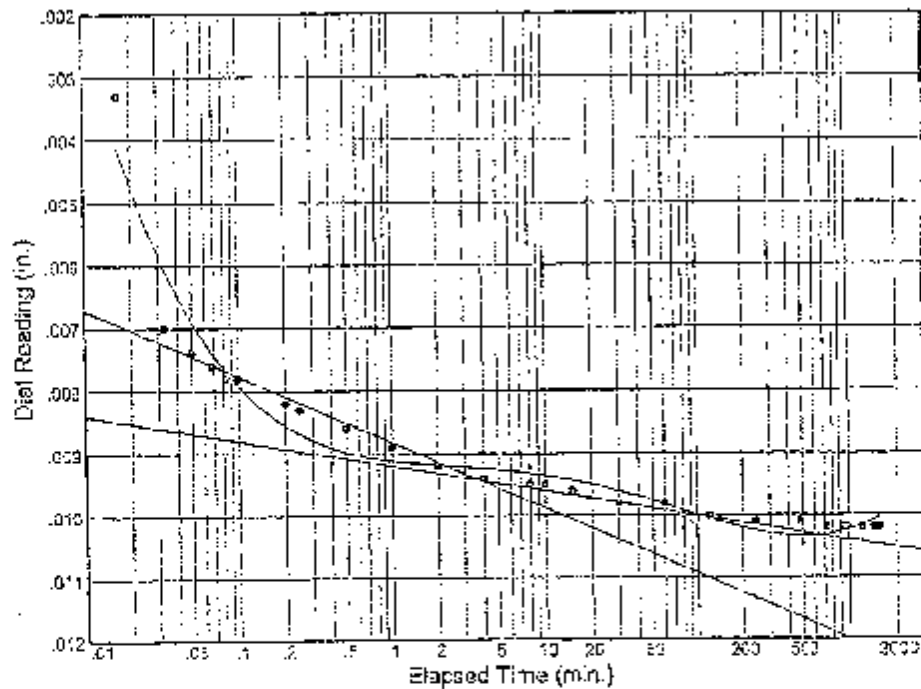
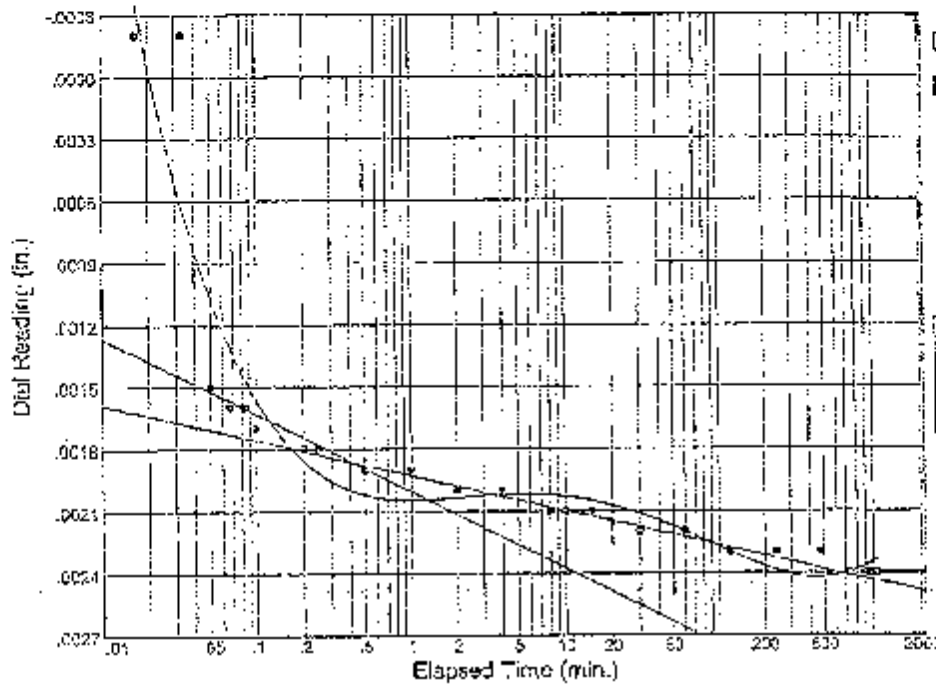

Jay FL

MACTEC Engineering and Consulting, Inc.

### Dial Reading vs. Time

Project No.: 305(090131.02  
 Project: Dike Drilling

Source: 3-0055

Sample No.: CD-6

Elev./Depth: 22.0'-24.8'

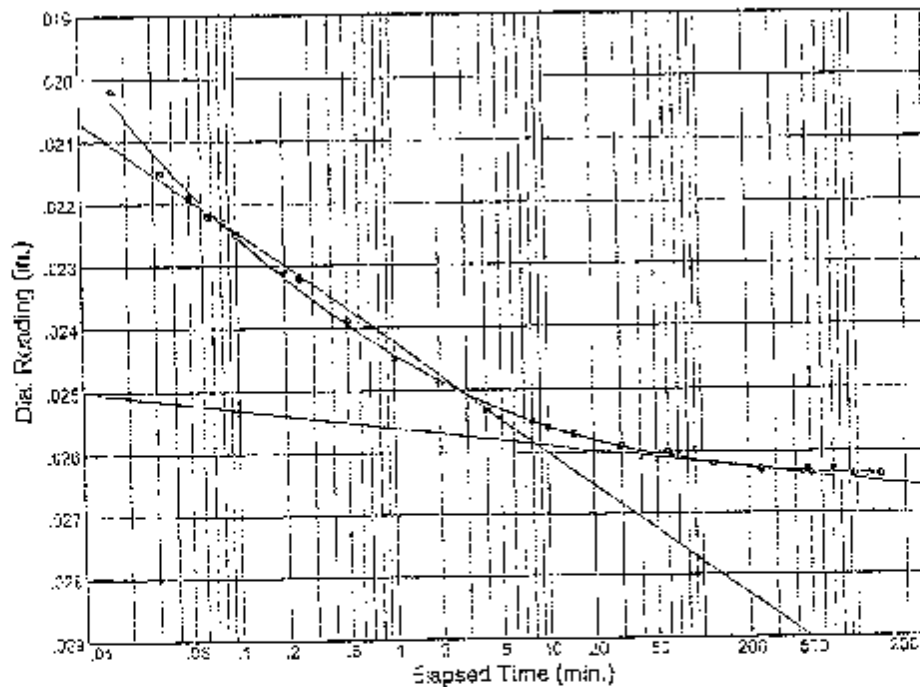
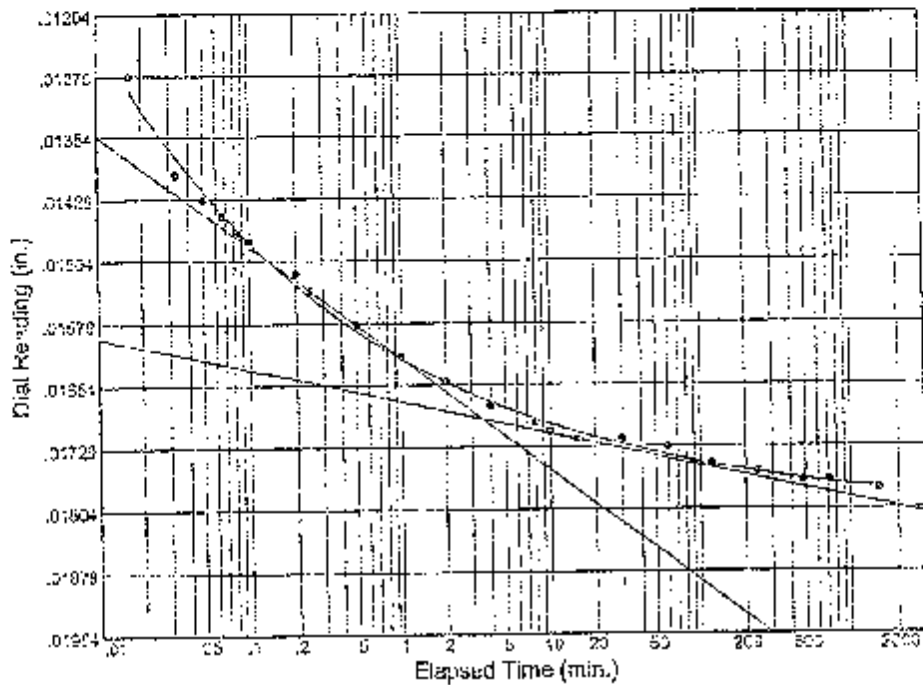

Jax FL.

MACTEC Engineering and Consulting, Inc.

### Dial Reading vs. Time

Project No.: 3050090131.02  
 Project: Dike Drilling

Source: B-0906

Sample No.: UD-6

Elev./Depth: 22.0'-24.0'

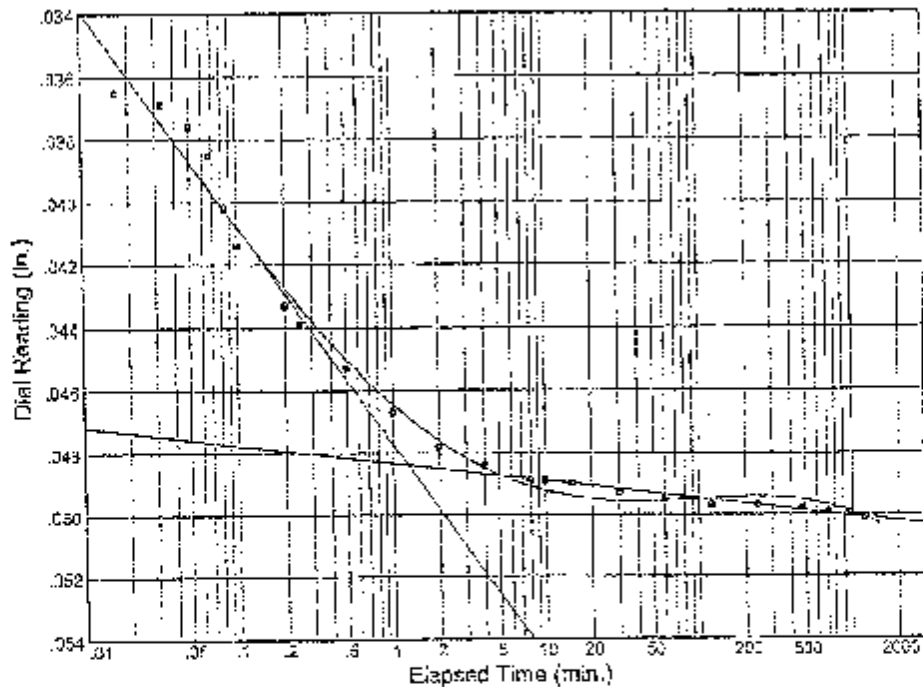
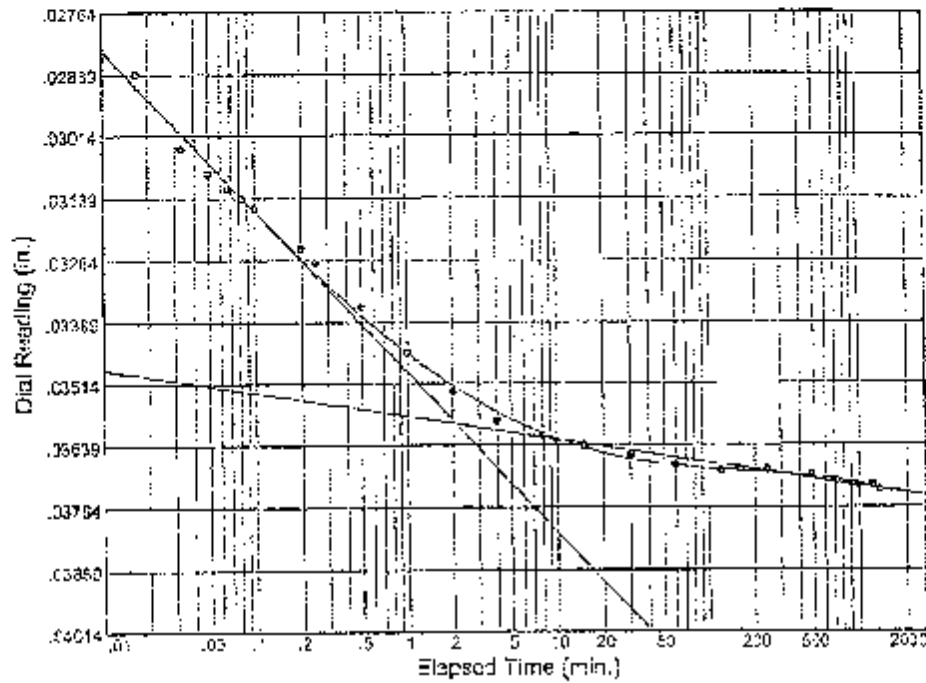

MACTEC Engineering and Consulting, Inc.

Jon F.



### Dial Reading vs. Time

Project No.: 3050090131.02  
 Project: Dike Drilling

Source: B-0906

Sample No.: 07D-6

Elev./Depth: 22.0-24.0

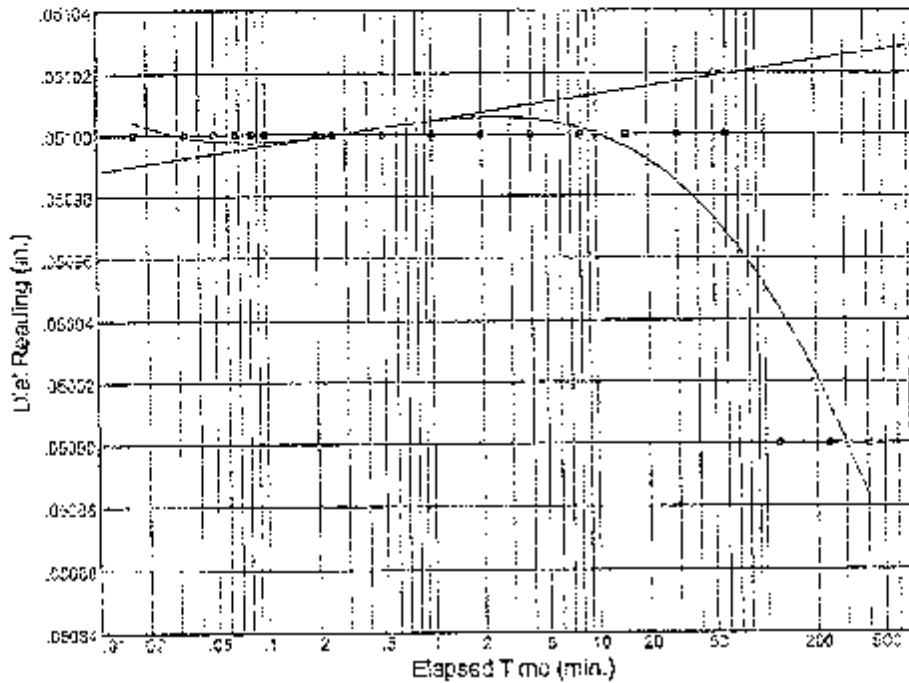

Load No. = 7

Load = 2.00 ksf

$D_0 = 0.05100$

$D_{50} = 0.05095$

$D_{100} = 0.05090$

$T_{50} = 102.71 \text{ min.}$

$C_v @ T_{50}$

0.00 ft<sup>2</sup>/day

$C_a = 0.000$

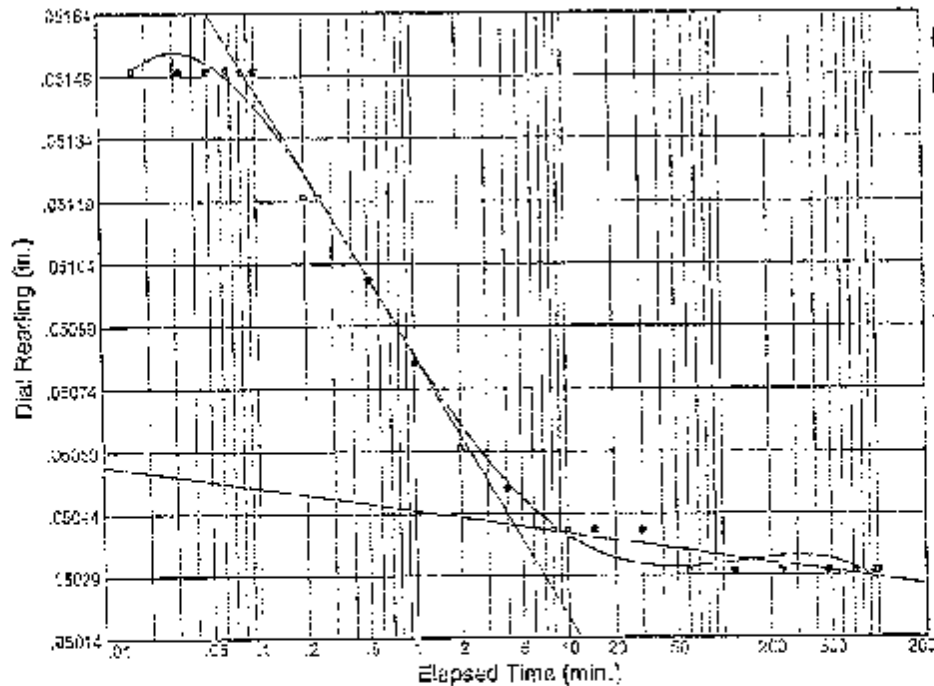

Load No. = 8

Load = 1.00 ksf

$D_0 = 0.05090$

$D_{50} = 0.05066$

$D_{100} = 0.05041$

$T_{50} = 2.01 \text{ min.}$

$C_v @ T_{50}$

0.12 ft<sup>2</sup>/day

MACTEC Engineering and Consulting, Inc.

Jax FL.

### Dial Reading vs. Time

Project No.: 3050000131.02  
 Project: Dike Drilling

Source: B-0906

Sample No.: U1-6

Elev./Depth: 22.0'-24.0'

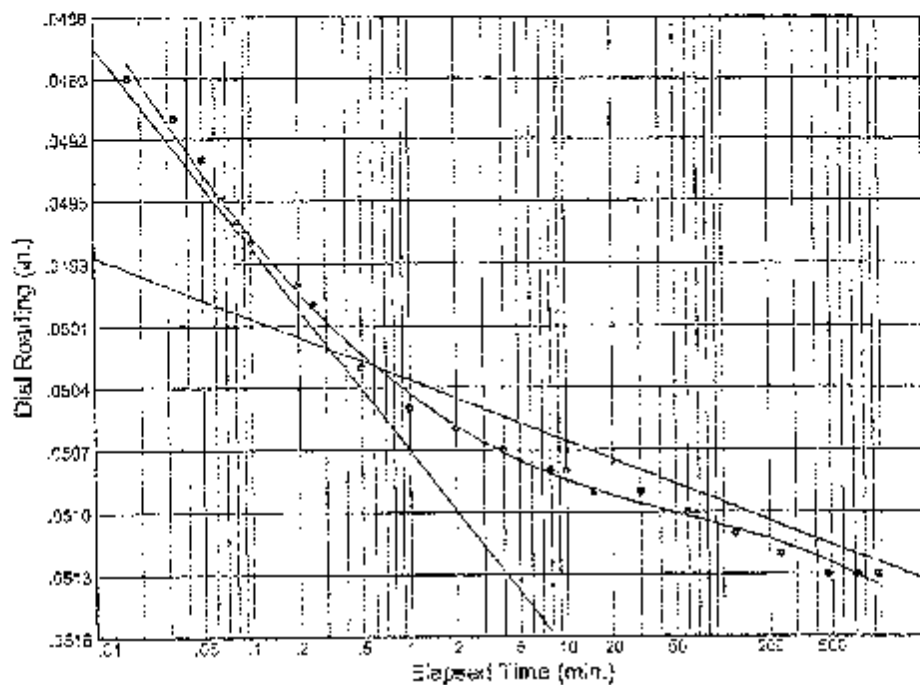

Load No.= 10  
 Load= 4.00 ksf  
 $D_0 = 0.04970$   
 $D_{50} = 0.04995$   
 $D_{100} = 0.05021$   
 $T_{50} = 0.21 \text{ min.}$

$C_v @ T_{50}$   
 1.14 ft.<sup>2</sup>/day

$C_a = 0.000$

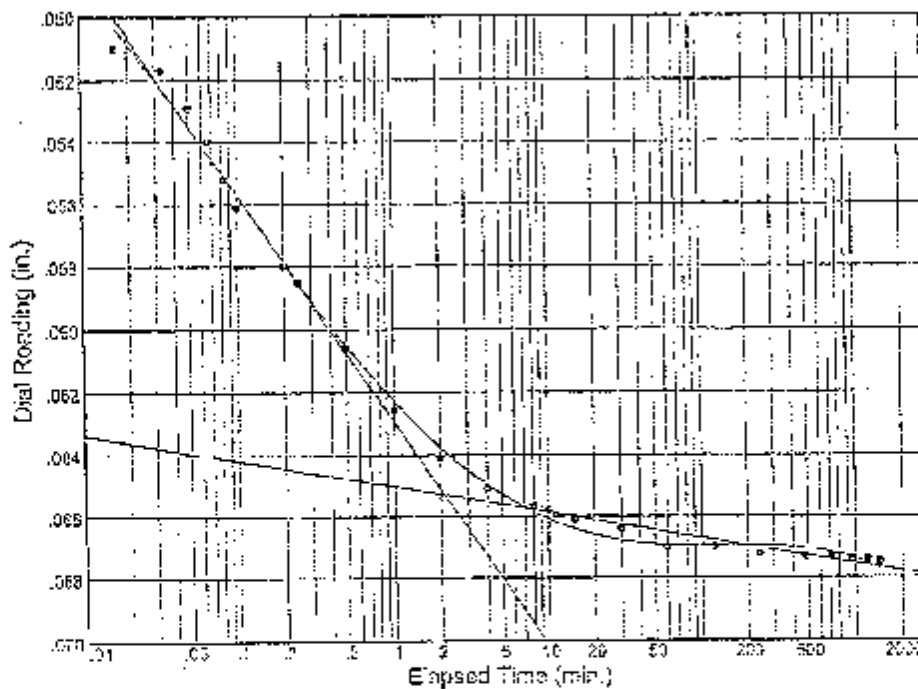

Load No.= 11  
 Load= 8.00 ksf  
 $D_0 = 0.05060$   
 $D_{50} = 0.05795$   
 $D_{100} = 0.06530$   
 $T_{50} = 0.21 \text{ min.}$

$C_v @ T_{50}$   
 1.13 ft.<sup>2</sup>/day

$C_a = 0.001$

MACTEC Engineering and Consulting, Inc.

(ax Fl.)

### Dial Reading vs. Time

Project No.: 3050090131.02  
Project: Dike Drilling

Source: B-0906

Sample No.: U7-6

Elev./Depth: 23.0-24.0

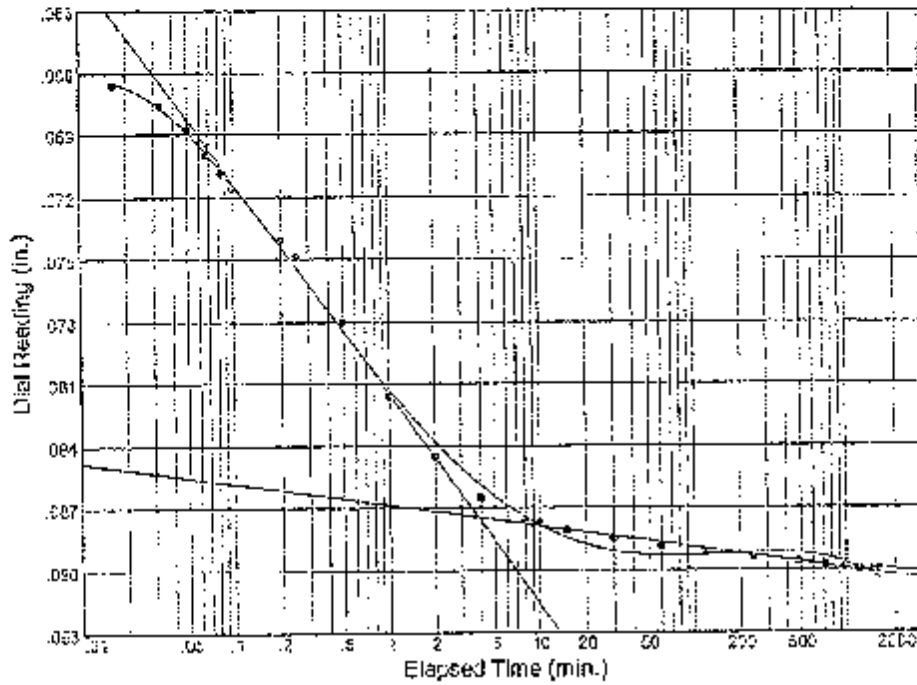

Load No. = 12  
Load = 16.00 ksf  
 $D_0 = 0.06750$   
 $D_{50} = 0.07749$   
 $D_{100} = 0.08747$   
 $T_{50} = 0.40 \text{ min.}$

$C_v @ T_{50}$   
0.55 ft./day

$C_{\alpha} = 0.001$



22010 Commerce Drive  
 Abingdon, Va. 24211  
 (276) 676-0426  
 (276) 676-0761

Density of Soil Specimens  
 ASTM D 7263 Method B

Project Name: AEP Dike Drilling  
 Project Number: 3050-09-0131  
 Boring Number: B-0903  
 Sample Number: UD-3  
 Depth: 34'-36'

Moisture Content

|         |                 |         |  |  |  |
|---------|-----------------|---------|--|--|--|
| Mass(g) | Tare + Wet Soil | 1241.47 |  |  |  |
|         | Tare + Dry Soil | 1016.53 |  |  |  |
|         | Water           | 224.94  |  |  |  |
|         | Tare            | 477.47  |  |  |  |
|         | Dry Soil        | 539.06  |  |  |  |
|         | Water Content % | 41.7282 |  |  |  |

Weight - Volume Relations

|                  |                  |        |        |        |        |
|------------------|------------------|--------|--------|--------|--------|
| Measurements(in) | Height           | 4.5920 | 4.5195 | 4.5760 | 4.5725 |
|                  | Average Height   | 4.59   |        |        |        |
|                  | Inside Diameter  | 2.8860 | 2.8760 | 2.8795 | 2.8870 |
|                  | Average Diameter | 2.8821 |        |        |        |

|          |               |        |
|----------|---------------|--------|
| Mass(lb) | Tare + Sample | 2.4085 |
|          | Tare          | 0.7152 |
|          | Sample        | 1.6932 |

Volume (PCF): 0.01731

Wet Density (PCF): 97.82

Dry Density (PCF): 69.02

Performed By: NCH 12/9/09

Reviewed By: RDR 12-9-09

US EPA ARCHIVE DOCUMENT



22010 Commerce Drive  
 Abingdon, Va. 24211  
 (276) 676-0426  
 (276) 676-0761

Density of Soil Specimens  
 ASTM D 7263 Method B

Project Name: AEP Dike Drilling  
 Project Number: 3050-09-0131  
 Boring Number: B-0907  
 Sample Number: UD-14  
 Depth: 57' - 59'

Moisture Content

|         |                 |         |  |  |  |
|---------|-----------------|---------|--|--|--|
| Mass(g) | Tare + Wet Soil | 937.03  |  |  |  |
|         | Tare + Dry Soil | 641.62  |  |  |  |
|         | Water           | 295.41  |  |  |  |
|         | Tare            | 166.3   |  |  |  |
|         | Dry Soil        | 475.32  |  |  |  |
|         | Water Content % | 62.1457 |  |  |  |

Weight - Volume Relations

|                   |                  |         |        |        |        |
|-------------------|------------------|---------|--------|--------|--------|
| Measurements(in.) | Height           | 4.6385  | 4.7175 | 4.7510 | 4.5880 |
|                   | Average Height   | 4.69875 |        |        |        |
|                   | Inside Diameter  | 2.8750  | 2.8770 | 2.8575 | 2.8790 |
|                   | Average Diameter | 2.8745  |        |        |        |

|           |               |        |
|-----------|---------------|--------|
| Mass (lb) | Tare + Sample | 2.4549 |
|           | Tare          | 0.7491 |
|           | Sample        | 1.7057 |

Volume (PCF): 0.0176  
 Wet Density (PCF): 96.92  
 Dry Density (PCF): 59.77

Performed By: 12/9/09 MCH

Reviewed By: RDR 12-9-09

US EPA ARCHIVE DOCUMENT

APPENDIX 3  
PIEZOMETER DATA

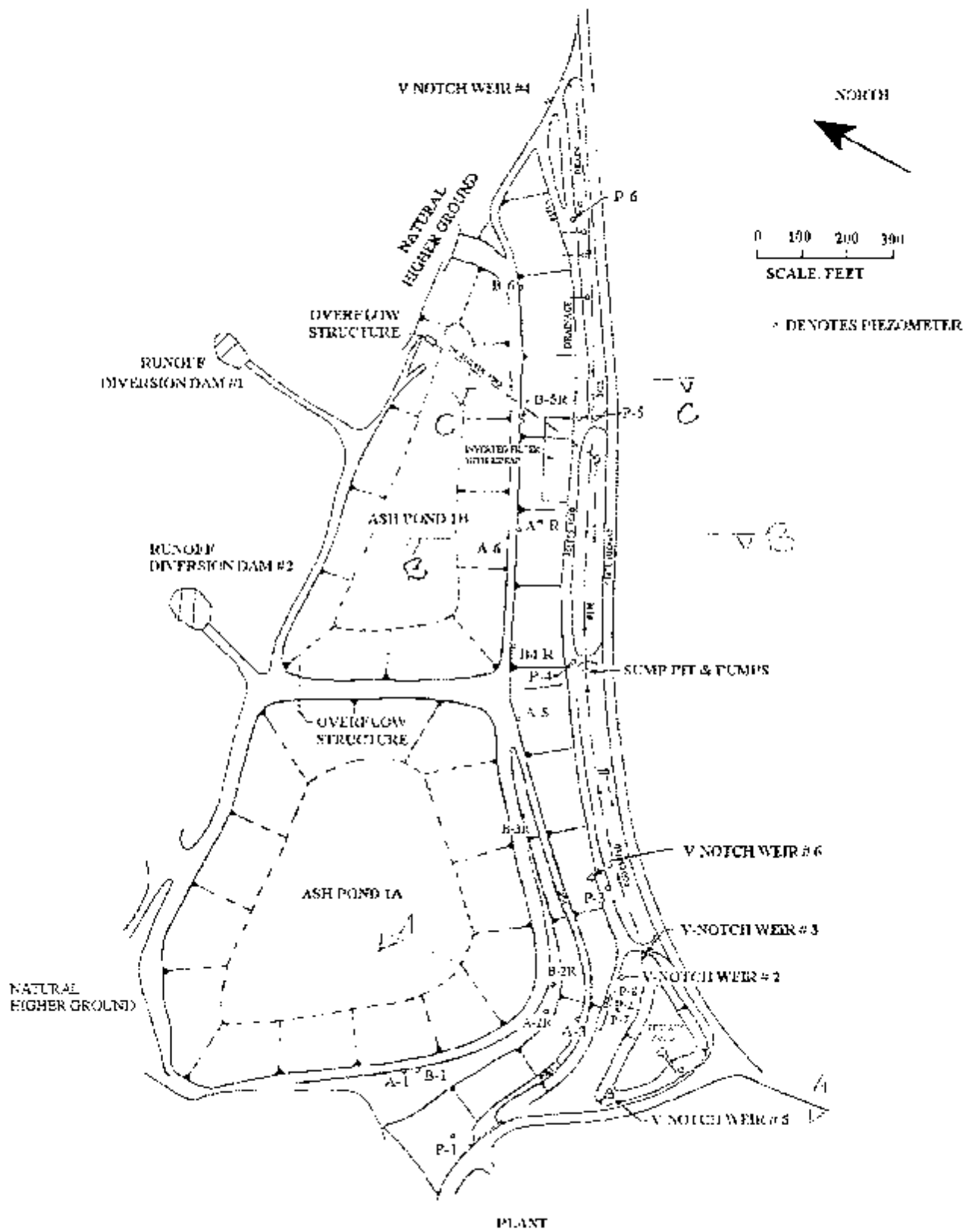

◆ A-1    ◆ A-2 R    ◆ A-3    ◆ A-5    ◆ A-6    ◆ A-7 R    ◆ B-1    ◆ B-2 R    ◆ B-3 R    ◆ B-4 R    ◆ B-5 R    ◆ B-6  
 P-1 R    P-2 R    P-3 R    P-4 R    P-5 R    P-6 R    P-7    P-8    P-0901S    P-0901D    P-0908S    P-0908D  
 P-0909    P-0904    P-0906    P-0902

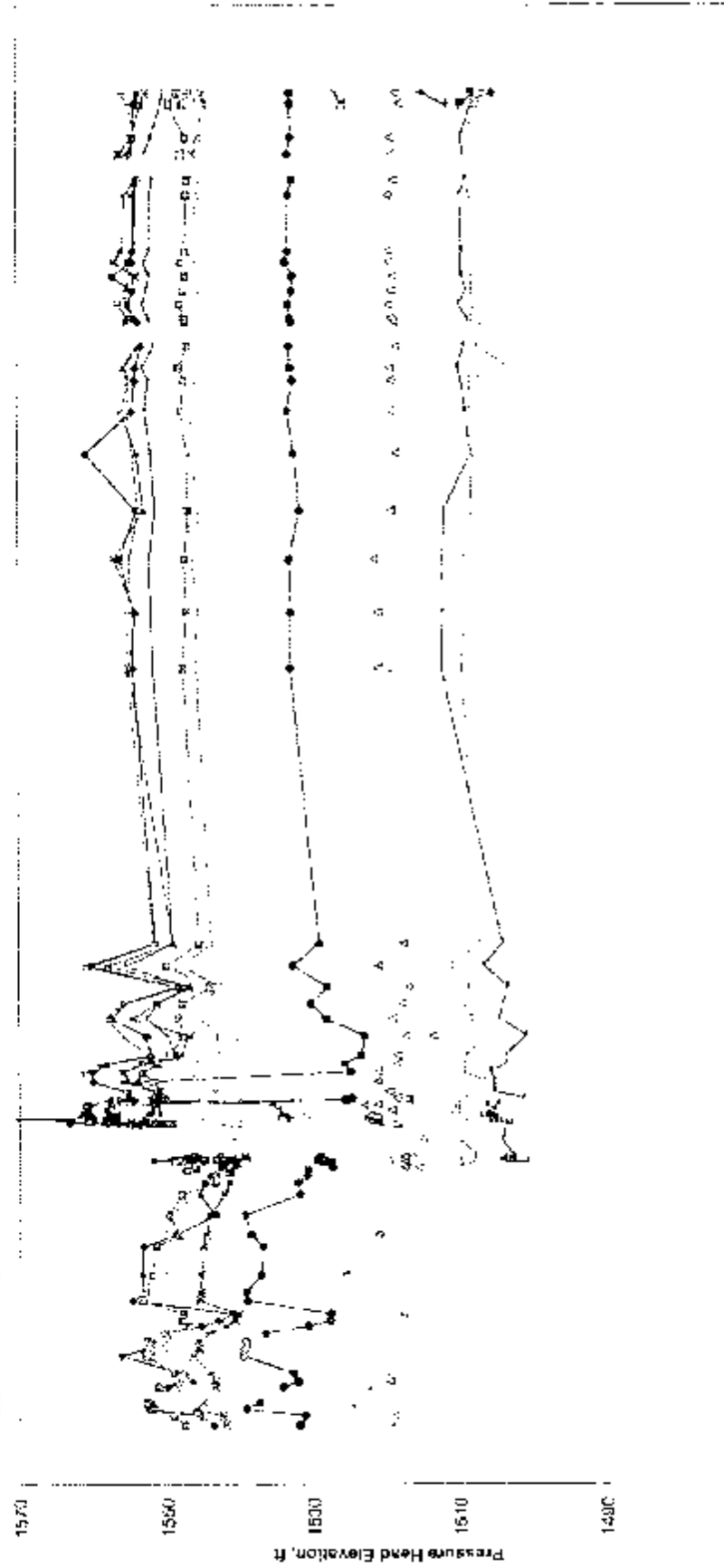

1470  
 09/01/54    05/25/67    02/22/69    11/18/92    06/15/65    05/11/68    02/04/61    11/01/63    07/28/66    04/23/69    01/18/72



APPENDIX 4

**SEEPAGE AND STABILITY MODEL INPUTS**

Section A

**SEEP/W Analysis**

Source: <https://www.epa.gov/epaosopr/odp/records/epaosopr-odp-record-0198>

Section A

**Miscellanea**

**Outer shell: Fly sand and shale fragment**

Model **Function: Fly sand and shale fragment**  
 Hydraulic  
 Reference: [unclear]  
 Vol. WC Function: [unclear]  
 K Sat: [unclear]  
 K Unsat: [unclear]

**Top Crust 10'**

Model **Function: Top Crust 10'**  
 Hydraulic  
 K Function: [unclear]  
 Vol. WC Function: [unclear]  
 K Sat: [unclear]  
 K Unsat: [unclear]  
**Original: Fly sand and shale fragment**  
 Model **Function: Fly sand and shale fragment**  
 Hydraulic  
 K Function: [unclear]  
 Vol. WC Function: [unclear]  
 K Sat: [unclear]  
 K Unsat: [unclear]

**Confined Layer**

Model **Function: Confined Layer**  
 Hydraulic  
 K Function: [unclear]  
 Vol. WC Function: [unclear]  
 K Sat: [unclear]  
 K Unsat: [unclear]

**Fly ash**

Model **Function: Fly ash**  
 Hydraulic  
 K Function: [unclear]  
 Vol. WC Function: [unclear]  
 K Sat: [unclear]  
 K Unsat: [unclear]

**Fundamentals Fly sand and shale fragment**

Model **Function: Fundamentals Fly sand and shale fragment**  
 Hydraulic  
 K Function: [unclear]  
 Vol. WC Function: [unclear]  
 K Sat: [unclear]  
 K Unsat: [unclear]

**File Information**

Created by: [unclear]  
 Revision Number: 75  
 Last Edited: 12/13/83  
 Date: 12/13/83  
 Time: 11:00 AM  
 File Name: [unclear]  
 Path: [unclear]

**Project Settings**

Initial Flow Rate: [unclear]  
 Time to Flow: [unclear]  
 Initial Head: [unclear]  
 Mass Flow Rate: [unclear]  
 Initial Weight of Water: [unclear]  
 View: [unclear]

**Analysis Settings**

**SEEP/W Analysis**  
 Description: [unclear]  
 K: 0.001  
 Vol. WC: [unclear]  
 Sat: [unclear]  
 Initial Head: [unclear]  
 Initial Flow Rate: [unclear]  
 Include Air Flow: [unclear]  
 Control: [unclear]  
 Consistency: [unclear]  
 Maximum Number of Iterations: [unclear]  
 Tolerance: [unclear]  
 Minimum Change in Head: [unclear]  
 Rate of Change in K: [unclear]  
 Minimum Change in K: [unclear]  
 Equilibrium Saturation: [unclear]  
 Potential Average Head in Reviews: [unclear]  
**Time**  
 Starting Time: [unclear]  
 Duration: [unclear]  
 End Step: [unclear]  
 Step Generation Method: [unclear]  
 Step Size Decay: [unclear]  
 Use Adaptive Time Stepping: [unclear]

Section A

SP6-Block  
 Model: SP6-Block  
 Hydrology  
 K Slope: 0.01  
 Manning's Water Content: 0.01  
 Manning's Water Content: 0.01  
 Manning's Water Content: 0.01  
 Manning's Water Content: 0.01  
 Manning's Water Content: 0.01

Original Base Layer  
 Model: Original Base Layer  
 Hydrology  
 Manning's Water Content: 0.01  
 Manning's Water Content: 0.01  
 Manning's Water Content: 0.01  
 Manning's Water Content: 0.01  
 Manning's Water Content: 0.01

Original Base Layer  
 Model: Original Base Layer  
 Hydrology  
 Manning's Water Content: 0.01  
 Manning's Water Content: 0.01  
 Manning's Water Content: 0.01  
 Manning's Water Content: 0.01  
 Manning's Water Content: 0.01

Weathered shale  
 Model: Weathered shale  
 Hydrology  
 Manning's Water Content: 0.01  
 Manning's Water Content: 0.01  
 Manning's Water Content: 0.01  
 Manning's Water Content: 0.01  
 Manning's Water Content: 0.01

Second Block  
 Model: Second Block  
 Hydrology  
 Manning's Water Content: 0.01  
 Manning's Water Content: 0.01  
 Manning's Water Content: 0.01  
 Manning's Water Content: 0.01  
 Manning's Water Content: 0.01

Second Block  
 Model: Second Block  
 Hydrology  
 Manning's Water Content: 0.01  
 Manning's Water Content: 0.01  
 Manning's Water Content: 0.01  
 Manning's Water Content: 0.01  
 Manning's Water Content: 0.01

Second Block  
 Model: Second Block  
 Hydrology  
 Manning's Water Content: 0.01  
 Manning's Water Content: 0.01  
 Manning's Water Content: 0.01  
 Manning's Water Content: 0.01  
 Manning's Water Content: 0.01

Section A

Model: Section A  
 Hydrology  
 Manning's Water Content: 0.01  
 Manning's Water Content: 0.01  
 Manning's Water Content: 0.01  
 Manning's Water Content: 0.01  
 Manning's Water Content: 0.01

Boundary Conditions

DuPont's Soap Factory  
 Model: DuPont's Soap Factory  
 Hydrology  
 Manning's Water Content: 0.01  
 Manning's Water Content: 0.01  
 Manning's Water Content: 0.01  
 Manning's Water Content: 0.01  
 Manning's Water Content: 0.01

Constant Head  
 Model: Constant Head  
 Hydrology  
 Manning's Water Content: 0.01  
 Manning's Water Content: 0.01  
 Manning's Water Content: 0.01  
 Manning's Water Content: 0.01  
 Manning's Water Content: 0.01

Initial Water Tables  
 Model: Initial Water Tables  
 Hydrology  
 Manning's Water Content: 0.01  
 Manning's Water Content: 0.01  
 Manning's Water Content: 0.01  
 Manning's Water Content: 0.01  
 Manning's Water Content: 0.01

Flux Section 1  
 Model: Flux Section 1  
 Hydrology  
 Manning's Water Content: 0.01  
 Manning's Water Content: 0.01  
 Manning's Water Content: 0.01  
 Manning's Water Content: 0.01  
 Manning's Water Content: 0.01

Flux Section 2  
 Model: Flux Section 2  
 Hydrology  
 Manning's Water Content: 0.01  
 Manning's Water Content: 0.01  
 Manning's Water Content: 0.01  
 Manning's Water Content: 0.01  
 Manning's Water Content: 0.01

Flux Section 3  
 Model: Flux Section 3  
 Hydrology  
 Manning's Water Content: 0.01  
 Manning's Water Content: 0.01  
 Manning's Water Content: 0.01  
 Manning's Water Content: 0.01  
 Manning's Water Content: 0.01

Flux Section 4  
 Model: Flux Section 4  
 Hydrology  
 Manning's Water Content: 0.01  
 Manning's Water Content: 0.01  
 Manning's Water Content: 0.01  
 Manning's Water Content: 0.01  
 Manning's Water Content: 0.01

840939-A

840939-A

140069348  
 Coordinates: 131.1772, 41  
 Coordinate Units: UTM

**K Functions**

**Outer shell: clays/sand**

Model: 3-2-1-1-1  
 Function: K Function Estimator Method  
 Curve Fit: Data Fit  
 Segment: 1 (Volume: 0.00)

K Factor: 0.0000000000

Data Point: 1 (0.00, 0.00)

Data Point: 2 (0.00, 0.00)

Data Point: 3 (0.00, 0.00)

Data Point: 4 (0.00, 0.00)

Data Point: 5 (0.00, 0.00)

Data Point: 6 (0.00, 0.00)

Data Point: 7 (0.00, 0.00)

Data Point: 8 (0.00, 0.00)

Data Point: 9 (0.00, 0.00)

Data Point: 10 (0.00, 0.00)

Data Point: 11 (0.00, 0.00)

Data Point: 12 (0.00, 0.00)

Data Point: 13 (0.00, 0.00)

Data Point: 14 (0.00, 0.00)

Data Point: 15 (0.00, 0.00)

Data Point: 16 (0.00, 0.00)

Data Point: 17 (0.00, 0.00)

Data Point: 18 (0.00, 0.00)

Data Point: 19 (0.00, 0.00)

Data Point: 20 (0.00, 0.00)

Data Point: 21 (0.00, 0.00)

Data Point: 22 (0.00, 0.00)

Data Point: 23 (0.00, 0.00)

Data Point: 24 (0.00, 0.00)

Data Point: 25 (0.00, 0.00)

Data Point: 26 (0.00, 0.00)

Data Point: 27 (0.00, 0.00)

Data Point: 28 (0.00, 0.00)

Data Point: 29 (0.00, 0.00)

Data Point: 30 (0.00, 0.00)

Data Point: 31 (0.00, 0.00)

Data Point: 32 (0.00, 0.00)

Data Point: 33 (0.00, 0.00)

Data Point: 34 (0.00, 0.00)

Data Point: 35 (0.00, 0.00)

Data Point: 36 (0.00, 0.00)

Data Point: 37 (0.00, 0.00)

Data Point: 38 (0.00, 0.00)

Data Point: 39 (0.00, 0.00)

Data Point: 40 (0.00, 0.00)

840939-A

140069348  
 Coordinates: 131.1772, 41  
 Coordinate Units: UTM

**K Functions**

**Outer shell: clays/sand**

Model: 3-2-1-1-1  
 Function: K Function Estimator Method  
 Curve Fit: Data Fit  
 Segment: 1 (Volume: 0.00)

K Factor: 0.0000000000

Data Point: 1 (0.00, 0.00)

Data Point: 2 (0.00, 0.00)

Data Point: 3 (0.00, 0.00)

Data Point: 4 (0.00, 0.00)

Data Point: 5 (0.00, 0.00)

Data Point: 6 (0.00, 0.00)

Data Point: 7 (0.00, 0.00)

Data Point: 8 (0.00, 0.00)

Data Point: 9 (0.00, 0.00)

Data Point: 10 (0.00, 0.00)

Data Point: 11 (0.00, 0.00)

Data Point: 12 (0.00, 0.00)

Data Point: 13 (0.00, 0.00)

Data Point: 14 (0.00, 0.00)

Data Point: 15 (0.00, 0.00)

Data Point: 16 (0.00, 0.00)

Data Point: 17 (0.00, 0.00)

Data Point: 18 (0.00, 0.00)

Data Point: 19 (0.00, 0.00)

Data Point: 20 (0.00, 0.00)

Data Point: 21 (0.00, 0.00)

Data Point: 22 (0.00, 0.00)

Data Point: 23 (0.00, 0.00)

Data Point: 24 (0.00, 0.00)

Data Point: 25 (0.00, 0.00)

Data Point: 26 (0.00, 0.00)

Data Point: 27 (0.00, 0.00)

Data Point: 28 (0.00, 0.00)

Data Point: 29 (0.00, 0.00)

Data Point: 30 (0.00, 0.00)

Data Point: 31 (0.00, 0.00)

Data Point: 32 (0.00, 0.00)

Data Point: 33 (0.00, 0.00)

Data Point: 34 (0.00, 0.00)

Data Point: 35 (0.00, 0.00)

Data Point: 36 (0.00, 0.00)

Data Point: 37 (0.00, 0.00)

Data Point: 38 (0.00, 0.00)

Data Point: 39 (0.00, 0.00)

Data Point: 40 (0.00, 0.00)

Data Point: 41 (0.00, 0.00)

Data Point: 42 (0.00, 0.00)

Data Point: 43 (0.00, 0.00)

Data Point: 44 (0.00, 0.00)

Data Point: 45 (0.00, 0.00)

Data Point: 46 (0.00, 0.00)

Data Point: 47 (0.00, 0.00)

Data Point: 48 (0.00, 0.00)

Data Point: 49 (0.00, 0.00)

Data Point: 50 (0.00, 0.00)



Section A

Hydra. C.A. Sec. A. 1/1/80  
 Proj. # Function Column Material: 101-101-K-101  
 Material: 101  
 Minimum: 1.0  
 Max: 100.0  
 Name: Water  
 Material: Water

Hydraulic Boundary Functions

Year Level: Year  
 Model: 101-101-K-101  
 Function: 101-101-K-101  
 Name: Water  
 Material: Water  
 Minimum: 1.0  
 Maximum: 100.0  
 Name: Water

Vol. Water Contents Functions

Function: 101-101-K-101  
 Name: Water  
 Material: Water  
 Minimum: 1.0  
 Maximum: 100.0  
 Name: Water

Section A

Hydra. C.A. Sec. A. 1/1/80  
 Proj. # Function Column Material: 101-101-K-101  
 Material: 101  
 Minimum: 1.0  
 Max: 100.0  
 Name: Water  
 Material: Water

Material: 101  
 Name: Water  
 Minimum: 1.0  
 Maximum: 100.0  
 Name: Water

Vol. Water Contents Functions

Function: 101-101-K-101  
 Name: Water  
 Material: Water  
 Minimum: 1.0  
 Maximum: 100.0  
 Name: Water







Section A

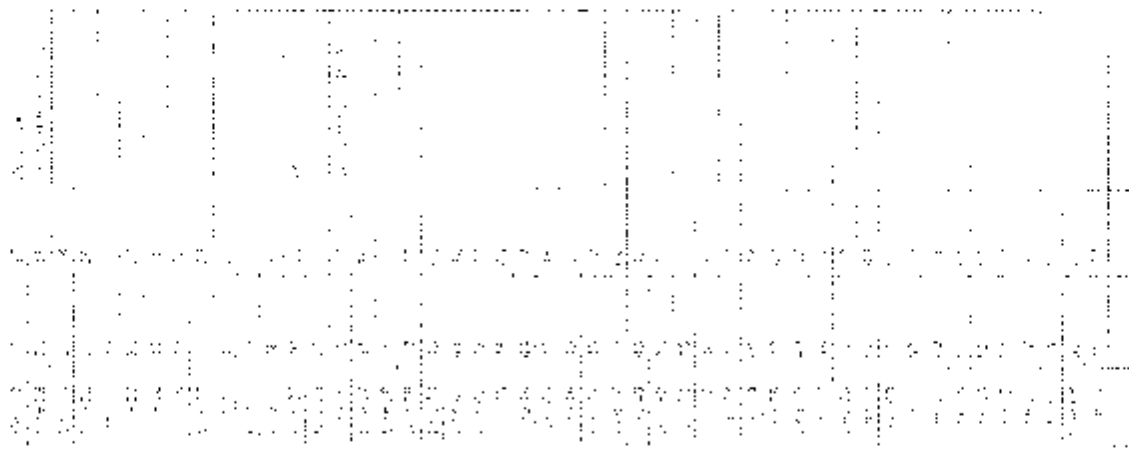

Section A

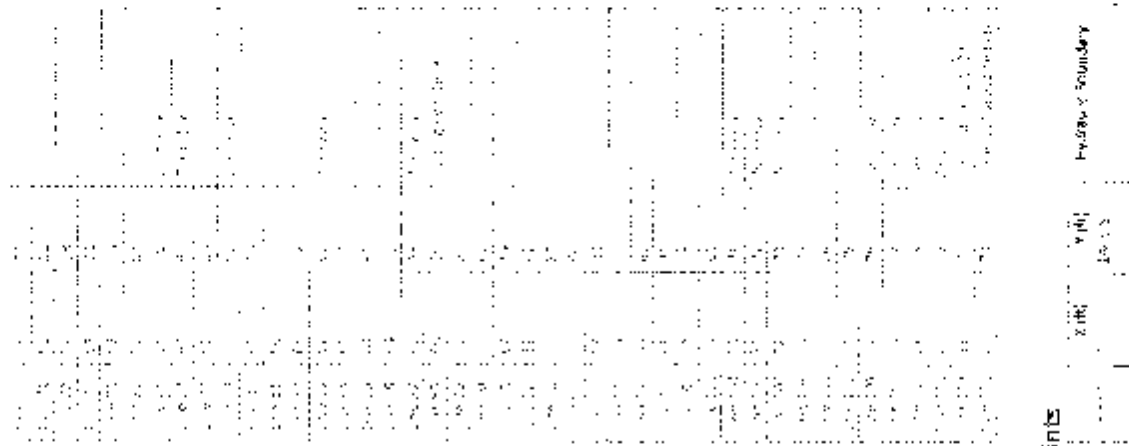

Section A

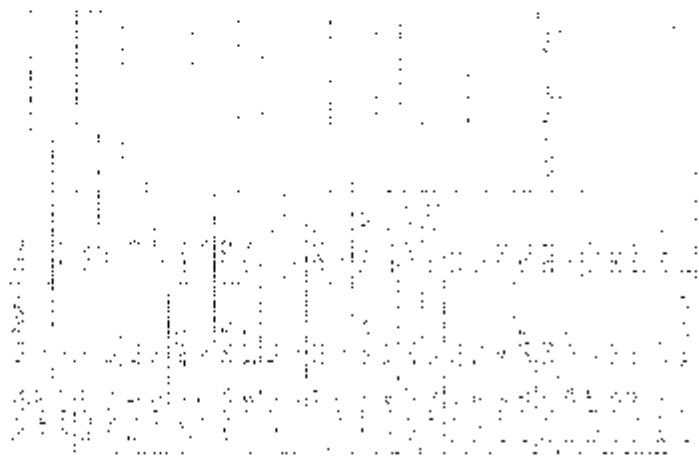

Section A

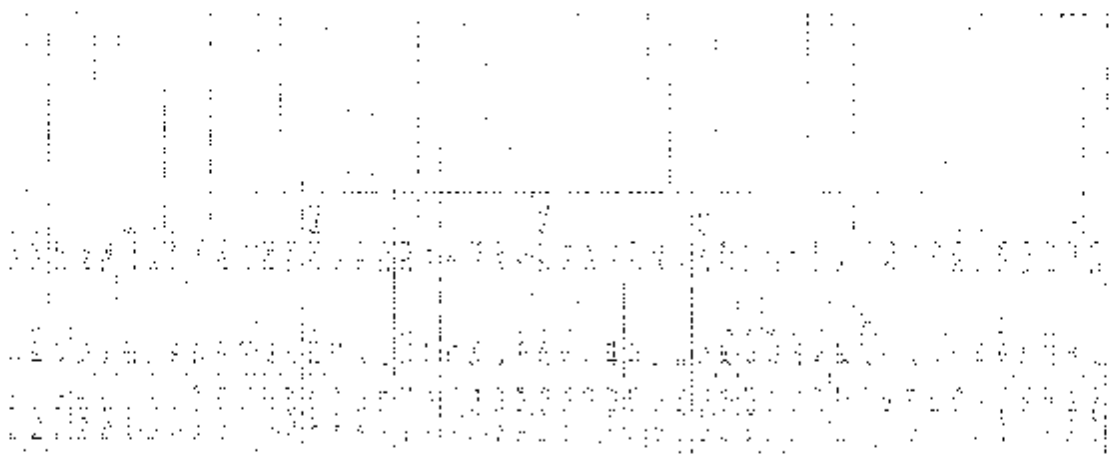

Section II

SEEP/W Analysis

Path: C:\msdost\mgp\help\winhelp\11 - SEEP/W ANALYSIS - 02-10-2001

File Information

Created By: User Name  
Res Size Number: 75  
Last Edited By: R. M. Anderson  
Date: 11-03-2000  
Time: 11:30:11  
File Name: 1960  
Directory: C:\msdost\mgp\help\winhelp\11 - SEEP/W ANALYSIS - 02-10-2001

Project Settings

Length: 10.000000  
Length Units: Feet  
Permeability Units: Darcy  
Pressure Unit: Psi  
Mass Density: 1.94  
Min. Porosity: 0.000000  
Min. Weighted Water: 0.000000  
View: 2

Analysis Settings

SEEP/W Analysis  
Deposition: No  
Kind: 2D - N  
Method: Picard  
Settings  
In File: SWP (SWP) - 1960  
Control: Picard for Picard  
Convergence  
Maximum Number of Iterations: 10  
Tolerance: 1.0E-05  
Maximum Change in K: 1  
Size of Change Log: 10  
Maximum Change in K: 1.0E-05  
Equation Solver: Picard  
Potential Seepage Max # of Reviews: 5  
Time  
Starting Time: 0.00  
Function: 0000  
# of Steps: 100  
Step Generation Method: Picard  
Save Step: Every 10  
Use Adaptive Time Stepping: No

Section II

SEEP/W Analysis

Overhead - Hand-raising  
Model: Seepage  
Hydraulic  
KFunction: Picard  
Vp-WC Function: Seepage  
K Ratio: 1  
K Direction: 2

Fluid Properties

Model: Seepage  
Hydraulic  
KFunction: Picard  
Vp-WC Function: Seepage  
K Ratio: 1  
K Direction: 2  
Original Density with Gravity  
Model: Seepage  
Hydraulic  
KFunction: Picard  
Vp-WC Function: Seepage  
K Ratio: 1  
K Direction: 2  
Compacted Ash - First Mixing  
Model: Seepage  
Hydraulic  
KFunction: Picard  
Vp-WC Function: Seepage  
K Ratio: 1  
K Direction: 2

PI 1960

Model: Seepage  
Hydraulic  
KFunction: Picard  
Vp-WC Function: Seepage  
K Ratio: 1  
K Direction: 2  
K Sat: 0.000000  
Volumetric Water Content: 0.000000  
Max: 1  
K Ratio: 1  
K Direction: 2

SEEP/W Analysis - Total Seepage (GAL/DAY)

Model: Seepage  
Hydraulic  
KFunction: Picard  
Vp-WC Function: Seepage  
K Ratio: 1  
K Direction: 2  
Volumetric Water Content: 0.000000  
Max: 1  
K Ratio: 1  
K Direction: 2



Section B

Flux Section 3

Coordinates: 2 14318  
 Coordinate S: 14318

K Functions

Conc: 0.00000000000000000000  
 Model: 2  
 Function: 1  
 Curve Fit: 1

Segment Curvature: 0.0000  
 K Saturation: 0.0000  
 Data Point: 1  
 Data Point: 2  
 Data Point: 3  
 Data Point: 4  
 Data Point: 5  
 Data Point: 6  
 Data Point: 7  
 Data Point: 8  
 Data Point: 9  
 Data Point: 10  
 Data Point: 11  
 Data Point: 12  
 Data Point: 13  
 Data Point: 14  
 Data Point: 15  
 Data Point: 16  
 Data Point: 17  
 Data Point: 18  
 Data Point: 19  
 Data Point: 20

Volume Water Content Function: 0.00000000000000000000  
 Hydraulic K Sat: 0.00000000000000000000  
 Hyd K Function: 0.00000000000000000000  
 Maximum: 0.00000000000000000000  
 Minimum: 0.00000000000000000000  
 Residual Water Content: 0.00000000000000000000

Flux Section 3  
 Volume Water Content Function: 0.00000000000000000000  
 Hydraulic K Sat: 0.00000000000000000000  
 Hyd K Function: 0.00000000000000000000  
 Maximum: 0.00000000000000000000  
 Minimum: 0.00000000000000000000  
 Residual Water Content: 0.00000000000000000000

Conc: 0.00000000000000000000  
 Model: 2  
 Function: 1  
 Curve Fit: 1  
 Segment Curvature: 0.0000  
 K Sat: 0.00000000000000000000  
 Data Point: 1  
 Data Point: 2

Section B

Data Point: 1  
 Data Point: 2  
 Data Point: 3  
 Data Point: 4  
 Data Point: 5  
 Data Point: 6  
 Data Point: 7  
 Data Point: 8  
 Data Point: 9  
 Data Point: 10  
 Data Point: 11  
 Data Point: 12  
 Data Point: 13  
 Data Point: 14  
 Data Point: 15  
 Data Point: 16  
 Data Point: 17  
 Data Point: 18  
 Data Point: 19  
 Data Point: 20

Volume Water Content Function: 0.00000000000000000000  
 Hydraulic K Sat: 0.00000000000000000000  
 Hyd K Function: 0.00000000000000000000  
 Maximum: 0.00000000000000000000  
 Minimum: 0.00000000000000000000  
 Residual Water Content: 0.00000000000000000000

Original Disk-only with 32MB

Volume Water Content Function: 0.00000000000000000000  
 Hydraulic K Sat: 0.00000000000000000000  
 Hyd K Function: 0.00000000000000000000  
 Maximum: 0.00000000000000000000  
 Minimum: 0.00000000000000000000  
 Residual Water Content: 0.00000000000000000000

Volume Water Content Function: 0.00000000000000000000  
 Hydraulic K Sat: 0.00000000000000000000  
 Hyd K Function: 0.00000000000000000000  
 Maximum: 0.00000000000000000000  
 Minimum: 0.00000000000000000000  
 Residual Water Content: 0.00000000000000000000

Volume Water Content Function: 0.00000000000000000000  
 Hydraulic K Sat: 0.00000000000000000000  
 Hyd K Function: 0.00000000000000000000  
 Maximum: 0.00000000000000000000  
 Minimum: 0.00000000000000000000  
 Residual Water Content: 0.00000000000000000000

Section 11

Estimation Procedure:  
 Volume Water Content Function:  $0.0014 \cdot \text{Depth} + 0.0001 \cdot \text{Year}$   
 Hydraulic Conductivity:  $0.0001 \cdot \text{Year}$   
 Hyd. K Function Estimation Method:  $\text{Depth} \cdot \text{Year} \cdot \text{Year}$   
 Maximum: 0.001  
 Minimum: 0.0001  
 Num. Points: 30  
 Residual Water Content: 0.0001

The Chloride Ion

Model:  $\text{Chloride} = \text{Year} \cdot \text{Year} \cdot \text{Year}$   
 Function:  $\text{Chloride} = \text{Year} \cdot \text{Year} \cdot \text{Year}$   
 Gradient Convolution: 1.000  
 K: 0.0001  
 Data Points: 30  
 Data Point: 1, 0.0001  
 Data Point: 2, 0.0001  
 Data Point: 3, 0.0001  
 Data Point: 4, 0.0001  
 Data Point: 5, 0.0001  
 Data Point: 6, 0.0001  
 Data Point: 7, 0.0001  
 Data Point: 8, 0.0001  
 Data Point: 9, 0.0001  
 Data Point: 10, 0.0001  
 Data Point: 11, 0.0001  
 Data Point: 12, 0.0001  
 Data Point: 13, 0.0001  
 Data Point: 14, 0.0001  
 Data Point: 15, 0.0001  
 Data Point: 16, 0.0001  
 Data Point: 17, 0.0001  
 Data Point: 18, 0.0001  
 Data Point: 19, 0.0001  
 Data Point: 20, 0.0001  
 Data Point: 21, 0.0001  
 Data Point: 22, 0.0001  
 Data Point: 23, 0.0001  
 Data Point: 24, 0.0001  
 Data Point: 25, 0.0001  
 Data Point: 26, 0.0001  
 Data Point: 27, 0.0001  
 Data Point: 28, 0.0001  
 Data Point: 29, 0.0001  
 Data Point: 30, 0.0001

Estimation Procedure

Volume Water Content Function:  $0.0014 \cdot \text{Depth} + 0.0001 \cdot \text{Year}$   
 Hydraulic Conductivity:  $0.0001 \cdot \text{Year}$   
 Hyd. K Function Estimation Method:  $\text{Depth} \cdot \text{Year} \cdot \text{Year}$   
 Maximum: 0.001  
 Minimum: 0.0001  
 Num. Points: 30  
 Residual Water Content: 0.0001

Block Fragment  
 Model:  $\text{Block} = \text{Year} \cdot \text{Year} \cdot \text{Year}$   
 Function:  $\text{Block} = \text{Year} \cdot \text{Year} \cdot \text{Year}$   
 Gradient Convolution: 1.000  
 K: 0.0001  
 Data Points: 30  
 Data Point: 1, 0.0001  
 Data Point: 2, 0.0001  
 Data Point: 3, 0.0001  
 Data Point: 4, 0.0001  
 Data Point: 5, 0.0001  
 Data Point: 6, 0.0001  
 Data Point: 7, 0.0001  
 Data Point: 8, 0.0001  
 Data Point: 9, 0.0001  
 Data Point: 10, 0.0001  
 Data Point: 11, 0.0001  
 Data Point: 12, 0.0001  
 Data Point: 13, 0.0001  
 Data Point: 14, 0.0001  
 Data Point: 15, 0.0001  
 Data Point: 16, 0.0001  
 Data Point: 17, 0.0001  
 Data Point: 18, 0.0001  
 Data Point: 19, 0.0001  
 Data Point: 20, 0.0001  
 Data Point: 21, 0.0001  
 Data Point: 22, 0.0001  
 Data Point: 23, 0.0001  
 Data Point: 24, 0.0001  
 Data Point: 25, 0.0001  
 Data Point: 26, 0.0001  
 Data Point: 27, 0.0001  
 Data Point: 28, 0.0001  
 Data Point: 29, 0.0001  
 Data Point: 30, 0.0001

Section 12

Data Point: 1, 0.0001  
 Data Point: 2, 0.0001  
 Data Point: 3, 0.0001  
 Data Point: 4, 0.0001  
 Data Point: 5, 0.0001  
 Data Point: 6, 0.0001  
 Data Point: 7, 0.0001  
 Data Point: 8, 0.0001  
 Data Point: 9, 0.0001  
 Data Point: 10, 0.0001  
 Data Point: 11, 0.0001  
 Data Point: 12, 0.0001  
 Data Point: 13, 0.0001  
 Data Point: 14, 0.0001  
 Data Point: 15, 0.0001  
 Data Point: 16, 0.0001  
 Data Point: 17, 0.0001  
 Data Point: 18, 0.0001  
 Data Point: 19, 0.0001  
 Data Point: 20, 0.0001  
 Data Point: 21, 0.0001  
 Data Point: 22, 0.0001  
 Data Point: 23, 0.0001  
 Data Point: 24, 0.0001  
 Data Point: 25, 0.0001  
 Data Point: 26, 0.0001  
 Data Point: 27, 0.0001  
 Data Point: 28, 0.0001  
 Data Point: 29, 0.0001  
 Data Point: 30, 0.0001

Original Data Study:  $\text{Block} = \text{Year} \cdot \text{Year} \cdot \text{Year}$

Function:  $\text{Block} = \text{Year} \cdot \text{Year} \cdot \text{Year}$   
 Curve Fitted Data: 0.0001  
 Inverse Convolution: 1.000  
 Data Point: 1, 0.0001  
 Data Point: 2, 0.0001  
 Data Point: 3, 0.0001  
 Data Point: 4, 0.0001  
 Data Point: 5, 0.0001  
 Data Point: 6, 0.0001  
 Data Point: 7, 0.0001  
 Data Point: 8, 0.0001  
 Data Point: 9, 0.0001  
 Data Point: 10, 0.0001  
 Data Point: 11, 0.0001  
 Data Point: 12, 0.0001  
 Data Point: 13, 0.0001  
 Data Point: 14, 0.0001  
 Data Point: 15, 0.0001  
 Data Point: 16, 0.0001  
 Data Point: 17, 0.0001  
 Data Point: 18, 0.0001  
 Data Point: 19, 0.0001  
 Data Point: 20, 0.0001  
 Data Point: 21, 0.0001  
 Data Point: 22, 0.0001  
 Data Point: 23, 0.0001  
 Data Point: 24, 0.0001  
 Data Point: 25, 0.0001  
 Data Point: 26, 0.0001  
 Data Point: 27, 0.0001  
 Data Point: 28, 0.0001  
 Data Point: 29, 0.0001  
 Data Point: 30, 0.0001







Section D

Standard 6.479  
 Determinant: 206 (passing) 0.24  
 Estimated as 100% passing 0.24  
 Measured 0.24  
 Risk: none  
 Risk Rank: 0

100 City City 512

Model: V10.0  
 Function: WWTreatment: Activated Sludge

Curve Fit: Data 1/1

Segment: Curve 1/1

Model:

Segment: Water Content: 0.00

Estimation Properties

WWTreatmentMethod: 100 City City 512

Data Point: 1  
 Data Point: 2  
 Data Point: 3  
 Data Point: 4  
 Data Point: 5  
 Data Point: 6  
 Data Point: 7  
 Data Point: 8  
 Data Point: 9  
 Data Point: 10  
 Data Point: 11  
 Data Point: 12  
 Data Point: 13  
 Data Point: 14  
 Data Point: 15  
 Data Point: 16  
 Data Point: 17  
 Data Point: 18  
 Data Point: 19  
 Data Point: 20  
 Data Point: 21  
 Data Point: 22  
 Data Point: 23  
 Data Point: 24  
 Data Point: 25  
 Data Point: 26  
 Data Point: 27  
 Data Point: 28  
 Data Point: 29  
 Data Point: 30

Estimation Properties

WWTreatmentMethod: 100 City City 512  
 Sample Method: 100 City City 512  
 Saturated Water Content: 0.70  
 Liquid Limit: 25  
 Estimated LUL: 25  
 Diameter at 60% passing: 0.075  
 Maximum: 0.24  
 Minimum: 0.24  
 Risk: none

100 City City 512

Model: V10.0  
 Function: WWTreatment: Activated Sludge

Curve Fit: Data 1/1

Segment: Curve 1/1

Model:

Segment: Water Content: 0.00

Estimation Properties

WWTreatmentMethod: 100 City City 512

Section B

Standard 6.479  
 Determinant: 206 (passing) 0.24  
 Estimated as 100% passing 0.24  
 Measured 0.24  
 Risk: none  
 Risk Rank: 0

100 City City 512

Model: V10.0  
 Function: WWTreatment: Activated Sludge

Curve Fit: Data 1/1

Segment: Curve 1/1

Model:

Segment: Water Content: 0.00

Estimation Properties

WWTreatmentMethod: 100 City City 512

Data Point: 1  
 Data Point: 2  
 Data Point: 3  
 Data Point: 4  
 Data Point: 5  
 Data Point: 6  
 Data Point: 7  
 Data Point: 8  
 Data Point: 9  
 Data Point: 10  
 Data Point: 11  
 Data Point: 12  
 Data Point: 13  
 Data Point: 14  
 Data Point: 15  
 Data Point: 16  
 Data Point: 17  
 Data Point: 18  
 Data Point: 19  
 Data Point: 20  
 Data Point: 21  
 Data Point: 22  
 Data Point: 23  
 Data Point: 24  
 Data Point: 25  
 Data Point: 26  
 Data Point: 27  
 Data Point: 28  
 Data Point: 29  
 Data Point: 30

Estimation Properties

WWTreatmentMethod: 100 City City 512  
 Sample Method: 100 City City 512  
 Saturated Water Content: 0.70  
 Liquid Limit: 25  
 Estimated LUL: 25  
 Diameter at 60% passing: 0.075  
 Maximum: 0.24  
 Minimum: 0.24  
 Risk: none

100 City City 512

Model: V10.0  
 Function: WWTreatment: Activated Sludge

Curve Fit: Data 1/1

Segment: Curve 1/1

Model:

Segment: Water Content: 0.00

Estimation Properties

WWTreatmentMethod: 100 City City 512



Section B

1. The first part of the document discusses the importance of maintaining accurate records of all transactions. It emphasizes that proper record-keeping is essential for ensuring the integrity and transparency of the financial system. This section outlines the various methods and tools used to collect and analyze data, highlighting the need for consistency and reliability in the information provided.

2. The second part of the document focuses on the challenges faced by organizations in implementing effective data management practices. It identifies key areas such as data quality, security, and access control, and provides practical advice on how to address these issues. The text also discusses the role of technology in streamlining data processes and improving overall efficiency.

3. The final part of the document concludes with a summary of the key findings and recommendations. It reiterates the importance of a proactive approach to data management and encourages organizations to regularly review and update their policies and procedures. The document serves as a valuable resource for anyone involved in financial operations and data analysis.

Section B

1. The first part of the document discusses the importance of maintaining accurate records of all transactions. It emphasizes that proper record-keeping is essential for ensuring the integrity and transparency of the financial system. This section outlines the various methods and tools used to collect and analyze data, highlighting the need for consistency and reliability in the information provided.

2. The second part of the document focuses on the challenges faced by organizations in implementing effective data management practices. It identifies key areas such as data quality, security, and access control, and provides practical advice on how to address these issues. The text also discusses the role of technology in streamlining data processes and improving overall efficiency.

3. The final part of the document concludes with a summary of the key findings and recommendations. It reiterates the importance of a proactive approach to data management and encourages organizations to regularly review and update their policies and procedures. The document serves as a valuable resource for anyone involved in financial operations and data analysis.

Section B



Section B

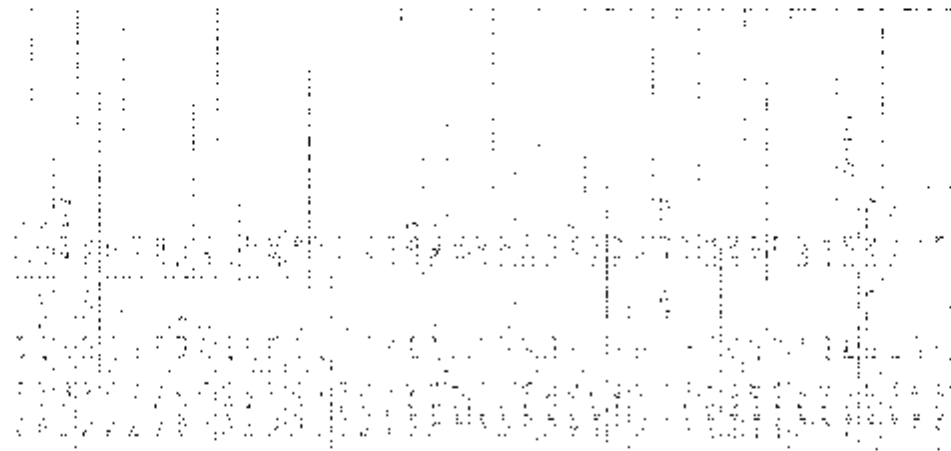

Points

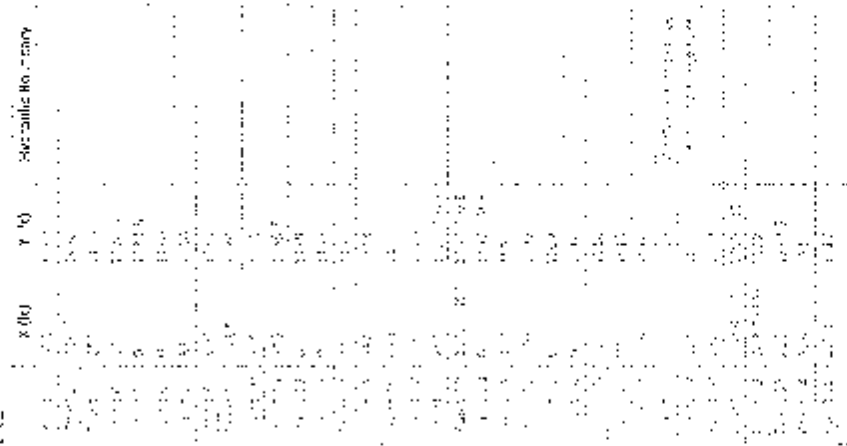

Section C

## SEEP/W Analysis

Model: C:\Program Files\SEEP/W\SEEP/W.exe

### File Information

Created by: J. J. J. J.  
 Revision Number: 1.0  
 Last Edited by: J. J. J. J.  
 Name: C:\Program Files\SEEP/W\SEEP/W.exe  
 File Name: C:\Program Files\SEEP/W\SEEP/W.exe  
 Location: C:\Program Files\SEEP/W\SEEP/W.exe

### Project Settings

Beneficial Use: 1  
 Time Units: 1  
 Energy Units: 1  
 Pressure and Density: 1  
 Mass Density: 1  
 Mass Flux Units: 1  
 Unit Weight of Water: 1  
 View: 1

### Analysis Settings

SEEP/W Analysis  
 Location: C:\Program Files\SEEP/W\SEEP/W.exe  
 Method: 1  
 Settings: 1  
 Near WQV: 1  
 Reach Air Flow: 1  
 General  
 Aquifer Riffled: 1  
 Consolidated  
 Maximum Number of Iterations: 1  
 Tolerance: 1  
 Maximum Change in K: 1  
 Rate of Change in K: 1  
 Minimum Change in K: 1  
 Evolution Filter: 1  
 Potential Seepage State of Materials: 1  
 Time  
 Maximum Time: 1  
 Number of Time Steps: 1  
 Time Step: 1  
 SEEP/W Analysis Method: 1  
 Case Study: 1  
 Use Adaptive Time Stepping: 1

Section C

## Materials

### Coarse-grained sand and shale fragments

Model: C:\Program Files\SEEP/W\SEEP/W.exe  
 Hydraulic  
 Retention of Water: 1  
 Volume Fraction of Water: 1  
 K Ratio: 1  
 K Direction: 1

### Trapping entity 1

Model: C:\Program Files\SEEP/W\SEEP/W.exe  
 Hydraulic  
 K Ratio: 1  
 Volume Fraction of Water: 1  
 K Ratio: 1  
 K Direction: 1

### Clay at dike tail with gravel

Model: C:\Program Files\SEEP/W\SEEP/W.exe  
 Hydraulic  
 K Ratio: 1  
 Volume Fraction of Water: 1  
 K Ratio: 1  
 K Direction: 1

### Fine sand, compacted ash

Model: C:\Program Files\SEEP/W\SEEP/W.exe  
 Hydraulic  
 K Ratio: 1  
 Volume Fraction of Water: 1  
 K Ratio: 1  
 K Direction: 1

### Gravel

Model: C:\Program Files\SEEP/W\SEEP/W.exe  
 Hydraulic  
 K Ratio: 1  
 Volume Fraction of Water: 1  
 K Ratio: 1  
 K Direction: 1

### Foundation Gravel and sandysilt 02.U1A

Model: C:\Program Files\SEEP/W\SEEP/W.exe  
 Hydraulic  
 K Ratio: 1  
 Volume Fraction of Water: 1  
 K Ratio: 1  
 K Direction: 1

Section C

Red Rock

Abundant in the ...  
Address: Water Contaminant ...  
Mile ...  
Coordinates: ...

Pre-nuclear Energy and Oil Use

Abundant in the ...  
Address: Water Contaminant ...  
Mile ...  
Coordinates: ...

Weathering State

Abundant in the ...  
Address: Water Contaminant ...  
Mile ...  
Coordinates: ...

Secondarily shale and oil

Abundant in the ...  
Address: Water Contaminant ...  
Mile ...  
Coordinates: ...

Foundation (Shale and Oil)

Abundant in the ...  
Address: Water Contaminant ...  
Mile ...  
Coordinates: ...

Boundary Conditions

Potential Seepage Face

Coordinates: ...

Flowing (Soil) Level

Coordinates: ...

Section C

Type: ...

Content Field: ...

Type: ...

Zero Flux

Type: ...

Initial Water Tables

Total Water (mg) ...  
Coordinates: ...

Flux Sections

Flux Section 1  
Coordinates: ...

Flux Section 2

Coordinates: ...

Flux Section 3

Coordinates: ...

X Functions

Center of Gravity of Sand  
Model ...  
Function ...  
Coordinates: ...









Section C

Data Point: 13.706 and 13.707  
 Data Point: 13.710, 13.711, 13.712  
 Data Point: 13.713, 13.714, 13.715, 13.716  
 Data Point: 13.717, 13.718, 13.719, 13.720  
 Data Point: 13.721, 13.722, 13.723, 13.724  
 Data Point: 13.725, 13.726, 13.727, 13.728  
 Data Point: 13.729, 13.730, 13.731, 13.732  
 Data Point: 13.733, 13.734, 13.735, 13.736  
 Data Point: 13.737, 13.738, 13.739, 13.740  
 Data Point: 13.741, 13.742, 13.743, 13.744  
 Data Point: 13.745, 13.746, 13.747, 13.748

Estimation Methods:  
 Use Method 201 (Method 201) to determine TOC.  
 Sample Material: Water  
 Separated Water Content: 100%  
 Liquid Air: 100%  
 Extraction at 100°C (passing through 50µm mesh)  
 Duration of 50% pass: 10 min  
 Maximum TOC: 2.5%  
 Min. Point: 13.748

Section C

Data Point: 13.749, 13.750, 13.751, 13.752  
 Data Point: 13.753, 13.754, 13.755, 13.756  
 Data Point: 13.757, 13.758, 13.759, 13.760  
 Data Point: 13.761, 13.762, 13.763, 13.764  
 Data Point: 13.765, 13.766, 13.767, 13.768  
 Data Point: 13.769, 13.770, 13.771, 13.772  
 Data Point: 13.773, 13.774, 13.775, 13.776  
 Data Point: 13.777, 13.778, 13.779, 13.780  
 Data Point: 13.781, 13.782, 13.783, 13.784  
 Data Point: 13.785, 13.786, 13.787, 13.788  
 Data Point: 13.789, 13.790, 13.791, 13.792

Notes

| Point  | Sample | Location | Hydraulic Conductivity |
|--------|--------|----------|------------------------|
| 13.749 | 13.749 | 13.749   | 13.749                 |
| 13.750 | 13.750 | 13.750   | 13.750                 |
| 13.751 | 13.751 | 13.751   | 13.751                 |
| 13.752 | 13.752 | 13.752   | 13.752                 |
| 13.753 | 13.753 | 13.753   | 13.753                 |
| 13.754 | 13.754 | 13.754   | 13.754                 |
| 13.755 | 13.755 | 13.755   | 13.755                 |
| 13.756 | 13.756 | 13.756   | 13.756                 |
| 13.757 | 13.757 | 13.757   | 13.757                 |
| 13.758 | 13.758 | 13.758   | 13.758                 |
| 13.759 | 13.759 | 13.759   | 13.759                 |
| 13.760 | 13.760 | 13.760   | 13.760                 |
| 13.761 | 13.761 | 13.761   | 13.761                 |
| 13.762 | 13.762 | 13.762   | 13.762                 |
| 13.763 | 13.763 | 13.763   | 13.763                 |
| 13.764 | 13.764 | 13.764   | 13.764                 |
| 13.765 | 13.765 | 13.765   | 13.765                 |
| 13.766 | 13.766 | 13.766   | 13.766                 |
| 13.767 | 13.767 | 13.767   | 13.767                 |
| 13.768 | 13.768 | 13.768   | 13.768                 |
| 13.769 | 13.769 | 13.769   | 13.769                 |
| 13.770 | 13.770 | 13.770   | 13.770                 |
| 13.771 | 13.771 | 13.771   | 13.771                 |
| 13.772 | 13.772 | 13.772   | 13.772                 |
| 13.773 | 13.773 | 13.773   | 13.773                 |
| 13.774 | 13.774 | 13.774   | 13.774                 |
| 13.775 | 13.775 | 13.775   | 13.775                 |
| 13.776 | 13.776 | 13.776   | 13.776                 |
| 13.777 | 13.777 | 13.777   | 13.777                 |
| 13.778 | 13.778 | 13.778   | 13.778                 |
| 13.779 | 13.779 | 13.779   | 13.779                 |
| 13.780 | 13.780 | 13.780   | 13.780                 |
| 13.781 | 13.781 | 13.781   | 13.781                 |
| 13.782 | 13.782 | 13.782   | 13.782                 |
| 13.783 | 13.783 | 13.783   | 13.783                 |
| 13.784 | 13.784 | 13.784   | 13.784                 |
| 13.785 | 13.785 | 13.785   | 13.785                 |
| 13.786 | 13.786 | 13.786   | 13.786                 |
| 13.787 | 13.787 | 13.787   | 13.787                 |
| 13.788 | 13.788 | 13.788   | 13.788                 |
| 13.789 | 13.789 | 13.789   | 13.789                 |
| 13.790 | 13.790 | 13.790   | 13.790                 |
| 13.791 | 13.791 | 13.791   | 13.791                 |
| 13.792 | 13.792 | 13.792   | 13.792                 |

Regions

| Region | Material | Spice  | Area (ft <sup>2</sup> ) |
|--------|----------|--------|-------------------------|
| 13.749 | 13.749   | 13.749 | 13.749                  |
| 13.750 | 13.750   | 13.750 | 13.750                  |
| 13.751 | 13.751   | 13.751 | 13.751                  |
| 13.752 | 13.752   | 13.752 | 13.752                  |
| 13.753 | 13.753   | 13.753 | 13.753                  |
| 13.754 | 13.754   | 13.754 | 13.754                  |
| 13.755 | 13.755   | 13.755 | 13.755                  |
| 13.756 | 13.756   | 13.756 | 13.756                  |
| 13.757 | 13.757   | 13.757 | 13.757                  |
| 13.758 | 13.758   | 13.758 | 13.758                  |
| 13.759 | 13.759   | 13.759 | 13.759                  |
| 13.760 | 13.760   | 13.760 | 13.760                  |
| 13.761 | 13.761   | 13.761 | 13.761                  |
| 13.762 | 13.762   | 13.762 | 13.762                  |
| 13.763 | 13.763   | 13.763 | 13.763                  |
| 13.764 | 13.764   | 13.764 | 13.764                  |
| 13.765 | 13.765   | 13.765 | 13.765                  |
| 13.766 | 13.766   | 13.766 | 13.766                  |
| 13.767 | 13.767   | 13.767 | 13.767                  |
| 13.768 | 13.768   | 13.768 | 13.768                  |
| 13.769 | 13.769   | 13.769 | 13.769                  |
| 13.770 | 13.770   | 13.770 | 13.770                  |
| 13.771 | 13.771   | 13.771 | 13.771                  |
| 13.772 | 13.772   | 13.772 | 13.772                  |
| 13.773 | 13.773   | 13.773 | 13.773                  |
| 13.774 | 13.774   | 13.774 | 13.774                  |
| 13.775 | 13.775   | 13.775 | 13.775                  |
| 13.776 | 13.776   | 13.776 | 13.776                  |
| 13.777 | 13.777   | 13.777 | 13.777                  |
| 13.778 | 13.778   | 13.778 | 13.778                  |
| 13.779 | 13.779   | 13.779 | 13.779                  |
| 13.780 | 13.780   | 13.780 | 13.780                  |
| 13.781 | 13.781   | 13.781 | 13.781                  |
| 13.782 | 13.782   | 13.782 | 13.782                  |
| 13.783 | 13.783   | 13.783 | 13.783                  |
| 13.784 | 13.784   | 13.784 | 13.784                  |
| 13.785 | 13.785   | 13.785 | 13.785                  |
| 13.786 | 13.786   | 13.786 | 13.786                  |
| 13.787 | 13.787   | 13.787 | 13.787                  |
| 13.788 | 13.788   | 13.788 | 13.788                  |
| 13.789 | 13.789   | 13.789 | 13.789                  |
| 13.790 | 13.790   | 13.790 | 13.790                  |
| 13.791 | 13.791   | 13.791 | 13.791                  |
| 13.792 | 13.792   | 13.792 | 13.792                  |

Section C

Section F

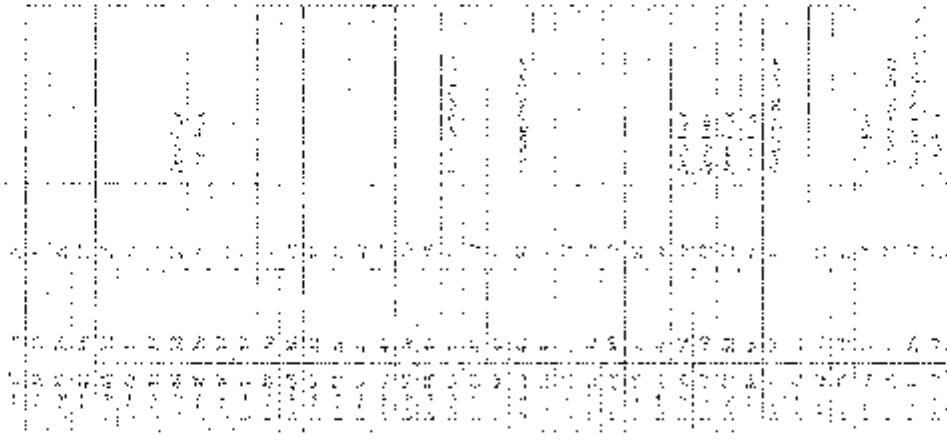

Points

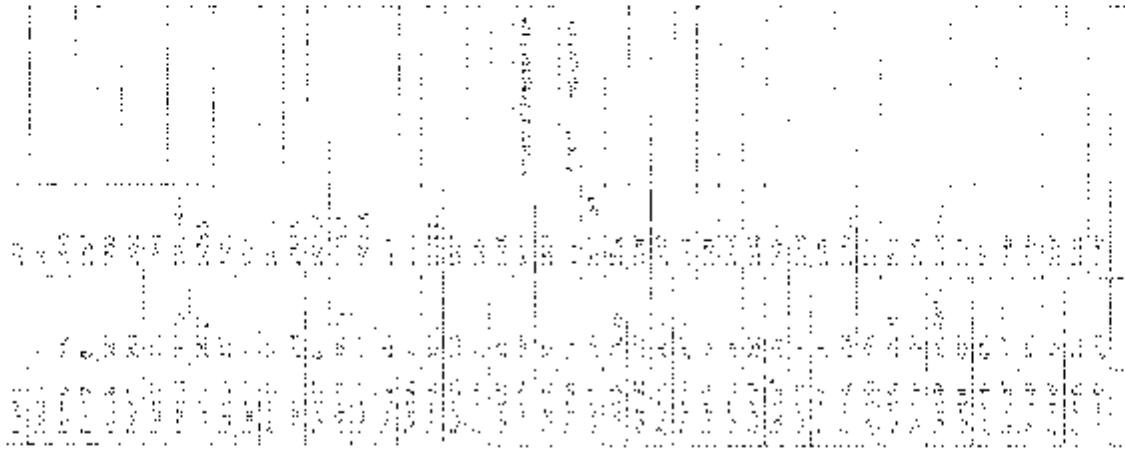

Section C

1. The following information is required to be submitted to the Administrator for review and approval of the proposed rulemaking under the Act:

- (a) A statement of the need for the proposed rulemaking, including a description of the problem to be addressed and the benefits to be realized.
- (b) A description of the proposed rulemaking, including a description of the problem to be addressed and the benefits to be realized.
- (c) A description of the proposed rulemaking, including a description of the problem to be addressed and the benefits to be realized.
- (d) A description of the proposed rulemaking, including a description of the problem to be addressed and the benefits to be realized.
- (e) A description of the proposed rulemaking, including a description of the problem to be addressed and the benefits to be realized.

## APPENDIX 5

### STABILITY ANALYSIS REPORT AND RESULTS

Figures 5-1 through 5-6: Stability results of Section A

Figures 5-7 through 5-13: Stability results of Section A

Figures 5-13 through 5-19: Stability results of Section A

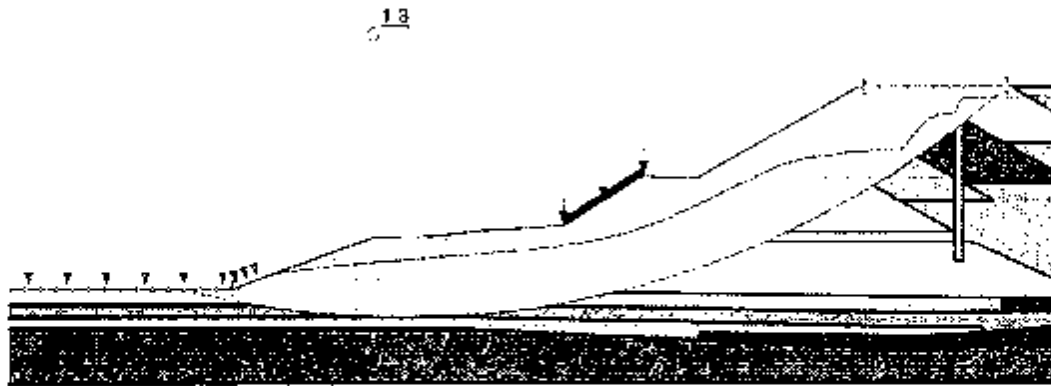

Figure 5.1. Stability of Section A under steady-state condition with a deep failure surface.

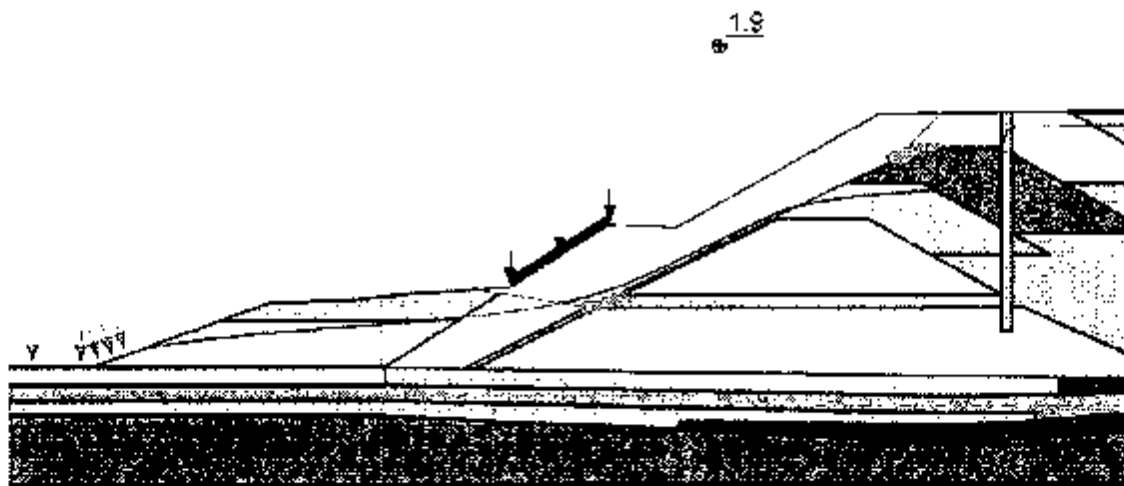

Figure 5.2. Stability of Section A under steady state seepage condition using block failure mode.

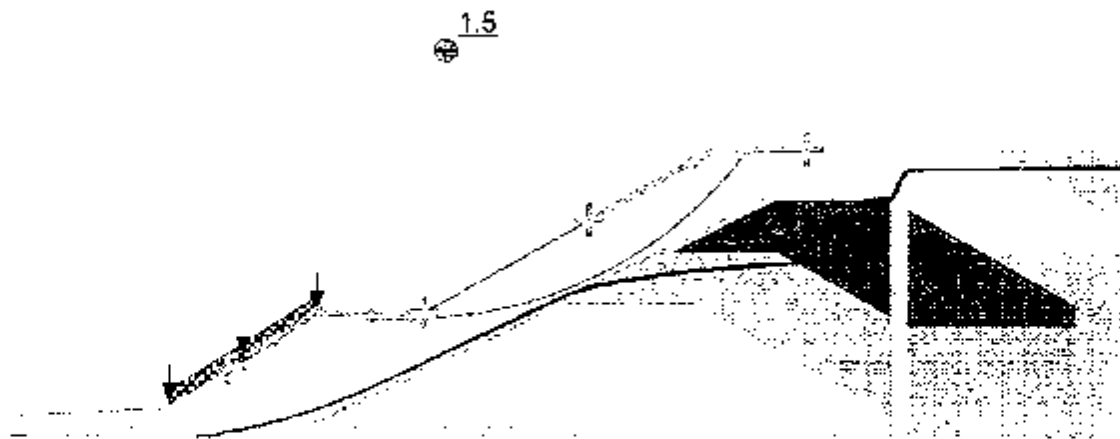

Figure 5.3. Stability of the outer shell of Section A under steady state seepage.

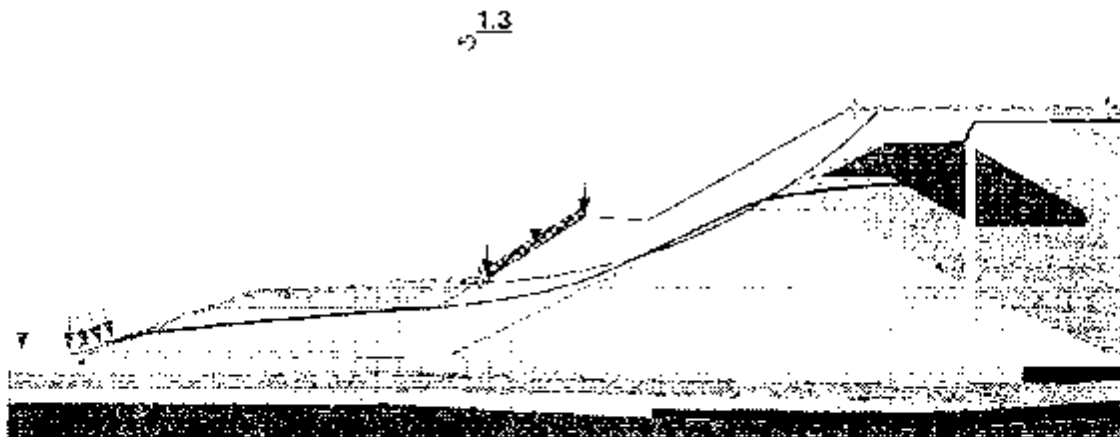

Figure 5.4. Critical failure surface and the corresponding factor of safety under seismic loading condition for Section A using drained material properties.

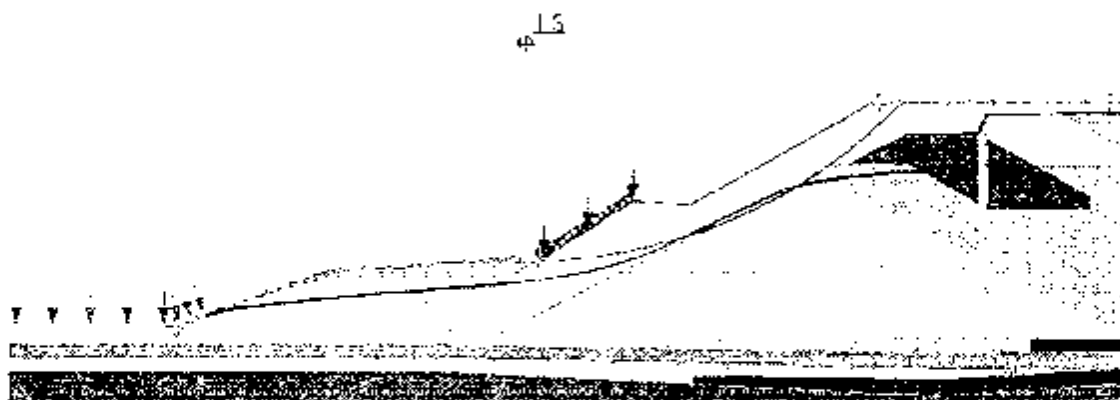

Figure 5.5. Critical failure surface and the corresponding factor of safety under seismic loading condition for Section A using consolidated undrained material properties.

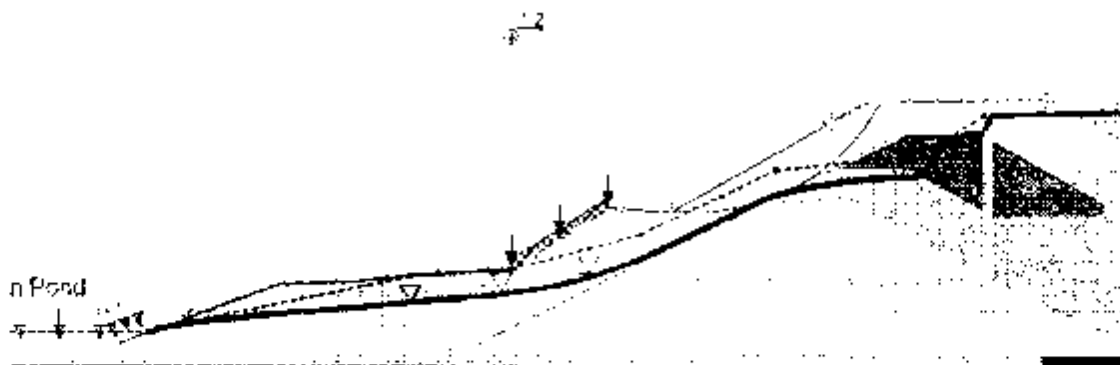

Figure 5.6. Stability of Section A after 7 ft raise in the piezometric water levels.



17

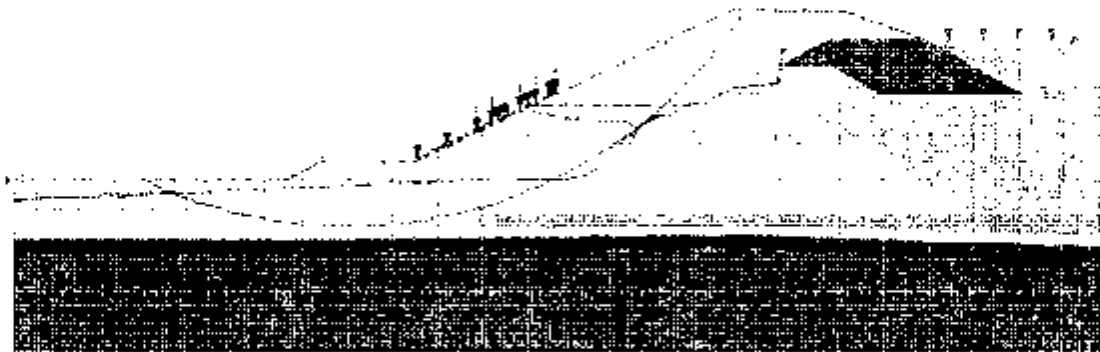

Figure 5.7. Stability of Section B under steady-state condition with a deep failure surface.

20

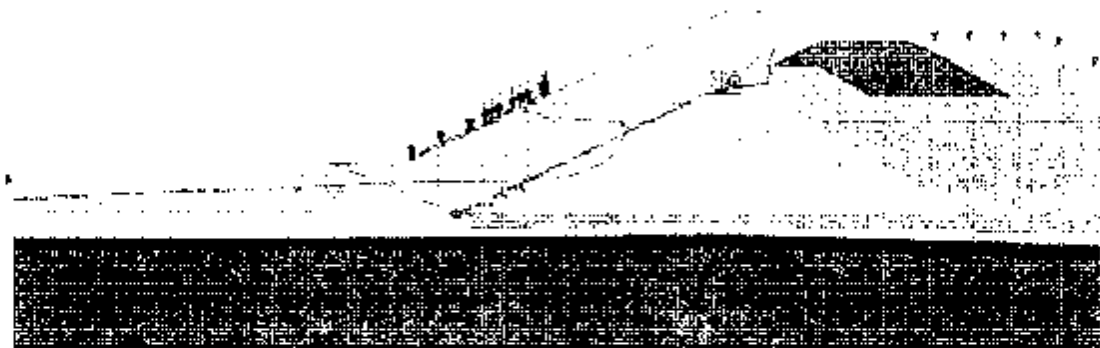

Figure 5.8. Stability of Section B under steady state seepage with a block failure mechanism.

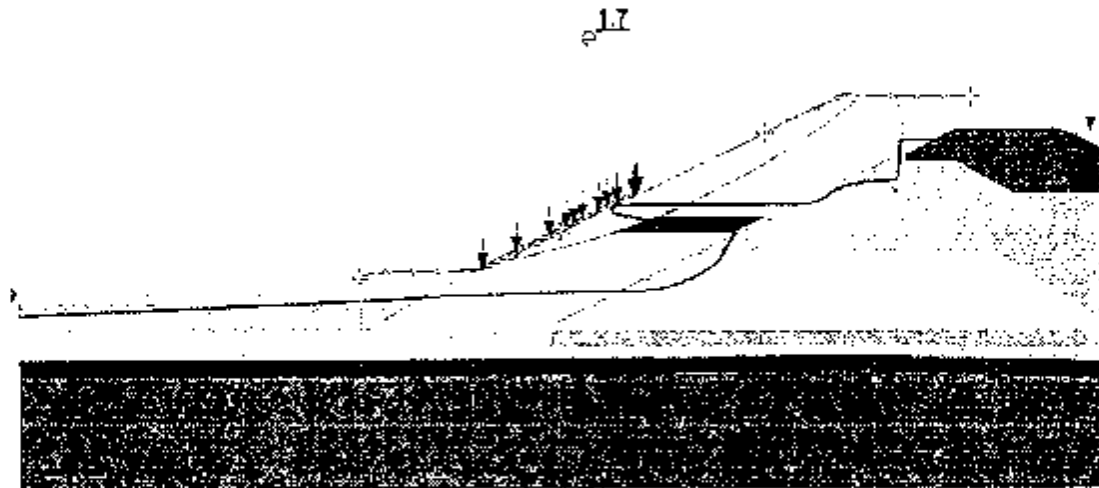

Figure 5.9. Stability of the outer shell of Section B under steady state seepage.



Figure 5.10. Stability analysis results of Section B under seismic loading using drained material properties.



Figure 5.11. Stability analysis results of Section B under seismic loading using consolidated undrained material properties.

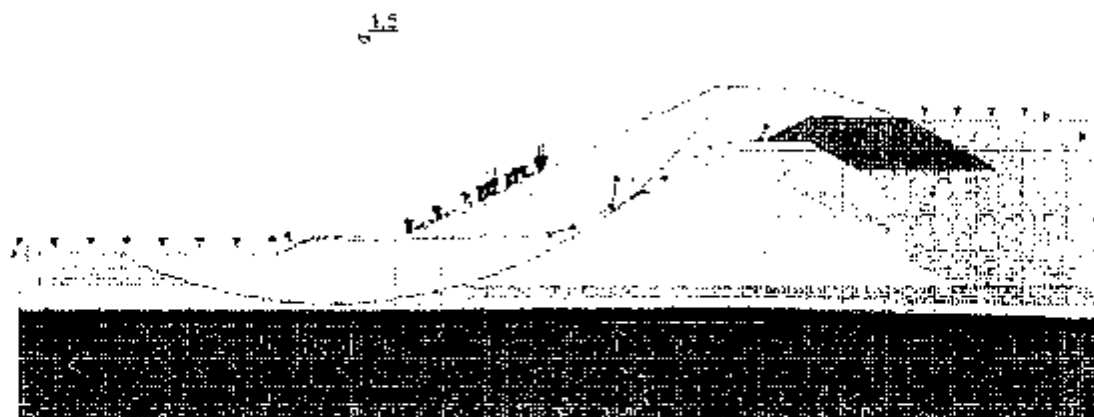

Figure 5.12. The warning water level for Section B was determined to be approximately 7 ft raise in the current piezometric levels.

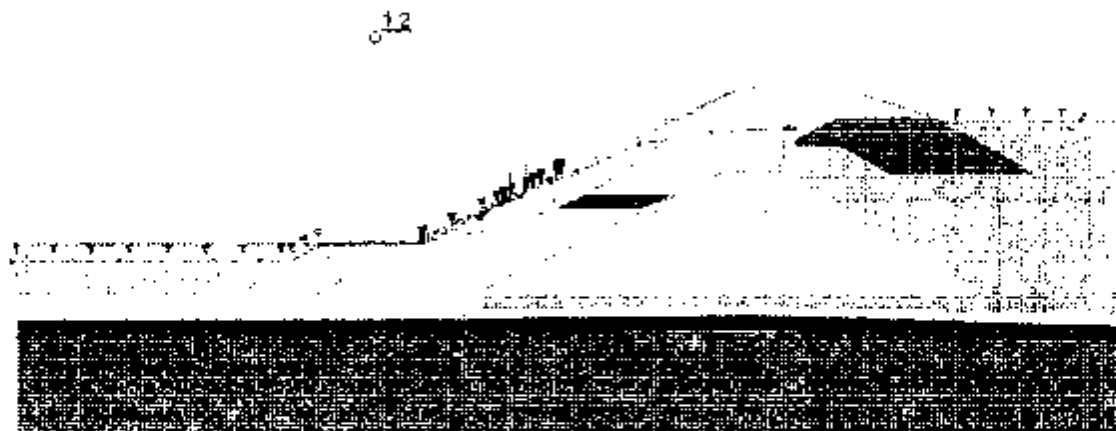

Figure 5.13. The critical water level for Section B is indicated by about 12 ft raise in the piezometric water levels at the crest or about 10 ft raise in the piezometric water levels at the toe.

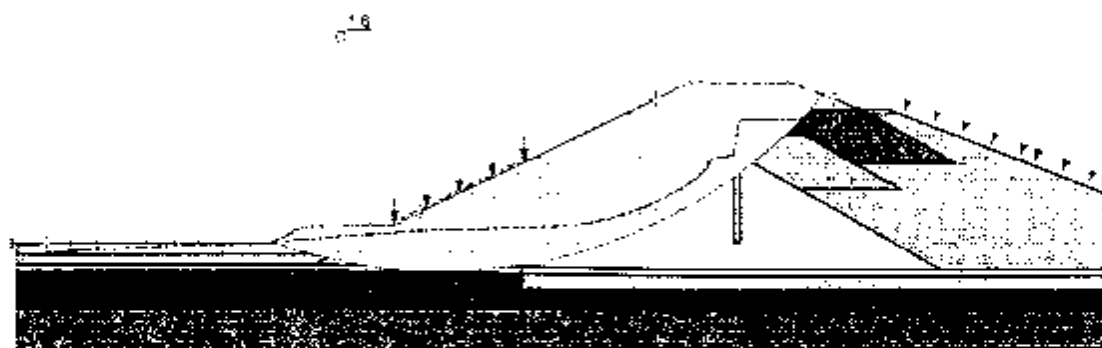

Figure 5.14. Stability of Section C under steady-state seepage condition with a deep failure surface.

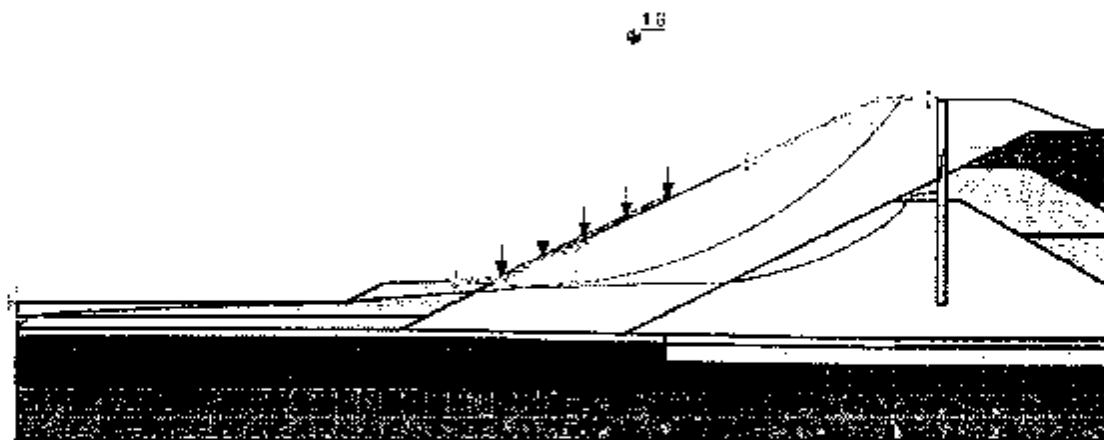

Figure 5.15. Stability of the outer shell of Section C under steady-state seepage condition.

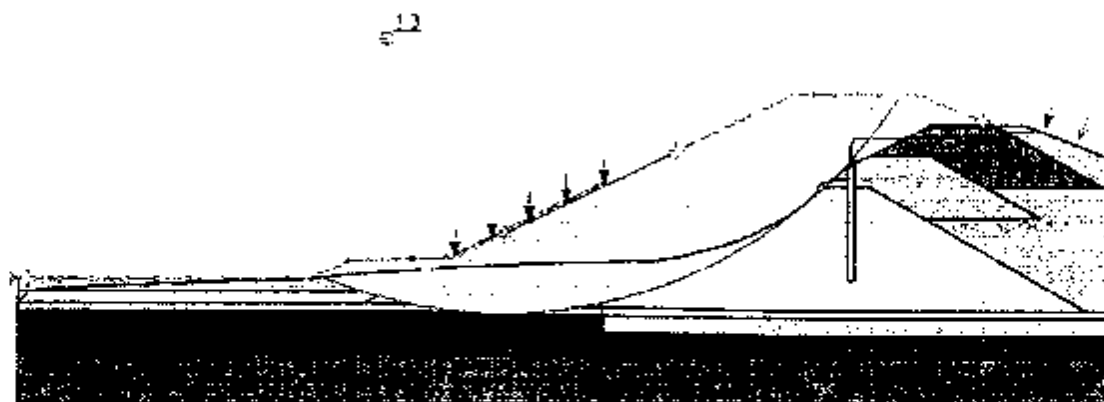

Figure 5.16. Stability of Section C under seismic loading condition using drained material shear strength.

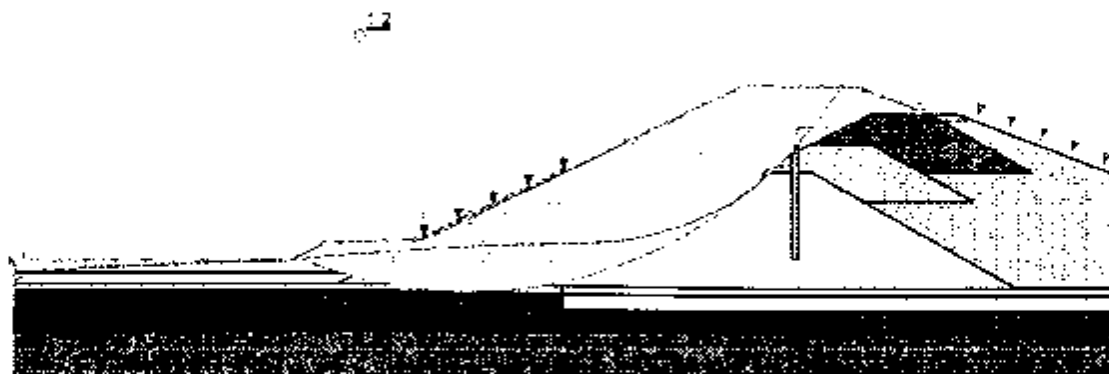

Figure 5.17. Stability of Section C under seismic loading condition using consolidated undrained shear strengths.

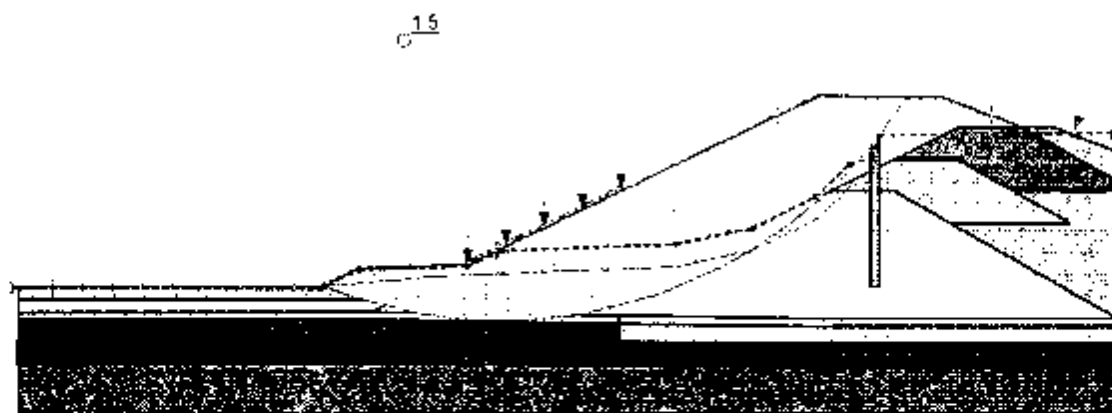

Figure 5.18. Stability analysis results for Section C after 7 ft increase of the phreatic water levels.

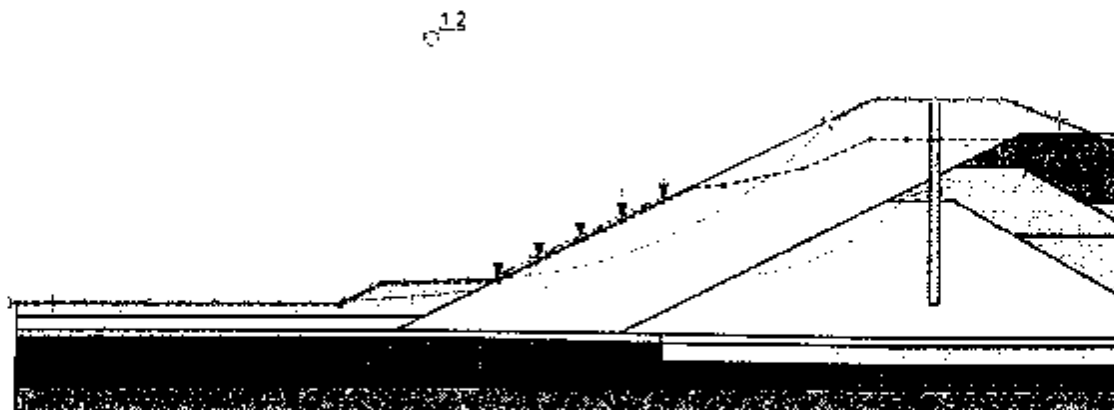

Figure 5.19. Stability analysis for Section C after 28 ft increase in the piezometric levels.

January 15, 2009  
001-11497-007



American Electric Power  
Mr. Gary Zych, P.E.  
1 Riverside Plaza  
Columbus, Ohio 43215

Re: **Design Summary**  
**Ash Pond 2 Final Closure**  
**Clinch River Power Plant**  
**Carbo, Virginia**

Dear Mr. Zych,

In accordance with our June 27, 2008 proposal, and written authorization on July 1, 2008, BBC&M Engineering, Inc. has completed engineering and design services associated with the final closure of Ash Pond No. 2 at the Clinch River Power Plant near Carbo, Virginia.

BBCM's scope of work consisted of engineering, design and permitting of the cap system for final closure under Virginia regulations, generally following the intent of the Virginia Department of Environmental Quality (VADEQ) regulations and guidelines, for Industrial Waste Disposal Facilities

#### **Design Summary**

It is proposed to close Clinch River Ash Pond No. 2 through re-grading and the application of a cap and vegetative cover. The existing surface will be re-graded and filled to achieve a gently sloping (5%) surface to promote surface water runoff. The re-graded ash surface will be covered with a flexible geomembrane covered by a geocomposite drainage layer and 2-feet of soil fill. The surface of the soil fill will be seeded and mulched to promote the growth of a vegetative cover. Surface water run-on from the adjacent slope will be diverted and runoff from the capped areas will be directed into one of two sediment ponds, prior to being discharged into Dumps Creek

#### **Drawings**

Working in close association with AEP, drawings have been prepared for bidding and construction. The drawings contain an Existing Site Plan, Phasing Plan, Final Grading Plan, Cross Sections, Details and an Erosion & Sediment Control Plan and Details. The drawings were developed in conjunction with geotechnical and surface water considerations.

#### **Part 1: Geotechnical Analyses**

In support of the final closure plan, BBCM performed a subsurface investigation to assess the overall stability of the site with respect to the proposed cap geometry. Soil and rock borings were performed to augment previous borings which were used to define the subsurface



conditions at the site. Soil and rock samples were obtained and laboratory testing was performed on selected samples recovered in the field

Geotechnical analyses were performed by BBCM using the results of the boring program and laboratory testing. The analyses covered slope stability, liquefaction and settlement based on the new geometry and loads imposed by the capping. Results of the analyses indicate that the proposed final grades are stable under ordinary conditions as well as under seismic conditions.

Results of the Subsurface Investigation including geotechnical analyses are included in Part 1 of this submittal.

### **Part 2: Cover System Stability**

The stability of the proposed final cover system was evaluated by BBCM considering the impact of rainfall. These calculations, included as Part 2, demonstrate that the cover system exhibits adequate factors of safety against surficial failure modes.

### **Part 3: Surface Water Controls**

A series of runoff control structures including diversion berms, ditches, channels, sediment ponds and spillways were designed by BBCM for the final closure of Ash Pond 2. Storm water runoff was computed using National Resource Conservation Service (NRCS) methodology, including TR-55. This methodology was used to determine peak discharge from a given drainage area under a given rainfall amount.

Rainfall events were obtained from NOAA Atlas 14, given the coordinates for the site. The 25-year, 24-hour storm event was the basis for design of surface water control structures. The 25-year storm for this area is 4.23 inches. Surface water control structures, such as ditches and berms, were designed to pass the peak runoff from a 25-year, 24-hour storm event.

Sediment ponds were designed to contain 134 cubic yards of runoff per acre of drainage area below the level of the principal spillway. Sediment pond principal spillways have been sized to pass the runoff from a 2-year, 24-hour storm event, without flows entering the emergency spillway. Sediment Pond emergency spillways have been designed to pass the 25-year storm without overtopping the banks of the pond and maintaining at least 1-foot of freeboard. Runoff from the various storm events were routed through the ponds using the HEC-1 computer program using computed storage/discharge relationships and watershed characteristics for each pond.

Calculations for runoff, discharge and pond sizing are contained in Part 3 of this submittal.

### **Part 4: Estimated Quantities**

BBCM developed estimated quantities for the various construction components and waste volume. This information is summarized as Part 4.

We appreciate the opportunity to be of service to you on this project. If you have any questions, please feel free to contact us at any time

Respectfully Submitted,

**BBC&M ENGINEERING, INC.**  
Dublin Office

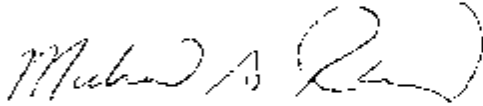

Michael G. Rowland, P.E.  
Senior Engineer

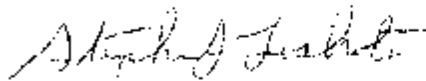

Stephen J. Loskota, P.E.  
Senior Project Engineer

Submitted: 1 Copy

Attachments: Part 1: Geotechnical Analysis Report  
Part 2: Cover System Stability  
Part 3: Surface Water  
Part 4: Quantity Estimate

**PART 1**  
**GEOTECHNICAL ANALYSIS REPORT**

December, 2008

**GEOTECHNICAL ANALYSIS REPORT  
CLINCH RIVER POWER PLANT  
POND NO. 2 FINAL CLOSURE  
CARBO, VIRGINIA**

**Report to**

**AMERICAN ELECTRIC POWER SERVICE CORP.  
COLUMBUS, OHIO**

**Prepared by**

**BBC&M ENGINEERING, INC.  
GEOTECHNICAL ENGINEERS  
COLUMBUS, OHIO**

**December, 2008**

December 12, 2008  
001-11497-007



American Electric Power  
Mr. Gary Zych, P.E.  
1 Riverside Plaza  
Columbus, Ohio 43215

Re: Geotechnical Analysis Report – Pond 2 Closure Plans  
Clinch River Power Plant  
Carbo, Virginia

Dear Mr. Zych,

In accordance with our June 27, 2008 proposal, and written authorization on July 1, 2008, BBC&M Engineering, Inc. has completed the geotechnical analysis in support of the design for the closure of Ash Pond No. 2 at the Clinch River Power Plant near Carbo, Virginia.

BBC&M's scope of work consisted of engineering, design and permitting of the cap system for final closure under Virginia regulations, generally following the intent of the Virginia Department of Environmental Quality (VADEQ) regulations and guidelines, for Industrial Waste Disposal Facilities. The following report is a summary of our geotechnical analyses consisting of slope stability, liquefaction potential, and settlement analyses. These analyses focus on deep seated modes of failure. The stability of the final cover system was assessed separately.

We appreciate the opportunity to be of service to you on this project. If you have any questions, please feel free to contact us at any time.

Respectfully Submitted,

**BBC&M ENGINEERING, INC.**  
Dublin Office

A handwritten signature in black ink, appearing to read "Michael G. Rowland".

Michael G. Rowland, P.E.  
Senior Engineer

A handwritten signature in black ink, appearing to read "Stephen J. Loskota".

Stephen J. Loskota, P.E.  
Senior Project Engineer

Submitted: 1 Electronic Copy

US EPA ARCHIVE DOCUMENT

**TABLE OF CONTENTS**

|  |           |
|--|-----------|
| <b>INTRODUCTION</b> .....                        | <b>1</b>  |
| <i>Project Description</i> . . . . .             | 1         |
| <i>Purpose of This Work</i> . . . . .            | 1         |
| <i>Available Geotechnical Data</i> . . . . .     | 1         |
| <b>CURRENT SUBSURFACE INVESTIGATION</b> .....    | <b>2</b>  |
| <b>FIELD WORK</b> .....                          | <b>2</b>  |
| <b>LABORATORY TESTING</b> .....                  | <b>3</b>  |
| <b>GENERAL SUBSURFACE CONDITIONS</b> .....       | <b>4</b>  |
| <b>DESIGN CROSS SECTION FOR ANALYSES</b> .....   | <b>4</b>  |
| <i>Geometry</i> . . . . .                        | 4         |
| <i>Soil Layers</i> . . . . .                     | 5         |
| <i>Strength Parameters</i> . . . . .             | 6         |
| <i>Groundwater Level</i> . . . . .               | 7         |
| <b>ANALYSES AND RESULTS</b> .....                | <b>7</b>  |
| <i>Liquefaction Potential</i> . . . . .          | 7         |
| <i>Global Slope Stability Analysis</i> . . . . . | 8         |
| <i>Settlement</i> . . . . .                      | 9         |
| <b>CONCLUSIONS</b> .....                         | <b>10</b> |

**APPENDICES**

|   |              |
|---|--------------|
| <b>APPENDIX A: Subsurface Investigation</b>                           | <b>Plate</b> |
| Plan of Explorations . . . . .  | 1            |
| Explanation of Symbols and Terms Used on Boring Logs – Soil . . . . . | 2            |
| Explanation of Symbols and Terms Used on Boring Logs – Rock . . . . . | 3            |
| Boring Logs (B-1 through B-8) . . . . .                               | 4-19         |
| Summary of Laboratory Test Results . . . . .                          | 20-21        |
| Atterberg Limits' Results . . . . .                                   | 22           |
| Logs of Shelby Tube Samples . . . . .                                 | 23           |
| Gradation Curves . . . . .  | 24-45        |

**APPENDIX B: Slope Stability Analysis**

**APPENDIX C: Settlement Analysis**

## INTRODUCTION

### Project Description

BBCM Engineering, Inc (BBCM) has been retained by AEP to provide design services for the final closure of the inactive Ash Pond No. 2 (Pond 2) at the AEP Clinch River Power Plant near Carbo, Virginia in Russell County. Services included a surface and subsurface site investigation, engineering and design. The permit application itself will be prepared by AEP. The design of the final cover generally follows the intent of the Virginia Department of Environmental Quality (VADEQ) regulations and guidelines, for Industrial Waste Disposal Facilities. This report addresses the Geotechnical Analysis portion of the design.

Pond 2 consists of a three tiered dike system constructed to impound coal combustion byproducts (both bottom and fly ash). To be consistent with previous reports performed by AEP, the dikes were termed Lower Level, Middle Level, and Upper Level dikes, although they are also known as Dikes 1, 2 and 3, respectively. Based on information provided by AEP, BBCM understands operations at Pond No. 2, which began around 1954, were discontinued in 1997 and the pond has been inactive since that time. During active operations, fly ash and bottom ash were sluiced into the pond areas. Over the years, the capacity of Pond 2 was increased through vertical expansions consisting of first increasing the height of the lower dike, then subsequently constructing the middle and upper dikes. At this time, the upper portion of the impoundment remains open to the environment. A cover system will provide final closure of the facility.

The proposed pond closure design will utilize dry coal ash placed as structural fill to achieve a 5% grade sloping away from the hillside to allow surface water to drain from the 20 acre site. As much as 30 feet of fill will be required in some areas to achieve the final grade. The completed pond will then be capped with a flexible membrane liner, geocomposite drainage layer, and cover soil.

### Purpose of This Work

The purpose of this work was to assess the impact of the proposed final cover system on the stability of the existing ash pond as well as to generally assess the long term stability of the overall system. It is understood that this report will be included with the permit application prepared by AEP. The geotechnical analyses summarized in this report consist of an evaluation of potential for the existing ash to liquefy under a seismic event, the stability of the overall pond under the weight of the new cover system (under both normal and seismic conditions) and to estimate the settlement of the existing ash and foundation soils under the weight of the proposed cover system. Each of these analyses are dependent upon the existing subsurface conditions. To this end, BBCM performed a limited subsurface investigation at the facility to supplement the existing extensive data. Please note that only analyses dealing with the existing subsurface conditions have been included in this report. Other analyses, such as hydrologic and hydraulic and the surficial stability of the final cover itself have been documented in a separate design report.

### Available Geotechnical Data

An extensive analysis of the stability of Ash Pond No. 2 was performed by AEP in 1990. In this report, entitled "Stability Analysis of Clinch River Ash Pond Dikes" dated January,

**Geotechnical Analysis Report  
Clinch River Power Plant  
Pond No. 2 Closure  
Russell County, Virginia**

1990 the construction and operation of the facility was reviewed and the results of a subsurface investigation were summarized. As part of this investigation, five soil borings and piezometers were installed and a large number of consolidated-undrained triaxial shear tests and direct shear tests were performed.

As part of our work, BBCM reviewed the AEP report. In the report, AEP examined various combinations of circular and block failure surfaces for the existing dike configuration, as well as a progressive failure mode. AEP also performed a sensitivity analyses by reducing the drained friction angle of the dikes by 2 degrees, and found this had little effect on the failure surface and its factor of safety. Overall, AEP determined the stability of the clay dike system at Pond 2 was satisfactory and operations could continue without modification. Additionally, BBCM understands that no major problems have occurred at Pond 2 since the time of the report. Some time after Ash Pond 2 was taken out of service, portions of the upper dike (Dike 3), which had not been filled to capacity, were removed to prevent surface water ponding; otherwise the existing geometry is largely the same as it was at the time of the 1990 report.

Limit equilibrium slope stability analyses in the 1990 report were generally performed along a single cross-section generated through the facility. Such analyses provide a factor of safety as an output which represents the resisting forces (soil strength) divided by the driving forces. A factor of safety of 1.0 implies that the slope is in a state of incipient failure. AEP's lowest computed factor of safety was 1.3 for the middle dike.

#### **CURRENT SUBSURFACE INVESTIGATION**

As part of the design of the final closure of Pond 2, BBCM performed a limited subsurface investigation which was intended to supplement the available information. The focus of this investigation was to confirm the condition of the lower and middle dikes, to confirm the top of bedrock elevation across the site, and to investigate the condition of the impounded ash which will become the foundation for the final cover system. The details of this investigation are described in the following sections.

#### **FIELD WORK**

During the period of July 22 through August 6, 2008, AEP personnel performed eight (8) soil borings, designated B-1 through B-8, that were extended to depths ranging from 23.6 to 81.8 feet below existing grades. A project geologist, (Certified Professional in the state of Virginia) from BBCM was onsite between July 22 and 23 to meet with AEP plant personnel, perform a reconnaissance of the overall site, position the borings in the field, log Borings B-3 and B-4, and coordinate survey work. The remaining borings were logged by AEP personnel.

Borings B-3 and B-4 were located on the crest of the lower and middle dikes, respectively. Borings B-1 and B-8 were located between the middle and upper dikes and Borings B-2, B-6, and B-7 were located between the upper dike (partially removed at this time) and the hillside. The boring locations, as shown on the Plan of Borings and presented as Plate 1 in the Appendix A, were selected and field located by BBCM personnel. The ground surface elevations of the borings were initially estimated from recent topographic mapping provided by AEP for preliminary analyses, and later



recorded during a site survey. Logs of all borings are submitted in the appendix as Plates 4 through 19.

All borings were performed with a truck mounted drill rig and were advanced between sampling attempts using 3¼-inch I.D. hollow-stem augers. At regular intervals, disturbed, but representative, samples were obtained by lowering a 2-inch O.D. split-barrel sampler to the bottom of the hole and driving it into the soil by blows from a 140-pound hammer freely falling 30 inches (Standard Penetration Test, ASTM D1586). Split barrel samples were examined immediately after recovery and representative portions of each sample were placed in air tight jars and retained for subsequent laboratory testing.

Upon encountering auger refusal in Borings B-3 and B-6, a changeover was made to rock coring techniques to verify the presence and condition of the bedrock. At these locations, bedrock core were obtained by using a NQ rock coring techniques with water as the circulating fluid. Recovered rock cores were catalogued in the field and preserved in compartmented boxes and delivered to our laboratory for inspection, classification and testing. The rock coring was performed in accordance with ASTM D 2113.

During drilling procedures, personnel from BBCM or AEP performed the following specific duties:

- examined all samples recovered from the borings;
- cleaned soil samples of cuttings and preserved representative portions in airtight glass jars;
- preserved bedrock samples in core boxes;
- prepared a log of each boring;
- made hand-penetrometer measurements in soil samples exhibiting cohesion; and,
- provided liaison between the field personnel and the Project Manager so that the field investigation could be modified in the event that unexpected subsurface conditions were encountered.

At the completion of drilling, all recovered samples were transported to the BBCM laboratory for further examination and testing.

## LABORATORY TESTING

In the laboratory, the samples were visually identified and on representative samples, moisture contents, liquid and plastic limit determinations, and grain-size analyses were performed. Results of these index tests permit an evaluation of strength and compressibility characteristics of the soil by comparison with similar soils for which these characteristics have been previously determined. Based upon the results of the laboratory visual identifications and testing program, soil descriptions contained on the field logs were modified, if necessary and laboratory-corrected logs are submitted as Plates 4 through 19 in Appendix A. Results of the laboratory tests are shown graphically on the individual boring logs and a summary of test results is presented on Plates 20 and 21 in Appendix A. The results of the grain size analyses are presented in curve form on Plates 24 through 45 in Appendix A.

**Geotechnical Analysis Report  
Clinch River Power Plant  
Pond No. 2 Closure  
Russell County, Virginia**

Soils described in this report have been classified basically in accordance with the Unified Soil Classification System, but this system has been augmented by the use of special adjectives to designate the approximate percentages of minor soil components for the naturally occurring soils. Definitions of these special adjectives and an explanation of the symbols and terms used on the boring logs are presented on Plates 2 and 3 in Appendix A.

## GENERAL SUBSURFACE CONDITIONS

Consistent with the purpose of the ash pond, coal ash fill was predominantly encountered in the borings. Borings B-1, B-2, B-5, B-6 and B-8 encountered coal ash at the surface to depths of boring completion or near auger refusal upon bedrock. The coal ash generally consisted of very-loose to loose fly ash, with zones of bottom ash. Borings B-5 and B-6 encountered between 2.5 and 5.0 feet of medium stiff silty clay and clayey silt just above the bedrock surface. Borings B-3 and B-4 were drilled on top of the lower and middle dike, respectively. The dike material encountered in these borings was primarily composed of medium-dense to dense fine to coarse gravel consisting of shale fragments, with zones of hard silty clay and clayey silt, and zones of fine to coarse sand. Natural soils were encountered in Boring B-3 beneath the lower dike consisting of organic clayey silt and fine to medium sand above the bedrock surface. Beneath the middle dike, Boring B-4 encountered coal ash consisting of approximately 12 feet of medium-dense to very-dense ash followed by 30 feet of loose to medium-dense ash.

Bedrock was encountered in Borings B-2 through B-7 at elevations ranging from 1491.2 to 1522.4 feet above Mean Sea Level (MSL). Based on descriptions of the rock core and rock fragments obtained in the split spoon samples, bedrock at the site consists of very-soft to soft gray shale and hard gray limestone. Generally, bedrock encountered beneath the dike system consisted of the very-soft to soft shale. Both rock types exhibited massive bedding with many diagonal fractures. Rock Quality Designation (RQD) of the limestone ranged between 26 to 64%.

Groundwater observations were made as each boring was being advanced and measurements were made at the completion of drilling. During drilling, groundwater was encountered within the borings at depths of 11.5 to 24.4 feet below the existing grade, with groundwater elevations generally decreasing as the borings approached Dump's Creek.

## DESIGN CROSS SECTION FOR ANALYSES

### Geometry

The three tiered dike system created from subsequent vertical expansions of Pond 2 is demonstrated on the design section developed by AEP in 1990. As previously noted, however, the upper dike was intentionally partially removed to prevent surface water ponding. Thus, the upper dike is no longer well defined. Based on topographic data provided by AEP, BBCM developed a cross section of the surface topography through the pond. Since only the surficial topography has changed since AEP's analysis, the subsurface stratigraphy and geometry of the dikes as shown on BBCM's design cross section were created based on AEP's design cross-section, as well as information from

the new borings. The ash pond site stratigraphy consists principally of the clay dike system and the impounded fly ash. Beneath the fly ash, a layer of bottom ash placed directly over the bedrock serves as a drainage layer, although this layer was not well defined in the borings. The design cross section is presented in Appendix B with the slope stability analysis.

### Soil Layers

#### *Cover System*

The proposed cover system extends up from the crest of the middle dike at a 5% slope until it intersects the hillside. The cover will consist of 24 inches of soil cover over a geocomposite drainage system and a 30-MIL PVC geosynthetic liner. The soil cover will consist mainly of existing onsite soil/rock spoils processed to obtain a maximum 6 inch particle size. Dry fly ash will be placed as structural fill to bring the existing ground surface up to the planned elevation before the cover system can be constructed. Additional material information can be found in the Cover System design package and details of the cover system are shown on the design plans.

#### *Coal Ash*

The existing impounded coal ash consists mainly of loose fly ash with zones of bottom ash and pond ash. Deposits of ash range from 30 feet beneath the middle dike to approximately 60 feet in the area between the middle dike and the hillside. As part of the 1990 report, AEP performed two direct shear tests on the impounded ash and delineated the ash into two separate layers based the time of placement. The upper fly ash layer begins at Elevation 1539, which is the bottom elevation of the middle dike. The direct shear tests performed on the fly ash samples yielded drained friction angles of 30 and 27 degrees for the lower and upper fly ash layers, respectively. Based on information available in literature (DiGioia and Nuzzo 1972) and the fact that actual laboratory testing was performed on these samples, BBC&M believes that these values are reasonable to represent the long-term strength of the in-place fly ash.

#### *Clay/Shale Dikes*

The existing dikes were constructed of a mixture of compacted clay shale and rock fill, likely excavated from the nearby hillside which is used to contain the ash. The dikes have historically performed well without any major stability or seepage problems. The middle dike was constructed inside of the lower dike and founded on the ponded coal ash retained by the lower dike. AEP assumed a drained friction angle of 32 degrees with a cohesion value of 200 psf for their stability analyses.

Utilizing the correlations between index properties and fully softened shear strength included in Stark et al. 2005, BBC&M estimated the shear strength of the dike material based on liquid limit and clay size fraction values obtained from during laboratory testing. The liquid limit for samples obtained in this material ranged from 19 to 29, while the average clay size fraction (% finer than 0.05 mm) was 24. Adjusting for the impact of ball milling and using an effective normal stress between 50 and 100 kPa (approximately equal to the effective stress range in the clay dikes), the correlation suggests a fully softened friction angle between 30 and 33 degrees. Therefore, the assumed friction angle of 32 degrees appears reasonable.

*Bottom Fill*

Historical drawings detail a layer of bottom ash constructed beneath Pond 2 and directly over bedrock to serve as a drainage layer. In AEP's stability report, this layer is modeled with a thickness of 10 to 12 feet and described as the same material as the clay dikes and exhibiting the same strength characteristics. Based on the new borings, this layer was shown to be inconsistent in thickness and extent. Based on a consolidated-undrained triaxial shear test, AEP assigned a friction angle of 28.5 degrees and a cohesion of 200 psf to model the strength of this layer. For BBCM's analyses, the value of 28.5 degrees was maintained, but the cohesion value was reduced to 0 psf recognizing the inconsistencies associated with defining this layer in the borings.

*Bedrock*

Rock core samples obtained in Borings B-3 and B-8 show that the bedrock surface at the site consists of very-soft to soft shale beneath the dike system (Borings B-2 through B-5) to hard limestone at the base of the hillside (Boring B-6). With the exception of Boring B-6, these borings also indicate that the top of bedrock is relatively flat, varying from El 1491.2 to 1496.7 across the site. Based on the site topography, BBCM believes that Pond 2 was constructed in the old river valley of Dumps Creeks, and that Dumps Creek may have actually been re-routed as part of construction; thus the reason for the flat bedrock surface.

The shear strength of these rocks is largely a function of the presence of joints and of particular importance, slickenside surfaces. However, the factors of safety computed for both circular and translational failure surfaces were shown to be independent of the strength of the bedrock as all slip surface passed well above the bedrock.

*Strength Parameters*

Shear strength parameters for the fly ash, the clay/shale dikes, the bottom ash fill layer, and the riprap fill were developed in the 1990 report. These parameters were developed based on laboratory testing performed as part of the analyses. With exception of the shear strength of the clay dikes, BBCM used AEP's values to carry out the stability analyses. A summary of the values used are shown in Table 1 below.

**Table 1: Summary of material shear strength parameters for stability analyses.**

| Material Description        | $\gamma_{wet}$<br>(pcf) | Drained Strength |                  | Reference             |
|-----------------------------|-------------------------|------------------|------------------|-----------------------|
|                             |                         | $\Phi'$          | $c'$ (psf)       |                       |
| Proposed Ash Fill and Cover | 100                     | 32               | 0                | Assumed Value         |
| Upper Ash Layer             | 101                     | 27               | 0                | AEP Direct Shear      |
| Lower Ash Layer             | 92                      | 30               | 0                | AEP Direct Shear      |
| Clay/Shale Dikes            | 134                     | 32 <sup>1</sup>  | 100 <sup>2</sup> | AEP Assumed value     |
| Bottom Fill                 | 129                     | 28.5             | 0 <sup>2</sup>   | AEP CU Triaxial Shear |
| Rip-Rap                     | 125                     | 35               | 0                | AEP Section 1         |

<sup>1</sup>Value confirmed through Index correlations for fully softened shear strength

<sup>2</sup>Value reduced from 200 psf

### Groundwater Level

During active operations, the fly ash was considered to be in 'full saturation' due to the nature of the placement of the material, implying the groundwater level was equivalent with the top of the fly ash in the active filling areas. AEP's analysis incorporated this elevated groundwater level, as operations at Pond 2 were planned to continue for several years. However, since operations at the plant have become inactive, the groundwater level has fallen to lower levels. BBCM estimated groundwater levels within the existing ash impoundment based on the groundwater levels encountered during drilling within the new borings. Existing piezometer wells at the site were checked, but satisfactory data was not attainable as they have generally stopped functioning.

As shown in the Design Cross Section, the groundwater levels encountered between Borings B-3 through B-6 fall in succession as the borings are distanced further from the hillside and the groundwater level approaches the normal pool elevation of Dumps Creek. The groundwater level beneath the middle dike is located approximately 44 feet below the top of the dike and approximately 23 feet below the bottom of dike. The groundwater surface is shown on Design Cross Section in Appendix B.

With the design of the final closure plans, groundwater recharge from rainfall events will be significantly reduced; with the only possible source of groundwater impact from the potential seepage emanating from the existing hillside. For these reasons, BBCM believes that the assumed phreatic surface incorporated in the following analyses is reasonable to represent long term conditions.

## **ANALYSES AND RESULTS**

### Liquefaction Potential

AEP evaluated the design seismic parameters using GeoSlope's Quake/W software as part of the final closure analysis. The following paragraphs were submitted by AEP to summarize their findings:

A numerical model was developed to assess the potential of liquefaction of the saturated fly ash at the ash pond 2 for the long term conditions after the closure of the pond in Clinch River Plant. The analysis was conducted using Quake/W 2007 program, a component of GeoStudio 2007, built by Geo-Slope International, Ltd.

The model was prepared by BBCM using Slope/W program based on a review of available data, and the field exploration program performed for this study, one critical cross-section was developed showing the various material zones. Dynamic material properties of saturated fly ash were based on cyclic triaxial tests results performed at Ohio State University (OSU). Equivalent linear analysis was conducted with strain dependent modulus and damping relationships for other materials were estimated using published relationships. Table 1 summarizes the static and dynamic material properties used in this analysis.

No historical Earthquake record was available to be used in the analysis, however, USGS 2002 Interactive Deaggregations website provides the most

likely synthetic seismograph record for the specified location. The obtained acceleration-time history was used as the loading force in this analysis. (AEP used a horizontal acceleration coefficient of 0.187 for this analysis.)

The performed dynamic analyses using Quake/W program provides details on earthquake-induced porewater pressure, stresses, and other important parameters for various points within the model. In addition, the program highlights location where liquefaction occurs. According to the results of the dynamic analysis there was no liquefaction within the fly ash under the applied earthquake loading. Maximum horizontal and vertical movement at the ground surface deformation on the existing dikes were less than 0.2 inch.

**Table 2 Strength Parameters Used in the Liquefaction Analysis**

| <i>Material</i>   | <i>Unit weight (pcf)</i> | <i>Friction angle (°)</i> | <i>Cohesion (psf)</i> | <i>Gmax (psf)</i> | <i>Damping ratio</i> |
|-------------------|--------------------------|---------------------------|-----------------------|-------------------|----------------------|
| Proposed Ash fill | 100                      | 32                        | 0                     | 4×10 <sup>5</sup> | 0.03                 |
| Upper Ash Layer   | 101                      | 27                        | 0                     | 4×10 <sup>5</sup> | 0.03                 |
| Lower Ash Layer   | 92                       | 30                        | 0                     | 1×10 <sup>6</sup> | 0.05                 |
| Clay/Shale Dikes  | 134                      | 32                        | 100                   | 8×10 <sup>5</sup> | 0.04                 |
| Bottom Fill       | 129                      | 28.5                      | 0                     | 6×10 <sup>6</sup> | 0.03                 |
| Rip-Rap           | 125                      | 37                        | 0                     | 1×10 <sup>7</sup> | 0.02                 |
| Shale             | 140                      | 15                        | 1100                  | 8×10 <sup>7</sup> | 0.01                 |

Global Slope Stability Analysis

Following an examination of the previous slope stability analyses by AEP, BBCM performed a limited number of slope stability analyses to assess what impact the proposed cover system and associated fill would have on the computed factors of safety. Limit equilibrium slope stability analyses were performed using the aforementioned design cross-section, which was based on the original design cross-section developed by AEP. Please note that this work focused on the potential for failure surfaces to develop through the existing dike system. The veneer stability of the proposed cover system (which is independent of soil borings) was assessed separately.

The slope stability analyses were performed using the 2-D limit equilibrium computer program Slide V 5.035 developed by Rocscience, Inc. Both circular and translational (block type) deep-seated failure surfaces were examined under static (long-term) and pseudo-static loading conditions for the final slope configuration; with the analysis focused on the stability of the middle dike. Stability of the lower dike, which is not being modified as part of the proposed cover system design, was only considered in a translational failure in combination with the middle dike. The graphical computer output for these analyses has been included with this report in Appendix B. Army Corps of Engineers (ACOE) specifications for earthen embankment dams require a minimum factor of safety of 1.5 with respect to shear failure for static conditions, and 1.0 for pseudo-static loading conditions. Overall, factors of safety computed during this analysis were higher than those computed by AEP in 1990 mainly due to the lowered

groundwater level in the impoundment. The following table shows the computed factors of safety for each stability analyses performed for this report

**Table 3. Summary of slope stability safety factors for final ash pond configuration.**

| Load Case   | Computed FS | FS <sub>REQ D</sub> |
|---|-------------|---------------------|
| Static Loading with Final Slopes<br>-Circular Failure Surface                                 | 1.67        | 1.5                 |
| Static Loading with Final Slopes<br>-Translational Failure Surface<br>-Middle Dike            | 2.67        | 1.5                 |
| Static Loading with Final Slopes<br>-Translational Failure Surface<br>-Lower and Middle Dikes | 2.29        | 1.5                 |
| Pseudo-Static Loading with Final Slopes<br>-Circular Failure Surface                          | 1.13        | 1.0                 |

Settlement

BBCM used the design cross section to estimate the maximum settlement due to the surcharge from the ash fill for the proposed cover. Settlements estimates were performed using the one-dimensional compression software FoSSA version 2.0 developed by ADAMA Engineering, Inc which is intended for the analyses of embankments and foundations. Typical consolidation parameters of fly ash were used for the preliminary calculations. The lower fly ash layer was assigned a slightly lower compression index value in correlation with its higher shear strength derived from the direct shear test

**Table 5: Consolidation parameter of impounded fly ash**

| Material Description | $\gamma_{wet}$ (pcf) | Poissons Ratio $\nu$ | Compression Index, $c_c$ | Recompression Index, $c_r$ | Void Ratio $e_o$ |
|----------------------|----------------------|----------------------|--------------------------|----------------------------|------------------|
| Upper Ash Layer      | 101                  | 0.5                  | 0.20                     | 0.03                       | 0.8              |
| Lower Ash Layer      | 92                   | 0.5                  | 0.15                     | 0.03                       | 0.8              |

Results of the analysis indicate that settlement of the fly ash foundation in the range of 1.8 to 2.7 feet may be expected in areas of the foundation subjected to the thickest cover. Although modeled as a consolidation response, settlement should occur relatively quickly during construction due to the permeability characteristics of the fly ash and therefore settlement is not expected to adversely affect the cover system. Output from the analysis is presented in Appendix C

## CONCLUSIONS

BBCM performed slope stability analyses, examined liquefaction potential, and estimated the maximum foundation settlement in support of our cover system design for Pond No. 2 at the Clinch River Power Plant. BBCM believes the stability of the dike system has improved since operations at Pond 2 became inactive. The additional driving forces on the middle dike created from the proposed fill and cover system had a smaller effect on the factor of safety in comparison to the drop in the groundwater level. As discussed, it was concluded that the liquefaction would not be initiated under the design earthquake load. Additionally, settlement is not expected to adversely affect the cover system as the majority of settlement should occur during placement of the fill layer, prior to constructing the final cover system.



**APPENDIX A: Subsurface Investigation**

## EXPLANATION OF SYMBOLS AND TERMS USED ON BORING LOGS FOR SAMPLING AND DESCRIPTION OF SOIL

### SAMPLING DATA

- Blocked-in "SAMPLES" column indicates sample was attempted and recovered within this depth interval
- Sample was attempted within this interval but not recovered
- 2/5/9 - The number of blows required for each 6-inch increment of penetration of a "Standard" 2-inch O D split-barrel sampler, driven a distance of 18 inches by a 140-pound hammer freely falling 30 inches. Addition of one of the following symbols indicates the use of a split-barrel other than the 2" O D. sampler:
  - 2S - 2½" O D split-barrel sampler
  - 3S - 3" O D split-barrel sampler
- P - Shelby tube sampler, 3" O D, hydraulically pushed
- R - Refusal of sampler in very-hard or dense soil, or on a resistant surface
- 50-2" - Number of blows (50) to drive a split-barrel sampler a certain number of inches (2), other than the normal 6-inch increment
- S/D - Split-barrel sampler (S) advanced by weight of drill rods (D),
- S/H - Split-barrel sampler (S) advanced by combined weight of rods and drive hammer (H)

### SOIL DESCRIPTIONS

All soils have been classified basically in accordance with the Unified Soil Classification System, but this system has been augmented by the use of special adjectives to designate the approximate percentages of minor components as follows:

| <u>Adjective</u> | <u>Percent by Weight</u> |
|------------------|--------------------------|
| trace            | 1 to 10                  |
| little           | 11 to 20                 |
| some             | 21 to 35                 |
| "and"            | 36 to 50                 |

The following terms are used to describe density and consistency of soils:

| <u>Term (Granular Soils)</u> | <u>Blows per foot (N<sub>60</sub>)</u> |
|------------------------------|--|
| Very-loose                   | Less than 5                            |
| Loose                        | 5 to 10                                |
| Medium-dense                 | 11 to 30                               |
| Dense                        | 31 to 50                               |
| Very-dense                   | Over 50                                |
| <u>Term (Cohesive Soils)</u> | <u>Qu (tsf)</u>                        |
| Very-soft                    | Less than 0.25                         |
| Soft                         | 0.25 to 0.5                            |
| Medium-stiff                 | 0.5 to 1.0                             |
| Stiff                        | 1.0 to 2.0                             |
| Very-stiff                   | 2.0 to 4.0                             |
| Hard                         | Over 4.0                               |

## EXPLANATION OF SYMBOLS AND TERMS USED ON BORING LOGS FOR SAMPLING AND DESCRIPTION OF ROCK

### SAMPLING DATA

When bedrock is encountered and rock core samples are attempted, the "SAMPLING EFFORT" column is used to record the type of core barrel used (NXM), the percentage of core recovered (REC) for each run of the sampler, and the Rock Quality Designation (ROD) value. Rock-core barrels can be of either single- or double-tube construction, and a special series of double-tube barrels, designated by the suffix M, is commonly used to obtain maximum core recovery in very-soft or fractured rock. Three basic groups of barrels are used most often in subsurface investigations for engineering purposes, and these groups and the diameters of the cores obtained are as follows:

|                  |   |              |
|------------------|---|--------------|
| AX, AW, AXM, AWM | - | 1-1/8 inches |
| BX, BW, BXM, BWM | - | 1-5/8 inches |
| NX, NW, NXM, NWM | - | 2-1/8 inches |

Rock Quality Designation (RQD) is expressed as a percentage and is obtained by summing the total length of all core pieces which are at least 4 inches long and then dividing this sum by the total length of core run. It has been found that there is a reasonably good relationship between the RQD value and the general quality of rock for engineering purposes. This relationship is shown as follows:

| <u>RQD - %</u> | <u>General Quality</u> |
|----------------|------------------------|
| 0 - 25         | Very-poor              |
| 25 - 50        | Poor                   |
| 50 - 75        | Fair                   |
| 75 - 90        | Good                   |
| 90 - 100       | Excellent              |

### ROCK HARDNESS

THE FOLLOWING TERMS ARE USED TO DESCRIBE ROCK HARDNESS:

| <u>Term</u> | <u>Meaning</u>  | <u>Mohs' Hardness</u> |
|-------------|---|-----------------------|
| Very-soft   | Rock such as shale can be easily picked apart by the fingers. Sandstone is poorly cemented and very friable. The rock resembles hard clay or dense sand, but has rock structure.  | Less than 1           |
| Soft        | Rock such as shale, siltstone or limestone can be scratched or powdered by fingernail pressure. Sandstone is mostly poorly cemented, and individual sand grains can be separated from the main rock mass by a fingernail. | 1 to 1½               |
| Medium-hard | Rock cannot be scratched by a fingernail, but can be powdered by a knife. Sandstone is mostly well cemented, but individual grains can be removed by scratching with a knife.   | 2½ to 5½              |
| Hard        | Rock is well cemented and cannot be powdered by a knife.  | 5½ to 6½              |
| Very-hard   | Rock can be powdered by a steel file. Rock cannot be scratched by a steel file and the core sample rings when struck with a hammer.   | Greater than 6½       |

**LOG OF BORING NO. B-1  
CLINCH RIVER POND #2 CLOSURE  
CARBO, VIRGINIA**



DATE: 7/28/08

LOCATION: NAD 83 VA South Zone

COORDINATES: N 3521957.2; E 10404206.58

ELEVATION: 1558.4

DRILLING METHOD: 3-1/4" I.D. Hollow-stem Auger

COMPLETION DEPTH: 28.3'

SAMPLER(S): 2" O.D. Split-barrel Sampler

| ELEV.  | DEPTH, FEET | SAMPLE NUMBER | SAMPLE EFFORT | N  | VALUE | SAMPLE REC. % | USCS  | DESCRIPTION  | NATIONAL PARTICULATES INDEX |              | TEST RESULTS |
|--------|-------------|---------------|---------------|----|-------|---------------|-------|--|-----------------------------|--------------|--------------|
|        |             |               |               |    |       |               |       |  | PLASTIC LIMIT               | LIQUID LIMIT |              |
| 1558.4 | 0           | 1             | 12, 19        | 31 | 100   |               | ML-SM | FILL: Medium-dense to dense gray fly ash intermixed with bottom ash, dry                       |                             |              |              |
|        | 5           | 2             | 5, 7, 8       | 15 | 100   |               |       |  |                             |              |              |
| 1558.4 | 10          | 3             | 3, 4, 5       | 9  | 100   |               | ML-SM | FILL: Very-loose to loose gray fly ash, contains zones of bottom ash, moist                    |                             |              |              |
|        | 15          | 4             | 1, 1, 0       | 3  | 100   |               |       |  |                             |              |              |
| 1536.6 | 20          | 5             | 1, 1, 0       | 1  | 100   |               | ML-SM | FILL: Very-loose gray fly ash, contains zones of bottom ash, contains few shale fragments, wet |                             |              | MC-55 G      |
| 1530.1 | 25          | 6             | 1, 1, 0       | 1  | 67    |               |       |  |                             |              |              |
|        | 30          |               |               |    |       |               |       |  |                             |              |              |
|        | 35          |               |               |    |       |               |       |  |                             |              |              |

- Boring logged by AEP personnel  
 - Blind drilled 3-1/4" augers; no grounding procedures on this boring  
 - Static Water Level 0.0', used 100 gallons of quick grout to grade

SYMBOLS USED TO INDICATE TEST METHODS:  
 1 - Penetration Test  
 2 - Shear Comp. Test  
 3 - Triaxial Comp. Test  
 4 - Direct Comp. Test  
 5 - Unconf. Comp. Test  
 6 - Consolidation Test  
 7 - Swell Test  
 8 - Free Swell Test  
 9 - Free Shrinkage Test  
 10 - Free Expansion Test  
 11 - Free Contraction Test  
 12 - Free Expansion and Contraction Test  
 13 - Free Shrinkage and Expansion Test  
 14 - Free Swell and Shrinkage Test  
 15 - Free Swell and Shrinkage and Expansion and Contraction Test

2005 SVA VALUE WEAR 111497-007 GPH DRACALGOT 11.8.05

**LOG OF BORING NO. B-2  
CLINCH RIVER POND #2 CLOSURE  
CARBO, VIRGINIA**



DATE: **8/6/08**

LOCATION: **NAD 83 VA South Zone**      COORDINATES: **N 3522090.54; E 10404660.72**      ELEVATION: **1559.6**  
 DRILLING METHOD: **3-1/4" I.D. Hollow-stem Auger**      COMPLETION DEPTH: **68.4'**  
 SAMPLER(S): **2" O.D. Split-barrel Sampler**

| ELEV | DEPTH, FEET | SAMPLE NUMBER | SAMPLE EFFORT | N  | VALUE | SAMPLE REC-% | USCS  | DESCRIPTION   | SATURATED CONSISTENCY INDEX |                  |                   |               | TEST RESULTS |
|------|-------------|---------------|---------------|----|-------|--------------|-------|---|-----------------------------|------------------|-------------------|---------------|--------------|
|      |             |               |               |    |       |              |       |   | WATER CONTENT (%)           | LIQUID LIMIT (%) | PLASTIC LIMIT (%) | SHRINKAGE (%) |              |
| 1572 | 0-5         | 3 / 1         | 1             | 2  | 60    |              | ML-SM | FILL: Very-loose to loose gray fly ash intermixed with bottom ash, dry    |                             |                  |                   |               |              |
|      | 5-10        |               |               |    |       |              |       |   |                             |                  |                   |               |              |
|      | 10-15       | 3 / 2         | 4             | 6  | 100   |              |       |   |                             |                  |                   |               |              |
| 1572 | 15-20       | 3 / 2         | 4             | 6  | 100   |              | ML-SM | FILL: Very-loose to loose gray fly ash intermixed with bottom ash, wet    |                             |                  |                   |               |              |
|      | 20-25       |               |               |    |       |              |       |   |                             |                  |                   |               |              |
|      | 25-30       | 2 / 4         | 2             | 6  | 100   |              |       |   |                             |                  |                   |               |              |
|      | 30-35       | 1 / 2         | 5             | 7  | 100   |              |       |   |                             |                  |                   |               |              |
| 1572 | 35-40       | 1 / 1         | 3             | 3  | 100   |              | ML-SM | FILL: Very-loose to loose gray fly ash, contains zones of bottom ash, wet |                             |                  |                   |               |              |
|      | 40-45       |               |               |    |       |              |       |   |                             |                  |                   |               |              |
|      | 45-50       | 5 / 3         | 12            | 15 | 100   |              |       |   |                             |                  |                   |               |              |

WATER LEVEL: **35.4**  
 WATER NOTE: **Caved at 64'**  
 DATE: **8/6/08**

SYMBOLS USED TO INDICATE TEST RESULTS:  
 1 - Gradation      2 - Sat      3 - Plasticity Index  
 4 - Liquid Limit      5 - Shrinkage  
 6 - Dry Comp      7 - Dry Comp  
 8 - Plasticity Index

11/18/2005 GPA/BUCM/GDT 11:00 AM  
 2008 VA-AUGER WITH

LOG OF BORING NO. B-2  
CLINCH RIVER POND #2 CLOSURE  
CARBO, VIRGINIA



DATE: 8/6/08

LOCATION: NAD 83 VA South Zone COORDINATES: N 3522090.54; E 10404660.72 ELEVATION: 1559.6  
 DRILLING METHOD: 3-1/4" I.D. Hollow-stem Auger COMPLETION DEPTH: 68.4'  
 SAMPLER(S): 2" O.D. Split-barrel Sampler

| ELEV   | DEPTH<br>FEET | SAMPLE<br>NUMBER | SAMPLE<br>EFFECT | N  | VALUE<br>SAMPLE<br>REC. % | USCS  | DESCRIPTION  | UNIFORM CONSISTENCY INDEX |    |    |                | TEST<br>RESULTS |
|--------|---------------|------------------|------------------|----|---------------------------|-------|--|---------------------------|----|----|----------------|-----------------|
|        |               |                  |                  |    |                           |       |  | PL                        | LL | PI | U <sub>c</sub> |                 |
|        |               |                  |                  |    |                           | ML-SM | FILL: Very-loose to loose gray fly ash,<br>contains zones of bottom ash, wet |                           |    |    |                |                 |
|        | 35            | 8                | 1/0, 2           | 2  | 100                       |       |  |                           |    |    |                |                 |
|        | 40            |                  |                  |    |                           |       |  |                           |    |    |                |                 |
|        | 45            | 9                | SH, SH, SH       |    | 100                       |       |  |                           |    |    |                |                 |
|        | 50            | 10               | 2, 1/4           | 5  | 100                       |       |  |                           |    |    |                |                 |
|        | 55            | 11               | 2, 1/4           | 2  | 100                       |       |  |                           |    |    |                |                 |
|        | 60            | 12               | SH, SH, SH       |    | 100                       |       |  |                           |    |    |                |                 |
|        | 65            | 13               | 5, 3, 6          | 9  | 100                       |       |  |                           |    |    |                |                 |
| 1492.2 | 68.4          | 14               | 5, 17, 50-1"R    | 73 |                           | SM    | FILL: Medium-dense dark-gray bottom ash,<br>wet                              |                           |    |    |                |                 |

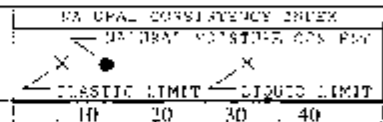

ML-SM  
G

WATER LEVEL: 35.4  
 WATER NOTE: Caved at 64.1'  
 DATE: 8/6/08

SYMBOLS USED TO INDICATE TEST RESULTS  
 G - Gradation  
 C - Compaction  
 T - Triax Comp  
 O - Oedometer  
 S - Soil Swell  
 W - Water Content  
 U - Unit Weight  
 R - Retention Test (%)

2005 REV. ALL I.D. WITH: 11497-007-021 BB, N. C. L. J. 11/26/08

**LOG OF BORING NO. B-2  
CLINCH RIVER POND #2 CLOSURE  
CARBO, VIRGINIA**



DATE: 8/6/08

LOCATION: NAD 83 VA South Zone

COORDINATES: N 3523090.54; E 10404660.72

ELEVATION: 1559.6

DRILLING METHOD: 3-1/4" LD. Hollow-stem Auger

COMPLETION DEPTH: 68.4'

SAMPLER(S): 2" O.D. Split-barrel Sampler

| ELEV.<br>FEET                     | DEPTH<br>FEET | SAMPLE<br>NUMBER | SAMPLE<br>DEPTH | SUPPORT | N<br>VALUE | SAMPLE<br>REC. % | USCS | DESCRIPTION   | NATURAL CONSISTENCY INDEX |               | TEST<br>RESULTS |
|-----------------------------------|---------------|------------------|-----------------|---------|------------|------------------|------|---|---------------------------|---------------|-----------------|
|                                   |               |                  |                 |         |            |                  |      |   | NATURAL MOISTURE CONTENT  | PLASTIC LIMIT |                 |
|                                   | 0             |                  |                 |         |            |                  |      | - Boring logged by AEP personnel<br>- Blind drilled 3-1/4" augers down; no<br>grounding procedure used on this boring;<br>moved boring 14' southwest<br>- Drilling mud added to boring at 12 0'<br>- Auger refusal encountered at 68.4' |                           |               |                 |
|                                   | 75            |                  |                 |         |            |                  |      |   |                           |               |                 |
|                                   | 80            |                  |                 |         |            |                  |      |   |                           |               |                 |
|                                   | 85            |                  |                 |         |            |                  |      |   |                           |               |                 |
|                                   | 90            |                  |                 |         |            |                  |      |   |                           |               |                 |
|                                   | 95            |                  |                 |         |            |                  |      |   |                           |               |                 |
|                                   | 100           |                  |                 |         |            |                  |      |   |                           |               |                 |
|                                   | 105           |                  |                 |         |            |                  |      |   |                           |               |                 |
| WATER LEVEL: <u>35.4</u>          |               |                  |                 |         |            |                  |      |   |                           |               |                 |
| WATER NOTE: <u>Caved at 64.1'</u> |               |                  |                 |         |            |                  |      |   |                           |               |                 |
| DATE: <u>8/6/08</u>               |               |                  |                 |         |            |                  |      |   |                           |               |                 |

1149700-GPI-BBCM-CDDT-11/08-05

20 08 NAVALE WITA

SAMPLES SHOWN IN THIS LOG INDICATE TEST RESULTS  
 G - Gradation      S - Swell      R - Relative Density (G)  
 O - Organic Comp.      Sp - Specific Gravity      W - Unit Weight (pcf)  
 T - Triaxial Comp.      P - Permeability      S - Relative Density (G)  
 C - Consolidation

**LOG OF BORING NO. B-3  
CLINCH RIVER POND #2 CLOSURE  
CARBO, VIRGINIA**



DATE: 7/22/08 - 7/23/08

LOCATION: NAD 83 VA South Zone

COORDINATES: N 3522639.7; E 10404557.48

ELEVATION: 1534.1

DRILLING METHOD: 3-1/4" I.D. Hollow-stem Auger

COMPLETION DEPTH: 54.4'

SAMPLER(S): 2" O.D. Split-barrel Sampler, 3" O.D. Shelby Tube Sampler, NQ Rock Core Barrel

| ELEV.  | DEPTH, FEET | SAMPLE NUMBER | SAMPLE EFFORT | N VALUE | SAMPLE REC. % | USCS  | DESCRIPTION   | UNIFIED CONSISTENCY INDEX  |              |    |    | TEST RESULTS |  |  |  |  |  |         |
|--|-------------|---------------|---------------|---------|---------------|-------|---|--|--------------|----|----|--------------|--|--|--|--|--|---------|
|  |             |               |               |         |               |       |   | PLASTIC LIMIT  | LIQUID LIMIT | PL | LL |              |  |  |  |  |  |         |
|  | 0           |               |               |         |               |       |   |  |              |    |    |              |  |  |  |  |  |         |
|  | 1           | 17            | 30            | 50      | 80            | GC-SC | FILL: Medium-dense to very-dense gray and brown fine to coarse gravel consisting of shale fragments, little to some (% varies) fine to coarse sand, some clayey silt, contains zones of medium-stiff to stiff clayey silt and zones of fine to coarse sand, dry |  |              |    |    |              |  |  |  |  |  |         |
|  | 5           | 20            | 11            | 31      | 20            |       |   |  |              |    |    |              |  |  |  |  |  |         |
|  | 3           | 27            | 12            | 20      | 47            |       |   |  |              |    |    |              |  |  |  |  |  |         |
|  | 10          | 8             | 7             | 18      | 80            |       |   |  |              |    |    |              |  |  |  |  |  |         |
|  | 5           | 18            | 10            | 29      | 60            |       |   |  |              |    |    |              |  |  |  |  |  |         |
|  | 15          | 24            | 33            | 65      | 60            |       |   |  |              |    |    |              |  |  |  |  |  |         |
|  | 7           | 13            | 15            | 47      | 87            |       |   |  |              |    |    |              |  |  |  |  |  |         |
|  | 20          | 21            | 35            | 72      | 93            |       |   |  |              |    |    |              |  |  |  |  |  |         |
|  | 9           | 21            | 25            | 27      |               |       |   |  |              |    |    |              |  |  |  |  |  |         |
| 1510.1   |             | 50-5'R        |               |         |               |       |   |  |              |    |    |              |  |  |  |  |  |         |
|  | 25          | 15            | 11            | 27      | 51            | GC-SC | FILL: Medium-dense to very-dense gray and brown fine to coarse gravel consisting of shale fragments, little to some (% varies) fine to coarse sand, some clayey silt, contains zones of medium-stiff to stiff clayey silt and zones of fine to coarse sand, wet |  |              |    |    |              |  |  |  |  |  |         |
|  | 11          | 3             | 5             | 17      | 60            |       |   |  |              |    |    |              |  |  |  |  |  | H-07-19 |
|  | 12          | 1             | 12            | 80      |               |       |   |  |              |    |    |              |  |  |  |  |  | HI-451  |
|  | 30          |               |               |         |               |       |   |  |              |    |    |              |  |  |  |  |  |         |
| 1502.6   |             |               |               |         |               |       |   |  |              |    |    |              |  |  |  |  |  |         |
|  | 17          | 21            | 15            | 30      | 67            | SM    | FILL: Medium-dense gray bottom ash, wet   |  |              |    |    |              |  |  |  |  |  |         |
| 500.5  |             |               |               |         |               |       |   |  |              |    |    |              |  |  |  |  |  |         |
|  | 35          | 6             |               |         |               | ML-CL | Medium-stiff to stiff gray organic clayey silt, some fine sand, wet.  |  |              |    |    |              |  |  |  |  |  |         |
| WATER LEVEL: <u>24.1</u><br>WATER NOTE: <u>18.5' encountered</u><br>DATE: <u>7/22/08</u> |             |               |               |         |               |       |   | SYMBOLS USED TO INDICATE TEST RESULTS:<br>O - Gradation<br>X - Liquid Limit<br>T - Plastic Limit<br>P - Penetration<br>See Separate Sheets<br>H - Penetration (std)<br>U - Unit Weight (std)<br>R - Relative Density (std) |              |    |    |              |  |  |  |  |  |         |

1534.1' TO 500.5' (BBCM) (DPT) (1534.1)

500.5' VALUE WITH



DATE: 7/22/08 - 7/23/08

LOG OF BORING NO. B-3  
CLINCH RIVER POND #2 CLOSURE  
CARBO, VIRGINIA



LOCATION: NAD 83 VA South Zone      COORDINATES: N 3522639.7; E 10404557.48      ELEVATION: 1534.1

DRILLING METHOD: 3-1/4" I.D. Hollow-stem Auger      COMPLETION DEPTH: 54.4'

SAMPLER(S): 2" O.D. Split-barrel Sampler, 3" O.D. Shelby Tube Sampler, NQ Rock Core Barrel

| ELIV.  | DIPTICL<br>FEET | SAMPLE<br># | SAMPLE<br># | SAMPLE<br>EFFORT | N<br>VALUE | SAMPLE<br>REC-% | USCS  | DESCRIPTION  | NATURAL CONSISTENCY INDEX<br>VERTICAL MOISTURE CONTENT | TEST<br>RESULTS |
|--------|-----------------|-------------|-------------|------------------|------------|-----------------|-------|--|--|-----------------|
| 1496.0 |                 |             | 5           | 7                |            |                 | SM    | Medium-stiff to stiff gray organic clayey silt, some fine sand, wet.   |  | U-0.6 T.6       |
| 1497.2 |                 | 15A         |             | 18               | 100        |                 | CI-MI | Very-loose gray fine to medium sand, some silt, wet.   |  |                 |
|        |                 | 15B         |             |                  | 42         |                 |       |  |  |                 |
| 1494.8 |                 | 16A         | 4           | 11               | 55         | 100             |       | Soft to medium-stiff gray silt "and" fine sand, few lenses of silt, slightly organic, trace fine to coarse sand, trace fine gravel, wet. |  | G<br>H-25.0.6   |
|        | 40              | 16B         |             | 44               | 85         |                 |       | Very-dense brown and gray fine to coarse sand, little fine to coarse gravel, some silt, wet.   |  | G               |
| 1493.1 |                 | 17          |             |                  | 13         |                 |       | Very-soft to soft dark-gray shale, diagonal bedding, numerous diagonal and irregular fractures, few smooth slickenside type features.    |  |                 |
|        |                 | 18          |             |                  | 38         |                 |       |  |  |                 |
|        | 45              |             |             |                  |            |                 |       |  |  |                 |
|        |                 | 19          |             |                  | 81         |                 |       |  |  |                 |
|        | 50              |             |             |                  |            |                 |       |  |  |                 |
|        |                 | 20          |             |                  | 98         |                 |       |  |  |                 |
| 1479.2 |                 |             |             |                  |            |                 |       |  |  |                 |
|        | 55              |             |             |                  |            |                 |       |  |  |                 |
|        |                 |             |             |                  |            |                 |       |  |  |                 |
|        | 60              |             |             |                  |            |                 |       |  |  |                 |
|        |                 |             |             |                  |            |                 |       |  |  |                 |
|        | 65              |             |             |                  |            |                 |       |  |  |                 |
|        |                 |             |             |                  |            |                 |       |  |  |                 |
|        | 70              |             |             |                  |            |                 |       |  |  |                 |

- Encountered water at 24.1'
- Encountered cobbles at 5.5'
- Sample S-2 appeared to be cuttings, drove cobble
- Drilling mud added at 38.1'
- Encountered auger refusal at 42.0'
- Casing set at 42.0'
- Reamed out bore hole with 2-7/8" Tricone bit from 0.0' to 43.0'
- Backfilled boring with bentonite grout at completion.
- Water at 2.5' at completion (influenced by water for coring and drilling mud).
- Boring sounded at 53.9' at completion
- Caved at 18.5' after casing pulled

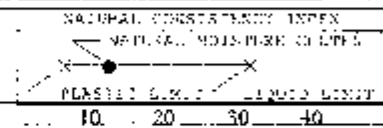

SYMBOLS USED TO INDICATE TEST RESULTS

- - Gradation
- - Moisture
- - Liquid Limit
- - Plasticity
- - Compaction
- - Swell
- - Consolidation
- - Settlement
- - Permeability
- - Shear
- - Triaxial
- - CBR

WATER LEVEL: 24.1'  
WATER NOTE: 18.5' encountered  
DATE: 7/22/08

2008-N-V-VALUE WITH

DATE: 7/24/08

# LOG OF BORING NO. B-4 CLINCH RIVER POND #2 CLOSURE CARBO, VIRGINIA



LOCATION: NAD 83 VA South Zone

COORDINATES: N 3522561; E 10404636.87

ELEVATION: 1560.3

DRILLING METHOD: 3-1/4" I.D. Hollow-stem Auger

COMPLETION DEPTH: 66.9'

SAMPLER(S): 2" O.D. Split-barrel Sampler

| FLYV   | DEPTH, FEET | SAMPLE NUMBER | SAMPLE EFFORT | N VALUE | SAMPLE REC. % | USCS  | DESCRIPTION  | NATURAL CONSISTENCY TEST<br>NATURAL MOISTURE CONTENT                               | TEST RESULTS |       |   |
|--------|-------------|---------------|---------------|---------|---------------|-------|--|--|--------------|-------|---|
|        | 0           |               |               |         |               |       |  |  |              |       |   |
|        | 1           | 13            | 13            | 21      | 93            | GC-SC | FILL: Medium-dense to dense gray and brown fine to coarse gravel consisting of shale fragments, little to some (% varies) fine to coarse sand, some clayey silt, contains zones of hard silty clay and zones of fine to coarse sand, dry | 10   | G            |       |   |
| 5      | 2           | 8             | 11            | 22      | 80            |       |  |  |              | H 4.5 |   |
|        | 3           | 5             | 9             | 17      | 80            |       |  |  |              |       |   |
| 10     | 4           | 6             | 16            | 25      | 67            |       |  |  |              |       |   |
|        | 5           | 11            | 19            | 34      | 81            |       |  |  |              |       |   |
| 15     | 6           | 7             | 13            | 21      | 87            |       |  |  |              |       |   |
|        | 7           | 6             | 2             | 15      | 54            |       |  |  |              |       |   |
| 20     | 8           | 6             | 61            | 11      | 60            |       |  |  |              | G     |   |
|        | 9A          | 20            |               | 59      | 100           |       |  |  |              |       |   |
| 1536.6 | 9B          | 28            |               |         | 100           |       |  |  |              |       |   |
|        | 10          | 5             | 8             | 15      | 100           | SM-MI |  | FILL: Medium-dense to very-dense gray bottom ash, contains zones of fly ash, moist |              |       |   |
|        | 11          | 15            | 19            | 35      | 100           |       |  |  |              |       |   |
|        | 12          | 6             | 14            | 26      | 100           |       |  |  |              |       | G |
| 30     | 13          | 19            | 27            | 66      | 100           |       |  |  |              |       |   |
|        | 13          | 6             |               |         |               |       |  |  |              |       |   |
| 35     | 13          | 19            | 27            | 66      | 100           |       |  |  |              |       |   |
|        | 32          |               |               |         |               |       |  |  |              |       |   |
|        |             |               |               |         |               |       |  |  |              |       |   |

WATER LEVEL: 39.2  
WATER NOTE: Covered at 54.9'  
DATE: 7/24/08

SYMBOLS USED TO INDICATE TEST RESULTS  
C - Conductivity    See    # - Parameters (Part)  
G - Liquid Comp       W - Water Dry Wt. (Gr%)  
T - Inflow Temp          R - Relative Comp. (%)  
O - Ozone                  

2008-07-24 09:00:00 GDT 11/16/08

JOB: 011-11497-007

-CONTINUED-

PLATE 10

DATE: 7/24/08

LOG OF BORING NO. B-4  
CLINCH RIVER POND #2 CLOSURE  
CARBO, VIRGINIA



LOCATION: NAD 83 VA South Zone

COORDINATES: N 3522561; E 10404636.87

ELEVATION: 1560.3

DRILLING METHOD: 3-1/4" I.D. Hollow-stem Auger

COMPLETION DEPTH: 66.9'

SAMPLER(S): 2" O.D. Split-barrel Sampler

| ELEV.  | DEPTH, FEET | SAMPLE NUMBER | SAMPLE EFFORT | N VALUE | SAMPLE REC-% | USCS  | DESCRIPTION  | NATURAL COMPRESSION INDEX | NATURAL POTENTIAL | TEST RESULTS |
|--------|-------------|---------------|---------------|---------|--------------|-------|--|---------------------------|-------------------|--------------|
| 1524.1 | 35          | 14            | 4             |         |              |       |  |                           |                   |              |
|        |             | 15A           | 3             | 18      | 100          | ML-SM | FILL: Loose to medium-dense gray fly ash and bottom ash, moist |                           |                   |              |
|        |             | 15B           | 3             | 15      | 100          |       |  |                           |                   |              |
|        | 40          | 16            | 6             | 18      | 100          |       |  |                           |                   |              |
|        |             | 17            | 5             |         | 100          |       |  |                           |                   |              |
| 1516.3 | 45          | 18A           | 3             | 27      | 100          | Mt-SM | FILL: Loose to medium-dense gray fly ash and bottom ash, wet   |                           |                   |              |
|        |             | 18B           | 3             | 15      | 100          |       |  |                           |                   |              |
|        |             | 19A           | 4             | 8       | 100          |       |  |                           |                   |              |
|        |             | 19B           | 4             | 7       | 100          |       |  |                           |                   |              |
|        | 50          | 20A           | 6             | 27      | 100          |       |  |                           |                   |              |
|        |             | 20B           | 6             | 14      | 100          |       |  |                           |                   |              |
|        | 55          | 21            | 7             | 21      | 100          |       |  |                           |                   | G            |
|        |             | 22A           | 1             | 17      | 100          |       |  |                           |                   |              |
| 1500.1 | 60          | 22B           | 1             | 45      |              | SM    | FILL: Loose to medium-dense gray bottom ash, wet               |                           |                   | H 96-16      |
|        |             | 23A           | 1             | 11      | 100          |       |  |                           |                   |              |
|        |             | 23B           | 1             | 43      |              |       |  |                           |                   | G            |
| 1494.1 | 65          | 24            | 50-2'R        | 13      |              |       | Very-soft to soft gray shale.                                  |                           |                   |              |
| 1493.4 | 70          |               |               |         |              |       |  |                           |                   |              |

- Encountered seepage at 21.7'
- Encountered water at 44.4'
- Added drilling mud at 50.7'

WATER LEVEL: 39.2  
WATER NOTE: Caved at 54.9'  
DATE: 7/24/08

SYMBOLS USED ON THE ABOVE TEST RESULTS  
G - Gradation  
U - Undr Comp  
T - Slack Comp  
C - Coequal  
S - Sub  
C - Compressed (15%)  
W - No. of Clay Wt. In Soil  
R - Relative Dens (%)

1:40000 SCALE BBCM CDL 1-08-08

2008 NVA LUR WITH

DATE: 7/29/08

**LOG OF BORING NO. B-5  
CLINCH RIVER POND #2 CLOSURE  
CARBO, VIRGINIA**



LOCATION: NAD 83 VA South Zone COORDINATES: N 3522491.17; E 10404707.72 ELEVATION: 1555.7  
 DRILLING METHOD: 3-1/4" I.D. Hollow-stem Auger COMPLETION DEPTH: 66.8'  
 SAMPLER(S): 2" O.D. Split-barrel Sampler

| ELEV   | DEPTH, FEET | SAMPLE NUMBER | SAMPLE REPORT | N  | VALUE | SAMPLE REC-% | USCS  | DESCRIPTION   | NATURAL CONSISTENCY INDEX |              | TEST RESULTS |       |
|--------|-------------|---------------|---------------|----|-------|--------------|-------|---|---------------------------|--------------|--------------|-------|
|        |             |               |               |    |       |              |       |   | PLASTIC LIMIT             | LIQUID LIMIT |              |       |
|        |             |               |               |    |       |              |       |   | 10                        | 20           | 30           | 40    |
|        |             | 1             | 6 / 6 / 6     | 12 | 100   |              | ML-SM | FILL: Very-loose to medium-dense gray fly ash, contains zone of bottom ash, dry |                           |              |              |       |
|        |             | 2             | 2 / 1 / 1     | 2  | 100   |              |       |   |                           |              |              |       |
|        |             | 3             | 1 / 1 / 14    | 15 | 100   |              |       |   |                           |              |              |       |
| 1559.0 |             | 4             | 8 / 3 / 5     | 8  | 100   |              | ML-SM | FILL: Loose gray fly ash intermixed with bottom ash, moist                      |                           |              |              |       |
| 1554.0 |             | 5             | 4 / 2 / 2     | 4  | 100   |              | ML-SM | FILL: Very-loose to loose gray fly ash, contains zones of bottom ash, wet.      |                           |              |              | MC-SP |
|        |             | 6             | 5 / 17 / 48   | 65 | 100   |              |       |   |                           |              |              |       |
|        |             | 7             | 1 / 0 / 0     | 0  | 100   |              |       |   |                           |              |              |       |

WATER LEVEL: 47.5  
 WATER NOTE: Caved at 66.7'  
 DATE: 7/29/08

SYM-BOL USED TO INDICATE TEST RESULTS:  
 - Gradation see see see  
 - Broken Comp see see see  
 - Loose Comp see see see  
 - Density see see see

2008 REV. VALUE WITH 11497-021 BBLM.GIT 11/08

**LOG OF BORING NO. B-5  
CLINCH RIVER POND #2 CLOSURE  
CARBO, VIRGINIA**



DATE: 7/29/08

LOCATION: NAD 83 VA South Zone

COORDINATES: N 3522491.17; E 10404707.72

ELEVATION: 1555.7

DRILLING METHOD: 3-1/4" I.D. Hollow-stem Auger

COMPLETION DEPTH: 66.8'

SAMPLER(S): 2" O.D. Split-barrel Sampler

| ELEV.<br>DEPTH<br>IN FEET | SAMPLE<br>NUMBER | SAMPLE<br>DEPTH | EFFORT | N<br>VALUE | SAMPLE<br>RUC-% | USCS  | DESCRIPTION  | NATURAL CONSISTENCY INDEX<br>NATURAL MOISTURE CONTENT |              | TEST<br>RESULTS |
|---------------------------|------------------|-----------------|--------|------------|-----------------|-------|--|---|--------------|-----------------|
|                           |                  |                 |        |            |                 |       |  | PLASTIC LIMIT   | LIQUID LIMIT |                 |
| 1555.7                    | 8                | 2               | 4      | 5          | 100             | ML-SM | FILL: Very-loose to loose gray fly ash, contains zones of bottom ash, wet  |   |              |                 |
| 1550                      | 9                | 6               | 3      | 7          | 100             |       |  |   |              |                 |
| 1505                      | 10               | 5               | 5      | 9          | 100             |       |  |   |              | MC=55<br>IG     |
| 1500                      | 11               | 2               | 1      | 2          | 100             |       |  |   |              |                 |
| 1499.0                    | 12               | 2               | 2      | 3          | 100             | CI    | Medium-stiff gray silty clay, little fine to coarse sand, slightly organic, few seams of fine sand, wet                                    |   |              | H 08            |
| 1484.0                    | 13               | 59<br>50-5"R    |        |            | 60              |       | Very-soft gray shale with 60 degree silt filled fractures  |   |              |                 |
| 1489.9                    | 14               | 50-1"R          |        |            |                 |       | Very-soft gray shale<br>- Blind drilled 3-1/4" augers; no grounding procedures in use on this boring<br>- Borehole grouted upon completion |   |              |                 |

WATER LEVEL: 47.5  
 WATER NOTE: Caved at 66.7'  
 DATE: 7/29/08

SYMBOLS USED TO INDICATE TEST RESULTS  
 S - Swellometer      SW - Swellometer  
 C - Cone Test      H - Penetration Test  
 T - Triaxial Test      H - Unit Test  
 C - Consolidation      C - Relative Density

LOG OF BORING NO. B-6  
CLINCH RIVER POND #2 CLOSURE  
CARBO, VIRGINIA



DATE: 7/30/08 - 8/4/08

LOCATION: NAD 83 VA South Zone

COORDINATES: N 3522248.22; E 10405163.61

ELEVATION: 1566.7

DRILLING METHOD: 3-1/4" I.D. Hollow-stem Auger

COMPLETION DEPTH: 54.6'

SAMPLER(S): 2" O.D. Split-barrel Sampler, NQ Rock Core Barrel

| ELEV.  | DEPTH FEET | SAMPLE NUMBER | SAMPLE EFFORT | N VALUE | SAMPLE REC-% | USCS  | DESCRIPTION  | NATURAL CONSISTENCY INDEX | NATURAL WETTED CONSIST | TEST RESULTS |
|--------|------------|---------------|---------------|---------|--------------|-------|--|---------------------------|------------------------|--------------|
|        | 0          |               |               |         |              | ML-SM | FILL: Loose gray fly ash, contains zones of bottom ash           |                           |                        |              |
|        | 1          | 1             | 3/3           | 6       | 100          |       |  |                           |                        |              |
|        | 2          | 2             | 1/3           | 8       | 100          |       |  |                           |                        |              |
| 1555.1 | 3          | 3             | 1/0           | 6       | 100          | ML-SM | FILL: Very-loose gray fly ash, contains zones of bottom ash, wet |                           |                        | MC-56        |
|        | 4          | 4             | 0/0           | 1       | 100          |       |  |                           |                        |              |
|        | 5          | 5             | 1/1           | 1       | 100          |       |  |                           |                        |              |
|        | 6          | 6             | SH            |         | 100          |       |  |                           |                        | MC-53        |
|        | 7          | 7             | SH            |         | 100          |       |  |                           |                        |              |
|        | 34.7       |               |               |         |              |       |  |                           |                        |              |
|        | 54.6       |               |               |         |              |       |  |                           |                        |              |

2008 N-VALUE WITH BBCM.GDT 1.0.05

WATER LEVEL: 34.7  
WATER NOTE: Caved at 54.6'  
DATE: 8/4/08

Standard Penetration Test (SPT) Results  
 Under Comp. (Relative Density) Results  
 Under Comp. (Relative Density) Results  
 Under Comp. (Relative Density) Results  
 Under Comp. (Relative Density) Results

LOG OF BORING NO. B-6  
CLINCH RIVER POND #2 CLOSURE  
CARBO, VIRGINIA



DATE: 7/30/08 - 8/4/08

LOCATION: NAD 83 VA South Zone

COORDINATES: N 3522248.22; E 10405163.61

ELEVATION: 1566.7

DRILLING METHOD: 3-1/4" I.D. Hollow-stem Auger

COMPLETION DEPTH: 54.6'

SAMPLER(S): 2" O.D. Split-barrel Sampler, NQ Rock Core Barrel

| ELEV.  | DEPTH, FEET | SAMPLE NUMBER | SAMPLE     | REFORC. | N  | VALUE | SAMPLE REC. % | USCS  | DESCRIPTION  | NATURAL CONSISTENCY INDEX | NATURAL MOISTURE CONTENT | TEST RESULTS |
|--------|-------------|---------------|------------|---------|----|-------|---------------|-------|--|---------------------------|--------------------------|--------------|
| 1525.1 | 40          | 8             | SH         | SH      |    |       |               | ML-SM | FILL: Very-loose gray fly ash, contains zones of bottom ash, wet   |                           |                          |              |
| 1522.4 | 45          | 9             | 0          | 0       | 39 |       |               | ML-CL | Medium-stiff brown and gray clayey silt, "and" fine to coarse sand, some fine gravel, contains limestone fragments |                           |                          | H-10         |
| 1512.1 | 55          | 10            | NQ RQD 26% |         |    |       |               |       | Hard gray limestone, massive bedding, many diagonal (few near horizontal) fractures                                |                           |                          |              |
| 1512.1 | 55          | 11            | NQ RQD 64% |         |    |       |               |       |  |                           |                          |              |

- Blind drilled 3-1/4" augers; no grouting procedures in use on this boring
- Encountered auger refusal at 44 3'
- Drove 4" casing to 44 1' and started rock coring at 44 3'
- Borehole grouted upon completion

WATER LEVEL: 34.7  
WATER NOTE: Caved at 54.6'  
DATE: 8/4/08

SYMBOLS USED TO INDICATE TEST RESULTS  
 C - Consolidation Test  
 O - Open Core  
 T - Triaxial Comp  
 C - Consol.  
 S - Sieve  
 E - Expansion  
 W - Wet Dry Weight  
 G - Relative Density

2008 NAVAJUP WITH

11/19/08 GPO BBCM GDU 11/8-08

LOG OF BORING NO. B-7  
CLINCH RIVER POND #2 CLOSURE  
CARBO, VIRGINIA



DATE: 7/30/08 - 8/5/08

LOCATION: NAD 83 VA South Zone

COORDINATES: N 3522654.09; E 10405203.14

ELEVATION: 1578.3

DRILLING METHOD: 3-1/4" I.D. Hollow-stem Auger

COMPLETION DEPTH: 81.8'

SAMPLER(S): 2" O.D. Split-barrel Sampler

| ELEV.  | DEPTH FEET | SAMPLE NUMBER | SAMPLE EFFORT | N VALUE | SAMPLE REC. % | USCS   | DESCRIPTION   | NATURAL CONSISTENCY INDEX |              | TEST RESULT |
|--------|------------|---------------|---------------|---------|---------------|--|---|---------------------------|--------------|-------------|
|        |            |               |               |         |               |  |   | PLASTIC LIMIT             | LIQUID LIMIT |             |
|        | 0          | 10            | 37, 27        | 64      | 53            | GM   | FILL: Very-dense brown and gray fine to coarse gravel (limestone and chert fragments), little to some fine to coarse sand, little to some silt, dry |                           |              |             |
|        | 5          |               |               |         |               |  |   |                           |              |             |
|        | 10         | 2             | 10, 27, 24    | 71      | 53            |  |   |                           |              |             |
| 1566.7 | 15         | 3             | 26, 27, 21    | 48      | 100           | ML-SM  | FILL: Loose to dense gray fly ash, contains zones of bottom ash, moist  |                           |              |             |
|        | 20         | 4             | 8, 16, 16     | 52      | 100           |  |   |                           |              |             |
|        | 25         | 5             | 3, 4, 6       | 10      | 100           |  |   |                           |              |             |
|        | 30         | 6             | 11, 12, 19    | 21      | 100           |  |   |                           |              |             |
| 1566.7 | 35         | 7             | 2, 1, 0       | 87      | ML-SM         | FILL: Very-loose gray fly ash, contains zones of bottom ash, wet |   |                           |              |             |
|        |            |               |               |         |               |  |   |                           |              |             |

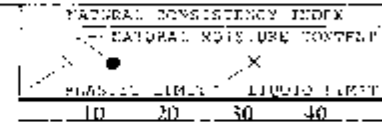

WATER LEVEL: 71.2  
WATER NOTE: Caved at 81.3'  
DATE: 8/5/08

SYMBOLS FOR SOIL PROPERTIES AND RESULTS  
 U - Gradation %  
 G - Union Corp. Apparatus  
 L - Liquid Limit  
 C - Consistency

2008 REVISED BY BBCM/LLJ/TJG/RS



LOG OF BORING NO. B-7  
CLINCH RIVER POND #2 CLOSURE  
CARBO, VIRGINIA



DATE: 7/30/08 - 8/5/08

LOCATION: NAD 83 VA South Zone

COORDINATES: N 3522654.09; E 10405203.14

ELEVATION: 1578.3

DRILLING METHOD: 3-1/4" I.D. Hollow-stem Auger

COMPLETION DEPTH: 81.8'

SAMPLER(S): 2" O.D. Split-barrel Sampler

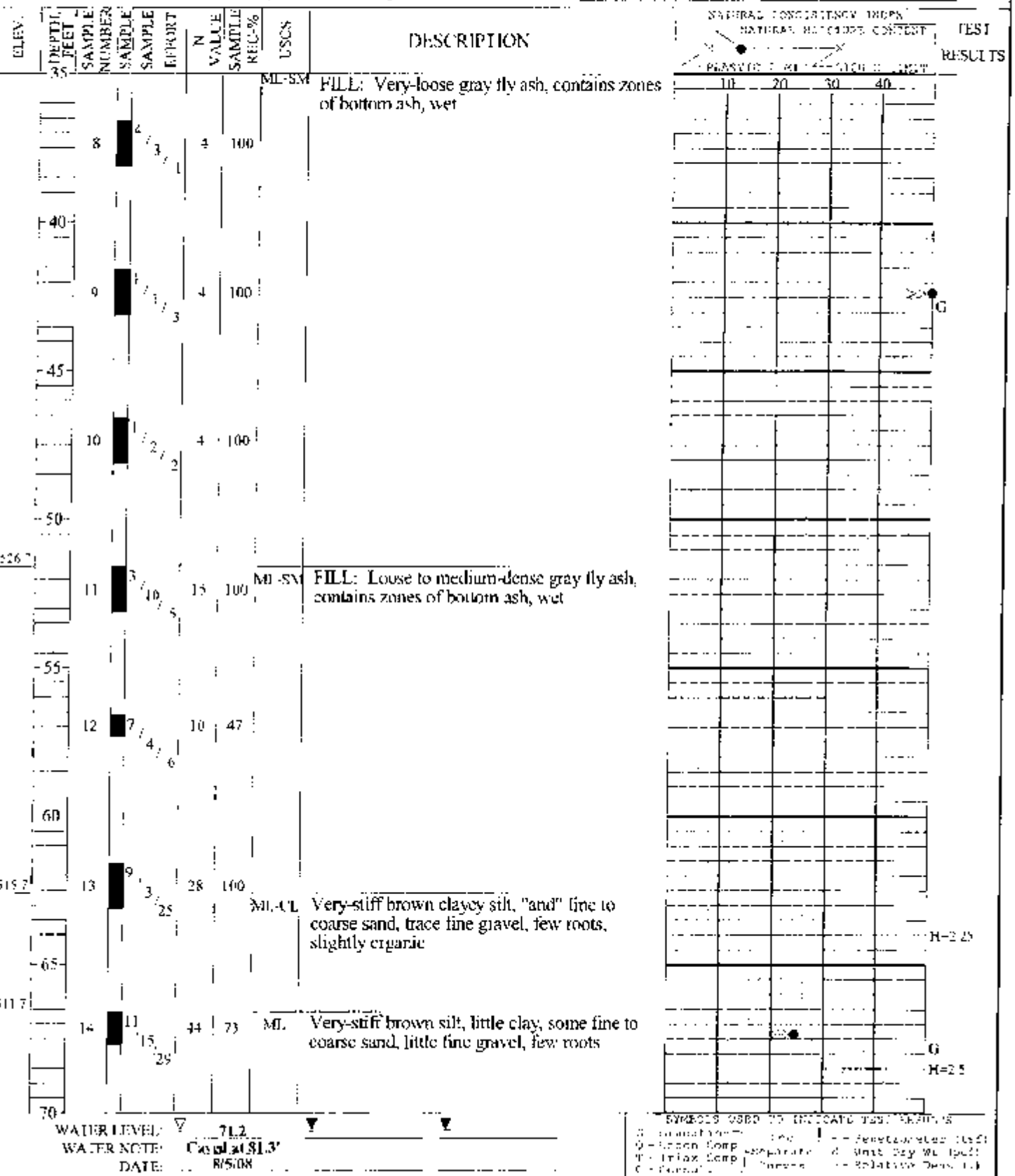

2008 N-VALUE WITH C  
1149700-G02 BNC-N-G01 11/6/08

**LOG OF BORING NO. B-7  
CLINCH RIVER POND #2 CLOSURE  
CARBO, VIRGINIA**



DATE: 7/30/08 - 8/5/08

LOCATION: NAD 83 VA South Zone

COORDINATES: N 3522654.09; E 10405201.14

ELEVATION 1578.3

DRILLING METHOD: 3-1/4" I.D. Hollow-stem Auger

COMPLETION DEPTH: 81.8'

SAMPLER(S): 2" O.D. Split-barrel Sampler

| ELEV<br>DEPTH<br>FEET | SAMPLE<br>NUMBER | SAMPLE<br>EFFECT | N<br>VALUE | SAMPLE<br>RUC-% | USCS | DESCRIPTION   | NATURAL CONSISTENCY INDEX |    |               |              | TEST<br>RESULTS |
|-----------------------|------------------|------------------|------------|-----------------|------|---|---------------------------|----|---------------|--------------|-----------------|
|                       |                  |                  |            |                 |      |   | NATURAL MOISTURE CONTENT  |    | PLASTIC LIMIT | LIQUID LIMIT |                 |
|                       |                  |                  |            |                 |      |   | 10                        | 20 | 30            | 40           |                 |
| 1506                  | 15               | 9<br>13<br>27    | 40         | 93              | CL   | Very-stiff brown silt, little clay, some fine to coarse sand, little fine gravel, few roots   |                           |    |               |              |                 |
| 1507                  | 16               | 11<br>25<br>40   | 65         | 100             | GM   | Very-dense brown and gray fine to coarse gravel (limestone fragments), some fine to coarse sand, some silt, little clay   |                           |    |               |              | H-45            |
| 1496.7<br>(376.7)     | 17               | 50-2"R           |            | 13              |      | Soft to medium-hard gray shale.   |                           |    |               |              |                 |
| 85                    |                  |                  |            |                 |      | <ul style="list-style-type: none"> <li>- Boring logged by ABP personnel</li> <li>- Blind drilled 3-1/4" augers; no grouting procedure used on this boring</li> <li>- Fill and fly ash interface between 8'-11' 6"</li> <li>- Encountered auger refusal at 83' 4"</li> <li>- Borehole grouted upon completion</li> </ul> |                           |    |               |              |                 |
| 90                    |                  |                  |            |                 |      |   |                           |    |               |              |                 |
| 95                    |                  |                  |            |                 |      |   |                           |    |               |              |                 |
| 100                   |                  |                  |            |                 |      |   |                           |    |               |              |                 |
| 105                   |                  |                  |            |                 |      |   |                           |    |               |              |                 |

WATER LEVEL: 71.2  
 WATER NOTE: Caved at 81.3'  
 DATE: 8/5/08

SYMBOLS USED TO INDICATE TEST RESULTS  
 G - Graduated Gyr. Jar      A - Proctor Test (ASTM)  
 Q - Jenson Comp. Apparatus      R - Comp. Test (ASTM)  
 T - Triax. Comp. Pressure      S - Comp. Test (ASTM)  
 C - Comp.      D - Relative Comp. (%)

US EPA ARCHIVE DOCUMENT

2008 N VALLEY WATER LOGS FOR CFB BOREHOLE B-7

**LOG OF BORING NO. B-8  
CLINCH RIVER POND #2 CLOSURE  
CARBO, VIRGINIA**



DATE: 7/29/08

LOCATION: NAD 83 VA South Zone

COORDINATES: N 3523040.68; E 10405041.75

ELEVATION: 1556.4

DRILLING METHOD: 3-1/4" I.D. Hollow-stem Auger

COMPLETION DEPTH: 23.2'

SAMPLER(S): 2" O.D. Split-barrel Sampler

| CURV | DEPTH<br>Feet | SAMPLE<br>NUMBER | SAMPLE<br>DEPTH | EFFORT | N<br>VALUE | SAMPLE<br>REC-% | USCS  | DESCRIPTION  | NATURAL CONSISTENCY INDEX |              | TEST<br>RESULTS |
|------|---------------|------------------|-----------------|--------|------------|-----------------|-------|--|---------------------------|--------------|-----------------|
|      |               |                  |                 |        |            |                 |       |  | NATURAL MOISTURE          | LIQUID LIMIT |                 |
|      |               |                  |                 |        |            |                 | ML-SM | FILL: Very-loose to medium-dense gray fly ash, contains zones of bottom ash, dry |                           |              |                 |
|      | 1             | 8                | 6/12            |        | 18         | 100             |       |  |                           |              |                 |
|      | 2             | 2                | 1/5             |        | 4          | 93              |       |  |                           |              | G               |
|      | 3             | 4                | 4/4             |        | 8          | 100             |       |  |                           |              |                 |
|      | 4             | 3                | 3/3             |        | 6          | 100             | ML-SM | FILL: Loose gray fly ash, contains zones of bottom ash, wet                      |                           |              | G               |
|      | 5             | 3                | 2/3             |        | 10         | 60              |       |  |                           |              |                 |
|      | 6             |                  |                 |        |            |                 |       |  |                           |              |                 |
|      | 7             |                  |                 |        |            |                 |       |  |                           |              |                 |
|      | 8             |                  |                 |        |            |                 |       |  |                           |              |                 |
|      | 9             |                  |                 |        |            |                 |       |  |                           |              |                 |
|      | 10            |                  |                 |        |            |                 |       |  |                           |              |                 |
|      | 11            |                  |                 |        |            |                 |       |  |                           |              |                 |
|      | 12            |                  |                 |        |            |                 |       |  |                           |              |                 |
|      | 13            |                  |                 |        |            |                 |       |  |                           |              |                 |
|      | 14            |                  |                 |        |            |                 |       |  |                           |              |                 |
|      | 15            |                  |                 |        |            |                 |       |  |                           |              |                 |
|      | 16            |                  |                 |        |            |                 |       |  |                           |              |                 |
|      | 17            |                  |                 |        |            |                 |       |  |                           |              |                 |
|      | 18            |                  |                 |        |            |                 |       |  |                           |              |                 |
|      | 19            |                  |                 |        |            |                 |       |  |                           |              |                 |
|      | 20            |                  |                 |        |            |                 |       |  |                           |              |                 |
|      | 21            |                  |                 |        |            |                 |       |  |                           |              |                 |
|      | 22            |                  |                 |        |            |                 |       |  |                           |              |                 |
|      | 23            |                  |                 |        |            |                 |       |  |                           |              |                 |
|      | 24            |                  |                 |        |            |                 |       |  |                           |              |                 |
|      | 25            |                  |                 |        |            |                 |       |  |                           |              |                 |
|      | 26            |                  |                 |        |            |                 |       |  |                           |              |                 |
|      | 27            |                  |                 |        |            |                 |       |  |                           |              |                 |
|      | 28            |                  |                 |        |            |                 |       |  |                           |              |                 |
|      | 29            |                  |                 |        |            |                 |       |  |                           |              |                 |
|      | 30            |                  |                 |        |            |                 |       |  |                           |              |                 |
|      | 31            |                  |                 |        |            |                 |       |  |                           |              |                 |
|      | 32            |                  |                 |        |            |                 |       |  |                           |              |                 |
|      | 33            |                  |                 |        |            |                 |       |  |                           |              |                 |
|      | 34            |                  |                 |        |            |                 |       |  |                           |              |                 |
|      | 35            |                  |                 |        |            |                 |       |  |                           |              |                 |

- Blind drilled 3-1/4" auger; no grouting procedures on this boring  
 - Sounding 23.6'; SWL 0.0'  
 - Borehole grouted upon completion.

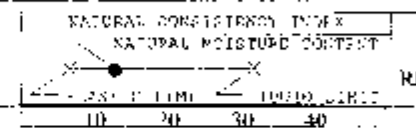

WATER LEVEL:                       
 WATER NOTE:                       
 DATE:                     

**SYMBOLS USED TO INDICATE TEST RESULTS**  
 G - Gradation  
 U - Unconf. Comp. (Unsat.)  
 P - Plastic Comp. (Unsat.)  
 S - Shrinkage Swell  
 R - Relative Density  
 W - Wet/Dry wt. (part)  
 D - Density (part)



SUMMARY OF LABORATORY TEST RESULTS

| BORING | APPRO. DEPTH | MC |    |    | LL |    |    | PL |    |    | PJ |    |    | GRADATION | HYDROMETER | COMPACTION | TRIAxIAL | DIRECT SHEAR | UNCONSOLIDATED | GRAVIMETRIC | UNITARY | PCF | REMOVED | PERMEABILITY | RELATIVE | L O : | SHELLY | ROCK CORE |
|--------|--------------|----|----|----|----|----|----|----|----|----|----|----|----|-----------|------------|------------|----------|--------------|----------------|-------------|---------|-----|---------|--------------|----------|-------|--------|-----------|
|        |              | %  | 20 | NP | %  | NP | NP | %  | NP | NP | %  | NP | NP |           |            |            |          |              |                |             |         |     |         |              |          |       |        |           |
| B-1    | 7.55         |    |    |    |    |    |    |    |    |    |    |    | *  |           |            |            |          |              |                |             |         |     |         |              |          |       |        |           |
| B-1    | 22.55        | 55 |    |    |    |    |    |    |    |    |    |    | *  |           |            |            |          |              |                |             |         |     |         |              |          |       |        |           |
| B-2    | 27.65        | 66 |    |    |    |    |    |    |    |    |    |    | *  |           |            |            |          |              |                |             |         |     |         |              |          |       |        |           |
| B-2    | 47.65        | 83 |    |    |    |    |    |    |    |    |    |    | *  |           |            |            |          |              |                |             |         |     |         |              |          |       |        |           |
| B-3    | 2.35         | 7  | 19 | 15 | 4  |    |    |    |    |    |    |    |    |           |            |            |          |              |                |             |         |     |         |              |          |       |        |           |
| B-3    | 9.85         | 5  | 19 | 12 | 7  |    |    |    |    |    |    |    |    |           |            |            |          |              |                |             |         |     |         |              |          |       |        |           |
| B-3    | 17.35        | 6  | 26 | 18 | 8  |    |    |    |    |    |    |    | *  |           |            |            |          |              |                |             |         |     |         |              |          |       |        |           |
| B-3    | 27.35        | 22 | 25 | 17 | 8  |    |    |    |    |    |    |    |    |           |            |            |          |              |                |             |         |     |         |              |          |       |        |           |
| B-3    | 28.80        |    |    |    |    |    |    |    |    |    |    |    |    |           |            |            |          |              |                |             |         |     |         |              |          |       |        |           |
| B-3    | 34.85        | 24 | 34 | 21 | 13 |    |    |    |    |    |    |    |    |           |            |            |          |              |                |             |         |     |         |              |          |       |        |           |
| B-3    | 37.50        | 26 | 24 | 18 | 6  |    |    |    |    |    |    |    | *  |           |            |            |          |              |                |             |         |     |         |              |          |       |        |           |
| B-3    | 39.95        |    |    |    |    |    |    |    |    |    |    |    | *  |           |            |            |          |              |                |             |         |     |         |              |          |       |        |           |
| B-4    | 2.45         | 7  | 27 | 17 | 10 |    |    |    |    |    |    |    |    |           |            |            |          |              |                |             |         |     |         |              |          |       |        |           |
| B-4    | 7.45         | 7  | 20 | 14 | 6  |    |    |    |    |    |    |    |    |           |            |            |          |              |                |             |         |     |         |              |          |       |        |           |
| B-4    | 12.45        | 7  |    |    |    |    |    |    |    |    |    |    |    |           |            |            |          |              |                |             |         |     |         |              |          |       |        |           |
| B-4    | 19.95        | 11 | 29 | 17 | 12 |    |    |    |    |    |    |    | *  |           |            |            |          |              |                |             |         |     |         |              |          |       |        |           |
| B-4    | 29.25        |    |    |    |    |    |    |    |    |    |    |    | *  |           |            |            |          |              |                |             |         |     |         |              |          |       |        |           |
| B-4    | 42.45        | 64 |    |    |    |    |    |    |    |    |    |    | *  |           |            |            |          |              |                |             |         |     |         |              |          |       |        |           |
| B-4    | 54.95        |    |    |    |    |    |    |    |    |    |    |    | *  |           |            |            |          |              |                |             |         |     |         |              |          |       |        |           |
| B-4    | 64.60        | 24 | NP | NP | NP |    |    |    |    |    |    |    | *  |           |            |            |          |              |                |             |         |     |         |              |          |       |        |           |

\* SEE INDIVIDUAL TEST CURVES

PROJECT CLINCH RIVER POND #2 CLOSURE  
 LOCATION CARBO, VIRGINIA  
 JOB NO. 011-11497-007 DATE 11/8/08

TESTING SUMMARY - STANDARD



SUMMARY OF LABORATORY TEST RESULTS

| BORING APPRO. DEPTH | MC    | LL | PL | PI | GRADATION | Hydrometer | COMPACTION | TRIAXIAL | DIRECT SHEAR | UNCONSOLIDATED | CONSOLIDATED | GRAVITY | SPLITS | UNIT WEIGHT | PCF | BOLD | PERMEABILITY | RELATIVE DENSITY | LOI | LOI OF | SHEAR TIME | ROCK CORE LOG |
|---------------------|-------|----|----|----|-----------|------------|------------|----------|--------------|----------------|--------------|---------|--------|-------------|-----|------|--------------|------------------|-----|--------|------------|---------------|
|                     |       |    |    |    |           |            |            |          |              |                |              |         |        |             |     |      |              |                  |     |        |            |               |
| B-5                 | 12.45 | 46 | NP | NP | *         | *          |            |          |              |                |              |         |        |             |     |      |              |                  |     |        |            |               |
| B-5                 | 22.45 | 58 | NP | NP | *         | *          |            |          |              |                |              |         |        |             |     |      |              |                  |     |        |            |               |
| B-5                 | 47.45 | 55 |    |    | *         | *          |            |          |              |                |              |         |        |             |     |      |              |                  |     |        |            |               |
| B-6                 | 1.75  |    |    |    |           |            |            |          |              |                |              |         |        |             |     |      |              |                  |     |        |            |               |
| B-6                 | 5.25  |    |    |    |           |            |            |          |              |                |              |         |        |             |     |      |              |                  |     |        |            |               |
| B-6                 | 9.25  |    |    |    |           |            |            |          |              |                |              |         |        |             |     |      |              |                  |     |        |            |               |
| B-6                 | 12.35 | 56 |    |    | *         | *          |            |          |              |                |              |         |        |             |     |      |              |                  |     |        |            |               |
| B-6                 | 27.35 | 53 | NP | NP | *         | *          |            |          |              |                |              |         |        |             |     |      |              |                  |     |        |            |               |
| B-7                 | 1.75  |    |    |    |           |            |            |          |              |                |              |         |        |             |     |      |              |                  |     |        |            |               |
| B-7                 | 5.25  |    |    |    |           |            |            |          |              |                |              |         |        |             |     |      |              |                  |     |        |            |               |
| B-7                 | 9.25  |    |    |    |           |            |            |          |              |                |              |         |        |             |     |      |              |                  |     |        |            |               |
| B-7                 | 42.35 | 59 |    |    | *         | *          |            |          |              |                |              |         |        |             |     |      |              |                  |     |        |            |               |
| B-7                 | 67.35 | 25 | 23 | 21 | 2         | *          | *          |          |              |                |              |         |        |             |     |      |              |                  |     |        |            |               |
| B-7                 | 77.35 | 13 | 19 | 16 | 3         |            |            |          |              |                |              |         |        |             |     |      |              |                  |     |        |            |               |
| B-8                 | 7.45  | 22 |    |    | *         | *          |            |          |              |                |              |         |        |             |     |      |              |                  |     |        |            |               |
| B-8                 | 17.45 | 66 |    |    | *         | *          |            |          |              |                |              |         |        |             |     |      |              |                  |     |        |            |               |

TESTING SUMMARY - STANDARD PROJECT CLINCH RIVER POND #2 CLOSURE LOCATION CARBO, VIRGINIA JOB NO. 011-11497-007 DATE 11/6/08

# ATTERBERG LIMITS' RESULTS

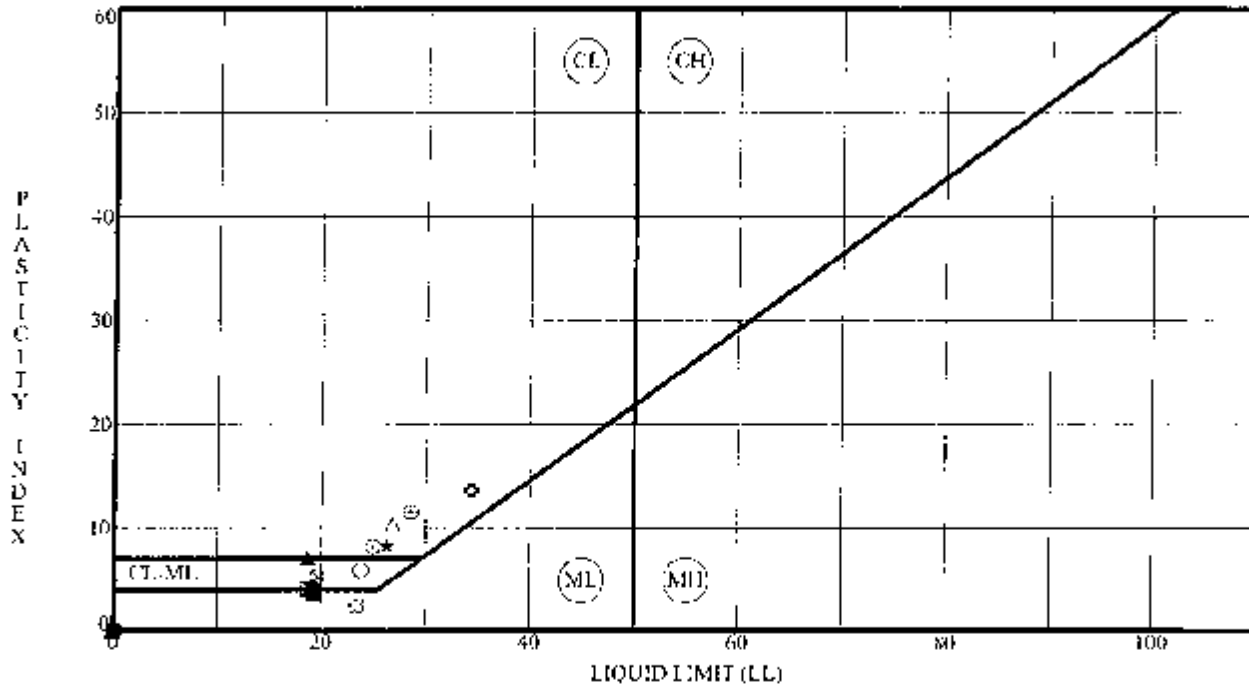

| Specimen Id. | Depth | MC | LL | PL | PI | Fines | ASTM Classification        |
|--------------|-------|----|----|----|----|-------|----------------------------|
| ● B-1        | 7.55  | 20 | NP | NP | NP | 57.2  | SANDY SILTY ML             |
| ☒ B-3        | 2.35  | 7  | 19 | 15 | 4  |       |                            |
| ▲ B-3        | 9.85  | 5  | 19 | 12 | 7  |       |                            |
| ★ B-3        | 17.35 | 6  | 26 | 18 | 8  | 31.0  | CLAYEY SAND with GRAVEL SC |
| ⊙ B-3        | 27.35 | 22 | 25 | 17 | 8  |       |                            |
| ⊙ B-3        | 34.85 | 24 | 34 | 21 | 13 |       |                            |
| ○ B-3        | 37.50 | 26 | 24 | 18 | 6  | 57.4  | SANDY SILTY CLAY CL-ML     |
| △ B-4        | 2.45  | 7  | 27 | 17 | 10 | 29.2  | CLAYEY SAND with GRAVEL SC |
| ⊙ B-4        | 7.45  | 7  | 20 | 14 | 6  |       |                            |
| ⊙ B-4        | 19.95 | 11 | 29 | 17 | 12 | 38.5  | CLAYEY SAND with GRAVEL SC |
| ○ B-4        | 64.60 | 24 | NP | NP | NP | 26.2  | SILTY SAND SM              |
| ⊙ B-5        | 12.45 | 46 | NP | NP | NP | 70.5  | SILT with SAND ML          |
| ⊙ B-5        | 22.45 | 58 | NP | NP | NP | 77.0  | SILT with SAND ML          |
| ★ B-6        | 27.35 | 53 | NP | NP | NP | 98.2  | SILT ML                    |
| ⊙ B-7        | 67.35 | 25 | 23 | 21 | 2  | 61.3  | SANDY SILT ML              |
| ■ B-7        | 77.35 | 13 | 19 | 16 | 3  |       |                            |

PROJECT CLINCH RIVER POND #2 CLOSURE  
 LOCATION CARBO, VIRGINIA  
 JOB NO. 011-11497-007 DATE 11/6/08

US EPA ARCHIVE DOCUMENT

ALP:REG-11497007.PDF BBCM.GDI 11/6/08

JC NUMBER : 011-11497-007

PROJECT : CLINCH RIVER POND #2 CLOSURE  
 LOCATION : CARBO, VIRGINIA



LABORATORY LOG OF SHELBY TUBES

| Boring | Sample         | 12       | Boring | Sample | Boring | Sample   |
|--------|----------------|----------|--------|--------|--------|----------|
| Depth  | 28.1' to 29.3' | Recovery | 15.00" | Depth  | Depth  | Recovery |
| 0      | VOID           |          |        | 0      |        |          |
| 12     |                |          |        | 12     |        |          |
| I      |                |          |        | 24     |        |          |
| II     |                |          |        | 36     |        |          |
| III    |                |          |        |        |        |          |
| 36     |                |          |        |        |        |          |

30.00' tub

FILL: Brown fine to coarse gravel and silty clay, little fine to coarse sand.

**LEGEND**

- Consolidation, Incremental
- Consolidation, CRS
- Permeability, Vertical / Horizontal
- Swelling, Test
- Unconfined Compression Test
- Triaxial Compression Test
- Hand Penetrometer (tsf)
- Direct Shear
- Loss on Ignition
- Atterberg Limits
- Sieve/Hydrometer
- Specific Gravity
- Shrinkage Limit
- Porosity
- Unit Dry Weight
- Moisture Content
- Relative Density
- Sieve

REVISIONS: 11497-007-001 11/89

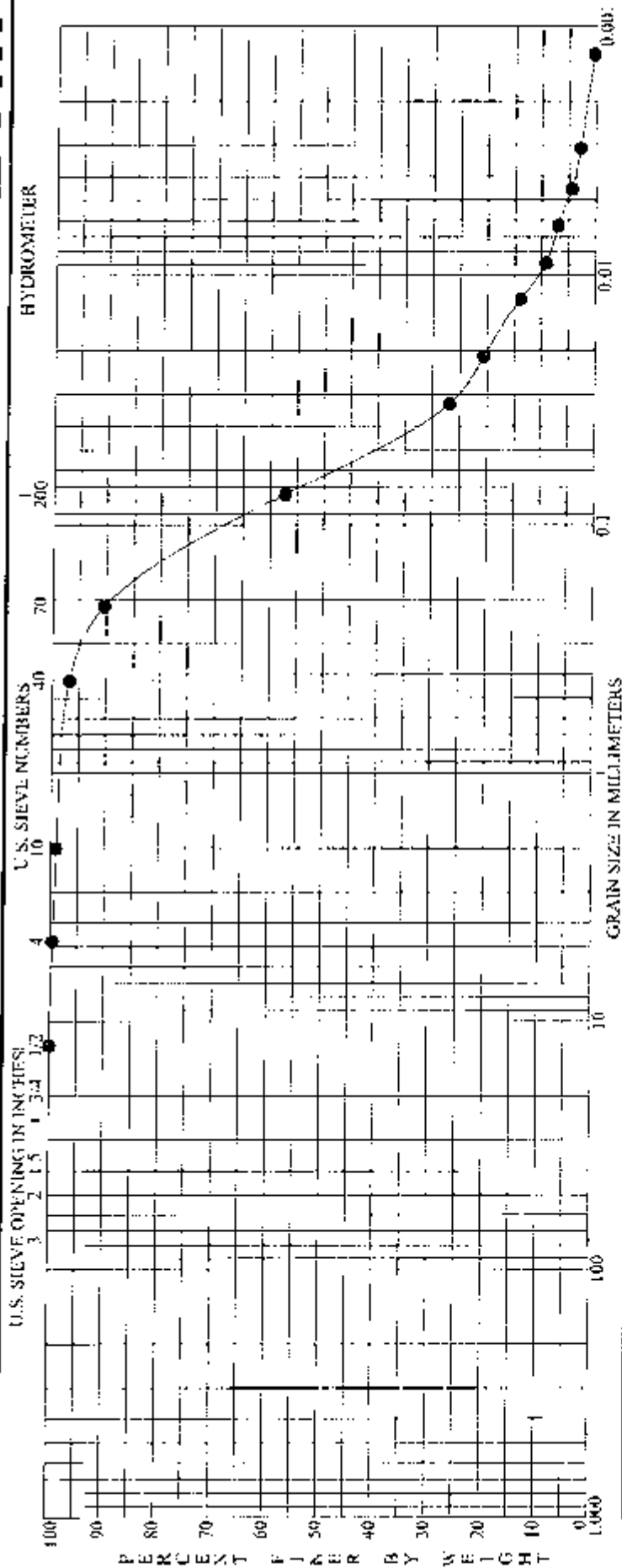

| BOULDERS                        |  | GRAVEL |        |        |     | SAND |       |        |  | SILT OR CLAY |  |        |  |      |  |  |
|---------------------------------|--|--------|--------|--------|-----|------|-------|--------|--|--------------|--|--------|--|------|--|--|
| COARSE                          |  | FINE   |        | MEDIUM |     | FINE |       | MEDIUM |  | FINE         |  | MEDIUM |  | FINE |  |  |
| Specimen Identification - Depth | MC%  | LL     | PL     | PI     | opt | mc   | % max | % per  |  |              |  |        |  |      |  |  |
| R-1 S-2 6.8' to 8.3'            | 20   | NP     | NP     | NP     | NP  | NP   | NP    | NP     |  |              |  |        |  |      |  |  |
| Classification:                 | FLYASH Gray and brown silt, trace clay, "and" fine sand, trace medium to coarse sand, trace fine gravel. |        |        |        |     |      |       |        |  |              |  |        |  |      |  |  |
| Specimen Identification - Depth | D100   | D360   | D30    | D10    |     |      |       |        |  |              |  |        |  |      |  |  |
| B-1 S-2 6.8' to 8.3'            | 12.5000  | 0.0819 | 0.0355 | 0.0094 | 0.4 | 42.4 | 51.9  | 5.3    |  |              |  |        |  |      |  |  |

ASTM D422  
 GRADATION CURVE  
 PROJECT CLINCH RIVER POND #2 CLOSURE  
 LOCATION CARBO, VIRGINIA  
 JOB NO. 011-11497-007  
 DATE 11/6/08



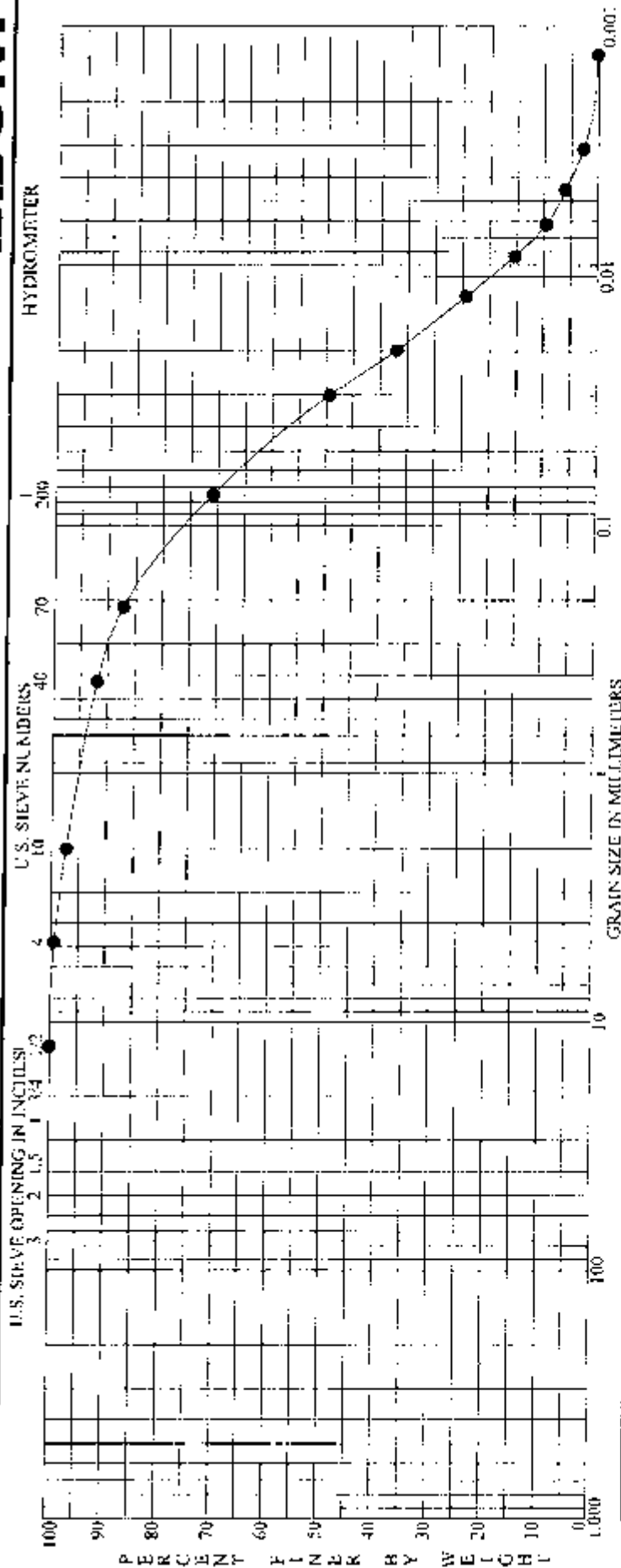

| BOULDERS  | COBBLES | GRAVEL  |        |                | SAND   |        |      | SILT OR CLAY |       |       |       |          |
|---|---------|---------|--------|----------------|--------|--------|------|--------------|-------|-------|-------|----------|
|   |         | coarse  | fine   | Classification | coarse | medium | fine | MC%          | LL    | PL    | PI    | opt me % |
| Specimen Identification - Depth<br>● B-1 S-5 21.8' to 23.3' FLYASH Gray silt, trace clay, some fine sand, trace medium to coarse sand, trace fine gravel. |         |         |        |                |        |        |      |              |       |       |       |          |
| Specimen Identification - Depth<br>● B-1 S-5 21.8' to 23.3'   |         |         |        |                |        |        |      |              |       |       |       |          |
|   |         | D100    | D60    | D30            | D10    |        |      | %Gravel      | %Sand | %Silt | %Clay |          |
|   |         | 12.5000 | 0.0470 | 0.0150         | 0.0063 |        |      | 0.6          | 28.5  | 63.6  | 7.3   |          |

**ASTM D422** GRADATION CURVE  
 PROJECT CLINCH RIVER POND #2 CLOSURE  
 LOCATION CARBO, VIRGINIA  
 JOB NO. 011-11497-007 DATE 11/6/08

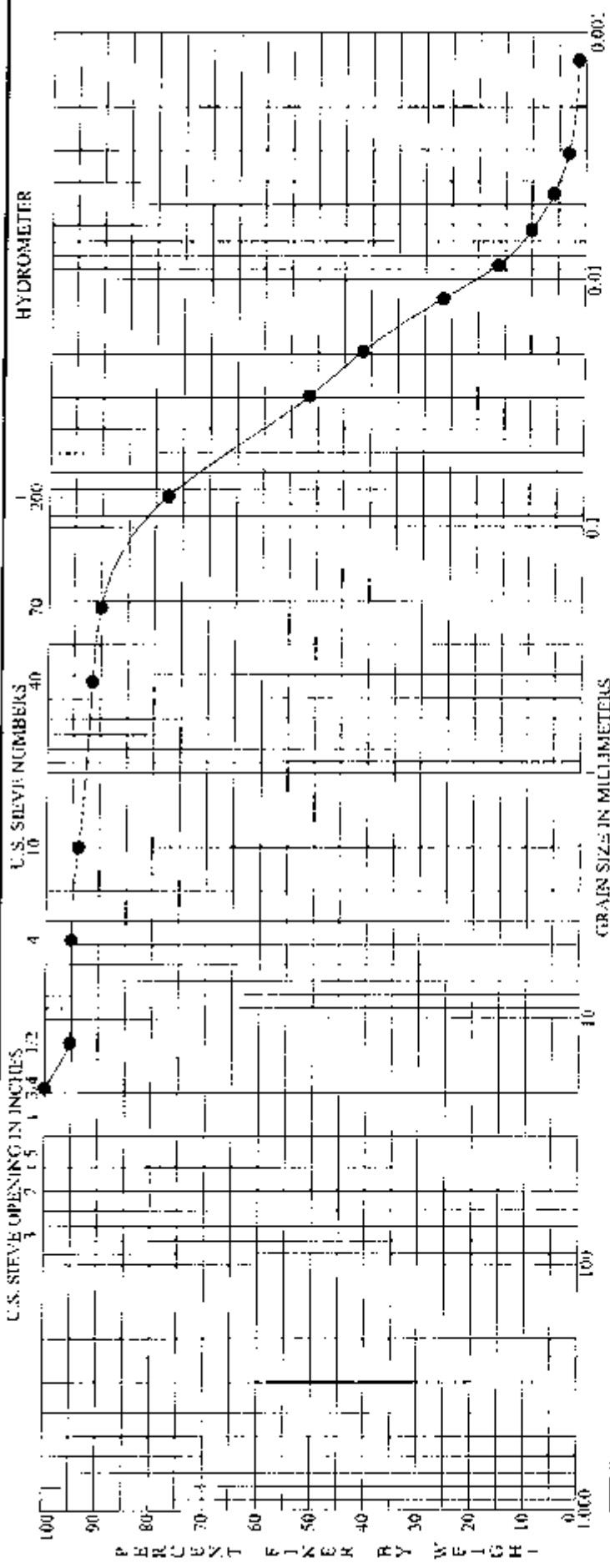

| BOULDERS                             | COBBLES |                | GRAVEL  |         | SAND   |        | SILT OR CLAY |          |
|--------------------------------------|---------|----------------|---|---------|--------|--------|--------------|----------|
|                                      | coarse  | fine           | coarse  | fine    | coarse | fine   | PI           | opt mc % |
| Specimen Identification - Depth      |         |                |   |         |        |        |              |          |
| ● B-2                                | S-6     | 26.9' to 28.4' | FLYASH Gray, dark gray and graybrown silt, trace clay, little fine to coarse sand, trace fine gravel. |         | MC%    | 66     |              |          |
| Specimen Identification - Depth      |         |                |   |         |        |        |              |          |
| ● B-2                                | S-6     | 26.9' to 28.4' | D100  | 19.0000 | D60    | 0.0397 | D30          | 0.0133   |
|                                      |         |                | D110  | 0.0062  | D30    | 0.0062 | %Gravel      | 4.9      |
|                                      |         |                |   |         |        |        | %Sand        | 17.4     |
|                                      |         |                |   |         |        |        | %Silt        | 70.4     |
|                                      |         |                |   |         |        |        | %Clay        | 7.3      |
| PROJECT CLINCH RIVER POND #2 CLOSURE |         |                |   |         |        |        |              |          |
| LOCATION CARBO, VIRGINIA             |         |                |   |         |        |        |              |          |
| JOB NO. 011-11497-007                |         |                |   |         |        |        |              |          |
| DATE 11/6/08                         |         |                |   |         |        |        |              |          |

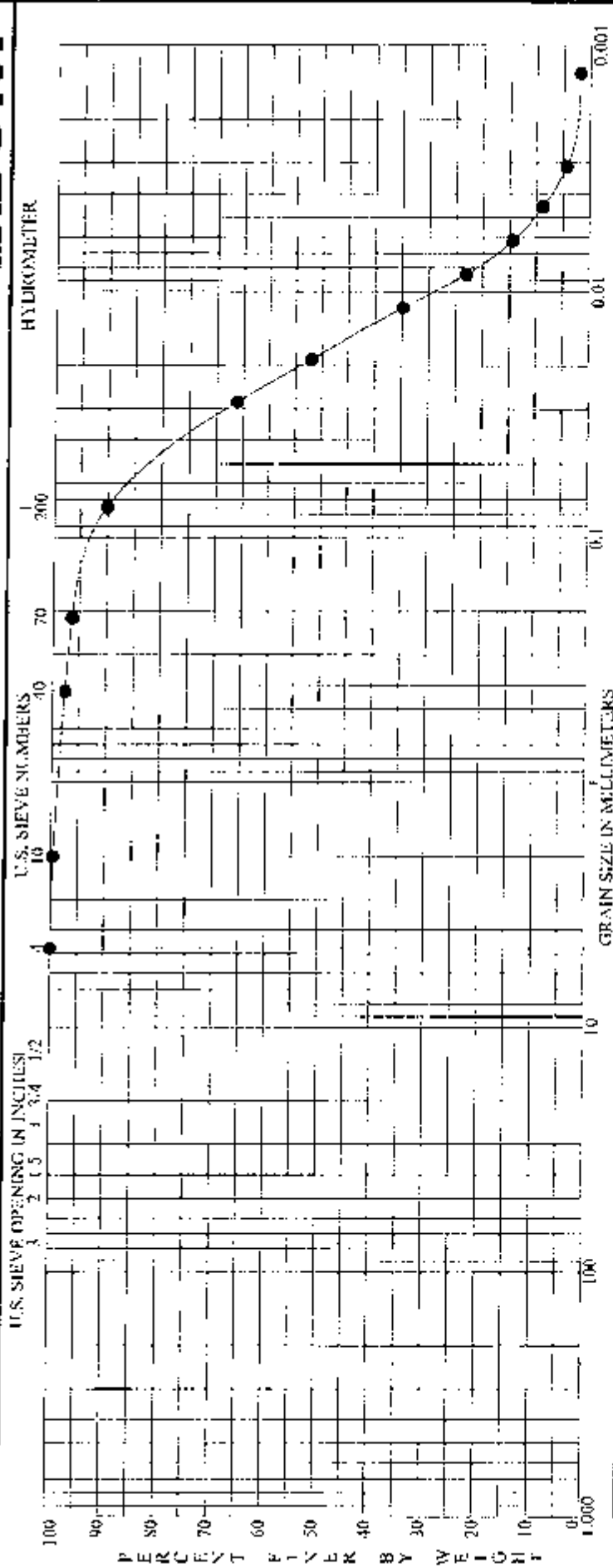

| BOULDERS                        | CORBLES |                | GRAVEL  |        |      | SAND   |        |        | SILT OR CLAY |        |         |     |            |         |       |      |       |      |
|---------------------------------|---------|----------------|---|--------|------|--------|--------|--------|--------------|--------|---------|-----|------------|---------|-------|------|-------|------|
|                                 | coarse  | fine           | coarse  | medium | fine | coarse | medium | fine   | MC%          | LL     | PL      | Pf  | opt line % | max pec |       |      |       |      |
| Specimen Identification - Depth |         |                |   |        |      |        |        |        |              |        |         |     |            |         |       |      |       |      |
| ● B-2                           | S-10    | 46.9' to 48.4' | FLYASH Gray silt, little clay, trace fine to coarse sand. |        |      |        |        |        |              |        |         |     |            |         |       |      |       |      |
| Specimen Identification - Depth |         |                |   |        |      |        |        |        |              |        |         |     |            |         |       |      |       |      |
| ● B-2                           | S-10    | 46.9' to 48.4' | D100  | 4.7500 | D60  | 0.0235 | D30    | 0.0102 | D10          | 0.0048 | %Gravel | 0.0 | %Sand      | 9.9     | %Silt | 79.5 | %Clay | 10.6 |

**ASTM D422**    **GRADATION CURVE**    PROJECT \_\_\_\_\_ CLINCH RIVER POND #2 CLOSURE  
 LOCATION \_\_\_\_\_ CARBO, VIRGINIA  
 JOB NO. \_\_\_\_\_ DATE 11/6/08  
 011-11497-007

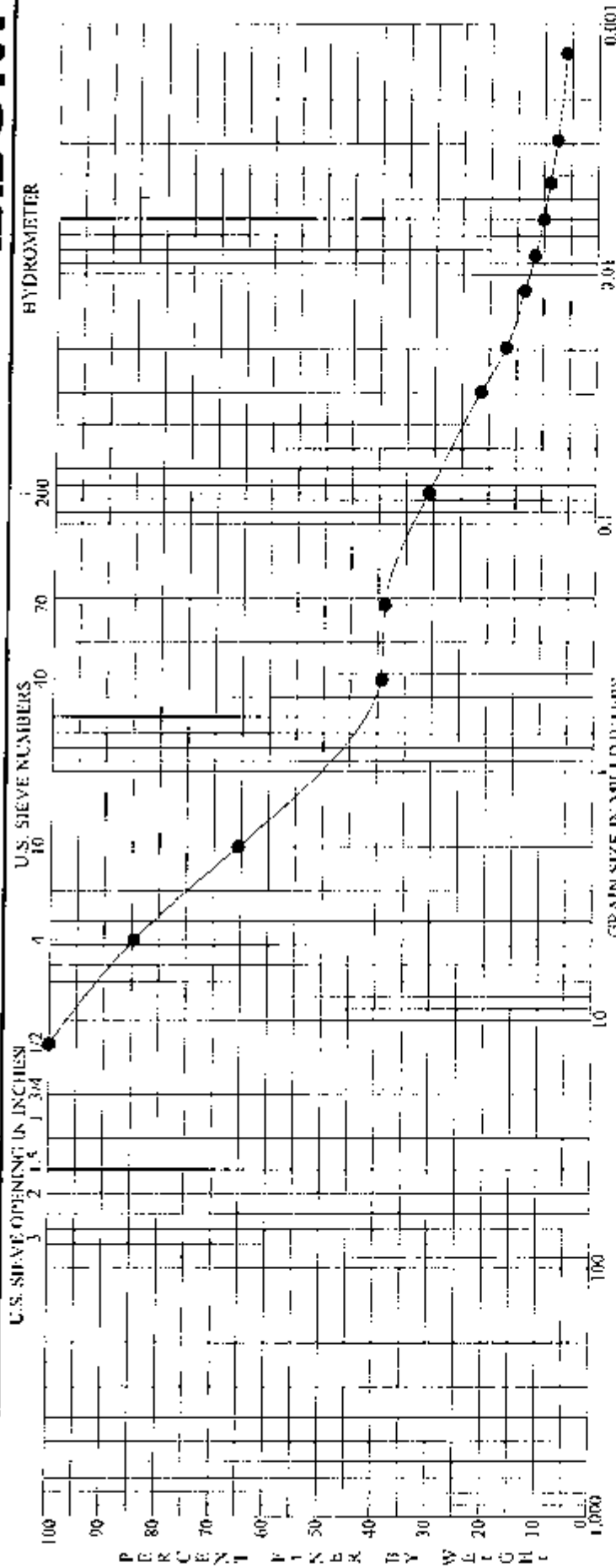

| BOULDERS                        | CORRIERS   |        | GRAVEL |        |      | SAND    |       |       | SILT OR CLAY |          |         |
|---------------------------------|--|--------|--------|--------|------|---------|-------|-------|--------------|----------|---------|
|                                 | coarse   | fine   | coarse | medium | fine | MC%     | LL    | PL    | PJ           | opt me % | max pct |
| Specimen Identification - Depth |  |        |        |        |      |         |       |       |              |          |         |
| ● B-3 S-7 16.6' to 17.9'        | FLYASH Gray fine to coarse sand, little fine gravel (shale fragments), little clayey silt. |        |        |        |      |         |       |       |              |          |         |
| Specimen Identification - Depth |  |        |        |        |      |         |       |       |              |          |         |
| ● B-3 S-7 16.6' to 17.9'        | D100   | D60    | D30    | D10    |      | %Gravel | %Sand | %Silt | %Clay        |          |         |
|                                 | 12.5000  | 1.4413 | 0.0683 | 0.0058 |      | 15.5    | 53.6  | 21.5  | 9.5          |          |         |

ASTM D422 GRADATION CURVE PROJECT CLINCH RIVER POND #2 CLOSURE  
 LOCATION CARBO, VIRGINIA  
 JOB NO. 011-11497-007 DATE 11/6/08

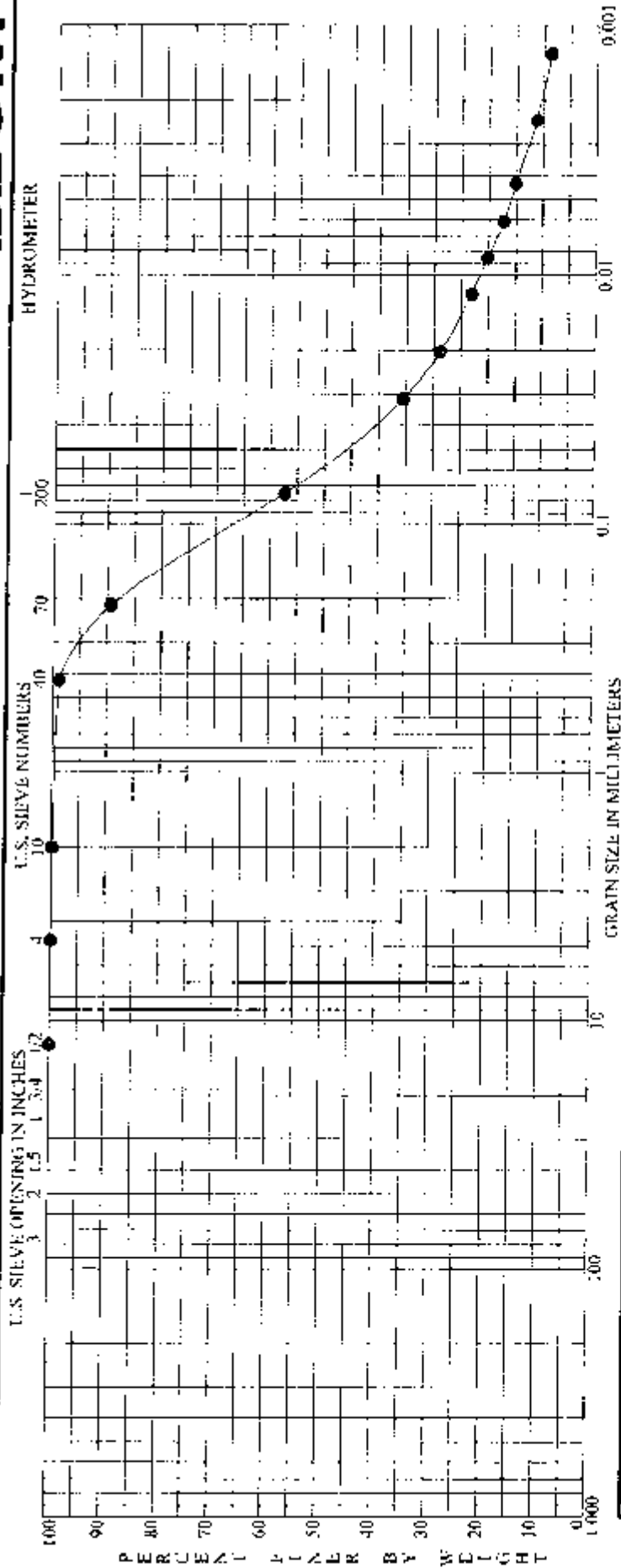

| BOULDERS  | COBBLES | GRAVEL | SAND    | SILT OR CLAY      |
|---|---------|--------|---------|-------------------|
| coarse  | fine    | coarse | medium  | fine              |
| Classification  |         |        |         |                   |
| MC%   | LL      | PL     | PI      | opt. mc % max pel |
| 26  | 24      | 18     | 6       | 6                 |
| Specimen Identification - Depth   |         |        |         |                   |
| ● B-3 S-15b 36.9' to 37.4' FLYASH Gray sly clay, "and" fine sand, trace medium to coarse sand, trace fine gravel. |         |        |         |                   |
| Specimen Identification - Depth   |         |        |         |                   |
| D100  | D60     | D30    | D10     | %Clay             |
| 12.5000   | 0.0817  | 0.0219 | 0.0018  | 16.0              |
|   |         |        | %Gravel | %Silt             |
|   |         |        | 0.1     | 41.3              |
|   |         |        | %Sand   |                   |
|   |         |        | 42.6    |                   |

ASTM D422 GRADATION CURVE LOCATION \_\_\_\_\_ DATE 11/6/08

PROJECT CLINCH RIVER POND #2 CLOSURE

JOB NO. 011-11497-007 CARBO, VIRGINIA

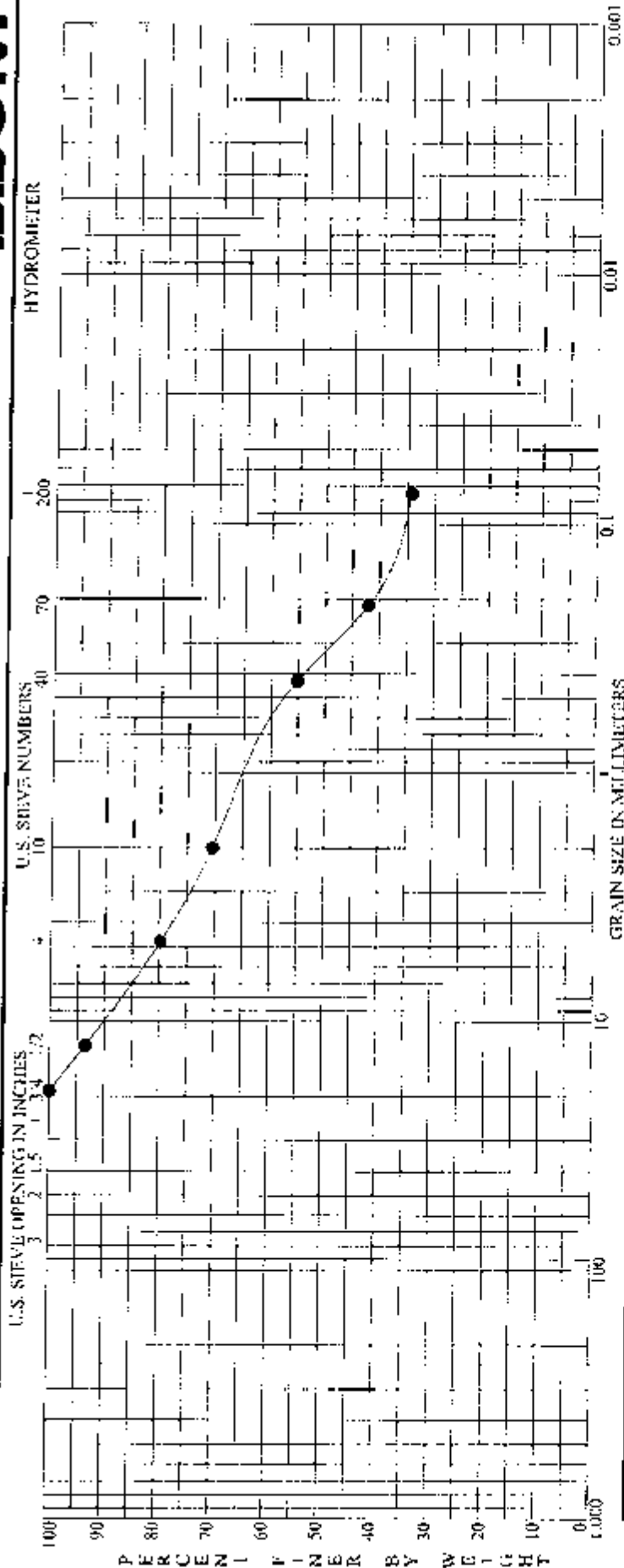

| BOULDERS                        | COBBLES | GRAVEL |          |   | SAND   |        |      | SILT OR CLAY |       |       |       |           |
|---------------------------------|---------|--------|----------|---|--------|--------|------|--------------|-------|-------|-------|-----------|
|                                 |         | coarse | fine     | Classification  | coarse | medium | fine | MC%          | LL    | PL    | PI    | opt. mc % |
| Specimen Identification - Depth |         |        |          |   |        |        |      |              |       |       |       |           |
| ● B-3                           | S-16h   | 36.9'  | to 37.4' | FLYASH Brown and gray fine to coarse sand, little fine gravel (shale fragments), some silt. |        |        |      |              |       |       |       |           |
| Specimen Identification - Depth |         |        |          |   |        |        |      |              |       |       |       |           |
| ● B-3                           | S-16h   | 36.9'  | to 37.4' | D100  | D60    | D30    | D10  | %Gravel      | %Sand | %Silt | %Clay |           |
|                                 |         |        |          | 19.0080   | 0.6968 |        |      | 20.2         | 45.4  |       | 34.4  |           |

**ASTM D422**      **GRADATION CURVE**      PROJECT CLINCH RIVER POND #2 CLOSURE  
 LOCATION CARBO, VIRGINIA      DATE 11/6/08  
 JOB NO. 011-11497-007

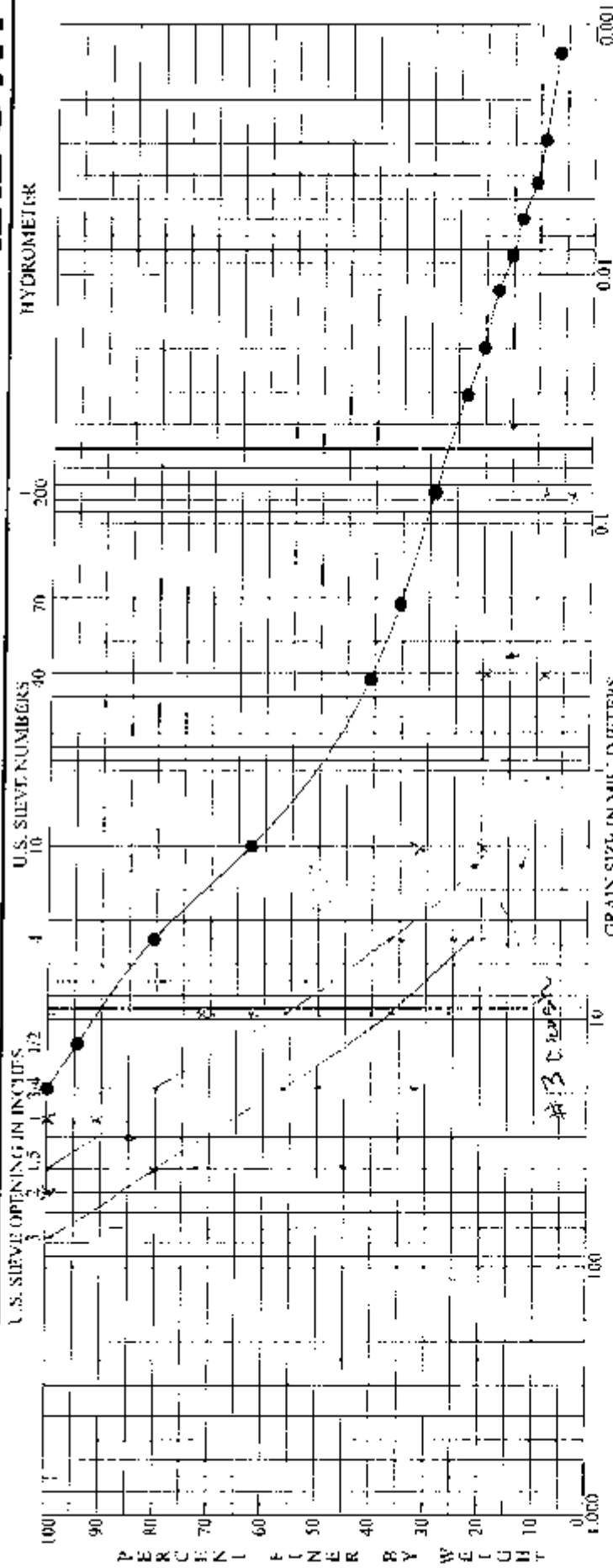

| BOULDERS                        | COBBLES | GRAVEL   | SAND   |        |          | SILT OR CLAY |       |                              |        |           |
|---------------------------------|---------|--|--------|--------|----------|--------------|-------|------------------------------|--------|-----------|
| Classification                  |         | coarse   | fine   | coarse | medium   | fine         | PL    | PI                           | opt mc | % max pcf |
| Specimen Identification - Depth |         |  |        |        |          |              |       |                              |        |           |
| ● B-4 S-1 1.7' to 3.1'          |         | FLYASH Brown and gray fine to coarse sand, little fine gravel (slate fragments), some clayey silt. |        |        |          |              |       |                              |        |           |
| Specimen Identification - Depth |         | D100   | D60    | D30    | D10      | %Gravel      | %Sand | %Silt                        | %Clay  |           |
| ● B-4 S-1 1.7' to 3.1'          |         | 19.0000  | 1.6660 | 0.0859 | 0.0036   | 19.5         | 51.3  | 17.2                         | 12.0   |           |
| ASTM D422                       |         | GRADATION CURVE  |        |        | PROJECT  |              |       | CLINCH RIVER POND #2 CLOSURE |        |           |
|                                 |         |  |        |        | LOCATION |              |       | CARBO, VIRGINIA              |        |           |
|                                 |         |  |        |        | JOB NO.  |              |       | 011-11497-007                |        |           |
|                                 |         |  |        |        | DATE     |              |       | 11/6/08                      |        |           |

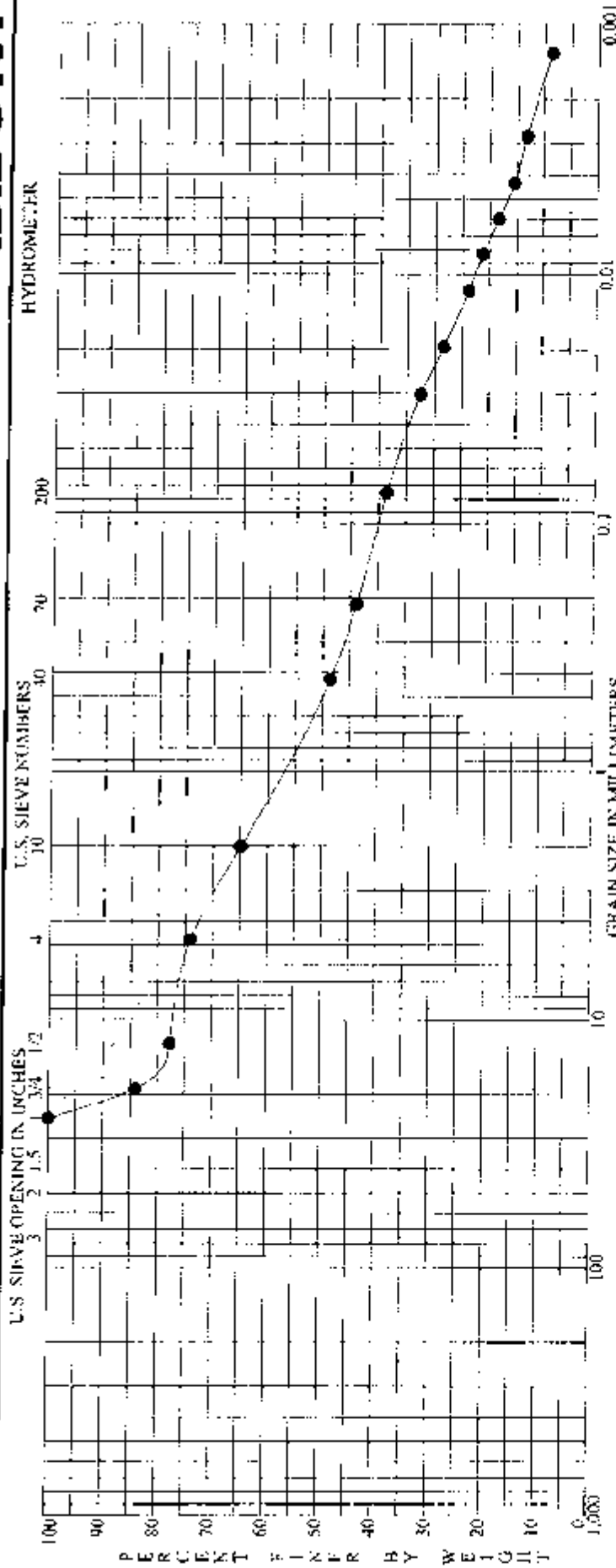

| BOULDERS  | COBBLES |      | GRAVEL |        |      | SAND |    |    | SILT OR CLAY |    |       |
|---|---------|------|--------|--------|------|------|----|----|--------------|----|-------|
|   | coarse  | fine | coarse | medium | fine | LL   | PL | PI | opt          | mc | % max |
| Specimen Identification - Depth<br>● B-4 S-8 19.2' to 20.1' FLY ASH Brown and gray fine to coarse sand, some fine to coarse gravel (shale fragments), "and" silty clay. |         |      |        |        |      |      |    |    |              |    |       |
| Specimen Identification - Depth<br>● B-4 S-8 19.2' to 20.1' 25.0000 D100 1.2594 D60 0.0231 D30 0.0016 D10   |         |      |        |        |      |      |    |    |              |    |       |
| MC% 11 %Gravel 26.0 %Sand 35.5 %Silt 21.7 %Clay 16.8  |         |      |        |        |      |      |    |    |              |    |       |
| ASTM D422 GRADATION CURVE CLINCH RIVER POND #2 CLOSURE<br>LOCATION CARBO, VIRGINIA<br>JOB NO. 011-11497-007 DATE 11/6/08  |         |      |        |        |      |      |    |    |              |    |       |



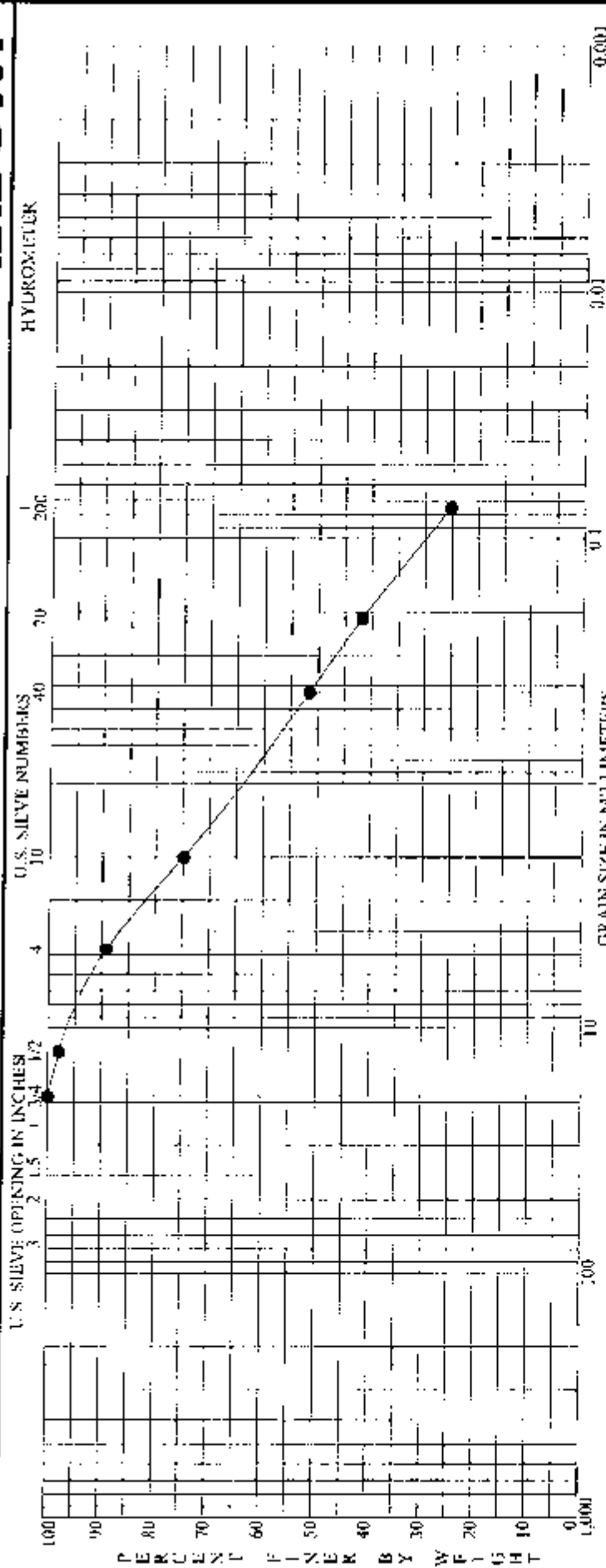

|   |  |  |                |  |  |        |  |  |  |  |  |
|---|--|--|----------------|--|--|--------|--|--|--|--|--|
| BOULDERS COBBLES  |  |  | GRAVEL         |  |  | SAND   |  |  | SILT OR CLAY                             |  |  |
| coarse  |  |  | fine           |  |  | coarse |  |  | fine                                     |  |  |
| Classification  |  |  | Classification |  |  | MC%    |  |  | LL PL pI opt mc % <sub>opt</sub> max pcf |  |  |
| Specimen Identification - Depth: <b>B-4 S-12 29.2' to 30.7'</b> Flyash Gray fine to coarse sand, little fine gravel, some silt. |  |  |                |  |  |        |  |  |  |  |  |
| Specimen Identification - Depth: <b>B-4 S-12 29.2' to 30.7'</b>   |  |  |                |  |  |        |  |  |  |  |  |
| D100  |  |  | D60            |  |  | D30    |  |  | D10                                      |  |  |
| 19.0000   |  |  | 0.7436         |  |  | 0.1013 |  |  | 10.8                                     |  |  |
| %Sand   |  |  | %Gravel        |  |  | %Silt  |  |  | %Clay                                    |  |  |
| 64.0  |  |  | 25.2           |  |  |        |  |  |  |  |  |

**ASTM D422 GRADATION CURVE**

**PROJECT** CLINCH RIVER POND #2 CLOSURE  
**LOCATION** CARBO, VIRGINIA  
**JOB NO.** 011-11497-007 **DATE** 11/6/08

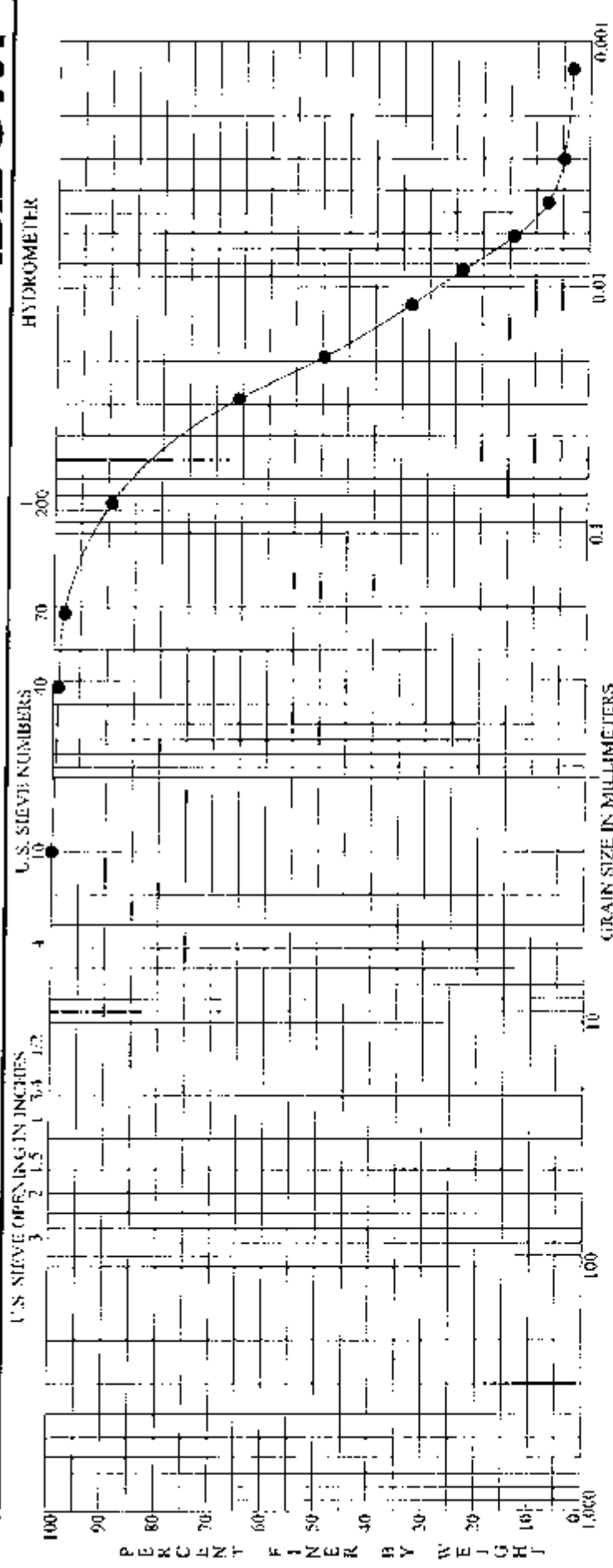

| BOULDERS                        | GRAVEL |        | SAND  |        |                 | SILT OR CLAY |       |       |           |
|---------------------------------|--------|--------|---|--------|-----------------|--------------|-------|-------|-----------|
|                                 | coarse | fine   | coarse  | medium | fine            | PI           | opt   | mc    | % max per |
| Specimen Identification - Depth |        |        |   |        |                 |              |       |       |           |
| ● B-4 S-17 41.7' to 43.2'       |        |        | FLYASH Gray silt, trace clay, little fine to medium sand. |        |                 |              |       |       |           |
|                                 |        |        |   |        |                 |              |       |       |           |
|                                 |        |        |   |        |                 |              |       |       |           |
| Specimen Identification - Depth | D100   | D60    | D30   | D10    | D <sub>50</sub> | %Sand        | %Silt | %Clay |           |
| ● B-4 S-17 41.7' to 43.2'       | 2.0000 | 0.0246 | 0.0104  | 0.0050 |                 | 10.6         | 79.5  | 9.9   |           |

PROJECT \_\_\_\_\_ CLINCH RIVER POND #2 CLOSURE  
 LOCATION \_\_\_\_\_ CARBO, VIRGINIA  
 JOB NO. \_\_\_\_\_ 011-11497-007 DATE \_\_\_\_\_ 11/5/08

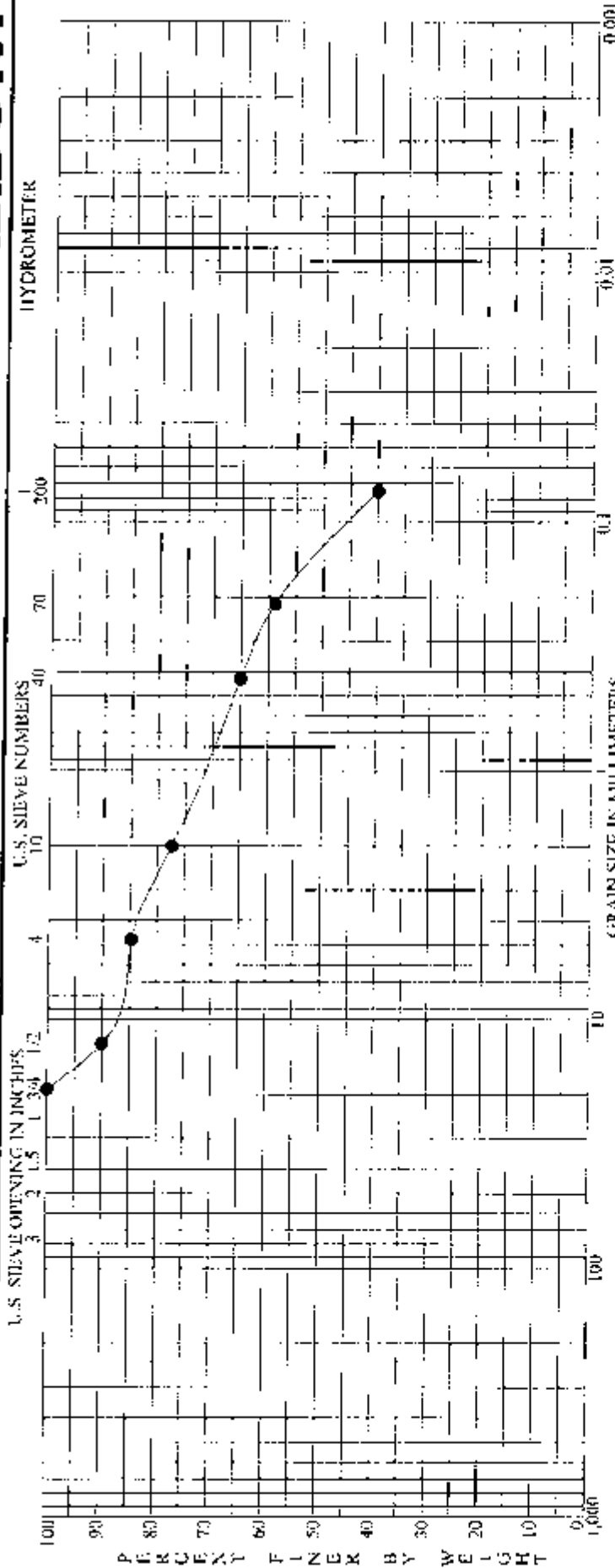

BOULDERS COBBLES \_\_\_\_\_ GRAVEL \_\_\_\_\_ coarse \_\_\_\_\_ fine \_\_\_\_\_ SAND \_\_\_\_\_ coarse \_\_\_\_\_ medium \_\_\_\_\_ fine \_\_\_\_\_ SILT OR CLAY \_\_\_\_\_

Classification \_\_\_\_\_ MC% \_\_\_\_\_ LL \_\_\_\_\_ PL \_\_\_\_\_ PI \_\_\_\_\_ opt me %i max pcf \_\_\_\_\_

Specimen Identification - Depth **B-4 S-21 54.2' to 55.7'** FLYASH Gray fine to coarse sand, little fine gravel, "and" silt.

|                                 |         |        |     |     |         |       |       |       |
|---------------------------------|---------|--------|-----|-----|---------|-------|-------|-------|
| Specimen Identification - Depth | D100    | D60    | D30 | D10 | %Gravel | %Sand | %Silt | %Clay |
| B-4 S-21 54.2' to 55.7'         | 19.0000 | 0.2431 |     |     | 15.3    | 44.8  |       | 40.0  |

ASTM D422 | GRADATION CURVE

PROJECT CLINCH RIVER POND #2 CLOSURE  
 LOCATION CARBO, VIRGINIA  
 JOB NO. 011-11497-007 DATE 11/6/98

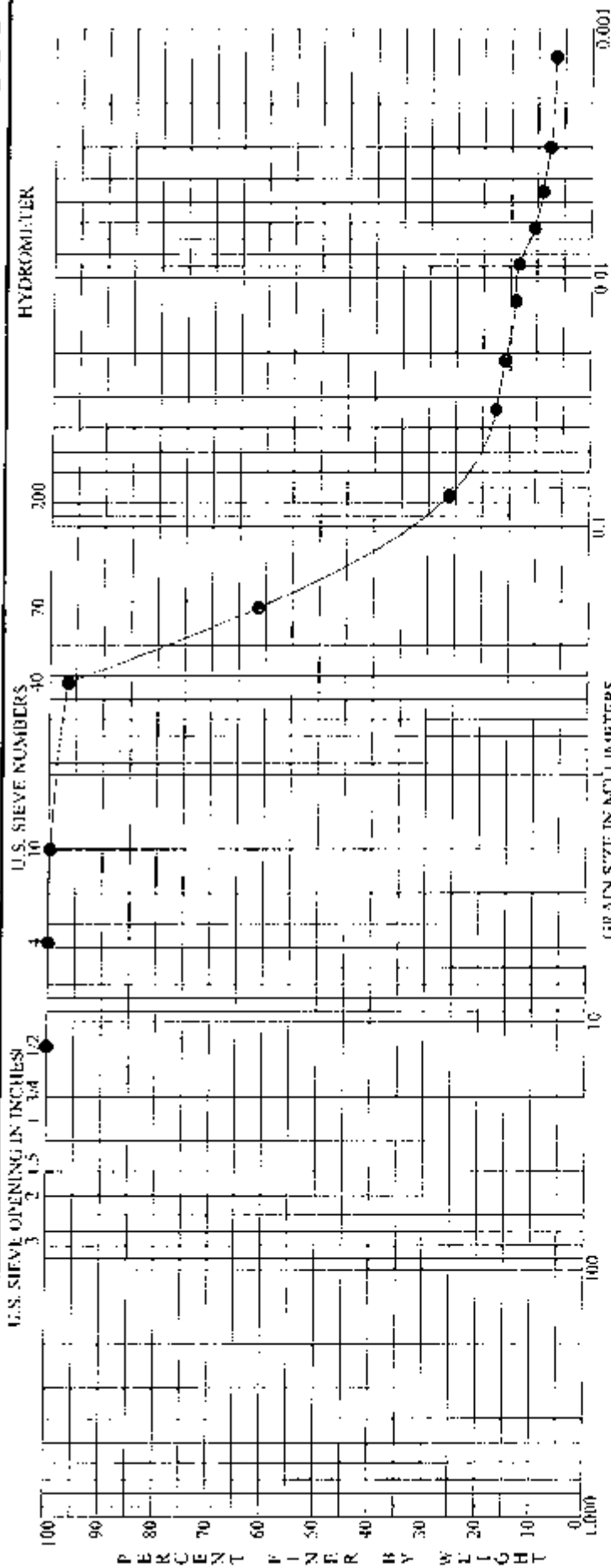

| BOULDERS  | COBBLES |                | GRAVEL  |        |        | SAND   |        |        | SILT OR CLAY |    |    |           |         |
|---|---------|----------------|---|--------|--------|--------|--------|--------|--------------|----|----|-----------|---------|
|   | Depth   | Classification | fine  | coarse | medium | fine   | coarse | medium | LL           | PL | PI | opt. mc % | max pcf |
| ● B-4   | S-23a   | 64.2' to 65.0' | FLYASH Gray fine sand, trace medium to coarse sand, trace fine gravel, little silt, trace clay. |        |        | 24     | NP     | NP     | NP           | NP | NP | 16.7      | 9.5     |
| Specimen Identification - Depth<br>● B-4 S-23a 64.2' to 65.0' |         |                |   |        |        |        |        |        |              |    |    |           |         |
| Specimen Identification - Depth<br>● B-4 S-23a 64.2' to 65.0' |         |                |   |        |        |        |        |        |              |    |    |           |         |
|   |         |                | D100  | D60    | D30    | D10    | D40    | D60    | MC%          | LL | PL | %Silt     | %Clay   |
|   |         |                | 12.5000   | 0.2038 | 0.0840 | 0.0056 | 0.1    | 73.7   | 24           | NP | NP | 16.7      | 9.5     |

**ASTM D422**    **GRADATION CURVE**    PROJECT **CLINCH RIVER POND #2 CLOSURE**  
 LOCATION **CARBO, VIRGINIA**  
 JOB NO. **011-11497-007**    DATE **11/6/08**

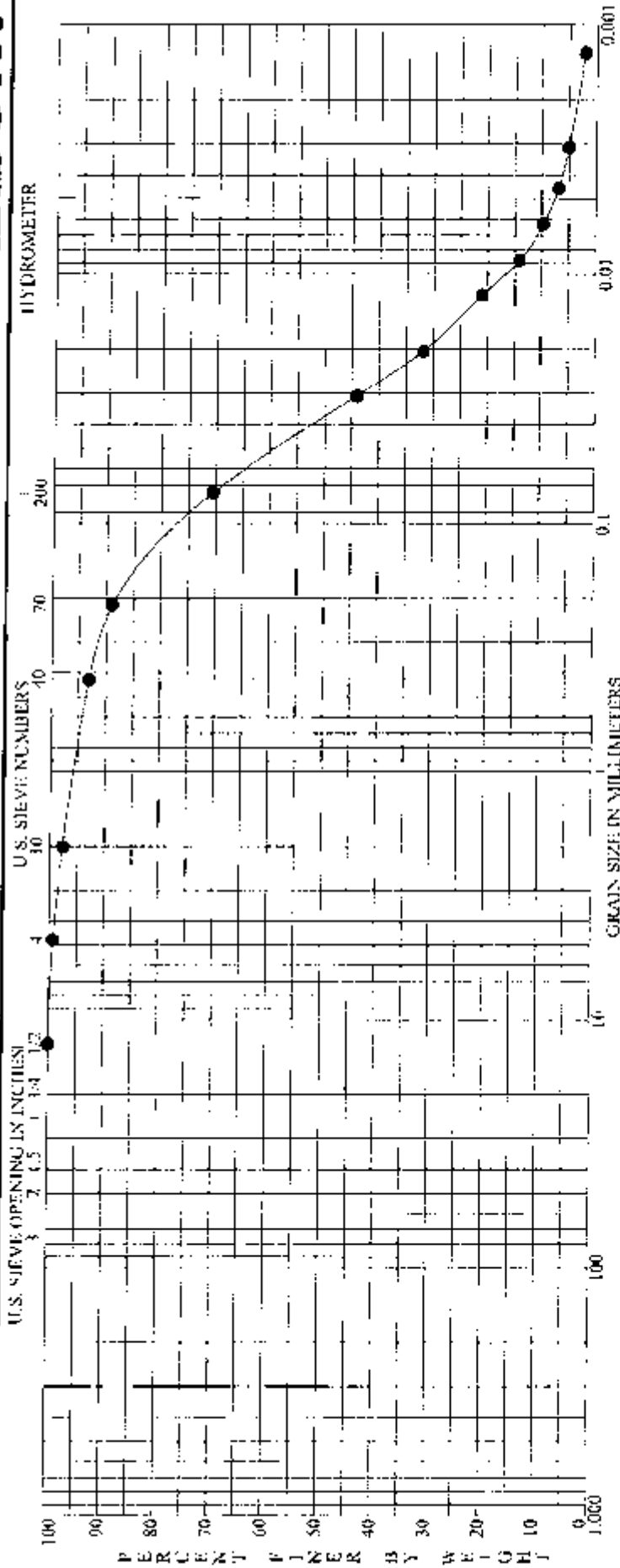

| BOULDERS COBBLES                |  |        |  | GRAVEL  |  |        |  | SAND  |  |       |  | SILT OR CLAY  |  |       |  |                       |  |
|---------------------------------|--|--------|--|---|--|--------|--|---|--|-------|--|---|--|-------|--|-----------------------|--|
| coarse                          |  | fine   |  | coarse  |  | medium |  | fine  |  | LL    |  | PL  |  | PI    |  | opt. org. % max. def. |  |
| Classification                  |  |        |  | Classification  |  |        |  | Classification  |  |       |  | Classification  |  |       |  |                       |  |
| Specimen Identification - Depth |  |        |  | Specimen Identification - Depth   |  |        |  | Specimen Identification - Depth   |  |       |  | Specimen Identification - Depth   |  |       |  |                       |  |
| B-5 S-3 11.7' to 13.2'          |  |        |  | FLYASH Gray and dark-gray silt, trace clay, some fine sand, trace medium to coarse sand, trace fine gravel. |  |        |  | FLYASH Gray and dark-gray silt, trace clay, some fine sand, trace medium to coarse sand, trace fine gravel. |  |       |  | FLYASH Gray and dark-gray silt, trace clay, some fine sand, trace medium to coarse sand, trace fine gravel. |  |       |  |                       |  |
| D(10)                           |  | D(30)  |  | D(60)   |  | D(100) |  | %Gravel   |  | %Sand |  | %Silt   |  | %Clay |  |                       |  |
| 12.5000                         |  | 0.0525 |  | 0.0185  |  | 0.0064 |  | 0.7   |  | 28.8  |  | 62.8  |  | 7.8   |  |                       |  |

**ASTM D422**      **GRADATION CURVE**      PROJECT CLINCH RIVER POND #2 CLOSURE  
 LOCATION CARBO, VIRGINIA  
 JOB NO. 011-11497-007      DATE 11/6/08

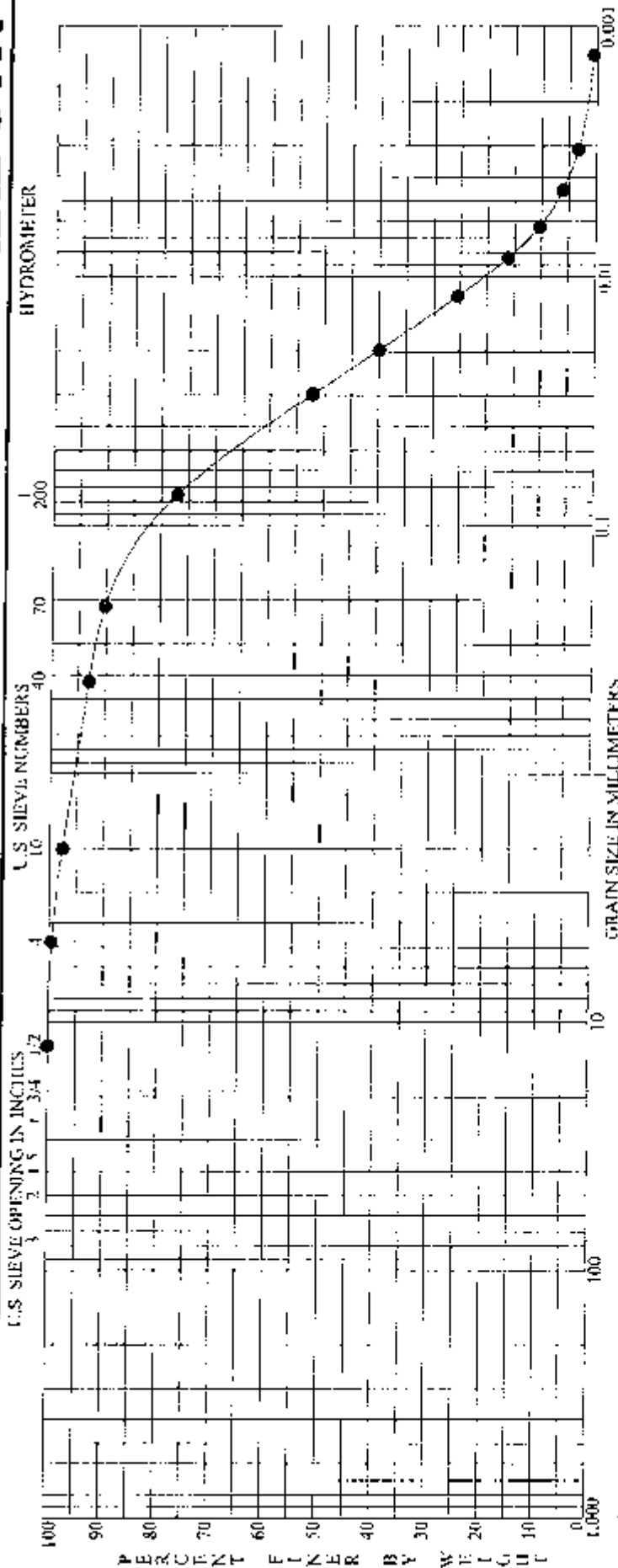

| BOULDERS                        |  | COBBLES                |  | GRAVEL   |  | SAND        |  | SILT OR CLAY |  |
|---------------------------------|--|------------------------|--|--|--|-------------|--|--------------|--|
| coarse                          |  | fine                   |  | coarse   |  | medium      |  | fine         |  |
| Classification                  |  | Classification         |  | MC%  |  | LL          |  | PI           |  |
| Specimen Identification - Depth |  | B-5 S-5 21.7' to 23.2' |  | FLYASH Gray, dark-gray and gray-brown silt, trace clay, some fine to coarse sand, trace fine gravel. |  | S8          |  | NP NP        |  |
| Specimen Identification - Depth |  | B-5 S-5 21.7' to 23.2' |  | D100 12.5000   |  | D60 0.0397  |  | D30 0.0140   |  |
|                                 |  |                        |  | D10 0.0061   |  | %Gravel 0.5 |  | %Sand 22.5   |  |
|                                 |  |                        |  |  |  |             |  | %Silt 69.5   |  |
|                                 |  |                        |  |  |  |             |  | %Clay 7.5    |  |

ASTM D422 GRADATION CURVE LOCATION CARBO, VIRGINIA

PROJECT CLINCH RIVER POND #2 CLOSURE

JOB NO. 011-11497-007 DATE 11/6/08

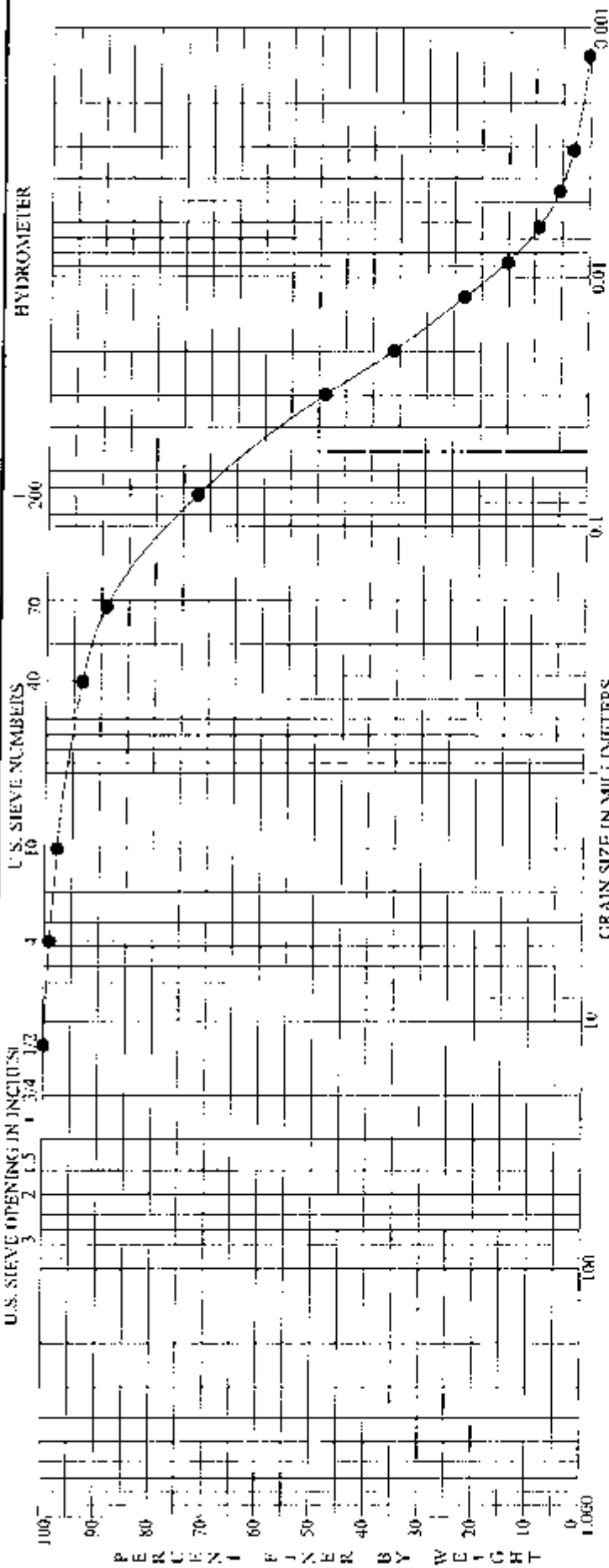

| BOULDERS                        | COBBLES | GRAVEL  | SAND   | SILT OR CLAY |       |          |               |
|---------------------------------|---------|---|--------|--------------|-------|----------|---------------|
| coarse                          | fine    | coarse  | fine   |              |       |          |               |
| Classification                  |         | MC%   | LL     | PL           | PI    | opt mc % | max pct %Clay |
| Specimen Identification - Depth |         |   |        |              |       |          |               |
| ● B-5 S-10 46.7' to 48.2'       |         | FLYASH Gray silt, trace clay, some fine sand, trace medium to coarse sand, trace fine gravel. |        |              |       |          |               |
| Specimen Identification - Depth |         |   |        |              |       |          |               |
| ● B-5 S-10 46.7' to 48.2'       |         |   |        |              |       |          |               |
| D100                            | D60     | D30   | D10    | %Gravel      | %Sand | %Silt    | %Clay         |
| 12.5000                         | 0.0460  | 0.0156  | 0.0066 | 1.0          | 26.7  | 65.7     | 6.7           |
| PROJECT                         |         | CLINCH RIVER POND #2 CLOSURE  |        |              |       |          |               |
| LOCATION                        |         | CARBO, VIRGINIA   |        |              |       |          |               |
| JOB NO.                         |         | 011-11497-007   |        | DATE         |       | 11/6/08  |               |

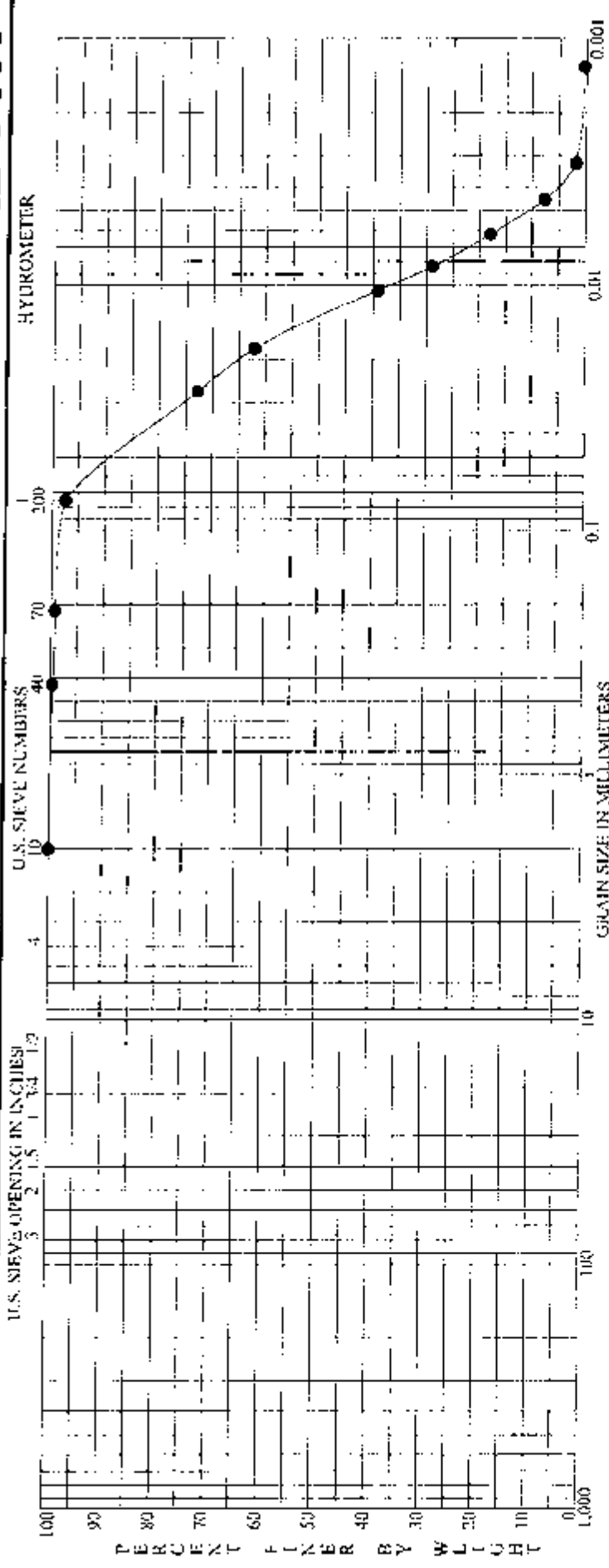

| BOULDERS   | COBBLES |       | GRAVEL |        |      | SAND   |        |      | SILT OR CLAY |    |    |    |     |    |       |       |       |     |       |      |       |      |
|--|---------|-------|--------|--------|------|--------|--------|------|--------------|----|----|----|-----|----|-------|-------|-------|-----|-------|------|-------|------|
|  | course  | fine  | course | medium | fine | coarse | medium | fine | MC%          | LL | PI | PI | opt | mc | % max | % per |       |     |       |      |       |      |
| Specimen Identification - Depth  |         |       |        |        |      |        |        |      |              |    |    |    |     |    |       |       |       |     |       |      |       |      |
| ● B-6 S-3 11.6' to 13.1' FLYASH Gray and dark-gray silt, little clay, trace fine to medium sand.                             |         |       |        |        |      |        |        |      |              |    |    |    |     |    |       |       |       |     |       |      |       |      |
| Specimen Identification - Depth  |         |       |        |        |      |        |        |      |              |    |    |    |     |    |       |       |       |     |       |      |       |      |
| ● B-6 S-3 11.6' to 13.1' 2.0000 D100 0.0172 D60 0.0086 D30 0.0048 D10 0.0  |         |       |        |        |      |        |        |      |              |    |    |    |     |    |       |       |       |     |       |      |       |      |
| <table border="1"> <tr> <td>%Sand</td> <td>2.6</td> <td>%Silt</td> <td>86.4</td> <td>%Clay</td> <td>11.1</td> </tr> </table> |         |       |        |        |      |        |        |      |              |    |    |    |     |    |       |       | %Sand | 2.6 | %Silt | 86.4 | %Clay | 11.1 |
| %Sand  | 2.6     | %Silt | 86.4   | %Clay  | 11.1 |        |        |      |              |    |    |    |     |    |       |       |       |     |       |      |       |      |

ASTM D422 GRADATION CURVE LOCATION CLINCH RIVER POND #2 CLOSURE  
 PROJECT CARBO, VIRGINIA  
 JOB NO. 011-11497-007 DATE 11/6/08



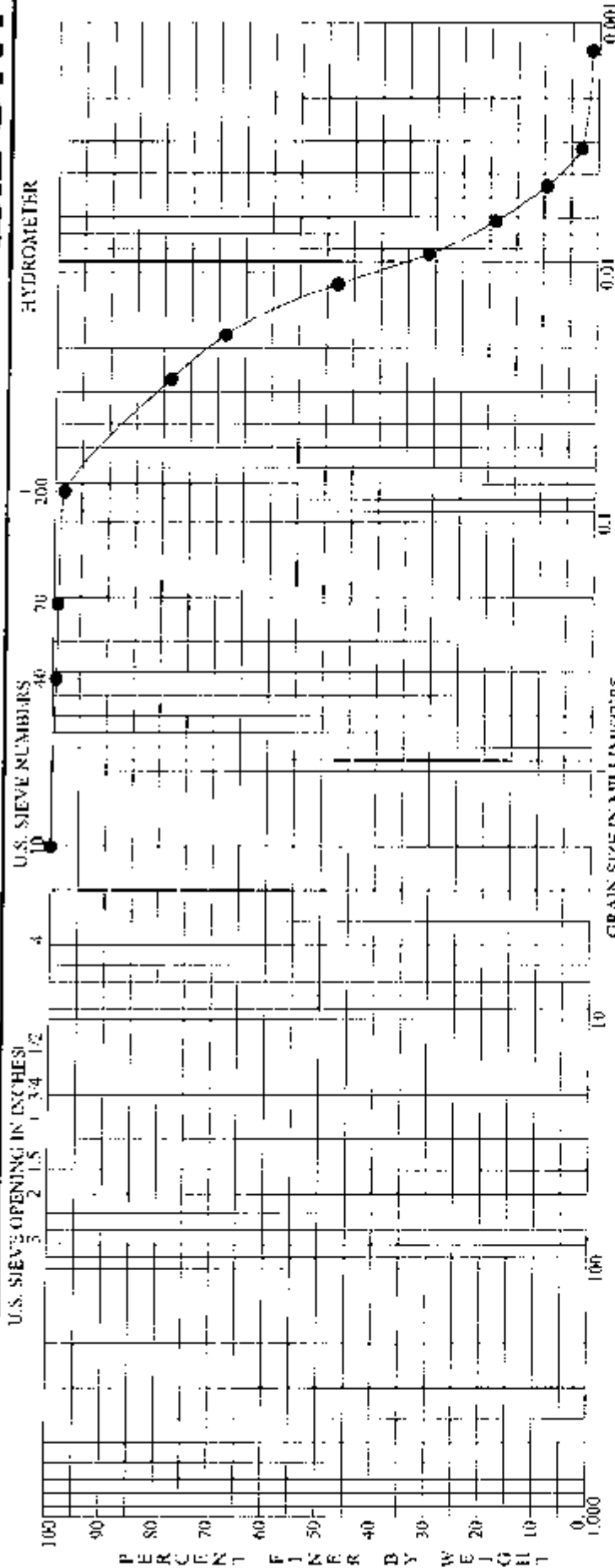

**BOULDERS** \_\_\_\_\_ **GRAVEL** \_\_\_\_\_ **SAND** \_\_\_\_\_ **SILT OR CLAY** \_\_\_\_\_  
 coarse fine coarse medium fine  
 Classification \_\_\_\_\_  
 MC% \_\_\_\_\_ PL \_\_\_\_\_ PI \_\_\_\_\_ opt mc %  
 max pct \_\_\_\_\_ NP \_\_\_\_\_ NP \_\_\_\_\_ NP \_\_\_\_\_  
 FLYASH Gray and dark gray silt, little clay, trace fine to medium sand.

Specimen Identification - Depth \_\_\_\_\_  
 B-6 S-6 26.6' to 28.1'

Specimen Identification - Depth \_\_\_\_\_  
 B-6 S-6 26.6' to 28.1'

| Specimen Identification - Depth | D100   | D60    | D30    | D10    | %Gravel | %Sand | %Silt | %Clay |
|---------------------------------|--------|--------|--------|--------|---------|-------|-------|-------|
| B-6 S-6 26.6' to 28.1'          | 2.0000 | 0.0146 | 0.0081 | 0.0046 | 0.0     | 1.8   | 85.6  | 12.6  |

PROJECT \_\_\_\_\_ CLINCH RIVER POND #2 CLOSURE  
 LOCATION \_\_\_\_\_ CARBO, VIRGINIA  
 JOB NO. \_\_\_\_\_ DATE 11/6/08

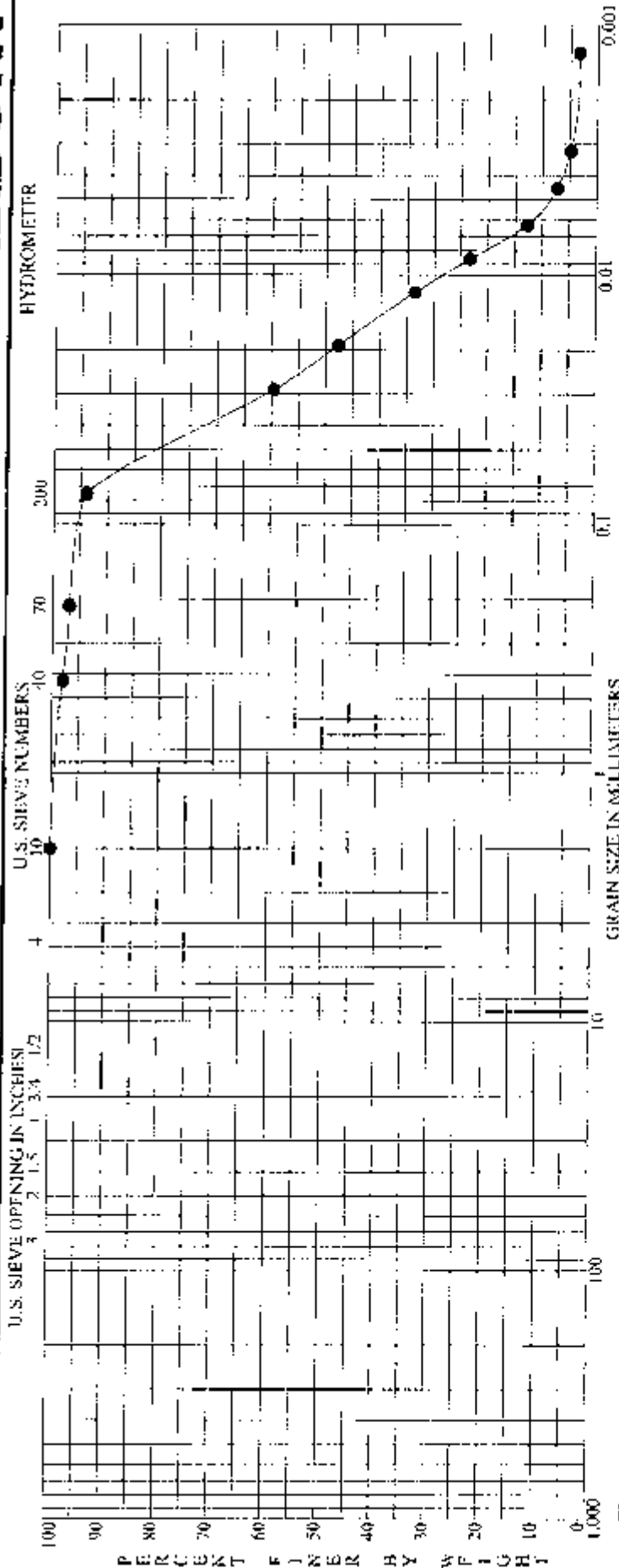

| BOULDERS                        | GRAVEL  |        | SAND          |        |         | SILT OR CLAY                 |       |                  |
|---------------------------------|---|--------|---------------|--------|---------|------------------------------|-------|------------------|
|                                 | coarse  | fine   | coarse        | medium | fine    | PL                           | PI    | opt me % max pct |
| Specimen Identification - Depth | Classification  |        |               |        |         |                              |       |                  |
| ● B-7 S-9 41.6' to 43.1'        | FLYASH Gray, graybrown and dark-gray silt, trace clay, trace fine to medium sand. |        |               |        |         |                              |       |                  |
| Specimen Identification - Depth | D100  | D60    | D30           | D10    | %Gravel | %Sand                        | %Silt | %Clay            |
| ● B-7 S-9 41.6' to 43.1'        | 2.0000  | 0.0290 | 0.0105        | 0.0053 | 0.0     | 6.1                          | 84.9  | 9.0              |
| ASTM D422                       | GRADATION CURVE   |        | PROJECT       |        |         | CLINCH RIVER POND #2 CLOSURE |       |                  |
|                                 | LOCATION  |        | JOB NO.       |        |         | CARBO, VIRGINIA              |       |                  |
|                                 | DATE  |        | 011-11497-007 |        |         | 11/6/98                      |       |                  |

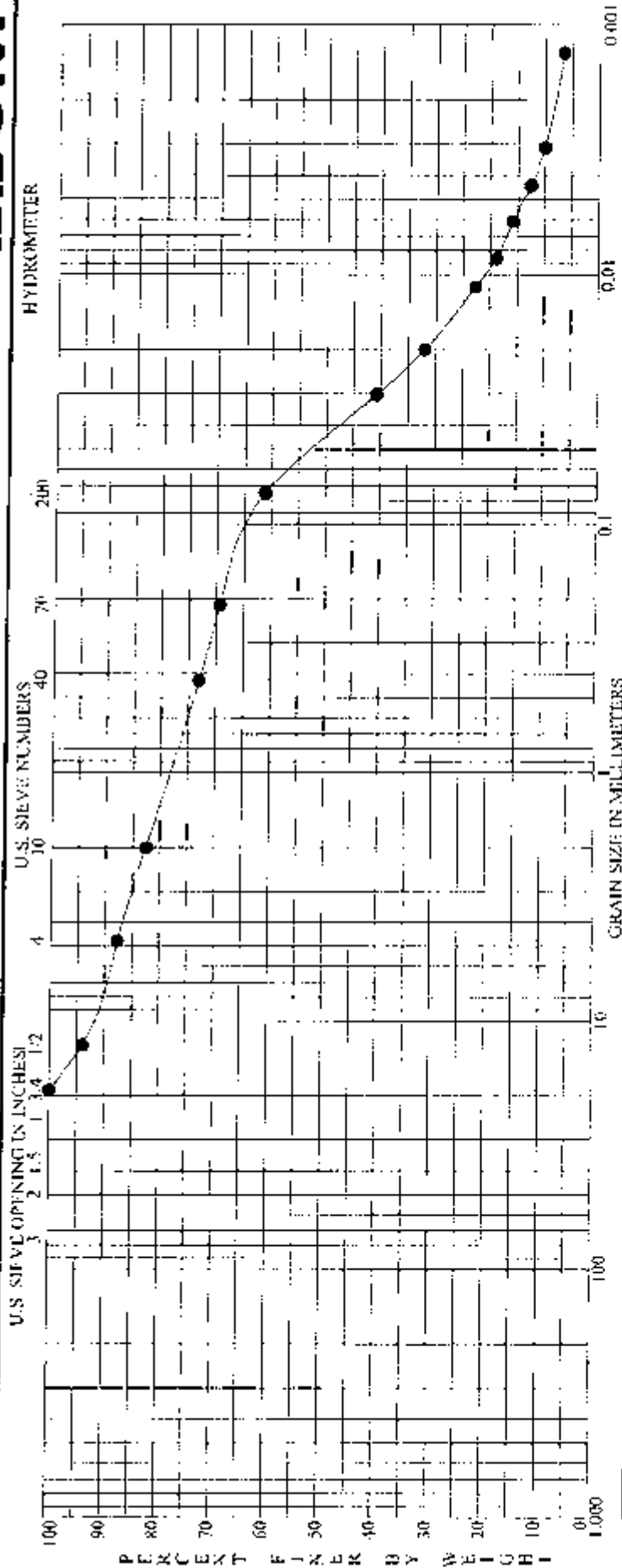

| BOULDERS                        | CORRIERS | GRAVEL         | SAND  | SILT OR CLAY |
|---------------------------------|----------|----------------|---|--------------|
| coarse                          | fine     | coarse         | medium  | fine         |
| <b>Classification</b>           |          |                |   |              |
| Specimen Identification - Depth |          |                |   |              |
| B-7                             | S-14     | 66.6' to 67.7' | FLYASH Brown silt, little clay, some fine to coarse sand, little fine gravel. |              |
| MC%                             |          |                |   |              |
| 25                              |          |                |   |              |
| LL                              |          |                |   |              |
| 23                              |          |                |   |              |
| PI                              |          |                |   |              |
| 21                              |          |                |   |              |
| PI                              |          |                |   |              |
| 2                               |          |                |   |              |
| opt me                          |          |                |   |              |
| % max per                       |          |                |   |              |
| % Sand                          |          |                |   |              |
| 26.4                            |          |                |   |              |
| % Gravel                        |          |                |   |              |
| 12.3                            |          |                |   |              |
| D10                             |          |                |   |              |
| 0.0030                          |          |                |   |              |
| D30                             |          |                |   |              |
| 0.0176                          |          |                |   |              |
| D60                             |          |                |   |              |
| 0.0709                          |          |                |   |              |
| D100                            |          |                |   |              |
| 19.0000                         |          |                |   |              |
| % Silt                          |          |                |   |              |
| 47.4                            |          |                |   |              |
| % Clay                          |          |                |   |              |
| 13.9                            |          |                |   |              |

**ASTM D422 GRADATION CURVE**      PROJECT CLINCH RIVER POND #2 CLOSURE  
 LOCATION CARBO, VIRGINIA  
 JOB NO. 011-11497-007      DATE 11/6/08

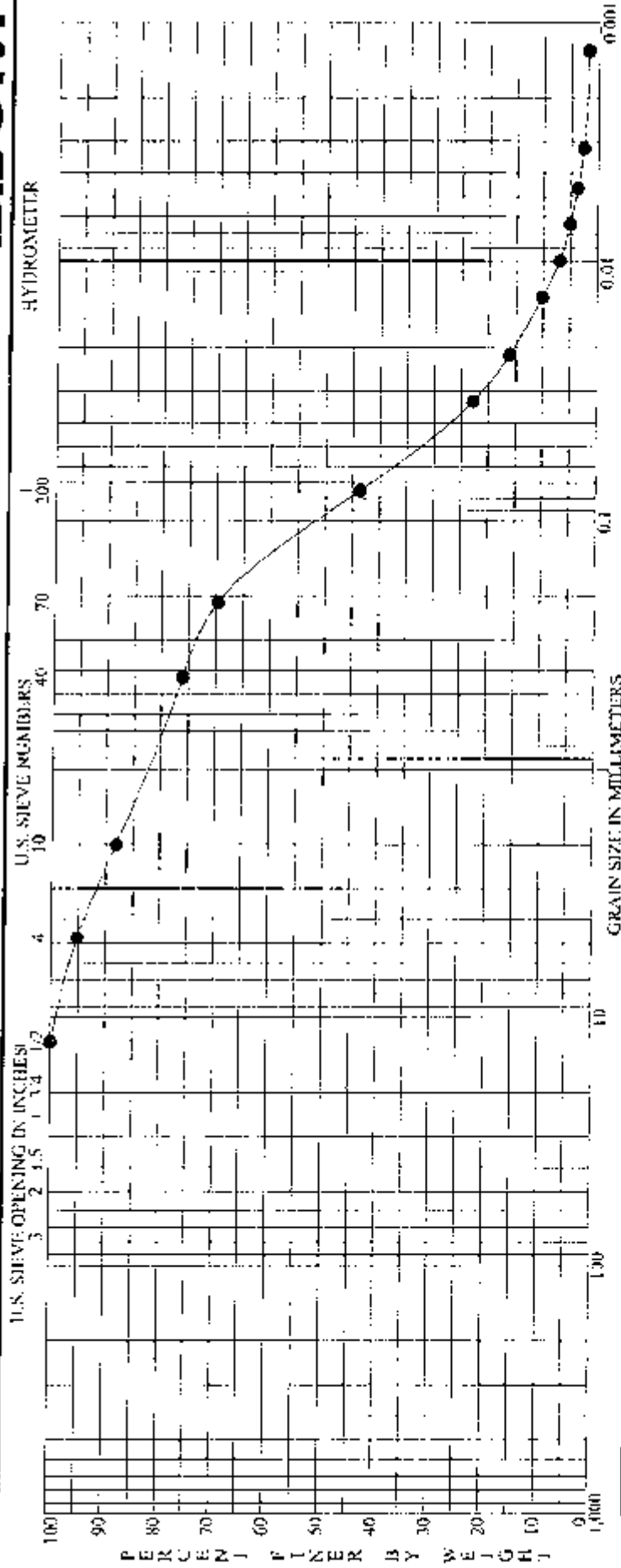

| BOULDERS  | GRAVEL   |        |        | SAND   |         |       | SILT OR CLAY |       |    |    |        |           |
|---|--|--------|--------|--------|---------|-------|--------------|-------|----|----|--------|-----------|
|   | coarse   | fine   | fine   | coarse | medium  | fine  | MC%          | LL    | PL | PI | opt me | % max per |
| Specimen Identification - Depth   |  |        |        |        |         |       |              |       |    |    |        |           |
| ● B-8 S-2 6.7' to 8.1'  | FLYASH Fray fine to medium sand, trace coarse sand, trace fine gravel, "and" silt, trace clay. |        |        |        |         |       |              |       |    |    |        |           |
| Specimen Identification - Depth   |  |        |        |        |         |       |              |       |    |    |        |           |
| ● B-8 S-2 6.7' to 8.1'  | D100   | D60    | D30    | D10    | %Gravel | %Sand | %Silt        | %Clay |    |    |        |           |
|   | 12.5000  | 0.1439 | 0.0437 | 0.0123 | 4.8     | 51.5  | 39.5         | 4.1   |    |    |        |           |
| PROJECT: CLINCH RIVER POND #2 CLOSURE<br>LOCATION: CARBO, VIRGINIA<br>JOB NO.: 011-11497-007<br>DATE: 11/6/08 |  |        |        |        |         |       |              |       |    |    |        |           |

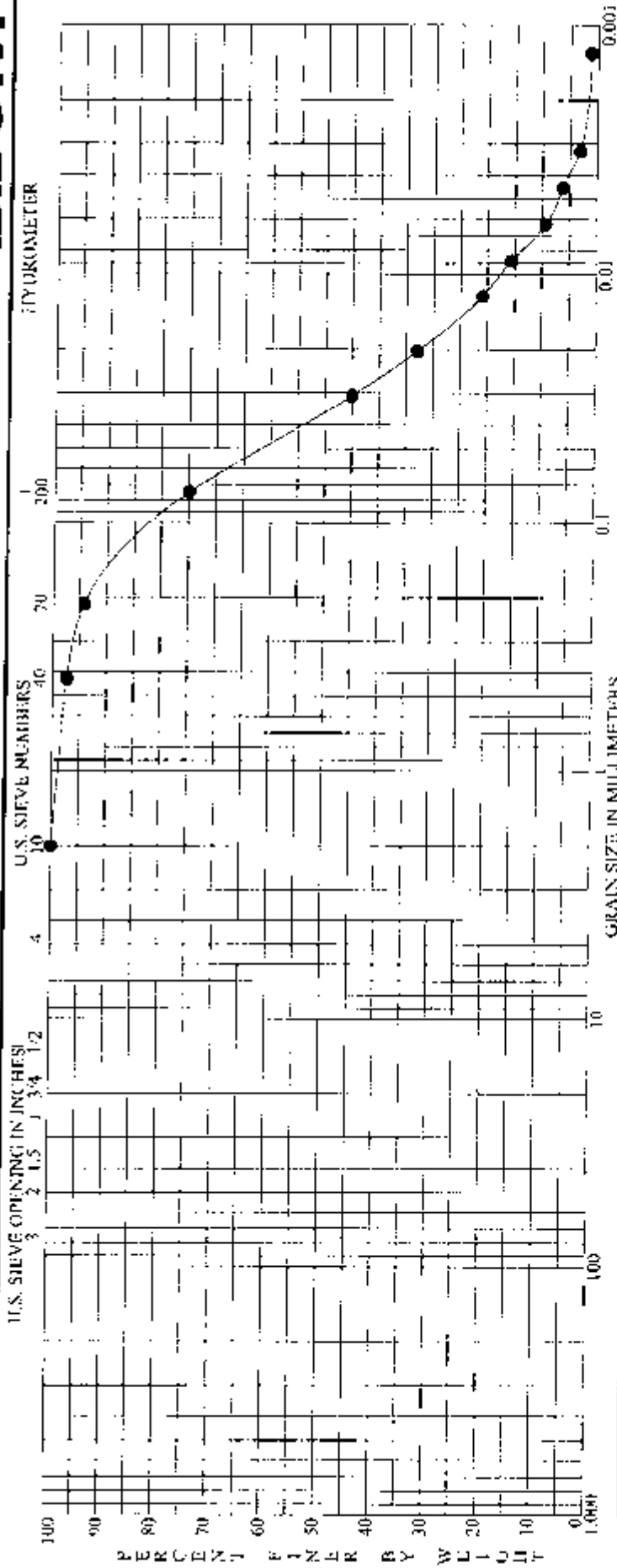

|   |                |               |             |                     |        |                  |
|---|----------------|---------------|-------------|---------------------|--------|------------------|
| <b>BOULDERS</b>   | <b>COBBLES</b> | <b>GRAVEL</b> | <b>SAND</b> | <b>SILT OR CLAY</b> |        |                  |
| fine  | coarse         | fine          | coarse      | medium              | fine   |                  |
| Classification  |                | MC%           | LL          | PL                  | PI     | opt me % max pcf |
| <b>B-8 S-4 16.7' to 18.2'</b>   |                | 66            |             |                     |        |                  |
| Specimen Identification - Depth<br><b>B-8 S-4 16.7' to 18.2'</b>  |                |               |             |                     |        |                  |
| Description<br><b>FLYASH Graybrown and gray silt, trace clay, some fine to medium sand, few seams of fine sand.</b> |                |               |             |                     |        |                  |
| Specimen Identification - Depth   |                |               | D100        | D60                 | D30    | D10              |
| <b>B-8 S-4 16.7' to 18.2'</b>   |                |               | 2.0000      | 0.0479              | 0.0179 | 0.0065           |
|   |                |               |             | %Gravel             | %Sand  | %Silt            |
|   |                |               |             | 0.0                 | 25.0   | 67.7             |
|   |                |               |             |                     |        | 7.3              |
| PROJECT<br><b>CLINCH RIVER POND #2 CLOSURE</b>  |                |               |             |                     |        |                  |
| LOCATION<br><b>CARBO, VIRGINIA</b>  |                |               |             |                     |        |                  |
| JOB NO. <b>011-11497-007</b> DATE <b>11/6/08</b>  |                |               |             |                     |        |                  |

APPENDIX B: Slope Stability Analysis

### Global Stability Analysis

- Analyze static and pseudo-static conditions of final dike system and cover.
- Examine circular and translational failure surfaces.
- Program: Slide V. 5.035 developed by Rocscience, Inc.

#### Groundwater:

AEP stability analysis assumed groundwater was equivalent to height of newly placed ash fill above the middle dike since operations were active and ash was being sluiced in. Recently performed borings, however, indicate the groundwater level has lowered since operations have become inactive. The design cross section shown in this Appendix shows the groundwater levels as encountered during drilling. Generally, this lowered groundwater level improved the overall stability of the dike system in comparison with AEP's report.

Design parameters are shown on the graphical output for each stability run.

#### Summary of Results

| Load Case  | Computed FS | FS <sub>REQ'D</sub> |
|--|-------------|---------------------|
| Static Loading with Final Slopes<br>-Circular Failure Surface                                | 1.67        | 1.5                 |
| Static Loading with Final Slopes<br>-Translational Failure Surface<br>-Middle Dike           | 2.67        | 1.5                 |
| Static Loading with Final Slopes<br>-Translational Failure Surface<br>Lower and Middle Dikes | 2.20        | 1.5                 |
| Pseudo-Static Loading with Final Slopes<br>-Circular Failure Surface                         | 1.13        | 1.0                 |

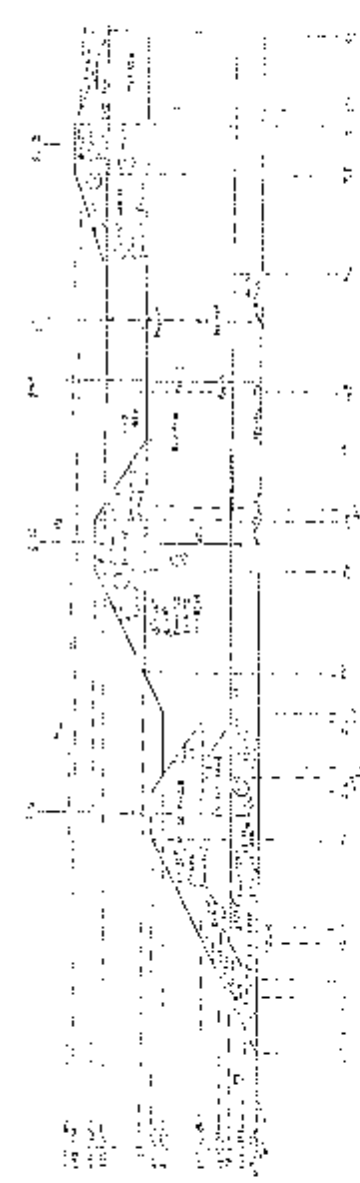
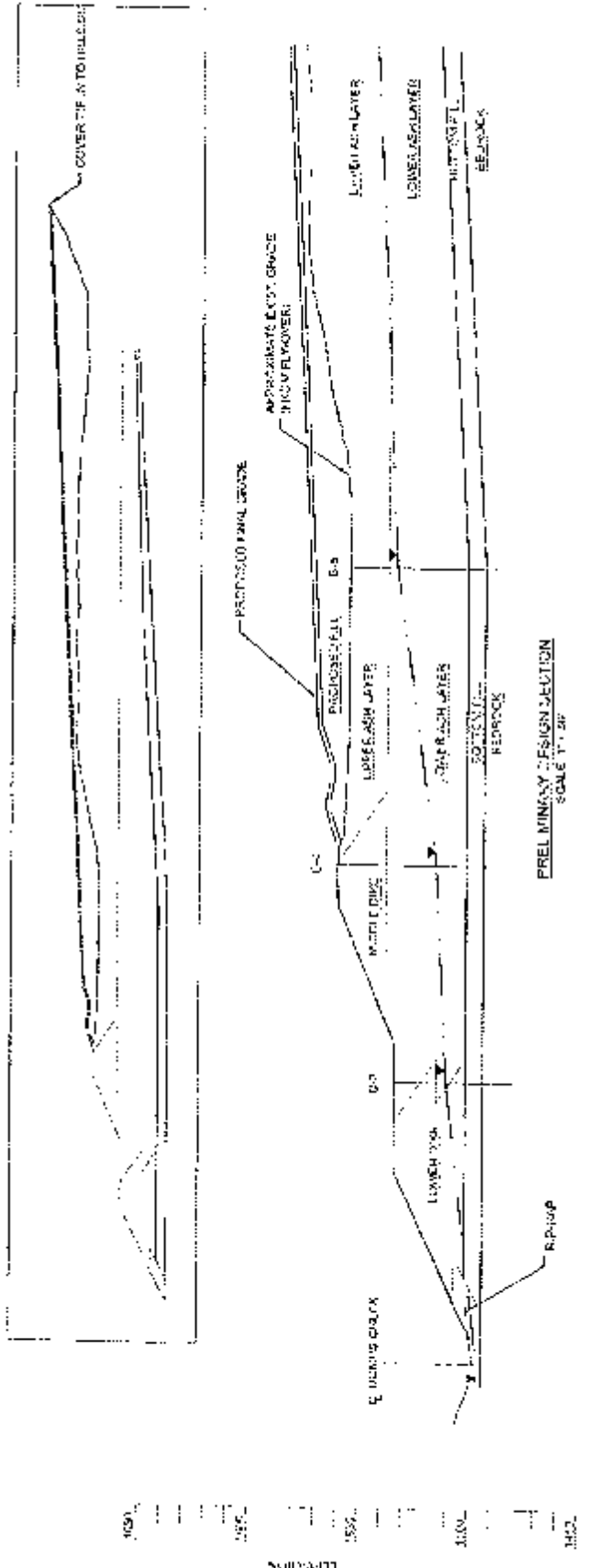

**DESIGN CROSS SECTION**

|   |                   |
|---|-------------------|
| March River Power Plant<br>Pond No. 2 Closure<br>Const. Map No. |                   |
| Project: CT-11-07-001   | Sheet No. MTR     |
| Drawing No. B-11-023  | Accession No. JOK |
| File Number: 8462008  | Scale: 1" = 20'   |

**BECM**  
 BECHTEL CORPORATION  
 500 MARKET STREET  
 BERKELEY, CA 94710  
 (415) 848-7000

DATE



By: MTR  
Date: 9-9-03

**Clinch River Power Plant  
Ash Pond No. 2 Closure**

**Middle Dike**

- Static Stability Analysis of Final Slopes
- Deep Seated, Circular Failure Surface
- Drained Shear Strengths

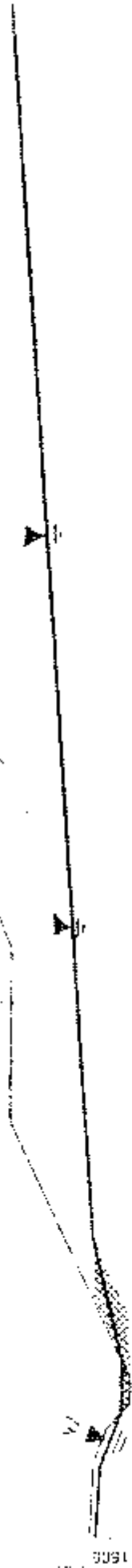
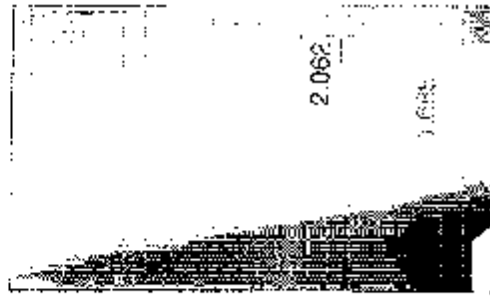
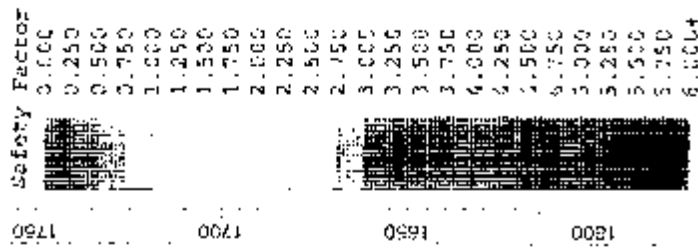

| Layer | Material          | $\gamma_m$<br>pcf | $\phi'$<br>pcf | $\psi'$<br>degrees |
|-------|-------------------|-------------------|----------------|--------------------|
| 1     | Proposed Ash Fill | 100               | 0              | 37                 |
| 2     | Upper Ash Layer   | 103               | 0              | 27                 |
| 3     | Lower Ash Layer   | 82                | 0              | 30                 |
| 4     | Clay/Shale Dikes  | 134               | 100            | 32                 |
| 5     | Bottom Fill       | 128               | 0              | 28.5               |
| 6     |                   | 125               | 0              | 35                 |

Method: Spencer  
Scale: 1" = 50'

By: MTR  
Date: 9-4-08

**Clinch River Power Plant  
Ash Pond No. 2 Closure**

**-Static Stability Analysis of Final Slopes  
-Deep Seated Transitional Failure Surface  
-Drained Shear Strengths**

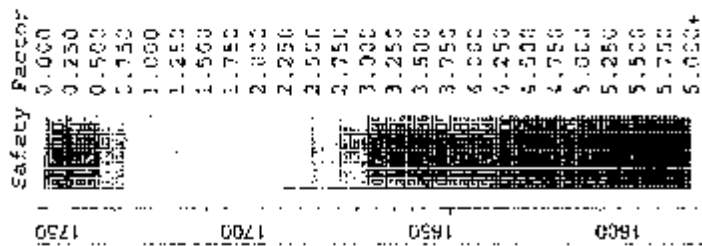

2.75

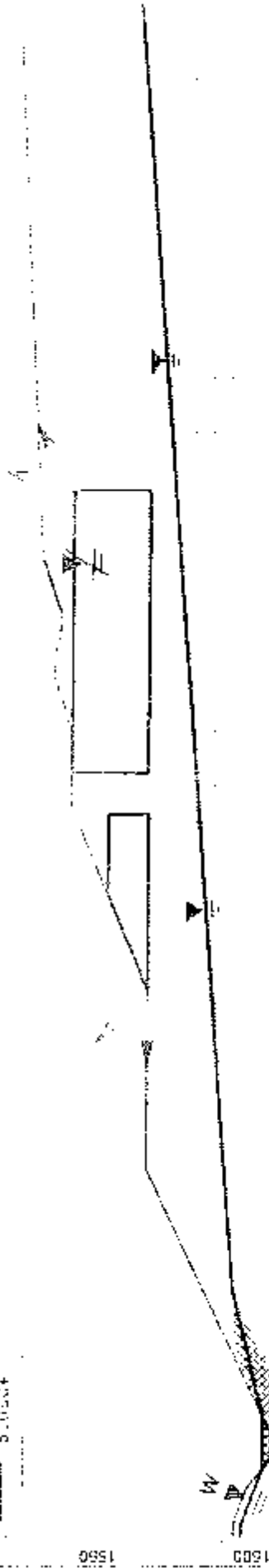

| Layer | Material          | $V_m$<br>pcf | $c'$<br>psf | $\phi'$<br>degrees |
|-------|-------------------|--------------|-------------|--------------------|
| 1     | Proposed Ash Fill | 100          | 0           | 32                 |
| 2     | Upper Ash Layer   | 101          | 0           | 27                 |
| 3     | Lower Ash Layer   | 92           | 0           | 30                 |
| 4     | Clay/Shale Dikes  | 134          | 100         | 32                 |
| 5     | Bottom Fill       | 129          | 0           | 28.5               |
| 6     | Bottom Fill       | 125          | 0           | 35                 |

Method: Spencer  
Scale: 1" = 50'

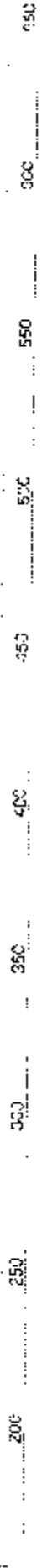

By: MTF  
Date: 5-4-02

**Clinch River Power Plant  
Ash Pond No. 2 Closure**

- Static Stability Analysis of Final Slopes
- Design Sealed Transitional Failure Surface
- Determined Shear Strengths

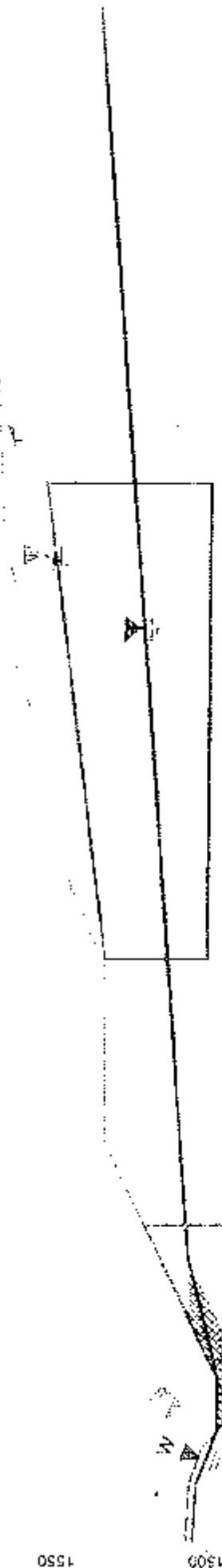
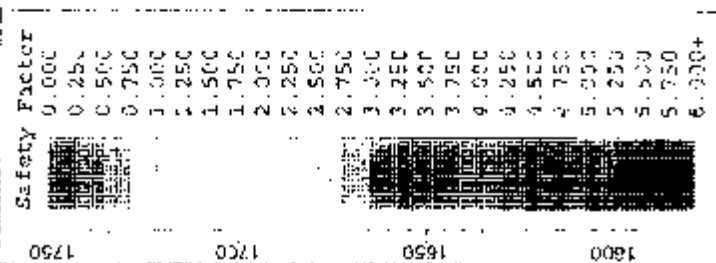

| Layer | Material          | $\gamma_m$<br>pcf | $c'$<br>psf | $\phi'$<br>degrees |
|-------|-------------------|-------------------|-------------|--------------------|
| 1     | Proposed Ash Fill | 100               | 0           | 32                 |
| 2     | Upper Ash Layer   | 101               | 0           | 27                 |
| 3     | Lower Ash Layer   | 92                | 0           | 30                 |
| 4     | Clay/Slate Dikes  | 134               | 100         | 32                 |
| 5     | Bottom Fill       | 125               | 0           | 28.5               |
| 6     | Original Ground   | 125               | 0           | 35                 |

Method: Spencer  
Scale: 1" = 50'





By: MTR  
Date: 9-4-08

4-6-1074  
Title

Clinch River Power Plant  
Ash Pond No. 2 Closure

- Pseudo-Static Stability Analysis of Final Slopes
- Deep Seated Circular Failure Surface
- Drained Shear Strengths

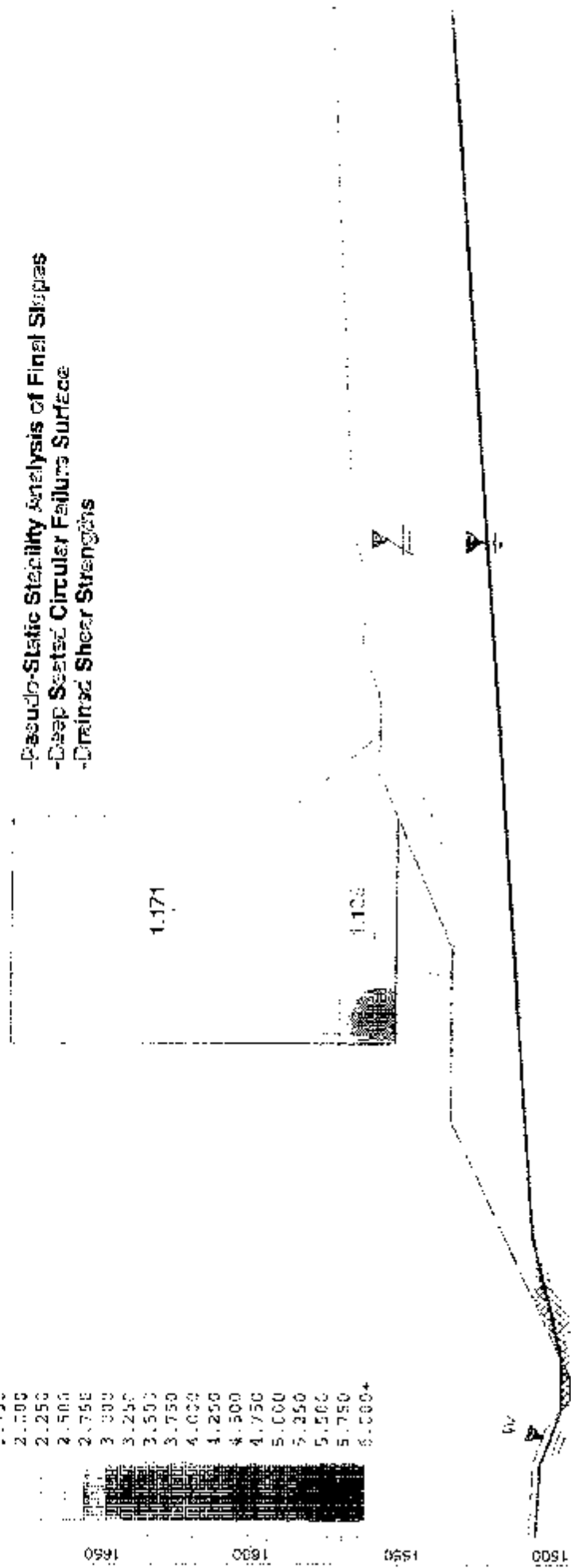

| Layer | Thickness         | $V_m$<br>pcf | $c'$<br>psf | $\phi'$<br>degrees |
|-------|-------------------|--------------|-------------|--------------------|
| 1     | Proposed Ash Fill | 100          | 0           | 32                 |
| 2     | Upper Ash Layer   | 101          | 0           | 27                 |
| 3     | Lower Ash Layer   | 92           | 0           | 30                 |
| 4     | Clay/Shale Dikes  | 134          | 100         | 32                 |
| 5     | Bottom Fill       | 125          | 0           | 28.5               |
| 6     | Bottom Fill       | 125          | 0           | 35                 |

Method: Spencer  
Scale: 1" = 50'  
File Name: Pond 2 - Seismic Un drained.sli

FROM REP 1990 STABILITY ANALYSIS  
SUMMARY OF RESULTS  
POND 2

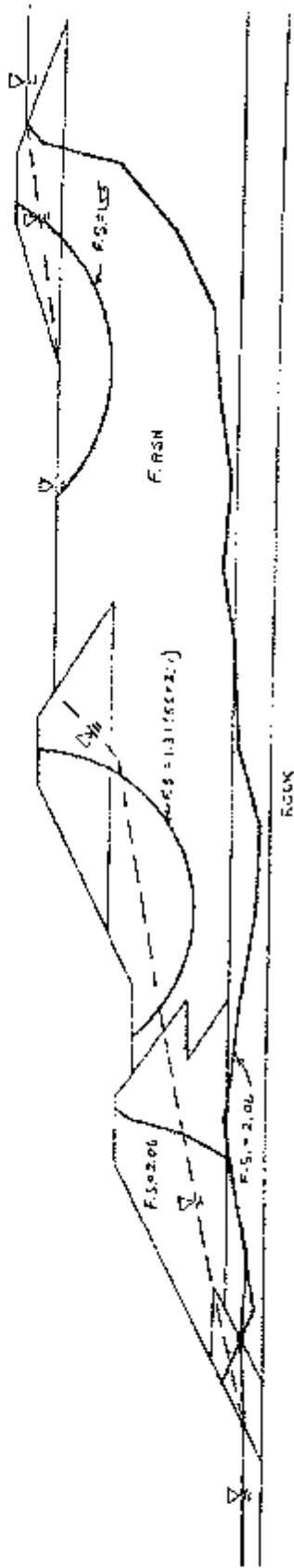

| CASE | DESCRIPTION     | F.S. |
|------|-----------------|------|
| EA   | LOWER DIKE      | 2.06 |
| EB   | MIDDLE DIKE     | 1.31 |
| EC   | UPPER DIKE      | 1.57 |
| ED   | CENTRAINE DIKES | 2.06 |

SUMMARY FIGURE I

**APPENDIX C: Settlement Analysis**

**Foundation Settlement Calculations**

- Compute settlement of foundation (ponded ash) under surcharge of proposed fill and cover.
- Program: Foundation Stress and Settlement Analysis (FoSSA) Version 2.0
- Model fly ash as consolidation response
- Find maximum settlement of ash foundation under proposed fill – two areas on design cross section with deep fills.

**Design Parameters**

| <i>Material Description</i> | <i><math>\gamma_{wet}</math> (pcf)</i> | <i>Poisson's Ratio <math>\nu</math></i> | <i>Compression Index, <math>c_c</math></i> | <i>Recompression index, <math>c_r</math></i> | <i>Void Ratio <math>e_s</math></i> |
|-----------------------------|--|---|--|--|------------------------------------|
| Upper Ash Layer             | 101                                    | 0.5                                     | 0.20                                       | .03  | 0.8                                |
| Lower Ash Layer             | 92                                     | 0.5                                     | 0.15                                       | .03  | 0.8                                |

\*All other layers assumed incompressible

The above values are based on typical values for fly ash placed in very-loose to loose conditions.

Two areas on the design cross section to be analyzed for maximum foundation settlements. These sections correspond to x-values ranging from 100 to 240 and from 693 to 763 in the FoSSA program.

NOV 1987  
CLARK ROAD & CROSS  
SEMINOLE MEMPHIS  
BOSMA MODEL

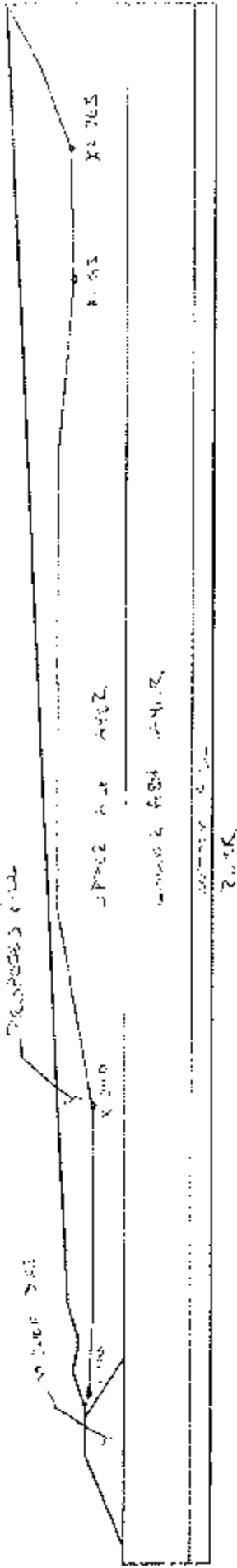





# Clinch River Power Plant - Pond 2 Closure

Report created by FoSSA(2.0): Copyright (c) 2003-2007, ADAMA Engineering, Inc.

### SUBJECT IDENTIFICATION

Title: Clinch River Power Plant - Pond 2 Closure  
 Project Number: 011-11497 - 007  
 Client: AEP  
 Designer: MTR  
 Station Number:

### Descriptions:

#### Company's Information:

Name: BBGM  
 Street:  
 Telephone #:  
 Fax #:  
 E-Mail:

Original file path and name: G:\Columbu... \calculations\Settlement\011-11497-007 Section 1.251  
 Original date and time of creating this file: Fri Sep 19 11:32:36 2008

GEOMETRY: Analysis of a 2D geometry

US EPA ARCHIVE DOCUMENT

INPUT DATA -- FOUNDATION LAYERS -- 5 layers

|   | Wet Unit Weight, $\gamma$<br>[lb/ft <sup>3</sup> ] | Poisson's Ratio $\mu$ | Description of Soil  |
|---|--|-----------------------|----------------------|
| 1 | 101.00   | 0.50                  | Upper Ash Pond Layer |
| 2 | 134.00   | 0.30                  | Exist. Clay Dike     |
| 3 | 92.00  | 0.50                  | Lower Ash Pond Layer |
| 4 | 129.00   | 0.30                  | Bottom Fill          |
| 5 | 140.00   | 0.30                  | Rock                 |

INPUT DATA -- ENHANCEMENT LAYERS -- 1 layers

|   | Wet Unit Weight, $\gamma$<br>[lb/ft <sup>3</sup> ] | Description of Soil    |
|---|--|------------------------|
| 1 | 100.00   | New Ash Fill and Cover |

INPUT DATA OF WATER

| Point # | Elevations (X, Z) : |                |
|---------|---------------------|----------------|
|         | (X)<br>[ ft. ]      | (Z)<br>[ ft. ] |
| 1       | 0.00                | 1512.00        |
| 2       | 75.00               | 1515.00        |
| 3       | 212.00              | 1534.00        |
| 4       | 900.00              | 1534.00        |
| 5       | 1000.00             | 1534.00        |

US EPA ARCHIVE DOCUMENT

INPUT DATA FOR CONSOLIDATION --  $\alpha = 1/2$

| Layer #                                 | OCR     | Cc   | Cr   | e0   | Cv                     | Drains at: |            |
|---|---------|------|------|------|------------------------|------------|------------|
| Undergoing<br>Consolidation<br>[Yes/No] | Pc / Po |      |      |      | [ft <sup>2</sup> /day] |            |            |
| 1                                       | Yes     | 1.00 | 0.20 | 0.03 | 0.80                   | 1.0000     | Top & Bot. |
| 2                                       | No      | N/A  | N/A  | N/A  | N/A                    | N/A        | N/A        |
| 3                                       | Yes     | 1.00 | 0.15 | 0.03 | 0.80                   | 1.0000     | Top & Bot. |
| 4                                       | No      | N/A  | N/A  | N/A  | N/A                    | N/A        | N/A        |
| 5                                       | No      | N/A  | N/A  | N/A  | N/A                    | N/A        | N/A        |

**ULTIMATE SETTLEMENT, Sc**

| Node # | X [ ft.] | Y [ ft.] | Original Z [ ft.] | Settlement Sc [ ft.] | Final Z* [ ft.] |
|--------|----------|----------|-------------------|----------------------|-----------------|
| 1      | 100.00   | 0.00     | 1557.59           | 0.76                 | 1556.83         |
| 2      | 115.57   | 0.00     | 1556.87           | 1.01                 | 1555.86         |
| 3      | 131.11   | 0.00     | 1556.16           | 1.23                 | 1554.92         |
| 4      | 146.67   | 0.00     | 1556.00           | 1.45                 | 1554.55         |
| 5      | 162.22   | 0.00     | 1556.00           | 1.54                 | 1554.46         |
| 6      | 177.78   | 0.00     | 1556.00           | 1.62                 | 1554.38         |
| 7      | 193.33   | 0.00     | 1556.00           | 1.69                 | 1554.31         |
| 8      | 208.89   | 0.00     | 1556.00           | 1.75                 | 1554.25         |
| 9      | 224.44   | 0.00     | 1556.00           | 1.80                 | 1554.20         |
| 10     | 240.00   | 0.00     | 1556.00           | 1.81                 | 1554.19         |

\*Note: Final Z is calculated assuming only 'Ultimate Settlement' exists.

US EPA ARCHIVE DOCUMENT

**ULTIMATE SETTLEMENT, Sc**

| Node # | X [ft.] | Y [ft.] | Original Z [ft.] | Settlement Sc [ft.] | Final Z.* [ft.] |
|--------|---------|---------|------------------|---------------------|-----------------|
| 1      | 693.00  | 0.00    | 1569.00          | 2.62                | 1565.38         |
| 2      | 703.00  | 0.00    | 1568.29          | 2.65                | 1565.64         |
| 3      | 713.00  | 0.00    | 1568.57          | 2.67                | 1565.91         |
| 4      | 723.00  | 0.00    | 1568.86          | 2.68                | 1566.18         |
| 5      | 733.00  | 0.00    | 1569.14          | 2.69                | 1566.45         |
| 6      | 743.00  | 0.00    | 1569.43          | 2.70                | 1566.73         |
| 7      | 753.00  | 0.00    | 1569.71          | 2.69                | 1567.02         |
| 8      | 763.00  | 0.00    | 1570.00          | 2.66                | 1567.34         |

\*Note: Final Z is calculated assuming only 'Ultimate Settlement' exists.

US EPA ARCHIVE DOCUMENT

**TABLED GEOTECHNICAL INPUT OF FOUNDATION SOILS**

| Found. Soil # | Point # | Coordinates (X, Z): |             | DESCRIPTION          |
|---------------|---------|---------------------|-------------|----------------------|
|               |         | (X) [ ft. ]         | (Z) [ ft. ] |                      |
| 1             | 1       | 9.70                | 1539.20     | Upper Ash Pond Layer |
|               | 2       | 59.40               | 1560.10     |                      |
|               | 3       | 79.40               | 1560.10     |                      |
|               | 4       | 84.00               | 1560.00     |                      |
|               | 5       | 91.00               | 1558.00     |                      |
|               | 6       | 134.50              | 1556.00     |                      |
|               | 7       | 245.00              | 1556.00     |                      |
|               | 8       | 352.00              | 1575.00     |                      |
|               | 9       | 597.00              | 1576.00     |                      |
|               | 10      | 593.00              | 1568.00     |                      |
|               | 11      | 763.00              | 1570.00     |                      |
|               | 12      | 807.00              | 1587.00     |                      |
|               | 13      | 840.70              | 1615.00     |                      |
| 2             | 1       | 9.70                | 1539.10     | Exist. Clay Lake     |
|               | 2       | 59.40               | 1560.00     |                      |
|               | 3       | 79.40               | 1560.00     |                      |
|               | 4       | 113.00              | 1539.10     |                      |
|               | 5       | 840.00              | 1539.10     |                      |
| 3             | 1       | 0.00                | 1539.00     | Lower Ash Pond Layer |
|               | 2       | 840.00              | 1539.00     |                      |
| 4             | 1       | 0.00                | 1503.00     | Bottom Fill          |
|               | 2       | 840.00              | 1503.00     |                      |
| 5             | 1       | 0.00                | 1494.00     | Rock                 |
|               | 2       | 840.00              | 1494.00     |                      |

US EPA ARCHIVE DOCUMENT

**TABULATED GEOMETRY: INPUT OF EMBANKMENT SOILS**

| Embank.<br>Soil<br># | Point<br>#        | Coordinates (X, Z) |             | DESCRIPTION            |         |
|----------------------|-------------------|--------------------|-------------|------------------------|---------|
|                      |                   | (X)<br>[ft]        | (Z)<br>[ft] |                        |         |
| 1                    | X1 = 84.00 [ft]   | 102.10             | 1566.00     | New Ash Fill and Cover |         |
|                      | X2 = 1605.00 [ft] | 2                  | 107.10      |                        | 1566.00 |
|                      |                   | 3                  | 117.00      |                        | 1566.00 |
|                      |                   | 4                  | 122.66      |                        | 1564.00 |
|                      |                   | 5                  | 140.60      |                        | 1570.00 |
|                      |                   | 6                  | 160.00      |                        | 1605.00 |

US EPA ARCHIVE DOCUMENT

---

**Summary Report**

**Construction of Cutoff Wall  
Ash Pond 1A and 1B Dikes  
Clinch River Plant  
Carbo, Virginia**

Prepared for:

**American Electric Power Service Corporation**

1 Riverside Plaza  
Columbus, Ohio 43215

December 1991

90C4140

Prepared by:

**Woodward – Clyde Consultants**

201 Willowbrook Boulevard  
Wayne, New Jersey 07470

---



201 Willowbrook Boulevard  
P.O. Box 290  
Wayne, NJ 07470  
201 765-0700  
212 926-2878  
Fax 201-765-0023

## Woodward-Clyde Consultants

January 29, 1992

American Electric Power Service Corporation  
1 Riverside Plaza  
Columbus, OH 43215

Attn: Mr. Harald Jacobsen, Section Manager  
Geotechnical Engineering Section  
Civil Engineering Division

Re: Final Summary Report  
Construction of Cutoff Walls  
Ash Pond 1A and 1B Dikes  
Clinch River Plant  
Carbo, Virginia

Gentlemen:

Woodward-Clyde Consultants is pleased to submit herewith five copies of the above-referenced report.

We appreciate the opportunity to assist you on this interesting project. Please contact us if you have any questions.

Very truly yours,

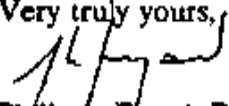
  
Philippe Fayad, P.E.  
Project Engineer

  
Majed A. Khoury, P.E.  
Senior Associate

PF:MAK:am

cc: Michael Damian

mds\90C4140\d001ltr.w51

Consulting Engineers, Geologists  
and Environmental Scientists  
Offices in Other Principal Cities



AEPCR000121

---

**Summary Report**

**Construction of Cutoff Wall  
Ash Pond 1A and 1B Dikes  
Clinch River Plant  
Carbo, Virginia**

Prepared for:

**American Electric Power Service Corporation**

1 Riverside Plaza  
Columbus, Ohio 43215

December 1991

90C4140

Prepared by:

**Woodward – Clyde Consultants**

201 Willowbrook Boulevard  
Wayne, New Jersey 07470

---

## TABLE OF CONTENTS

---

| <u>Section</u>                                     | <u>Page</u> |
|--|-------------|
| EXECUTIVE SUMMARY                                  | ES-1        |
| 1.0 INTRODUCTION                                   | 1-1         |
| 1.1 GENERAL  | 1-1         |
| 1.2 PROJECT DESCRIPTION                            | 1-1         |
| 1.3 BACKGROUND                                     | 1-2         |
| 1.4 SCOPE OF WORK                                  | 1-3         |
| 2.0 DESIGN CONSIDERATIONS                          | 2-1         |
| 2.1 SUBSURFACE CONDITIONS                          | 2-1         |
| 2.2 PIEZOMETRIC CONDITIONS PRIOR<br>TO CUTOFF WALL | 2-2         |
| 2.3 CUTOFF WALL DESIGN                             | 2-3         |
| 2.3.1 Geometry                                     | 2-3         |
| 2.3.2 Backfill Design Mix                          | 2-3         |
| 3.0 CONSTRUCTION OBSERVATIONS                      | 3-1         |
| 3.1 GENERAL  | 3-1         |
| 3.2 SITE ORGANIZATION                              | 3-1         |
| 3.3 MIXING OF SLURRY                               | 3-2         |
| 3.3.1 Mixing Equipment                             | 3-2         |
| 3.3.2 Mixing Sequence                              | 3-3         |
| 3.3.3 Field Trial Mix                              | 3-3         |

## TABLE OF CONTENTS (Continued)

|   | <u>Page</u> |
|---|-------------|
| 3.4 EXCAVATION                              | 3-4         |
| 3.5 CONSTRUCTION OF CUTOFF WALL CAP         | 3-5         |
| 4.0 QUALITY CONTROL TESTING                 | 4-1         |
| 4.1 GENERAL                                 | 4-1         |
| 4.2 ALIGNMENT                               | 4-1         |
| 4.3 DEPTH                                   | 4-2         |
| 4.4 BENTONITE-WATER SLURRY TESTING          | 4-2         |
| 4.5 CEMENT-BENTONITE-FLY ASH SLURRY TESTING | 4-3         |
| 5.0 POST CONSTRUCTION OBSERVATIONS          | 5-1         |
| 5.1 GENERAL                                 | 5-1         |
| 5.2 GROUNDWATER LEVEL MEASUREMENTS          | 5-1         |
| 5.3 SEEPAGE OBSERVATIONS                    | 5-3         |
| 5.4 EVALUATION OF POST-CONSTRUCTION DATA    | 5-5         |
| 6.0 CONCLUSIONS AND RECOMMENDATIONS         | 6-1         |
| 6.1 CONCLUSIONS                             | 6-1         |
| 6.2 RECOMMENDATIONS                         | 6-2         |

### LIST OF APPENDICES

|            |   |
|------------|---|
| APPENDIX A | WCC CORRESPONDENCE                                    |
| APPENDIX B | CONTRACT DOCUMENTS                                    |
| APPENDIX C | DAILY INSPECTION REPORTS BY AEP                       |
| APPENDIX D | RESULTS OF PRECONSTRUCTION LABORATORY TESTING PROGRAM |

## TABLE OF CONTENTS (Continued)

---

### LIST OF TABLES

|         |  |
|---------|--|
| TABLE 1 | SLURRY TRENCH DEPTH  |
| TABLE 2 | SUMMARY OF TEST RESULTS - BENTONITE-WATER SLURRY               |
| TABLE 3 | SUMMARY OF TEST RESULTS - CEMENT-BENTONITE-FLY ASH<br>BACKFILL |
| TABLE 4 | SUMMARY OF WATER LEVEL MEASUREMENTS                            |
| TABLE 5 | RESULTS OF PIEZOMETER FLUSHING OPERATIONS                      |

### LIST OF FIGURES

|           |   |
|-----------|---|
| FIGURE 1  | SITE LOCATION PLAN  |
| FIGURE 2  | PLAN AND SECTIONS   |
| FIGURE 3  | GENERALIZED SUBSURFACE CROSS-SECTION A-A'                                       |
| FIGURE 4  | MIXING PLANT SET UP   |
| FIGURE 5  | POND 1-A PIEZOMETRIC ELEVATIONS - COMPLETE<br>HYDROGRAPH                        |
| FIGURE 6  | POND 1-A PIEZOMETRIC ELEVATIONS - RECENT DATA                                   |
| FIGURE 7  | POND 1-A PIEZOMETRIC ELEVATIONS - COMPLETE<br>HYDROGRAPH FOR CROSS-SECTION B-B' |
| FIGURE 8  | POND 1-A PIEZOMETRIC ELEVATIONS - RECENT DATA FOR<br>CROSS-SECTION B-B'         |
| FIGURE 9  | POND 1-B PIEZOMETRIC ELEVATIONS - COMPLETE<br>HYDROGRAPH                        |
| FIGURE 10 | POND 1-B PIEZOMETRIC ELEVATIONS - RECENT DATA                                   |
| FIGURE 11 | POND 1-B PIEZOMETRIC ELEVATIONS - COMPLETE<br>HYDROGRAPH FOR CROSS-SECTION C-C' |
| FIGURE 12 | POND 1-B PIEZOMETRIC ELEVATIONS - RECENT DATA FOR<br>CROSS-SECTION C-C'         |

## EXECUTIVE SUMMARY

---

During the period of November through December 1990 a cement-bentonite-fly ash (CBFA) cutoff wall was constructed within the Ash Ponds 1A and 1B dikes at the American Electric Power Service Corporation (AEP) Clinch River Plant located in Carbo, Virginia. The purpose of the cutoff wall was to block potential seepage paths in the dikes and to improve downstream stability. Inquip Corporation (Inquip) constructed the cutoff wall. Inquip was also responsible for implementing a quality control testing program during construction to verify that the cutoff wall was constructed in accordance with the design requirements and the Contract Documents. AEP provided full-time inspection of the Contractor's work. Woodward-Clyde Consultants (WCC) made periodic site visits during construction to observe the Contractor's work. In addition, WCC performed laboratory tests on CBFA slurry samples taken from the trench.

The dikes were previously constructed in four stages following the upstream construction method. The first stage corresponds to the original embankment which consisted of silty clay with shale and sandstone fragments. The second stage construction materials consisted of fly ash and bottom ash. The remaining stages were essentially constructed of the same material as the original material in the dikes. The cutoff wall was a minimum 30 in. wide and approximately 2,150 ft long. The cutoff wall was generally 65 ft deep and keyed into the original embankment except at both abutments where it keyed 1 ft to 2 ft into the shallow fractured bedrock.

Based on our review of the quality control field and laboratory test results, the daily inspection reports by AEP, and our visual observations of the dikes after construction of the cutoff wall, we conclude the following:

1. The cutoff wall was constructed in accordance with the intent of the design and generally to the locations and grades shown in the Contract Documents.
2. Laboratory tests on CBFA samples from the cutoff wall indicated a permeability of less than or equal to  $5 \times 10^{-6}$  cm/sec as required in the Contract Documents.

3. The piezometric levels upstream of the cutoff wall have increased after construction of the cutoff wall when compared to levels prior to construction. Also, a general piezometric drop is noticed across the cutoff wall.
4. There are no indications of significant underseepage beneath the cutoff wall.
5. The cutoff wall has been successful in intercepting most of the pervious seams in the embankment as evidenced by bare and dry calcified soil spots on the downstream face of the dikes.
6. The cutoff wall has also been successful in reducing seepage along the downstream face and toe of the dikes as evidenced by the reduced flow rates measured at the flow weirs. Post-construction seepage at the toe is clear and internal soil erosion was not observed. However, a boil area was noticed at the downstream toe of Dike 1A near Piezometer P-2 with clear water flowing without noticeable signs of internal soil erosion. The observed seepage does not appear to threaten the stability of the dikes.

Based on our conclusions related to the construction of the cutoff wall, we recommend the following:

1. AEP should continue to monitor the seepage at the downstream toe of the dikes, and two additional flow weirs should be installed.
2. Six observation wells should be installed in the downstream shells of the dikes. Monitoring the existing observation wells should continue on a monthly basis when the ponds are in service to confirm the effectiveness of the cutoff wall and to evaluate potential sources of post-construction seepage. A pair of piezometers should also be installed at the observed boil area location to understand the source of the observed seepage.
3. All downstream benches should be graded and drainage swales should be cleared of all vegetation and sediments. The objective is to enhance drainage patterns and to enhance seepage detection and evaluation.

4. The grass and vegetation cover observed on the downstream face of the dike should be mowed and the few small trees should be cut. The objective is to enhance inspection of the slopes, to allow a better evaluation of seepage patterns, and to prevent damage to the slope from tree roots.



## 1.1 GENERAL

This report describes the design and construction aspects of a cement-bentonite-fly ash (CBFA) cutoff wall within the Ash Pond 1A and 1B dikes at Appalachian Electric Power Service Company (AEP) Clinch River Plant located in Carbo, Virginia. A summary of piezometer measurements prior to and after construction of the cutoff wall is presented. Woodward-Clyde Consultants (WCC) also performed laboratory tests on materials used in the construction of the cutoff wall to verify the permeability of the CBFA backfill mix.

The evaluations presented herein are based on periodic site visits by WCC during construction to verify that the contractor's work was in accordance with the contract documents and the design concepts. Personnel from American Electric Power Service Corporation (AEP) provided full-time inspection during construction. Inquip Associates, Inc. of McLean, Virginia was the cutoff wall contractor. WCC's work was authorized by AEP's service order No. B-6955.

## 1.2 PROJECT DESCRIPTION

The Clinch River Plant is located off of Route 664, approximately 10 miles west of Lebanon, Virginia. Ash Ponds 1A and 1B are located at the intersection of Dumps Creek and Clinch River. A site location map is shown in Figure 1.

Ash Ponds 1A and 1B form a roughly triangular impoundment created by constructing a main dike as one side of the triangle with higher ground forming the remaining two sides of the triangle (See Figure 2). The crest of the 55-ft high main dike is currently at about el. 1,570 ft. This dike is about 2,000 ft long with an approximately 50-ft wide crest at Ash Pond 1A and an approximately 35-ft wide crest at Ash Pond 1B. A splitter dike separates Ash Pond 1A from Ash Pond 1B.

The dikes were originally constructed around 1955 to 1956 and have been raised following the upstream construction method. As seen on Figure 2, this method consists

of maintaining the downstream alignment of the dikes while raising the embankments in the upstream direction. Part of the addition of the dikes rested on the sedimented ash. The dikes were raised three times over a period of eight years with the latest construction to el. 1,570 ft completed in 1971. Although some of the dike extensions are shown in Figure 2 to have been constructed in the downstream direction, most of the extensions were in the upstream direction.

The typical cross-sections through Pond 1A and 1B dikes shown on Figure 2 have been inferred from AEP drawing No. 13-10585-3107-4 dated September 19, 1969 and revised in November 21, 1973 (4th revision). The elevation of the base of the dike has been corrected to reflect our best estimate of the original ground surface elevation (i.e. el. 1,500 ft). The original ground elevation shown at el. 1,515 ft in AEP drawing No. 13-10585-3107-4 contradicts other AEP documents and subsurface information described in Section 2.1. Also, downstream grading has been altered from the original drawings to reflect actual site conditions.

It appears that construction of the dikes necessitated the relocation of Dumps Creek. Documents provided by AEP indicate that the original bed of Dumps Creek passed beneath the Pond 1A dike.

Operating pool elevations at Pond 1A and 1B are el. 1,565 ft and el. 1,558 ft, respectively. Water level in Pond 1A is maintained by a 30-in. diameter spillway connected to Pond 1B. A 36-in. diameter pipe in Pond 1B carries the overflow to a catch basin at the toe of the dike, from which it flows by gravity to the recirculation pond through a 30-in. diameter reinforced concrete pipe (RCP).

### 1.3 BACKGROUND

Ponds 1A and 1B have had a history of obvious seepage at the downstream toe of the dikes since before WCC initial inspection in 1978. Toe drains, consisting of 10-in. diameter perforated pipe encased in a gravel backfill, have been installed along the toe of the dikes. Water flowing to the toe drains is collected in a sump and pumped into the 30-in. diameter RCP which carries the pond overflow to the recirculation pond.

Despite the toe drains, seepage was still occurring and a boil area was noted in 1975 near the downstream toe of Pond 1B. Small inverted filter blankets were constructed during the following years until 1984 when a larger inverted blanket (still noticeable) was placed over the general seepage area. Several seeps were also observed at the downstream toe of the Pond 1A dike and were reported in the various WCC inspection reports.

In response to the recommendations of the Virginia State Water Control Board and the recommendations in WCC inspection report dated May 1984, AEP performed a stability analysis of the dikes. A report summarizing the stability analyses was prepared by AEP in January 1990. The report concluded that the stability of the Pond 1A and 1B dikes was not adequate because of the high pore pressures measured in the embankment. The report recommended improving the stability of the dikes by lowering the phreatic surface in the downstream shells of the dikes by one of the following methods:

- 1- Impervious upstream core and upstream surface blanket,
- 2- Free draining downstream surcharge berm, or
- 3- Vertical seepage cutoff barrier.

AEP recommended implementing the third method by means of the slurry trench seepage cutoff method.

#### 1.4 SCOPE OF WORK

AEP retained WCC to review AEP design concept, to finalize the design of a cutoff wall, to provide input to the contract documents developed for construction of the cutoff wall, and to provide periodic construction monitoring. These tasks were detailed in WCC's letter proposal dated May 17, 1990. Our activities with respect to these tasks are summarized below:

##### Task 1: Review of AEP Design Concept

WCC reviewed the available data provided by AEP and assessed the appropriateness and feasibility of a cutoff wall for controlling seepage and for

improving the stability of the dikes. A letter report dated July 12, 1990 summarizes our activities and conclusions relative to this task. A field investigation program consisting of borings and piezometers was recommended in a WCC letter dated July 13, 1990. These referenced letters are included in Appendix A.

#### Task 2: Design of Cutoff Wall

The additional information provided by the new borings and piezometers was reviewed and recommendations related to the design of the cutoff wall were presented by WCC in a letter dated September 24, 1990. This letter is also included in Appendix A.

#### Task 3: Cutoff Wall Input to Contract Documents

WCC's written input was not requested during this task. However, several telephone conversations took place between Messrs. Mike Damian of AEP and Majed Khoury and Philippe Fayad of WCC to discuss key issues associated with the contract documents. These contract documents are included in Appendix B.

#### Task 4: Construction Monitoring

Cutoff wall construction started on November 19, 1990 and was completed on December 19, 1990. A two-day site visit was conducted by Messrs. Philippe Fayad and Paul Dutko of WCC on November 15 and 16, 1990 before the start of construction. Two site visits were then conducted during construction by Messrs. Fayad and Dutko on November 27 and 28, 1990 and December 11, 1990, respectively. Personnel from AEP monitored the construction of the cutoff wall on a full-time basis and performed quality assurance testing. AEP daily inspection reports are included in Appendix C.

## 2.1 SUBSURFACE CONDITIONS

Subsurface conditions along the dikes of Pond 1A and 1B were summarized in the WCC letter dated September 24, 1990 (Appendix A) following the drilling of new borings mainly along the dike centerline. Grain-size analyses and Atterberg Limit tests were performed on selected representative soil samples. A soil profile along the axis of the dikes is presented in Figure 3 showing the approximate locations of the three material "zones" identified and described below:

### Zone 1: Embankment Material

Zone 1 includes two material sub-zones:

- Zone 1a. Fill material consisting of silty CLAY with gravel or sand-size shale and sandstone fragments and occasional boulders.
- Zone 1b. Fill material consisting of fly ash or bottom ash with sand-size coal fragments.

### Zone 2: Overburden

Zone 2 material includes soil encountered below the original ground surface and over the bedrock. The soil in Zone 2 consists of silty CLAY with gravel or sand-size shale and sandstone fragments and occasional sand seams or inclusions.

### Zone 3: Bedrock

Bedrock is encountered on average at about 10 ft below the original ground surface (estimated at el 1,500 ft). In general, the rock is highly fractured (RQD\* = 0%) except for two borings where RQD ranged between 42% and 77%. The bedrock consists of shale, limestone, dolomite, and sandstone.

### 2.2 PIEZOMETRIC CONDITIONS PRIOR TO CUTOFF WALL

Piezometric information was obtained from observation wells screened through the embankment fill and the bedrock, and from piezometers installed along the downstream toe of the dike near the top of the bedrock. Old observation wells installed in the embankments provided additional information. The location of piezometers and observation wells is shown on Figure 2. A detailed discussion of the piezometric conditions is given in WCC letter dated September 24, 1990 (Appendix A). The following summarizes the major findings:

- The presence of relatively pervious seams was postulated in the later embankments extensions, but not in the original embankment material. These seams were suspected to provide potential flow channels between the pond water and the surface of the downstream slopes.
- The pore pressures in the upper fractured zones of the bedrock appear to respond to the regional groundwater regime as well as to the water levels in the ponds.

It was not possible, based on the available piezometric data, to estimate seepage quantities through either the pervious seams in the embankments or the fractured bedrock.

---

\* RQD corresponds to Rock Quality Designation which is equivalent to the percentage of total length of core pieces, 4-in. or longer, to the total length cored.

## 2.3 CUTOFF WALL DESIGN

### 2.3.1 Geometry

The solution proposed by AEP to mitigate the observed seepage, i.e. constructing a cutoff wall, was believed likely to reduce seepage in the embankments and hence to improve downstream stability. Based on the available subsurface and piezometric conditions, WCC recommended construction of a 65-ft deep cutoff wall terminating (keying) into the original low permeability embankment material. The wall would be 2.5 ft wide and would be constructed with a cement-bentonite-fly ash (CBFA) backfill mix having a permeability equal to or less than  $5 \times 10^{-6}$  cm/sec and a minimum strength of 8 psi at 7 days.

Two pipe crossings exist along the cutoff wall alignment and are shown on Figure 3. An 18-in. diameter transite pipe carries surface run-off from the steeply sloped areas north of Ponds 1A and 1B and discharges into Dumps Creek. This pipe is located at the splitter dike crossing and is buried about 5 ft below the surface. A 36-in. diameter outflow pipe connects the overflow structure in the northwest corner of Pond 1B to the downstream catch basin. The approximate alignment is shown on Figure 2 and the invert is estimated at about cl. 1,498.5 ft, as inferred from AEP drawings No. 12-3434A-2 revised on July 17, 1958 (2nd revision) and No. 12-3032A-4 revised on June 21, 1963 (3rd revision).

### 2.3.2 Backfill Design Mix

A single backfill design mix was developed in WCC's Clifton, New Jersey laboratory using fly ash and Clinch River water provided by AEP. The mix consisted of the following ratios by weight:

|                             |       |
|-----------------------------|-------|
| Bentonite:Water ratio (B/W) | 0.044 |
| Cement:Water ratio (C/W)    | 0.225 |
| Cement:Fly Ash ratio (C/FA) | 1.5   |

Before the contract was awarded, the Contractor proposed an alternate backfill mix that uses a proprietary admixture called Actisol. This admixture allows greater substitution of fly ash for cement and provides a mix that would meet the requirements of permeability and strength presented in the contract documents. Also, the Contractor requested that the acceptance of the cutoff wall be based on the 28-day permeability and strength rather than the 7-day measurements specified in the contract documents. AEP approved this request during the pre-award meeting held on September 9, 1990.

Five different backfill mixes using Actisol admixture were tested in WCC's laboratory using the same bentonite, cement, and water as in the original mix. The retarder was Marasperse C-21 manufactured by Daishowa and was similar to the retarder used during construction of the cutoff wall. The results of preconstruction laboratory testing are provided in Appendix D. The mix selected by the Contractor and approved by AEP corresponds to mix IQ-2 with the following quantity ratios expressed by weight:

|                             |         |
|-----------------------------|---------|
| Bentonite:Water ratio (B/W) | 0.038   |
| Cement:Water ratio (C/W)    | 0.1277  |
| Cement:Fly Ash ratio (C/FA) | 0.694   |
| Actisol:Cement ratio (A/C)  | 0.0699  |
| Retarder:Cement ratio (R/C) | 0.00806 |

These ratios lead to the following design quantities per cubic yard of mix:

|           |           |
|-----------|-----------|
| Bentonite | 56 lbs    |
| Cement    | 189 lbs   |
| Fly Ash   | 272 lbs   |
| Actisol   | 13.2 lbs  |
| Water     | 1,480 lbs |
| Retarder  | 1.5 lbs   |



The above ratios yielded a laboratory CBFA mix with the following characteristics:

| Characteristic                               | Average Slurry Parameter | Curing Time of Hardened Slurry, Days |      |      |      |
|--|--------------------------|--------------------------------------|------|------|------|
|  |                          | 3                                    | 7    | 14   | 28   |
| Marsh Funnel viscosity, sec                  | 34                       |                                      |      |      |      |
| Mud Balance density, pcf                     | 74                       |                                      |      |      |      |
| Flexible-wall permeability, $10^{-6}$ cm/sec | N/A                      | 9.4                                  | 7.0  | 3.4  | 2.7  |
| Unconfined compression, psi                  | N/A                      | 5.1                                  | 11.0 | 22.5 | 26.1 |

The results of the laboratory testing program suggested that the CBFA slurry characteristics (i.e. permeability, strength, etc.) were very sensitive to the amount of bentonite in the mix.

### 3.1 GENERAL

The cutoff wall construction started at the right abutment on Monday, November 19, 1990 and was completed on Wednesday, December 19, 1990. The excavated material was originally stockpiled on the side of the trench, but was trucked to an on-site disposal area designated by AEP. A gravel cap was constructed on top of the completed cutoff wall in January and February 1991. WCC made site visits during construction to review the contractor's operations and AEP monitoring records. AEP's personnel maintained the daily inspection reports as presented in Appendix B.

### 3.2 SITE ORGANIZATION

The contractor had located the mixing plant on the north side of Pond 1A. The plant was composed of two high shear velocity mixing tanks, two 100-ton silos, and one 22 cubic yard averaging tank. A tank temporarily stored bulk cement before it was pumped to one of the silos. Fly ash was shuttled from AEP's power plant located near the site via pneumatic tanker trucks. Bentonite was shipped in bulk to the site by railroad cars where it was shuttled to the site via pneumatic tanker trucks. The proprietary admixture, Actisol was shipped in 50-lb bags. Retarder additive was shipped in 50-lb bags. Water was pumped directly from the Clinch River.

Two ponds were excavated to store bentonite-water (BW) slurry. Dry bentonite and water were mixed at the nozzle of a continuous Venturi tube high shear mixer and BW slurry was discharged into the first pond. The slurry was hydrated overnight and later pumped to the second pond. The slurry was typically mixed at a higher density than that required for the final mix. The density was adjusted by adding water to the slurry at the pump suction intake. Figure 4 presents the general setup of the contractor's operations.

### 3.3 MIXING OF SLURRY

#### 3.3.1 Mixing Equipment

A schematic of Inquip's batch plant is shown in Figure 4. The entire batch plant is automated except for the Actisol admixture and the retarder which are added to the mixer by hand. A hopper is located over each of the two mixers and is suspended to a load cell. The purpose of the load cell is to measure the weight of cement and fly ash added to the hopper. A computerized driving system introduces the preset amounts of cement and fly ash into the hopper. A digital dial indicates at all times, the weight in the hopper. The hook-up, calibration, and programming of the scales were done by Moore Scale Service, Inc. of Stephens City, Virginia, on November 15 and 16, 1990. The load cells were described as to be fully compensated for temperature changes and were rated for 5,000 lbs with a 150 percent overload capacity.

BW slurry is pumped from the hydrated pond into a steel column of known volume. An overflow pipe controls the volume and helps indicating when the column is full. The dimensions of the column were measured by Inquip and indirectly checked by WCC using the known volume of the mixer. The total volume of each mixer was approximately 7.1 cubic yards. However, only about 4.3 cubic yards of material were mixed for each batch.

The CBFA slurry is pumped into an "averaging" tank from which it is pumped to the trench. The purpose of this tank is to average the excavation/backfilling operations. During excavation of the deeper portion of a panel, mixing operations produce slurry faster than the backhoe can excavate the soil, thus storing of the excess slurry in the tank is required. During the excavation of the upper (shallower) part of the panel, the backhoe can excavate soil faster than slurry is produced, thus drawing from the tank the balance of slurry required. The capacity of the "averaging" tank is about 4 to 5 CBFA batches, or approximately 20 cubic yards.

### 3.3.2 Mixing Sequence

The hydrated BW slurry is pumped from the ponds into the steel columns at the mixing plant. Water is added to the pump intake to adjust the viscosity of the slurry to the required value. Once the column is full, as indicated by the overflow pipe, the pump is shut-off and this volume of BW slurry is dropped into the mixing tank. In the meantime, the automated driving system pours into the hopper the predetermined weights of fly ash followed by cement. Retarder is added first to the BW slurry. Fly ash and cement are then introduced while slowly adding the Actisol additive. The CBFA slurry is mixed for about 2 minutes before being pumped to either the trench or to the "averaging" tank.

In general, the automated system performed adequately except for some problems related to the electronic driving system. The built-in programmable time lag closing circuitry, controlling the volume of solids (cement and fly ash) poured in the hopper, tended to overshoot the necessary volumes for each mix. During ideal conditions, the excess material is automatically compensated every few batches. Measurements and cross-check calculations indicated, however, that the correction was not done properly at the end of the day. Up to 6 percent excess fly ash and 2 percent excess cement were calculated at the end of a day.

### 3.3.3 Field Trial Mix

A field trial mix was attempted late in the afternoon of November 16, 1990. Initial density and viscosity testing of the BW slurry indicated that the slurry was richer in bentonite than the design mix. As a result, Inquip circulated the BW slurry in the pond while adding water at the pump intake. These efforts were however only partly successful, and water was added directly to the mixer to achieve the desired slurry characteristics.

It was originally intended to take samples of the CBFA trial mix for permeability and strength testing. However, because of the incorrect amount of material, samples were not taken. Samples were taken during the second day of operation and were shipped to WCC for testing.

### 3.4 EXCAVATION

A hydraulic backhoe, Koehring 1266D with an extended dipper stick (reach of about 75 ft) excavated the trench. Excavation was done in continuous 20-ft to 30-ft long panels. The cutoff wall was constructed as close to the downstream edge of the crest as practically possible, i.e. about 15 ft from the downstream edge. The cutoff wall was a minimum 30 inches wide and approximately 2,150 ft long. The cutoff wall keyed by about 1 ft to 2 ft into the shallow fractured bedrock at both abutments. Excavation and backfill progressed at an average rate of about 5,700 ft<sup>2</sup>/day. The cutoff wall was typically about 65 ft deep and keyed into the old embankment material.

Before excavation started in the morning, standing water on the top of the trench was removed with the bucket of the backhoe. The standing water appeared red-brown in color and was about 9 in. to 18 in. deep after an overnight setting. Every day, the first excavated panel was keyed a minimum of 2 ft into the previous day's hardened backfill to ensure continuity.

Precautions were taken when excavating around the 36-in. diameter pipe. The springline of the pipe was estimated at approximately 68 ft below the top of the dike. The trench above the pipe was, however, excavated to a depth of 60 ft, for a lateral distance of 10 ft on both sides of the estimated pipe centerline.

The 30-in. diameter pipe crossing the trench alignment at the east end of the splitter dike was removed over a distance of about 30 ft as quoted in AEP inspection reports. The pipe was then reinstalled through the hardened CBFA backfill, but no inspection by AEP was provided at the time of these operations. The details of the excavation at the pipe crossing are contained in item 5 of the pre-award minutes of the meeting between AEP and Inquip on 9 September, 1990. These details are included in Appendix B.

The excavated material was generally red-brown silty clay with shale and sandstone fragments. Layers of fly ash and bottom ash were encountered during excavation and were apparently harder to excavate. The original embankment material was generally similar to the majority of the embankment material in the later dike extensions. In some

areas, zones of dry highly fractured shale were encountered as shown in the generalized cross section presented in Figure 3. The locations of these zones are very approximate and are based on AEP's inspection reports and as-built information. Also, some inconsistencies were observed between AEP's inspection reports and the as-built profile provided by AEP. Samples of the key material were taken and stored in ziplock bags. No rock samples were saved from the bedrock keying stratum in the areas close to both dike abutments.

### 3.5 CONSTRUCTION OF CUTOFF WALL CAP

The top of the cutoff wall was capped with clay and gravel as shown in Figure 2. The cap design consisted of excavating the hardened CBFA backfill to a depth of 2 ft below the ground surface, placing and compacting a 6-in. thick layer of clay, placing a Tensor BX1100 (SS1) geogrid, and backfilling the remaining portion with compacted Virginia DOT#21A gravel. The clay was imported from a borrow area located on AEP Power Plant property located about 5 miles from the site. The construction sequence was not observed by WCC and was not reported in AEP's inspection reports. It appeared, however, through verbal communication with AEP that construction of the cap went well.

**QUALITY CONTROL TESTING**

---

**4.1 GENERAL**

Quality Control (QC) of the construction of the cutoff wall was the responsibility of the contractor. The QC program was defined in the contract documents and covered testing of water, bentonite, cement, bentonite-water slurry, cement-bentonite-fly ash slurry, and measuring the depth of the trench. AEP inspectors performed additional quality assurance (QA) tests and participated with the contractor in making his measurements. Results of QC testing performed by AEP were logged daily in the inspection reports and were submitted to WCC at the end of the cutoff wall construction. WCC performed additional testing on the BW and CBFA slurries during the site visits. Laboratory permeability and strength testing was also performed by WCC on samples taken from the trench, on a weekly basis. A summary of all QC testing results is presented in Tables 1 through 3. The following sections provide an overview of the QC tests based on AEP's records supplemented by measurements made by WCC during the two site visits.

**4.2 ALIGNMENT**

The alignment of the cutoff wall was field fit at the top of the dikes by the contractor. The location of the alignment was governed by the following conditions:

- The wall alignment should be located as close as practically possible to the downstream edge of the dikes to maximize the penetration of the wall into the original embankment. Based on the sequence of construction of the embankments, i.e. upstream extension, most of the original embankment material was located downstream of the present centerline of the dikes as shown in the typical cross-section in Figure 2.
- Disturbance to piezometers and observation wells installed at the crest of the dikes should be minimized.

- The radius of curvature of the wall should be maximized along the curved portions of the alignment to facilitate trench excavation.

Work progress along the alignment was controlled by wooden stakes located about 20 ft downstream of the trench centerline along the edge of the crest, and were placed in a non-linear (zig-zag) manner. This control procedure resulted in inaccurate stationing along the cutoff wall. The length of the wall as measured by the control stakes and presented in AEP inspection reports was about 100-ft longer than the length measured along the as-built alignment on Figure 2.

#### 4.3 DEPTH

The depth of the trench was measured every 10 ft by AEP inspectors during construction. Results of depth measurements are summarized on Table 1.

Depth measurements were initially performed with a weighted tape. However, the tape broke a few times because of the high viscosity of the slurry at depth. A second attempt of depth measurements consisted of attaching the tape to the teeth of the bucket. The tape could not, however, be held straight along the boom, thus resulting in erroneous depth measurements.

Depth measurements were then made with a steel rope hooked to a heavy metal rod. Pipe clamps were attached at one-ft intervals to indicate the 65-ft, 66-ft, and 67-ft depth markings. This method provided repeatable depth measurements but was very difficult to operate because of the large combined weight of the rope and the metal rod. Measurements with the steel rope started on November 27, 1990 when the excavation reached about Station 2 + 80.

#### 4.4 BENTONITE-WATER SLURRY TESTING

Bentonite-water (BW) slurry was tested for viscosity, density and temperature several times per day at the mixing plant (BW columns), and at the transfer pump between the storage (hydration) pond and the mixing plant. In the pond, BW was stored at a thicker consistency than needed for the mixing operation but was generally at about a Marsh



Funnel viscosity of 40 sec. A hydrometer was available at the site and was used frequently to evaluate the density of the slurry. A density of 64 pcf measured with the mud balance was equivalent to a specific gravity of 1.024 measured with the hydrometer.

The BW slurry was also tested at the mixing plant. Slurry samples were taken from the transfer columns, shown on Figure 4, before the slurry was dumped into the mixers. The slurry was tested for viscosity, density, and temperature at least once a day, as reported by AEP.

The test results generally indicated that BW slurry had a uniform consistency with a Marsh Funnel viscosity around 32 sec, a Mud Balance density of about 64 pcf and a specific gravity of about 1.024. These results are summarized in Table 1.

#### 4.5 CEMENT-BENTONITE-FLY ASH SLURRY TESTING

Cement-bentonite-fly ash (CBFA) slurry was tested in the mixing tanks for viscosity and density. Samples were taken at one occasion from the mixing tanks for laboratory permeability and strength testing. Samples were taken weekly from the trench and were sent to WCC laboratory for laboratory permeability and strength testing.

The CBFA slurry was tested in the mixing tanks just before it was pumped to the trench. The Mud Balance results indicated that the density was relatively uniform around 74 pcf. The viscosity as measured with the Marsh Funnel was, however, extremely variable and ranged from 31 sec to 95 sec with an average value of about 51 sec. The results are summarized in Table 2. These viscosity results are consistent with visual observations made at the mixing plant. The consistency of the CBFA slurry mix consisting of bentonite, cement, fly ash, Actisol additive and retarder was apparently very sensitive to the BW slurry properties and to the sequence of adding the materials. Mixing problems, including electronic driving system overshoots, pump clogging, poor mixing, and line bursting were reported in AEP's inspection reports and were observed by WCC during the site visits.

The laboratory permeability test results in Table 3 indicate that the hardened CBFA slurry from the trench had a permeability of  $5 \times 10^{-6}$  cm/sec or less at 7 days which meets

the permeability requirements in the Contract Documents. The unconfined compressive strength test results indicate that the hardened CBFA slurry had an unconfined strength greater than 8 psi at 28 days, which meets the acceptance criteria set by AEP at the preaward meeting with Inquip (Appendix B). The Contract Documents required originally that the CBFA slurry has a minimum unconfined compressive strength of 8 psi after 7 days of curing. However, the key issue is that the slurry must be sufficiently hardened to become self-supporting before excavation begins at the adjacent section so that cracks do not form in the partially set slurry. Based on visual observations of the AEP inspectors, the slurry was sufficiently hardened before excavation began at an adjacent panel.

## POST-CONSTRUCTION OBSERVATIONS

---

### 5.1 GENERAL

Ponds 1A and 1B were taken out of service on April 1990 for dewatering and excavation of ash. This was also necessary to allow for the start of construction of the cutoff wall. Refilling of the ponds began in May 1991. Ponds 1A and 1B reached their normal operating levels of el. 1,566 ft and el. 1,558 ft on or about May 10, 1991 and May 21, 1991, respectively. AEP performed daily monitoring of piezometers and observation wells, pool elevations, flow rates at the existing flow weirs, and flow rates at the seepage collection sump between May 6 and July 3, 1991, and then on about a monthly basis thereafter. A summary of water level measurements in observation wells, piezometers, and flow weirs is presented in Table 3.

The purpose of the post-construction observations was to evaluate the effectiveness of the cutoff wall and the performance of the dikes after the refilling of the ponds. The following sections present an evaluation of post-construction observations and monitoring through October 28, 1991.

### 5.2 GROUNDWATER LEVEL MEASUREMENTS

Groundwater levels in the embankments and in the foundations were monitored by two series of observation wells, A- and B-series, and one series of piezometers, P-series. A- and B-series wells consist of a 2-ft long slotted bottom section of PVC connected to a 1.5-in diameter solid PVC riser. The bottom of the wells were located at the bottom of the borehole. Relatively clean coarse sand was used to backfill the annulus space between the riser pipe and the borehole to about 2 to 3 ft from the ground surface. The water level data represents, therefore, the piezometric conditions of the most permeable layer encountered along the length of the observation wells. The P-series piezometers consist of Casagrande-type piezometers installed in the foundation soils immediately above the weathered bedrock and sealed with bentonite pellets. Each piezometer consists of a Geonor Model M-206 bronze-filtered sensor (14-in. long by 1/4-in. diameter) connected to a 1/4-in. I.D. polyethylene tubing.

Following construction of the cutoff wall, the observation wells were rehabilitated by the cutoff wall contractor. Independent depths checks performed in September 1991 by AEP revealed, however, obstructions in some of these wells. During a site visit on September 24, 1991, WCC recommended flushing all wells and bailing the water out. AEP personnel flushed the A- and the B-series wells on October 17, 1991 and found cement-bentonite slurry and soil sediments in some of the wells. The results of the flushing operations are presented in Table 5 which indicates that the flushing of the wells was generally effective in removing sediments but that few wells were still obstructed. The amount of sediments (or level of obstruction) in each well is represented by the difference between the measured bottom elevation and the bottom of the screen reported by AEP after the installation of the wells. A well is considered in good condition if this difference is less than 1 ft, i.e. within the level of accuracy of the depth measurements. Wells A-2, B-2, and B-4 and to a lesser extent A-1 are therefore questionable because the calculated difference is much larger than 1 ft.

The changes of water levels in observation wells with the pool elevation in Pond 1A are plotted in Figures 5 and 6. Figure 5 shows a hydrograph for all measurements available since the installation of the A-series observation wells. Figure 6 shows the most recent data. The water levels in wells installed upstream of the cutoff wall are about 15 ft higher than the water levels recorded prior to the construction of the cutoff wall, during normal pond operations. Also, the water levels followed the rise in pond elevation with little to no time-lag. The observation wells downstream of the cutoff walls recorded generally similar water levels to the levels measured prior to the construction of the cutoff wall. However, these observation wells recorded a slight increase in head, with the refilling of the pond, then stabilized. Although not very clear, a general drop in head across the wall can be inferred from the water level measurements. This trend is observed on cross-section B-B' in Figure 2 and in the data presented for cross-section B-B' in Figures 7 and 8. The piezometers located along the downstream toe and screened immediately above the bedrock horizon exhibit relatively low total heads which seems to indicate that underseepage is not significant.

The response of the observation wells and piezometers to the change in pool elevation in Pond 1B follows a similar trend to the one observed for Pond 1A. These measurements are plotted on Figures 9 and 10. The water level data relative to cross-

section C-C shown on Figure 2 are plotted on Figures 11 and 12. In general, the increase in head observed in the wells located downstream of the cutoff wall is much smaller than observed at Pond 1A following the filling of Pond 1B. Well A-7 is screened at the base of the original embankment fill, and is located downstream of the cutoff wall. Initial measurements have indicated that the well was dry. Flushing operations have, however, removed 14.5 ft of sediments and more time is needed to allow the head to reach hydrostatic conditions.

### 5.3 SEEPAGE OBSERVATIONS

Initial assessment by AEP personnel indicated that downstream conditions have markedly improved after construction of the cutoff wall. Inspection reports since July 1991, however, have indicated that some seepage areas have reactivated at the toe of Dike 1A. A site visit was conducted by WCC on September 24, 1991 to observe dike conditions during normal operations of the ash ponds and to evaluate visually the performance of the dikes after construction of the cutoff wall. Results of the site visit are summarized in a WCC memorandum dated September 30, 1991 and included in Appendix A.

Post-construction conditions of Pond 1A dike are best described by flow weir No.3 and by visual inspections by AEP and WCC. The flow rate measured at flow weir No. 3 decreased from 30 gpm on August 29, 1989 to about 3 to 6 gpm during the latest measurements, as shown in Table 4. Old calcified bare soil spots were often found in various locations along the downstream slopes. These calcified areas were apparently caused by old (before cutoff wall) seeps that became dry at the present. A few seeps were, however, observed along the toe of the Pond 1A dike and the general toe area around the recirculation pond was wet with 1 to 4 inches of standing water as observed by AEP personnel and as confirmed by WCC during the site visit. Water flowing from the seeps was clear with no sign of piping or erosion.

During the September 24, 1991 site visit, WCC observed a water boil in one area at the toe of the Pond 1A dike between piezometers P-2 and P-3 (Photo 4 in memorandum dated September 30, 1990 of Appendix A). Similar boils had been observed before 1984 at the toe of the Pond 1B dike and had been covered with an inverted filter blanket to

prevent piping. The present boil was not reported by earlier inspections, prior to construction of the cutoff wall and is located about 10 ft above the bottom of the cutoff wall. Water flowing was clear with no sign of internal soil erosion. The volume of flowing water was difficult to quantify because the area around the boil was saturated with about 1 in. of standing water, but it was, however, estimated at about less than 1 gpm. At the present, this boil area does not appear to threaten the stability of the dike.

The general seepage pattern observed at Pond 1A dike indicates that the embankment face is dryer today than it was before the cutoff wall was constructed. Water seepage appears to have decreased as compared to conditions before the cutoff wall but some seeps are still observed at discrete locations along the toe. These seeps are clear with no sign of internal soil erosion and do not appear to threaten the stability of the dike.

Post-construction conditions of Pond 1B dike are best described by flow weirs No.1 and 2, and by visual inspections by AEP and WCC. The flow rate measured at flow weirs No. 1 and 2 installed at the toe of the inverted blanket became dry, following construction of the cutoff wall. This represents a major improvement compared to a combined flow of 29 gpm measured on August 29, 1989 before construction of the cutoff wall during normal operations, as shown in Table 4. Old calcified bare soil spots were also found in various locations along the downstream slopes which indicates that the embankment face is drier now than before construction of the cutoff wall. No seeps were reported along the toe which was generally densely vegetated.

Flow weir No. 4 installed at the right abutment is currently measuring about 53 gpm and appears to be intercepting the phreatic surface at the downstream toe of the dikes. Flow data are not available for flow weir No.4 prior to construction of the cutoff wall during normal pond operations. Chemical tests done on the water flowing into Weir No. 4 indicate that it is mostly natural spring water. A spring was observed by AEP personnel in March 1991 near flow weir No. 4 but it was attributed to a high water table in the abutment due to a very rainy time period.

#### 5.4 EVALUATION OF POST CONSTRUCTION DATA

In general, observation wells and piezometers appear to be operating properly, except for wells A-2, A-7, B-2, and B-4, and piezometer P-3. Also, wells B-3, and B-5 appear to be inoperable. The data from observation wells screened below the bottom of the cutoff wall are difficult to interpret because of their installation procedure which consisted of backfilling the annulus of the boreholes around the riser pipes with sand. The resulting piezometric heads are controlled by the most pervious layer along the riser pipe which could create a hydraulic source or sink, depending on their hydrostatic conditions. The wells screened below the bottom cutoff wall (B-series) may therefore be impacted by the fractured bedrock, which could introduce a pervious layer below the foundations.

The following trends can generally be inferred from the observation well and piezometer data as well as from seepage and visual observations:

- Piezometric data upstream of the cutoff wall is generally at or slightly below the pool elevation. This represents an increase over similar data collected prior to the construction of the cutoff wall.
- Piezometric data downstream of the cutoff wall have a decreasing trend towards the downstream toe at an approximate gradient of 60%. A projection of the slope to the piezometric surface intercepts the downstream toe corroborating seepage observations.
- A piezometric head drop of about 15 ft across the cutoff wall can be inferred from observation well data (only one representative cross-section through Pond 1A dike).
- Piezometric data at, or slightly above, the bedrock horizon indicate total heads close to the ground surface (i.e., about el. 1,515 ft) along the downstream toe, increasing toward the embankment at an average gradient of 17%. These piezometric heads are relatively small and seem to indicate that little underseepage is taking place.

Stability analyses were performed by AEP and were presented in an AEP report dated January 1990. Effective stress analyses were performed using the simplified (uncorrected) Janbu method with circular and wedge block failure surfaces. The stability analyses were performed with different phreatic surfaces representing conditions with and without cutoff wall. Soil parameters were derived from consolidated undrained triaxial tests conducted on one representative sample in each soil zone. Based on engineering correlations and judgement, the effective strength parameters selected for analyses by AEP appear to be conservative. Furthermore, the base of the embankments (i.e. original ground surface) was assumed at el. 1,515 ft but is now confirmed to be at about el. 1,500 ft. This assumption introduces an additional level of conservatism because the postulated foundation soils between el. 1,500 ft and 1,515 ft were assumed weaker than the actual embankment soils.

It should be mentioned that the method of slope stability most widely used by practitioners is the simplified Bishop analysis which is equivalent to the simplified (corrected) Janbu analysis\*. The factors of safety presented by AEP correspond to the simplified (uncorrected) Janbu method. The corrected Janbu method consists of applying a correction factor to the resulting (uncorrected) factors of safety. The correction factor is related to cohesion, angle of internal friction, and the shape of the failure surface. If such a correction factor was applied, the resulting (corrected) factors of safety would have been about 10% higher than presented in AEP analyses.

AEP analyzed the case of no cutoff wall assuming a phreatic surface slightly higher than the phreatic surface measured by wells A-3 and A-5. As a result, the factor of safety calculated by AEP (i.e., 1.3) is expected to be lower than the factor of safety that would be calculated with the lower phreatic surface observed at the present. AEP has also evaluated the case of a cutoff wall in the embankment with no downstream phreatic surface. However, the downstream piezometric data collected after the construction of the cutoff wall indicate that a higher piezometric surface than assumed by AEP exist in the downstream shells. The estimated factor of safety of about 1.5 for this case is likely to be higher than actual. Based on the above considerations and the assumptions made

---

\* Fredlund D.G., and Krahn J., 1977. Comparison of Slope Stability Methods of Analysis. Canadian Geotechnical Journal. Vol 14, No.2, pp. 429-439.



in the AEP analyses, it is possible that a more representative factor of safety for present condition (i.e. after construction of the cutoff wall) would be greater than 1.4.

In summary, the field observations of downstream slope conditions and seepage, and the water level measurements indicate that the cutoff wall has markedly improved conditions in the downstream shell of the dikes by intercepting pervious seams that may have existed in the dikes. However, due to the lack of reliable soil parameters and phreatic surface data, it is difficult to quantify by analyses the improvement resulting from the construction of the cutoff wall.

## CONCLUSIONS AND RECOMMENDATIONS

---

### 6.1 CONCLUSIONS

Based on our review of the results of the field and laboratory quality control tests, and on our review of the daily inspection reports prepared by AEP, it is our opinion that the CBFA cutoff wall was built in accordance with the contract documents (i.e., the cutoff wall was constructed generally to the locations and grades shown on the Drawings). Also, the laboratory tests performed on samples of CBFA slurry from the cutoff wall indicate that a permeability of less than or equal to  $5 \times 10^{-6}$  cm/sec was achieved.

Visual observations made during field inspections indicate that the cutoff wall was effective in intercepting pervious seams in the embankments. This conclusion is based on the following observations:

- 1- rain water is now being retained in the ponds;
- 2- present flow rates measured at the existing downstream V-notch flow weirs are significantly lower than before construction of the cutoff wall; and
- 3- several dry calcified bare soil spots are noticed on the downstream slopes of the dikes at the location of old seepage areas with seepage now observed only at the toe of the dikes.

Observation well and piezometer data generally corroborate the above visual observations. However, some of the wells do not appear to be functioning properly. The following general trends can be inferred from observation well and piezometric measurements:

- Piezometric levels, for wells located upstream of the cutoff wall, have increased after construction of the cutoff wall when compared to levels prior to construction.
- A general piezometric level drop is noticed across the cutoff wall.

- There are no indications of significant underseepage beneath the cutoff wall.

Some seepage has been recently reported by AEP personnel following construction of the cutoff wall along the toe of Pond 1A dike. Seepage appear however to have decreased markedly in comparison to conditions before construction of the cutoff wall. A new boil area was observed after construction of the cutoff wall at the toe of the Pond 1A dike between Piezometers P-2 and P-3. Volume of flowing water was difficult to quantify but it was estimated at less than 1 gpm. Water was clear with no sign of internal soil erosion. At the time of this report, and based on the available data, the observed seepage does not appear to threaten the stability of the dikes.

## 6.2 RECOMMENDATIONS

We recommend that the following measures be implemented to address the seepage spots and to continue monitoring the performance of the dikes:

- Install two flow weirs (Numbers 5 and 6) to collect seepage at the toe of the pond 1-A dike. The approximate locations of the weirs were identified at the site in the presence of Messrs. M. Damian and M. Stevenson of AEP and are shown in Figure 2. Smaller notch angles than the ones currently used could be utilized but the angles should be calculated to accommodate 5 times the flow presently measured.
- Treat the boil area, similarly to past occurrences of boil areas, by placing a graded filter blanket and riprap. We recommend covering a surface area of at least 20 ft by 20 ft. The boil area should be monitored on a monthly basis, changes in flow or evidence of soil erosion should be observed, and reports should be promptly forwarded to the Civil Engineering Division for review and analysis.
- Install six observation wells in the downstream shells of the dikes. Three piezometers could be installed at the Pond 1A dike and the remaining three at the Pond 1B dike. The bottom of the wells should be installed

above the bottom of the cutoff wall and the annulus space between the riser pipe and the boring should be filled with clean, coarse sand. The objective of these wells is to improve our understanding of the piezometric levels downstream of the cutoff wall and to replace the defective wells.

A pair of piezometers should be installed at the boil area. One piezometer should be sealed in the underlying fractured bedrock and the other piezometer should be sealed in the foundation soils.

- Grade all downstream benches and clean drainage swales of all vegetation and sediments. The objective is to provide a free-draining downstream area to enhance seepage detection and evaluation of any observed seepage.
- Mow grass and vegetation cover, and cut the few small trees noticed in some areas. The objective is to enhance inspection of the downstream slopes, to allow a better evaluation of seepage patterns, and to prevent damage to the slopes from tree roots.

Some of these recommendations were presented verbally to Messrs M. Damian and M. Stevenson of AEP and in WCC memorandum dated September 30, 1991 (Appendix A). We further recommend that inspection of the dikes and collection of water level data and seepage rate data continue on a monthly basis when the ponds are in service. The data should be promptly forwarded to the Civil Engineering Division for review and analysis.



As 5709 P 1/9  
faxed to Eych 10/27/08  
200

CLINCH RIVER PLANT  
DIKE INSPECTION CHECKLIST

1. GENERAL INFORMATION

Date of Inspection 10-25-08

Inspected by D.L. RASNAKE

Weather RAINING

Temperature 55°

Rainfall During Past 7 Days \_\_\_\_\_

Reservoir elevations at time of inspection:

Pond 1A 1572.66 - 71 = 1566.75

Pond 1B 1560.0 - 22.5 = 1558.13

Pond 2 Out of service

2. EMBANKMENT CONDITION AT PONDS 1A & 1B

Please refer to the Ash Area 1 Dike Inspection Location Plan which is found on Page 8. Place a number and a descriptive sketch on the location plan at each problem area. Place the same number(s) next to the appropriate description(s) below.

| <u>DESCRIPTION</u> | <u>LOCATION NUMBERS</u> |
|--------------------|-------------------------|
| Cracks             | <u>No</u>               |
| Bulges             | <u>NO</u>               |
| Sliding            | <u>NO</u>               |
| Erosion            | <u>NO</u>               |
| Soft Soil          | <u>yes</u>              |

US EPA ARCHIVE DOCUMENT

Leaking Pipe NO

Seepage/Wetness yes

Vegetative Cover Good

Trees on Slope NO

Hillside Runoff Drain #1 OK

Hillside Runoff Drain #2 OK DRAIN PROP NEED CLEAN OUT

Rodent Burrows yes

Other (Please Specify) \_\_\_\_\_

3. PIEZOMETERS READINGS AT PONDS 1A & 1B

| PIEZ. NO. | ELEV., TOP OF TUBE | DEPTH TO WATER FROM TOP OF TUBE | WATER ELEVATION | COMMENTS |
|-----------|--------------------|---------------------------------|-----------------|----------|
| A-1       | 1571.0             | 17.10                           | 1553.9          |          |
| A-2R      | 1569.5             | 22.82                           | 1546.68         |          |
| A-3       | 1535.0             | 15.44                           | 1519.56         |          |
| A-5       | 1572.2             | 27.08                           | 1545.12         |          |
| A-6       | 1571.3             | 17.43                           | 1553.87         |          |
| A-7R      | 1572.0             | 39.50                           | 1532.5          |          |
| B-1       | 1571.2             | 17.69                           | 1553.51         |          |
| B-2R      | 1571.1             | 19.53                           | 1551.57         |          |
| B-3R      | 1570.9             | CDN'T MEASURE                   |                 |          |
| B-4R      | 1571.1             | 29.60                           | 1541.5          |          |
| B-5R      | 1571.4             | 34.09                           | 1537.31         |          |
| B-6       | 1571.8             | 53.10                           | 1518.7          |          |
| P-1R      | 1529.85            | 14.30                           | 1515.55         |          |

US EPA ARCHIVE DOCUMENT

|      |         |              |                |
|------|---------|--------------|----------------|
| P-2R | 1522.31 | <u>7.30</u>  | <u>1515.01</u> |
| P-3R | 1520.18 | <u>11.69</u> | <u>1508.49</u> |
| P-4R | 1519.16 | <u>14.73</u> | <u>1504.43</u> |
| P-5R | 1519.66 | <u>10.71</u> | <u>1508.95</u> |
| P-6R | 1517.53 | <u>9.95</u>  | <u>1561.58</u> |
| P-7  | 1523.84 | <u>27.28</u> | <u>1495.86</u> |
| P-8  | 1521.11 | <u>27.85</u> | <u>1493.26</u> |

4. V-NOTCH WEIRS

Please determine the flow rate in gallons per minute for each of the V-notch weirs. This can be done by measuring the head H of water above the apex of the V-notch to the nearest 1/4 inch and comparing it to the chart below.

| HEAD, H,<br>INCHES | FLOW RATE, GPM |           | HEAD, H,<br>INCHES | FLOW RATE, GPM |           |
|--------------------|----------------|-----------|--------------------|----------------|-----------|
|                    | 90° WEIR       | 22½° WEIR |                    | 90° WEIR       | 22½° WEIR |
| 1                  | 2              | 0.75      | 3                  | 37             | 7.2       |
| 1 1/4              | 4              | 1         | 3 1/4              | 45             | 8.9       |
| 1 1/2              | 6              | 1.4       | 3 1/2              | 53             | 10.8      |
| 1 3/4              | 9              | 1.9       | 3 3/4              | 65             | 12.5      |
| 2                  | 12             | 2.6       | 4                  | 76             | 14.5      |
| 2 1/4              | 17             | 3.4       | 4 1/4              | 88             | 16.8      |
| 2 1/2              | 24             | 4.6       | 4 1/2              | 100            | 19        |
| 2 3/4              | 30             | 5.9       | 4 3/4              | 114            | 21.6      |

|                  |                       |            |                    |
|------------------|-----------------------|------------|--------------------|
| V-notch Weir #1: | <u>out of Service</u> | <u>2</u>   | gallons per minute |
| V-notch Weir #2: | <u>1 90°</u>          | <u>2</u>   | gallons per minute |
| V-notch Weir #3: | <u>1/4 90°</u>        | <u>1/2</u> | gallons per minute |
| V-notch Weir #4: | <u>2 3/4 90°</u>      | <u>30</u>  | gallons per minute |
| V-notch Weir #5: | <u>1 3/4 90°</u>      | <u>9</u>   | gallons per minute |
| V-notch Weir #6: | <u>1 1/4 22°</u>      | <u>1</u>   | gallons per minute |

5. SEEPAGE COLLECTION SUMP

Please determine the flow rate, in gallons per minute, of the two branches of the french drain at the 8 foot diameter seepage collection sump. This can be done by measuring how much the water

US EPA ARCHIVE DOCUMENT



level rises while recording the time during a period when both pumps are off. Flow rate is given by the following formula:

$$\text{FLOW RATE,} = \frac{(3.1416)(16)(7.48)(60)H}{t}$$

in which H = rise of water level in feet during the unpumped time interval t, in seconds.

FLOW RATE = 5" every min GALLONS PER MINUTE

6. DISCHARGE STRUCTURE AT POND 1B

Please note the conditions with regard to the following:

- Condition of concrete: OK
- Are stoplogs available? OK
- Obstructions NO
- Foreign object in pond? CENOSHERES ON POND
- Pedestrian access O.K.? OK
- Erosion Problems NO
- Other (Please specify) \_\_\_\_\_

7. MISCELLANEOUS AT PONDS 1A & 1B

Is seepage repair area O.K.? OK

What is condition of French drain? Is white precipitate building up impeding drainage? Good

wet place just above P-3 well

What is the overall condition of the discharge structure from Pond 1A to Pond 1B?

Good DRAIN Line about 3/4 under water

US EPA ARCHIVE DOCUMENT

Are seepage sump pumps O.K.? yes

Is entrance to 24" seepage overflow pipe clear of obstructions? yes

8. PONDS 1A & 1B NOTES AND COMMENTS INCLUDING JOB ORDERS WRITTEN AND REPAIRS/MAINTENANCE SINCE LAST INSPECTION:

yard personnel removing ash on pond 1A

9. EMBANKMENT CONDITION AT POND 2 AREA

Please refer to the Ash Area 2 Dike Inspection Location Plan which is found on Page 9. Place a number and a descriptive sketch on the location plan at each problem area. Place the same number(s) next to the appropriate description(s) below.

DESCRIPTION

LOCATION NUMBERS

Cracks

Out of Service

Bulges

Sliding

Erosion

Soft Soil

Leaking Pipe

Seepage/Wetness

US EPA ARCHIVE DOCUMENT

| <u>DESCRIPTION</u>     | <u>LOCATION NUMBERS</u> |
|------------------------|-------------------------|
| Vegetative Cover       | _____                   |
| Trees on Slope         | _____                   |
| Rodent Burrows         | _____                   |
| Other (Please Specify) | _____                   |

10. PIEZOMETER READINGS AT POND 2 AREA

| <u>PIEZ. NO.</u> | <u>ELEV., TOP OF TUBE</u> | <u>DEPTH TO WATER FROM TOP OF TUBE</u> | <u>WATER ELEVATION</u> | <u>COMMENTS</u> |
|------------------|---------------------------|--|------------------------|-----------------|
| P-1              | 1557.0                    |  |                        |                 |
| P-2              | 1555.8                    |  |                        |                 |
| P-3              | 1556.7                    |  |                        |                 |
| P-4              | 1557.4                    |  |                        |                 |
| P-5              | 1557.7                    |  |                        |                 |
| P-6              | 1557.4                    |  |                        |                 |
| P-7              | 1557.9                    |  |                        |                 |
| P-8              | 1557.4                    |  |                        |                 |
| P-9              | 1558.2                    |  |                        |                 |
| U-1              | 1560.0                    | 46.00                                  | 1514.0                 |                 |
| U-2              | 1561.1                    | 37.25                                  | 1523.85                | DRY             |
| U-3              | 1560.0                    | 44.90                                  | 1513.1                 | DRY             |
| U-4              | 1560.0                    | 46.25                                  | 1513.75                |                 |
| L-5              | 1532.0                    | No Cap full of water                   |                        |                 |
| L-6              | 1532.0                    | Gone                                   |                        |                 |
| L-7              | 1535.3                    | 14.15                                  | 1521.15                |                 |
| L-8              | 1534.7                    | 20.62                                  | 1514.08                |                 |

US EPA ARCHIVE DOCUMENT

11. IS PERFORATED DRAIN PIPE BETWEEN LOWER LEVEL AND MIDDLE LEVEL  
DIXES WORKING PROPERLY AND IN GOOD CONDITION?

Out of Service

12. DISCHARGE STRUCTURE AT POND 2

Please note the conditions with regard to the following:

Condition of concrete

Out of Service

Gates/valves operational?

Obstructions

Is access clear?

Erosion problems

Other (Please specify)

13. POND 2: NOTES AND COMMENTS INCLUDING JOB ORDERS WRITTEN AND  
REMEDIAL WORK DONE SINCE LAST INSPECTION

Out of Service

PAGE 8 OF 9  
DIVISION 2  
FEBRUARY 7, 1996

NORTH

0 100 200 300  
SCALE FEET

• DENOTES PIEZOMETER

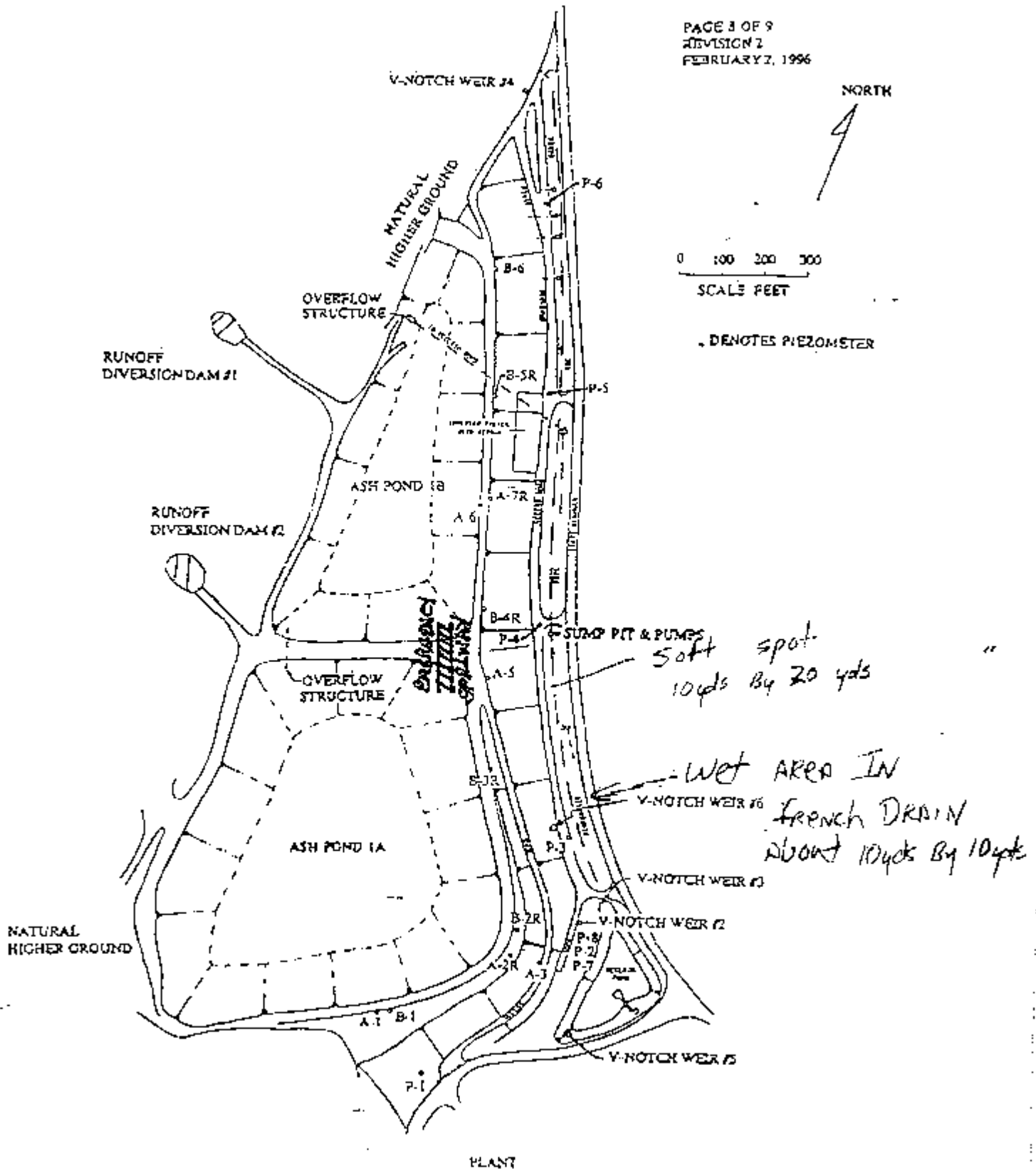

CLINCH RIVER PLANT: ASH AREA DIKE INSPECTION LOCATION PLAN

US EPA ARCHIVE DOCUMENT

US EPA ARCHIVE DOCUMENT

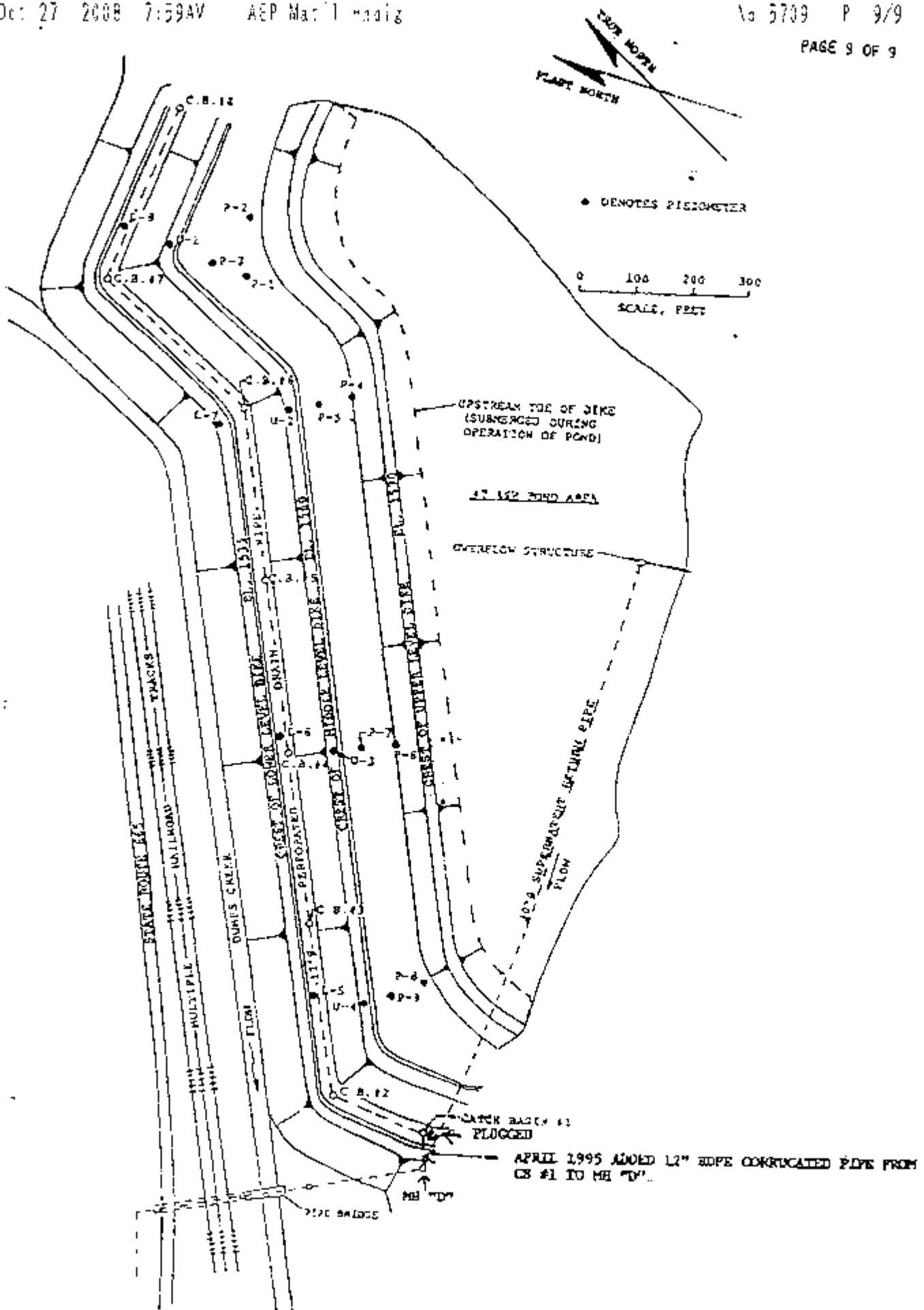

CLINCH RIVER PLANT: ASH AREA 2 DIKE INSPECTION LOCATION PLAN

Page 1 of 9  
Revision 1 5/20/93CLINCH RIVER PLANT  
DIKE INSPECTION CHECKLIST1. GENERAL INFORMATION

Date of Inspection

4-17-09      4-18-09

Inspected by

D.L. RAINDAKE

Weather

SUNNY

Temperature

65°

Rainfall During Past 7 Days

Reservoir elevations at  
time of inspection:

Pond 1A

1572.66 - 20.5" = ~~1552.16~~ 1555.13

Pond 1B

1560.3 - 16" = ~~1544.3~~ 1558.67

Pond 2

2. EMBANKMENT CONDITION AT PONDS 1A & 1B

Please refer to the Ash Area 1 Dike Inspection Location Plan which is found on Page 8. Place a number and a descriptive sketch on the location plan at each problem area. Place the same number(s) next to the appropriate description(s) below.

| <u>DESCRIPTION</u> | <u>LOCATION NUMBERS</u> |
|--------------------|-------------------------|
| Cracks             | <u>NO</u>               |
| Bulges             | <u>NO</u>               |
| Sliding            | <u>NO</u>               |
| Erosion            | <u>NO</u>               |
| Soft Soil          | <u>YES</u>              |

Leaking Pipe NO  
 Seepage/Wetness yes  
 Vegetative Cover Good  
 Trees on Slope NO  
 Hillside Runoff Drain #1 OK  
 Hillside Runoff Drain #2 OK NEEDS cleaned out  
 Rodent Burrows NO  
 Other (Please Specify) \_\_\_\_\_

3. PIEZOMETERS READINGS AT PONDS 1A & 1B

| PIEZ. NO. | ELEV., TOP OF TUBE | DEPTH TO WATER FROM TOP OF TUBE | WATER ELEVATION | COMMENTS |
|-----------|--------------------|---------------------------------|-----------------|----------|
| A-1       | 1571.0             | 16.23                           | 1554.77         |          |
| A-2R      | 1569.5             | 21.94                           | 1547.56         |          |
| A-3       | 1535.0             | 14.84                           | 1520.16         |          |
| A-5       | 1572.2             | 26.11                           | 1546.09         |          |
| A-6       | 1571.3             | 15.25                           | 1556.05         |          |
| A-7R      | 1572.0             | 38.85                           | 1533.15         |          |
| B-1       | 1571.2             | 16.65                           | 1554.55         |          |
| B-2R      | 1571.1             | 18.50                           | 1552.60         |          |
| B-3R      | 1570.9             | CAN'T measure                   |                 |          |
| B-4R      | 1571.1             | 29.12                           | 1541.98         |          |
| B-5R      | 1571.4             | 33.84                           | 1537.56         |          |
| B-6       | 1571.8             | 52.91                           | 1518.89         |          |
| P-1R      | 1529.85            | 11.00                           | 1518.85         |          |



|      |         |              |                |
|------|---------|--------------|----------------|
| P-2R | 1522.31 | <u>7.10</u>  | <u>1515.21</u> |
| P-3R | 1520.18 | <u>12.54</u> | <u>1507.64</u> |
| P-4R | 1519.16 | <u>14.05</u> | <u>1505.11</u> |
| P-5R | 1519.66 | <u>10.50</u> | <u>1509.16</u> |
| P-6R | 1517.53 | <u>9.40</u>  | <u>1508.13</u> |
| P-7  | 1523.14 | <u>25.70</u> | <u>1497.44</u> |
| P-8  | 1521.11 | <u>26.48</u> | <u>1494.63</u> |

4. V-NOTCH WEIRS

Please determine the flow rate in gallons per minute for each of the V-notch weirs. This can be done by measuring the head H of water above the apex of the V-notch to the nearest 1/4 inch and comparing it to the chart below.

| HEAD, H,<br>INCHES | FLOW RATE, GPM |           | HEAD, H,<br>INCHES | FLOW RATE, GPM |           |
|--------------------|----------------|-----------|--------------------|----------------|-----------|
|                    | 90° WEIR       | 22½° WEIR |                    | 90° WEIR       | 22½° WEIR |
| 1                  | 2              | 0.75      | 3                  | 37             | 7.2       |
| 1 1/4              | 4              | 1         | 3 1/4              | 45             | 8.9       |
| 1 1/2              | 6              | 1.4       | 3 1/2              | 53             | 10.8      |
| 1 3/4              | 9              | 1.9       | 3 3/4              | 65             | 12.5      |
| 2                  | 12             | 2.6       | 4                  | 76             | 14.5      |
| 2 1/4              | 17             | 3.4       | 4 1/4              | 88             | 16.8      |
| 2 1/2              | 24             | 4.6       | 4 1/2              | 100            | 19        |
| 2 3/4              | 30             | 5.9       | 4 3/4              | 114            | 21.6      |

|                  |                       |            |                               |
|------------------|-----------------------|------------|-------------------------------|
| V-notch Weir #1: | <u>Out of Service</u> |            | gallons per minute            |
| V-notch Weir #2: | <u>1</u>              | <u>90°</u> | <u>2</u> gallons per minute   |
| V-notch Weir #3: | <u>0.25</u>           | <u>90°</u> | <u>1.5</u> gallons per minute |
| V-notch Weir #4: | <u>2.75</u>           | <u>90°</u> | <u>30</u> gallons per minute  |
| V-notch Weir #5: | <u>1.5</u>            | <u>90°</u> | <u>6</u> gallons per minute   |
| V-notch Weir #6: | <u>1.5</u>            | <u>22°</u> | <u>1.4</u> gallons per minute |

5. SEEPAGE COLLECTION SUMP

Please determine the flow rate, in gallons per minute, of the two branches of the French drain at the 8 foot diameter seepage collection sump. This can be done by measuring how much the water

level rises while recording the time during a period when both pumps are off. Flow rate is given by the following formula:

$$\text{FLOW RATE,} = \frac{(3.1416)(16)(7.48)(60)H}{t}$$

in which H = rise of water level in feet during the unpumped time interval t, in seconds.

FLOW RATE = 5" every min GALLONS PER MINUTE

6. DISCHARGE STRUCTURE AT POND 1B

Please note the conditions with regard to the following:

|                         |                            |
|-------------------------|----------------------------|
| Condition of concrete   | <u>OK</u>                  |
| Are stoplogs available? | <u>OK</u>                  |
| Obstructions            | <u>NO</u>                  |
| Foreign object in pond? | <u>Cenospheres on Pond</u> |
| Pedestrian access O.K.? | <u>OK</u>                  |
| Erosion Problems        | <u>NO</u>                  |
| Other (Please specify)  | <u></u>                    |

7. MISCELLANEOUS AT PONDS 1A & 1B

Is seepage repair area O.K.? OK

What is condition of French drain? Is white precipitate building up impeding drainage? Good

2 places wet just Below P-3 well

What is the overall condition of the discharge structure from Pond 1A to Pond 1B?

Good Drain Line about 7/8 under water

Are seepage sump pumps O.K.? yes

Is entrance to 24"φ seepage overflow pipe clear of obstructions? yes

8. PONDS 1A & 1B NOTES AND COMMENTS INCLUDING JOB ORDERS WRITTEN AND REPAIRS/MAINTENANCE SINCE LAST INSPECTION:

Pond 1A Looks Good Contractors  
cleaning ash out of pond

Pond 1B Looks Good  
condensates on pond

9. EMBANKMENT CONDITION AT POND 2 AREA

Please refer to the Ash Area 2 Dike Inspection Location Plan which is found on Page 9. Place a number and a descriptive sketch on the location plan at each problem area. Place the same number(s) next to the appropriate description(s) below.

| <u>DESCRIPTION</u> | <u>LOCATION NUMBERS</u> |
|--------------------|-------------------------|
| Cracks             | <u>Out Service</u>      |
| Bulges             | _____                   |
| Sliding            | _____                   |
| Erosion            | _____                   |
| Soft Soil          | _____                   |
| Leaking Pipe       | _____                   |
| Seepage/Wetness    | _____                   |

| <u>DESCRIPTION</u>     | <u>LOCATION NUMBERS</u> |
|------------------------|-------------------------|
| Vegetative Cover       | _____                   |
| Trees on Slope         | _____                   |
| Rodent Burrows         | _____                   |
| Other (Please Specify) | _____                   |

10. PIEZOMETER READINGS AT POND 2 AREA

| <u>PIEZ. NO.</u> | <u>ELEV., TOP OF TUBE</u> | <u>DEPTH TO WATER FROM TOP OF TUBE</u> | <u>WATER ELEVATION</u> | <u>COMMENTS</u> |
|------------------|---------------------------|--|------------------------|-----------------|
| P-1              | 1557.0                    | _____                                  | _____                  | _____           |
| P-2              | 1555.8                    | _____                                  | _____                  | _____           |
| P-3              | 1556.7                    | _____                                  | _____                  | _____           |
| P-4              | 1557.4                    | _____                                  | _____                  | _____           |
| P-5              | 1557.7                    | _____                                  | _____                  | _____           |
| P-6              | 1557.4                    | _____                                  | _____                  | _____           |
| P-7              | 1557.9                    | _____                                  | _____                  | _____           |
| P-8              | 1557.4                    | _____                                  | _____                  | _____           |
| P-9              | 1558.2                    | _____                                  | _____                  | _____           |
| U-1              | 1560.0                    | 45.82                                  | 1514.18                | _____           |
| U-2              | 1561.1                    | 35.64                                  | 1525.46                | _____           |
| U-3              | 1560.0                    | 45.89                                  | 1514.11                | _____           |
| U-4              | 1560.0                    | 46.40                                  | 1513.60                | _____           |
| L-5              | 1532.0                    | NO CAP Fall of water                   |                        |                 |
| L-6              | 1532.0                    | None                                   |                        |                 |
| L-7              | 1535.3                    | 15.92                                  | 1519.38                | _____           |
| L-8              | 1534.7                    | 19.75                                  | 1514.95                | _____           |

11. IS PERFORATED DRAIN PIPE BETWEEN LOWER LEVEL AND MIDDLE LEVEL  
DIKES WORKING PROPERLY AND IN GOOD CONDITION?

*out of service*

12. DISCHARGE STRUCTURE AT POND 2

Please note the conditions with regard to the following:

Condition of concrete

*Out of Service*

Gates/valves operational?

Obstructions

Is access clear?

Erosion problems

Other (Please specify)

13. POND 2: NOTES AND COMMENTS INCLUDING JOB ORDERS WRITTEN AND  
REMEDIAL WORK DONE SINCE LAST INSPECTION

*Out of Service*

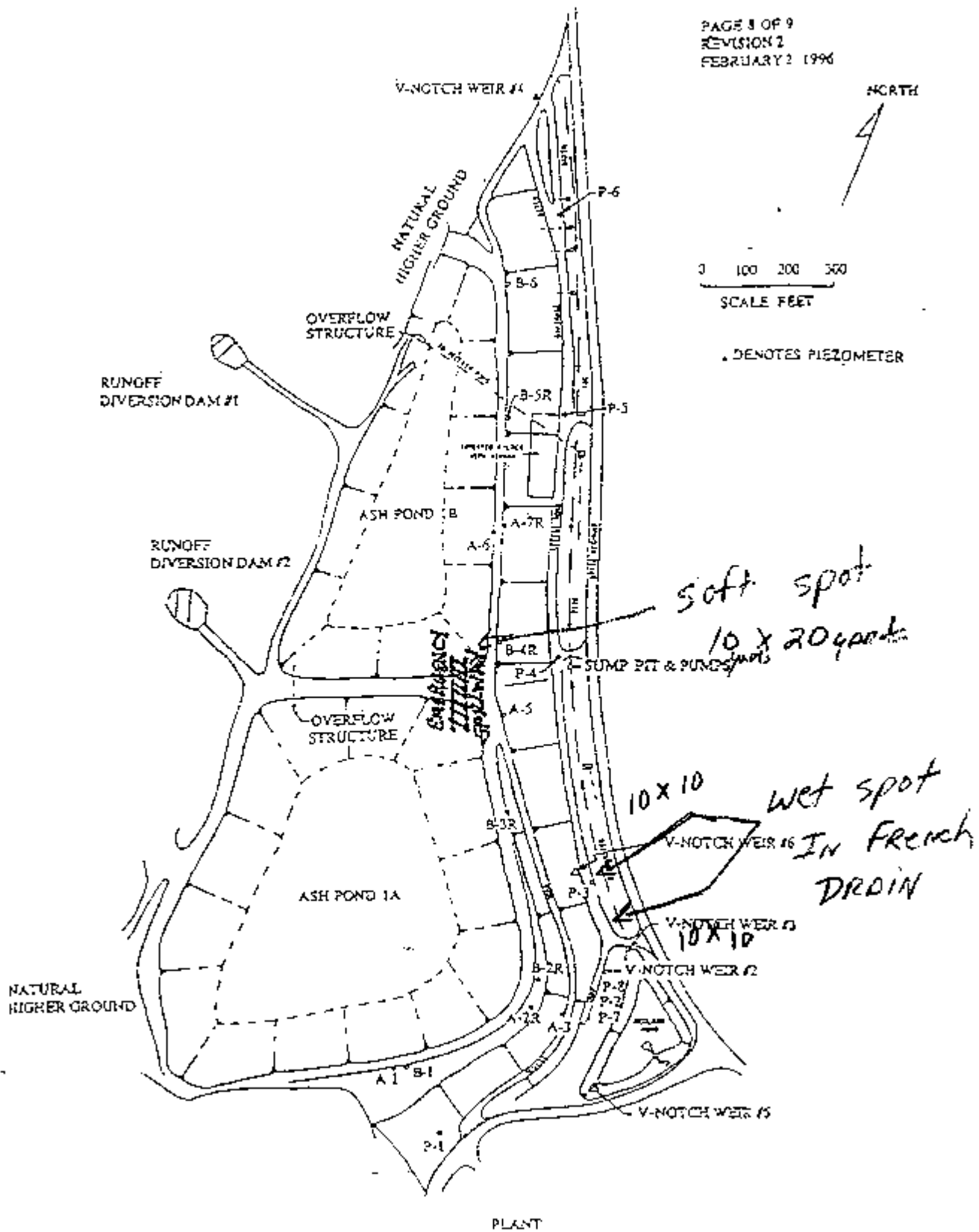

CLUNCH RIVER PLANT, ASH AREA 1 DIKE INSPECTION LOCATION PLAN

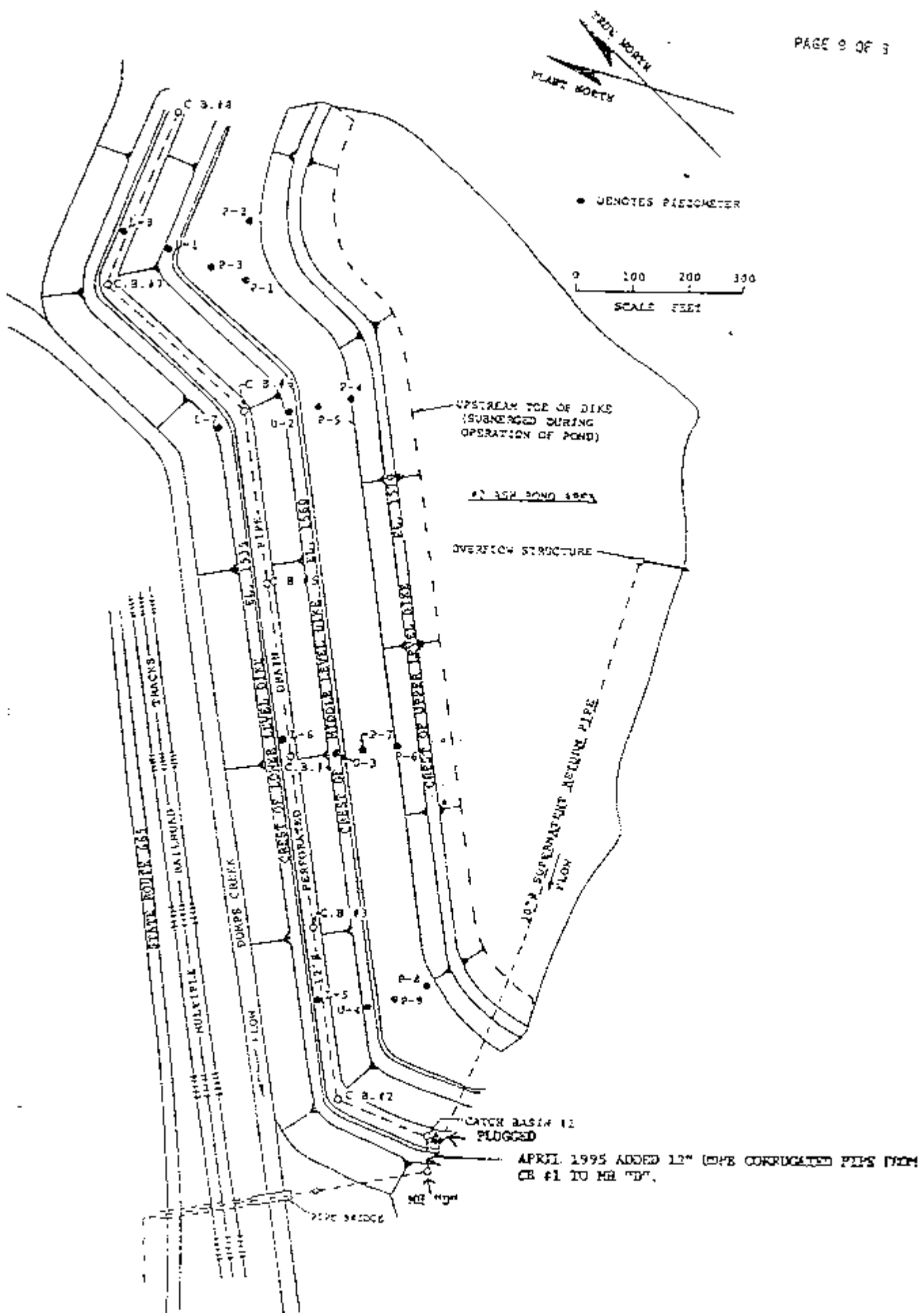

CLINCH RIVER PLANT: ASH AREA 2 DIKE INSPECTION LOCATION PLAN

## SUMMARY OF AEP'S DAM AND DIKE INSPECTION AND MAINTENANCE PROGRAM (DIMP)

**Subject:** Dam and DiKE Inspection and Maintenance Program

**Category:** CIVIL (Maintenance)

**CL #** OIM CL 0100

**Revision:**

Revised to reflect the current status of the program and to reflect the current status of the program.

**Purpose:**

To describe the inspection, documentation and routine maintenance duties and responsibilities of Plant, Region Engineering, Environmental Services and Engineering Services under the ACP Dam Inspection and Maintenance Program. The program applies to all existing dams and dikes used for ash or TGD sludge storage and disposal, waste water ponds and large cooling water storage facilities on the AEP System. Section IV of this letter briefly discusses Emergency Action Plans (EAP) but does not address actions to be taken under emergency conditions. For response to emergency conditions refer to the facility's Emergency Action Plan if applicable, or contact AEP SO Geotechnical Engineering Section.

**Background:**

From the 1940's through the 1970's, as the AEP System was expanded, AEP operated extensively on its dams and dikes with one of the principals of geotechnical engineering, Professor Arthur Casagrande, in full view. If a dam or dike exhibited problems, AEP would monitor and report under his guidance. In the 1960's and 1970's, large consulting companies engineered major dam construction projects with Casagrande Consultants doing as the owner's reviewer.

In the 1970's, AEP began to perform dam inspections with internal staff. In addition, the U.S. Army Corps of Engineers inspected several AEP dams in the late 1970's as part of a national program in response to the Buffalo Creek disaster in West Virginia. In 1979, AEP contracted with Woodward Clyde Consultants to begin inspecting existing ash disposal dams and dikes on the AEP System every two years. In 1983, AEP Civil Engineering initiated the Dam Inspection and Maintenance Program. Its purpose was to provide for systematic inspection, follow-up on significant inspection findings and to establish a contact point for plant concerns. Inspection checklists were created, and the plants were asked to perform periodic inspections.

Through the 1990's to the present, the program has been uniform and consistent. The purpose of this revision is to further strengthen the program throughout the entire AEP System and to reinforce the need to perform and document routine and formal inspections, collect instrumentation data where applicable and implement maintenance and remedial activities to assure the facilities are operated and maintained in a condition consistent with their design basis.

The Geotechnical Engineering Section (GES) of AEP SO Engineering Services coordinates the overall program, which is largely based on state regulations, Federal Emergency Management Agency guidelines, and sound engineering practice.

The inspection component of the program consists of four levels of inspection: (1) routine surveillance inspections by Plant personnel looking for changes in conditions (slips along dam face, erosion, gullies, excessive settlement, malfunctioning drains, new seepage areas, etc.); (2) formal, checklist-type inspections by Plant or Region Engineering staff performed on a scheduled basis; (3) engineering inspections performed under the direction of a P.E. at a frequency determined by the dam's risk classification (1, 2, or 3 year intervals); and (4) non-routine plant inspections after unusual events such as heavy rains, seismic events, or other events that could cause a change in the condition of the facility.



Inspection Schedule for Plant Formal (checklist) Inspections

| VA                      |                   |
|-------------------------|-------------------|
| Roanoke River FAD 1A/1B | Inspect Quarterly |
| Roanoke River FAD 2     | Inspect Quarterly |
| Roanoke River FAP       | Inspect Quarterly |
| Roanoke River SAP       | Inspect Quarterly |
| Roanoke River West Fork | Inspect Quarterly |

**DAM & DIKE INSPECTION REPORT  
RECLAIM POND  
ASH POND 1A & 1B**

**CLINCH RIVER PLANT  
CARBO, VA**

**INSPECTION DATE** November 24, 2009

**PREPARED BY** Behrad Zand  
Behrad Zand, Engineer

**DATE** 1/6/2010

**REVIEWED BY** Gary F. Zych  
Gary F. Zych, P.E.

**DATE** 1/6/2010

**APPROVED BY** Pedro J. Amaya  
Pedro J. Amaya, P.E.  
Section Manager - Geotechnical Engineering

**DATE** 1/8, 2010

**QA/QC DOCUMENT NO.**  
GERS-09-048

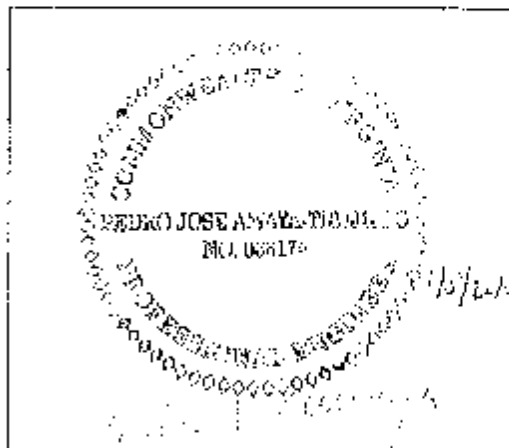

**PROFESSIONAL ENGINEER  
SEAL & SIGNATURE**

**US EPA ARCHIVE DOCUMENT**

2009 INSPECTION REPORT  
RECLAIM POND  
ASH POND 1A AND 1B

CLINCH RIVER PLANT  
CARBO, VA

January 5, 2010

|       |   |   |
|-------|---|---|
| 1     | Introduction.....   | 1 |
| 2     | Summary of Visual Observations.....   | 1 |
| 2.1   | General.....  | 1 |
| 2.2   | Reclaim Pond.....   | 2 |
| 2.3   | Pond 1A.....  | 3 |
| 2.4   | Pond 1B.....  | 4 |
| 3     | Assessment of Recent Instrumentation Data.....                              | 6 |
| 3.1   | Pond Water Levels.....  | 6 |
| 3.2   | Piezometer and Observation Wells.....                                       | 6 |
| 3.3   | Flow Measurement Weirs.....   | 6 |
| 4     | Conclusions.....  | 7 |
| 4.1   | Reclaim Pond.....   | 7 |
| 4.2   | Pond 1A.....  | 7 |
| 4.3   | Pond 1B.....  | 7 |
| 5     | Recommendations.....  | 7 |
| 5.1   | Items That Require Attention Beyond the Regular Maintenance Activities..... | 7 |
| 5.2   | Regular Maintenance Items.....  | 8 |
| 5.2.1 | Reclaim Pond.....   | 8 |
| 5.2.2 | Pond 1A.....  | 8 |
| 5.2.3 | Pond 1B.....  | 9 |

## 1 INTRODUCTION

AEPC Civil Engineering administers the company's Dam Inspection and Maintenance Program (DIMP). As part of DIMP, staff from the Geotechnical Engineering Section conducts dike and dam inspections annually. Mr. Behrad Zand conducted the 2009 inspection. This report has been prepared under the direction of Mr. Pedro J. Amaya, P.E. and presents a summary of the inspection and assessment of the condition of the facilities.

Mr. Jimmie Saunders at the Clinch River Plant was the project facility contact. The inspection was performed on November 24, 2009. Weather conditions were partially cloudy. Temperatures ranged from a low of 39°F to a high of 59°F, with a mean temperature of 49°F<sup>1</sup>. There was no rainfall on the day of inspection and 0.15 inches of rainfall on the day before inspection day. There was 0.15 inches of rainfall during the ten days prior to the inspection day.

At Clinch River Plant, the Ash Pond Complex consists of Ash Pond 1A, Ash Pond 1B and a Reclaim Pond as shown in Figures 1 through 5. The two ash ponds are formed by earthen embankments approximately 60-ft. high on the west, south and east sides, a splitter embankment in the center and natural high ground along the north side. The embankments have interior slopes of approximately 3 Horizontal to 1 Vertical (3H to 1V) and exterior slopes of approximately 2H to 1V. The exterior dike on the south side has an underdrain and finger drain system installed downstream of the toe road to control and collect seepage. The Reclaim Pond is an excavated pond.

In addition to the Ash Pond Complex, there is Ash Pond 2 that is located across the road from the Complex. Ash Pond 2 has been out-of-service since 1998 and there is no free water in the pond. Therefore, no inspection was performed, although the site was visited.

## 2 SUMMARY OF VISUAL OBSERVATIONS

### 2.1 GENERAL

The summary of the visual observations uses terms to describe the general appearance or condition of an observed item, activity or structure. Their meaning of these terms is as follows:

<sup>1</sup> Weather data was obtained from [www.weather underground.com](http://www.weather underground.com) website for Richland, VA.

|                       |   |
|-----------------------|---|
| Good:                 | A condition or activity that is generally better or slightly better than what is minimally expected or anticipated from a design or maintenance point of view.  |
| Fair or Satisfactory: | A condition or activity that generally meets what is minimally expected or anticipated from a design or maintenance point of view.  |
| Poor:                 | A condition or activity that is generally below what is minimally expected or anticipated from a design or maintenance point of view.   |
| Minor:                | A reference to an observed item (e.g., erosion, seepage, vegetation, etc.) where the current maintenance condition is below what is normal or desired, but which is not currently causing concern from a structure safety or stability point of view.   |
| Excessive:            | A reference to an observed item (e.g., erosion, seepage, vegetation, etc.) where the current maintenance condition is above or worse than what is normal or desired, and which may have affected the ability of the observer to properly evaluate the structure or particular area being observed or which may be a concern from a structure safety or stability point of view. |

Appendices A, B and C contain selected photographs taken during the inspection of the Reclaim Pond, Pond 1A and Pond 1B, respectively.

## 2.2 RECLAIM POND

1. The north slope of the Reclaim pond is protected by rip-rap and is in good condition. The remaining interior slopes of the pond have been vegetated with sufficient coverage in most places. There are a few areas on the slopes with insufficient vegetative coverage. There were no signs of major erosion on the slopes. Minor to moderate erosion gullies were present at several locations (e.g. Photo 1).

2. The V notch weir boxes referenced as Nos. 2, 3, and 5 were in fair condition. Clear water flow was discharging from all the weirs. Gray precipitate was observed on the downstream of weir box No. 3 (Photo 2), and at the bottom of all the weir boxes.
3. The surface of the Reclaim Pond was entirely covered with ctenospheres (Photo 3).

### 2.3 POND 1A

1. Herbicide had been applied to the vegetation in the western groin ditch to eliminate heavy overgrown vegetation presented in this area. Dried vegetation was still present along the groin ditch (Photo 4), that limited the extent of the visual inspection.
2. The erosion protection for the groin ditch was in satisfactory condition. The area on the abutment within 25 ft from the center of the groin ditch was clear of any woody or overgrown vegetation except for one tree near the crest that was only 15 ft away from the center of the groin ditch.
3. The exterior slope of the west 1A dike was well vegetated and in good condition. Rip-rap protection has recently been installed along the toe area of the west dike near groin ditch (Photo 5) and to the west of the access road. There were no signs of erosion or excessive seepage on the slope or at the toe area.
4. The lower half of the southeast slope of 1A dike, downstream of the access road, is covered with an inverted filter for seepage and erosion control (Photo 6). The rip-rap of the filter was in good condition with no visual signs of rock deterioration or displacement.
5. The portions of the exterior slope of the south 1A dike above the haul road that was not covered by rip-rap (inverted filter) was well vegetated. There were no signs of sloughing, bulging, wet patches, or settlement on the upper section of the slope. The general condition of the slope was satisfactory (Photos 7). No animal burrows were observed on this portion of the slope.
6. There was no visual indication of piping or excessive seepage at the toe area of 1A dike. No signs of erosion were observed at the toe of the rip rapped portions of the slope. A wet area was observed approximately at the middle of south 1A dike below the access road.
7. There was clear seepage flow from V-notch weir #6. Flow from the weir is directed into a stoned-lined ditch at the toe of the dike. The bottom of the weir box was covered with a layer of light gray precipitate.

8. The top of dike road was in good condition with no visual evidence of dike settlement or misalignment. Several areas with minor rutting were observed on the road. There were no signs of instability or settlement on the access road along the toe of the south dike. Rutting was observed at a few areas of the road.
9. Reddish to light gray precipitate were present in most of the toe drain pipes (e.g. Photo 8).
10. The overflow tower from 1A to 1B ponds was in satisfactory conditions (Photo 9). There was no protective railing on the splitter dike around the overflow structure from 1A Pond to 1B Pond. The hand rail around the overflow structure was loose.
11. Two temporary spillway shafts have been installed to discharge the flow from 1A to 1B ponds to facilitate maintenance of the main spillway shaft. Photo 10 shows one of the new spillway shafts to the north of the overflow tower. The second shaft, located to the south of the overflow tower, has a higher invert elevation to pass discharge water from 1A to 1B ponds if the pool level increases to higher than normal levels during a storm event.
12. No staff gage is installed for 1A Pond and the pool level could not be determined. At the time of inspection the pool level appeared to be lower than its normal level, thus it is believed that the freeboard was sufficient. Plant personnel indicated that a staff gage will be installed in early 2010.
13. The rock slope on the northwest side of 1A pond appeared to be in stable condition. There was no visual indication of major cracks, rock deterioration, displacement, or instable rock blocks (Photo 11).

#### 2.4 POND 1B

1. Clear water was flowing in the east groin ditch below approximate elevation of 1520 ft. Clear seepage flow was present in V-notch weir #4.
2. Heavy vegetation, including woody vegetation, was present in or near the east groin ditch (Photo 12). The portion of the groin ditch that was not covered with vegetation and could be inspected was in fair condition with no signs of erosion, blockage, or instability. A portion of the slope and groin ditch near the crest has rip-rap protection (Photo 13).
3. An inverted filter has been installed on the lower half of the south slope of 1B dike (Photo 14). The rip-rap was in good condition with no signs of sloughing, displacement, or deterioration of the stones.

4. There were no visual signs of piping or excessive seepage at the toe area of 1A dike. No signs of erosion were observed at the toe area or along the perimeters of the rip-rap (inverted filter). A seep was observed on the slope of the dike near the abutment at approximate elevation of 1540 ft.
5. Several small trees were present on the outboard slope 1B dike near the east abutment (e.g. Photo 12). A small tree was observed on the inboard slope of the south dike (Photo 15).
6. The portion of the outboard slopes not covered with rip-rap had vegetative cover. The slope appeared stable and was in satisfactory condition (Photo 13). Several areas on the slope were noticed to have insufficient vegetative coverage. A portion of the slope between piezometers B-5R and A7-R had no vegetative cover (Photo 16).
7. The area on the outboard slope at approximate elevation of 1533 near the interface with 1A pond that was reported in the previous inspection reports is now covered with the inverted filter.
8. Four animal burrows were observed on the south 1B slope above the inverted filter.
9. The inboard slope of the dike had sufficient vegetative coverage (Photo 15).
10. The top of dike road was in fair condition with no evidence of dike settlement or misalignment. Several areas with minor rutting were observed on the road.
14. There were no signs of instability or settlement on the access road along the toe of the south dike. Rutting was observed on a few areas of the road.
11. A layer of cenospheres covered the majority of the water surface in 1B pond (Photo 15).
12. Minor erosion developments were noticed on the slope of the drainage ditch at several locations (e.g. Photo 17).
13. The outlet structure from the pond was in fair condition. Flow under the slide gate was smooth and unobstructed. Portions of the outfall tower, particularly the interior, was rusty and the tower was in need of painting (Photo 18).
14. The exterior of the concrete manholes at the toe of the slope were in good condition. Surface water has appeared to collect in the bottom of the pipe pit structure.
15. No functional staff gage was installed in 1B pond. The plant personnel indicated that a staff gage will be installed in this pond.
16. Settlement cracks were present on the portion of splitter dike that has been constructed recently (Photo 19).
17. An old surface sloughing was noticed on the east hillside near the groin ditch (Photo 20).



### 3 ASSESSMENT OF RECENT INSTRUMENTATION DATA

#### 3.1 POND WATER LEVELS

Pond water levels, as measured on the date of the previous inspections, are summarized in Table 1. Due to the lack of a staff gage the pool levels could not be determined during the current inspection. Plant personnel measure the pool levels during the routine inspections performed by the plant on quarterly basis.

| Pond Name    | 7 Aug 2009   | 7 Jan 2009   | 31 Oct 2007  | 3 July 2007  | 6 Oct. 2006  | 1 Nov 2005    | 10 Sept 2003 | 14 Sept 2002 | 6 Nov. 2001 |
|--------------|--------------|--------------|--------------|--------------|--------------|---------------|--------------|--------------|-------------|
| Reclaim Pond | Not measured | Not measured | Not measured | Not measured | Not measured | Not measured  | Not measured | 12.2*        | 5.7*        |
| IA Pond      | 1566.8       | 1566.5       | Not measured | 1566.7       | 1566.7       | 1567 (approx) | 1566.8       | 1567.4       | 1566.9      |
| IB Pond      | 1558.1       | 1559         | 1558.1       | 1558.4       | 1558         | 1559.0        | 1557.33      | 1556.47      | 1558.1      |
| Pond 2       | Dewatered    |              |              |              |              |               |              |              |             |

\* All depths and elevations reported in feet.

\*\* Depth Measured Below Top of Sump Structure Grating Located on South Slope of Reclaim Pond.

Table 1. Pond elevations since 2001

#### 3.2 PIEZOMETER AND OBSERVATION WELLS

Twenty (20) piezometers located on or near the Ash Complex are being monitored by AEP. Locations of the piezometers are shown on figure 6. Figure 7 presents the measurements recorded by the plant since 1985. Measurements recorded by the Plant since 2005 appear similar and within their normal historic range. Piezometers at the dewatered Ash Pond 2 are not included in the current AEP monitoring program. Several new piezometers have been installed on or near the dikes of IA and IB ponds. Plant personnel should monitor these wells along with the other instrumentations.

#### 3.3 FLOW MEASUREMENT WEIRS

Flow through five V-Notched Weirs collecting seepage and surface runoff from the Ash Pond IA and IB Complex were measured during the inspection. Presented in Table 2 are the recorded measurements and previous measurements.

| Weir No. &<br>Size | Flow Rate, GPM |           |            |            |            |                  |            |
|--------------------|----------------|-----------|------------|------------|------------|------------------|------------|
|                    | 23 Dec.<br>09  | 7 Jan. 09 | 31 Oct. 07 | 03 Nov. 05 | 15 Dec. 04 | 09 Sep. 03       | 14 Sep. 02 |
| 2-90"              | 9              | 8         | 7          | 6          | 7          | 2.5              | 1          |
| 3-90"              | 1              | 1.5       | No flow    | No flow    | <2         | No flow          | 0.5        |
| 4-90"              | 30             | 88        | Unreadable | 37         | 45         | 24 (Oct<br>2003) | 30         |
| 5-90"              | 12             | 37        | 10         | 7          | 12         | 6                | 6          |
| 6-22 1/2"          | 1              | 6.6       | 1.75       | 2.6        | 5.9        | 1                | 0.75       |

Table 2. Seepage flow rates at V-notch weirs since 2002

#### 4 CONCLUSIONS

##### 4.1 RECLAIM POND

The side slopes around the Reclaim Pond are in fair condition. The pond is performing as desired.

##### 4.2 POND 1A

Overall, the embankments forming Pond 1A are in satisfactory condition. Measured seepage is clear and the flow rates are within their historical ranges. There are no signs of instability or piping. Few components are in poor condition and in need of improvement.

##### 4.3 POND 1B

Overall, the earthen embankments forming Pond 1B are in satisfactory condition. Seepage areas are stable and there are no signs of increased flow rates or changes in the clarity of the seepage water. Few components are in poor condition and in need of improvement.

#### 5 RECOMMENDATIONS

##### 5.1 ITEMS THAT REQUIRE ATTENTION BEYOND THE REGULAR MAINTENANCE ACTIVITIES

Visual inspection of the Reclaim, 1A, and 1B ponds did not reveal any issue that would raise an immediate concern on the safety or stability of these facilities. Below is a summary of the components that were found to be in poor condition and in need of improvement:

- 1- The west and east groin ditches should be cleared of any vegetation. In general, dried vegetation shall be removed after each application of herbicide. All the trees and woody vegetation that have grown on the slopes of the dikes should be removed.
- 2- The tree on the west abutment that is near the groin ditch should be removed.
- 3- All the broken or nonfunctional piezometers should be identified and abandoned properly.

Besides the above items, it is recommended that the plant begins monitoring water levels in the newly installed piezometers and wells. The quarterly inspection sheet should be updated to include the new wells and piezometers.

## 5.2 REGULAR MAINTENANCE ITEMS

The recommendations of this section are considered to be regular maintenance items that should be performed on regular basis to assure that the satisfactory condition of the facilities will be maintained. A facility-specific summary of recommendations is presented below.

### 5.2.1 RECLAIM POND

- 1- Cenospheres should be removed from the surface of the Reclaim Pond on regular basis.
- 2- The erosion rills on the slopes of the Reclaim Pond should be repaired by excavating the disturbed areas and placing rip-rap over fabric. The rip-rap protection will prevent re-occurrence of the erosion rills.
- 3- The areas with insufficient vegetative coverage should be seeded.
- 4- Monitoring of the instrumentation should be continued on quarterly basis.

### 5.2.2 POND IA

1. The seepage area on the lower section of the south dike, mentioned in the previous inspection reports, remains the primary concern at this facility. The plant shall continue monitoring the seepage flow from the pond for signs of piping or drastic changes in the flow rates or piezometric water levels. The wet area below the access road along the toe should be inspected frequently for signs of piping.
2. Erosion rills that form on the main dike or the splitter dike should be identified and repaired promptly

3. Any large rutting that develops on the crest of the main dike, the splitter dike, or any of the access roads should be repaired on a timely manner.
4. It is recommended that the plant continues to mow the slopes of the dike at least twice a year. The area of the west hillside that is within 25 feet horizontal distance from the center of the groin ditch should be properly seeded and mowed regularly.
5. A staff gage should be installed in 1A pond to facilitate water level readings.
6. Protective railing should be installed around the overflow structure from 1A to 1B ponds, unless this structure is abandoned properly.
7. The section of the slope not covered by rip-rap should be thoroughly inspected by the plant personnel twice a year to identify animal burrows. All the animal holes shall be mud-packed. Generally, a good time to inspect and mud-pack animal burrows is early spring. The second inspection can be performed early autumn. It is a good practice to mow the slopes before the inspections.
8. Operation of the seepage collection system and pumps must be maintained to ensure the structural integrity of the dikes. This includes continuing the periodic program to replace the toe drain system as necessary to prevent build up of chemical precipitates within the stone and piping system. The drainage pipe should be flushed or replaced periodically to prevent blockage due to accumulation of precipitates.

### 5.2.3 POND 1B

1. Seepage areas on the lower section of the dike, mentioned in previous inspection reports, still remain the main concern. Monitoring of the piezometers should be continued. The plant should continue monitoring the seepage flow from the pond for signs of piping or drastic changes in the flow rates.
2. The increasing number of animal burrows on the south slope of 1B pond is becoming a concern. It is recommended to install traps near the animal holes to control the population of the burrowing animals. Animal burrows on the slopes of the dike should be identified through regular inspections and mud-packed. Two inspections per year are recommended on early spring and early autumn, after each mow.
3. The eroded rills that form on the dike should be identified and repaired promptly.
4. Any large rutting that develops on the crest or any of the access roads should be repaired on a timely manner.

5. Bare areas on the outboard slope should be seeded to establish a proper vegetative cover.
6. It is recommended that the plant continues to mow the vegetative cover of the slopes twice a year. The area of east hillside within 25 feet horizontal distance from the edge of the groin ditch should be maintained free of any woody vegetation.
7. Cenospheres should be removed from the surface of the pool on regular basis.
8. The overflow structure shall be painted.
9. A new staff gage shall be installed in IB pond.

A good inspection and maintenance program needs to be emphasized especially in the area of instrumentation monitoring and maintaining routine vegetation and erosion control to preserve the intent of the design and operation of the facilities. Routine inspections, monitoring and maintenance by plant personnel should continue. If you have any questions with regard to this report, please do not hesitate to contact Behrad Zand at (614) 716-2873 (audinet 200-2873) or Pedro Amaya at (614) 716-2926 (audinet 200-2926).

**FIGURES**

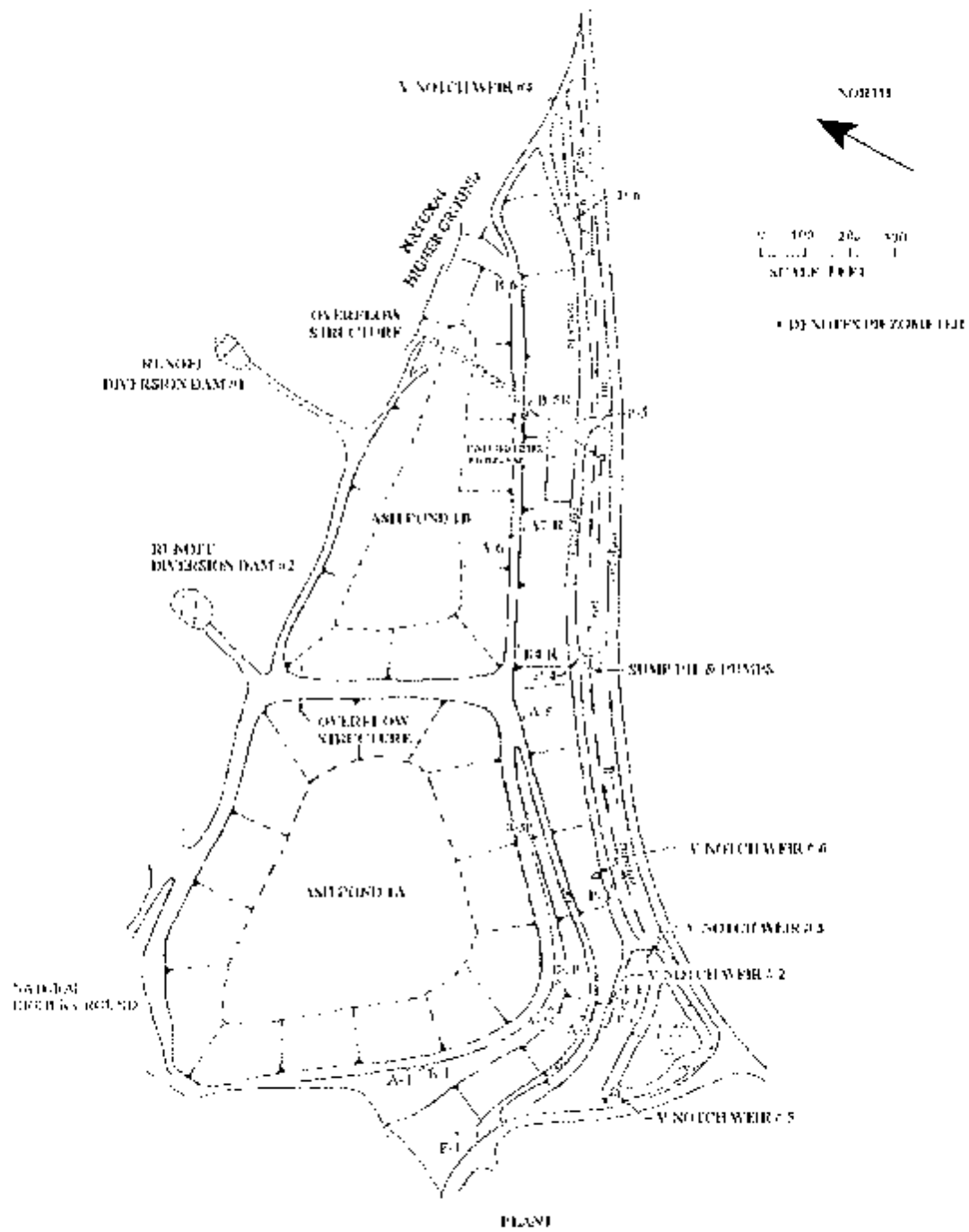

Figure 6. Piezometer location map







|                |   |                  |   |
|----------------|---|------------------|---|
| DATE: 11/15/78 | CLINCH RIVER POWER STATION<br>SHEET 2 of 5<br>POND 1A & 2 | DWS NO: FIGURE 2 | APP SERVICE CORP.<br>TRIPLEX PLAZA<br>COLUMBUS OH 43215 |
|----------------|---|------------------|---|



|   |  |            |  |
|---|--|------------|--|
| DATE: 1971<br>PROJECT: CLINCH RIVER POWER STATION<br>DRAWING NO: FIGURE 3 | CLINCH RIVER POWER STATION<br>SHEET 3 of 5<br>POND 1A & 1B | DATE: 1971 | AEP SERVICE CORP.<br>1 RIVERSIDE PLAZA<br>COLUMBUS, OH 43215 |
|---|--|------------|--|



|   |                                      |                          |                    |
|---|--------------------------------------|--------------------------|--------------------|
| <p>1. TITLE</p> <p>2. AUTHOR</p> <p>3. DATE</p> | <p>4. SUBJECT</p> <p>5. ABSTRACT</p> | <p>6. CLASSIFICATION</p> | <p>7. INDEXING</p> |
|---|--------------------------------------|--------------------------|--------------------|

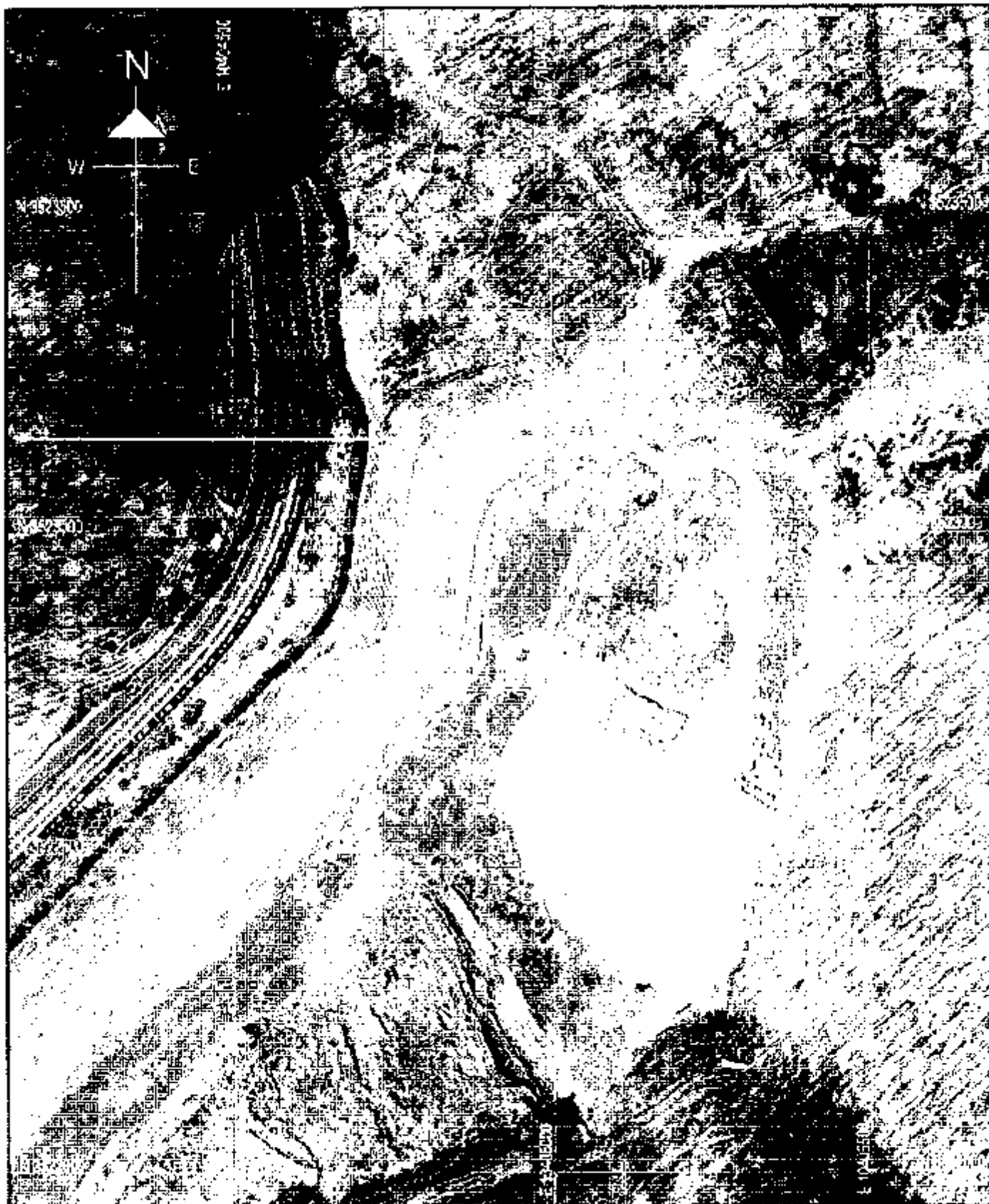

|  |   |  |   |
|--|---|--|---|
| DATE: 10/15/81<br>SCALE: 1:25000<br>PROJECT: 10000 | CLINTON RIVER POWER STATION<br>POND 2<br>SHEET 5 of 5 | JOB NO: E7694-5<br> AMERICAN ELECTRIC POWER | AEP SERVICE CENTER<br>7 HAVESON PLAZA<br>COLUMBUS, OH 43229 |
|--|---|--|---|

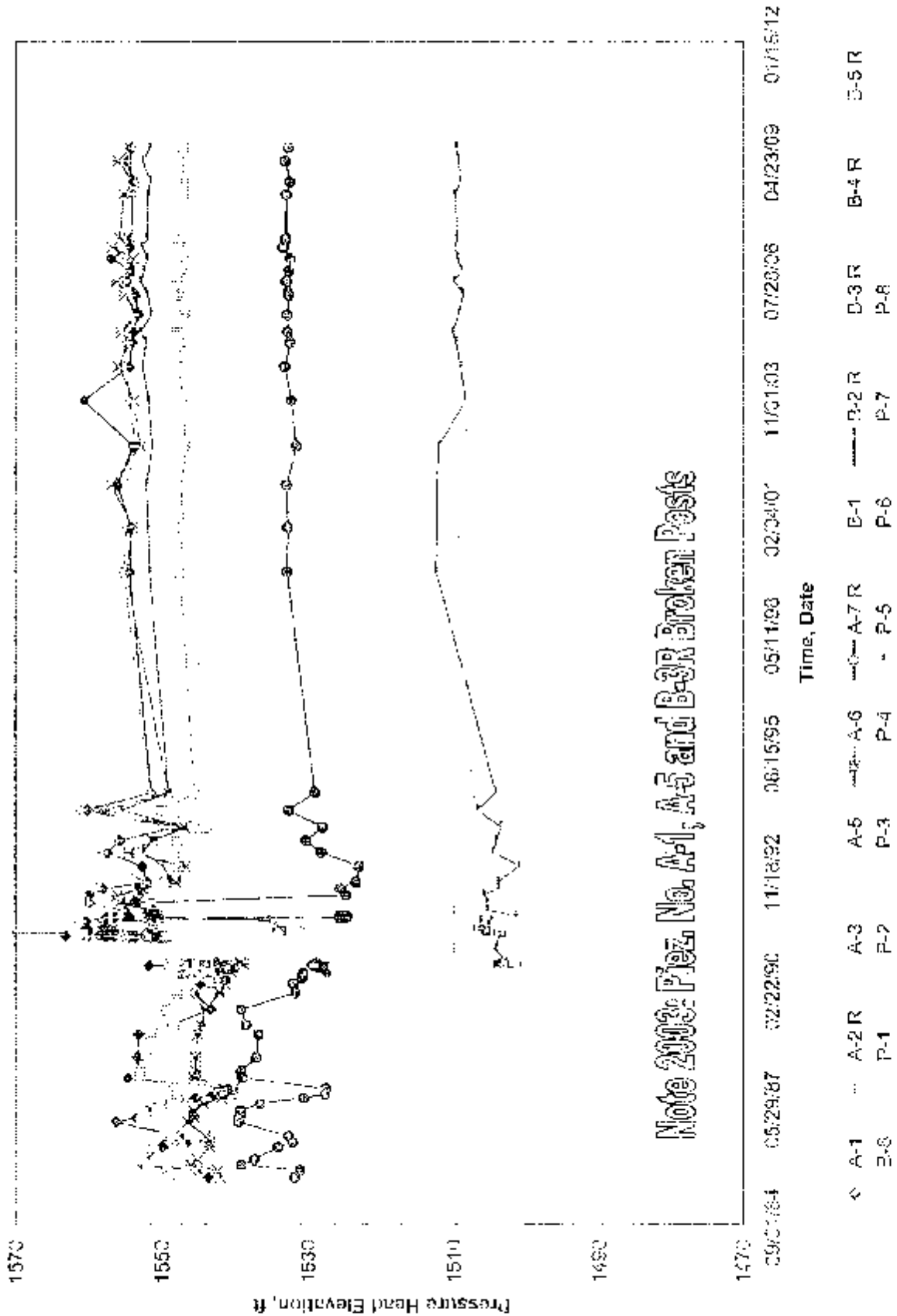

Figure 7. Piezometer readings since 1985

**RECLAIM POND PHOTOGRAPHS**

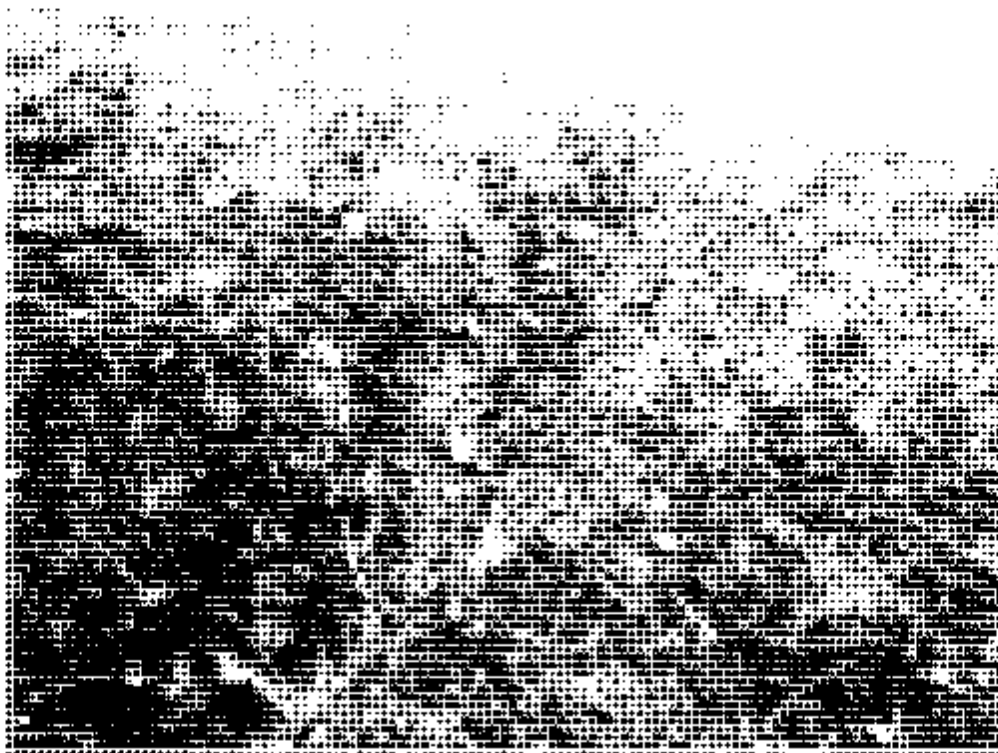

Photo 1. An erosion rill on the slope of the Reclaim Pond



Photo 2. Reclaim Pond viewed from the crest of West LA dike

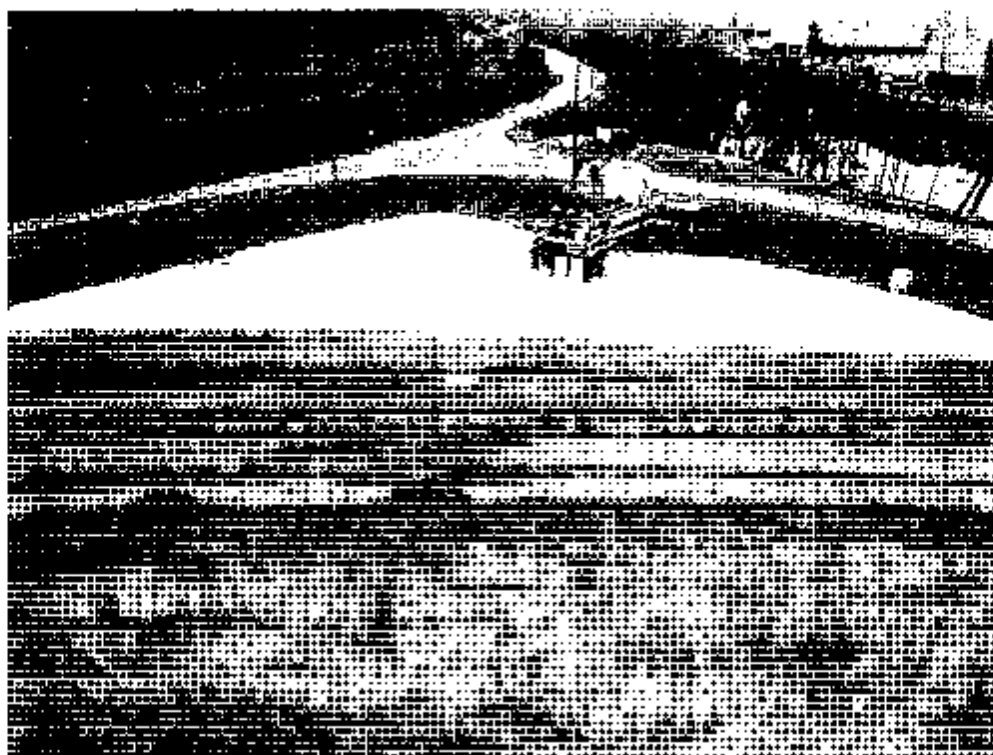

Photo 3. Reclaim Pond viewed from the crest of West LA dike



ASHTON POND LA PHOTOGRAPHS



Photo 4. Groin ditch of the West IA dike (western groin ditch)

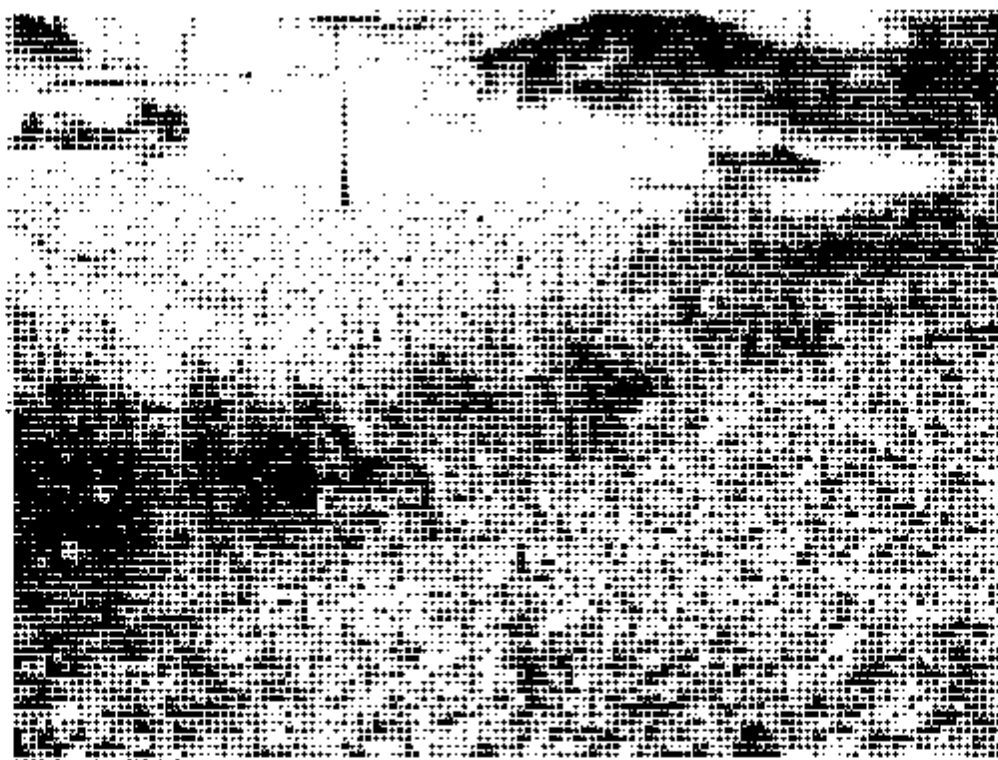

Photo 5. Rip-rap protection on the outboard slope of Pond IA near the groin ditch



Photo 6. Rip-rap protection of the outboard slope of the south 1A dike



Photo 7. South 1A dike above the access road



Photo 8. Build up of chemical precipitates in the toe drain pipes

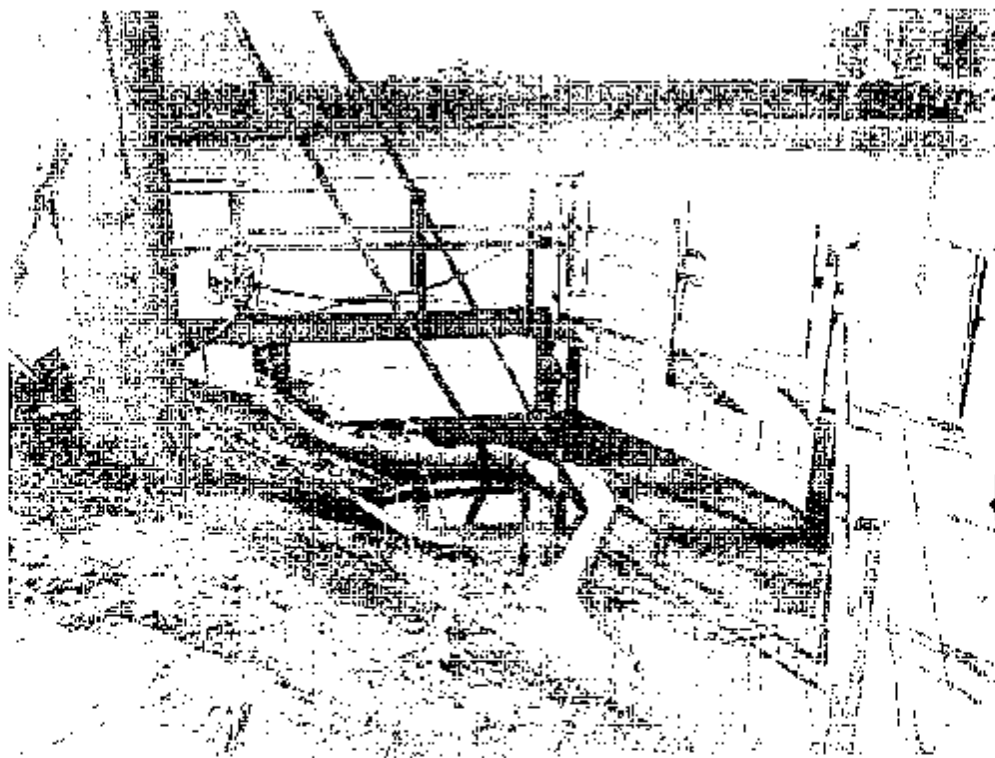

Photo 9. The overflow structure that discharges from IA to IB Ponds

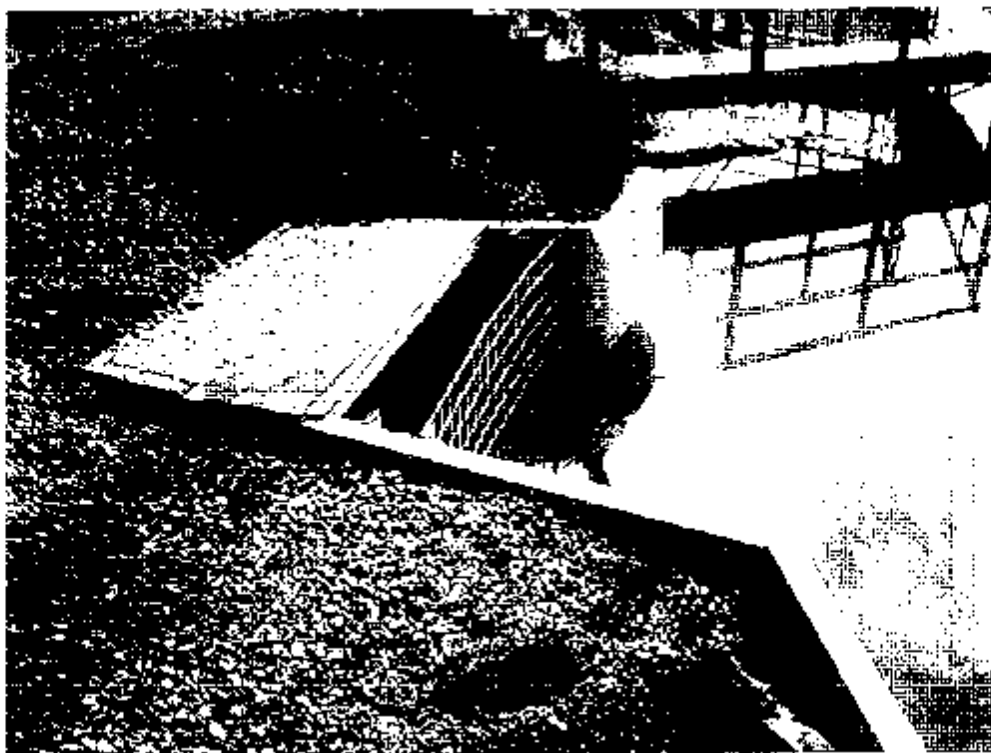

Photo 10. Inlet of the new spillway shaft from 1A to 1B ponds



Photo 11. Rock slope on the northeast of 1A pond

**ASH POND 1B PHOTOGRAPHS**



Photo 12. Groin ditch of 1B dike at the east side.

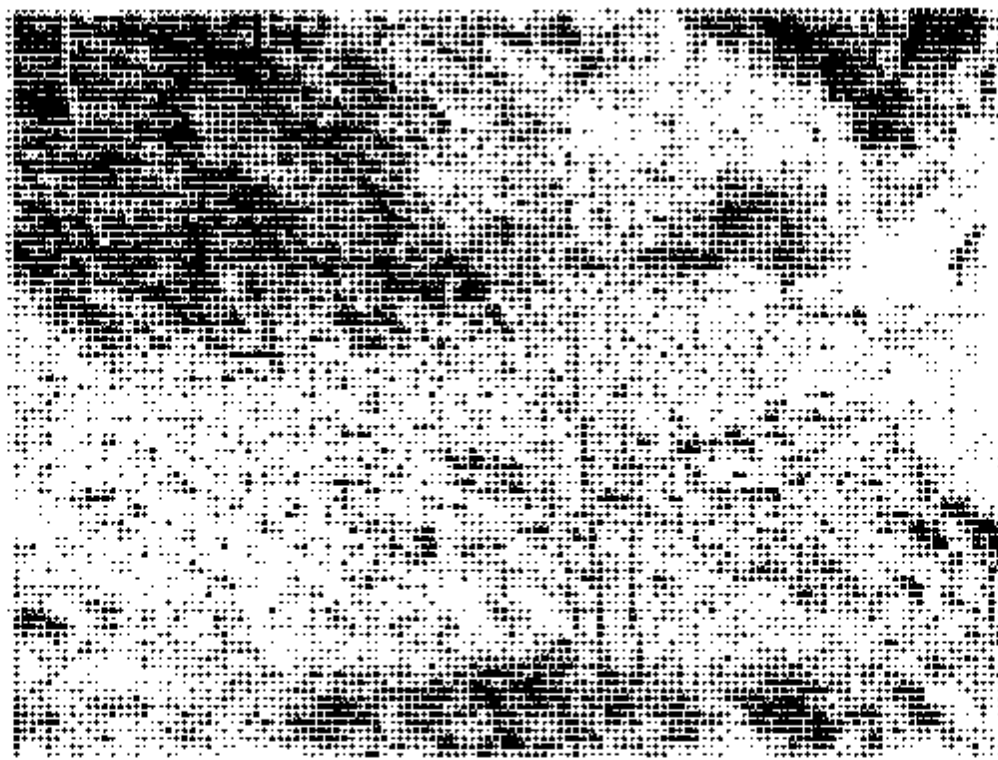

Photo 13. A portion of the east groin ditch and the slope next to it has rip-rap protection

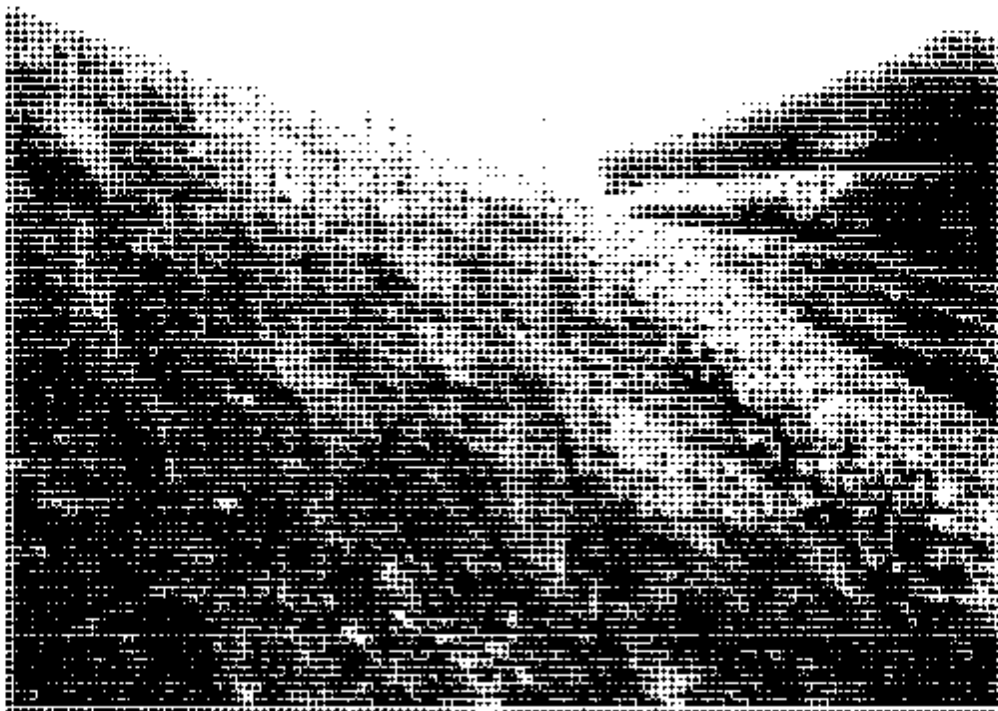

Photo 14. Outboard slope of south 113 dike. The lower half of the slope has rip-rap protection

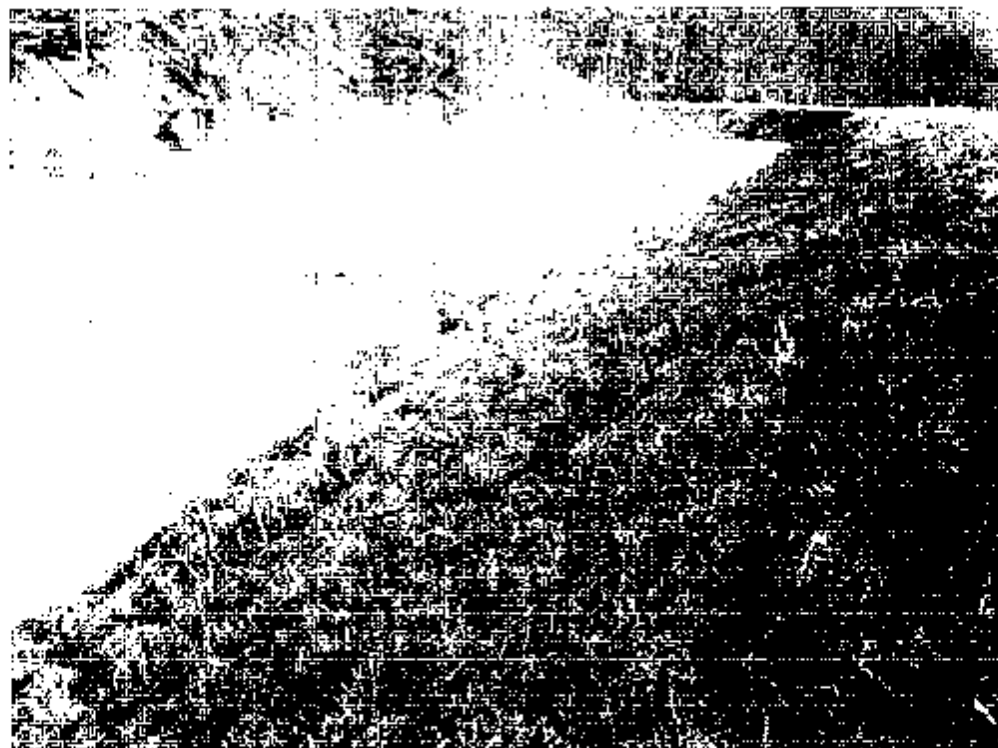

Photo 15. Inboard slope of 113 dike



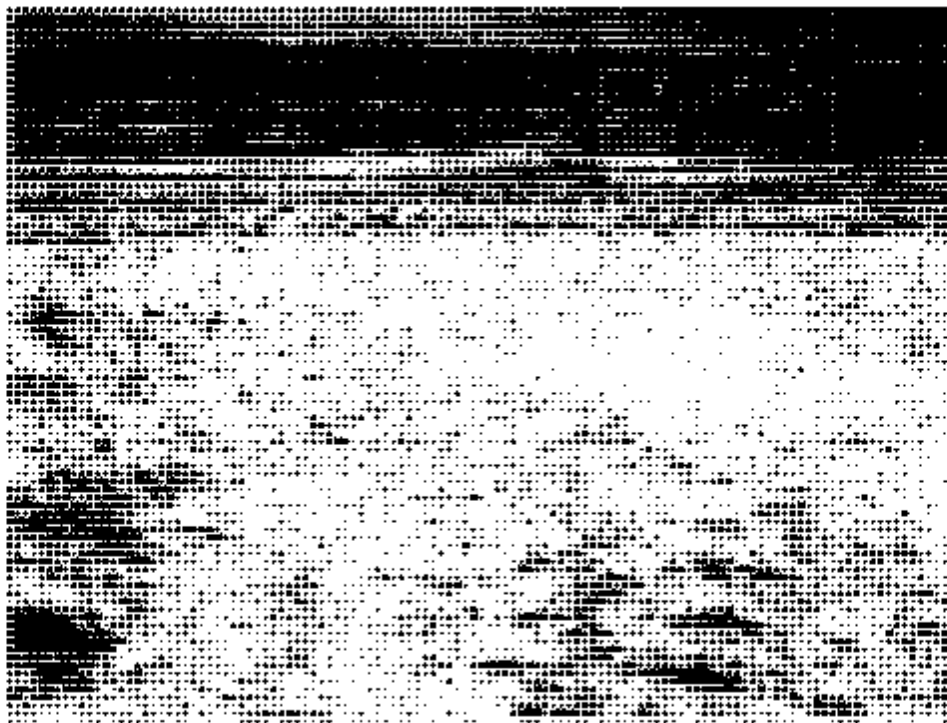

Photo 16. A bare area on the south 1B slope of the dike above the rip-rap. This portion of the slope is susceptible to erosion.



Photo 17. An erosion development at the toe of 1B dike



Photo 18. Corrosion of the decant structure of 1B pond

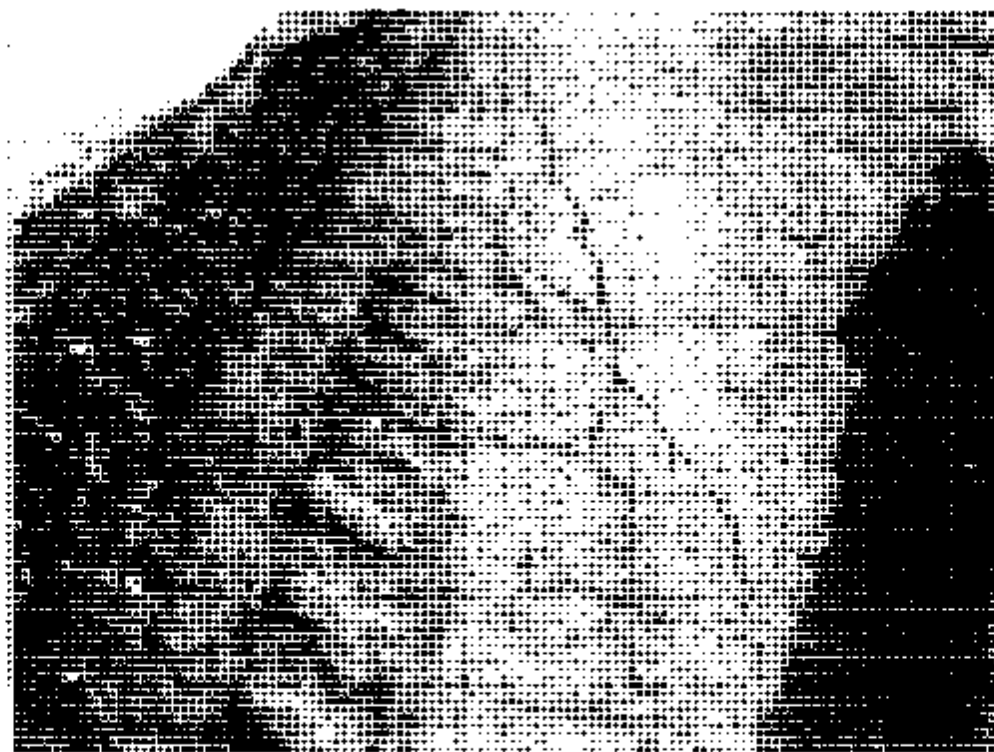

Photo 19. Settlement cracks on the newly constructed portion of the splitter dike

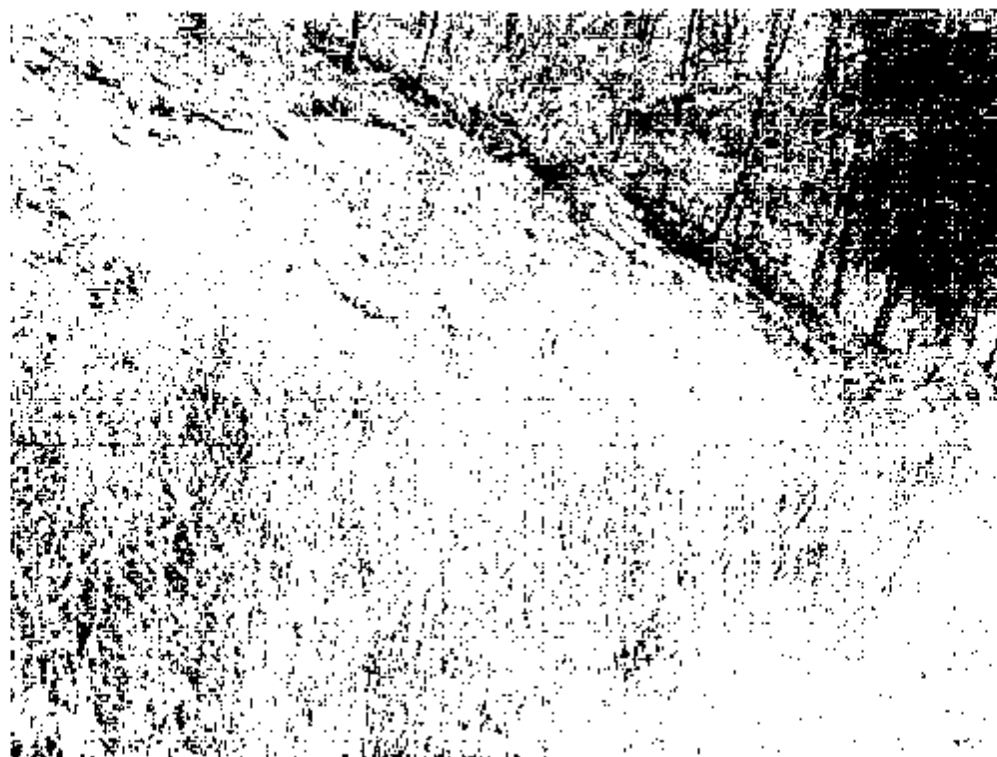

Photo 20. An old slide on the hillside near the east groin ditch above weir box No. 4

\* FOR INFORMATIONAL PURPOSES ONLY\*

|   | COMPANY Appalachian Power Company  | Appalachian Power Company   |  |
|---|--|---|--|
|   | PLANT Clinch River   | Clinch River  |  |
|   | ASH MANAGEMENT UNIT Bottom Ash Pond 1A/1B  | Bottom Ash Pond 2   |  |
| <b>QUESTION 1</b>                       | Dam Hazard Rating<br>Who Established Rating<br>Basis for Rating<br>No Rating Assigned  | Low<br>VA DCR<br>Health Hazard<br>N/A   | Low<br>VA DCR<br>Health Hazard<br>N/A  |
| <b>QUESTION 2</b>                       | Year Commissioned<br>Year(s) Expanded  | 1964<br>Modified 1971   | 1964<br>Placed out of service in 1998. closure plan submitted for regulatory approval in 2009  |
| <b>QUESTION 3 - Mark all that apply</b> | Fly Ash<br>Bottom Ash<br>Boiler Slag<br>Flue Gas Emission Control Residuals<br>Other (Specify)   | X<br>X  | X<br>X   |
| <b>QUESTION 4</b>                       | Designed by P.E.<br>Constructed under P.E. Supervision<br>Inspection/monitoring under P.E. Supervision   | Not Available<br>Not Available<br>Yes   | Not Available<br>Not Available<br>Yes  |
| <b>QUESTION 5</b>                       | Date of Last Company Safety Assessment<br><br>Describe Evaluator's Credentials<br>Describe Past Followup Corrective Actions<br>Describe Credentials of Corrective Action Implementers<br>Describe Planned Followup Actions | 1/7/2009<br><br>VA P E<br>Routine maintenance. Enhance seepage control<br>Subcontractor under plant supervision<br>1A -- reassess stability of dike. 1B --<br>Continue seepage control implementation on D/S slope. Routine maintenance(1A & 1B)      | 9/10/2003: Slope stability, liquefaction, and settlement analyses performed in 2008 as part of final closure design<br>VA P E<br>Routine maintenance<br>Under plant supervision<br>Routine maintenance |
| <b>QUESTION 6</b>                       | Date of Next Safety Assessment   | 2010  | None (no free water in reservoir)  |
| <b>QUESTION 6</b>                       | Date of Last Regulatory Safety Inspection<br>Agency Name<br>Date of Planned Regulatory Safety Inspection<br>Agency Name<br>Copy of Most Recent Regulatory Inspection Included  | 3/19/2008<br>Va DCR<br>N/A<br>N/A<br>Yes  | 3/19/2008<br>Va DCR<br>N/A<br>N/A<br>Yes   |
| <b>QUESTION 7</b>                       | Safety Issues from Regulatory Inspections w/in Past Year<br>Corrective Actions<br>Documentation Included   | N/A<br>N/A<br>N/A   | N/A<br>N/A<br>N/A  |
| <b>QUESTION 8</b>                       | Surface Area (acres)<br>Total Storage Capacity<br>Volume Currently Stored<br>Date of Volume Measurement<br>Maximum Height (feet)   | 45 acres - This pond complex consists of a single pond (based on regulation under dam safety rules) which has been subdivided into two cells<br>1 240 acre-ft<br>Variable - ash is routinely removed for use or disposal in dry landfill<br>N/A<br>55 | No active impounding water area. No ash is currently sluiced to this inactive pond. A closure plan has been submitted to VDEQ for approval.<br>1,332 acre-ft<br>1,332 acre-ft (estimated)<br>N/A<br>73 |
| <b>QUESTION 9</b>                       | Spills or Unpermitted Release History (10 Years)   | No  | No   |
| <b>QUESTION 10</b>                      | All legal owner(s) and operator(s)   | Appalachian Power Company   | Appalachian Power Company  |

CLINCH

AFPCR000119

\*FOR INFORMATIONAL PURPOSES ONLY\*



**AMERICAN  
ELECTRIC  
POWER**

American Electric Power  
1 Riverside Plaza  
Columbus OH 43215-2073  
www.aep.com

Thomas J Roberts P E - Region 4 Dam Safety Engineer  
Virginia Department of Conservation and Recreation  
Dam Safety Program  
8 Radford St  
Christiansburg, Virginia 24073

April 17, 2009

Re: Clinch River Fly Ash Dike No 1 (16703)  
Clinch River Fly Ash Dike No 2 (16702)  
Glen Lyn Fly Ash Dam (07101)  
Glen Lyn Bottom Ash Dam (07102)

Dear Mr. Roberts:

Enclosed please find the completed Annual Inspection Report forms the Clinch River facility, Ash Ponds 1A and 1B (Fly Ash Dike No 1), and the Glen Lyn facility, Fly Ash Dam and Bottom Ash Dam for 2009

If you have any questions, or if I can be of further assistance, please do not hesitate to contact me at (614) 716-2906

Sincerely,

William R. Smith  
AEP Service Corp., Civil Engineering  
wrsmith@aep.com

Attachments: 1. 2009 Annual Dam Inspection Report – Clinch River Plant  
2. 2009 Annual Dam Inspection Report – Glen Lyn Plant

cc: J Saunders – Clinch River (w/ Clinch River attachments)  
J Ryder – Glen Lyn (w/ Glen Lyn attachments)  
P J Amaya – AEP Service Corp., Geotechnical Engineering (w/o attachments)  
File

US EPA ARCHIVE DOCUMENT



Date Prepared: 2-13-2009  
 Prepared By: Behrad Zand

**ANNUAL INSPECTION REPORT FOR VIRGINIA REGULATED IMPOUNDING STRUCTURES**

Reference: Impounding Structures Regulations, 4VAC 50-20-10 et seq., including 4VAC 50-20-105, Virginia Soil and Water Conservation Board

**Owner's Information**

Name of Dam: Clinch River Ash Pond 1A and 1B Inventory Number: 16703  
 Owner's Name: Appalachian Power Co. Location-County/City: Russell County  
 Contact Person (if different from above): Pedro J. Amaya  
 Owner's Address: P.O. Box 2021-Clinch River Hazard Classification: III  
 Name of Reservoir: Roanoke, VA 24022  
 Purpose of Reservoir: \_\_\_\_\_  
 Telephone No: (Residential) \_\_\_\_\_ (Business) 267-889-7324  
 Other means of communication: \_\_\_\_\_

**Owner's Engineer**

Name of Engineering Firm and Engineer: American Electric Power Service Corporation ; Pedro J. Amaya, PE  
 Professional Engineer Virginia License Number: 036174  
 Mailing Address: 1 Riverside Plaza, Columbus, OH 43215  
 Telephone No: (Business) 614-716-2926

Directions: Make note of all pertinent conditions and changes since the last inspection, or, if this is the first inspection, since the filing of a design report.

Date of This Inspection 1-7-2009  
 Date of Last Inspection 10-31-2007

**1. EMBANKMENT**

- a Any alteration made to the embankment? No
- b Erosion on embankment? Minor erosion on the slope of the drainage ditch
- c Settlement, misalignment or cracks in embankment? No
- d Seepage? If so, seepage flow rate and location (describe any turbidity and observed color within the flow): Clear seepage at the toe area. The facility has a seepage collection system and seepage quantities are measured on regular basis.

**2. UPSTREAM SLOPE**

- a Woody vegetation discovered? No
- b Rodent burrows discovered? No
- c Remedial work performed? No

**3. INTAKE STRUCTURE** NOTE: The intake structure consists of a steel decant tower and a concrete culvert

- a Deterioration of concrete? No
- b Exposure of rebar reinforcement? No
- c Is there a need to repair or replace the trash rack? No
- d Any problems with debris? No
- e Was the drawdown valve operated? No

US EPA ARCHIVE DOCUMENT

**4. ABUTMENT CONTACTS**

a. Any seepage? If so, estimate the flow rate and describe the location of the seep or damp areas (describe any turbidity and observed color within the flow):

No

**5. EARTHEN EMERGENCY SPILLWAY**

a. Obstructions to flow? If so, describe plans to correct: NA

b. Rodent burrows discovered? NA

c. Any deterioration in the approach or discharge channel? NA

**6. CONCRETE EMERGENCY SPILLWAY**

a. Deterioration of concrete? NA

b. Exposed steel reinforcement? NA

c. Any leakage below concrete spillway? NA

d. Obstructions to flow? If so, lists plans to correct: NA

**7. DOWNSTREAM SLOPE**

a. Woody vegetation discovered? No

b. Rodent burrows discovered? Yes

c. Are seepage drains flowing? No

d. Any seepage or wet areas? No - All the wet areas reported in the previous inspection reports are now covered and protected by riprap over fabric.

**8. OULET PIPE**

a. Any water flowing outside of discharge pipe through the  
impounding Structure? No

b. Describe any deflection or damage to the pipe: No

**9. STILLING BASIN**

a. Deterioration of concrete structures? NA

b. Exposure of rebar reinforcement? NA

c. Deterioration of the basin slopes? NA

d. Repairs made? NA

e. Any obstruction to flow? NA

**10. GATES**

a. Gate malfunctions or repairs? NA

b. Corrosion or damage? NA

c. Were any gates operated? If so, how often and to what extreme? NA

**11. RESERVOIR/WATERSHED**

a. New developments upstream of dam? No

b. Slides or erosion of lake banks around the rim? No

c. General comments to include silt, algae or other influence factors: No

**12. INSTRUMENTS**

- a List all instruments 20 piezometers and 5 V-notched weirs
- b Any readings of instruments? Readings are taken on quarterly basis
- c Any installation of new instruments? No

**13. DOWNSTREAM/HAZARD ISSUES**

- a New development in downstream inundation zone? No
- b Note the maximum storm water discharge or peak elevation during the previous year Not measured
- c Was general maintenance performed on dam? If so, when? Trees were removed from abutment area on Jan. 2009
- d List actions that need to be accomplished before the next inspection:  
1- Continue placing riprap on the downstream slope of 1B dike; 2- Reclassify the facility based on the new code; and  
3- Reassess the safety of the facility according to the new regulations

**14. OVERALL EVALUATION OF IMPOUNDING STRUCTURE AND APPUR TENANCES**

(Check one)  EXCELLENT  GOOD  POOR

General Comments: We understand that the Impounding Structure Regulations have recently been updated and that based on the new regulations the Hazard Classification of this facility should most likely be updated to "Significant". In response to correspondence we received from DCR on October 7, 2008 a new study was started and is in progress to reassess the hazard classification of the facility.

Recommendations: 1- Continue to place riprap on the downstream slope; 2- Continue to mow the slopes on regular basis; 3- Continue quarterly monitoring of the instrumentation; 4- Mud-pack the animal burrows; 5- Continue quarterly and annual inspections; and 6- continue the general maintenance



**CERTIFICATION BY OWNER'S ENGINEER (required only when an inspection by an engineer is required)**

I hereby certify that the information provided in this report has been examined by me and found to be true and correct in my professional judgment

Signed: \_\_\_\_\_ Virginia Number: \_\_\_\_\_  
Professional Engineer's Signature Print Name

This \_\_\_\_\_ day of \_\_\_\_\_, 20 \_\_\_\_\_

Engineer's Virginia Seal:

**CERTIFICATION BY OWNER**

I hereby certify that the information provided in this report has been examined by me

Signed: \_\_\_\_\_  
Owner's Signature Print Name  
*Ricky L. Clark*

This 26 day of February, 20 09

Mail the executed form to the appropriate  
Department of Conservation and Recreation  
Division of Dam Safety and Floodplain Management  
Regional Engineer



Virginia Department of Conservation & Recreation  
 State Parks • Soil & Water Conservation • Natural Heritage  
 Chesapeake Bay Local Assistance • Land Conservation  
 Outdoor Recreation Planning • Dam Safety & Floodplains

Date Prepared: 2-13-2009  
 Prepared By: Behrad Zand

**ANNUAL INSPECTION REPORT FOR VIRGINIA REGULATED IMPOUNDING STRUCTURES**

Reference: Impounding Structures Regulations, 4VAC 50-20-10 et seq., including 4VAC 50-20-105, Virginia Soil and Water Conservation Board

**Owner's Information**

Name of Dam: Clinch River Ash Pond 2 Inventory Number: 16702  
 Owner's Name: Appalachian Power Co. Location-County/City: Russell County  
 Contact Person (if different from above): Pedro J. Amaya  
 Owner's Address: P.O. Box 2021-Clinch River Hazard Classification: III  
 Name of reservoir: Roanoke, VA 24022  
 Purpose of reservoir: \_\_\_\_\_  
 Telephone No: (Residential) \_\_\_\_\_ (Business) 567-889-7324  
 Other means of communication: \_\_\_\_\_

**Owner's Engineer**

Name of Engineering Firm and Engineer: American Electric Power Service Corporation, Pedro J. Amaya, PE VA  
 Professional Engineer Virginia License Number: 036174  
 Mailing Address: 1 Riverside Plaza, Columbus, OH 43215  
 \_\_\_\_\_  
 Telephone No: (Business) 614-716-2926

Directions: Make note of all pertinent conditions and changes since the last inspection, or, if this is the first inspection, since the filing of a design report.

Date of This Inspection NA  
 Date of Last Inspection NA

**1. EMBANKMENT**

- a Any alteration made to the embankment? NA
- b Erosion on embankment? NA
- c Settlement, misalignment or cracks in embankment? NA
- d Seepage? If so, seepage flow rate and location (describe any turbidity and observed color within the flow): NA

**2. UPSTREAM SLOPE**

- a Woody vegetation discovered? NA
- b Rodent burrows discovered? NA
- c Remedial work performed? NA

**3. INTAKE STRUCTURE**

- a Deterioration of concrete? NA
- b Exposure of rebar reinforcement? NA
- c Is there a need to repair or replace the trash rack? NA
- d Any problems with debris? NA
- e Was the drawdown valve operated? NA

US EPA ARCHIVE DOCUMENT

**4. ABUTMENT CONTACTS**

a. Any seepage? If so, estimate the flow rate and describe the location of the seep or damp areas (describe any turbidity and observed color within the flow):

NA

---

**5. EARTHEN EMERGENCY SPILLWAY**

a. Obstructions to flow? If so, describe plans to correct: NA

b. Rodent burrows discovered? NA

c. Any deterioration in the approach or discharge channel? NA

---

**6. CONCRETE EMERGENCY SPILLWAY**

a. Deterioration of concrete? NA

b. Exposed steel reinforcement? NA

c. Any leakage below concrete spillway? NA

d. Obstructions to flow? If so, lists plans to correct: NA

---

**7. DOWNSTREAM SLOPE**

a. Woody vegetation discovered? NA

b. Rodent burrows discovered? NA

c. Are seepage drains flowing? NA

d. Any seepage or wet areas? NA

---

**8. OUTLET PIPE**

a. Any water flowing outside of discharge pipe through the Impounding Structure? NA

b. Describe any deflection or damage to the pipe: NA

---

**9. STILLING BASIN**

a. Deterioration of concrete structures? NA

b. Exposure of rebar reinforcement? NA

c. Deterioration of the basin slopes? NA

d. Repairs made? NA

e. Any obstruction to flow? NA

---

**10. GATES**

a. Gate malfunctions or repairs? NA

b. Corrosion or damage? NA

c. Were any gates operated? If so, how often and to what extreme? NA

---

**11. RESERVOIR/WATERSHED**

a. New developments upstream of dam? NA

b. Slides or erosion of lake banks around the rim? NA

c. General comments to include silt, algae or other influence factors: NA

---

12. INSTRUMENTS

- a List all instruments NA
- b Any readings of instruments? NA
- c Any installation of new instruments? NA

13. DOWNSTREAM/HAZARD ISSUES

- a New development in down-stream inundation zone? NA
- b Note the maximum storm water discharge or peak elevation during the previous year NA
- c Was general maintenance performed on dam? If so, when? NA
- d List actions that need to be accomplished before the next inspection: NA

14. OVERALL EVALUATION OF IMPOUNDING STRUCTURE AND APPURTENANCES

NA  
 (Check one)  EXCELLENT  GOOD  POOR

General Comments:

This facility was dewatered in 1998 and has been out of service since then. An application for the permanent closure of the facility has been filed with the regulator authorities.

Recommendations:

\_\_\_\_\_  
 \_\_\_\_\_  
 \_\_\_\_\_

**CERTIFICATION BY OWNER'S ENGINEER (required only when an inspection by an engineer is required)**

I hereby certify that the information provided in this report has been examined by me and found to be true and correct in my professional judgment

Signed: \_\_\_\_\_ Virginia Number: \_\_\_\_\_  
Professional Engineer's Signature Print Name

This \_\_\_\_\_ day of \_\_\_\_\_, 20 \_\_\_\_\_

Engineer's Virginia Seal:

**CERTIFICATION BY OWNER**

I hereby certify that the information provided in this report has been examined by me

Signed: Ricky L. Clatta \_\_\_\_\_  
Owner's Signature Print Name

This 26 day of February, 20 09

Mail the executed form to the appropriate  
Department of Conservation and Recreation  
Division of Dam Safety and Floodplain Management  
Regional Engineer

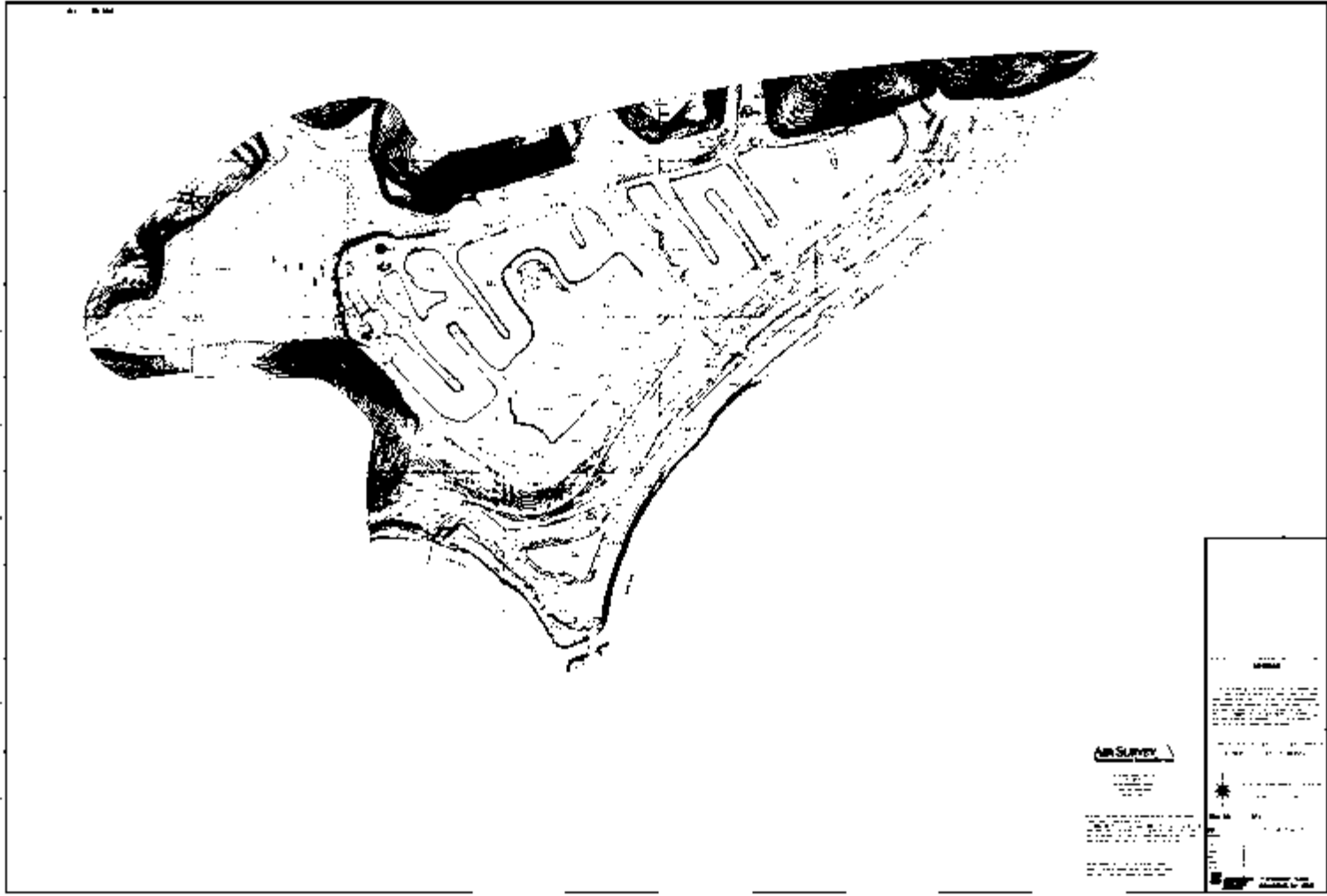

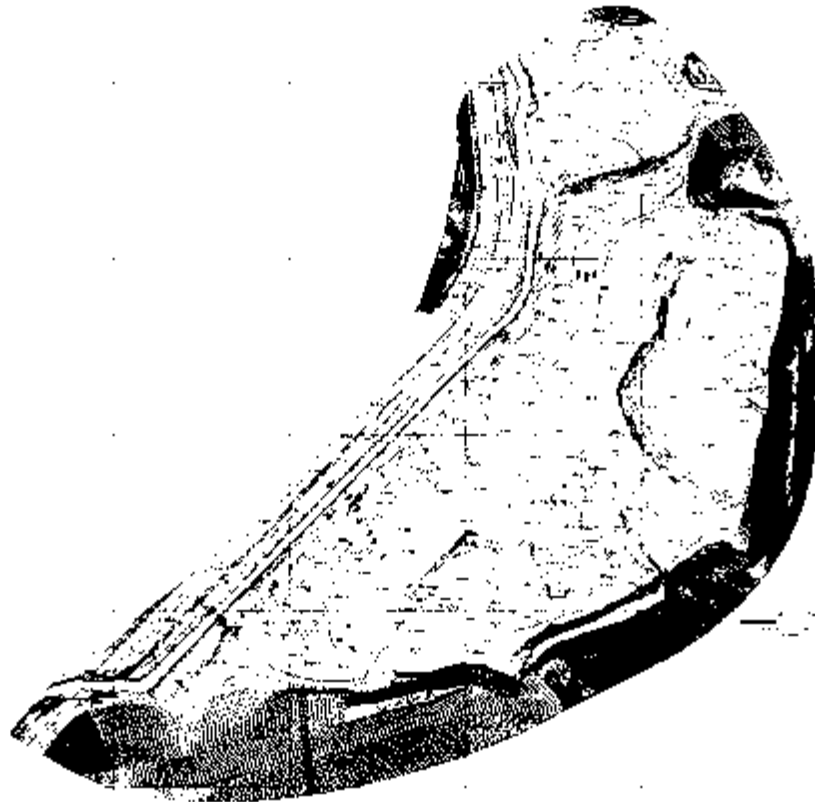

# APPENDIX B





## Coal Combustion Dam Inspection Checklist Form

|                          |                                     |  |  |
|--------------------------|-------------------------------------|--|--|
| <b>Site Name:</b>        | <b>Clinch River Plant</b>           | <b>Date:</b>   | <b>February 17, 2011</b>   |
| <b>Unit Name:</b>        | <b>ASH POND 1<br/>(Ponds 1A/1B)</b> | <b>Operator's Name:</b>                                | <b>Appalachian Power</b>   |
| <b>Unit I.D.:</b>        | <b>VA16703</b>                      | <b>Hazard Potential Classification:</b>                | High <input type="checkbox"/> Significant <input checked="" type="checkbox"/> Low <input type="checkbox"/> |
| <b>Inspector's Name:</b> |                                     | Scott Clarke, P.E. and Loraine Ramos Nieves, P.E., CFM |  |

Check the appropriate box below. Provide comments when appropriate. If not applicable or not available, record "N/A". Any unusual conditions or construction practices that should be noted in the comments section. For large diked embankments, separate checklists may be used for different embankment areas. If separate forms are used, identify approximate area that the form applies to in comments.

**Note: Comments regarding each issue number have been listed below as needed.**

| Issue #  | Yes | No  | Issue #   | Yes | No |
|--|-----|-----|---|-----|----|
| 1. Frequency of Company's Dam Inspections?   | ✓   |     | 18. Sloughing or bulging on slopes?   |     | ✓  |
| 2. Pool elevation (operator records)?  | ✓   |     | 19. Major erosion or slope deterioration?   |     | ✓  |
| 3. Decant inlet elevation (operator records)?  |     | ✓   | 20. Decant Pipes:   |     |    |
| 4. Open channel spillway elevation (operator records)?   |     | N/A | Is water entering inlet, but not exiting outlet?  |     | ✓  |
| 5. Lowest dam crest elevation (operator records)?  | ✓   |     | Is water exiting outlet, but not entering inlet?  |     | ✓  |
| 6. If instrumentation is present, are readings recorded (operator records)?                                  | ✓   |     | Is water exiting outlet flowing clear?  | ✓   |    |
| 7. Is the embankment currently under construction?   |     | ✓   | 21. Seepage (specify location, if seepage carries fines, and approximate seepage rate below): |     |    |
| 8. Foundation preparation (remove vegetation, stumps, topsoil in area where embankment fill will be placed)? |     | ✓   | From underdrain?  | ✓   |    |
| 9. Trees growing on embankment? (If so, indicate largest diameter below)                                     |     | ✓   | At isolated points on embankment slopes?  | ✓   |    |
| 10. Cracks or scarps on crest?   |     | ✓   | At natural hillside in the embankment area?   | ✓   |    |
| 11. Is there significant settlement along the crest?   |     | ✓   | Over widespread areas?  |     | ✓  |
| 12. Are decant trashracks clear and in place?  | ✓   |     | From downstream foundation area?  |     | ✓  |
| 13. Depressions or sinkholes in tailings surface or whirlpool in the pool area?                              |     | ✓   | "Boils" beneath stream or ponded water?   |     | ✓  |
| 14. Clogged spillways, groin or diversion ditches?   |     | ✓   | Around the outside of the decant pipe?  |     | ✓  |
| 15. Are spillway or ditch linings deteriorated?  |     | ✓   | 22. Surface movements in valley bottom or on hillside?  |     | ✓  |
| 16. Are outlets of decant or underdrains blocked?  |     | ✓   | 23. Water against downstream toe?   |     | ✓  |
| 17. Cracks or scarps on slopes?  |     | ✓   | 24. Were Photos taken during the dam inspection?  | ✓   |    |

Major adverse changes in these items could cause instability and should be reported for further evaluation. Adverse conditions noted in these items should normally be described (extent, location, volume, etc.) in the space below and on the back of this sheet.

| Issue #   | Comments   |
|-----------|--|
| 1.        | Impoundments are inspected quarterly by the plant personnel, and annually through an outside consultant.   |
| 2.        | Operating pool elevations for Pond 1A and Pond 1B are 1565 and 1558, respectively.   |
| 6.        | Twenty piezometers and a staff gage in both Pond 1A and Pond 1B exist at Ash Pond 1. Readings are monitored in the plant's Dam Inspection Checklist.   |
| 5.        | The lowest crest elevation for the Ash Pond 1 is 1570.0'.  |
| 16. & 20. | Pond 1A outfalls into Pond1B. Pond 1B outlets into a Reclaim Pond. Both pipes were completely submerged and not visible for inspection. The Reclaim Pond discharge is piped back to the plant to an onsite water treatment |



|     |  |
|-----|--|
|     | facility for continued use onsite.   |
| 21. | The side hill embankment of Ash Pond 1 has an elaborate seepage control system, consisting of perforated pipe toe drains that run the length of the embankment, which collects seepage at several areas along the embankment either directly from cross drains or from v-notch weirs that collect seepage discharge. All seepage discharge originating from cross drains and v-notch weirs were notably clear and free of fines or sediment. A rate of discharge was not determined on the site visit; however, a completed quarterly inspection report, titled Dike Inspection Checklist, indicating flow rates for each v-notch weir has been requested. The north outside embankment groin was observed to be conveying some minor clear seepage flow. The south outside embankment groin was dry but was noted to have signs of erosion due to storm runoff. |
| *   | An animal burrow was observed along the southern most part of the embankment of Pond 1A. The burrow was small in size and near the crest of the embankment.  |

US EPA ARCHIVE DOCUMENT



## Coal Combustion Waste (CCW) Impoundment Inspection

**Impoundment NPDES Permit** N/A

**INSPECTOR** Scott Clarke, P.E. and Lorainne Ramos Nieves, P.E., CFM

**Date** February 17, 2011  
**Impoundment Name** Ash Pond 1 (Ponds 1A /1B)

**Impoundment Company** AEP, Appalachian Power  
**EPA Region** 3

**State Agency (Field Office) Address** Virginia Department of Conservation & Recreation, Division of Dam Safety and Floodplain Management; 8 Radford St., Suite 201 Christiansburg, VA 24073

**Name of Impoundment** Ash Pond 1 (Ponds 1A /1B)

*(Report each impoundment on a separate form under the same Impoundment NPDES Permit number)*

**New**  **Update**

|   | <b>Yes</b>                          | <b>No</b>                           |
|---|-------------------------------------|-------------------------------------|
| <b>Is impoundment currently under construction?</b>                 | <input type="checkbox"/>            | <input checked="" type="checkbox"/> |
| <b>Is water or ccw currently being pumped into the impoundment?</b> | <input checked="" type="checkbox"/> | <input type="checkbox"/>            |

**IMPOUNDMENT FUNCTION:** Settling pond for bottom ash disposal.

**Nearest Downstream Town Name:** St. Paul, VA

**Distance from the impoundment:** 6.0 mi.

**Location:**

**Latitude** 36 Degrees 56 Minutes 14.0 Seconds **N**

**Longitude** 82 Degrees 11 Minutes 51.1 Seconds **W**

**State** Virginia **County** Russell

**Does a state agency regulate this impoundment?** Yes  No

**If So Which State Agency?** Virginia DCR, Division of Dam Safety and Floodplain Management

US EPA ARCHIVE DOCUMENT

**HAZARD POTENTIAL** *(In the event the impoundment should fail, the following would occur):*

- LESS THAN LOW HAZARD POTENTIAL:** Failure or misoperation of the dam results in no probable loss of human life or economic or environmental losses.
- LOW HAZARD POTENTIAL:** Dams assigned the low hazard potential classification are those where failure or misoperation results in no probable loss of human life and low economic and/or environmental losses. Losses are principally limited to the owner's property.
- SIGNIFICANT HAZARD POTENTIAL:** Dams assigned the significant hazard potential classification are those dams where failure or misoperation results in no probable loss of human life but can cause economic loss, environmental damage, disruption of lifeline facilities, or can impact other concerns. Significant hazard potential classification dams are often located in predominantly rural or agricultural areas but could be located in areas with population and significant infrastructure.
- HIGH HAZARD POTENTIAL:** Dams assigned the high hazard potential classification are those where failure or misoperation will probably cause loss of human life.

**DESCRIBE REASONING FOR HAZARD RATING CHOSEN:**

Ash Pond 1 is adjacent to State Routes 616 and 665 as well as the Norfolk and Western Railway. In addition, the facility is located immediately upstream of Clinch River and Dump's Creek. The Clinch River Plant is located immediately south of the facility just across the Clinch River. A failure of this facility would impact State Route 616 and/or State Route 665 and potentially the existing railroad. While no probable loss of human life is expected, economic and environmental damage would be expected.



**CONFIGURATION:**

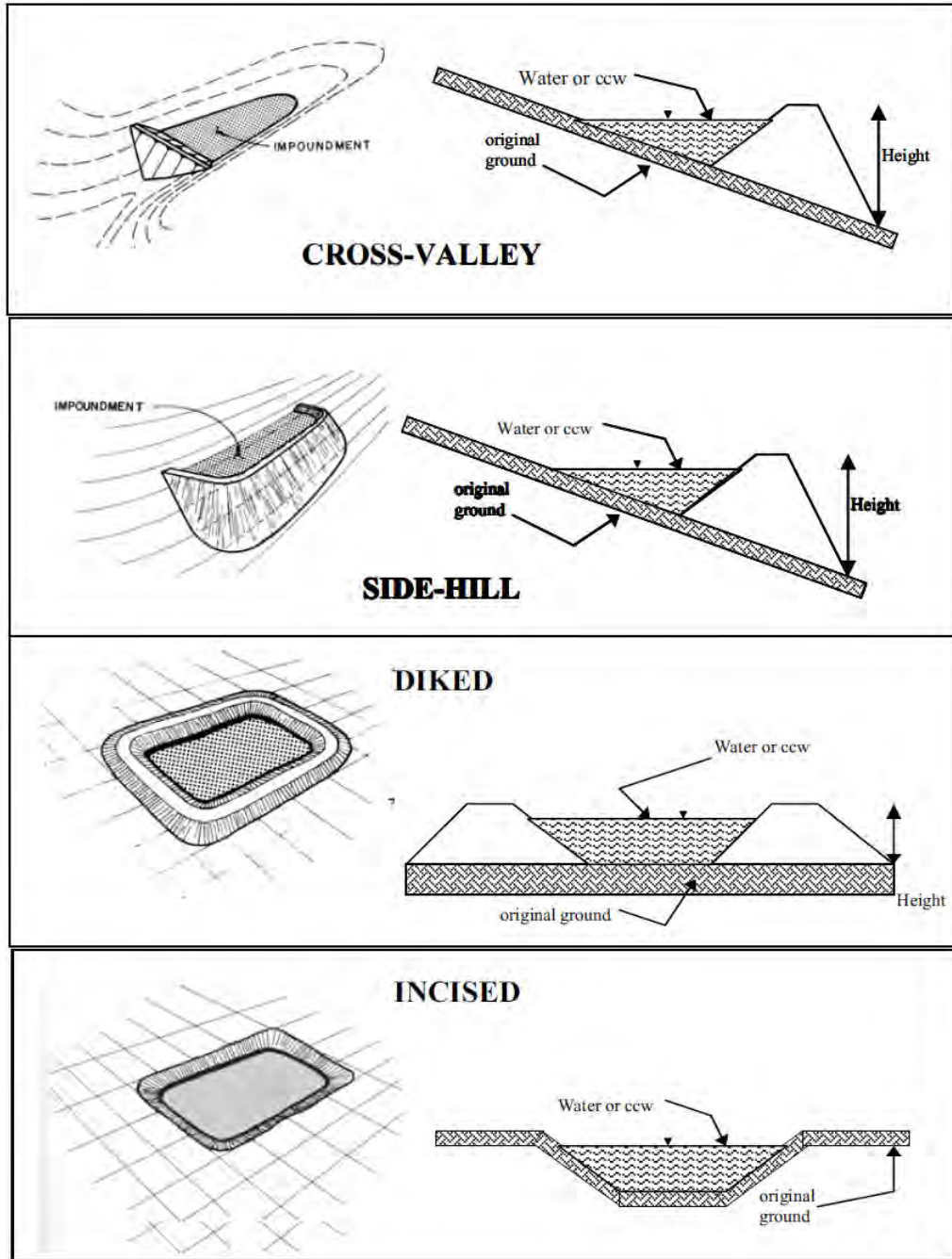

Cross-Valley

Side-Hill

Diked

Incised (form completion optional)

Combination Incised/Diked

**Embankment Height (ft)** 55 ft

**Embankment Material** Silty clay soil, mix. of shale and sandstone fragments, fly ash and bottom ash.

**Pool Area (ac)** 21 acre-ft

**Liner** None

**Current Freeboard (ft)** 5 ft/12 ft (Normal Freeboard)

**Liner Permeability** None



**TYPE OF OUTLET (Mark all that apply)**

**Open Channel Spillway**

- Trapezoidal
- Triangular
- Rectangular
- Irregular

depth (ft)

average bottom width (ft)

top width (ft)

TRAPEZOIDAL

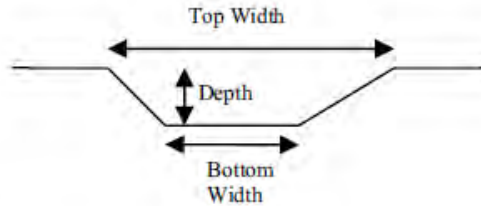

TRIANGULAR

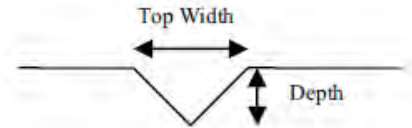

RECTANGULAR

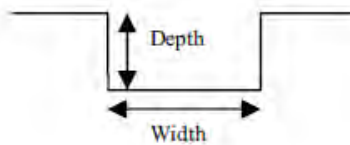

IRREGULAR

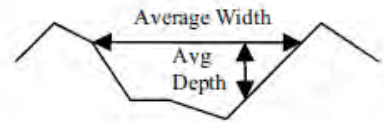

**Outlet**

30-inch inside diameter / Pond 1A  
36-inch inside diameter / Pond 1B

**Material**

- corrugated metal
- welded steel
- concrete
- plastic (hdpe, pvc, etc.)
- other (specify):

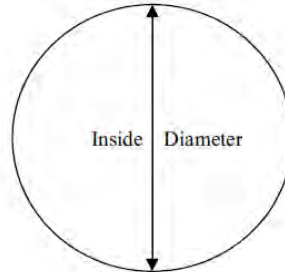

Yes

No

Is water flowing through the outlet?

No Outlet

Other Type of Outlet  
(specify):

The Impoundment was Designed By **AEP Engineers**

US EPA ARCHIVE DOCUMENT



Yes

No

Has there ever been a failure at this site?

If So When?

If So Please Describe :

US EPA ARCHIVE DOCUMENT



**Has there ever been significant seepages at this site?**      **Yes**      **No**  
     

**If So When?**      On-going but mitigated

**If So Please Describe :**

The side hill embankment of Ash Pond 1 has an elaborate seepage control system, consisting of perforated pipe toe drains that run the length of the embankment, which collects seepage at several areas along the embankment either directly from cross drains or from v-notch weirs that collect seepage discharge. All seepage discharge originating from cross drains and v-notch weirs were notably clear and free of fines or sediment. A rate of discharge was not determined on the site visit; however, a completed quarterly inspection report, titled Dike Inspection Checklist, indicating flow rates for each v-notch weir has been requested. The north outside embankment groin was observed to be conveying some minor clear seepage flow.

US EPA ARCHIVE DOCUMENT





|  | Yes                                 | No                       |
|--|-------------------------------------|--------------------------|
| <b>Has there ever been any measures undertaken to monitor/lower Phreatic water table levels based on past seepages or breaches at this site?</b> | <input checked="" type="checkbox"/> | <input type="checkbox"/> |

**If so, which method (e.g., piezometers, gw pumping,...)?** Piezometers

**If So Please Describe :**

A soil-bentonite slurry wall was installed to depths of 60-65 feet along the center of the side hill embankment to help mitigate seepage occurring through the dike, particularly in high water conditions. Approximately 20 piezometers located both at the crest and near the toe of the embankment have been installed to monitor phreatic water table levels. The piezometers were placed on either side of the slurry wall; instrumentation placed on the inside of the slurry wall reaches elevations as high as water surface elevations and crest while those placed on the outside of the slurry wall go down to almost 5 feet from the toe of the embankment.

US EPA ARCHIVE DOCUMENT

**ADDITIONAL INSPECTION QUESTIONS**

*Concerning the embankment foundation, was the embankment construction built over wet ash, slag, or other unsuitable materials? If there is no information just note that.*

No plans or information were available at the time of the site visit regarding embankment foundation. Information has been requested from AEP and will be provided after clearing AEP legal.

*Did the dam assessor meet with, or have documentation from, the design Engineer-of-Record concerning the foundation preparation?*

The AEP Senior Civil Engineer and the AEP Geotechnical Engineer for the Clinch River Plant were both present during the site visit, however no plans or information were available at the time of the site visit regarding the design foundation preparation. Information has been requested from AEP and will be provided after clearing AEP legal.

*From the site visit or from photographic documentation, was there evidence of prior releases, failures, or patchwork on the dikes?*

No evidence of prior releases, failures, or patchwork on dikes could be noted at the time of the site visit.



## Coal Combustion Dam Inspection Checklist Form

|                          |  |   |  |
|--------------------------|--|---|--|
| <b>Site Name:</b>        | <b>Clinch River Plant</b>                              | <b>Date:</b>                            | <b>February 17, 2011</b>   |
| <b>Unit Name:</b>        | <b>ASH POND 2<br/>(Inactive)</b>                       | <b>Operator's Name:</b>                 | <b>Appalachian Power</b>   |
| <b>Unit I.D.:</b>        | <b>VA16702</b>   | <b>Hazard Potential Classification:</b> | High <input type="checkbox"/> Significant <input checked="" type="checkbox"/> Low <input type="checkbox"/> |
| <b>Inspector's Name:</b> | Scott Clarke, P.E. and Loraine Ramos Nieves, P.E., CFM |   |  |

Check the appropriate box below. Provide comments when appropriate. If not applicable or not available, record "N/A". Any unusual conditions or construction practices that should be noted in the comments section. For large diked embankments, separate checklists may be used for different embankment areas. If separate forms are used, identify approximate area that the form applies to in comments.

**Note: Comments regarding each issue number have been listed below as needed.**

| Issue #  | Yes | No  | Issue #   | Yes | No  |
|--|-----|-----|---|-----|-----|
| 1. Frequency of Company's Dam Inspections?   | ✓   |     | 18. Sloughing or bulging on slopes?   |     | ✓   |
| 2. Pool elevation (operator records)?  |     | ✓   | 19. Major erosion or slope deterioration?   |     | ✓   |
| 3. Decant inlet elevation (operator records)?  |     | ✓   | 20. Decant Pipes:   |     |     |
| 4. Open channel spillway elevation (operator records)?   |     | N/A | Is water entering inlet, but not exiting outlet?  |     | N/A |
| 5. Lowest dam crest elevation (operator records)?  | ✓   |     | Is water exiting outlet, but not entering inlet?  |     | N/A |
| 6. If instrumentation is present, are readings recorded (operator records)?                                  |     | ✓   | Is water exiting outlet flowing clear?  |     | N/A |
| 7. Is the embankment currently under construction?   |     | ✓   | 21. Seepage (specify location, if seepage carries fines, and approximate seepage rate below): |     |     |
| 8. Foundation preparation (remove vegetation, stumps, topsoil in area where embankment fill will be placed)? |     | ✓   | From underdrain?  | ✓   |     |
| 9. Trees growing on embankment? (If so, indicate largest diameter below)                                     | ✓   |     | At isolated points on embankment slopes?  | ✓   |     |
| 10. Cracks or scarps on crest?   |     | ✓   | At natural hillside in the embankment area?   |     | ✓   |
| 11. Is there significant settlement along the crest?   |     | ✓   | Over widespread areas?  |     | ✓   |
| 12. Are decant trashracks clear and in place?  |     | N/A | From downstream foundation area?  |     | ✓   |
| 13. Depressions or sinkholes in tailings surface or whirlpool in the pool area?                              | ✓   |     | "Boils" beneath stream or ponded water?   |     | ✓   |
| 14. Clogged spillways, groin or diversion ditches?   |     | N/A | Around the outside of the decant pipe?  |     | ✓   |
| 15. Are spillway or ditch linings deteriorated?  |     | N/A | 22. Surface movements in valley bottom or on hillside?  |     | ✓   |
| 16. Are outlets of decant or underdrains blocked?  |     | ✓   | 23. Water against downstream toe?   | ✓   |     |
| 17. Cracks or scarps on slopes?  |     | ✓   | 24. Were Photos taken during the dam inspection?  | ✓   |     |

Major adverse changes in these items could cause instability and should be reported for further evaluation. Adverse conditions noted in these items should normally be described (extent, location, volume, etc.) in the space below and on the back of this sheet.

| Issue # | Comments   |
|---------|--|
| 1.      | Impoundments are inspected quarterly by the plant personal, and annually through an outside consultant.  |
| 2.      | Ash Pond 2 is currently inactive and on the day of the assessment had no pooling. According to quarterly inspections, titled Dike Inspection Checklist, a section of the upper level dike was removed in 1998 inhibiting the ability for the impoundment to pool water; no normal pool elevations were available for this impoundment. |
| 5.      | The lowest dam crest elevation would be equivalent to the upper level dike of the facility prior to it becoming inactive. The upper level crest elevation was 1570.0'.   |
| 9.      | Along the remaining sections of the upper dike of Bottom Ash Pond 2 there is significant tree growth; largest tree size ranged from 12"- 18" diameter. Additionally, between the toe of the embankment and Dump's Creek there is   |



|     |   |
|-----|---|
|     | significant tree growth; largest tree size ranged from 18"- 24" diameter. Virginia DCR requires a 25 ft clear zone (i.e. no trees) beyond the toe of all impounding structures.   |
| 13. | Fissures/cracks were observed in an area near the outflow spillway structure on the surface of the impoundment where it was evident that local storm runoff had been draining to.   |
| 20. | Ash Pond 2 is currently inactive and on the day of the assessment had no significant pooling. In addition, the inlet of the overflow structure is located at an elevation significantly higher than the current finished grade inside the remaining sections of the upper dike. Discharge through the overflow structure and outfall pipes is not possible at this time.  |
| 21. | The entire side-hill embankment of the Ash Pond 2 has a seepage control system, consisting of perforated pipe toe drains that run the length of the embankment, which collects seepage along the crest of the lower level dike. Seepage discharge originating from the toe drain was not accessible/visible during the site visit and although a rate of discharge for ongoing seepage was not determined, the plant personal did indicate that minimal seepage, possibly due to high ground water elevations, outfalls into Dump's Creek under a general NPDES permit. |
| 23. | Ash Pond 2 has Dumps Creek running along the entire stretch of its embankment.  |
| *   | An animal burrow was observed along the middle level dike of Ash Pond 2. The burrow was small in size and near the crest of the embankment.   |

US EPA ARCHIVE DOCUMENT



### Coal Combustion Waste (CCW) Impoundment Inspection

**Impoundment NPDES Permit** VA 0001015 / Outfall 015      **INSPECTOR** Scott Clarke, P.E. and Lorainne Ramos Nieves, P.E., CFM

**Date** February 17, 2011  
**Impoundment Name** Ash Pond 2 (Inactive)

**Impoundment Company** AEP, Appalachian Power  
**EPA Region** 3

**State Agency (Field Office) Address** Virginia Department of Conservation & Recreation, Division of Dam Safety and Floodplain Management; 8 Radford St., Suite 201 Christiansburg, VA 24073  
**Name of Impoundment** Ash Pond 2 (Inactive)

*(Report each impoundment on a separate form under the same Impoundment NPDES Permit number)*

**New**       **Update**

|   |                          |                                     |
|---|--------------------------|-------------------------------------|
|   | <b>Yes</b>               | <b>No</b>                           |
| <b>Is impoundment currently under construction?</b>                 | <input type="checkbox"/> | <input checked="" type="checkbox"/> |
| <b>Is water or ccw currently being pumped into the impoundment?</b> | <input type="checkbox"/> | <input checked="" type="checkbox"/> |

**IMPOUNDMENT FUNCTION:** Settling pond for bottom ash disposal.

**Nearest Downstream Town Name:** St. Paul, VA

**Distance from the impoundment:** 6.0 mi.

**Location:**

|                  |          |         |    |               |         |         |          |
|------------------|----------|---------|----|---------------|---------|---------|----------|
| <b>Latitude</b>  | 36       | Degrees | 56 | Minutes       | 18.6    | Seconds | <b>N</b> |
| <b>Longitude</b> | 82       | Degrees | 11 | Minutes       | 27.0    | Seconds | <b>W</b> |
| <b>State</b>     | Virginia |         |    | <b>County</b> | Russell |         |          |

|   |                                     |                          |
|---|-------------------------------------|--------------------------|
|   | <b>Yes</b>                          | <b>No</b>                |
| <b>Does a state agency regulate this impoundment?</b> | <input checked="" type="checkbox"/> | <input type="checkbox"/> |

**If So Which State Agency?** Virginia DCR, Division of Dam Safety and Floodplain Management / Virginia DEQ

US EPA ARCHIVE DOCUMENT

**HAZARD POTENTIAL** *(In the event the impoundment should fail, the following would occur):*

- LESS THAN LOW HAZARD POTENTIAL:** Failure or misoperation of the dam results in no probable loss of human life or economic or environmental losses.
- LOW HAZARD POTENTIAL:** Dams assigned the low hazard potential classification are those where failure or misoperation results in no probable loss of human life and low economic and/or environmental losses. Losses are principally limited to the owner's property.
- SIGNIFICANT HAZARD POTENTIAL:** Dams assigned the significant hazard potential classification are those dams where failure or misoperation results in no probable loss of human life but can cause economic loss, environmental damage, disruption of lifeline facilities, or can impact other concerns. Significant hazard potential classification dams are often located in predominantly rural or agricultural areas but could be located in areas with population and significant infrastructure.
- HIGH HAZARD POTENTIAL:** Dams assigned the high hazard potential classification are those where failure or misoperation will probably cause loss of human life.

**DESCRIBE REASONING FOR HAZARD RATING CHOSEN:**

Ash Pond 2 is adjacent to State Routes 616 as well as the Norfolk and Western Railway. In addition, the facility is located immediately upstream of Dumps Creek and Clinch River. The Clinch River Plant is located immediately south of the facility just across the Clinch River. A failure of this facility would impact State Route 616 and/or potentially the existing railroad. While no probable loss of human life is expected, economic and environmental damage would be expected.



**CONFIGURATION:**

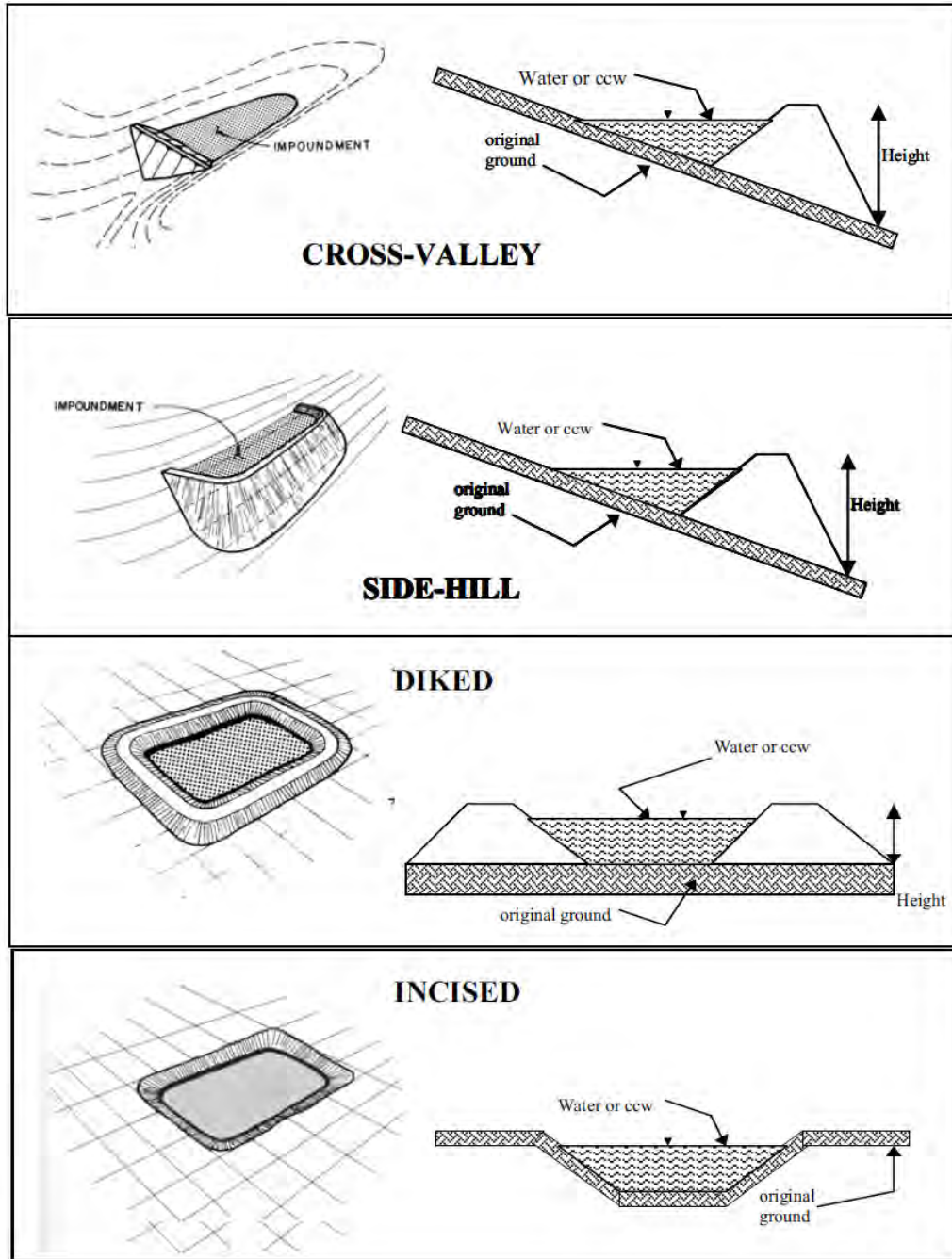

Cross-Valley



Side-Hill



Diked



Incised (form completion optional)



Combination Incised/Diked

**Embankment Height (ft)** 56 ft

**Embankment Material**

Shale fragments, silty clay, clayey silt and sand.

**Pool Area (ac)** 12.5 acre-ft

**Liner** None

**Current Freeboard (ft)** N/A

**Liner Permeability** None



**TYPE OF OUTLET (Mark all that apply)**

**Open Channel Spillway**

Trapezoidal

Triangular

Rectangular

Irregular

depth (ft)

average bottom width (ft)

top width (ft)

TRAPEZOIDAL

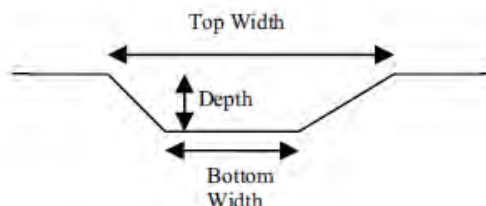

TRIANGULAR

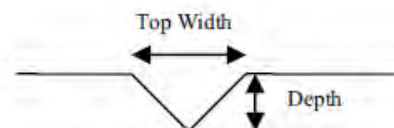

RECTANGULAR

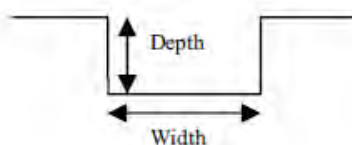

IRREGULAR

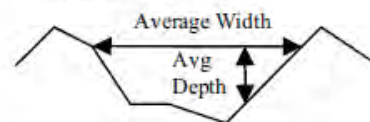

**Outlet**

30" inside diameter

**Material**

corrugated metal

welded steel

concrete

plastic (hdpe, pvc, etc.)

other (specify):

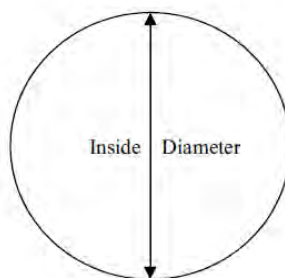

Yes

No

Is water flowing through the outlet?

No Outlet

Other Type of Outlet (specify):

The Impoundment was Designed By **AEP Engineers**

US EPA ARCHIVE DOCUMENT





Yes No

Has there ever been a failure at this site?

If So When? 1967

**If So Please Describe :**

Minimal information regarding the failure of the Ash Pond 2 is said to have been recorded. According to AEP, plant records do not indicate the cause of failure or the extent of damages to the affected areas. No photographs were available of the failure and its aftermath; however, the failure is said to have occurred near the northern end of the embankment and may have been due to seepage. In addition to the location and possible cause of the failure, the impact on aquatic wildlife in Dump's Creek and Clinch River was recalled to have been extensive. Any additional information that can be compiled has been requested from AEP.



|   | Yes                                 | No                       |
|---|-------------------------------------|--------------------------|
| <b>Has there ever been significant seepages at this site?</b> | <input checked="" type="checkbox"/> | <input type="checkbox"/> |
| <b>If So When?</b>  | Minor, on-going                     |                          |

**If So Please Describe :**

The side-hill embankment of Ash Pond 2 has a seepage control system, consisting of perforated pipe toe drains that run the length of the embankment, which collects seepage along the crest of the lower level dike. Seepage discharge originating from the toe drain was not accessible/visible during the site visit and although a rate of discharge for ongoing seepage was not determined, the plant personal did indicate that minimal seepage, possibly due to high ground water elevations, is collected from the system and outfalls into Dump's Creek under a general NPDES permit.

US EPA ARCHIVE DOCUMENT



|  | Yes                                 | No                       |
|--|-------------------------------------|--------------------------|
| <b>Has there ever been any measures undertaken to monitor/lower Phreatic water table levels based on past seepages or breaches at this site?</b> | <input checked="" type="checkbox"/> | <input type="checkbox"/> |

**If so, which method (e.g., piezometers, gw pumping,...)?** Piezometers

**If So Please Describe :**

Approximately 14 piezometers are located both at the crest and near the toe of both the lower and middle level dikes of the Ash Pond 2 embankment. These piezometers were installed to monitor phreatic water table levels while the pond was active. A design summary for final closure indicates a 15-20 ft drop in the phreatic water levels for this impoundment in 2008. As previously noted, this impoundment is inactive and no record of instrumentation readings or monitoring is kept.

**US EPA ARCHIVE DOCUMENT**

**ADDITIONAL INSPECTION QUESTIONS**

*Concerning the embankment foundation, was the embankment construction built over wet ash, slag, or other unsuitable materials? If there is no information just note that.*

No plans or information were available at the time of the site visit regarding embankment foundation. Information has been requested from AEP and will be provided after clearing AEP legal.

*Did the dam assessor meet with, or have documentation from, the design Engineer-of-Record concerning the foundation preparation?*

The AEP Senior Civil Engineer and the AEP Geotechnical Engineer for the Clinch River Plant were both present during the site visit, however no plans or information were available at the time of the site visit regarding the design foundation preparation. Information has been requested from AEP and will be provided after clearing AEP legal.

*From the site visit or from photographic documentation, was there evidence of prior releases, failures, or patchwork on the dikes?*

No evidence of prior releases, failures, or patchwork on dikes could be noted at the time of the site visit.