

**Alternative Control  
Techniques Document--  
NO<sub>x</sub> Emissions from  
Industrial/Commercial/Institutional  
(ICI) Boilers**

**Emission Standards Division**

**U.S. ENVIRONMENTAL PROTECTION AGENCY  
Office of Air and Radiation  
Office of Air Quality Planning and Standards  
Research Triangle Park, North Carolina 27711  
March 1994**

**U.S. Environmental Protection Agency  
Region 5, Library (1-12J)  
77 West Jackson Boulevard, 12th Floor  
Chicago, IL 60604-3590**

CLS 4.1

## **ALTERNATIVE CONTROL TECHNIQUES DOCUMENT**

This report is issued by the Emission Standards Division, Office of Air Quality Planning and Standards, U.S. Environmental Protection Agency, to provide information to State and local air pollution control agencies. Mention of trade names and commercial products is not intended to constitute endorsement or recommendation for use. Copies of this report are available—as supplies permit—from the Library Services Office (MD-35), U.S. Environmental Protection Agency, Research Triangle Park, North Carolina 27711 ([919] 541-2777) or, for a nominal fee, from the National Technical Information Services, 5285 Port Royal Road, Springfield, Virginia 22161 ([800] 553-NTIS).

## TABLE OF CONTENTS

	<b>Page</b>
<b>1 INTRODUCTION</b> .....	1-1
<b>2 SUMMARY</b> .....	2-1
2.1 ICI BOILER EQUIPMENT .....	2-2
2.2 NO <sub>x</sub> FORMATION AND BASELINE EMISSIONS .....	2-5
2.3 CONTROL TECHNIQUES AND CONTROLLED NO <sub>x</sub> EMISSION LEVELS .....	2-8
2.3.1 Combustion Modification Controls .....	2-11
2.3.2 Flue Gas Treatment Controls .....	2-15
2.4 COST AND COST EFFECTIVENESS OF NO <sub>x</sub> CONTROL TECHNIQUES .....	2-15
2.5 ENERGY AND ENVIRONMENTAL IMPACTS OF NO <sub>x</sub> CONTROL TECHNIQUES .....	2-19
<b>3 ICI BOILER EQUIPMENT PROFILE</b> .....	3-1
3.1 BOILER HEAT TRANSFER CONFIGURATIONS .....	3-3
3.2 COAL-FIRED BOILER EQUIPMENT TYPES .....	3-7
3.2.1 Coal-fired Watertube Boilers .....	3-9
3.2.2 Coal-fired Firetube Boilers .....	3-19
3.2.3 Cast Iron Boilers .....	3-25
3.3 OIL- AND NATURAL-GAS-FIRED ICI BOILER EQUIPMENT TYPES .....	3-25
3.3.1 Oil- and Natural-gas-fired Watertube Boilers .....	3-26
3.3.2 Oil- and Natural-gas-fired Firetube Boilers .....	3-27
3.3.3 Oil- and Natural-gas-fired Cast Iron Boilers .....	3-29
3.3.4 Other Oil- and Natural-gas-fired Boilers .....	3-29
3.3.5 Oil Burning Equipment .....	3-32
3.4 NONFOSSIL-FUEL-FIRED ICI BOILER EQUIPMENT TYPES .....	3-34
3.4.1 Wood-fired Boilers .....	3-34
3.4.2 Bagasse-fired Boilers .....	3-36
3.4.3 Municipal Solid Waste (MSW)-fired Boilers .....	3-38
3.4.4 Industrial Solid Waste (ISW)-fired Boilers .....	3-40
3.4.5 Refuse-derived Fuel (RDF)-fired Boilers .....	3-40
3.5 REFERENCES FOR CHAPTER 3 .....	3-43

## TABLE OF CONTENTS (continued)

		Page
4	<b>BASELINE EMISSION PROFILES</b> .....	4-1
4.1	<b>FACTORS AFFECTING NO<sub>x</sub> EMISSIONS FROM ICI BOILERS</b> .....	4-2
4.1.1	Boiler Design Type .....	4-2
4.1.2	Fuel Characteristics .....	4-3
4.1.3	Boiler Heat Release Rate .....	4-10
4.1.4	Boiler Operational Factors .....	4-13
4.2	<b>COMPILED BASELINE EMISSIONS DATA – ICI BOILERS</b> .....	4-15
4.2.1	Coal-fired Boilers .....	4-15
4.2.2	Oil-fired Boilers .....	4-18
4.2.3	Natural-gas-fired Boilers .....	4-18
4.2.4	Nonfossil-fuel-fired Boilers .....	4-20
4.2.5	Other ICI Boilers .....	4-22
4.3	<b>SUMMARY</b> .....	4-22
4.4	<b>REFERENCES FOR CHAPTER 4</b> .....	4-25
5	<b>NO<sub>x</sub> CONTROL TECHNOLOGY EVALUATION</b> .....	5-1
5.1	<b>PRINCIPLES OF NO<sub>x</sub> FORMATION AND COMBUSTION MODIFICATION NO<sub>x</sub> CONTROL</b> .....	5-2
5.2	<b>COMBUSTION MODIFICATION NO<sub>x</sub> CONTROLS FOR COAL-FIRED ICI BOILERS</b> .....	5-9
5.2.1	Combustion Modification NO <sub>x</sub> Controls for Pulverized Coal (PC)-fired ICI Boilers .....	5-10
5.2.2	Combustion Modification NO <sub>x</sub> Controls for Stoker Coal-fired ICI Boilers .....	5-23
5.2.3	Combustion Modification NO <sub>x</sub> Controls for Coal-fired Fluidized-bed Combustion (FBC) ICI Boilers .....	5-30
5.3	<b>COMBUSTION MODIFICATION NO<sub>x</sub> CONTROLS FOR OIL- AND NATURAL-GAS-FIRED ICI BOILERS</b> .....	5-39
5.3.1	Water Injection/Steam Injection (WI/SI) .....	5-43
5.3.2	Low-NO <sub>x</sub> Burners (LNBs) in Natural-gas- and Oil-fired ICI Boilers .....	5-43
5.3.3	Flue Gas Recirculation (FGR) in Natural-gas- and Oil-fired ICI Boilers .....	5-54
5.3.4	Fuel Induced Recirculation (FIR) .....	5-56
5.3.5	Staged Combustion Air (SCA) in Natural-gas- and Oil-fired ICI Boilers .....	5-56
5.3.6	Combined Combustion Modification NO <sub>x</sub> Controls for Natural-gas- and Oil-fired ICI Boilers .....	5-60
5.3.7	Fuel Switching .....	5-61
5.3.8	Combustion Modification NO <sub>x</sub> Controls for Thermally Enhanced Oil Recovery (TEOR) Steam Generators .....	5-63
5.3.9	Gas Fuel Flow Modifiers .....	5-69

**TABLE OF CONTENTS (continued)**

		<b>Page</b>
	5.4 COMBUSTION MODIFICATIONS FOR NONFOSSIL-FUEL-FIRED ICI BOILERS .....	5-70
	5.5 FLUE GAS TREATMENT NO <sub>x</sub> CONTROLS FOR ICI BOILERS .....	5-71
	5.5.1 Selective Noncatalytic Reduction (SNCR) .....	5-71
	5.5.2 Selective Catalytic Reduction (SCR) .....	5-75
	5.6 SUMMARY OF NO <sub>x</sub> REDUCTION PERFORMANCE .....	5-78
	5.7 REFERENCES FOR CHAPTER 5 .....	5-82
<b>6</b>	<b>COSTS OF RETROFIT NO<sub>x</sub> CONTROLS .....</b>	<b>6-1</b>
	6.1 COSTING METHODOLOGY .....	6-1
	6.1.1 Capital Costs of Retrofit NO <sub>x</sub> Controls .....	6-2
	6.1.2 Annual Operations and Maintenance (O&M) Costs .....	6-5
	6.1.3 Total Annualized Cost and Cost Effectiveness .....	6-5
	6.2 NO <sub>x</sub> CONTROL COST CASES AND SCALING METHODOLOGY .....	6-9
	6.3 CAPITAL AND TOTAL ANNUAL COSTS OF NO <sub>x</sub> CONTROLS .....	6-11
	6.4 COST EFFECTIVENESS OF NO <sub>x</sub> CONTROLS .....	6-15
	6.4.1 NO <sub>x</sub> Control Cost Effectiveness: Coal-fired ICI Boilers .....	6-15
	6.4.2 NO <sub>x</sub> Control Cost Effectiveness: Natural-gas-fired ICI Boilers ...	6-18
	6.4.3 NO <sub>x</sub> Control Cost Effectiveness: Fuel-oil-fired ICI Boilers .....	6-25
	6.4.4 NO <sub>x</sub> Control Cost Effectiveness: Nonfossil-fuel-fired ICI Boilers .	6-25
	6.4.5 NO <sub>x</sub> Control Cost Effectiveness: Oil-fired Thermally Enhanced Oil Recovery (TEOR) Steam Generators .....	6-30
	6.4.6 Cost Effect of Continuous Emissions Monitoring (CEM) System .	6-31
	6.5 REFERENCES FOR CHAPTER 6 .....	6-32
<b>7</b>	<b>ENVIRONMENTAL AND ENERGY IMPACTS .....</b>	<b>7-1</b>
	7.1 AIR POLLUTION .....	7-1
	7.1.1 NO <sub>x</sub> Reductions .....	7-1
	7.1.2 CO Emissions .....	7-4
	7.1.3 Other Air Pollution Emissions .....	7-8
	7.2 SOLID WASTE DISPOSAL .....	7-12
	7.3 WATER USAGE AND WASTEWATER DISPOSAL .....	7-13
	7.4 ENERGY CONSUMPTION .....	7-13
	7.4.1 Oxygen Trim (OT) .....	7-14
	7.4.2 Water Injection/Steam Injection (WI/SI) .....	7-16
	7.4.3 Staged Combustion Air (SCA) .....	7-16
	7.4.4 Low-NO <sub>x</sub> Burners (LNBs) .....	7-16
	7.4.5 Flue Gas Recirculation (FGR) .....	7-18

TABLE OF CONTENTS (continued)

	Page
7.4.6 Selective Noncatalytic Reduction (SNCR) .....	7-18
7.4.7 Selective Catalytic Reduction (SCR) .....	7-19
7.5 REFERENCES FOR CHAPTER 7 .....	7-22
APPENDIX A – ICI BOILER BASELINE EMISSION DATA .....	A-1
APPENDIX B – CONTROLLED NO <sub>x</sub> EMISSION DATA .....	B-1
APPENDIX C – LOW-NO <sub>x</sub> INSTALLATION LISTS, COEN COMPANY AND TAMPELLA POWER CORP. ....	C-1
APPENDIX D – SCALED COST EFFECTIVENESS VALUES .....	D-1
APPENDIX E – ANNUAL COSTS OF RETROFIT NO <sub>x</sub> CONTROLS: NATURAL-GAS-FIRED ICI BOILERS .....	E-1
APPENDIX F – ANNUAL COSTS OF RETROFIT NO <sub>x</sub> CONTROLS: COAL-FIRED ICI BOILERS .....	F-1
APPENDIX G – ANNUAL COSTS OF RETROFIT NO <sub>x</sub> CONTROLS: NONFOSSIL-FUEL-FIRED ICI BOILERS .....	G-1

## LIST OF FIGURES

		Page
Figure 2-1	Cost effectiveness versus boiler capacity, PC wall-fired boilers . . . . .	2-20
Figure 2-2	Cost effectiveness versus boiler capacity, natural-gas-fired packaged watertube boilers . . . . .	2-20
Figure 2-3	Cost effectiveness versus boiler capacity, distillate-oil-fired boiler . . . . .	2-21
Figure 2-4	Cost effectiveness versus boiler capacity, residual-oil-fired boilers . . . . .	2-21
Figure 3-1	Occurrence of fuel types and heat transfer configurations by capacity . . . . .	3-4
Figure 3-2	Occurrence of ICI boiler equipment types by capacity . . . . .	3-5
Figure 3-3	Simplified diagram of a watertube boiler . . . . .	3-6
Figure 3-4	Watertube boiler . . . . .	3-6
Figure 3-5	Simplified diagram of a firetube boiler . . . . .	3-8
Figure 3-6	Firetube boiler . . . . .	3-8
Figure 3-7	Single-retort horizontal-feed underfeed stoker . . . . .	3-11
Figure 3-8	Multiple-retort gravity-feed underfeed stoker . . . . .	3-11
Figure 3-9	Overfeed chain-grate stoker . . . . .	3-12
Figure 3-10	Spreader stoker . . . . .	3-12
Figure 3-11	Wall firing . . . . .	3-15
Figure 3-12	Tangential firing . . . . .	3-15
Figure 3-13	Bubbling FBC schematic . . . . .	3-18
Figure 3-14	Circulating FBC schematic . . . . .	3-18
Figure 3-15	Two-pass HRT boiler . . . . .	3-21
Figure 3-16	Four-pass gas-/oil-fired scotch boiler . . . . .	3-22
Figure 3-17	Exposed-tube vertical boiler . . . . .	3-23

## LIST OF FIGURES (continued)

	Page
Figure 3-18 Submerged-tube vertical boiler .....	3-24
Figure 3-19 Watertube design configurations .....	3-27
Figure 3-20 D-type packaged boiler and watertubes .....	3-28
Figure 3-21 Vertical tubeless boiler .....	3-30
Figure 3-22 TEOR steam generator .....	3-31
Figure 3-23 Effect of temperature on fuel oil viscosity .....	3-33
Figure 3-24 Ward fuel cell furnace .....	3-37
Figure 3-25 Large MSW-fired boiler .....	3-39
Figure 3-26 Modular MSW-fired boiler .....	3-41
Figure 4-1 Conversion of fuel nitrogen .....	4-4
Figure 4-2 Fuel oil nitrogen versus sulfur for residual oil .....	4-6
Figure 4-3 Effect of fuel nitrogen content on total NO <sub>x</sub> emissions .....	4-7
Figure 4-4 Fuel NO <sub>x</sub> formation as a function of coal oxygen/nitrogen ratio and coal nitrogen content .....	4-9
Figure 4-5 Effect of burner heat release rate on NO <sub>x</sub> emissions for coal and natural gas fuels .....	4-11
Figure 4-6 Furnace heat release rate versus boiler size .....	4-12
Figure 4-7 Effect of excess oxygen and preheat on NO <sub>x</sub> emissions, natural-gas- fired boilers .....	4-14
Figure 5-1 Effect of excess O <sub>2</sub> on NO <sub>x</sub> emissions for firetube boilers at baseline operating conditions, natural gas and oil fuels .....	5-7
Figure 5-2 Changes in CO and NO <sub>x</sub> emissions with reduced excess oxygen for a residual-oil-fired watertube industrial boiler .....	5-8
Figure 5-3 Effect of BOOS on emissions .....	5-14
Figure 5-4 Foster Wheeler CF/SF LNB .....	5-16



**LIST OF FIGURES (continued)**

	<b>Page</b>
Figure 5-5 Performance of CF/SF LNB .....	5-16
Figure 5-6 Riley low-NO <sub>x</sub> CCV burner with secondary air diverter .....	5-18
Figure 5-7 Riley low-NO <sub>x</sub> TSV burner with advanced air staging for turbo-furnace, down-fired and arch-fired installation .....	5-19
Figure 5-8 Schematic diagram of stoker with FGR .....	5-27
Figure 5-9 FGR effects on excess O <sub>2</sub> .....	5-28
Figure 5-10 NO emission versus excess O <sub>2</sub> , stoker boiler with FGR .....	5-28
Figure 5-11 Overfeed stoker with short active combustion zone .....	5-29
Figure 5-12 Effect of SCA on NO <sub>x</sub> and CO emissions, Chalmers University .....	5-33
Figure 5-13 NO <sub>x</sub> and CO versus bed temperature, pilot-scale BFBC .....	5-35
Figure 5-14 Effect of bed temperature on NO <sub>x</sub> and CO, Chalmers University .....	5-36
Figure 5-15 As the rate of water injection increases, NO <sub>x</sub> decreases .....	5-44
Figure 5-16 Staged air LNB .....	5-46
Figure 5-17 Staged fuel LNB .....	5-48
Figure 5-18 Low-NO <sub>x</sub> ASR burner .....	5-50
Figure 5-19 AFS air- and fuel-staged burner .....	5-50
Figure 5-20 Riley Stoker STS burner .....	5-51
Figure 5-21 Pyrocore LNB schematic .....	5-53
Figure 5-22 FGR system for gas- or oil-fired boiler .....	5-57
Figure 5-23 Effects of cofiring on NO <sub>x</sub> emissions .....	5-62
Figure 5-24 North American LNB on oil field steam generator .....	5-66
Figure 5-25 Process Combustion Corporation toroidal combustor .....	5-67
Figure 5-26 The MHI PM burner nozzle .....	5-68

## LIST OF FIGURES (continued)

		Page
Figure 6-1	Elements of total capital investment cost .....	6-3
Figure 6-2	Elements of total annual O&M cost .....	6-6
Figure 6-3	Total capital cost reported by Exxon for SNCR-ammonia on a variety of industrial boilers .....	6-14
Figure 6-4	Cost effectiveness versus boiler capacity, PC wall-fired boilers .....	6-17
Figure 6-5	Cost effectiveness versus boiler capacity, natural-gas-fired packaged watertube boilers .....	6-21
Figure 6-6	Cost effectiveness versus boiler capacity, natural-gas-fired packaged watertube boilers using SCR controls .....	6-23
Figure 6-7	Cost effectiveness versus boiler capacity, distillate-oil-fired boilers .....	6-28
Figure 6-8	Cost effectiveness versus boiler capacity, residual-oil-fired boilers .....	6-29
Figure 7-1	Changes in CO and NO <sub>x</sub> emissions with reduced excess oxygen for a residual-oil-fired watertube industrial boiler .....	7-8
Figure 7-2	Pilot-scale test results, conversion of NO <sub>x</sub> to N <sub>2</sub> O (NO <sub>i</sub> = 300 ppm, N/NO = 2.0) .....	7-11
Figure 7-3	Curve showing percent efficiency improvement per every 1 percent reduction in excess air. Valid for estimating efficiency improvements on typical natural gas, No. 2 through No. 6 oils, and coal fuels .....	7-15
Figure 7-4	Unburned carbon monoxide loss as a function of excess O <sub>2</sub> and carbon monoxide emissions for natural gas fuel .....	7-17
Figure 7-5	Energy penalty associated with the use of WI or SI for NO <sub>x</sub> control in ICI boilers .....	7-17
Figure 7-6	Estimated energy consumption in FGR use .....	7-19
Figure 7-7	Estimated increase in energy consumption with SCR pressure drop .....	7-20
Figure 7-8	Curve showing percent efficiency improvement per every 10°F drop in stack temperature. Valid for estimating efficiency improvements on typical natural gas, No. 2 through No. 6 oils, and coal fuels .....	7-21

## LIST OF TABLES

		Page
TABLE 2-1	ICI BOILER EQUIPMENT, FUELS, AND APPLICATIONS .....	2-3
TABLE 2-2	SUMMARY OF BASELINE NO <sub>x</sub> EMISSIONS .....	2-7
TABLE 2-3	EXPERIENCE WITH NO <sub>x</sub> CONTROL TECHNIQUES ON ICI BOILERS .....	2-9
TABLE 2-4	SUMMARY OF COMBUSTION MODIFICATION NO <sub>x</sub> CONTROL PERFORMANCE ON ICI WATERTUBE BOILERS .....	2-12
TABLE 2-5	SUMMARY OF COMBUSTION MODIFICATION NO <sub>x</sub> CONTROL PERFORMANCE ON ICI FIRETUBE BOILERS .....	2-14
TABLE 2-6	SUMMARY OF FLUE GAS TREATMENT NO <sub>x</sub> CONTROL PERFORMANCE ON ICI BOILERS .....	2-16
TABLE 2-7	ESTIMATED COST AND COST EFFECTIVENESS OF NO <sub>x</sub> CONTROLS (1992 DOLLARS) .....	2-18
TABLE 2-8	EFFECTS OF NO <sub>x</sub> CONTROLS ON CO EMISSIONS FROM ICI BOILERS .....	2-22
TABLE 3-1	ICI BOILER EQUIPMENT, FUELS, AND APPLICATIONS .....	3-2
TABLE 4-1	TYPICAL RANGES IN NITROGEN AND SULFUR CONTENTS OF FUEL OILS .....	4-6
TABLE 4-2	COMPARISON OF COMPILED UNCONTROLLED EMISSIONS DATA WITH AP-42 EMISSION FACTORS, COAL-FIRED BOILERS .....	4-16
TABLE 4-3	COMPARISON OF COMPILED UNCONTROLLED EMISSIONS DATA WITH AP-42 EMISSION FACTORS, OIL-FIRED BOILERS .....	4-19
TABLE 4-4	COMPARISON OF COMPILED UNCONTROLLED EMISSIONS DATA WITH AP-42 EMISSION FACTORS, NATURAL-GAS-FIRED BOILERS .....	4-20
TABLE 4-5	AP-42 UNCONTROLLED EMISSION FACTORS FOR NONFOSSIL-FUEL-FIRED BOILERS .....	4-21

**LIST OF TABLES (continued)**

		<b>Page</b>
TABLE 4-6	AVERAGE NO <sub>x</sub> EMISSIONS FROM MUNICIPAL WASTE COMBUSTORS .....	4-22
TABLE 4-7	SUMMARY OF BASELINE NO <sub>x</sub> EMISSIONS .....	4-23
TABLE 5-1	SUMMARY OF COMBUSTION MODIFICATION NO <sub>x</sub> CONTROL APPROACHES .....	5-4
TABLE 5-2	EXPERIENCE WITH NO <sub>x</sub> CONTROL TECHNIQUES ON ICI BOILERS .....	5-5
TABLE 5-3	COMBUSTION MODIFICATION NO <sub>x</sub> CONTROLS FOR FULL-SCALE PC-FIRED INDUSTRIAL BOILERS .....	5-11
TABLE 5-4	COMBUSTION MODIFICATION NO <sub>x</sub> CONTROLS FOR STOKER COAL-FIRED INDUSTRIAL BOILERS .....	5-24
TABLE 5-5	NO <sub>x</sub> CONTROL TECHNIQUES FOR FBC BOILERS .....	5-32
TABLE 5-6	REPORTED CONTROLLED NO <sub>x</sub> EMISSION LEVELS, FULL-SCALE, COAL-FIRED FBC BOILERS .....	5-35
TABLE 5-7	COMBUSTION MODIFICATION NO <sub>x</sub> CONTROLS FOR FULL-SCALE NATURAL-GAS-FIRED INDUSTRIAL BOILERS .....	5-41
TABLE 5-8	COMBUSTION MODIFICATION NO <sub>x</sub> CONTROLS FOR OIL-FIRED INDUSTRIAL BOILERS .....	5-42
TABLE 5-9	REPORTED NO <sub>x</sub> LEVELS AND REDUCTION EFFICIENCIES IN ICI BOILERS WITH LNBs .....	5-45
TABLE 5-10	EFFECTS OF SWITCHING FROM RESIDUAL OIL TO DISTILLATE FUEL ON INDUSTRIAL BOILERS .....	5-63
TABLE 5-11	ESTIMATES OF NO <sub>x</sub> REDUCTIONS WITH FUEL SWITCHING .....	5-64
TABLE 5-12	SNCR NO <sub>x</sub> CONTROL FOR ICI BOILERS .....	5-73
TABLE 5-13	SELECTED SCR INSTALLATIONS, CALIFORNIA ICI BOILERS ..	5-77
TABLE 5-14	SCR NO <sub>x</sub> CONTROLS FOR ICI BOILERS .....	5-77

LIST OF TABLES (continued)

		Page
TABLE 5-15	SUMMARY OF NO <sub>x</sub> REDUCTION PERFORMANCE .....	5-79
TABLE 6-1	ASSUMPTIONS FOR ESTIMATING CAPITAL AND ANNUAL O&M COSTS .....	6-7
TABLE 6-2	BASELINE (UNCONTROLLED) NO <sub>x</sub> EMISSIONS USED FOR COST CASES .....	6-9
TABLE 6-3	NO <sub>x</sub> REDUCTION EFFICIENCIES USED FOR COST CASES .....	6-10
TABLE 6-4	NO <sub>x</sub> CONTROL COST EFFECTIVENESS CASES .....	6-11
TABLE 6-5	CAPITAL AND TOTAL ANNUAL COSTS OF RETROFIT NO <sub>x</sub> CONTROLS FOR ICI BOILERS, 1992 DOLLARS .....	6-12
TABLE 6-6	SUMMARY OF NO <sub>x</sub> CONTROL COST EFFECTIVENESS, COAL-FIRED ICI BOILERS .....	6-16
TABLE 6-7	SUMMARY OF NO <sub>x</sub> CONTROL COST EFFECTIVENESS, NATURAL-GAS-FIRED ICI BOILERS .....	6-18
TABLE 6-8	SUMMARY OF NO <sub>x</sub> CONTROL COST EFFECTIVENESS, DISTILLATE-OIL-FIRED ICI BOILERS .....	6-26
TABLE 6-9	SUMMARY OF NO <sub>x</sub> CONTROL COST EFFECTIVENESS, RESIDUAL-OIL-FIRED ICI BOILERS .....	6-27
TABLE 6-10	SUMMARY OF NO <sub>x</sub> CONTROL COST EFFECTIVENESS, NONFOSSIL-FUEL-FIRED ICI BOILERS .....	6-30
TABLE 6-11	NO <sub>x</sub> CONTROL COST EFFECTIVENESS WITHOUT/WITH CEM SYSTEM, NATURAL-GAS-FIRED ICI BOILERS <sup>a</sup> .....	6-31
TABLE 7-1	EXPERIENCE WITH NO <sub>x</sub> CONTROL TECHNIQUES ON ICI BOILERS .....	7-2
TABLE 7-2	NO <sub>x</sub> EMISSIONS REDUCTION FROM MODEL BOILERS .....	7-3
TABLE 7-3	CO EMISSION CHANGES WITH NO <sub>x</sub> CONTROL RETROFIT — COAL-FIRED BOILERS .....	7-5
TABLE 7-4	CO EMISSION CHANGES WITH NO <sub>x</sub> CONTROL RETROFIT — GAS-FIRED BOILERS .....	7-6

LIST OF TABLES (continued)

	Page
TABLE 7-5 CO EMISSION CHANGES WITH NO <sub>x</sub> CONTROL RETROFIT – OIL-FIRED BOILERS .....	7-7
TABLE 7-6 AMMONIA EMISSIONS WITH UREA-BASED SNCR RETROFIT .....	7-10

## 1. INTRODUCTION

Congress, in the Clean Air Act Amendments (CAAA) of 1990, amended Title I of the Clean Air Act (CAA) to address ozone nonattainment areas. A new Subpart 2 was added to Part D of Section 103. Section 183(c) of the new Subpart 2 provides that:

[W]ithin 3 years after the date of the enactment of the CAAA, the Administrator shall issue technical documents which identify alternative controls for all categories of stationary sources of . . . oxides of nitrogen which emit or have the potential to emit 25 tons per year or more of such air pollutant.

These documents are to be subsequently revised and updated as determined by the Administrator.

Industrial, commercial, and institutional (ICI) boilers have been identified as a category that emits more than 25 tons of oxides of nitrogen (NO<sub>x</sub>) per year. This alternative control techniques (ACT) document provides technical information for use by State and local agencies to develop and implement regulatory programs to control NO<sub>x</sub> emissions from ICI boilers. Additional ACT documents are being developed for other stationary source categories.

ICI boilers include steam and hot water generators with heat input capacities from 0.4 to 1,500 MMBtu/hr (0.11 to 440 MWt). These boilers are used in a variety of applications, ranging from commercial space heating to process steam generation, in all major industrial sectors. Although coal, oil, and natural gas are the primary fuels, many ICI boilers also burn a variety of industrial, municipal, and agricultural waste fuels.

It must be recognized that the alternative control techniques and the corresponding achievable NO<sub>x</sub> emission levels presented in this document may not be applicable to every ICI boiler application. The furnace design, method of fuel firing, condition of existing equipment, operating duty cycle, site conditions, and other site-specific factors must be taken into consideration to properly evaluate the applicability and performance of any given control technique. Therefore, the feasibility of a retrofit should be determined on a case-by-case basis.

The information in this ACT document was generated through a literature search and from information provided by ICI boiler manufacturers, control equipment vendors, ICI boiler

users, and regulatory agencies. Chapter 2 summarizes the findings of this study. Chapter 3 presents information on the ICI boiler types, fuels, operation, and industry applications. Chapter 4 discusses NO<sub>x</sub> formation and uncontrolled NO<sub>x</sub> emission factors. Chapter 5 covers alternative control techniques and achievable controlled emission levels. Chapter 6 presents the cost and cost effectiveness of each control technique. Chapter 7 describes environmental and energy impacts associated with implementing the NO<sub>x</sub> control techniques. Finally, Appendices A through G provide the detailed data used in this study to evaluate uncontrolled and controlled emissions and the costs of controls for several retrofit scenarios.



## 2. SUMMARY

This chapter summarizes the information presented in more detail in Chapters 3 through 7 of this document. Section 2.1 reviews the diversity of equipment and fuels that make up the ICI boiler population. The purposes of this section are to identify the major categories of boiler types, and to alert the reader to the important differences that separate the ICI boiler population from other boiler designs and operating practices. This diversity of combustion equipment, fuels, and operating practices impacts uncontrolled NO<sub>x</sub> emission levels from ICI boilers and the feasibility of control for many units. Section 2.2 reviews baseline NO<sub>x</sub> emission reported for many categories of ICI boilers and highlights the often broad ranges in NO<sub>x</sub> levels associated with boiler designs, firing methods, and fuels.

The experience in NO<sub>x</sub> control retrofits is summarized in Section 2.3. This information was derived from a critical review of the open literature coupled with information from selected equipment vendors and users of NO<sub>x</sub> control technologies. The section is divided into a subsection on combustion controls and another on flue gas treatment controls. As in the utility boiler experience, retrofit combustion controls for ICI boilers have targeted principally the replacement of the original burner with a low-NO<sub>x</sub> design. When cleaner fuels are burned, the low-NO<sub>x</sub> burner (LNB) often includes a flue gas recirculation (FGR) system that reduces the peak flame temperature producing NO<sub>x</sub>. Where NO<sub>x</sub> regulations are especially stringent, the operating experience with natural gas burning ICI boilers also includes more advanced combustion controls and techniques that can result in high fuel penalties, such as water injection (WI). As in the case of utility boilers, some boiler designs have shown little adaptability to combustion controls to reduce NO<sub>x</sub>. For these units, NO<sub>x</sub> reductions are often achievable only with flue gas treatment technologies for which experience varies.

Section 2.4 summarizes the cost of installing NO<sub>x</sub> controls and operating at lower NO<sub>x</sub> levels. The data presented in this document are drawn from the reported experience of technology users coupled with costs reported by selected technology vendors. This information is offered only as a guideline because control costs are always greatly influenced by numerous

site factors that cannot be taken fully into account. Finally, Section 2.5 summarizes the energy and environmental impacts of low-NO<sub>x</sub> operation. Combustion controls are often limited in effectiveness by the onset of other emissions and energy penalties. This section reviews the emissions of CO, NH<sub>3</sub>, N<sub>2</sub>O, soot and particulate.

## **2.1 ICI BOILER EQUIPMENT**

The family of ICI boilers includes equipment type with heat input capacities in the range of 0.4 to 1,500 MMBtu/hr (0.11 to 440 MWt). Industrial boilers generally have heat input capacities ranging from 10 to 250 MMBtu/hr (2.9 to 73 MWt). This range encompasses most boilers currently in use in the industrial, commercial, and institutional sectors. The leading user industries of industrial boilers, ranked by aggregate steaming capacity, are the paper products, chemical, food, and the petroleum industries. Those industrial boilers with heat input greater than 250 MMBtu/hr (73 MWt) are generally similar to utility boilers. Therefore, many NO<sub>x</sub> controls applicable to utility boilers are also candidate control for large industrial units. Boilers with heat input capacities less than 10 MMBtu/hr (2.9 MWt) are generally classified as commercial/institutional units. These boilers are used in a wide array of applications, such as wholesale and retail trade, office buildings, hotels, restaurants, hospitals, schools, museums, government buildings, airports, primarily providing steam and hot water for space heating. Boilers used in this sector generally range in size from 0.4 to 12.5 MMBtu (0.11 to 3.7 MWt) heat input capacity, although some are appreciably larger.

Table 2-1 lists the various equipment and fuel combinations, the range in heat input capacity, and the typical applications. Passed boiler inventory studies were used to estimate the relative number and total firing capacity of each boiler-fuel category. Many of these boilers vary greatly in age and use patterns. Older units have outdated furnace configurations with greater refractory area and lower heat release rates. Newer designs focus on compact furnaces with tangent tube configurations for greater heat transfer and higher heat release rates. Newer furnaces also tend to have fewer burners, because of improvements in combustion control and better turndown capability, and better economics. This diversity of equipment requires a careful evaluation of applicable technologies. Many smaller ICI boilers often operate with little supervision, and are fully automated. Application of NO<sub>x</sub> controls that would limit this operational flexibility may prove impractical. They can be found fully enclosed inside commercial and institutional buildings and in industry steam plants or completely outdoors in several industrial applications at refineries and chemical plants. The location of these boilers often

TABLE 2-1. ICI BOILER EQUIPMENT, FUELS, AND APPLICATIONS

Heat transfer configuration	Design and fuel type	Capacity range, MMBtu/hr <sup>a</sup>	% of ICI boiler units <sup>b,c</sup>	% of ICI boiler capacity <sup>b,c</sup>	Application <sup>d</sup>
Watertube	Pulverized coal	100-1,500+	** <sup>e</sup>	2.5	PH, CG
	Stoker coal	0.4-550+ <sup>f</sup>	**	5.0	SH, PH, CG
	FBC <sup>g</sup> coal	1.4-1,075	**	**	PH, CG
	Gas/oil	0.4-1,500+	2.3	23.6	SH, PG, CG
	Oil field steamer	20-62.5	N.A. <sup>h</sup>	N.A.	PH
	Stoker nonfossil	1.5-1,000 <sup>f</sup>	**	1.1	SH, PH, CG
	FBC nonfossil	40-345	**	**	PH, CG
	Other nonfossil	3-800	**	**	SH, PH, CG
Firetube	HRT coal	0.5-50	**	**	SH, PH
	Scotch coal	0.4-50	**	**	SH, PH
	Vertical coal	<2.5	**	**	SH, PH
	Firebox coal	0.4-15	**	**	SH, PH
	HRT gas/oil	0.5-50	1.5	1.5	SH, PH
	Scotch gas/oil	0.4-50	4.8	4.6	SH, PH
	Vertical gas/oil	<2.5	1.0	**	SH, PH
	Firebox gas/oil	<20	6.5	48	SH, PH
	HRT nonfossil	2-50	N.A.	N.A.	SH, PH
	Firebox nonfossil	2-20	N.A.	N.A.	SH, PH
Cast iron	Coal	<0.4-14	9.9	1.3	SH, PH
	Gas/oil	<0.4-14	72	9.6	SH, PH
Tubeless	Gas/oil	<0.4-4	N.A.	N.A.	SH, PH

<sup>a</sup>To convert to MWt, multiply by 0.293.

<sup>b</sup>Includes all units used in the ICI sector, regardless of capacity.

<sup>c</sup>1991 FBC data; other data are from 1977-1978.

<sup>d</sup>SH = Space heat; PH = Process heat; CG = Cogeneration.

<sup>e</sup>\*\* indicates less than 1 percent.

<sup>f</sup>Design capacities can be higher.

<sup>g</sup>FBC = fluidized bed combustion.

<sup>h</sup>N.A. = Not available. No data are available.

influences the feasibility of retrofit for some control technologies because poor access and limited available space.

ICI boiler equipment is principally distinguished by the method of heat transfer of heat to the water. The most common ICI boiler types are the watertube and firetube units. Firetube boilers are generally limited in size to about 50 MMBtu/hr (15 MWt) and steam pressures, although newer designs tend to increase the firing capacity. All of these firetubes are prefabricated in the shop, shipped by rail or truck, and are thus referred to as packaged. Watertube boilers tend to be larger in size than firetube units, although many packaged single burner designs are well within the firetube capacity range. Larger, multi-burner watertubes tend to be field erected, especially older units. Newer watertubes also tend to be single burners and packaged. Steam pressures and temperatures for watertubes are generally higher than firetube units. Combustion air preheat is never used for firetube boiler configuration. Higher capacity watertube ICI boilers often use combustion air preheat. This is an important distinction because air preheat units tend to have higher NO<sub>x</sub> levels.

As the type and sizes of ICI boilers are extremely varied, so are the fuel types and methods of firing. The most commonly used fuels include natural gas, distillate and residual fuel oils, and coal in both crushed and pulverized form. Natural gas and fuel oil are burned in single or multiple burner arrangements. Many ICI boilers have dual fuel capability. In smaller units, the natural gas is normally fed through a ring with holes or nozzles that inject fuel in the air stream. Fuel oil is atomized with steam or compressed air and fed via a nozzle in the center of each burner. Heavy fuel oils must be preheated to decrease viscosity and improve atomization. Crushed coal is burned in stoker and fluidized bed (FBC) boilers. Stoker coal is burned mostly on a grate (moving or vibrating) and is fed by various means. Most popular are the spreader and overfeed methods. Crushed coal in FBC boilers burns in suspension in either a stationary bubbling bed of fuel and bed material or in a circulating fashion. The bed material is often a mixture of sand and limestone for capturing SO<sub>2</sub>. Higher fluidizing velocities are necessary for circulating beds which have become more popular because of higher combustion and SO<sub>2</sub> sorbent efficiencies. Where environmental emissions are strictly controlled and low grade fuels are economically attractive, FBC boilers have become particularly popular because of characteristically low NO<sub>x</sub> and SO<sub>2</sub> emissions.

Although the primary fuel types are fossil based, there is a growing percentage of nonfossil fuels being burned for industrial steam and nonutility power generation. These fuels

include municipal and agricultural wastes, coal mining wastes, and petroleum coke and special wastes such as shredded tires, refuse derived fuel (RDF), tree bark and saw dust, and black liquor from the production of paper. Solid waste fuels are typically burned in stoker or FBC boilers which provide for mass feed of bulk material with minimal pretreatment and the handling of large quantities of ash and other inorganic matter. Some industries also supplement their primary fossil fuels with hazardous organic chemical waste with medium to high heating value. Some of these wastes can contain large concentrations of organically bound nitrogen that can be converted to  $\text{NO}_x$  emissions. The practice of burning hazardous wastes in boilers and industrial furnaces is currently regulated by the EPA under the Resource Conservation and Recovery Act (RCRA).

## 2.2 $\text{NO}_x$ FORMATION AND BASELINE EMISSIONS

$\text{NO}_x$  is the high-temperature byproduct of the combustion of fuel and air. When fuel is burned with air, nitric oxide (NO), the primary form of  $\text{NO}_x$ , is formed mainly from the high temperature reaction of atmospheric nitrogen and oxygen (thermal  $\text{NO}_x$ ) and from the reaction of organically bound nitrogen in the fuel with oxygen (fuel  $\text{NO}_x$ ). A third and less important source of NO formation is referred to as "prompt NO," which forms from the rapid reaction of atmospheric nitrogen with hydrocarbon radical to form  $\text{NO}_x$  precursors that are rapidly oxidized to NO at lower temperatures. Prompt NO is generally minor compared to the overall quantity of NO generated from combustion. However, as  $\text{NO}_x$  emissions are reduced to extremely low limits, i.e., with natural gas combustion, the contribution of prompt NO becomes more important.

The mechanisms of  $\text{NO}_x$  formation in combustion are very complex and cannot be predicted with certainty. Thermal  $\text{NO}_x$  is an exponential function of temperature and varies with the square root of oxygen concentration. Most of the  $\text{NO}_x$  formed from combustion of natural gas and high grade fuel oil (e.g., distillate oil or naphtha) is attributable to thermal  $\text{NO}_x$ . Because of the exponential dependence on temperature, the control of thermal  $\text{NO}_x$  is best achieved by reducing peak combustion temperature. Fuel  $\text{NO}_x$  results from the oxidation of fuel-bound nitrogen. Higher concentrations of fuel nitrogen typically lead to higher fuel  $\text{NO}_x$  and overall  $\text{NO}_x$  levels. Therefore, combustion of residual oil with 0.5 percent fuel-bound nitrogen, will likely result in higher  $\text{NO}_x$  levels than natural gas or distillate oil. Similarly, because coal has higher fuel nitrogen content higher baseline  $\text{NO}_x$  levels are generally measured from coal combustion than either natural gas or oil combustion. This occurs in spite of the fact that the conversion of fuel nitrogen to fuel  $\text{NO}_x$  typically diminishes with increasing nitrogen

concentration. Some ICI boilers, however, that operate at lower combustion temperature, as in the case of an FBC, or with reduced fuel air mixing, as in the case of a stoker, can have low NO<sub>x</sub> emissions because of the suppression of the thermal NO<sub>x</sub> contribution.

Test data were compiled from several sources to arrive at reported ranges and average NO<sub>x</sub> emission levels for ICI boilers. Baseline data were compiled from test results on more than 200 ICI boilers described in EPA documents and technical reports. These data, representative of boiler operation at 70 percent capacity or higher, are detailed in Appendix A. Table 2-2 summarizes the range and average NO<sub>x</sub> emissions from the various categories of ICI boilers investigated in this study. On an average basis, coal-fired ICI boilers emit the highest level of NO<sub>x</sub>, as anticipated. Among the higher emitters are the wall-fired boilers with burners on one or two opposing walls of the furnace. Average NO<sub>x</sub> levels were measured at approximately 0.70 lb/MMBtu. Next highest emitters are tangential boilers burning pulverized coal (PC). The burners on these units are located in the corners of the furnace at several levels and firing in a concentric direction.

Among the stokers, the spreader firing system has the highest NO<sub>x</sub> levels than either the overfeed or underfeed designs. This is because a portion of the coal fines burn in suspension in the spreader design. This method of coal combustion provides for the greatest air-fuel mixing and consequently higher NO<sub>x</sub> formation. FBC boilers emit significantly lower NO<sub>x</sub> emissions than PC-fired units and are generally more efficient than stokers. The large variations in baseline NO<sub>x</sub> levels for the FBC units are generally the result of variations in air distribution among FBC units. Newer FBC designs incorporate a staged air addition that suppresses NO<sub>x</sub> levels. Also the type of bed material and SO<sub>2</sub> sorbent influence the level of NO<sub>x</sub> generated. FBC units are, on average, the lowest NO<sub>x</sub> emitters among coal burning ICI equipment.

Large variations in baseline NO<sub>x</sub> levels are also shown for ICI boilers burning residual oil. For example, boilers with a capacity of less than 100 MMBtu/hr (29 MWt) can have emissions in the range of 0.20 to 0.79 lb/MMBtu, a factor of nearly 4. This is attributable predominantly to large variations in fuel nitrogen content of these fuel oils. NO<sub>x</sub> emissions from distillate-oil- and natural-gas-fired ICI boilers are significantly lower due by and large to the burning of cleaner fuel with little or no fuel-bound nitrogen. It is also important to note that baseline emission levels for the larger boilers tend to be somewhat higher, on average. This is attributable to the higher heat release rate that generally accompanies the larger units in order to minimize the size of the furnace and the cost of the boiler. Also, another factor is the use

TABLE 2-2. SUMMARY OF BASELINE NO<sub>x</sub> EMISSIONS

Fuel	Boiler type	Uncontrolled NO <sub>x</sub> range, lb/MMBtu	Average, lb/MMBtu
Pulverized coal	Wall-fired	0.46-0.89	0.69
	Tangential	0.53-0.68	0.61
	Cyclone	1.12 <sup>a</sup>	1.12
Coal	Spreader stoker	0.35-0.77	0.53
	Overfeed stoker	0.19-0.44	0.29
	Underfeed stoker	0.31-0.48	0.39
	Bubbling FBC	0.11-0.81	0.32
	Circulating FBC	0.14-0.60	0.31
Residual oil	Firetube	0.21-0.39	0.31
	Watertube:		
	10 to 100 MMBtu/hr	0.20-0.79	0.36
> 100 MMBtu/hr	0.31-0.60	0.38	
Distillate oil	Firetube	0.11-0.25	0.17
	Watertube:		
	10 to 100 MMBtu/hr	0.08-0.16	0.13
> 100 MMBtu/hr	0.18-0.23	0.21	
Crude oil	TEOR steam generator	0.30-0.52	0.46
Natural gas	Firetube	0.07-0.13	0.10
	Watertube:		
	≤ 100 MMBtu/hr	0.06-0.31	0.14
	> 100 MMBtu/hr	0.11-0.45	0.26
	TEOR steam generator	0.09-0.13	0.12
Wood	< 70 MMBtu/hr	0.010-0.050	0.022
	≥ 70 MMBtu/hr	0.17-0.30	0.24
Bagasse		0.15 <sup>b</sup>	0.15
MSW	Mass burn	0.40 <sup>b</sup>	0.40
	Modular	0.49 <sup>b</sup>	0.49

<sup>a</sup>Single data point.

<sup>b</sup>AP-42 emission factor.

of preheated combustion air with the larger boilers. Higher heat release rate and preheated combustion air increase the peak temperature of the flame and contribute to higher baseline NO<sub>x</sub> levels. The AP-42 emission factors were used for some of the ICI boilers for which little or no data were available in this study.

### **2.3 CONTROL TECHNIQUES AND CONTROLLED NO<sub>x</sub> EMISSION LEVELS**

The reduction of NO<sub>x</sub> emissions from ICI boilers can be accomplished with combustion modification and flue gas treatment techniques or a combination of these. The application of a specific technique will depend on the type of boiler, the characteristic of its primary fuel, and method of firing. Some controls have seen limited application, whereas certain boilers have little or no flexibility for modification of combustion conditions because of method of firing, size, or operating practices. Table 2-3 lists the applicability of candidate NO<sub>x</sub> control techniques for ICI boiler retrofit. Each "X" marks the applicability of that control to the specific boiler/fuel combination. Although applicable, some techniques have seen limited use because of cost, energy and operational impacts, and other factors.

NO<sub>x</sub> emissions can be controlled by suppressing both thermal and fuel NO<sub>x</sub>. When natural gas or distillate oil is burned, thermal NO<sub>x</sub> is the only component that can be practically controlled due to the low levels of fuel N<sub>2</sub> in the distillate oil. The combustion modification techniques that are most effective in reducing thermal NO<sub>x</sub> are particularly those that reduce peak temperature of the flame. This is accomplished by quenching the combustion with water or steam injection (WI/SI), recirculating a portion of the flue gas to the burner zone (FGR), and reducing air preheat temperature (RAP) when preheated combustion air is used. The use of WI/SI has thus far been limited to small gas-fired boiler applications in Southern California to meet very stringent NO<sub>x</sub> standards. Although very effective in reducing thermal NO<sub>x</sub>, this technique has not been widely applied because of its potential for large thermal efficiency penalties, safety, and burner control problems. FGR, on the other hand, has a wide experience base. The technique is implemented by itself or in combination with LNB retrofits. In fact, many LNB designs for natural-gas-fired ICI boilers incorporate FGR. LNB controls are available from several ICI equipment vendors. RAP is not a practicable technique because of severe energy penalties associated with its use, and for this reason it was not considered further in this document.

Thermal NO<sub>x</sub> can also be reduced to some extent by minimizing the amount of excess oxygen, delaying the mixing of fuel and air, and reducing the firing capacity of the boiler. The



TABLE 2-3. EXPERIENCE WITH NO<sub>x</sub> CONTROL TECHNIQUES ON ICI BOILERS

NO <sub>x</sub> control technique	Coal-fired			Oil-/natural-gas-fired			Nonfossil-fuel-fired			MSW-fired
	Field-erected PC-fired	Stoker	FBC	Field-erected watertube	Packaged watertube	Packaged firetube	Stoker	FBC	Mass burn	
BT/OT					X	X				
WI/SI					X	X				
SCA	X	X <sup>a</sup>	X	X	X <sup>b</sup>		X <sup>a</sup>	X	X <sup>a</sup>	
LNB	X			X	X	X				
FGR				X	X	X				X <sup>b</sup>
NGR	X <sup>b</sup>									X <sup>b</sup>
SNCR	X <sup>b</sup>	X	X	X	X <sup>b</sup>		X	X		X
SCR	X <sup>b</sup>		X <sup>b</sup>	X <sup>b</sup>						

BT/OT = Burner tuning/oxygen trim

WI/SI = Water injection/steam injection

SCA = Staged combustion air, includes burners out of service (BOOS), biased firing, or overfire air (OFA)

LNB = Low-NO<sub>x</sub> burners

FGR = Flue gas recirculation

NGR = Natural gas reburning

SNCR = Selective noncatalytic reduction

SCR = Selective catalytic reduction

MSW = Municipal solid waste

<sup>a</sup>SCA is designed primarily for control of smoke and combustible fuel rather than NO<sub>x</sub>. Optimization of existing SCA (OFA) ports can lead to some NO<sub>x</sub> reduction.

<sup>b</sup>Limited experience.

first technique is often referred to as oxygen trim (OT) or low excess air (LEA) and can be attained by optimizing the operation of the burner(s) for minimum excess air without excessive increase in combustible emissions. The effect of lower oxygen concentration on  $\text{NO}_x$  is partially offset by some increase in thermal  $\text{NO}_x$  because of higher peak temperature with lower gas volume. OT and LEA are often impractical on packaged watertube and firetube boilers due to increased flame lengths and CO, and can lead to rear wall flame impingement, especially when fuel oil is fired. The second technique reduces flame temperature and oxygen availability by staging the amount of combustion air that is introduced in the burner zone. Staged combustion air (SCA) can be accomplished by several means. For multiple burner boiler, the most practical approach is to take certain burners out of service (BOOS) or biasing the fuel flow to selected burners to obtain a similar air staging effect. The third technique involves reducing the boiler firing rate to lower the peak temperature in the furnace. This approach is not often considered because it involves reducing steam generation capacity that must be replaced elsewhere. Also, with some fuels, gains in reduction of thermal  $\text{NO}_x$  are in part negated by increases in fuel  $\text{NO}_x$  that result by increases in excess air at reduced boiler load.

The reduction of fuel  $\text{NO}_x$  with combustion modifications is most effectively achieved with the staging of combustion air. By suppressing the amount of air below that required for complete combustion (stoichiometric conditions), the conversion of fuel nitrogen to  $\text{NO}_x$  can be minimized. This SCA technique is particularly effective on high nitrogen fuels such as coal and residual oil fired boilers, which may have high baseline emissions and would result in high reduction efficiencies. For PC, BOOS for  $\text{NO}_x$  reduction is not practical. Therefore, SCA is usually accomplished with the retrofit of internally air staged burner or overfire air ports. The installation of low- $\text{NO}_x$  burners for PC- and residual-oil-fired boilers is a particularly effective technique because it involves minimal furnace modifications and retained firing capacity. Staged fuel burners in some packaged watertube boilers without membrane convective side furnace wall(s) may cause an increase in CO emissions at the stack, due to short circuiting of incomplete combustion products to the convective section. The installation of OFA ports for some boilers is not practicable. These boilers are principally firetube and watertube packaged designs and most PC-fired units. Large field-erected gas- and low-sulfur oil-fired ICI boilers are the best candidates for the application of OFA because these fuels are least susceptible to the adverse effects of combustion staging, such as furnace corrosion and unburned fuel emissions.

Another combustion modification technique involves the staging of fuel, rather than combustion air. By injecting a portion of the total fuel input downstream of the main combustion zone, hydrocarbon radicals created by the reburning fuel will reduce NO<sub>x</sub> emission emitted by the primary fuel. This reburning technique is best accomplished when the reburning fuel is natural gas. Natural gas reburning (NGR) and cofiring have been investigated primarily for utility boilers, especially coal-fired units that are not good candidates for traditional combustion modifications such as LNB. Examples of these boilers are cyclones and stoker fired furnaces. Application of these techniques on ICI boilers has been limited to some municipal solid waste (MSW) and coal-fired stokers.

NO<sub>x</sub> control experience for ICI boilers with flue gas treatment controls has been limited to the selective noncatalytic and catalytic reduction techniques (SNCR and SCR). Both techniques involve the injection of ammonia or urea in a temperature window of the boiler where NO<sub>x</sub> reduction occurs by the selective reaction of NH<sub>2</sub> radicals with NO to form water and nitrogen. The reaction for the SNCR process must occur at elevated temperatures, typically between 870 and 1,090°C (1,600 and 2,000°F) because the reduction proceeds without a catalyst. At much lower flue gas temperatures, typically in the range of 300 to 400°C (550 to 750°F), the reaction requires the presence of a catalyst. SNCR is particularly effective when the mixing of injected reagent and flue gas is maximized and the residence time of the gas within the reaction temperature is also maximized. These favorable conditions are often encountered in retrofit applications of SNCR on FBC boilers. The reagent is injected at the outlet of the furnace (inlet to the hot cyclone), where mixing is promoted while flue gas temperature remains relatively constant. Other applications of SNCR on stoker boilers burning a variety of fuels and waste fuels have also shown promise. SCR retrofit ICI applications in this country have been limited to a few boilers in California, although the technology is widely used abroad and several vendors are currently marketing several systems.

### **2.3.1 Combustion Modification Controls**

Table 2-4 summarizes control efficiency and NO<sub>x</sub> levels achieved with the retrofit of combustion modification techniques for watertube ICI boilers. The data base includes primarily commercial facilities that were retrofit to meet regulated NO<sub>x</sub> limits. In addition, the data base also includes result obtained from controls installed for research and development of specific techniques. Details and references for this data base can be found in Appendices B and C of this document.

**TABLE 2-4. SUMMARY OF COMBUSTION MODIFICATION NO<sub>x</sub> CONTROL PERFORMANCE ON ICI WATERTUBE BOILERS**

ICI boiler and fuel	NO <sub>x</sub> control	Percent NO <sub>x</sub> reduction	Controlled NO <sub>x</sub> level, lb/MMBtu	Comments
PC, wall-fired	SCA	15-39	0.33-0.93	Limited applicability because of potential side effects.
	LNB	49-67	0.26-0.50	Technology transfer from utility applications.
	NGR	N.A. <sup>a</sup>	0.23-0.52	Limited experience. Technology transfer from utility applications.
	LNB+SCA	42-66	0.24-0.49	Technology transfer from utility applications.
PC, T-fired	SCA	25	0.29-0.38	Effective technique. Technology transfer from utility applications.
	LNB	18	0.36	LNCFS <sup>b</sup> utility firing system design with closed coupled OFA.
	NGR	30	0.23	Limited experience.
	LNB+SCA	55	0.20	LNCFS utility firing system design. Technology transfer from utility applications.
Spreader stoker	SCA	-1-35	0.22-0.52	Potential grate problems and high CO emissions.
	FGR+SCA	0-60	0.19-0.47	Limited applicability.
	RAP	32	0.30	Limited applicability.
	Gas cofiring	20-25	0.18-0.20	Only recent exploratory tests. NO <sub>x</sub> reduction via lower O <sub>2</sub> .
Coal-fired BFBC	SCA	40-67	0.10-0.14	SCA often incorporated in new designs.
Circulating coal-fired FBC	SCA	N.A.	0.05-0.45	SCA often incorporated in new designs.
	SCA+FGR	N.A.	0.12-0.16	Limited application for FGR.
Residual-oil-fired	LNB	30-60	0.09-0.23	Staged air could result in operational problems.
	FGR	4-30	0.12-0.25	Limited effectiveness because of fuel NO <sub>x</sub> contribution.
	SCA	5-40	0.22-0.74	Techniques include BOOS <sup>c</sup> and OFA. Efficiency function of degree of staging.
	LNB+FGR	N.A.	0.23	Combinations are not additive in effectiveness.
	LNB+SCA	N.A.	0.20-0.40	Combinations are not additive in effectiveness.
Distillate-oil-fired	LNB	N.A.	0.06-0.33	Low-excess air burner designs.
	FGR	20-68	0.04-0.15	Widely used technique because of effectiveness.
	SCA	30	0.09-0.12	Limited applications except BOOS <sup>c</sup> , Bias and selected OFA for large watertube.
	LNB+FGR	N.A.	0.03-0.13	Most common technique. Many LNB include FGR.
	LNB+SCA	N.A.	0.20	SCA also included in many LNB designs.
Natural-gas-fired	SCA	17-46	0.06-0.24	Technique includes BOOS <sup>c</sup> and OFA. Many LNB include SCA technique.
	LNB	39-71	0.03-0.17	Popular technique. Many designs and vendors available.
	FGR	53-74	0.02-0.10	Popular technique together with LNB.
	LNB+FGR	55-84	0.02-0.09	Most popular technique for clean fuels.
	LNB+SCA	N.A.	0.10-0.20	Some LNB designs include internal staging.

<sup>a</sup>N.A. = Not available. No data are available to determine control efficiency. See Appendix B for detailed individual test data.

<sup>b</sup>LNCFS = Low-NO<sub>x</sub> Concentric Firing System by ABB-Combustion Engineering.

<sup>c</sup>BOOS is not applicable to single-burner packaged boilers and some multiburner units.

The most effective NO<sub>x</sub> control techniques for PC-fired ICI boilers are LNB, NGR, and LNB+SCA. The average reduction achieved with the retrofit of LNB on seven ICI boilers was 55 percent with a controlled level of 0.35 lb/MMBtu. A combination of LNB plus overfire air (OFA) also achieved an average of 0.35 lb/MMBtu on eight ICI boilers. Lower NO<sub>x</sub> emissions were achieved for tangentially fired boilers. Evaluation of retrofit combustion controls for coal-fired stokers revealed control efficiencies in the range of 0 to 60 percent. This wide range in control efficiency is attributed to the degree of staging implemented and method of staging. Typically, existing OFA ports on stokers are not ideal for effective NO<sub>x</sub> staging. Furthermore, the long term effectiveness of these controls for stokers was not evaluated in these exploratory tests. The average NO<sub>x</sub> reduction for eight stokers with enhanced air staging was 18 percent with a corresponding controlled NO<sub>x</sub> level of 0.38 lb/MMBtu. Largest NO<sub>x</sub> reductions were accompanied by large increases in CO emissions. Gas cofiring in coal-fired stokers, only recently explored, achieves NO<sub>x</sub> reductions in the 20 to 25 percent range only by being able to operate at lower excess air.

Air staging in coal-fired FBC boilers is very effective in reducing NO<sub>x</sub> from these units. FBCs are inherently low NO<sub>x</sub> emitters because low furnace combustion temperatures preclude the formation of thermal NO<sub>x</sub>. Furthermore, the in-bed chemistry between coal particles, CO, and bed materials (including SO<sub>2</sub> sorbents) maintains fuel nitrogen conversion to NO at a minimum. The control of NO<sub>x</sub> is further enhanced by operating these boilers with some air staging. In fact, many new FBC designs, including circulating FBCs, come equipped with air staging capability especially for low NO<sub>x</sub> emissions. Excessive substoichiometric conditions in the dense portion of the fluidized bed can result in premature corrosion of immersed watertubes used in bubbling bed design. Circulating FBC boilers are better suited for deep staging because these units do not use in-bed watertubes.

NO<sub>x</sub> reductions and controlled levels for residual oil combustion are influenced by the nitrogen content of the oil, the degree of staging implemented, and other fuel oil physical and chemical characteristics. Because of these factors, NO<sub>x</sub> control performance on this fuel is likely to vary, as shown in Table 2-4. Data on LNB for residual-oil-fired ICI boilers were obtained primarily from foreign applications. The average controlled NO<sub>x</sub> level reported with LNB for residual-oil-fired ICI boilers is 0.19 lb/MMBtu based on 17 Japanese installations and one domestic unit equipped with Babcock and Wilcox (B&W) XCL-FM burner for industrial boilers.

The data base for distillate-oil- and natural-gas-fired boilers is much larger than that for residual-oil-fired units. This is because many of the distillate-oil- and natural-gas-fired applications are in California, where current regulations have imposed NO<sub>x</sub> reductions from such units. Among the controls more widely used are LNB, FGR, and LNB with FGR. Many LNB designs also incorporate low excess air and FGR, internal to the burner or external in a more conventional application. The average NO<sub>x</sub> reduction for FGR on natural-gas-fired boilers is approximately 60 percent from many industrial boilers, nearly all located in California. The average controlled NO<sub>x</sub> level for FGR-controlled ICI watertube boilers is 0.05 lb/MMBtu or approximately 40 ppm corrected to 3 percent O<sub>2</sub>. For distillate oil, the average FGR-controlled level from watertube boilers is 0.08 lb/MMBtu or approximately 65 ppm corrected to 3 percent O<sub>2</sub>. Average NO<sub>x</sub> emissions controlled with LNB plus FGR are slightly lower than these levels.

Table 2-5 summarizes results of controls for firetube units. Controlled NO<sub>x</sub> levels achieved on these boiler types are generally slightly lower than levels achieved on watertube

**TABLE 2-5. SUMMARY OF COMBUSTION MODIFICATION NO<sub>x</sub> CONTROL PERFORMANCE ON ICI FIRETUBE BOILERS**

Fuel type	NO <sub>x</sub> control	Percent NO <sub>x</sub> reduction	Controlled NO <sub>x</sub> level, lb/MMBtu	Comments
Residual-oil-fired	LNB	30-60	0.09-0.25	Staged air could result in operational problems.
	SCA	49	0.11	Technique generally not practical unless incorporated in new burner design.
Distillate-oil-fired	LNB	15	0.15	Several LNB designs are available. Most operate on low excess air.
	FGR	N.A. <sup>a</sup>	0.04-0.16	Effective technique for clean fuels.
Natural-gas-fired	SCA	5	0.08	Technique not practical unless incorporated in new burner design.
	LNB	32-78	0.02-0.08	Several LNB designs are available. Some include FGR or internal staging.
	FGR	55-76	0.02-0.08	Effective technique. Used in many applications in California.
	LNB+FGR	N.A.	0.02-0.04	Most popular technique for very low NO <sub>x</sub> levels. Some LNB designs include FGR.
	Radiant LNB	53-82	0.01-0.04	Commercial experience limited to small firetubes.

<sup>a</sup>N.A. = Not available. No data are available to determine control efficiency. See Appendix B for detailed individual test data.

units. For example, LNB + FGR recorded an average of about 0.033 lb/MMBtu or approximately 35 ppm corrected to 3 percent O<sub>2</sub>. FGR by itself is also capable to achieve these low NO<sub>x</sub> levels when burning natural gas. In addition to these combustion controls, both OT and WI have been retrofitted in combination on selected packaged industrial boilers in California to meet very low NO<sub>x</sub> levels. These controls offer the potential for economic NO<sub>x</sub> control because of low initial capital investment compared to either FGR or LNB. NO<sub>x</sub> reduction efficiencies and controlled levels have been reported in the range of about 55 to 75 percent depending on the amount of water injected and the level of boiler efficiency loss acceptable to the facility.

### **2.3.2 Flue Gas Treatment Controls**

Application of flue gas treatment controls in the United States is generally sparse. Table 2-6 summarizes the range in NO<sub>x</sub> reduction performance and controlled NO<sub>x</sub> levels achieved with the application of SNCR and SCR. The data base assembled to produce these results includes both domestic and foreign installation whose results have been reported in the literature or were available from selected technology vendors. References and details are available in Appendix B.

The NO<sub>x</sub> reduction efficiency of SNCR for PC-fired boilers is based on results from four boilers, one a small utility unit. For these boilers, NO<sub>x</sub> reductions ranged from 30 to 83 percent and averaged 60 percent, with controlled NO<sub>x</sub> levels in the range of 0.15 to 0.40 lb/MMBtu. SNCR performance is known to vary with boiler load because of the shifting temperature window. SNCR has been reported to be quite more effective for FBC and stoker boilers. In circulating FBC boilers in California, SNCR with either urea or ammonia injection, achieved an average NO<sub>x</sub> reduction and controlled level of nearly 75 percent and 0.08 lb/MMBtu, respectively. SNCR results for 13 coal-fired stokers ranged from 40 to 74 percent reduction, with controlled NO<sub>x</sub> levels between 0.14 and 0.28 lb/MMBtu. For stokers burning primarily waste fuels, including MSW mass burning equipment, several applications of SNCR resulted in NO<sub>x</sub> reductions in the range of 25 to 80 percent, averaging about 60 percent, with controlled levels in the range of 0.035 to 0.31 lb/MMBtu.

### **2.4 COST AND COST EFFECTIVENESS OF NO<sub>x</sub> CONTROL TECHNIQUES**

A simplified costing methodology, based primarily on the U.S. EPA's Office of Air Quality Planning and Standards (OAQPS) Control Cost Manual, was developed for this study. The capital control costs were based on costs reported by vendors and users of the NO<sub>x</sub> control technologies and from data available in the open literature. The total capital investment was

**TABLE 2-6. SUMMARY OF FLUE GAS TREATMENT NO<sub>x</sub> CONTROL PERFORMANCE ON ICI BOILERS**

ICI boiler and fuel	NO <sub>x</sub> control	Percent NO <sub>x</sub> reduction	Controlled NO <sub>x</sub> level, lb/MMBtu	Comments
PC, wall-fired	SNCR-Urea	30-83	0.15-0.40	Experience relies primarily on utility retrofits. Because of relatively higher NO <sub>x</sub> , higher control efficiency is frequently achieved.
Coal-fired FBC	SCR	53-63	0.10-0.15	Limited applications to few foreign installations. No domestic experience.
Coal-Stoker	SNCR-Ammonia	50-66	0.15-0.18	Control levels achieved in combination with OFA controls.
Coal-Stoker	SNCR-Urea	40-74	0.14-0.28	Control levels achieved in combination with OFA controls.
Wood-fired stoker	SNCR-Ammonia	50-80	0.04-0.23	Vendors of technology report good efficiency for stoker applications irrespective of fuels.
	SNCR-Urea	25-78	0.09-0.17	
MSW stokers and mass burn	SNCR-Ammonia	45-79	0.07-0.31	Vendors of technology report good efficiency for stokers applications, irrespective of fuels.
	SNCR-Urea	41-75	0.06-0.30	
	SCR	53	0.05	
Coal-fired FBC	SNCR-Ammonia	76-80	0.04-0.09	Technique is particularly effective for FBC boilers. Applications limited to California sites.
	SNCR-Urea	57-88	0.03-0.14	
Wood-fired FBC	SNCR-Ammonia	44-80	0.03-0.20	Technique is particularly effective for FBC boilers irrespective of fuel type. Applications limited to California sites.
	SNCR-Urea	60-70	0.06-0.07	
Wood-fired Watertube	SNCR-Urea	50-52	0.14-0.26	Limited application and experience.
	SCR	80	0.22	Only two known installations in the United States.
Natural-gas- and distillate-oil-fired watertube	SNCR-Ammonia	30-72	0.03-0.20	Limited application and experience.
	SNCR-Urea	50-60	0.05-0.10	
	SCR	53-91	0.01-0.05	



annualized using a 10-percent interest rate and an amortization period of 10 years. Cost effectiveness was calculated by dividing the total annualized cost by an NO<sub>x</sub> reduction for each retrofit cost case using boiler capacity factors in the range of 0.33 to 0.80.

Table 2-7 summarizes the total investment cost and cost effectiveness of several retrofit scenarios. Overall, the total investment of controls varies from a minimum of about \$100/MMBtu/hr for oxygen trim with operation of the boiler with BOOS for multi-burner watertubes, to an estimated \$20,000/MMBtu/hr for the installation of SCR on a 400 MMBtu/hr (120 MWt) PC-fired boiler. The high costs of SCR retrofit were derived from estimates developed for small utility boilers, and are meant to be estimates because no domestic application of this technology was available at the time of this printing. Furthermore, costs of SCR systems have recently shown a downward trend because of improvements in the technology, increased number of applications, and competitiveness in the NO<sub>x</sub> retrofit market.

Control techniques with the lowest investment cost are those that require minimum equipment modification or replacement. For example, the installation of an OT system coupled with WI for gas-fired firetubes and packaged watertube is typically much less than \$35,000. Also the application of BOOS in multi-burner units may be a relatively low investment cost approach in reducing NO<sub>x</sub>. These costs, however, do not consider the installation of emission monitoring instrumentation. The cost of CEM systems can easily outweigh the cost of NO<sub>x</sub> controls for these packaged boilers. The cost effectiveness of WI controls for packaged boilers is anticipated to be low in spite of the associated efficiency losses. This is because an efficiency improvement was credited with the combined application of oxygen trim controls that can compensate for some of the losses of WI.

The installation of FGR, LNB, and LNB with FGR controls for both packaged and multi-burner field erected boilers burning natural gas or oil was estimated to range between \$650/MMBtu/hr and \$4,700/MMBtu/hr with cost effectiveness as low as \$240/ton to as high as \$6,300/ton, depending on fuel type and boiler capacity. The cost of SNCR is based on estimates provided by two vendors of the technology. For a 400 MMBtu/hr boiler, the investment cost can be as low as \$1,100/MMBtu/hr for a stoker boiler burning coal, to \$3,300/MMBtu/hr for an MSW unit burning stoker. The cost effectiveness of SNCR was calculated to range from as low as \$1,010/ton to \$2,400/ton depending on fuel and boiler type. SNCR costs are not likely to vary with type of reagent used (aqueous ammonia or urea).

**TABLE 2-7. ESTIMATED COST AND COST EFFECTIVENESS OF NO<sub>x</sub> CONTROLS  
(1992 DOLLARS)**

Fuel type	Boiler type and size, MMBtu/hr	NO <sub>x</sub> control technique	Estimated NO <sub>x</sub> control level, lb/MMBtu <sup>a</sup>	NO <sub>x</sub> reduction, tons/yr	Total capital investment, \$/MMBtu/hr	Cost effectiveness, \$/ton of NO <sub>x</sub>
Pulverized coal	Watertube (400)	LNB	0.35	310	5,300	1,170-1,530
		SNCR	0.39	270	1,600-2,100	1,010-1,400
		SCR	0.14	490	20,000	3,400-4,200
Coal	FBC (400)	SNCR	0.08	210	1,600	890-1,030
	S. Stoker (400)	SNCR	0.22	270	1,100	1,300-1,500
Natural gas	Single burner packaged watertube (50)	OT+WI	0.06	5.8	530	710-820
		LNB	0.08	4.3	650-2,300	570-2,400
		LNB+FGR	0.06	5.8	2,100-4,700	1,600-4,400
		SCR	0.02	8.7	2,400-6,900	4,800-6,900
	Packaged firetube (10.5)	OT+WI	0.04	1.3	2,400	3,100-3,700
		OT+FGR	0.07	0.65	5,300	8,000-11,000
	Multiburner field-erected watertube (300)	OT+SCA <sup>b</sup>	0.15	53	190	210-240
		LNB	0.12	60	5,100-8,300	2,100-4,200
Distillate oil	Single burner packaged watertube (50)	LNB	0.10	3.3	2,300	460-1,900
		LNB+FGR	0.07	6.6	2,100-4,700	1,000-3,300
		SCR	0.03	25	2,400-6,900	3,900-5,500
	Packaged firetube (10.5)	OT+FGR	0.12	1.6	5,400	4,500-6,200
	Multiburner watertube (300)	LNB	0.10	72	5,100-8,300	3,100-6,300
Residual oil	Single burner packaged watertube (50)	LNB	0.19	19	2,300	240-1,000
		LNB+FGR	0.15	23	2,100-4,700	760-2,000
		SCR	0.06	33	2,400-6,900	2,000-2,900
	Firetube (10.5)	LNB	0.17	4.6	5,400	2,700-3,600
	Multiburner watertube (300)	LNB	0.19	120	5,100-8,300	1,600-3,300
Wood waste	Stoker (150)	SNCR	0.11	43	2,100-2,500	1,300-2,400
	FBC (400)	SNCR	0.11	61	970	1,500-1,600
MSW	Stoker (500)	SNCR	0.18	240	2,100-3,300	1,500-2,100

<sup>a</sup>Average levels calculated from the data base available to this study. Average levels do not necessarily represent what can be achieved in all cases.

<sup>b</sup>SCA is burners out of service.

Notes: Boiler capacity factor between 0.50 and 0.66. See Appendices D, E, F, and G for details of costing. Costs do not include installation of continuous emission monitoring (CEM) system. Annual NO<sub>x</sub> reduction based on 0.50 capacity factor. Total capital investment from Appendices E through G.

Figures 2-1 through 2-4 illustrate how the cost effectiveness of these controls varies with boiler capacity. As anticipated, the larger the boiler size the more cost effective is the control. Also, costs increase much more rapidly for boilers below 50 MMBtu/hr in size.

## **2.5 ENERGY AND ENVIRONMENTAL IMPACTS OF NO<sub>x</sub> CONTROL TECHNIQUES**

Combustion modification controls to reduce NO<sub>x</sub> emissions from ICI boilers can result in either increase or decreases in the emissions of other pollutants, principally CO emissions. The actual effect will depend on the operating conditions of the boiler's existing equipment and the sophistication of burner management system. As discussed earlier, many of these boilers especially the smaller packaged units are operated relatively with little supervision and with combustion safety margin which includes excessive amounts of combustion air to ensure efficient combustion. For these boilers, the installation of burner controls to reduce excess oxygen is likely to reduce NO<sub>x</sub> emissions with some increase in CO emissions. For those boilers, that have poor air distribution to the active burners, a program of burner tuning with oxygen trim is likely to achieve both some reduction in NO<sub>x</sub> and CO as well.

Table 2-8 lists CO emissions changes that were recorded with the application of combustion modification controls. The information shows that high CO emission are more prevalent when burning coal, especially with combustion controls such as LNB and SCA. Highest CO levels were recorded from the application of SCA for FBC boilers. CO emissions from combustion modifications for natural-gas- and oil-fired boilers are usually less than 200 ppm. Higher CO levels are likely to be recorded with the attainment of strict NO<sub>x</sub> emission levels. In recognition of this, the South Coast Air Quality Management District (SCAQMD) in California permits 400-ppm CO levels for low NO<sub>x</sub> permits under its Rule 1146. Also, the American Boiler Manufacturers Association (ABMA) recommends 400-ppm CO levels when NO<sub>x</sub> emissions from ICI boilers are lowered. Increases in particulate emissions and unburned carbon are other potential impacts of combustion modification NO<sub>x</sub> control retrofits on oil- and coal-fired ICI boilers. Insufficient data are available to quantify these potential impacts, however.

Other potential environmental impacts can result from the application of SNCR and SCR control techniques. Both techniques can have ammonia emissions released to the atmosphere from the boiler's stack. Ammonia-based SNCR or SCR can result in ammonia releases from the transport, storage, and handling of the chemical reagent. Data from technology vendors show that the level of unreacted ammonia emitted from the boiler's stack

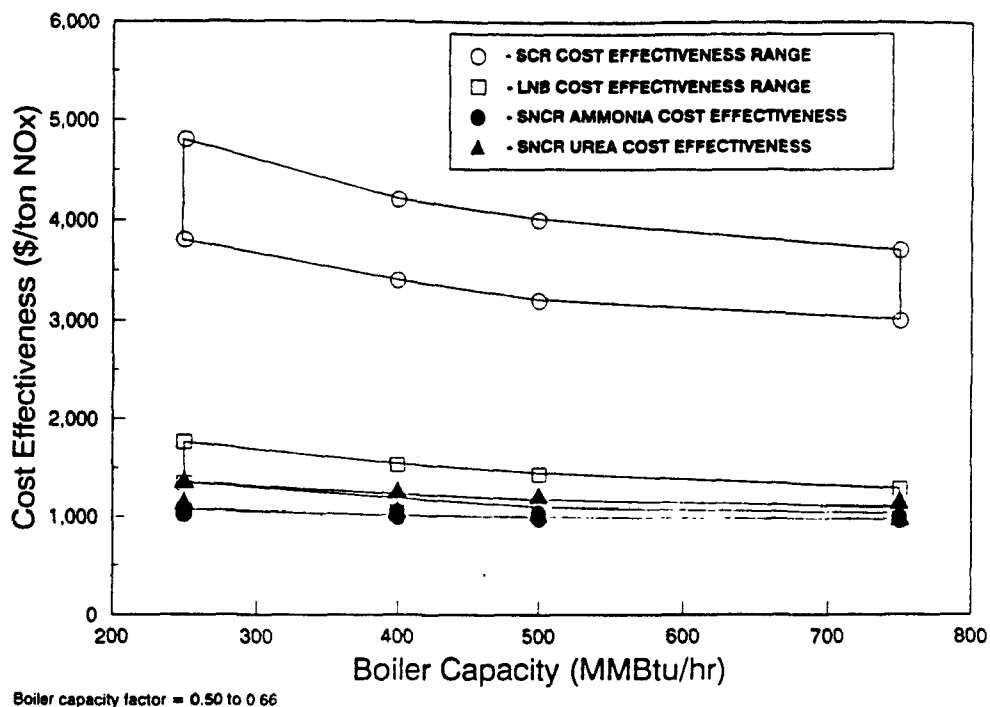

Figure 2-1. Cost effectiveness versus boiler capacity, PC wall-fired boilers.

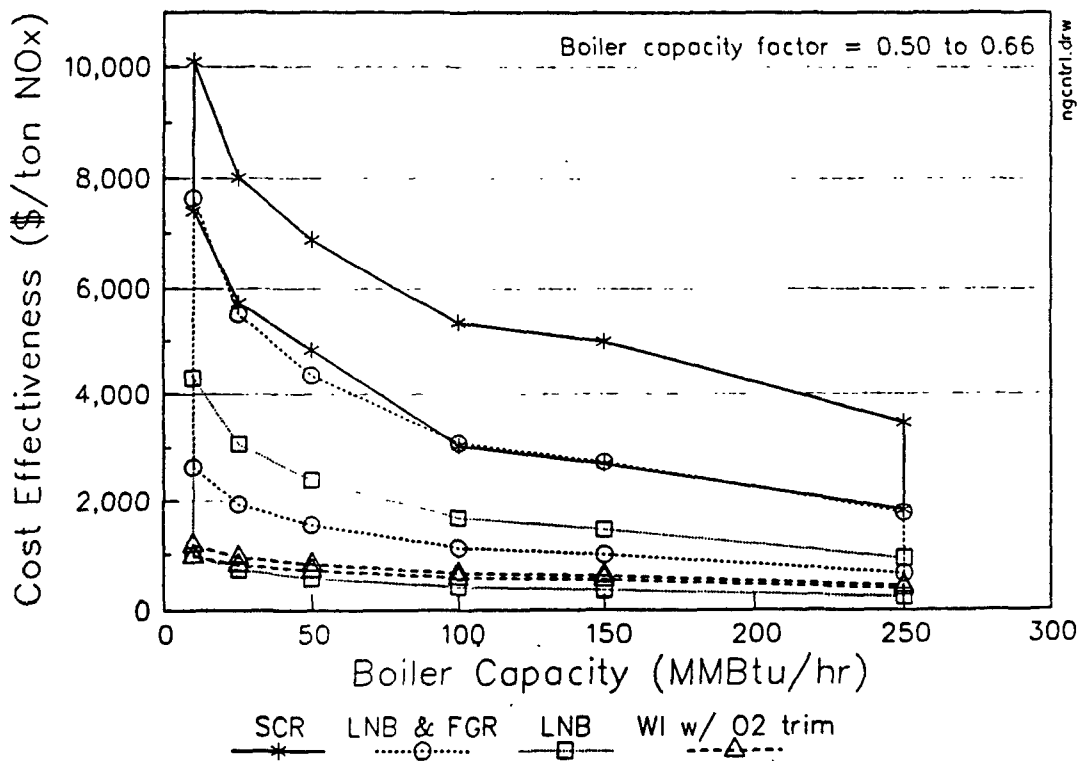

Figure 2-2. Cost effectiveness versus boiler capacity, natural-gas-fired packaged watertube boilers.

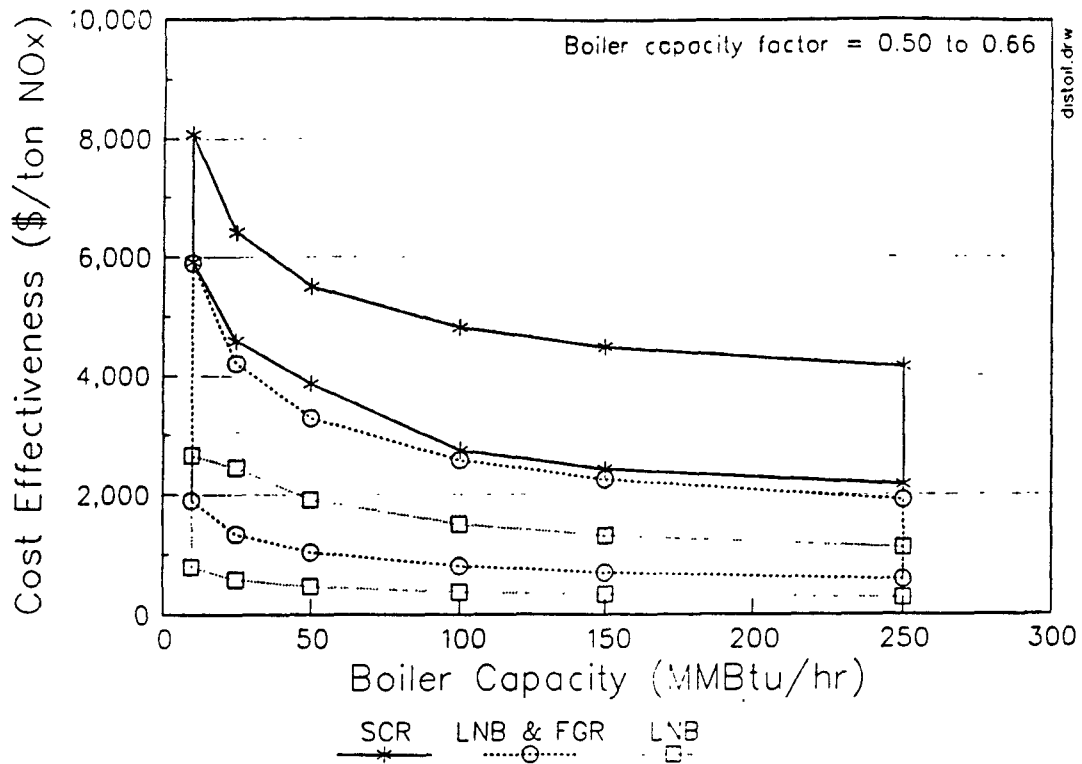

Figure 2-3. Cost effectiveness versus boiler capacity, distillate-oil-fired boilers.

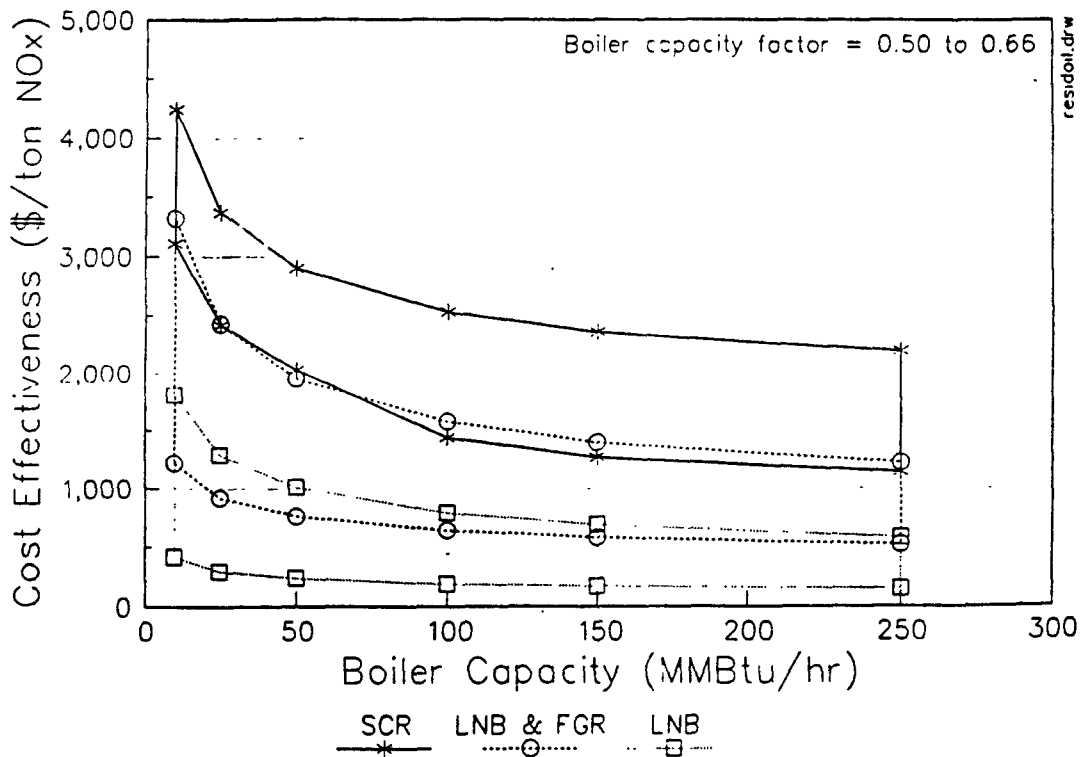

Figure 2-4. Cost effectiveness versus boiler capacity, residual-oil-fired boilers.

**TABLE 2-8. EFFECTS OF NO<sub>x</sub> CONTROLS ON CO EMISSIONS FROM ICI BOILERS**

Boiler and fuel type	NO <sub>x</sub> control	NO <sub>x</sub> reduction, %	CO emissions impact	
			Emissions at low NO <sub>x</sub> , ppm	Average change, %
Coal-fired watertube	LNB	67	13-430	+800
	LNB+SCA	66	60-166	+215
Coal-fired stoker	SCA	31	429	+80
Coal-fired FBC	SCA	67	550-1,100	+86
Gas-fired packaged firetube	FGR	59-74	3-192	-93 - -6.3
	LNB	32-82	0-30	-100 - -53
Gas-fired packaged watertube	FGR	53-78	20-205	-70 - +450
	LNB+FGR	55	2	-98
Distillate oil packaged watertube	FGR	20-68	24-46	+20 - +1,000
Distillate oil packaged firetube	LNB	15	13	+120
Residual oil watertube	FGR	4-30	20-145	0 - +1,400
	SCA	8-40	20-100	N.A. <sup>a</sup>

<sup>a</sup>N.A. = Not available.

when either urea and ammonia-based processes are used is less than 40 ppm. The actual level of ammonia breakthrough will depend on how well the reagent feedrate is controlled with variable boiler loads and on the optimization of injection location and mixing of reagent with the flue gas. For some retrofits, especially packaged boilers, the injection of reagents at SNCR temperatures and the retrofit of SNCR reactors are difficult if not completely impractical.

Increased energy consumption will result from the retrofit of most NO<sub>x</sub> control techniques. For example, the injection of water or steam to chill the flame and reduce thermal NO<sub>x</sub> will reduce the thermal efficiency of the boiler by 0.5 to 2 percent depending on the quantity of water used. Increases in CO emissions that can result from the application of certain controls such as WI, SCA, and LNB will also translate to increased fuel consumption. The application of FGR will require auxiliary power to operate the flue gas recirculation fan. Both

SNCR and SCR have auxiliary power requirements to operate reagent feed and circulating pumps. Also, anhydrous ammonia-based SNCR and SCR require auxiliary power to operate vaporizers and for increased combustion air fan power to overcome higher pressure drop across catalysts. Additionally, increases in flue gas temperatures, often necessary to maintain the SCR reactor temperature constant over the boiler load, can translate into large boiler thermal efficiency losses. Oxygen trim and burner tuning will, on the other end, often result in an efficiency improvement for the boiler. This is because lower oxygen content in the flue gas translates to lower latent heat loss at the stack. Estimates of increases and potential decreases in energy consumption are presented in Chapter 7.

### 3. ICI BOILER EQUIPMENT PROFILE

ICI boilers span a broad range of equipment designs, fuels, and heat input capacities. The feasibility of retrofitting existing ICI boilers with NO<sub>x</sub> controls, and the effectiveness and costs of these controls, depend on many boiler design characteristics such as heat transfer configuration, furnace size, burner configuration, and heat input capacity. Many of these design characteristics are influenced by the type of fuel used such as natural gas, fuel oil, pulverized and stoker coal, and solid waste fuels. Uncontrolled NO<sub>x</sub> emissions also vary significantly among the various fuels and boiler design types. Combustion modifications are the most common approach to reducing NO<sub>x</sub>, but experience with many ICI boiler types is limited. FGT controls can substitute for combustion modifications or can provide additive NO<sub>x</sub> reductions from controlled-combustion levels.

This chapter presents an overview of ICI boiler equipment to aid in the assessment of NO<sub>x</sub> control technologies. A boiler is defined here as a combustion device, fired with fossil or nonfossil fuels, used to produce steam or to heat water. In most ICI boiler applications, the steam is used for process heating, electrical or mechanical power generation, space heating, or a combination of these. Smaller ICI boilers produce hot water or steam primarily for space heating. The complete boiler system includes the furnace and combustion system, the heat exchange medium where combustion heat is transferred to the water, and the exhaust system. There are roughly 54,000 industrial boilers currently in operation in the United States today, with new units being added at the rate of about 200 per year. Of these new units, nearly 80 percent are sold as replacement units, thus the nation's industrial boiler population is growing only slightly. The leading user industries, ranked on the basis of aggregate steaming capacity, are the paper products industry, the chemical products industry, the food industry, and the petroleum industry.<sup>1</sup>

As a whole, ICI boilers span the range of heat input capacities from 0.4 to 1,500 MMBtu/hr (0.11 to 440 MWt). Table 3-1 gives the distribution of the major ICI boiler



TABLE 3-1. ICI BOILER EQUIPMENT, FUELS, AND APPLICATIONS

Heat transfer configuration	Design and fuel type	Capacity range, MMBtu/hr <sup>a</sup>	% of ICI boiler units <sup>b,c</sup>	% of ICI boiler capacity <sup>b,c</sup>	Application <sup>d</sup>
Watertube	Pulverized coal	100-1,500+	**	2.5	PH, CG
	Stoker coal	0.4-550+ <sup>e</sup>	** <sup>f</sup>	5.0	SH, PH, CG
	FBC <sup>g</sup> coal	1.4-1,075	**	**	PH, CG
	Gas/oil	0.4-1,500+	2.3	23.6	SH, PH, CG
	Oil field steamer	20-62.5	N.A. <sup>h</sup>	N.A.	PH
	Stoker nonfossil	1.5-1,000 <sup>e</sup>	**	1.1	SH, PH, CG
	FBC nonfossil	40-345	**	**	PH, CG
	Other nonfossil	3-800	**	**	SH, PH, CG
Firetube	HRT coal	0.5-50	**	**	SH, PH
	Scotch coal	0.4-50	**	**	SH, PH
	Vertical coal	<2.5	**	**	SH, PH
	Firebox coal	0.4-25	**	**	SH, PH
	HRT gas/oil	0.5-50	1.5	1.5	SH, PH
	Scotch gas/oil	0.4-50	4.8	4.6	SH, PH
	Vertical gas/oil	<2.5	1.0	**	SH, PH
	Firebox gas/oil	<20	6.5	48	SH, PH
	HRT nonfossil	2-50	N.A.	N.A.	SH, PH
	Firebox nonfossil	2-20	N.A.	N.A.	SH, PH
Cast iron	Coal	<0.4-14	9.9	1.3	SH, PH
	Gas/oil	<0.4-14	72	9.6	SH, PH
Tubeless	Gas/oil	<0.4-4	N.A.	N.A.	SH, PH

<sup>a</sup>To convert to MWt, multiply by 0.293.

<sup>b</sup>Includes all units used in the ICI sector, regardless of capacity.

<sup>c</sup>1991 FBC data<sup>2</sup>; other data are from 1977-1978.<sup>3,4</sup>

<sup>d</sup>SH = Space heat; PH = Process heat; CG = cogeneration.

<sup>e</sup>Design capacities can be higher.

<sup>f</sup>\*\* indicates less than 1 percent.

<sup>g</sup>FBC = fluidized bed combustion

<sup>h</sup>N.A. = Not available. No data are available.

types currently in use. Figures 3-1 and 3-2 illustrate the range of heat input capacities applicable to various fuels, heat transfer configurations, and equipment types. Industrial boilers generally have heat input capacities ranging from 10 to 250 MMBtu/hr (2.9 to 73 MWt). This range encompasses most boilers currently in use in the industrial, commercial, and institutional sectors. Those industrial boilers with heat input capacities greater than 250 MMBtu/hr (73 MWt) are generally similar to utility boilers.<sup>5</sup> Therefore, many of the NO<sub>x</sub> controls applicable to utility boilers are also candidate controls for large industrial boilers.

Boilers with heat input capacities less than 10 MMBtu/hr are generally classified as commercial/institutional units. These boilers are used in a wide array of applications, such as wholesale and retail trade, office buildings, hotels, restaurants, hospitals, schools, museums, and government facilities, primarily providing steam and hot water for space heating.<sup>3</sup> Boilers used in this sector generally range in size from 0.4 to 12.5 MMBtu/hr (0.11 to 3.7 MWt) heat input capacity, although some are appreciably larger.<sup>6</sup>

As the types and sizes of ICI boilers are extremely varied, so too are the fuel types burned in these units. The most commonly used fuels include natural gas, distillate and residual fuel oils, and coal in both crushed and pulverized form. Although the primary fuel types used are fossil based, there is a growing percentage of nonfossil fuels being burned for industrial steam and nonutility power generation. The fuels' physical and chemical composition greatly influence the quantity and type of emissions produced, and the feasibility of certain types of NO<sub>x</sub> controls, as will be discussed in Chapters 4 and 5.

The following sections describe the main characteristics of ICI boiler types used in the United States. Section 3.1 describes the three main heat transfer configurations of boilers. Section 3.2 addresses those units primarily fueled by coal. Section 3.3 discusses oil- and natural-gas-fired boilers. Finally, Section 3.4 describes nonfossil-fueled boilers.

### **3.1 BOILER HEAT TRANSFER CONFIGURATIONS**

An important way of classifying boilers is by heat transfer configuration. The four major configurations are watertube, firetube, cast iron, and tubeless. In a watertube boiler (Figures 3-3 and 3-4), combustion heat is transferred to water flowing through tubes lining the furnace walls and boiler passes. The furnace watertubes absorb primarily radiative heat, while the watertubes in the boiler passes gain heat by convective heat transfer. ICI watertube boilers span the entire range of ICI boiler capacities: 0.4 to 1,500 MMBtu/hr (0.11 to 440 MWt) heat input capacity.<sup>7,8</sup> They can be either packaged or field-erected, depending on their size. In general, most units

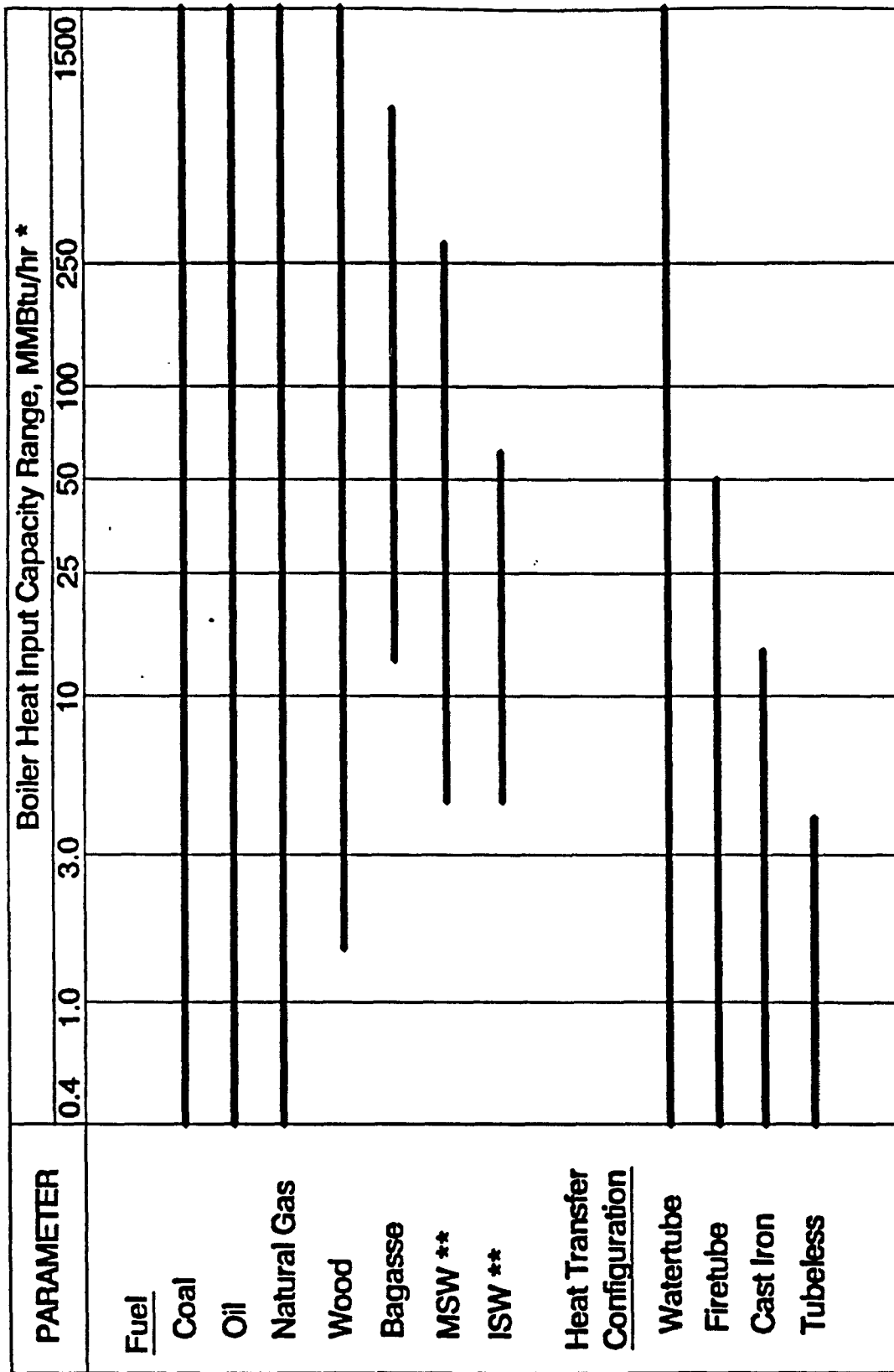

\* To convert MMBtu/hr to MW multiply by 0.293

\*\* MSW - municipal solid waste; ISW - industrial solid waste

Figure 3-1. Occurrence of fuel types and heat transfer configurations by capacity.

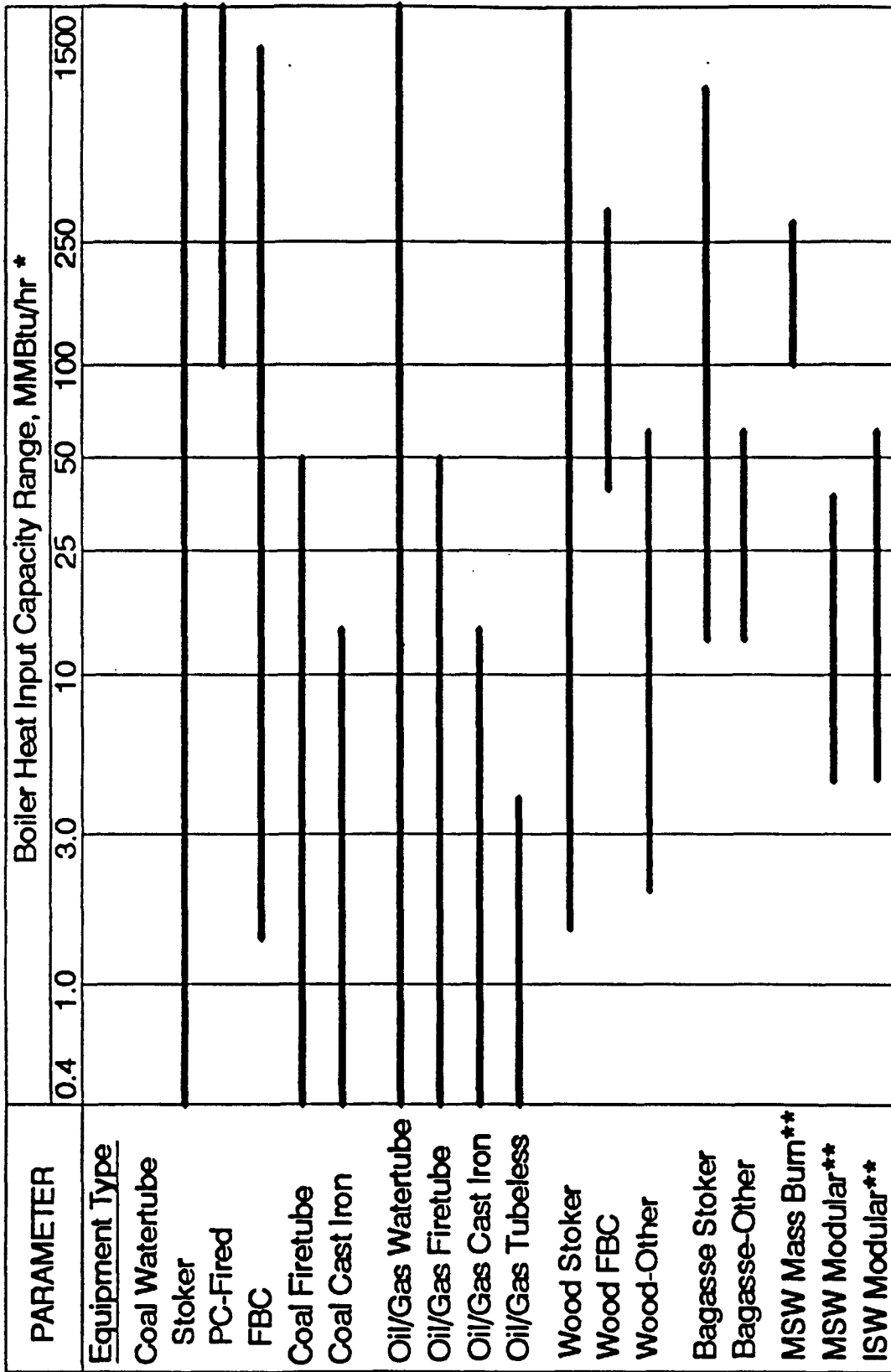

\* To convert MMBtu/hr to MW multiply by 0.293

\*\* MSW - municipal solid waste; ISW - industrial solid waste

Figure 3-2. Occurrence of ICI boiler equipment types by capacity.

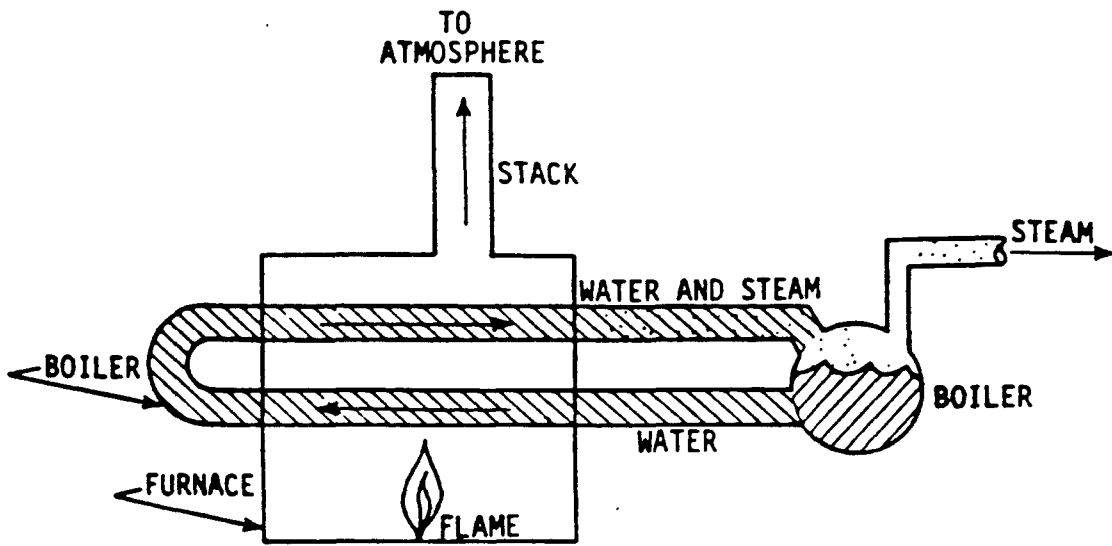

Figure 3-3. Simplified diagram of a watertube boiler.<sup>9</sup>

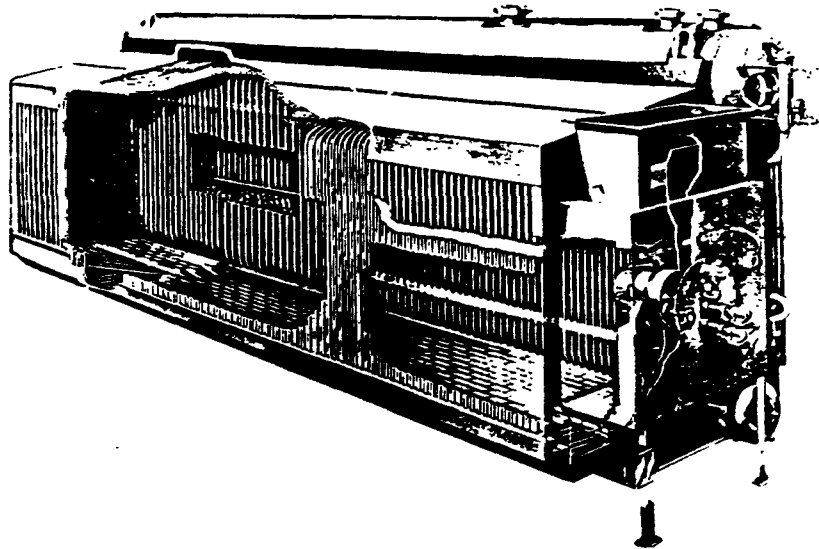

Figure 3-4. Watertube boiler.<sup>10</sup>

greater than 200 MMBtu/hr heat input capacity are field-erected. Field-erected units are assembled onsite; these include all large multi-burner gas- and oil-fired boilers and most PC and stoker units. Packaged boilers are shipped by rail or flatbed truck as complete units. New gas- and oil-fired boilers as large as 150 MMBtu/hr (44 MWt) heat input capacity are typically shop-assembled and shipped as packaged units. Demand for packaged boilers peaked in the 1970s, when premium fuel restrictions and the rapidly escalating prices of oil and gas caused their decline. However, with government's repeal of its premium fuel use restrictions, and with greater availability and lowered prices of oil and gas, the packaged boiler is becoming increasingly popular.<sup>11</sup>

In a firetube boiler (Figures 3-5 and 3-6), the hot combustion gases flow through tubes immersed in the boiler water, transferring heat to the water. The firebox itself is also often immersed in the water. At high pressures, and when subjected to large variations in steam demand, firetube units are more susceptible to structural failure than watertube boilers, since, in the firetube units, the high-pressure steam is contained by the boiler walls rather than by multiple small diameter watertubes, which are inherently stronger.<sup>6</sup> As a consequence, ICI firetube boilers are typically small, with heat input capacities limited to less than 50 MMBtu/hr (15 MWt)<sup>12</sup>, and steam pressures limited to 300 psig, although high-end steam pressures of 150 psig are more common. Firetubes are used primarily where loads are relatively constant. Nearly all firetube boilers are sold as packaged units because of their relatively small size.

In a cast iron boiler, combustion gases rise through a vertical heat exchanger and out through an exhaust duct. Water in the heat exchanger tubes is heated as it moves upward through the tubes. Cast iron boilers produce low-pressure steam or hot water, and generally burn oil or natural gas.<sup>13</sup> They are used primarily in the residential and commercial sectors, and have heat input capacities up to 14 MMBtu/hr (4.1 MWt).<sup>14</sup>

The tubeless design incorporates nested pressure vessels with water in between the shells. Combustion gases are fired into the inner pressure vessel and are then sometimes recirculated outside the second vessel.

## **3.2 COAL-FIRED BOILER EQUIPMENT TYPES**

In 1977, 12 percent of all ICI boilers in the United States were coal-fired.<sup>3</sup> Coal has not been utilized in ICI boilers as extensively as oil or natural gas, chiefly due to cost-effectiveness considerations for the smaller units. Although the majority of coal-fired ICI boilers are smaller cast iron units, coal-fired firetube or cast iron boilers are not as common as oil- or natural-gas-

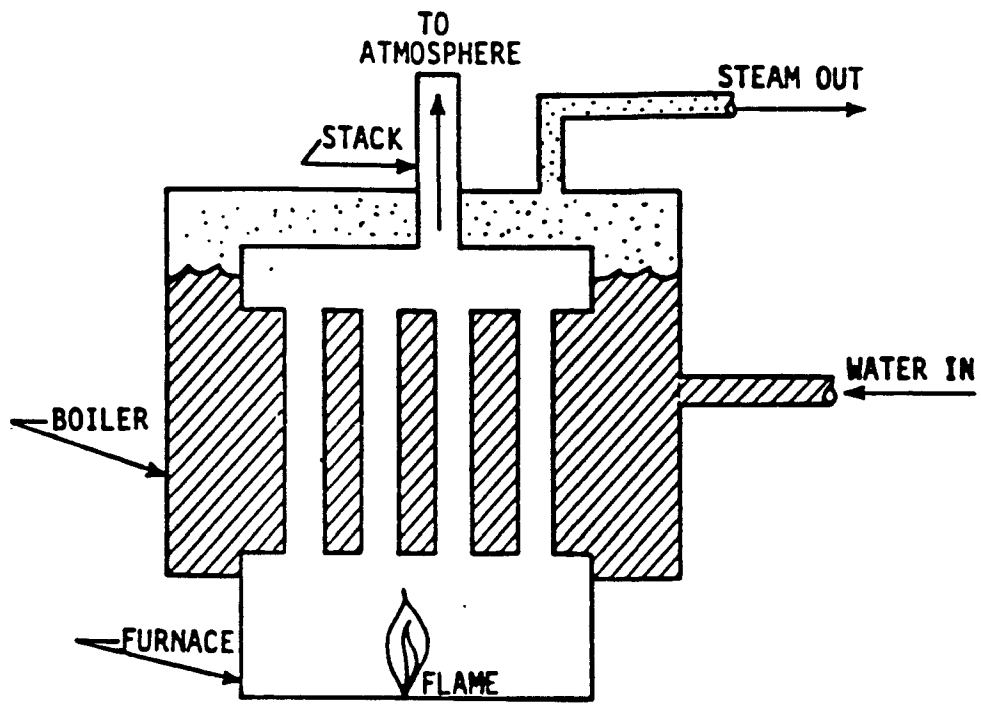

Figure 3-5. Simplified diagram of a firetube boiler.<sup>15</sup>

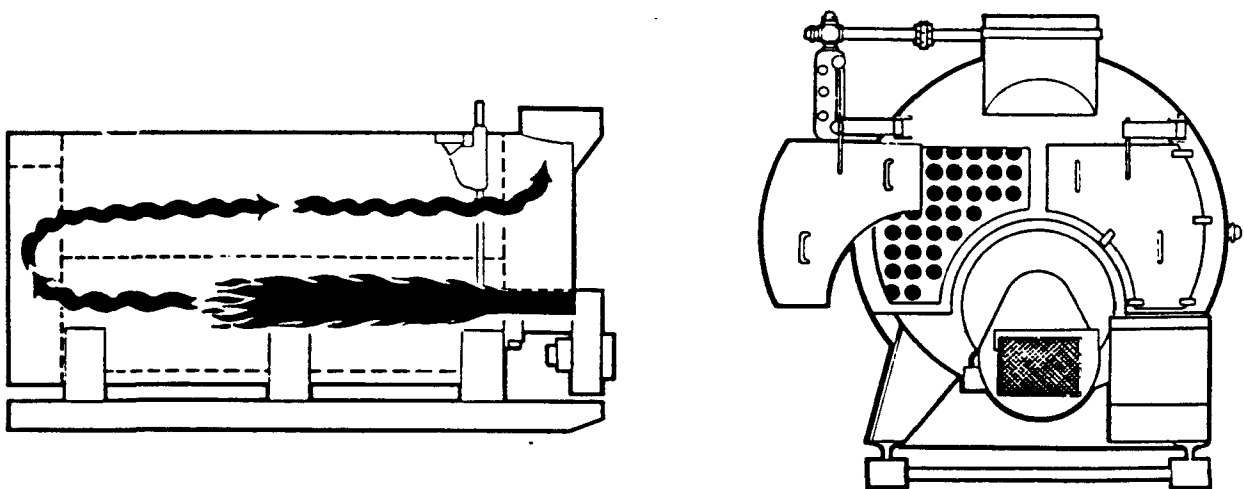

Figure 3-6. Firetube boiler.<sup>16</sup>

fired firetube units. As discussed above, this is because firetube boilers are usually limited to 50 MMBtu/hr (15 MWt) heat input capacity. For smaller industrial and commercial units below this capacity, coal has not been a popular fuel because of the high capital cost of coal handling equipment relative to the costs of the boilers. Thus, most ICI boilers are fueled with oil or natural gas.

Nevertheless, there has been a market percentage increase in coal-fired boilers since the early 1970s. Of the total industrial boiler units purchased in 1971, only 0.5 percent were designed primarily for coal use. By 1980, coal-fired boilers claimed 13.7 percent of the new boiler market. With regards to the application of these coal-fired boilers, five industry groups consumed 66 percent of the total industrial coal used in 1980. These groups included the chemical products industry, the paper products industry, the food and kindred products industry, the primary metals industry, and the transportation equipment industry.<sup>17</sup>

### **3.2.1 Coal-fired Watertube Boilers**

Coal-fired watertube boilers made up less than 1 percent of the total United States ICI boiler population in 1977, the last time an industrial boiler inventory was taken. Yet, due to their larger capacities, these units accounted for 14 percent of the total operating capacity.<sup>18</sup> Coal-fired watertube ICI boilers can be classified into three major categories: stokers, PC-fired units, and FBC boilers. The following subsections describe these types of boilers.

#### **3.2.1.1 Stoker-firing Watertube Boilers**

Stoker-firing systems account for approximately 90 percent of coal-fired watertube ICI boilers.<sup>19</sup> Stoker systems can be divided into three groups: underfeed stokers, overfeed stokers, and spreader stokers. These systems differ in how fuel is supplied to either a moving or stationary grate for burning. One important similarity among all stokers is that all design types use underfeed air to combust the coal char on the grate, combined with one or more levels of overfire air introduced above the grate. This helps ensure complete combustion of volatiles and low combustion emissions. Most stokers also utilize flyash reinjection to minimize the unburned carbon content in the flyash. Underfeed stokers were once the primary stoker type used in industrial and utility steam generation, but the high costs of maintenance and these units' slow response to varying loads have made them less competitive in the present market. Spreader stokers, however, are extremely popular in industry today, due in part to their wide fuel capability, discussed further below.<sup>20</sup>



Underfeed stokers are generally of two types: the horizontal-feed, side-ash-discharge type, shown in Figure 3-7; and the gravity-feed, rear-ash-discharge type, shown in Figure 3-8. The horizontal-feed, side-ash-discharge type of stoker is used primarily in small boilers supplying relatively constant steam loads of less than 30,000 lb/hr (~30 MMBtu/hr input).<sup>21</sup> As shown in Figure 3-7, coal is supplied from below the air-admitting surface of the grate into the bottom of a fuel bed, usually via a longitudinal channel called a retort. As additional coal is fed into the boiler with a ram or screw, the coal is forced to the top of the retort, where it spills onto a grate located on either side. Combustion air is supplied through tuyeres at the side grates, where combustion is completed. Overfire air is often supplied to the flame zone above the bed to provide more combustion air and turbulence for more complete combustion.<sup>22</sup> These smaller underfeed stokers typically have one or two retorts. Maximum allowable burning rates are typically 425,000 Btu/hr per square foot of grate area.<sup>21</sup> Allowable burning rates determine the size of the grate area for a given heat input rate. The higher the burning rate the higher the intensity of combustion and thickness of the burning bed. The gravity-feed, rear-ash-discharge underfeed stoker often has multiple retorts. Typically, this type of stoker has a maximum 500 MMBtu/hr (146 MWt) heat input capacity.<sup>21</sup> In this type of stoker, coal is introduced through a coal hopper and is ram-fed to the inclined retorts and grates. The retorts and grates are typically inclined 20 to 25°. Maximum allowable fuel burning rates are 600,000 Btu/ft<sup>2</sup>-hr.<sup>21</sup>

An overfeed stoker, shown in Figure 3-9, uses a moving grate assembly. Coal is fed from a hopper onto a continuous grate that conveys the coal into the furnace. As coal moves through the furnace on the grate, it passes over several air zones for staged burning. The air serves a dual purpose; it is used for combustion as well as for cooling the fuel bed and grate, preventing fusing of the coal. At the far end of the moving grate, combustion is completed and ash discharged to the bottom of the furnace. An adjustable gate at the coal feed point allows regulation of the depth of the fuel bed.<sup>23,24</sup> The three types of grates used with overfeed coal stokers are the chain, travelling, and water-cooled vibrating grates. These overfeed stoker systems are often referred to by the type of grate employed. Overfeed coal-fired systems typically range up to 350 MMBtu/hr (100 MWt) heat input capacity. Maximum fuel burning rates for overfeed stokers are roughly 500,000 Btu/ft<sup>2</sup>-hr.<sup>21</sup>

In a spreader stoker, mechanical or pneumatic feeders distribute coal uniformly over the surface of a moving grate. In a typical spreader stoker boiler, shown in Figure 3-10, primary air is admitted evenly throughout the active grate area, providing some fuel bed cooling, while above

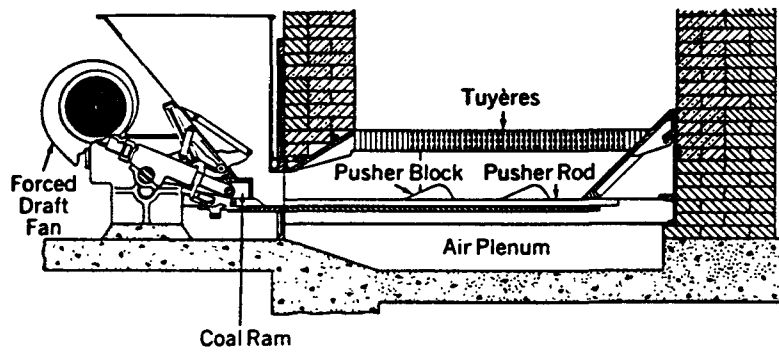

Figure 3-7. Single-retort horizontal-feed underfeed stoker.<sup>21</sup>

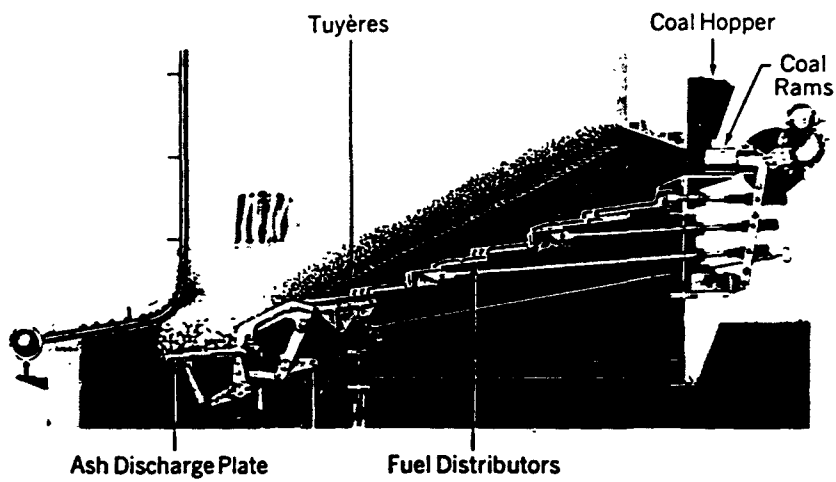

Figure 3-8. Multiple-retort gravity-feed underfeed stoker.<sup>21</sup>

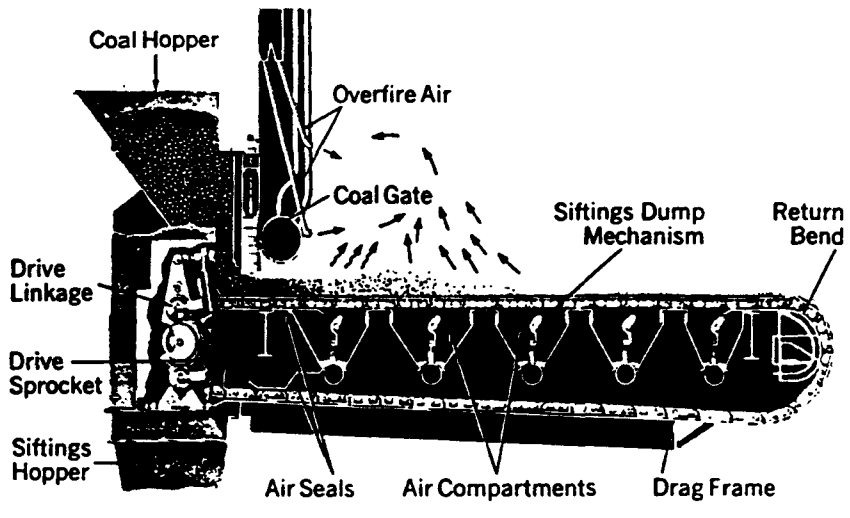

Figure 3-9. Overfeed chain-grate stoker.<sup>21</sup>

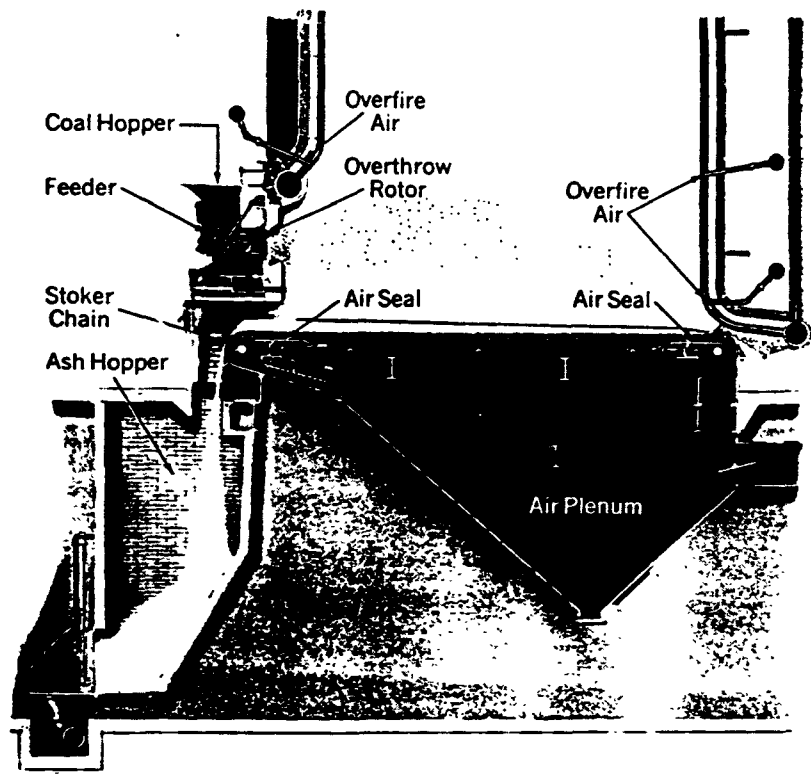

Figure 3-10. Spreader stoker.<sup>21</sup>

the grate an overfire air system provides secondary air and turbulence. The injection of the fuel into the furnace and onto the grate combines suspension burning with a thin, fast-burning fuel bed. The amount of fuel burned in suspension depends primarily on fuel size and composition, among other factors. Generally, the finer the fuel and/or the higher its volatile matter content, the more energy released in suspension; the higher the moisture content, the more energy released on the grate.<sup>24</sup> Many spreader stoker units incorporate a flyash recirculation system, whereby unburned solids in the flyash are collected and recirculated back into the primary combustion chamber. Heat input capacities of spreader stokers typically range from 5 to 550 MMBtu/hr (1.5 to 160 MWt), although there are a few units of 1,500 MMBtu/hr (440 MWt) or more.<sup>18</sup> Maximum fuel burning rates are highest for this stoker design, often reaching a maximum of 750,000 Btu/ft<sup>2</sup>-hr.<sup>21</sup>

In general, stoker coal is fed crushed with a nominal size less than 2 inches. Overfeed and spreader stokers can be used to burn almost any type of coal or solid fuel, including wood, wood waste, and bagasse. Coking bituminous coals, however, are not used in overfeed stokers to avoid matting and restricting the airflow through the grate. Coking has little effect on the performance of spreader stokers.<sup>8</sup> Most packaged stoker units designed for coal firing are less than 100 MMBtu/hr (29 MWt) capacity.<sup>25</sup> Larger units are typically field-erected.

### **3.2.1.2 PC-fired Watertube Boilers**

PC-fired boilers account for a small percentage of the ICI watertube boiler population. In 1977, they accounted for less than 1/10th of 1 percent of all installed ICI boiler units. However, they accounted for approximately 2.5 percent of total ICI boiler capacity.<sup>18</sup> This disparity is due to the fact that PC-fired boilers are almost entirely limited to sizes larger than 100 MMBtu/hr (29.3 MWt) heat input capacity. Below this level, the required coal-handling and pulverizing equipment can increase the capital cost of PC-fired units to as high as 10 times that of an oil- or natural-gas-fired industrial boiler of the same size.<sup>26</sup> Thus, when coal is the fuel of choice, stoker firing dominates in units below about 150 MMBtu/hr (44 MWt) heat input capacity. PC firing and FBC are usually the choices for larger boilers.<sup>27</sup> PC-fired ICI boilers are nearly all of watertube configuration, and the majority are field-erected.<sup>26</sup>

Combustion in PC-fired units takes place almost entirely while the coal is suspended, unlike in stoker units, in which most, if not all, of the coal burns on a grate. Finely ground coal (70 percent through 200 mesh) is typically mixed with primary combustion air and fed to the burner or burners, whereupon it is ignited and mixed with secondary combustion air. Depending

upon the location of the burners and the direction of coal injection into the furnace, PC-fired boilers can be classified into three different firing types

- Single- and opposed-wall, also known as face firing
- Tangential, also known as corner firing
- Cyclone

Of these types, wall and tangential configurations are the most common.<sup>26</sup>

Figure 3-11 shows a schematic of a single-wall-fired boiler. Wall-fired boilers can be either single-wall-fired, with burners on only one wall of the furnace firing horizontally, or opposed-wall-fired, with burners mounted on two opposing walls. However, opposed-wall boilers are usually much larger than 250 MMBtu/hr heat input capacity, and are much more common in utility rather than in industrial applications.<sup>26</sup>

Figure 3-12 shows a plan view of a tangential-firing configuration, with the burners mounted in the corners of the furnace. The fuel and air are injected toward the center of the furnace to create a vortex that enhances air/fuel mixing. Larger flame volumes and flame interaction contribute to characteristically lower NO<sub>x</sub> levels from tangential firing. Tangential boilers, like opposed-wall boilers, are commonly used in utility applications.<sup>26</sup>

Cyclone furnaces are often categorized as PC-fired systems even though the coal burned in cyclones is crushed and not pulverized. These furnaces burn low-fusion-temperature coal crushed to a maximum particle size of about 4.75 mm (95 percent through 1/4 inch mesh).<sup>8</sup> The coal is fed tangentially, with primary air, into a horizontal cylindrical furnace. Smaller coal particles are burned in suspension, while larger particles adhere to a molten layer of slag on the combustion chamber wall. The larger particles remain in the slag until they are burned. Because of their intense furnace heat release rates, cyclones emit high levels of NO<sub>x</sub>, and are generally more difficult to control with combustion modifications. Cyclone furnaces are not as widely used in the industrial sector as wall, tangential, or stoker systems.<sup>8</sup>

PC-fired boilers are also classified as either dry bottom or wet bottom, depending on whether the ash is removed in solid or molten state. This is an important differentiation with respect to NO<sub>x</sub> emissions, as wet-bottom boilers generally operate at higher furnace temperatures and subsequently emit greater amounts of NO<sub>x</sub>. Boiler designs in wet- and dry-bottom furnaces hinge on coal quality and ash fusion properties. Wet-bottom furnaces are also referred to as slag tap furnaces. In the ICI sectors, dry-bottom PC-fired boilers are much more widely used than wet-bottom boilers.<sup>6,8</sup>

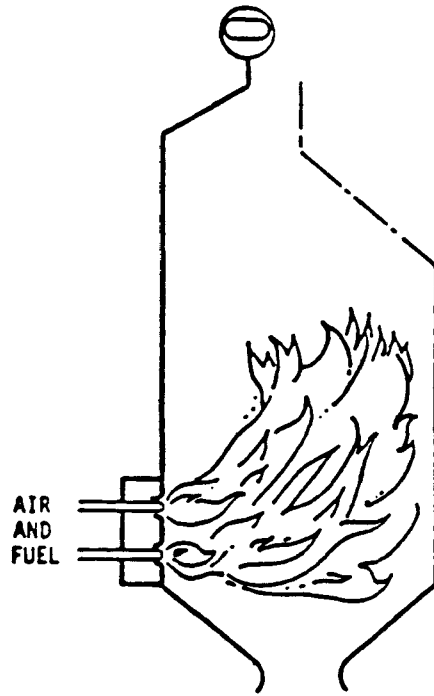

Figure 3-11. Wall firing.<sup>26</sup>

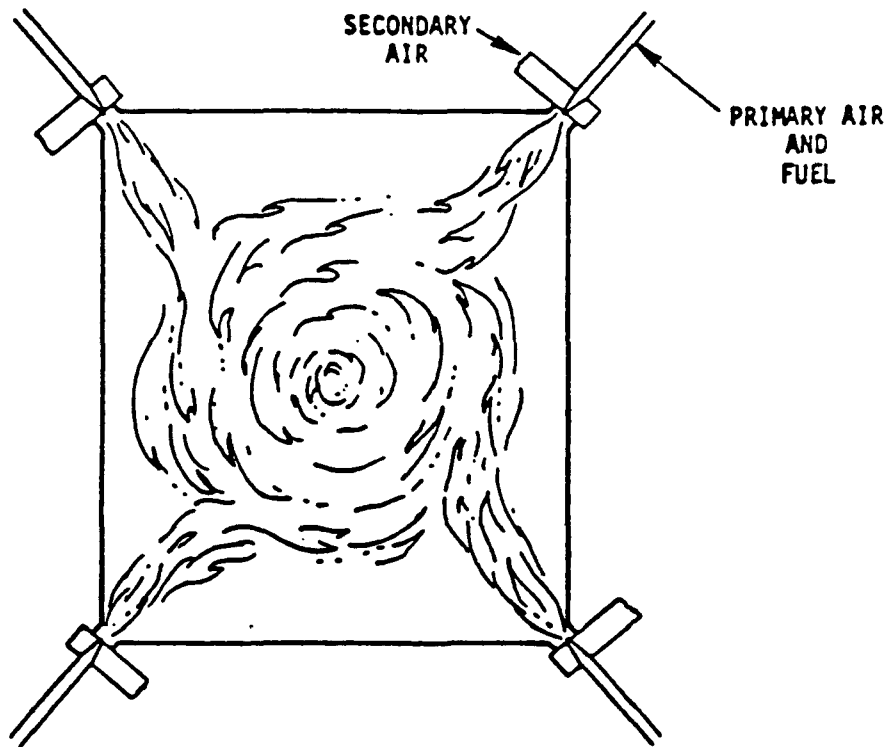

Figure 3-12. Tangential firing.<sup>26</sup>

### 3.2.13 FBC Watertube Boilers

FBC boilers, while not constituting a large percentage of the total ICI boiler population, have nonetheless gained popularity in the last decade, due primarily to their capabilities to burn a wide range of solid fuels and to use combined NO<sub>x</sub>/SO<sub>x</sub> controls within the furnace. FBC units generate steam for ICI facilities, cogenerators, independent power producers, and utilities. In the United States, FBCs in use in the industrial sector account for less than 10 percent of the total installed FBC generating capacity.<sup>28</sup>

There are two major categories of FBC systems: (1) atmospheric, operating at a slight negative draft, and (2) pressurized, operating at from 4 to 30 atmospheres (60 to 450 psig). Pressurized FBC (PFBC) systems are being demonstrated at two utility sites in the United States. No PFBC units are currently in operation in the ICI sector, and it is unlikely that such systems will be used for industrial applications in the near future, due to the developmental status of this technology. A recent market assessment report concluded that PFBCs are several years away from full commercialization in the utility industry, and that near-term opportunities for large industrial applications rest with atmospheric FBC technology.<sup>28</sup> Currently, only atmospheric FBC systems are used in the ICI sector.<sup>29</sup> Therefore, the remainder of this section describes atmospheric FBCs.

In a typical FBC boiler, solid, liquid, or gaseous fuel or fuels, together with a mixture of inert material (e.g., sand, silica, ash) and/or a sorbent such as limestone, are kept suspended by a steady upward flow of primary air through the fuel bed. This fuel bed fluidization promotes turbulence, which improves mixing of fuel and air, allowing the FBC to combust solid fuel at a substantially lower and more uniformly distributed temperature—typically 815 to 870°C (1,500 to 1,600°F) — compared to stoker or PC-fired boilers, where furnace temperatures can peak at 1,590°C (2,900°F).

This lower temperature range provides two of the three main advantages of FBCs over conventional boiler units:

- Lower combustion temperatures result in less formation of thermal NO<sub>x</sub> and allow use of sorbent to reduce SO<sub>2</sub> emissions
- Lower combustion temperatures are generally below the ash fusion temperatures of most fuels, resulting in less slagging and fouling of heat transfer surfaces
- FBCs are able to burn many types of fuels besides coal, including low-grade fuels such as petroleum coke, waste coal, municipal waste, and biomass materials

Flexible-fuel capability is inherent in FBC design, and the ability to efficiently burn low-grade fuels would generally be impractical without FBC technology. High combustion efficiencies are generally due to the long retention times of solids in the fluidized beds.<sup>30</sup>

FBCs are primarily watertube boilers, especially among the larger units, although firetube units are also available. In some FBCs — bubbling bed units, described below — additional watertubes are located within the fuel bed itself, oriented either horizontally or vertically. Steam output is controlled by manipulating the primary bed parameters of height, temperature, fuel input, and fluidization velocity—the velocity of the primary air through the bed.

Firetube FBC boilers are also available and in use. However, of the more than 50 FBC manufacturers worldwide, only 12 offer firetube designs in addition to the more conventional watertube systems.<sup>31</sup> This indicates the relative popularity of watertube FBC systems as compared to the less common firetube units.

Figures 3-13 and 3-14 show the two principal types of atmospheric FBC boilers, the bubbling bed and the circulating bed. The fundamental distinguishing feature between these types is the fluidization velocity. In the bubbling-bed design, the fluidization velocity is relatively slow, ranging between 5 and 12 ft/s, the idea being to minimize solid carryover into the convective passes of the boiler. In some units, relatively slow fluidization velocities allow watertubes to be placed within the bed itself, as long as tube erosion is not a problem. Circulating FBCs, however, employ fluidization velocities as high as 30 ft/s and actually promote the carryover or circulation of solids—fuel and bed material. Solids leaving the primary combustion zone are trapped by high-temperature cyclones and recirculated back to the primary combustion chamber. In some circulating-bed designs, a secondary combustion chamber is used to complete combustion of the fuel. The circulating FBC maintains a continuous, high-volume recycle rate that increases the fuel residence time compared to the bubbling-bed design. Because of this, circulating FBCs often achieve higher combustion efficiencies and better sorbent utilization in the control of SO<sub>2</sub> emissions than bubbling-bed units.<sup>33</sup> This is one reason why the bubbling bed FBC, still favored for small-scale boilers, is not as favored for large-scale industrial and utility applications.<sup>33</sup> Circulating FBCs have their heat exchange tubes downstream of the recirculating cyclone.

Of atmospheric FBCs currently in use in all sectors, including industrial, utility, independent power production, and cogeneration applications, coal is the primary fuel used, followed in descending order by biomass, coal waste, and municipal waste. Coal waste and



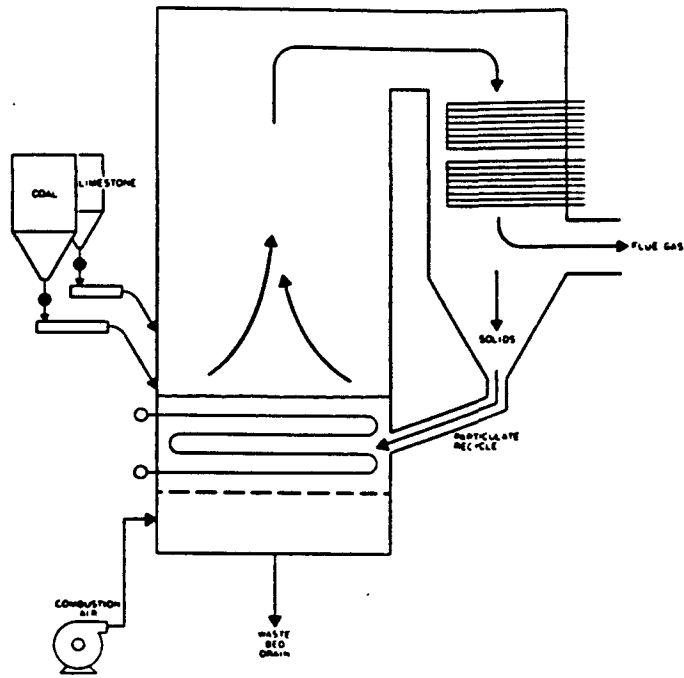

Figure 3-13. Bubbling FBC schematic.<sup>32</sup>

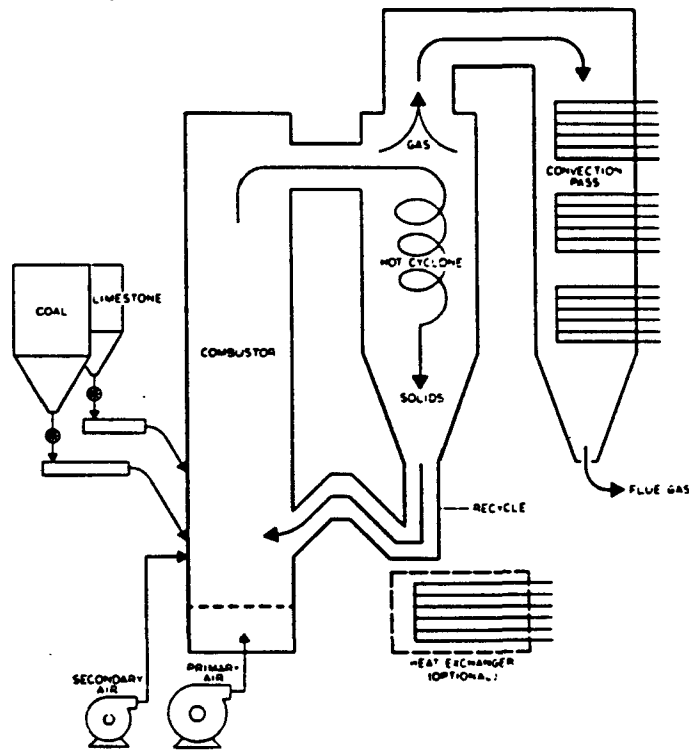

Figure 3-14. Circulating FBC schematic.<sup>32</sup>

municipal waste are not significant fuel types for larger FBC plants.<sup>33</sup> Of 157 non-utility FBC boilers in operation in the United States in 1991, 116 were of heat input capacities below 250 MMBtu/hr (73 MWt or 37 MWe), and of these, 51 burned coal exclusively.<sup>2</sup> Another 18 units burned coal in combination with wood, sludge, coke, or biomass. The coal-burning FBCs ranged between 8.4 and 235 MMBtu/hr heat input capacity (2.5 to 69 MWt, or 1.25 to 35 MWe output), and accounted for a relatively small amount of the total capacity of coal-fired ICI boilers. The largest coal-fired FBC unit in non-utility application in the United States has an approximate heat input capacity of 1,070 MMBtu/hr (315 MWt), generating 160 MWe of electric power at a cogeneration facility.<sup>2</sup>

From an economic standpoint, ICI FBC boilers that burn coal do not compete strongly with gas-fired units. For example, in the 200- to 600-MMBtu/hr (59- to 175-MWt or 30- to 90-MWe) size range, the capital costs of a coal-fired FBC boiler are 2 to 3 times higher than a conventional natural-gas-fired unit. The use of lower cost opportunity fuels, such as coke, biomass, wood waste, and low-grade coals, can provide sufficient economic incentive to offset higher initial capital costs. When used in electric power generating applications, FBC coal-fired power plants produce electricity at 1.5 to 3 times the cost of gas-based power generation.<sup>34</sup> Future growth in the ICI FBC boiler market is expected to occur mainly among units that burn fuels other than coal, such as waste fuels like wood and manure.

### **3.2.2 Coal-fired Firetube Boilers**

Coal-fired firetube boilers represent a small portion of the ICI boiler population. In 1977, coal-fired firetube boilers accounted for only 10 percent of the industrial and commercial firetube boiler population in the United States, and only 1.5 percent of all ICI boilers.<sup>35</sup> The four most common types of firetube boilers used with coal are the horizontal return tubular (HRT), Scotch, vertical, and the firebox; however, the HRT boiler is generally used with gas or oil instead of coal. Virtually all coal-fired firetube boilers are packaged units. The following sections discuss these boiler types as well as other less common firetube boilers.

#### **3.2.2.1 HRT Firetube Boilers**

In a typical HRT boiler, the firetubes are horizontal and self-contained, with the combustion chamber separate. When solid fuel such as coal is used, it is fed through a feed chute onto grates in the primary combustion chamber. The combustion gases then pass through the firetubes of the boiler.

Most coal- and other solid-fuel-fired HRT boilers are two-pass designs. In a two-pass HRT boiler, shown in Figure 3-15, primary and secondary combustion chambers are located beneath the boiler tank. The combustion gases flow over the bridge wall towards the rear of the boiler, heating the outer shell of the tank. At the rear of the boiler, the combustion gases then enter the firetubes. The gases flow through the firetubes, transferring additional heat to the water, and are then exhausted through the boiler stack.

HRT boilers come in various sizes, ranging from 0.5 to 50 MMBtu/hr (0.15 to 15 MWt) heat input capacity, with pressures of 15 to 250 psig. Some larger units are available that supply saturated steam at 300 psig. Firing of coal in HRT boilers is not as common as firing liquid or gaseous fuels, due to the possibility of scaling or slagging.

#### **3.2.2.2 Scotch Firetube Boilers**

A Scotch, or shell, boiler differs from the HRT boiler in that the boiler and furnace are contained in the same shell. In a two-pass unit, combustion occurs in the lower half, with the flue gases passing beneath the bottom of the water basin occupying the upper half. The gases then pass through the firetubes running through the basin. Scotch boilers also come in three- or four-pass configurations. The capacity of Scotch boilers ranges up to 50 MMBtu/hr (15 MWt) heat input, with pressures up to 300 psig, although more typical pressures are approximately 200 psig. Like HRT boilers, coal is not as commonly used in Scotch boilers due to slagging and scaling.<sup>36</sup> More common gas- and oil-fired Scotch units are shown in Figures 3-6 and 3-16.

#### **3.2.2.3 Vertical Firetube Boilers**

Another common firetube design is the vertical boiler. A vertical firetube boiler is a single-pass unit in which the firetubes come straight up from the water-cooled combustion chamber located at the bottom of the unit. Figure 3-17 depicts an exposed-tube vertical boiler in which the firetubes extend from the top of the furnace into the steam space. This causes the steam to be superheated and reduces carryover of moisture.<sup>37</sup>

Figure 3-18 shows a submerged-tube vertical boiler in which the firetubes extend from the furnace to the tube sheet, which is below the water level. This design prevents the ends of the firetubes from overheating. A conical flue gas collector directs the flue gases to an exhaust stack. The submerged-tube boiler has essentially been discontinued, however, because the collector is difficult to build and tends to leak.<sup>37</sup>

Vertical boilers are small, with heat input capacities under 2.5 MMBtu/hr (0.73 MWt). However, they are capable of burning all types of fuels, including coal.

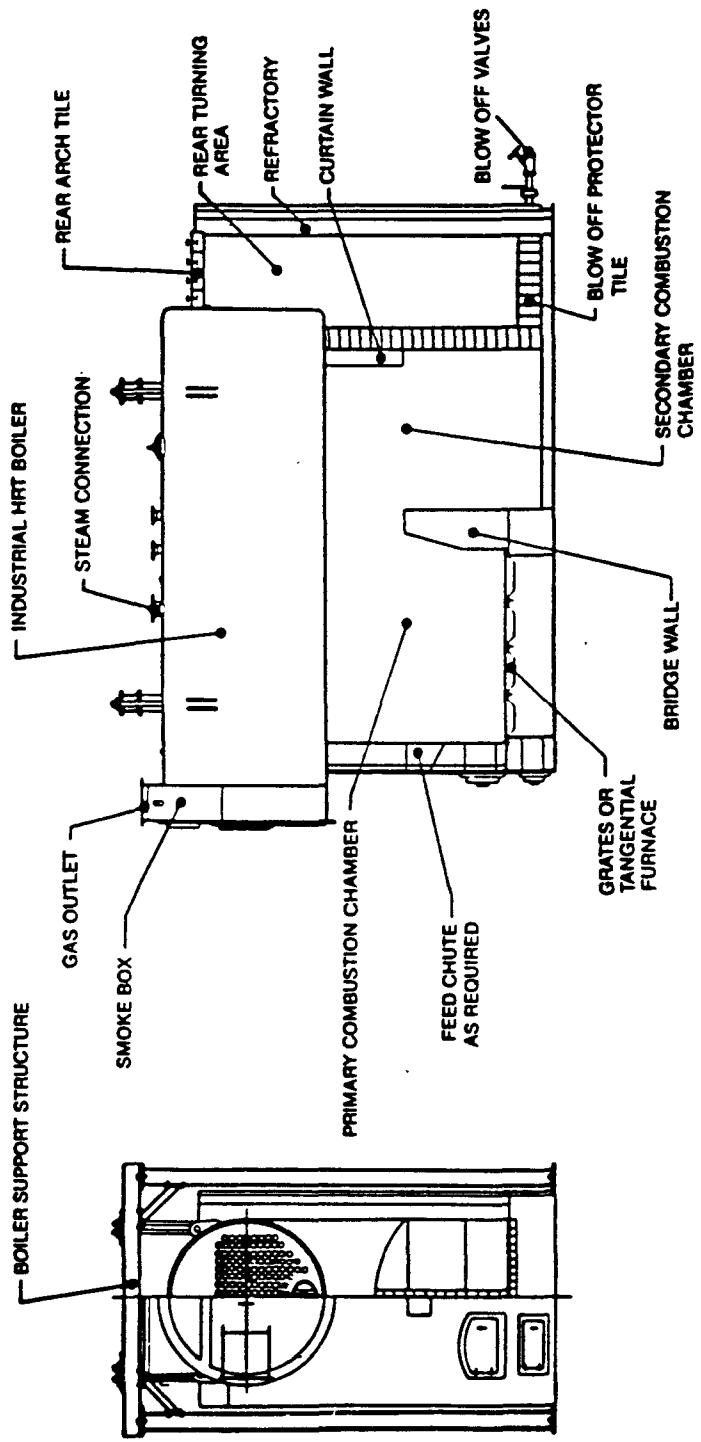
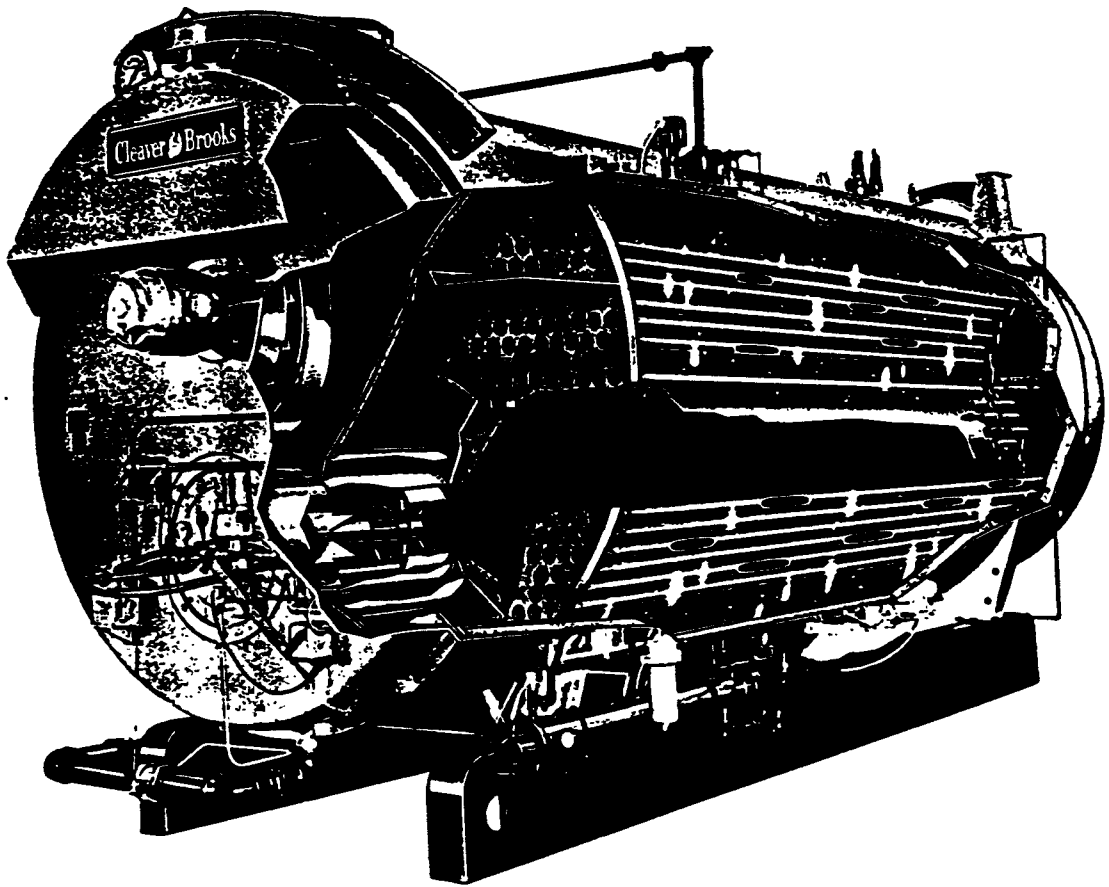

Figure 3-15. Two-pass HRT boiler.<sup>38</sup>



**Figure 3-16. Four-pass gas-/oil-fired scotch boiler.<sup>39</sup>**

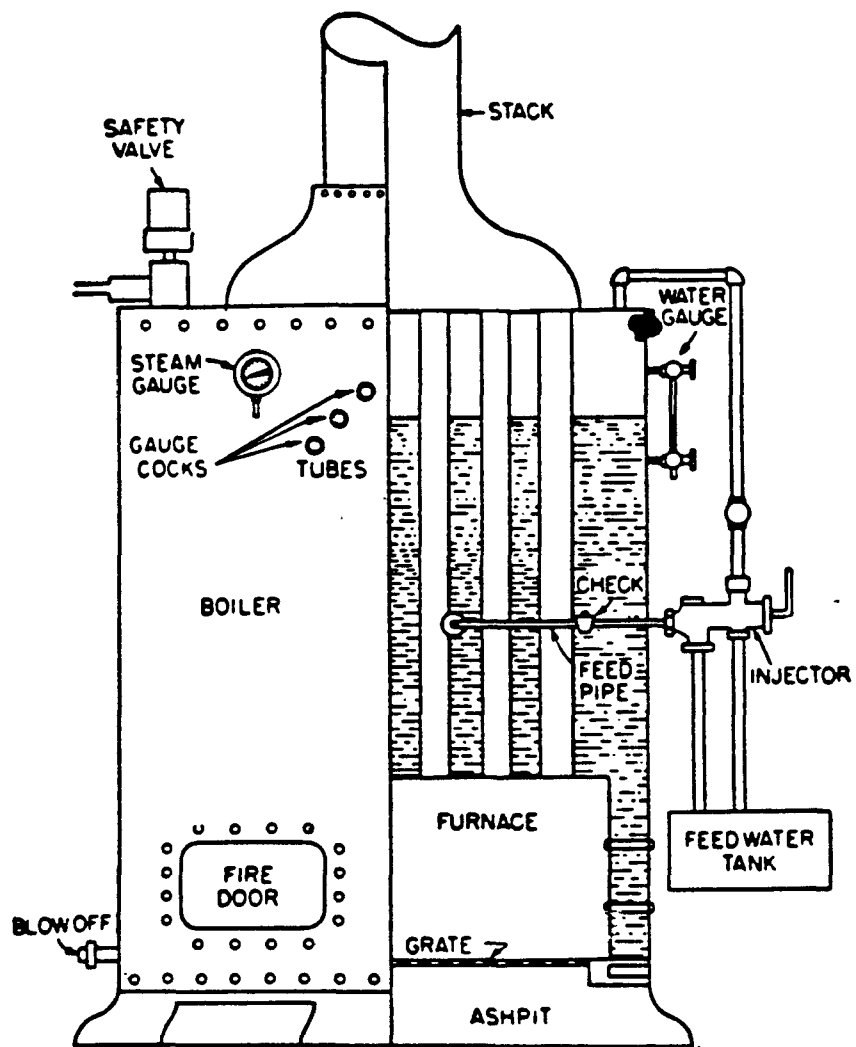

Figure 3-17. Exposed-tube vertical boiler.<sup>37</sup>

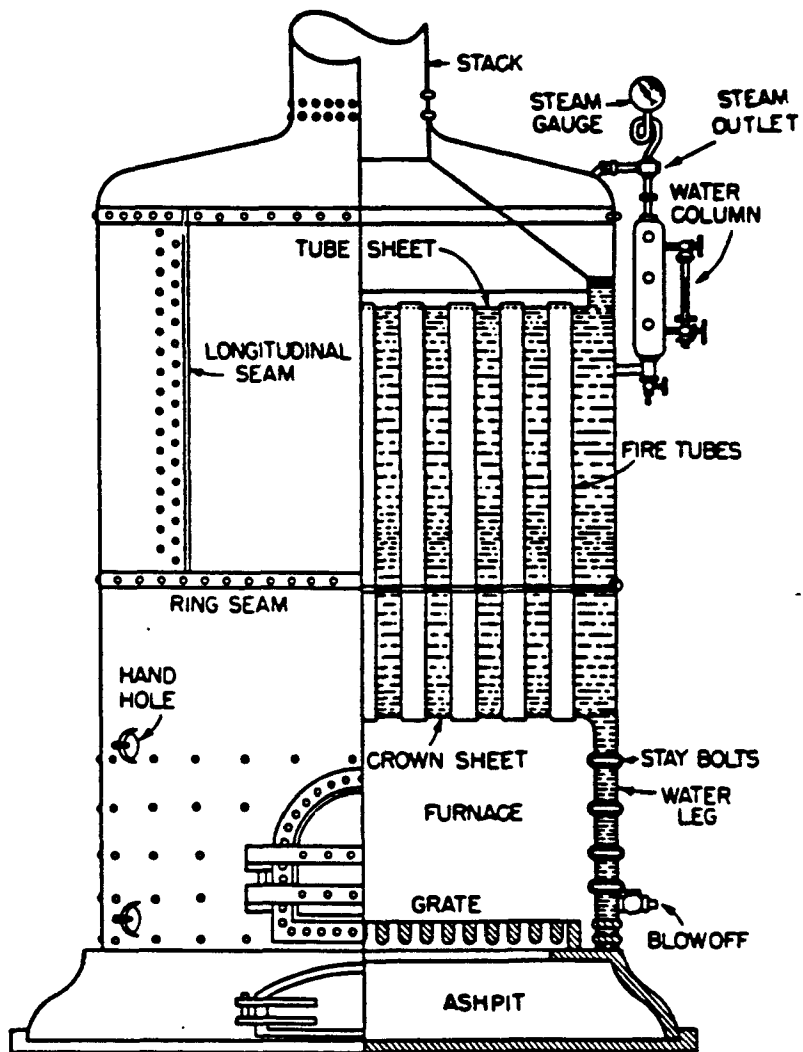

Figure 3-18. Submerged-tube vertical boiler.<sup>37</sup>

### **3.2.2.4 Firebox Firetube Boilers**

Another type of firetube boiler is the firebox boiler. These units are constructed with an internal steel-encased, water-jacketed firebox. Firebox boilers are compact and employ, at most, three passes of combustion gases. Firebox firetube boilers are also referred to as locomotive, short firebox, and compact firebox boilers. A locomotive boiler is a single-pass horizontal firetube boiler; a short firebox boiler is a two-pass horizontal firetube unit; and a compact firebox boiler is a three-pass horizontal unit.<sup>37</sup>

Currently available coal-fired firebox units either employ mechanical underfeed stokers, or are capable of being hand-fired. They are generally limited in size to below 25 MMBtu/hr (7.3 MWt) heat input capacity.<sup>40</sup>

### **3.2.3 Cast Iron Boilers**

Commercial cast iron boilers consist of several vertical sections of heat exchange tubes mounted above a firebox. Water enters each section at the bottom, and is heated or converted to steam as it passes upward through the heat exchange tubes. The capacity of a commercial cast iron boiler is determined by the number of heat exchange sections in the boiler.

In 1977, only 12 percent of the 1.5 million cast iron boilers in the United States were coal fired, and of these, 37 percent had heat input capacities of 0.4 MMBtu/hr (0.1 MWt) or higher.<sup>41</sup> The majority of cast iron boilers are below 0.4 MMBtu/hr (0.1 MWt) heat input capacity and are fueled by natural gas or fuel oil. All cast iron boilers are packaged units, as they are usually no greater than 14 MMBtu/hr (4.1 MWt) in heat input capacity, and, hence, are relatively small.

## **3.3 OIL- AND NATURAL-GAS-FIRED ICI BOILER EQUIPMENT TYPES**

Oil- and natural-gas-fired ICI boilers accounted for 88 percent of the ICI boiler population in 1977.<sup>3</sup> These boilers are generally similar to coal-fired units, with the exception of stoker systems, which are not used to burn liquid or gaseous fuels. However, some boilers are designed with oil/gas burners and a solid fuel stoker system, to allow use of the most economically available fuel. Oil- and natural-gas-fired ICI boilers are similar; in fact, many are capable of firing both fuels either separately or in combination.

In smaller packaged units, single burners are usually employed, while larger field-erected boilers often have multiple burners. In older boilers, multiple-burner arrangements provided a means of controlling heat input in lieu of burner turndown capability. With advances in burner control and turndown capability—most new burners can maintain stable flames as low as



10 percent of capacity—the use of multiple burners in smaller units has declined. Most newer units smaller than 200 MMBtu/hr (59 MWt) heat input capacity have only one burner. Oil- and natural-gas-fired boiler types can be categorized as watertube, firetube, cast iron, or tubeless, and as either packaged or field-erected. Watertube boilers can either be shop-assembled (packaged) or field-erected. Firetube and cast iron boilers are nearly all packaged because of their smaller sizes.

In the smaller sizes and most commercial applications of ICI boilers, the packaged gas/oil fired Scotch firetube boiler predominates.<sup>42</sup> Almost all of these applications are for heating where loads do not fluctuate quickly. Boilers designed for low temperature (250°F or less) and low pressure (15 psig and less) steam are the most widely used in residential, apartment, and commercial construction.<sup>42</sup>

### **3.3.1 Oil- and Natural-gas-fired Watertube Boilers**

Oil- and natural-gas-fired watertube boilers come in a wide range of capacities, from small commercial units of 0.4 MMBtu/hr (0.1 MWt) heat input capacity, to very large industrial boilers of 1,500 MMBtu/hr (440 MWt) or heat input capacity or higher. However, in the ICI sector, most are smaller than 250 MMBtu/hr (73 MWt). Larger oil- and natural-gas-fired watertube boilers that are field-erected are similar to PC-fired units in firing configuration, but with smaller furnace volumes (higher heat release rate per unit volume or waterwall surface area). Units with heat input capacities greater than 150 MMBtu/hr (44 MWt) are typically wall-fired or tangential-fired with multiple burners. Field-erected watertube boilers strictly designed for oil firing are more compact than coal-fired boilers with the same heat input, because of the more rapid combustion characteristics of fuel oil. Field-erected watertube boilers fired by natural gas are even more compact due to the rapid combustion rate of the gaseous fuel, the low flame luminosity, and the ash-free content of natural gas.<sup>43</sup>

In general, field-erected watertube boilers are much more common than packaged units in the boiler size category above 100 MMBtu/hr (29 MWt) heat input capacity, whereas below this capacity, watertube boilers are usually packaged. There are, however, packaged watertube units as large as 250 MMBtu/hr (73 MWt) heat input capacity.

The major type of watertube design used in packaged oil/natural-gas-fired ICI boilers is the horizontal bent tube, classified by the number of drums, headers, and tube configuration, with the latter being the most distinguishing factor. Figure 3-19 shows the three most common tube configurations used in packaged units. The "A" type has two small lower drums, or headers,

A-type has two small lower drums or headers. Upper drum is larger to permit separation of water and steam. Most steam production occurs in center furnace-wall tubes entering drum.

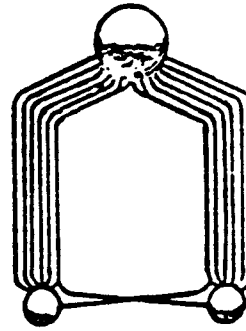

D-type allows much flexibility. Here the more active steaming risers enter drum near water line. Burners may be located in end walls or between tubes in buckle of the D, right angles to drum.

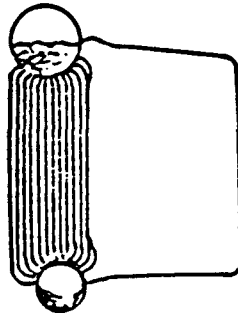

O-type is also a compact steamer. Transportation limits height of furnace, so, for equal capacity, longer boiler is often required. Floors of D and O types are generally tile-covered.

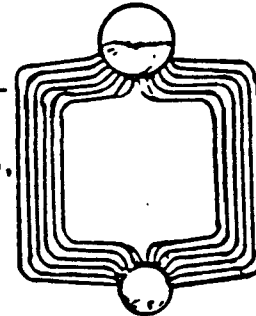

Figure 3-19. Watertube design configurations.<sup>44</sup>

and a large upper drum for steam and water separation. Most steam production occurs in the center furnace wall tubes entering the drum. The "D" type, the most flexible design and the most widespread, has two drums and a large-volume combustion chamber that is easy to outfit with a superheater or economizer. The "O" configuration's symmetry exposes the least amount of tube surface to radiant heat.<sup>11</sup> Figure 3-20 depicts a typical D-type packaged boiler, and its watertubes, equipped with a single oil/natural gas burner at the end.

### 3.3.2 Oil- and Natural-gas-fired Firetube Boilers

The most common types of firetube boilers used for oil and natural gas firing are the Scotch, the HRT, the vertical, and the firebox boilers. Available units range from 0.4 MMBtu/hr (0.1 MWt) to 50 MMBtu/hr (15 MWt) heat input capacity, although most in use in the ICI sector have capacities below 25 MMBtu/hr (7.3 MWt).<sup>35</sup> These firetube boilers almost always employ a single burner rather than multiple burners, and nearly all are packaged units.

Of these four types of firetube designs, the Scotch firetube boiler is the most common. In a four-pass Scotch boiler, such as that shown in Figure 3-16, the burner is located at the end of the unit. Combustion gases pass first through the furnace tube, which is an extension of the

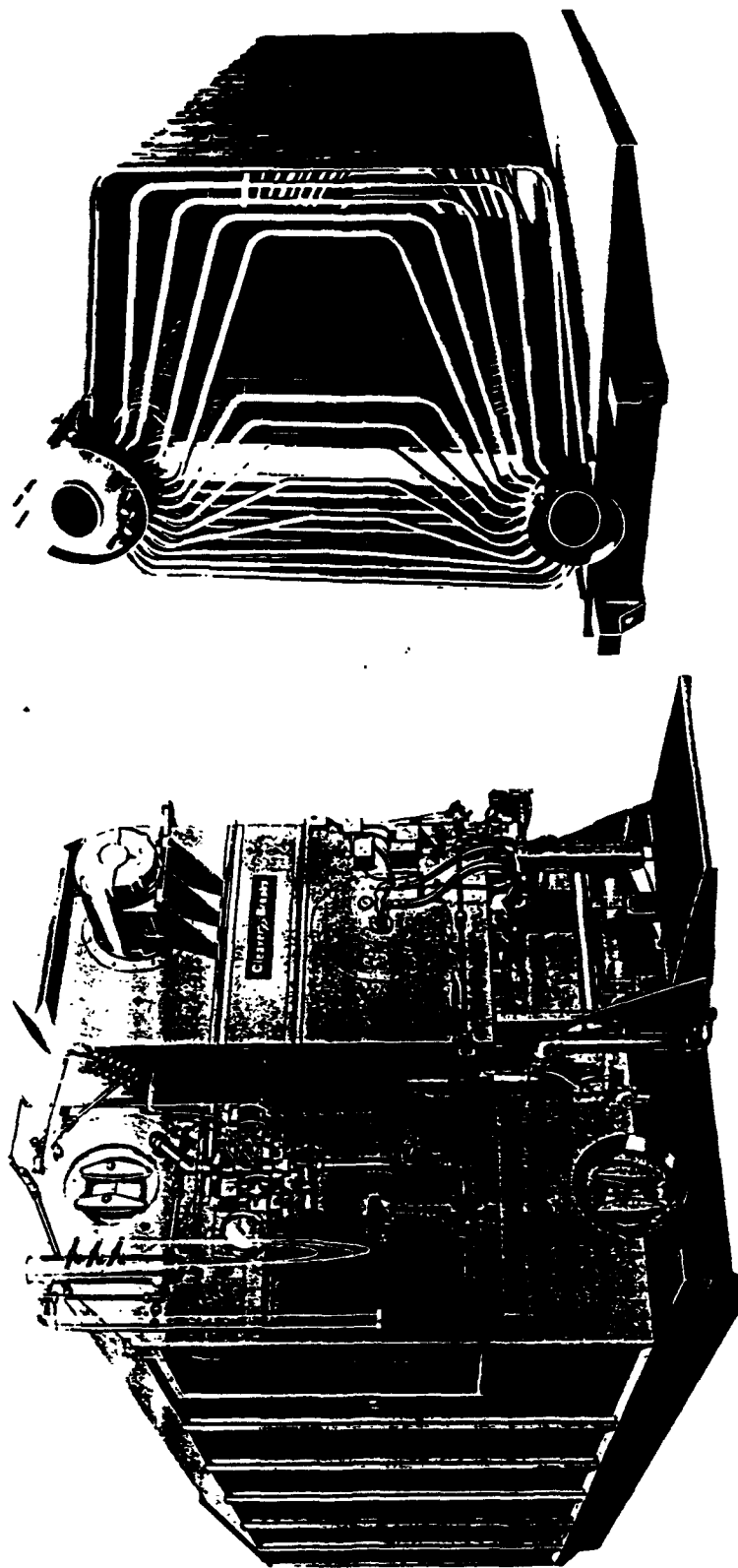

Figure 3-20. D-type packaged boiler and watertubes. 45

combustion chamber, to the end of the boiler, and then enter firetubes at the bottom of the unit. The flue gases then flow back toward the front of the unit, and then enter two more systems of firetubes located above the combustion chamber, before finally exhausting through the stack. A two-pass Scotch boiler is shown in Figure 3-6; this type of unit ranges from 1 MMBtu/hr to 30 MMBtu/hr (0.3 to 9 MWt) heat input capacity.

Oil- and natural-gas-fired HRT, vertical, and firetube boilers are similar in designs and capacities to the coal-fired units discussed earlier. They are essentially the same as the coal-fired firetube units, but differ in that burners rather than stoker systems are used.

### **3.3.3 Oil- and Natural-gas-fired Cast Iron Boilers**

Although approximately 70 percent of ICI boilers are oil- or natural-gas-fired cast iron units, these systems comprise only about 10 percent of the total United States ICI boiler capacity. Two-thirds of these boilers are rated below 0.4 MMBtu/hr (0.1 MWt) heat input capacity. Most of them are used in the commercial and institutional sectors to provide low-pressure steam or hot water. Cast iron boilers using oil or natural gas are similar in design to those described in Section 3.2.3.

### **3.3.4 Other Oil- and Natural-gas-fired Boilers**

Another oil- and natural-gas-fired boiler currently in use is the three-pass vertical tubeless boiler, shown in Figure 3-21. This boiler consists of a vertical, rigid steel pressure vessel enclosed inside another pressure vessel, with water in between. This assembly is itself enclosed within an insulated outer shell. The burner is mounted horizontally at the bottom of the boiler assembly, firing into the inner pressure vessel, which serves as a large primary radiant furnace. Flue gases pass up through the inner vessel, and then make second and third passes over convection fins mounted on the outside of the outer pressure vessel. Heat is transferred to the water located between the two pressure vessels. This type of boiler is packaged and is available in heat input capacities ranging from 0.25 to 4.2 MMBtu/hr (0.07 to 1.23 MWt). The largest units are roughly 6 feet in diameter and 9 feet in height.<sup>46</sup>

Boilers used in thermally enhanced oil recovery (TEOR) operations are referred to as TEOR steam generators. These units are typically packaged watertube boilers with heat input capacities from about 20 to 62.5 MMBtu/hr (5.9 to 18.3 MWt). Steam generators are typically cylindrical in shape and horizontally oriented, with watertubes arranged in a coil-like design. For a given size, there is little variability in the design or configuration of oil field steam generators.<sup>47</sup> Figure 3-22 shows a typical oil field steam generator.

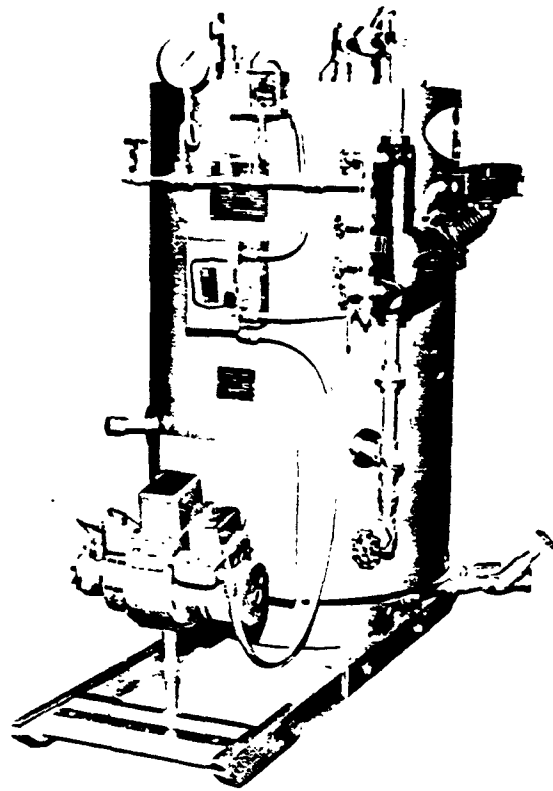

**Figure 3-21. Vertical tubeless boiler.<sup>46</sup>**

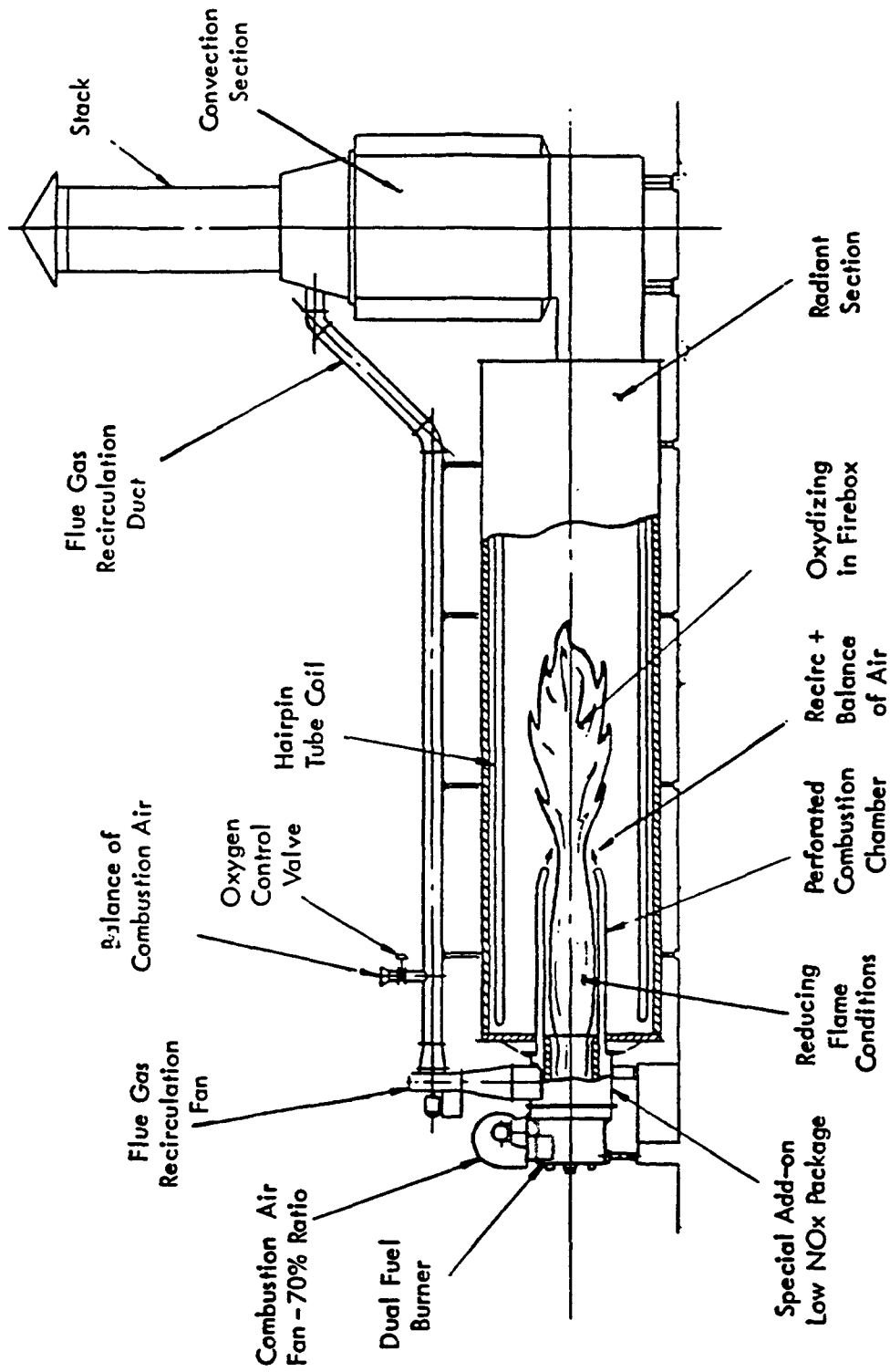

Figure 3-22. TEOR steam generator.<sup>49</sup>

FBC boilers rely on coal, biomass, wood, and other solid fuels. Natural gas or oil is used primarily as either a startup fuel to preheat the fluidized bed, or as an auxiliary fuel when additional heat is required.<sup>31,48</sup>

### **3.3.5 Oil Burning Equipment**

Natural-gas- and oil-fired boilers often use similar combustion equipment, and in fact, many units are capable of firing either fuel. The use of fuel oil, however, generally requires special equipment to "atomize" the fuel before combustion. In some installations, this atomization equipment may play a key role in the combustion performance of the boiler unit. To burn fuel oil at the high rates required in most ICI boiler applications, it is necessary that the oil be atomized or dispersed into the furnace as a fine mist. This exposes a larger amount of oil particle surface for contact with the combustion air, assuring prompt ignition and rapid combustion.<sup>50</sup> The most common types of atomizers are steam and mechanical atomizers.

Steam atomizers, which may also be used with moisture-free compressed air, are the most widely used.<sup>50</sup> These types of atomizers produce a steam-fuel emulsion which, when released into a furnace, atomizes the oil through rapid expansion of the steam. Steam atomizers are available in sizes up to 300 MMBtu/hr (88 MWt) input. The steam and oil pressure required are dependent on the design of the steam atomizer, although maximum oil pressures can be as high as 300 psi and maximum steam pressures as much as 150 psi.<sup>50</sup> Oil pressures are much lower than for mechanical atomizers. The steam atomizer performs more efficiently over a wider load range than do mechanical atomizers.

In mechanical atomizers the pressure of the fuel oil itself is used as the means for atomization. The oil pressure required at the atomizer for maximum capacity typically ranges from 600 to 1,000 psi, depending on capacity, load range, and fuel grade.<sup>50</sup> Mechanical atomizers are available in sizes up to 180 MMBtu/hr (53 MWt) input.

The viscosity of the oil is the most important property affecting atomization in mechanical atomizers.<sup>51</sup> As viscosity increases, larger viscous forces must be overcome by the energy supplied to the nozzle. This detracts from the energy available for droplet breakup, resulting in coarser atomization and possible adverse effects on combustion efficiency.<sup>51</sup> Thus, for proper atomization and combustion, oil of grades higher than No. 2 must usually be heated to reduce its viscosity to 135 to 150 Saybolt Universal Seconds.<sup>50</sup> Figure 3-23 shows the effect of temperature on viscosity for No. 2 (distillate) through No. 6 (residual) fuel oils.

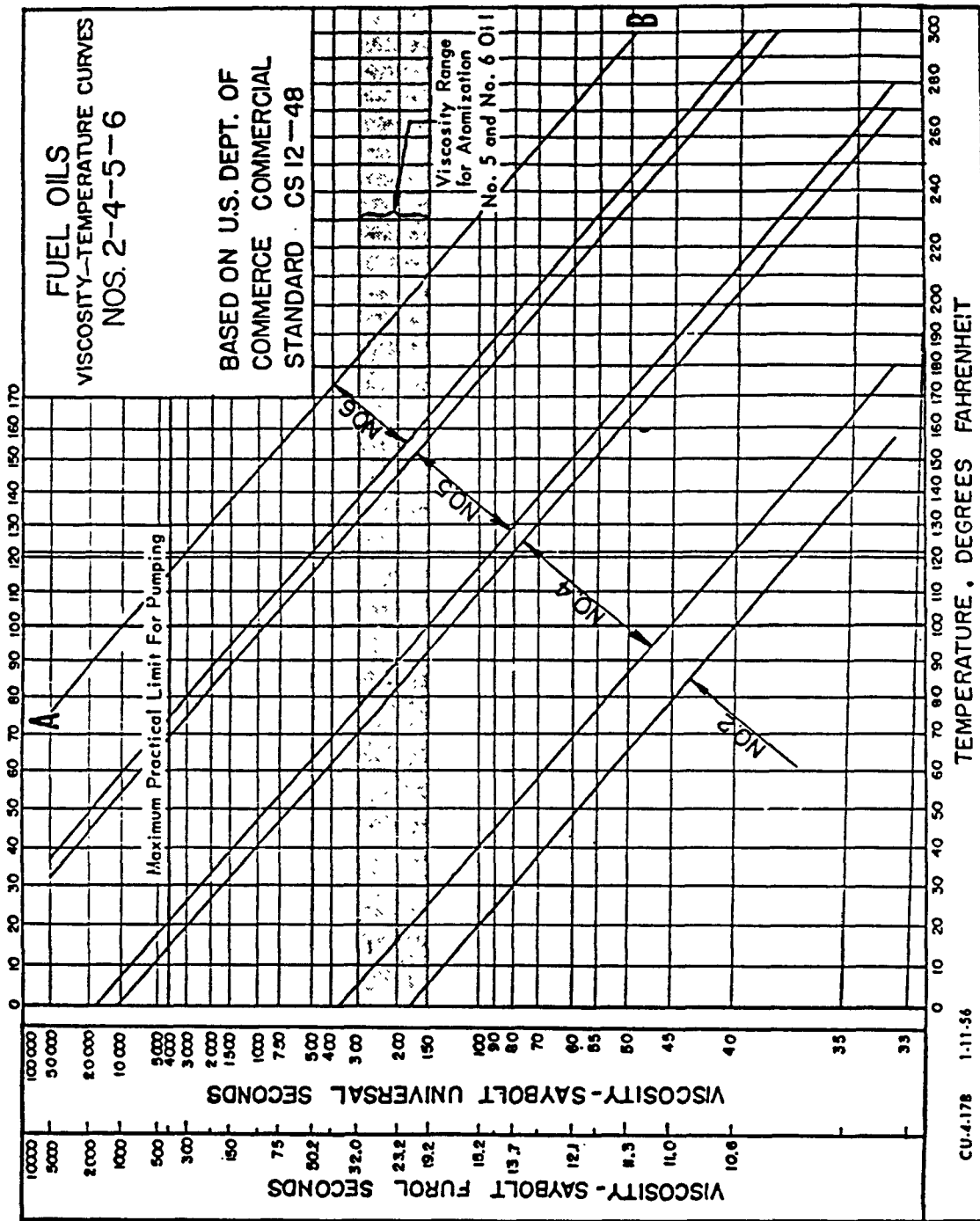

Figure 3-23. Effect of temperature on fuel oil viscosity. 51



### **3.4 NONFOSSIL-FUEL-FIRED ICI BOILER EQUIPMENT TYPES**

Nonfossil-fuel-fired boilers are commonly used in industries that generate combustible wastes from their industrial processes. In general, nonfossil-fuel-fired boilers include any boiler used in the production of steam or hot water from biomass, including wood wastes and bagasse, and general solid waste, including MSW, industrial solid waste (ISW), and RDF. The following subsections briefly describe the types of fuels burned and the most common types of nonfossil-fuel-fired boilers currently in use.

#### **3.4.1 Wood-fired Boilers**

Wood wastes are typically burned in boilers used in the paper and allied products industry, the forest products industry, and the furniture industry. Types of wood wastes are sawdust, sanderdust, wood chips, slats, and bark. Other sources of wood for fuel include discarded packing crates, wood pallets, and wood waste from construction or demolition activities.<sup>52</sup> Wood is often cofired with an auxiliary fossil fuel in larger boilers.

Stokers are the most common type of wood-firing systems in the United States. There are three types of wood-fired stokers: spreader, overfeed, and underfeed. In design, they are similar to the coal-fired stokers described earlier, and range from 1.5 MMBtu/hr (0.44 MWt) to greater than 1,430 MMBtu/hr (420 MWt) heat input capacity. Of larger wood-fired units of 150 MMBtu/hr (44 MWt) heat input capacity or greater, spreader stokers are the most widespread.<sup>53</sup> As in the coal-fired spreader stoker described earlier, fuel enters the furnace through a chute and is spread pneumatically or mechanically across the furnace, where part of the wood burns in suspension. The remainder of the fuel lands on a stationary or moving grate, where it is burned in a thin, even bed. A portion of the combustion air is injected under the grate to drive off the volatiles and burn the char, while the remainder is fed above the grate to complete combustion. Most stoker units are equipped with a flyash reinjection system.

Other methods used to fire wood are overfeed and underfeed stoker firing, gasification, pyrolysis, fuel cell firing, suspension firing, and FBC, though to a lesser degree than spreader stoker firing. Another type of boiler combustion system, the Dutch oven, is also in use, but has been essentially discontinued from new construction due to its low efficiency, high construction costs, and inability to follow load swings.<sup>53</sup> The overfeed stoker is the second most common method of wood firing after the spreader stoker.

Gasification is a method of firing wood waste or other biomass whereby the fuel is partially combusted to generate a combustible fuel gas rich in carbon monoxide and hydrogen,

which is then burned. Heat to sustain the process is derived from exothermic chemical reactions, while the combustible components of the resulting gas are generated by endothermic reactions.<sup>54</sup> In essence, a gasification system behaves as a type of biomass burner. One manufacturer offers flyash gasification systems ranging from 4.2 to 33.5 MMBtu/hr (1.2 to 9.8 MWt) heat input capacity.

In pyrolysis, an organic fuel is introduced into a high-temperature environment with little oxygen. Thermal cracking of the fuel occurs, producing combustible gases that are then burned. One system uses a moving variable-speed grate to introduce the waste fuel to the pyrolytic gasification chamber, where the fuel is thermally cracked between 1,500°F and 1,850°F. The resulting combustible gases are then fired in an afterburner and the flue gases directed to the boiler passes. This system is available in heat input capacities from 14 to 57 MMBtu/hr (4.1 to 16.7 MWt).

In a fuel cell boiler, wood is piled on a stationary grate in a refractory-lined cell. Forced draft air is supplied to drive off the volatiles in the wood and burn the carbon. The volatiles are mixed with secondary and tertiary combustion air and pass into a second chamber where combustion is completed.<sup>53</sup> Fuel cell boilers range in heat input capacity from 3 MMBtu/hr (0.9 MWt) to 60 MMBtu/hr (17.6 MWt).

In suspension firing boilers, small-sized wood fuel, such as sanderdust, is typically blown into the furnace and combusted in mid-air. The small-sized fuels required by these boilers are typically cleaner and drier than other wood wastes, which can result in increased combustion efficiency and less ash entering the furnace. However, most of the ash that does enter the furnace is usually entrained in the flue gas. Most newer boilers utilize a flyash reinjection system to minimize the amount of unburned carbon in the flyash.

Wood is also fired in FBC boilers, which are detailed in Section 3.2.1.3. In 1991, 10 nonutility FBC boilers below 250 MMBtu/hr (73 MWt) heat input capacity and exclusively firing wood wastes were in use in the United States.<sup>2</sup> These ranged from a 40-MMBtu/hr (12-MWt or 6-MWe) boiler, at a timber company's cogeneration plant, to a 180-MMBtu/hr (53-MWt or 27-MWe) unit, used by an independent power producer. In an additional 29 units below 250 MMBtu/hr (73 MWt) heat input capacity, wood was fired in combination with other fuels, such as coal, oil, plastic, and other agricultural wastes. The largest single wood-fired FBC boiler had an electrical generating capacity of 220 MWe, roughly equivalent to 1,500 MMBtu/hr (440 MWt) heat input capacity. This unit was operated by an independent power producer, and

is atypical in size. The next largest wood-fired FBC in the ICI sector was 345 MMBtu/hr (100 MWt or 51 MWe) heat input capacity. This is more typical of the ICI wood-fired FBC boiler range.<sup>2</sup>

It is fairly common practice to use an auxiliary fuel, particularly fossil fuel, in all types of wood-fired boilers. Approximately 50 percent of wood-fired boilers have some type of fossil fuel firing capability.<sup>53</sup> Fossil fuels are fired during startup operation, as an augmentation fuel, or alone when wood fuel is unavailable. Fossil fuels are used more frequently in larger wood-fired boilers than in smaller boilers below 100 MMBtu/hr (29 MWt) heat input capacity.

Wood-fired boilers are available in both firetube and watertube designs, and are packaged or field-erected. Typical firetube boilers used in wood firing are the HRT and the firebox. Wood-fired HRT boilers are usually no larger than 40 MMBtu/hr (12 MWt) heat input capacity, although some as large as 50 MMBtu/hr (15 MWt) have been built. Wood-fired firebox units generally range between 2 and 20 MMBtu/hr (0.6 to 6 MWt) heat input capacity. The firing methods discussed above are used with both firetube and watertube boilers.

Packaged watertube boilers are the most difficult of all boilers to fire with wood waste. This is because the furnaces of these boilers are relatively cold, with water walls on all sides, and because the furnaces are very narrow due to shipping requirements. Because of this cold environment, it is essential that the dry wood particles be small enough to burn out completely during the time it takes the particles to pass through the furnace. For most packaged watertube units, the particles should be no larger than 1/64 to 1/32 of an inch, depending upon the heat release rate.<sup>55</sup>

### **3.4.2 Bagasse-fired Boilers**

Bagasse, an agricultural waste, is the fibrous residue left after processing sugar cane. It is used in sugar industry boilers in Hawaii, Florida, Louisiana, Texas, and Puerto Rico.<sup>52</sup> This fuel is available on a seasonal basis. Other agricultural wastes include nut hulls, rice hulls, corn cobs, olive pits, and sunflower seed hulls.

The earliest type of bagasse-burning furnace was the Dutch oven with flat grates. In this type of furnace, the bagasse was burned in a pile on a refractory hearth and combustion air admitted to the pile around its circumference through tuyeres. However, this type of furnace resulted in high maintenance costs and was essentially discontinued from new installation. A more commonly used pile burning boiler is the fuel cell, described earlier. In one type of fuel cell boiler system, the Ward furnace, shown in Figure 3-24, bagasse is gravity-fed through chutes

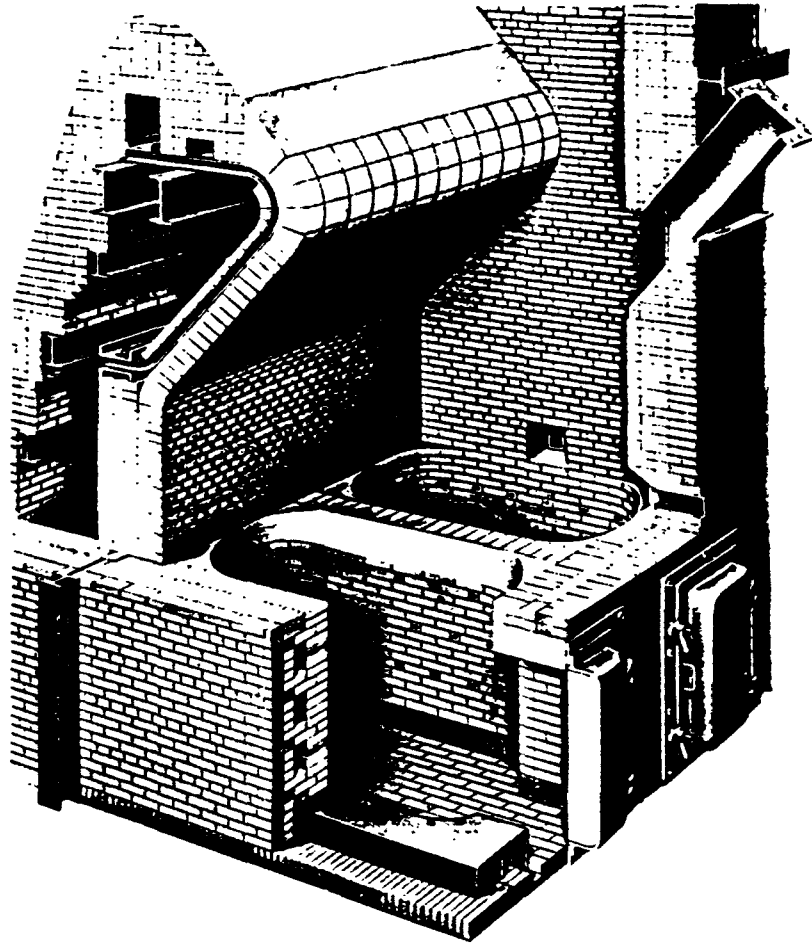

**Figure 3-24. Ward fuel cell furnace.<sup>56</sup>**

into individual cells, where it is burned from the surface of the pile with air injected into the sides of the pile. Additional heat is radiated to the pile from hot refractory, and combustion is completed in a secondary furnace. This type of design is considered one of the most reliable, flexible, and simple methods of burning bagasse.<sup>56</sup>

Recent trends in bagasse firing have been toward using spreader stoker systems. Bagasse spreader stoker boilers are similar in design to wood-fired spreader stokers, except that flyash reinjection is not normally used.<sup>57</sup> Spreader stokers require bagasse with a high percentage of fines and a moisture content not over 50 percent.<sup>56</sup>

Like most other waste-fueled boilers, bagasse-fired units typically use auxiliary fuels such as natural gas or fuel oil during startup or when additional capacity is required. Most operators minimize the amount of auxiliary fuel used, and typically less than 15 percent of the total annual

fuel heat input to bagasse boilers comes from fossil fuels.<sup>57</sup> Bagasse-fired boilers range from 13 to 800 MMBtu/hr (3.8 to 230 MWt) heat input capacity.

### **3.4.3 Municipal Solid Waste (MSW)-fired Boilers**

General solid waste consists of refuse and garbage from municipalities and industries. Boilers that fire general solid waste are found in manufacturing plants, district heating plants, municipal heating plants, and electric utilities. As mentioned earlier, general solid waste can be further classified as MSW, ISW, or as RDF.

MSW is made up of food wastes, rubbish, demolition and construction wastes, treatment plant wastes, and other special wastes. Combustible rubbish consists of material such as paper, cardboard, plastics, textiles, rubber, leather, wood, furniture, and garden trimmings. Treatment plant waste consists of sludge from water, wastewater, and industrial wastewater treatment facilities. Special wastes are roadside litter, dead animals, and abandoned vehicles. The exact makeup of MSW varies both seasonally and geographically. For example, more organic material is usually contained in MSW during the fall, especially in areas such as the northeast where many trees are deciduous. Typically, over one third of MSW in the United States is paper, with the next most abundant constituents being food wastes and garden trimmings.<sup>58</sup>

MSW-fired boilers can be categorized by heat input capacity as either small modular units or large mass-burning facilities. Small modular MSW-fired boilers range from 4.5 MMBtu/hr (1.3 MWt) to 38 MMBtu/hr (11 MWt) heat input capacity, while mass-burning units are as large as 290 MMBtu/hr (85 MWt).<sup>59</sup> Modular units have been in operation in the United States since the late 1960s, while most existing mass-burning facilities have been constructed since 1970.

A typical large mass-burning facility rated at 150 MMBtu/hr (44 MWt) heat input capacity and MSW throughput of 15 tons per hour is shown in Figure 3-25. The facility includes a waterwall furnace and an overfeed stoker system. MSW is loaded by overhead crane into the feed chute, which deposits the waste onto the first grate, known as the "dry-out" grate. Ignition starts at the bottom of the dry-out grate and is continued on a second "combustion" grate. A third grate, the "burn-out" grate, provides final combustion of the waste before dumping the ash into the ash pit. Typical thermal efficiencies for this size of mass-burning boiler range between 60 and 70 percent.<sup>60,61</sup> Other variations of mass burn systems besides the waterwall furnace type are controlled air (pyrolysis) and refractory furnaces. Controlled-air MSW units

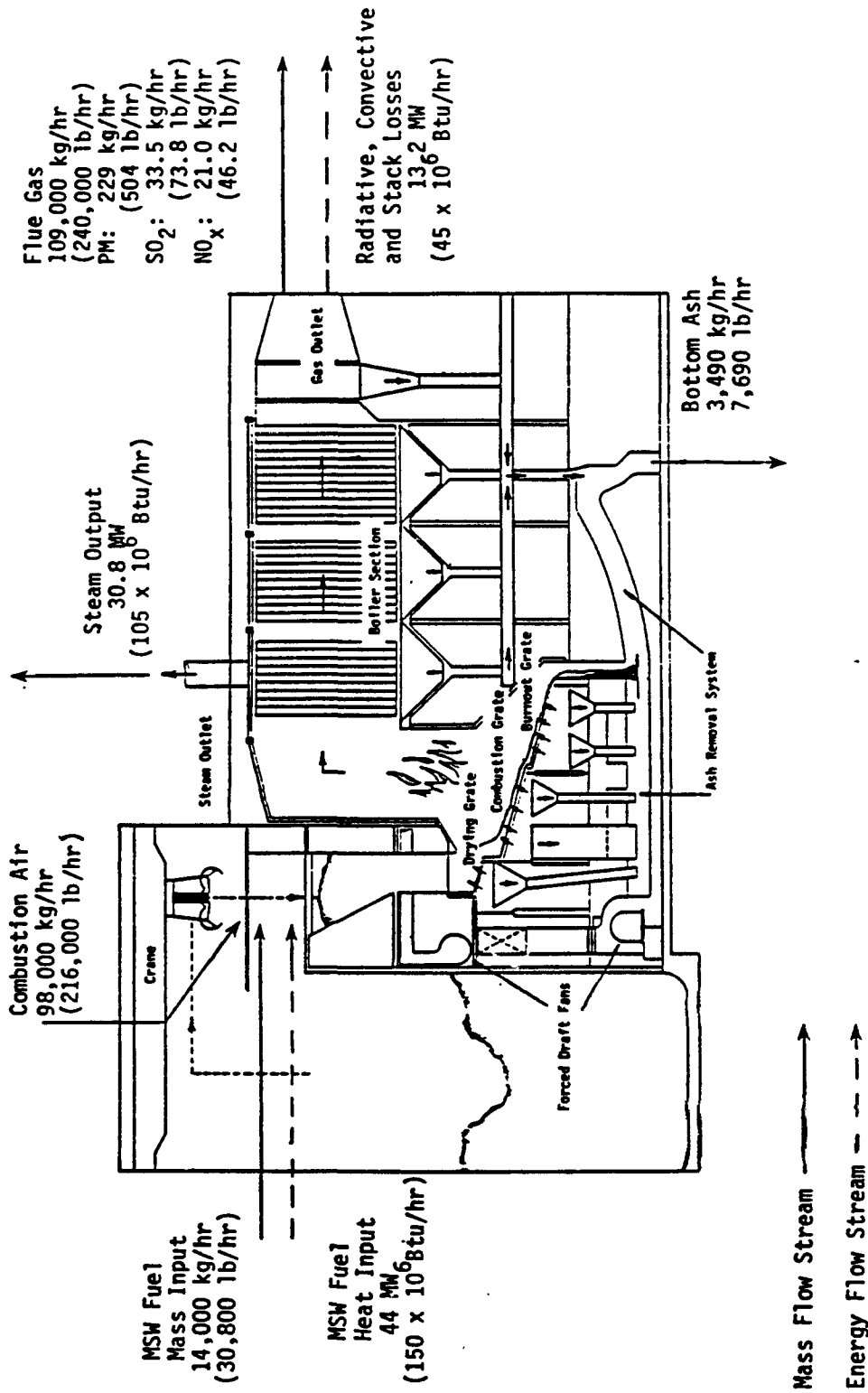

Figure 3-25. Large MSW-fired boiler.<sup>60</sup>

received much developmental attention during the 1970s. Many of these units, however, were subsequently shut down due to operational or economic problems.<sup>62</sup>

Small modular units differ from the mass-burning boilers in that they are typically hopper- and ram-fed instead of crane-fed. These units are packaged and designed to allow installation of additional units as the need for further capacity increases. A typical modular boiler, shown in Figure 3-26, utilizes a furnace with a primary and secondary combustion chamber. MSW is fired at approximately 820°C (1,500°F) in the primary chamber and at 1,040°C (1,900°F) in the secondary chamber. An auxiliary burner is used in the secondary chamber whenever additional heat is required. This particular type of unit is an example of a controlled-air or "starved-air" boiler, as the air in the primary combustion chamber is below stoichiometric levels to reduce ash and fuel entrainment.<sup>63</sup>

#### **3.4.4 Industrial Solid Waste (ISW)-fired Boilers**

ISW is composed of those wastes, typically paper, cardboard, plastic, rubber, textiles, wood, agricultural waste, and trash, arising from industrial processes. The composition of ISW fuel at any one site is usually relatively constant because the industrial activities that generate the waste are usually well regulated. The average heating value of ISW is higher than MSW, about 17,000 kJ/kg (7,100 Btu/lb) compared to 11,000 kJ/kg (4,875 Btu/lb) as fired, and the ash content is less.<sup>64</sup>

ISW is fired in the same type of boiler systems as the modular units described above. These units encompass the same capacity range of the modular MSW-fired boilers, but can also be as large as 60 MMBtu/hr (17.6 MWt) heat input capacity. Large-mass burning boilers are not commonly used at industrial facilities; thus, ISW is usually only fired in mass-burning boilers when it is collected as part of MSW.<sup>64</sup>

#### **3.4.5 Refuse-derived Fuel (RDF)-fired Boilers**

RDF is fuel processed from general solid waste. Unlike MSW and ISW fuels, which are burned in the same form as they are received at the boiler site, RDF is generated by the sorting and processing of the general solid waste. Usually, noncombustibles, such as glass and metal, are removed and recycled, and the remainder of the refuse processed into pelletized or powdered form. RDF can be burned alone or in combination with coal or oil.<sup>54</sup> The most common use of RDF is as a substitute for part of the coal used in coal-fired stoker and PC boilers. However, a few stoker units burn RDF alone; these units are similar to standard coal-fired boilers.<sup>64</sup>

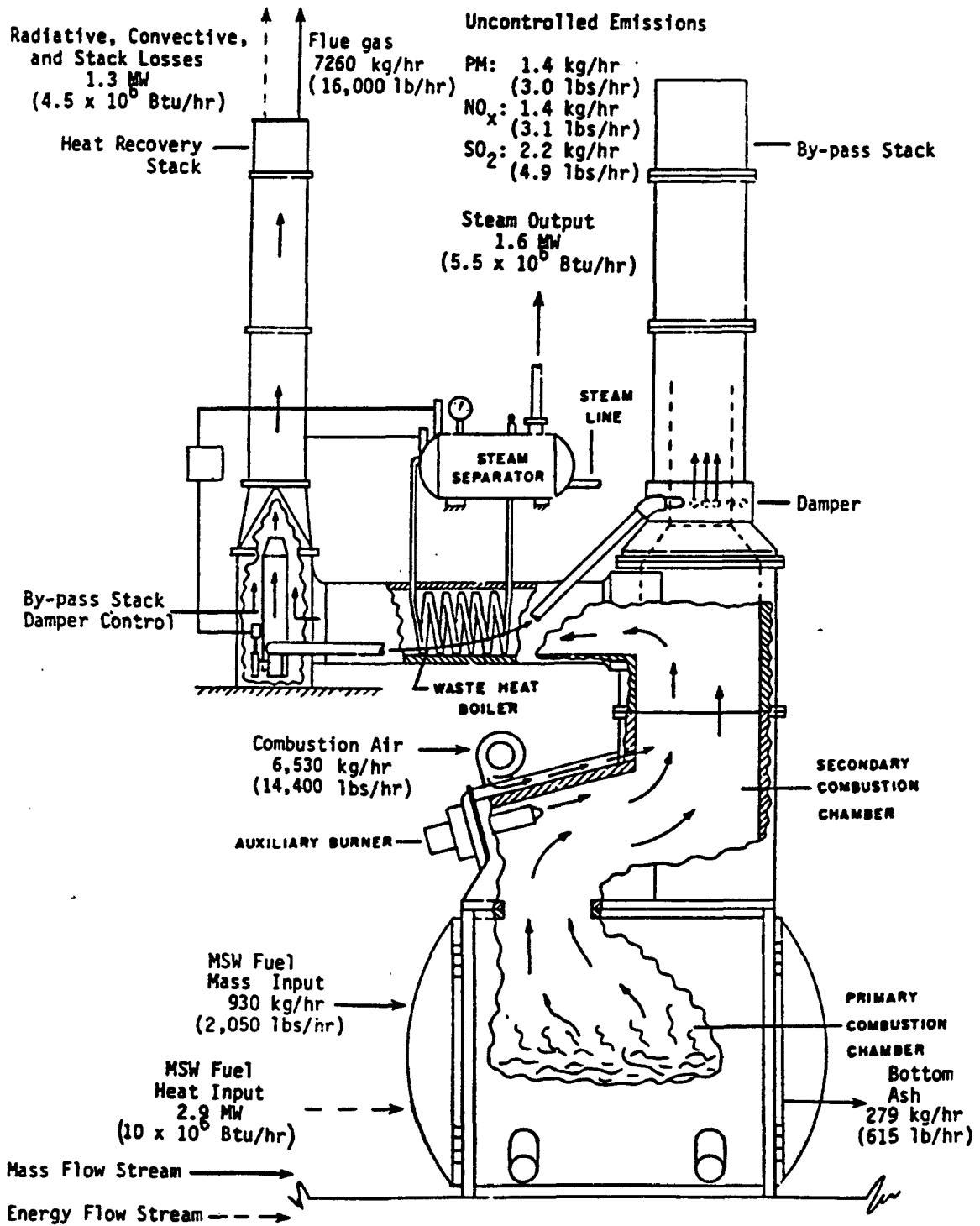

Figure 3-26. Modular MSW-fired boiler.<sup>63</sup>



Both RDF-firing and mass burn systems were commonly used in early U.S. resource recovery plants. Currently, the majority of U.S. MSW firing units utilize mass burn and not RDF firing, due in part to the successful experience of mass burn plants in Germany, Switzerland, Japan, and a number of U.S. locations. Based on the number of plants in operation and the number being planned in the near future, mass burn is the MSW-firing system of choice, although RDF firing is still considered a viable technique, especially when refuse throughput is low to moderate, on the order of a few thousand tons per day.<sup>62,65</sup>

### 3.5 REFERENCES FOR CHAPTER 3

1. CIBO NO<sub>x</sub> RACT Guidance Document. Council of Industrial Boiler Owners. Burke, VA. January 1993. p. 5.
2. Lorelli, J., and C. Castaldini (Acurex Corp.). Fluidized-Bed Combustion Boilers Market Assessment. Prepared for the Gas Research Institute. Chicago, IL. August 1991. Appendix A.
3. Devitt, T., et al. (PEDCo Environmental, Inc.). Population and Characteristics of Industrial/Commercial Boilers in the U.S. Publication No. EPA-600/7-79-178a. Prepared for the U.S. Environmental Protection Agency. Research Triangle Park, NC. August 1979. p. 10.
4. Nonfossil Fuel Fired Industrial Boilers—Background Information. Publication No. EPA-450/3-82-007. U.S. Environmental Protection Agency. Emission Standards and Engineering Division. Research Triangle Park, NC. March 1982.
5. Lim, K. J., et al. (Acurex Environmental Corp.). Industrial Boiler Combustion Modification NO<sub>x</sub> Controls, Volume 1: Environmental Assessment. Publication No. EPA-600/7-81-126a. Prepared for the U.S. Environmental Protection Agency. Research Triangle Park, NC. July 1981. p. 2-1.
6. Surprenant, N. F., et al. (GCA Corp.). Emissions Assessment of Conventional Stationary Combustion Systems, Volume IV: Commercial/Institutional Combustion Sources. Publication No. EPA-600/7-81-003b. Prepared for the U.S. Environmental Protection Agency. Research Triangle Park, NC. January 1981.
7. Devitt, T., et al. (PEDCo Environmental, Inc.). Population and Characteristics of Industrial/Commercial Boilers in the U.S. Publication No. EPA-600/7-79-178a. Prepared for the U.S. Environmental Protection Agency. Research Triangle Park, NC. August 1979. pp. A-1 to A-5.
8. Surprenant, N. F., et al. (GCA Corp.). Emissions Assessment of Conventional Stationary Combustion Systems, Volume V: Industrial Combustion Sources. Publication No. EPA-600/781-003c. Prepared for the U.S. Environmental Protection Agency. Research Triangle Park, NC. April 1981.
9. Devitt, T., et al. (PEDCo Environmental, Inc.). Population and Characteristics of Industrial/Commercial Boilers in the U.S. Publication No. EPA-600/7-79-178a. Prepared for the U.S. Environmental Protection Agency. Research Triangle Park, NC. August 1979. p. A-4.
10. Steam—39th Edition. Babcock & Wilcox. New York, NY. 1978. p. 25-6.
11. Boilers and Auxiliary Equipment. Power Magazine. McGraw-Hill, Inc. New York, NY. June 1988. p. B-52.

12. Devitt, T., et al. (PEDCo Environmental, Inc.). Population and Characteristics of Industrial/Commercial Boilers in the U.S. Publication No. EPA-600/7-79-178a. Prepared for the U.S. Environmental Protection Agency. Research Triangle Park, NC. August 1979. p. A-12.
13. Ibid. p. A-24.
14. Ibid. pp. A-2 to A-3.
15. Ibid. p. A-15.
16. Pacemaker II. Bulletin No. F2350 R1. Industrial Boiler Co., Inc. Thomasville, GA. December 1987.
17. The Fabric Filter Manual. The McIlvaine Company. Northbrook, IL. May 1985. Chapter IX. p. 10.01.
18. Devitt, T., et al. (PEDCo Environmental, Inc.). Population and Characteristics of Industrial/Commercial Boilers in the U.S. Publication No. EPA-600/7-79-178a. Prepared for the U.S. Environmental Protection Agency. Research Triangle Park, NC. August 1979. p. 13.
19. Lim, K. J., et al. (Acurex Environmental Corp.). Industrial Boiler Combustion Modification NO<sub>x</sub> Controls, Volume 1: Environmental Assessment. Publication No. EPA-600/7-81-126a. Prepared for the U.S. Environmental Protection Agency. Research Triangle Park, NC. July 1981. p. 2-4.
20. The Fabric Filter Manual. The McIlvaine Company. Northbrook, IL. May 1985. Chapter IX. p. 10.03.
21. Steam—39th Edition. Babcock & Wilcox. New York, NY. 1978. pp. 11-1 to 11-6.
22. Devitt, T., et al. (PEDCo Environmental, Inc.). Population and Characteristics of Industrial/Commercial Boilers in the U.S. Publication No. EPA-600/7-79-178a. Prepared for the U.S. Environmental Protection Agency. Research Triangle Park, NC. August 1979. p. A-6.
23. Ibid. p. A-8.
24. Boilers and Auxiliary Equipment. Power Magazine. McGraw-Hill, Inc. New York, NY. June 1988. pp. B-28 to B-32.
25. Devitt, T., et al. (PEDCo Environmental, Inc.). Population and Characteristics of Industrial/Commercial Boilers in the U.S. Publication No. EPA-600/7-79-178a. Prepared for the U.S. Environmental Protection Agency. Research Triangle Park, NC. August 1979. p. 25.

26. Lim, K. J., et al. (Acurex Environmental Corp.). Industrial Boiler Combustion Modification NO<sub>x</sub> Controls, Volume 1: Environmental Assessment. Publication No. EPA-600/7-81-126a. Prepared for the U.S. Environmental Protection Agency. Research Triangle Park, NC. July 1981. pp. 2-11 to 2-13.
27. Boilers and Auxiliary Equipment. Power Magazine. McGraw-Hill, Inc. New York, NY. June 1988. p. B-54.
28. Lorelli, J., and C. Castaldini (Acurex Corp.). Fluidized-Bed Combustion Boilers Market Assessment. Prepared for the Gas Research Institute. Chicago, IL. August 1991. pp. 6 to 8.
29. Scott, R. L. Fluidized Bed Combustion: Pressurized Systems. U.S. Department of Energy. Morgantown, WV.
30. Lorelli, J., and C. Castaldini (Acurex Corp.). Fluidized-Bed Combustion Boilers Market Assessment. Prepared for the Gas Research Institute. Chicago, IL. August 1991. p. 13.
31. Makansi, J., and R. Schwieger. Fluidized-bed Boilers. Power Magazine. McGraw-Hill, Inc. New York, NY. May 1987.
32. Gaglia, B. N. and A. Hall (Gilbert/Commonwealth, Inc.). Comparison of Bubbling and Circulating Fluidized Bed Industrial Steam Generation. Proceedings of the 1987 International Conference on Fluidized Bed Combustion. The American Society of Mechanical Engineers/Electric Power Research Institute/Tennessee Valley Authority. New York, NY. 1987.
33. Lorelli, J., and C. Castaldini (Acurex Corp.). Fluidized-Bed Combustion Boilers Market Assessment. Prepared for the Gas Research Institute. Chicago, IL. August 1991. pp. 3 to 6.
34. Ibid. p. 21.
35. Devitt, T., et al. (PEDCo Environmental, Inc.). Population and Characteristics of Industrial/Commercial Boilers in the U.S. Publication No. EPA-600/7-79-178a. Prepared for the U.S. Environmental Protection Agency. Research Triangle Park, NC. August 1979. p. 14.
36. Ibid. p. A-18.
37. Ibid. pp. A-21 to A-24.
38. Fusion Welded Horizontal Return Tubular Boiler To ASME Code. Bulletin No. F3350. Industrial Boiler Co., Inc. Thomasville, GA.

39. CB Packaged Boilers. Bulletin No. CBF-178 R11. Cleaver Brooks. Milwaukee, WI. December 1986.
40. Lim, K. J., et al. (Acurex Environmental Corp.). Industrial Boiler Combustion Modification NO<sub>x</sub> Controls, Volume 1: Environmental Assessment. Publication No. EPA-600/7-81-126a. Prepared for the U.S. Environmental Protection Agency. Research Triangle Park, NC. July 1981. p. 2-3.
41. Devitt, T., et al. (PEDCo Environmental, Inc.). Population and Characteristics of Industrial/Commercial Boilers in the U.S. Publication No. EPA-600/7-79-178a. Prepared for the U.S. Environmental Protection Agency. Research Triangle Park, NC. August 1979. p. 15.
42. Govan, F. A. and D. R. Bahnfleth. Boilers and Burners: An Industry in Transition. Heating/Piping/Air Conditioning Magazine. August 1992. pp. 31-33.
43. Lim, K. J., et al. (Acurex Environmental Corp.). Industrial Boiler Combustion Modification NO<sub>x</sub> Controls, Volume 1: Environmental Assessment. Publication No. EPA-600/7-81-126a. Prepared for the U.S. Environmental Protection Agency. Research Triangle Park, NC. July 1981. p. 2-38.
44. Ibid. p. 2-26.
45. Packaged Watertube Steam Boilers. Bulletin No. CBW-227 R9. Cleaver Brooks. Milwaukee, WI. July 1987.
46. Three-pass Vertical Tubeless Boilers. Bulletin No. F2050 990-3.0. Industrial Boiler Co., Inc. Thomasville, GA.
47. NO<sub>x</sub> Emission Control for Boilers and Process Heaters—Training Manual. Southern California Edison. Rosemead, CA. April 1991.
48. Lorelli, J., and C. Castaldini (Acurex Corp.). Fluidized Bed Combustion Boilers Market Assessment. Prepared for the Gas Research Institute. Chicago, IL. August 1991. p. 26.
49. Natcher, P. B. High Technology Low NO<sub>x</sub> Burner Systems for Fired Heaters and Steam Generators. Process Combustion Corporation. Pittsburgh, PA. Presented at the Pacific Coast Oil Show and Conference. Los Angeles, CA. November 1982.
50. Steam—39th Edition. Babcock & Wilcox. New York, NY. 1978. pp. 7-3 to 7-4.
51. Sotter, J. G. Fuel Oil Atomization for Boilers. Report No. 10-173. KVB, Inc. Tustin, CA. June 1974. pp. 5 to 8.

52. Nonfossil Fuel Fired Industrial Boilers—Background Information. Publication No. EPA-450/3-82-007. U.S. Environmental Protection Agency. Emission Standards and Engineering Division. Research Triangle Park, NC. March 1982. p. 3-2.
53. Ibid. pp. 3-10 to 3-24.
54. Peavy, H. S., et al. Environmental Engineering. McGraw-Hill Publishing Co. New York, NY. 1985. p. 671.
55. Wood Waste Burning Systems. Bulletin No. WW-74. Coen Company. Burlingame, CA.
56. Steam—39th Edition. Babcock & Wilcox. New York, NY. 1978. pp. 27-3 to 27-4.
57. Nonfossil Fuel Fired Industrial Boilers—Background Information. Publication No. EPA-450/3-82-007. U.S. Environmental Protection Agency. Emission Standards and Engineering Division. Research Triangle Park, NC. March 1982. pp. 3-30 to 3-35.
58. Ibid. p. 577.
59. Ibid. pp. 3-6 to 3-9.
60. Ibid. pp. 3-37 to 3-38.
61. Ibid. p. 674.
62. The Fabric Filter Manual. The McIlvaine Company. Northbrook, IL. May 1985. pp. 325.03 to 325.05.
63. Nonfossil Fuel Fired Industrial Boilers—Background Information. Publication No. EPA-450/3-82-007. U.S. Environmental Protection Agency. Emission Standards and Engineering Division. Research Triangle Park, NC. March 1982. pp. 3-43 to 3-44.
64. Ibid. pp. 3-48 to 3-49.
65. Boilers and Auxiliary Equipment. Power Magazine. McGraw-Hill, Inc. New York, NY. June 1988. p. B-57.

#### 4. BASELINE EMISSION PROFILES

$\text{NO}_x$  is a high-temperature byproduct of the combustion of fuels with air.  $\text{NO}_x$  formation in flames has two principal sources. Thermal  $\text{NO}_x$  is that fraction of total  $\text{NO}_x$  that results from the high-temperature reaction between the nitrogen and oxygen in the combustion air. The rate of thermal  $\text{NO}_x$  formation varies exponentially with peak combustion temperature and oxygen concentration. Fuel  $\text{NO}_x$  is that fraction of total  $\text{NO}_x$  that results from the conversion of organic-bound nitrogen in the fuel to  $\text{NO}_x$  via a high-temperature reaction with oxygen in the air. The amount of nitrogen in the fuel, peak combustion temperature, oxygen concentration, and mixing rate of fuel and air influence the amount of fuel  $\text{NO}_x$  formed. When low-nitrogen fuels such as natural gas, higher grade fuel oils, and some nonfossil fuels are used, nearly all the  $\text{NO}_x$  generated is thermal  $\text{NO}_x$ . When coal, low-grade fuel oils, and some organic wastes are burned, fuel  $\text{NO}_x$  generally becomes more of a factor because of the higher levels of fuel-bound nitrogen available.

Aside from the physical and chemical characteristics of the fuels, many boiler design and operating parameters influence the formation of  $\text{NO}_x$  because they impact peak flame temperatures, fuel-air mixing rates, and oxygen concentrations. Principal among these are the heat release rates and absorption profiles in the furnace, fuel feed mechanisms, combustion air distribution, and boiler operating loads. For example, steam pressure and temperature requirements may mandate a certain heat release rate and heat absorption profile in the furnace which changes with the load of the boiler. Solid fuels can be introduced into the furnace in several ways, each influencing the rate of mixing with combustion air and the peak combustion temperature. These parameters are very unit specific and vary according to the design type and application of each individual boiler. As described in Chapter 3, ICI boilers include a broad range of furnace types operating in a variety of applications and burning a variety of fuels ranging from clean burning natural gas to several types of nonfossil and waste fuels. Thus,  $\text{NO}_x$  emissions from ICI boilers tend to be highly variable.

This chapter discusses the primary factors influencing baseline NO<sub>x</sub> levels and summarizes the baseline (uncontrolled) NO<sub>x</sub> emission levels measured from a variety of ICI boiler and fuel combinations. Parameters affecting NO<sub>x</sub> emissions from ICI boilers are discussed in Section 4.1, while compiled baseline emissions for ICI boilers are presented in Section 4.2 on the basis of boiler fuel type. Section 4.3 presents a summary of the information presented in this chapter.

#### **4.1 FACTORS AFFECTING NO<sub>x</sub> EMISSIONS FROM ICI BOILERS**

The ranges in baseline NO<sub>x</sub> emissions for ICI boilers are due to several factors including boiler design, fuel type, and boiler operation. These factors usually influence baseline NO<sub>x</sub> in combination with each other, and often to different degrees depending on the particular ICI boiler unit. Thus, wide variations among ICI boiler NO<sub>x</sub> emissions are common, even among similar boiler designs or fuel types. These factors are discussed in the following subsections.

##### **4.1.1 Boiler Design Type**

The firing type of the boiler influences the overall NO<sub>x</sub> emission level. For example, for a given fuel, tangential field-erected units typically have a baseline level less than wall-fired boilers because of their inherent staging of fuel and air in a concentric fireball. This trend has been documented for utility-sized boilers.<sup>1</sup> Conversely, cyclone units generally have higher NO<sub>x</sub> levels than wall-fired units due to their inherent turbulent, high-temperature combustion process, which is conducive to NO<sub>x</sub> formation.<sup>2</sup> Even within a particular type of boiler, other design details may influence baseline NO<sub>x</sub>. For example, in field erected PC wall-fired units, NO<sub>x</sub> may vary depending upon whether a wet bottom or dry bottom furnace is used. Wet bottom furnaces have higher furnace temperatures to maintain the slag in a molten state, leading to greater thermal NO<sub>x</sub> formation.<sup>3</sup>

In comparison, coal stokers have lower NO<sub>x</sub> emissions than PC-fired units since the stokers inherently operate in a "staged combustion" configuration.<sup>4</sup> Staged combustion, which is discussed in greater detail in Chapter 5, relies on the reduction of the peak flame zone oxygen level to reduce formation of fuel NO<sub>x</sub>, and is achieved by delaying — or staging — the addition of combustion air. Higher NO<sub>x</sub> levels reported for spreader stokers are due to a portion of the fuel burning in suspension with more effective fuel/air mixing and higher combustion temperatures. In comparison, overfeed and underfeed stokers combust more of the coal on a grate where combustion is naturally staged, with a fuel rich zone close to the grate and a more fully mixed zone above the grate. Additionally, underfeed and overfeed units tend to have larger



fireboxes and, consequently, lower heat release rates, resulting in lower peak temperatures and lower levels of thermal  $\text{NO}_x$  formation.<sup>5</sup>

The other major design type of solid-fuel-fired units, FBC boilers, report lower baseline  $\text{NO}_x$  emissions than similarly-sized wall-, tangential-, or cyclone-fired units, due mostly to the lower combustion temperatures used in FBCs. In FBC boilers,  $\text{NO}_x$  formation generally peaks in the lower part of the furnace and is reduced in the freeboard zone, where heterogeneous reducing reactions between char and  $\text{NO}_x$  occur.<sup>6</sup> Also, newer FBC designs are incorporating combustion air staging in their original configuration to achieve low emissions for permitting in strict environmental areas. In staged configurations, the lower part of the fluidized bed and furnace are kept at or below stoichiometry. The staged addition of combustion air results in lower  $\text{NO}_x$  levels compared to unstaged designs.

Regarding smaller packaged natural-gas- or oil-fired boilers,  $\text{NO}_x$  emissions generally depend more on fuel, heat release rate and capacity characteristics. In general, ICI boilers with higher heat release rates and higher capacities tend to have higher levels of  $\text{NO}_x$ . This is discussed in more detail in Section 4.1.3. For a given heat release rate and fuel type, however, there is no strong correlation between  $\text{NO}_x$  emissions and whether a packaged boiler is a firetube or a watertube design.

#### **4.1.2 Fuel Characteristics**

ICI boiler baseline  $\text{NO}_x$  emissions are highly influenced by the properties of the fuels burned.  $\text{NO}_x$  and other emissions will vary depending on whether natural gas, oil, coal, or nonfossil fuels are used. Additionally, among each of these fuel types, emissions will depend on highly variable factors such as fuel grade and fuel source. In particular, studies have shown that fuel nitrogen content — and for coal the oxygen content and the ratio of fixed carbon to volatile matter — are key factors influencing  $\text{NO}_x$  formation.<sup>3,7-9</sup>

Much attention has been given to the role of fuel-bound nitrogen in  $\text{NO}_x$  formation. For any given fuel, only a portion of the available fuel nitrogen is converted during combustion to fuel  $\text{NO}_x$ . Published data indicate that for coal burning, anywhere from 5 to 60 percent of the nitrogen is converted, whereas for other fuels as much as 80 percent of the fuel bound nitrogen is routinely converted.<sup>10,11</sup> In general, higher nitrogen fuels such as coal and residual oil have lower conversion rates, as shown in Figure 4-1, but higher overall  $\text{NO}_x$  rates than lower nitrogen fuels such as distillate oil.<sup>3</sup> The nitrogen content of bituminous coals can vary from as low as 0.8 to as high as 3.5 percent by weight. Fuel oil is normally divided into distillate oil and residual

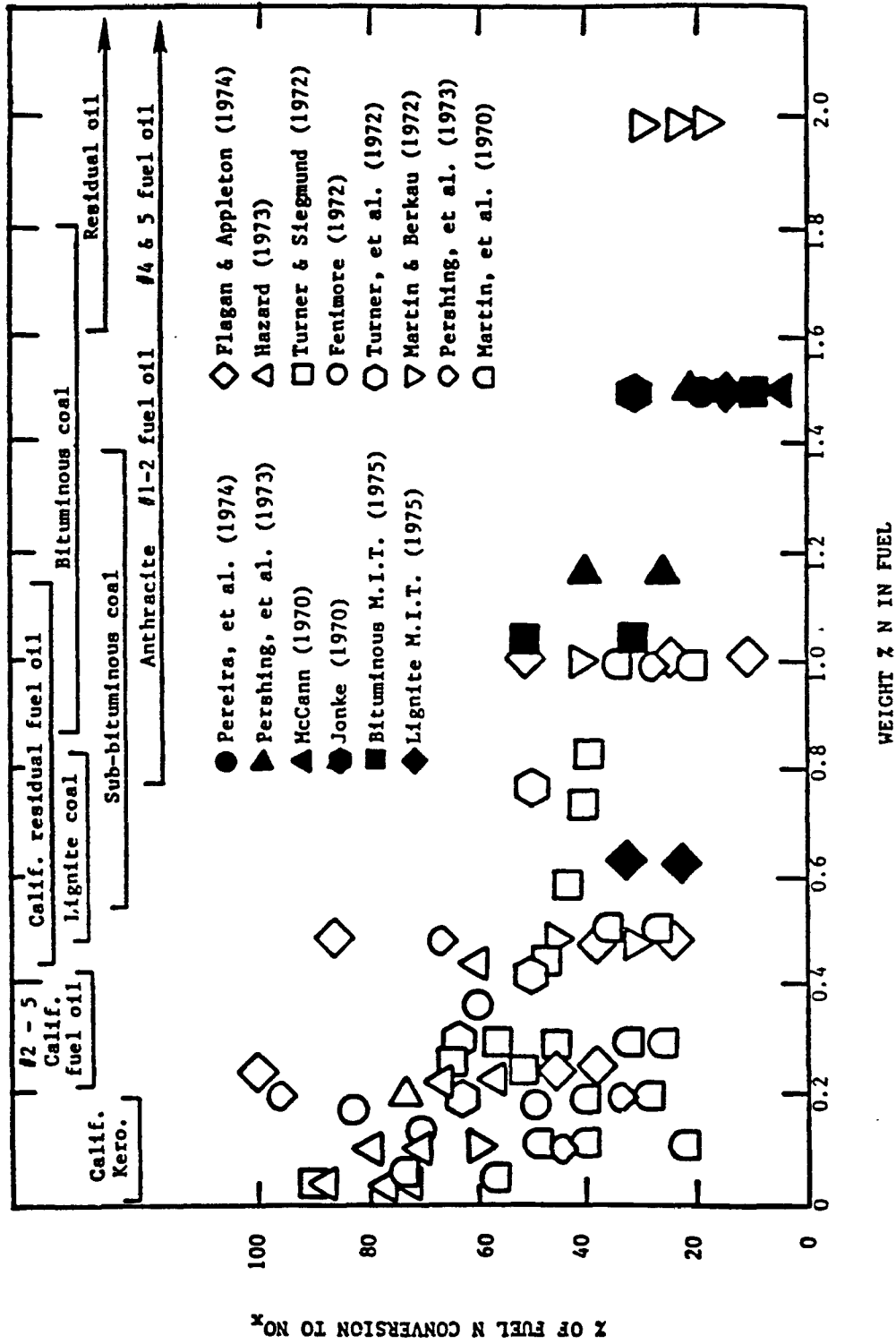

Figure 4-1. Conversion of fuel nitrogen.<sup>11</sup>

oil. Distillate oil represents the lighter fraction of the distillation process, including No. 2 oil and diesel oil normally used in residential and commercial heating, internal combustion engines, and sometimes in larger boilers strictly regulated for SO<sub>2</sub> and NO<sub>x</sub> emissions. Residual oil consists of the higher temperature fractions and still bottoms from the distillation process, including No. 4, 5, and 6 fuel oils often used in industrial and some commercial boilers.

Table 4-1 lists the range and average concentrations of nitrogen and sulfur in distillate, residual, and crude oils. The data were compiled from various sources, including emission test reports, to illustrate the variability of these fuel properties. Many areas will have oils with different values, these depending on many factors such as the type of crude, refinery processes (e.g., hydrodesulfurization), and blending. Clearly, the lighter oils contain much lower levels of fuel nitrogen and sulfur, thereby contributing significantly lower NO<sub>x</sub> and SO<sub>2</sub> emissions. Distillate oil normally has less than 0.01-percent nitrogen content, whereas the fuel nitrogen content of residual oils typically ranges from 0.1 to 0.8 percent by weight, with an average of 0.36 percent based on the data used to compile Table 4-1.

Sulfur content is typically specified when residual oil is purchased. This is done to meet environmental regulations and to safeguard boiler equipment from acid corrosion. Although lower sulfur content generally means lower nitrogen, there is no apparent direct relationship between these two fuel oil parameters, as illustrated in Figure 4-2. Because the deliberate denitrification of fuel oil is not a refinery practice, significant swings in the nitrogen content of residual oil occur even when sulfur content is limited to low levels.

The nitrogen content of natural gas can vary over a wide range, from zero to as high as 12.9 percent, depending on the source of the gas. Nitrogen in natural gas, however, does not contribute as much to the production of fuel NO<sub>x</sub> as with liquid or solid fuels, the reason being that the nitrogen in natural gas is in its molecular form (N<sub>2</sub>), as in the combustion air. In contrast, nitrogen in liquid or solid fuels is released in its atomic form (N) and reacts at relatively low temperatures with oxygen to form fuel NO<sub>x</sub>.<sup>12</sup>

Figure 4-3 shows the effect of fuel nitrogen content on total NO<sub>x</sub> emissions for 26 oil-fired and 15 coal-fired industrial boiler tests. For the oil-fired tests, in which both residual and distillate oils were burned, a clear correlation was seen between nitrogen content and NO<sub>x</sub>, with higher NO<sub>x</sub> levels reported for the higher nitrogen content oils. The field tests of coal-fired units, however, showed no direct correlation between total NO<sub>x</sub> emissions and coal fuel nitrogen content, per se.<sup>9</sup> Similar results were also reported in a study comparing the use of low-sulfur

**TABLE 4-1. TYPICAL RANGES IN NITROGEN AND SULFUR CONTENTS OF FUEL OILS<sup>a</sup>**

	Distillate oil (No. 2)		Residual oil (No. 6)	
	Nitrogen	Sulfur	Nitrogen	Sulfur
Average	<0.01	0.72	0.36	1.3
Low	<0.001	0.20	0.10	0.10
High	0.01	0.70	0.80	3.5
Standard deviation	0.005	0.20	0.17	0.90
Reference	13-15		9, 14, 16-20	

<sup>a</sup>All concentrations are percent by weight.

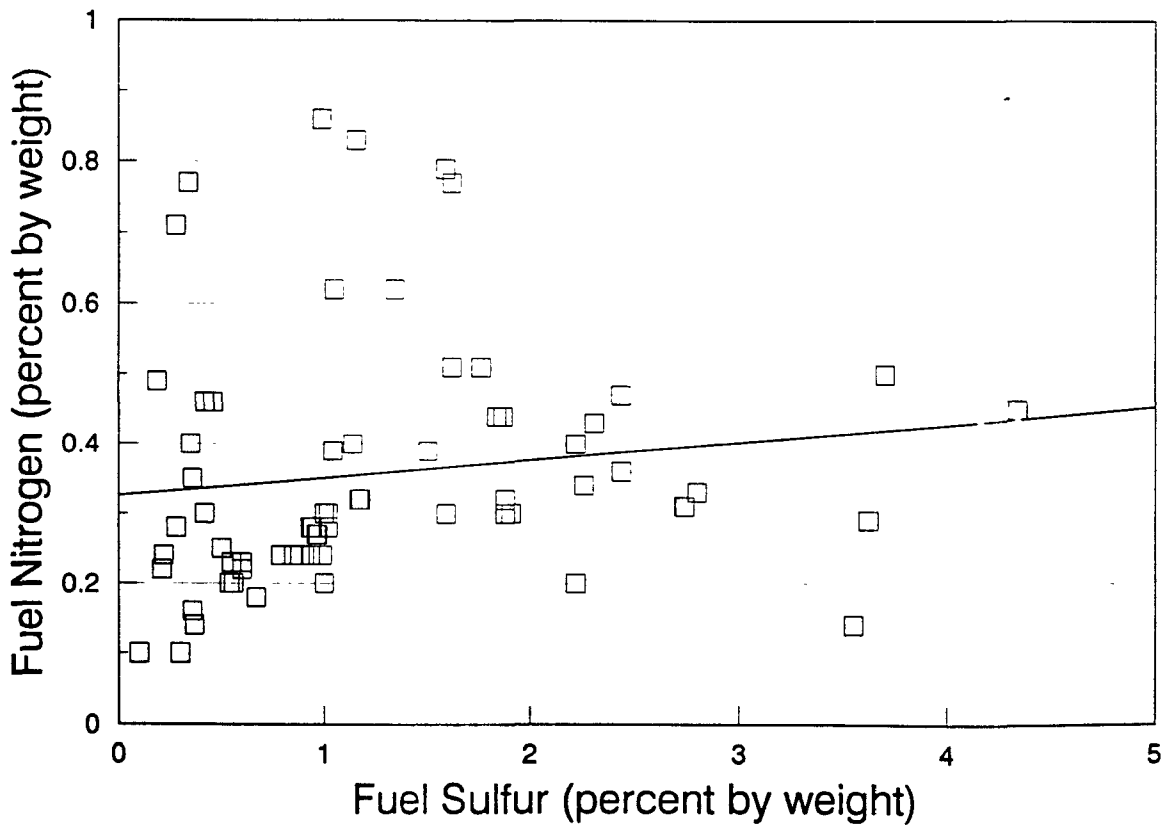

**Figure 4-2. Fuel oil nitrogen versus sulfur for residual oil. (Data from several EPA- and EPRI-sponsored tests; see Table 4-1.)**

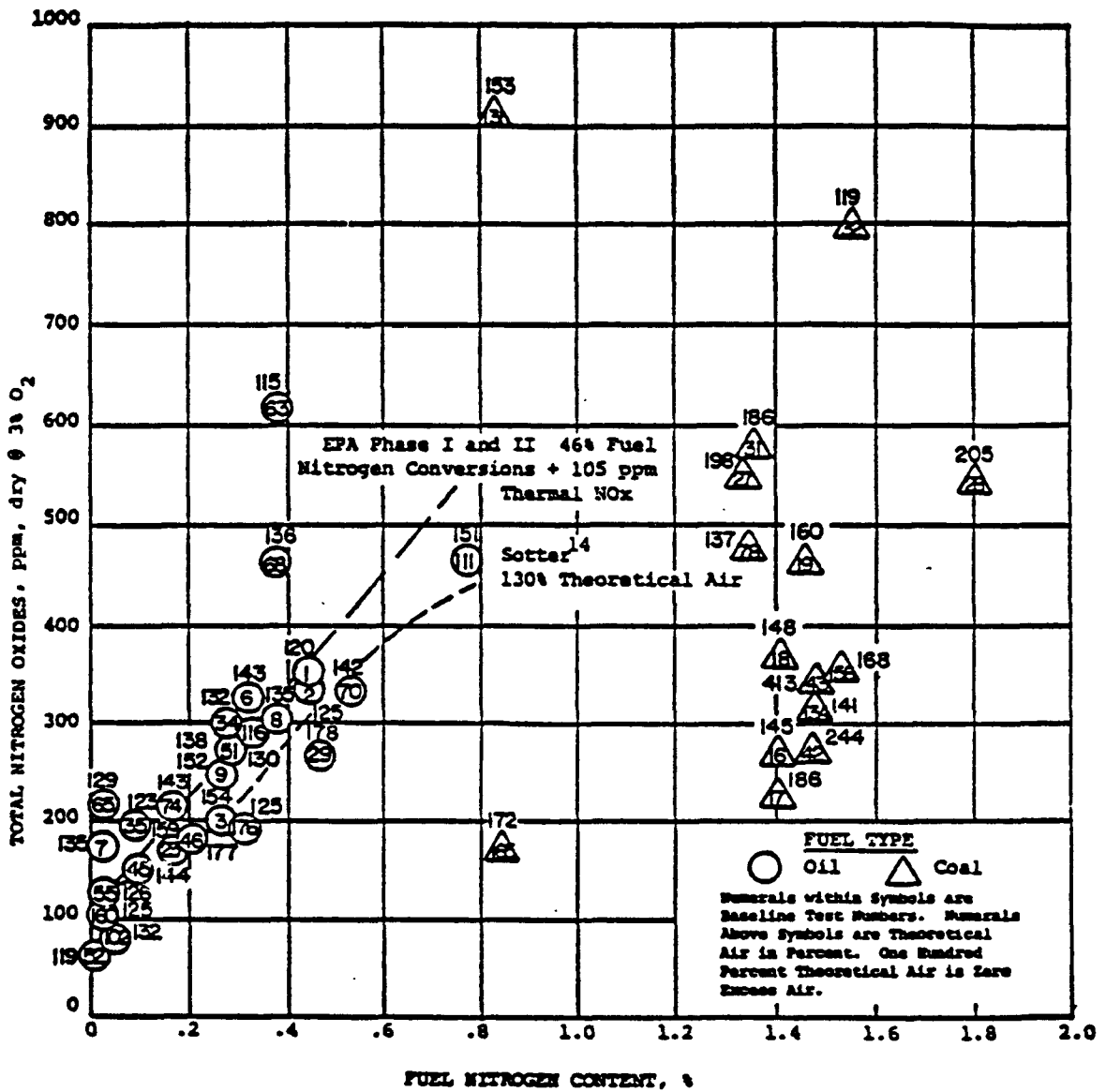

Figure 4-3. Effect of fuel nitrogen content on total NO<sub>x</sub> emissions.<sup>9</sup>

western coal to the use of eastern bituminous coal in ICI boilers.<sup>8</sup> It is believed that while nitrogen content does play a key role in NO<sub>x</sub> formation, as was seen in the oil tests, other coal fuel factors such as oxygen content also influence NO<sub>x</sub> formation concurrently, masking any obvious correlation between coal fuel nitrogen and NO<sub>x</sub>.

This was suggested by test results showing a possible linkage between the ratio of coal oxygen to coal nitrogen and the amount of NO<sub>x</sub> formed. Figure 4-4 shows the results of a study of the effects of the coal oxygen/nitrogen ratio on fuel NO<sub>x</sub> formation in tangential PC-fired boilers. The figure shows the relationship between fuel NO<sub>x</sub>, coal nitrogen content, and the coal oxygen/nitrogen ratio. The data indicate slightly higher NO<sub>x</sub> emissions for western sub-bituminous coal due to the higher coal oxygen/nitrogen ratio, despite the coal's lower fuel nitrogen content. On a broader scale, coal property data show that coals with high oxygen/nitrogen ratios generally have lower nitrogen contents. Thus, the two influences — higher NO<sub>x</sub> due to higher oxygen content, and lower NO<sub>x</sub> due to lower nitrogen content — would tend to balance one another resulting in reasonably similar fuel NO<sub>x</sub> emissions for a variety of coal types.<sup>7,21</sup>

Another major coal factor influencing baseline NO<sub>x</sub> formation is the fuel ratio, defined as the ratio of a coal's fixed carbon to volatile matter. Typically, under unstaged combustion conditions, lower fuel ratios (i.e. higher volatile content of the coal) correlate to higher levels of NO<sub>x</sub>, because with higher volatile content coals, greater amounts of volatile nitrogen are released in the high temperature zone of the flame where sufficient oxygen is present to form NO<sub>x</sub>.<sup>3</sup> Thus, considered by itself, higher volatile coal firing will tend to result in higher baseline NO<sub>x</sub> levels.<sup>22</sup> It has been shown, however, that firing coal with high volatile content and lower fixed carbon generally results in less solid carbon to be burned out in the post-flame gases, meaning that the coal can be fired at lower excess air before combustible losses became a problem.<sup>8</sup> As discussed in Section 4.1.4, lower excess air requirements generally result in lower NO<sub>x</sub> emissions. Thus, the higher NO<sub>x</sub> levels associated with higher volatile coals may be balanced to a certain degree by the lower excess air capability provided.

The difference between average NO<sub>x</sub> emission levels reported among various fuel oil types (i.e., residual versus distillate) lies primarily in the fact that residual oils are produced from the residue left after lighter fractions (gasoline, kerosene, and distillate oils) have been removed from crude oil. Residual oils thus contain high quantities of nitrogen, sulfur, and other impurities. As discussed, fuels with high nitrogen contents generally produce higher levels of

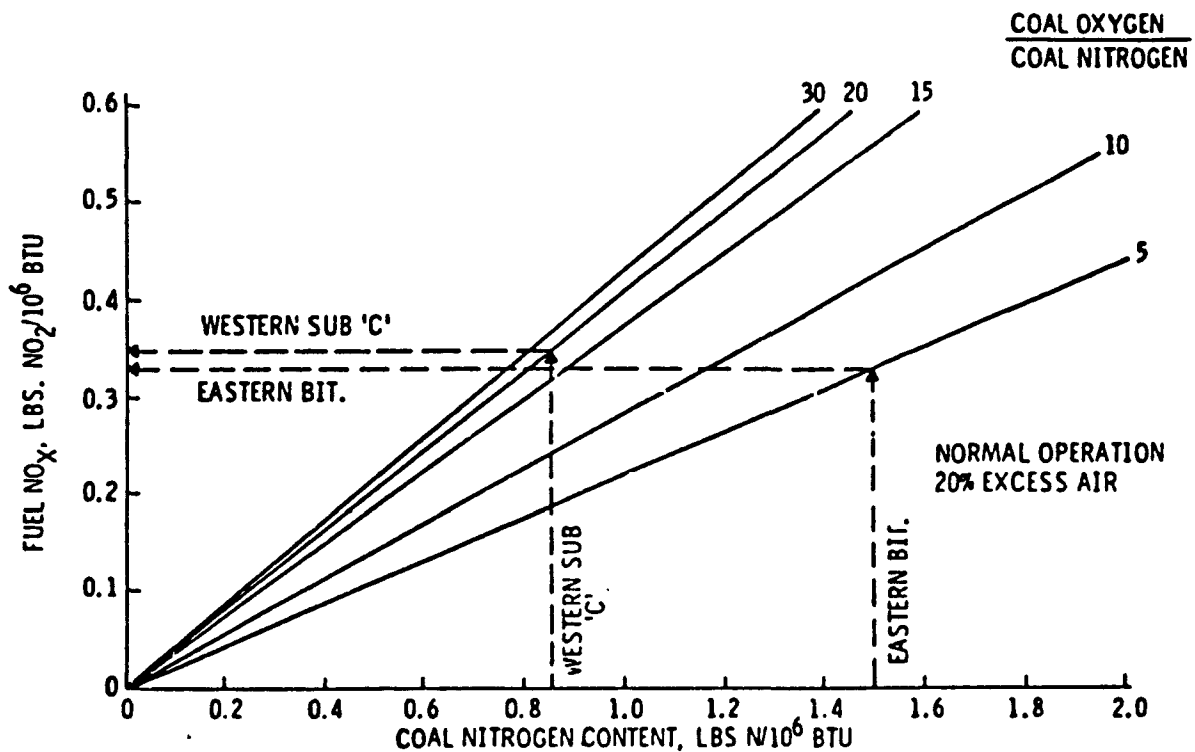

Figure 4-4. Fuel NO<sub>x</sub> formation as a function of coal oxygen/nitrogen ratio and coal nitrogen content.<sup>21</sup>

fuel-bound NO<sub>x</sub> than fuels with low nitrogen contents. Thus, with residual oil in particular, fuel NO<sub>x</sub> makes up a greater portion of the total NO<sub>x</sub> emitted. For any particular class of boilers, the range in NO<sub>x</sub> emissions for residual oil is often wider than the range of emissions for distillate oil. The larger amount and variation of fuel nitrogen in the residual oil accounts for this.<sup>23</sup> Even within one type of fuel oil, large variations in NO<sub>x</sub> emissions can be recorded due to the other factors discussed in this chapter. The variability in NO<sub>x</sub> emissions between the boilers listed in Appendix A burning the same type of oil is chiefly due to variations in boiler heat release rates and operating conditions.

Besides distillate oil, many nonfossil fuel types are low-nitrogen-content fuels. Thus, NO<sub>x</sub> emissions from ICI boilers fired on these fuels and on natural gas are almost entirely thermal NO<sub>x</sub>, and the major factors which influence their NO<sub>x</sub> levels are furnace heat release rate (related to capacity and operating load) and excess air level, both of which are discussed below.<sup>24</sup> While most wood burning boilers are stokers and are similar in design to coal-fired

units, the relatively low nitrogen content of wood contributes to much lower fuel-bound NO<sub>x</sub> formation than with coal. In general, with wood wastes the generation of particulates and other unburned combustibles is more of a concern than NO<sub>x</sub> formation. The wood moisture content and wood fuel size are the two most important fuel quality factors influencing those emissions.<sup>25</sup>

Moisture content also plays an important role in the formation of uncombustible emissions in MSW firing. By its nature, MSW composition is highly dependent on the net waste contributions of residential and commercial waste producers, and on seasonal factors which may impact the amount and type of organic waste produced. For example, a period of high rainfall can result in increased moisture content in the MSW, with larger quantities of yard waste. These variables result in wide ranges in MSW composition and corresponding fuel properties. Studies have shown that the non-combustible content of MSW can range from 5 to 30 percent, the moisture content from 5 to 50 percent, and the heating value from about 7,000 to 15,000 kJ/kg (3,000 to 6,500 Btu/lb).<sup>26</sup> Nitrogen contents, too, are often highly variable depending on the source of MSW. Ultimate analyses of MSW from different parts of the United States have shown nitrogen contents ranging between 0.2 and 1.0 percent.<sup>27-31</sup> Thus, emissions from MSW-fired boilers will also tend to be highly variable.

#### **4.1.3 Boiler Heat Release Rate**

Boiler heat release rate per furnace area is another influential variable affecting NO<sub>x</sub> formation. As heat release rate increases, so does peak furnace temperature and NO<sub>x</sub> formation, as illustrated in Figure 4-5. Boiler heat release rate varies primarily with the boiler firing type, the primary fuel burned, and the operating load.<sup>3</sup> Additionally, boiler heat release rate per unit volume is often related to boiler capacity, as illustrated in Figure 4-6. For example, among coal-fired boilers, PC-fired units are typically the largest in capacity. The data in Appendix A include PC-fired units from 111 to 640 MMBtu/hr (32.5 to 188 MWt) heat input capacity, whereas the coal stokers listed in Appendix A are generally smaller, ranging in size from 3 to 444 MMBtu/hr (0.88 to 130 MWt), with the vast majority being below 200 MMBtu/hr (59 MWt) capacity. These ranges are fairly representative of the capacity ranges discussed in Chapter 3. Compared to other coal-fired boiler designs, PC-fired units tend to have larger capacities, heat release rates, and, as shown by the data in Appendix A, generally higher baseline NO<sub>x</sub> levels.

Among stoker units, the largest capacity stokers are spreader stokers as reflected in the Appendix A data. The majority of spreader stoker data came from units greater than



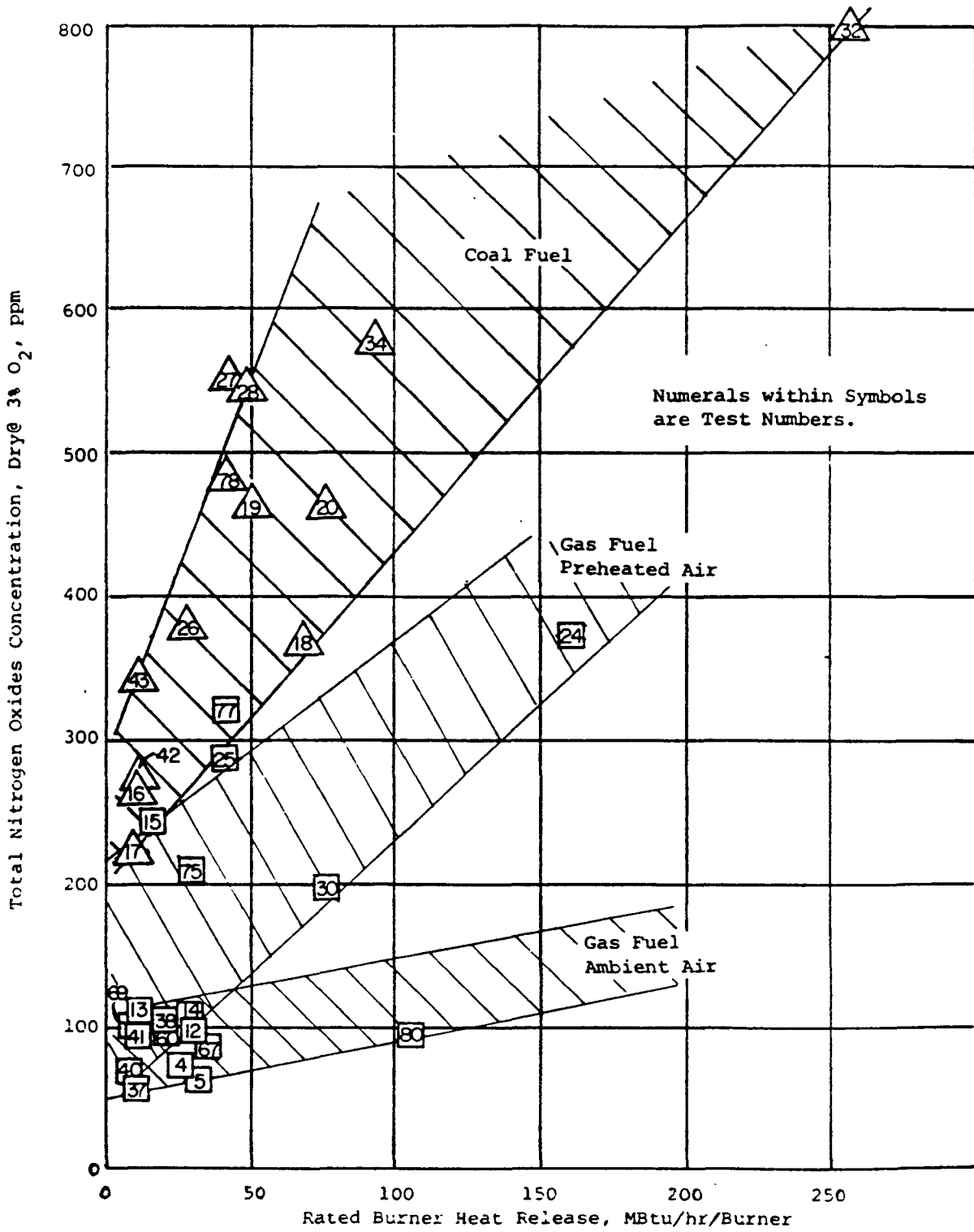

Figure 4-5. Effect of burner heat release rate on NO<sub>x</sub> emissions for coal and natural gas fuels.<sup>16</sup>

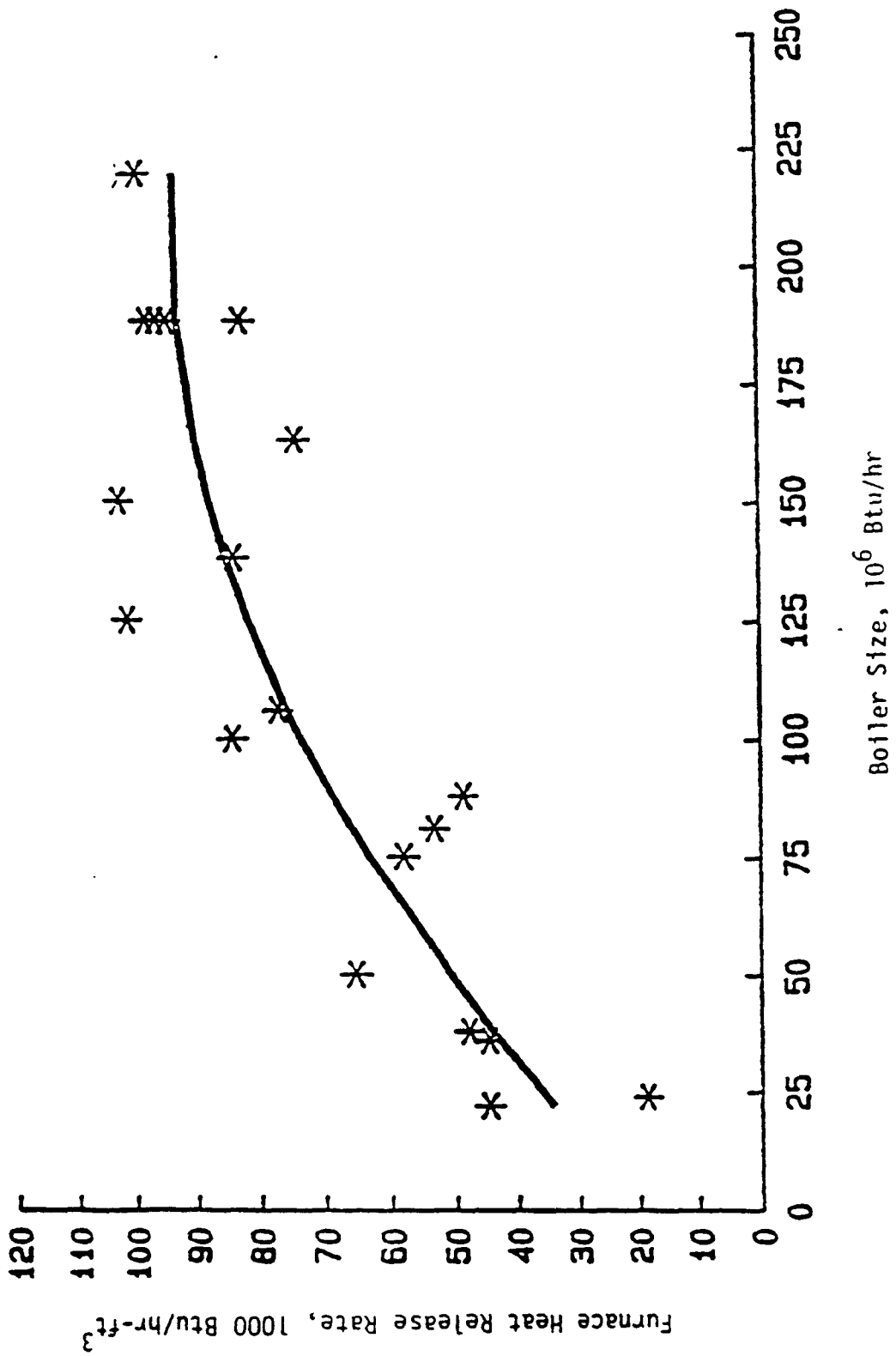

Figure 4-6. Furnace heat release rate versus boiler size.<sup>32</sup>

100 MMBtu/hr (29 MWt) in capacity, while the other two stoker types were usually less than 100 MMBtu/hr (29 MWt). While some large underfeed and overfeed stokers are in use in the ICI sector, these types of stokers commonly have lower heat input capacities, and, as indicated earlier, tend to have larger fireboxes. Consequently, overfeed and underfeed stokers generally have lower heat release rates per unit area, resulting in lower peak temperatures and lower levels of thermal  $\text{NO}_x$  formation than spreaders.<sup>5</sup>

Because packaged natural-gas- or oil-fired watertube boilers are available in higher capacities and heat release rates than firetubes, the high end of the ranges of reported baseline  $\text{NO}_x$  tends to be greater for the watertube designs. However, as noted in Section 4.1.1, there is no obvious correlation per se between  $\text{NO}_x$  emissions and whether a boiler is a firetube or a watertube.

#### **4.1.4 Boiler Operational Factors**

In addition to boiler design and fuel factors, the conditions under which a unit is operated also influence baseline  $\text{NO}_x$  levels. Chief among these operational factors are the amount of excess oxygen in the flue gases and the combustion air temperature. Excess oxygen refers to the oxygen concentration in the stack gases, and is dependent on the amount of excess air provided to the boiler for combustion.<sup>33</sup> Combustion air temperature, meanwhile, is dependent on the degree of air preheat used before the air is introduced into the furnace or burner. Air preheat is usually used to increase furnace thermal efficiency.

Numerous sources have discussed the typical relationship of excess oxygen levels and  $\text{NO}_x$ , wherein as excess oxygen increases, so does  $\text{NO}_x$ .<sup>34-37</sup> This relationship is shown in Figure 4-7, which presents data for natural-gas-fired watertube and firetube boilers. The thermal efficiency advantages of operating boilers at low excess oxygen levels have long been known, as long as the boiler is operated with a certain margin of excess air above the minimum level required to avoid excessive combustible emissions formation (CO, particulate). Operation on low excess oxygen or air is therefore considered a fundamental part of good combustion management of boilers. However, many ICI boilers are typically fired with excess oxygen levels which are more than adequate to assure complete combustion and provide a margin of safety to the operator.<sup>38</sup> Thus, these units often are operated at unnecessarily high excess oxygen levels that result in unnecessarily high  $\text{NO}_x$  emissions and losses in efficiency. Utility boilers, on the other hand, are typically fired with a smaller safety margin of excess air, but these units are more

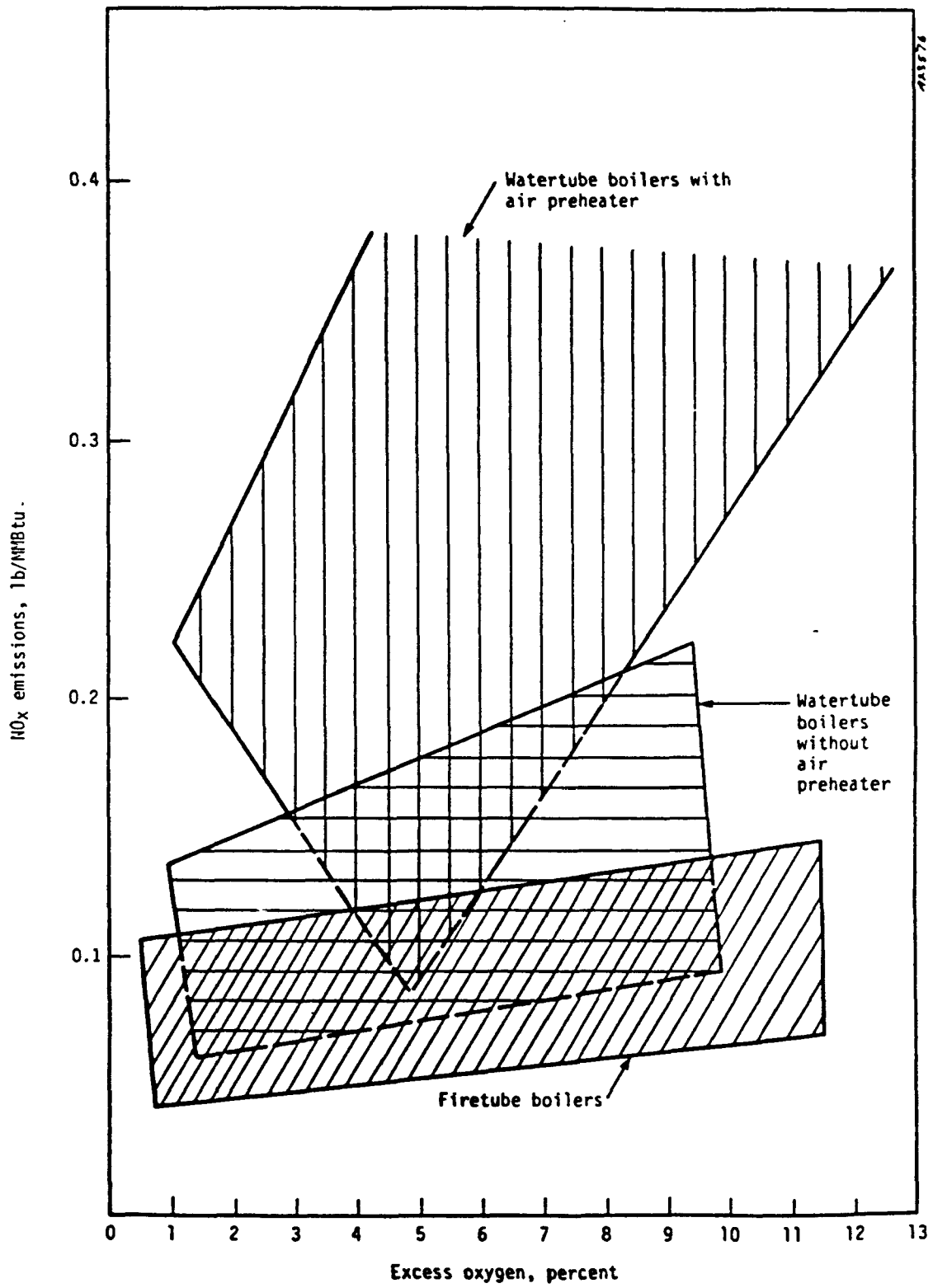

Figure 4-7. Effect of excess oxygen and preheat on NO<sub>x</sub> emissions, natural-gas-fired boilers.<sup>39</sup>

closely monitored by operating personnel and are not as subject to such wide variations in load as ICI boilers.<sup>38</sup>

Figure 4-7 also shows the effect of using combustion air preheat. As shown, use of air preheat generally results in higher levels of NO<sub>x</sub>. The level of combustion air preheat has a direct effect on the temperatures in the combustion zone, which, in turn, has a direct impact on the amount of thermal NO<sub>x</sub> formed. More specifically, the greater degree that the air is preheated, the higher the peak combustion temperature and the higher the thermal NO<sub>x</sub>.<sup>40</sup> Because the air preheat temperature primarily affects thermal NO<sub>x</sub> formation, the use of air preheat has its greatest NO<sub>x</sub> impact on fuels such as natural gas and distillate oils.<sup>40,41</sup> Boilers with combustion air preheat systems are usually larger than 50 MMBtu/hr in capacity, with preheat temperatures in the range of 120 to 340°C (250° to 650°F).<sup>41</sup> In particular, many stoker boilers are equipped with air preheat.

## **4.2 COMPILED BASELINE EMISSIONS DATA — ICI BOILERS**

This section presents compiled uncontrolled NO<sub>x</sub> emissions data for ICI boilers. Where data were available, CO and total unburned hydrocarbon (THC) emissions are also reported. These baseline data were compiled from test results on more than 200 boilers described in EPA documents and technical reports. These data are detailed in Appendix A. Emission tests on these boilers were performed at greater than 70-percent boiler load in most cases.

### **4.2.1 Coal-fired Boilers**

Table 4-2 summarizes reported baseline NO<sub>x</sub>, CO, and THC emission ranges for coal-fired boilers, and lists current AP-42 emission factors for comparison.<sup>42-45</sup> Industrial PC-fired boilers were among the highest emitters of NO<sub>x</sub>. The emission level from a wet bottom cyclone fired industrial boiler was recorded at 1.12 lb/MMBtu. The data for dry-bottom boilers compiled for this study show a range in NO<sub>x</sub> emissions from 0.46 to 0.89 lb/MMBtu. In comparison, AP-42 shows NO<sub>x</sub> emissions for dry-bottom boilers in the range of 0.58 to 0.81 lb/MMBtu. However, the AP-42 factors include several utility boilers as no distinction is made among application for this class of boilers. For wet-bottom industrial PC-fired boilers, only one data point was obtained in this study.

Spreader stoker units averaged 0.60 lb/MMBtu (450 ppm) NO<sub>x</sub> from a range of 0.40 to 1.08 lb/MMBtu (300 to 800 ppm). The other two stoker types, overfeed and underfeed, averaged 0.29 and 0.36 lb/MMBtu respectively (215 and 265 ppm). Emission data for spreader

**TABLE 4-2. COMPARISON OF COMPILED UNCONTROLLED EMISSIONS DATA WITH AP-42 EMISSION FACTORS, COAL-FIRED BOILERS**

Boiler type	NO <sub>x</sub> <sup>a</sup> lb/MMBtu <sup>a</sup>		CO, lb/MMBtu <sup>a</sup>		THC, lb/MMBtu <sup>a</sup>	
	Compiled data <sup>b</sup>	AP-42	Compiled data	AP-42	Compiled data	AP-42
PC wall-fired	0.46-0.89	0.58-0.81 <sup>c,d</sup>	0.0-0.05	0.02-0.04	0.001-0.019	0.004-0.007
PC tangential	0.53-0.68	0.58-0.81 <sup>c,d</sup>	0.0-0.14	0.02-0.04	0.004-0.009	0.004-0.007
Cyclone	1.12 <sup>e</sup>	1.31 <sup>c,d</sup>	0.0 <sup>e</sup>	0.02-0.04	N.A. <sup>f</sup>	0.004-0.007
Spreader stoker	0.35-0.77	0.42-0.54	0.0-0.53	0.19-0.35	0.0-0.018	0.004-0.007
Overfeed stoker	0.19-0.44	0.29-0.41	0.001-1.65	0.35-0.42	0.022-0.024	0.004-0.007
Underfeed stoker	0.31-0.48	0.37-0.42	0.0-0.94	0.42-0.76	0.010 <sup>e</sup>	0.081-0.150
Bubbling FBC	0.11-0.81	N.A.	0.17-0.49	N.A.	N.A.	N.A.
Circulating FBC	0.14-0.60	N.A.	0.02-0.25	N.A.	N.A.	N.A.

<sup>a</sup>To convert to ppm @ 3% O<sub>2</sub>, multiply by the following: NO<sub>x</sub>, 740; CO, 1,215; THC, 2,130.

<sup>b</sup>See Appendix A for compiled data.

<sup>c</sup>Current AP-42 does not distinguish PC units by firing configuration, but by dry- versus wet-bottom.

<sup>d</sup>Includes utility boilers.

<sup>e</sup>Single data point.

<sup>f</sup>N.A. = Not available. No data available.

stokers compiled for this study show generally higher emission levels than suggested by current AP-42 emission factors.

FBC boilers are typically low NO<sub>x</sub> emitters compared to PC-fired boilers and most spreader stokers, as the data indicate. This is due to several reasons, one of which is the lower combustion temperatures, as discussed in Chapter 3, and the use of staged combustion, as discussed in Section 4.1. As shown in Appendix A, available industrial coal-fired FBC data indicate an average NO<sub>x</sub> emission level of 0.27 lb/MMBtu (200 ppm), for bubbling bed units, and 0.32 lb/MMBtu (240 ppm), for circulating FBC boilers. NO<sub>x</sub> emissions ranged from 0.11 to 0.81 lb/MMBtu (80 to 600 ppm), for bubbling bed FBC units, and from 0.14 to 0.60 lb/MMBtu (105 to 445 ppm), for circulating FBC units. No AP-42 factors are currently available for industrial FBC boilers.

CO and THC emission data for all types of coal-fired boilers are highly variable. Average CO emission levels for PC wall-fired and spreader stoker units were generally in agreement with the AP-42 factors. For PC wall-fired units, CO ranged between 0 and 0.05 lb/MMBtu (0 to 60 ppm), while for spreader stokers, CO ranged between 0 and 0.53 lb/MMBtu (0 to 645 ppm). However, the measured CO emission levels for overfeed and underfeed stokers encompassed much wider ranges than reported in AP-42, ranging from 0 to 1.65 lb/MMBtu (0 to 2,000 ppm). Likewise, the THC emissions for overfeed stokers also differed greatly from the AP-42 values, averaging roughly 0.023 lb/MMBtu (50 ppm). Overfeed stoker THC data were available for only two units, however. This and the wide range of reported emission values indicates that available baseline CO and THC data from overfeed and underfeed stokers are generally inadequate. Circulating FBC boilers tend to have lower CO emissions than bubbling bed units, ranging from 0.02 to 0.25 lb/MMBtu (24 to 300 ppm). The bubbling bed units' CO levels were higher at 0.17 to 0.49 lb/MMBtu (205 to 595 ppm). The higher fluidization velocities and recirculation used in the circulating FBC units generally increase air/fuel mixing and combustion efficiency.

PC-fired boilers tend to emit less CO than stoker units. The data in Table 4-2 show CO emissions from PC wall-fired and tangential boilers ranging from 0 to 0.14 lb/MMBtu (0 to 170 ppm). CO emissions from the stoker units listed were higher, ranging from 0 to 1.65 lb/MMBtu (0 to 2,000 ppm). The use of pulverized coal allows better air/fuel mixing, increasing the combustion efficiency in the furnace which is evidenced by lower CO. In stoker units, however, coal combustion takes place on grates, and the combustion air supplied to the

fuel bed generally does not allow as high combustion efficiencies. Spreader stokers, which burn some fuel in suspension and the remainder on grates, generally emit less CO than overfeed and underfeed stokers, although the CO data in Appendix A for underfeed stokers is suspect, as mentioned above. The combustion temperatures in stokers are also lower than in PC-fired units, contributing to higher levels of CO.

#### **4.2.2 Oil-fired Boilers**

Table 4-3 gives baseline emission data for oil-fired ICI boilers, categorized by type of oil, boiler capacity, and heat transfer configuration. Residual-oil-fired boilers averaged approximately 0.36 lb/MMBtu (280 ppm) of NO<sub>x</sub>, regardless of capacity, with NO<sub>x</sub> ranging from 0.20 to 0.79 lb/MMBtu (160 to 625 ppm). Average baseline NO<sub>x</sub> levels for distillate-oil-fired units were lower at approximately 0.15 lb/MMBtu (120 ppm). NO<sub>x</sub> from the distillate-oil-fired units ranged from 0.08 to 0.25 lb/MMBtu (63 to 200 ppm). These data are in general agreement with AP-42 emission factors.

Reported CO emission levels for residual oil boilers were low, with the majority of units reporting CO levels below 0.030 lb/MMBtu (40 ppm). The baseline CO data for distillate-oil-fired watertube boilers, however, show wide variability, with units in the large capacity (greater than 100 MMBtu/hr) category emitting anywhere from 0 to 0.84 lb/MMBtu (0 to 1,090 ppm), while in the 10 to 100 MMBtu/hr capacity range, units emitted between 0 and 1.18 lb/MMBtu (0 and 1,530 ppm). CO emissions from distillate-oil-fired firetube units were low, under 0.015 lb/MMBtu (20 ppm). High levels of CO emissions from industrial boilers indicate, in part, poor burner tuning and maintenance levels for many of these units, which are often operated with little supervision and required maintenance.

Reported unburned THC emissions for residual-oil-fired boilers ranged from 0 to 0.031 lb/MMBtu (0 to 70 ppm), while for distillate-oil-fired units the range was between 0 and 0.022 lb/MMBtu (0 to 50 ppm). These are in general agreement with current AP-42 THC emission factors.

#### **4.2.3 Natural-gas-fired Boilers**

The data base compiled for this study indicated that baseline NO<sub>x</sub> emission levels for natural-gas-fired firetube boilers ranged from 0.07 to 0.13 lb/MMBtu (58 to 109 ppm). For watertube units, NO<sub>x</sub> ranged from 0.06 to 0.31 lb/MMBtu (50 to 260 ppm) for units less than or equal to 100 MMBtu/hr capacity, and from 0.11 to 0.45 lb/MMBtu (95 to 375 ppm) for units greater than 100 MMBtu/hr capacity. As shown in Table 4-4, the low end of the emission range



TABLE 4-3. COMPARISON OF COMPILED UNCONTROLLED EMISSIONS DATA WITH AP-42 EMISSION FACTORS, OIL-FIRED BOILERS

Oil type and boiler capacity	NO <sub>x</sub> <sup>a</sup> lb/MMBtu <sup>a</sup>	CO, lb/MMBtu <sup>a</sup>	THC, lb/MMBtu <sup>a</sup>
Compiled data <sup>b</sup>	AP-42	Compiled data	AP-42
<b>Residual Oil:</b>			
Firetube units	0.21-0.39	0.37	0.002-0.014
Watertube units:			
10 to 100 MMBtu/hr	0.20-0.79	0.37	0.0-0.031
>100 MMBtu/hr	0.31-0.60	0.28-0.45	0.002-0.016
<b>Distillate Oil:</b>			
Firetube units	0.11-0.25	0.14	0.012 <sup>c</sup>
Watertube units:			
10 to 100 MMBtu/hr	0.08-0.16	0.14	0.0-0.003
> 100 MMBtu/hr	0.18-0.23	N.A. <sup>d</sup>	0.001-0.009

<sup>a</sup>To convert to ppm @ 3% O<sub>2</sub>, multiply by the following: NO<sub>x</sub>, 790; CO, 1,300; THC, 2,270.

<sup>b</sup>See Appendix A for compiled data.

<sup>c</sup>Single data point.

<sup>d</sup>N.A. = Not available. No data available.

**TABLE 4-4. COMPARISON OF COMPILED UNCONTROLLED EMISSIONS DATA WITH AP-42 EMISSION FACTORS, NATURAL-GAS-FIRED BOILERS**

Boiler type and capacity	NO <sub>x</sub> , lb/MMBtu <sup>a</sup>		CO, lb/MMBtu <sup>a</sup>		THC, lb/MMBtu <sup>a</sup>	
	Compiled data <sup>b</sup>	AP-42	Compiled data	AP-42	Compiled data	AP-42
Firetube units	0.07-0.13	0.095	0.0-0.784	0.019	0.004-0.117	0.0076
Watertube units:						
≤ 100 MMBtu/hr	0.06-0.31	0.13	0.0-1.449	0.033	0.0-0.023	0.0055
> 100 MMBtu/hr	0.11-0.45	0.26-0.52	0.0-0.233	0.038	0.0-0.051	0.0016

<sup>a</sup>To convert to ppm @ 3% O<sub>2</sub>, multiply by the following: NO<sub>x</sub>, 835; CO, 1,370; THC, 2,400.

<sup>b</sup>See Appendix A for compiled data.

is well below the current AP-42 emission factors. This is due in part to emissions data obtained at reduced boiler load and emissions from smaller capacity boilers. As illustrated in Appendix A, NO<sub>x</sub> emissions from natural-gas-fired boilers tend to increase with increasing boiler capacity.

Baseline CO emission levels show wide variability, ranging from 0 to 1.45 lb/MMBtu (0 to 1,990 ppm). The data indicate that for natural-gas-fired boilers less than or equal to 100 MMBtu/hr in capacity, CO emissions are often higher than in the current AP-42 emission factors. THC emissions ranged from 0 to 0.117 lb/MMBtu (0 to 280 ppm).

#### 4.2.4 Nonfossil-fuel-fired Boilers

Table 4-5 shows AP-42 uncontrolled emission factors for wood waste-, bagasse-, and general solid waste-fired boilers. AP-42 NO<sub>x</sub> emission factors for wood-fired units are 0.27 lb/MMBtu (190 ppm), for larger boilers, and 0.065 lb/MMBtu (50 ppm), for smaller units. The limited emissions data for wood-fired boilers in Appendix A show an NO<sub>x</sub> range of 0.010 to 0.30 lb/MMBtu (7 to 220 ppm corrected to 3 percent O<sub>2</sub>). Many of these boilers operate inefficiently with very high excess air levels, at times greater than 5 times the amount required for complete combustion. Bagasse-fired boilers generally emit low levels of NO<sub>x</sub>, roughly 0.15 lb/MMBtu (105 ppm).

Boilers that burn general solid waste typically show higher NO<sub>x</sub> levels than biomass-fueled units. The current AP-42 NO<sub>x</sub> emission factors for MSW-fired units and RDF-fueled units are 0.4 to 0.49 lb/MMBtu (280 to 350 ppm) and 0.36 lb/MMBtu (250 ppm), respectively.

**TABLE 4-5. AP-42 UNCONTROLLED EMISSION FACTORS FOR NONFOSSIL-FUEL-FIRED BOILERS**

Fuel and equipment type	NO <sub>x</sub> , lb/MMBtu	CO, lb/MMBtu	THC, lb/MMBtu
<b>Wood Waste:</b>			
Units with 50,000 to 400,000 lb/hr steam output (~70 to 580 MMBtu/hr heat input)	0.27 (0.17-0.30) <sup>a</sup>	0.38-4.52	0.16
Units with less than 50,000 lb/hr steam output (<70 MMBtu/hr heat input)	0.022 (0.010-0.050) <sup>a</sup>	0.38-4.52	0.16
Bagasse	0.15	N.A. <sup>b</sup>	N.A.
<b>General Solid Waste:</b>			
Mass burn municipal solid waste	0.4	0.24	0.012
Modular municipal solid waste	0.49	0.38	N.A.
Refuse derived fuel	0.36	0.26	N.A.

<sup>a</sup>Compiled data range, Appendix A.

<sup>b</sup>N.A. = Not available. No data available.

Uncontrolled CO emissions from these boilers are relatively high, 0.24 to 0.38 lb/MMBtu (280 to 440 ppm). Table 4-6 presents a detailed breakdown of NO<sub>x</sub> emissions for municipal waste combustors (MWCs) by major equipment types. The data come from 52 combustion sources, each tested over a period of 1 to 3 hours. The average NO<sub>x</sub> level of 210 ppm corrected to 7 percent O<sub>2</sub> translates into approximately 0.4 lb/MMBtu.

Nonfossil-fuel-fired FBC boilers burning wood waste, manure, and other agricultural waste byproducts had NO<sub>x</sub> emissions ranging from 0.10 to 0.42 lb/MMBtu (70 to 300 ppm). This is lower than the coal-fired FBC emission levels because of the lower nitrogen contents of the nonfossil fuels.

AP-42 CO emission factors for all wood-fired boilers span a wide range, from 0.38 to 4.52 lb/MMBtu (440 to 5,200 ppm), due to several factors, including wood composition and boiler design type. Unburned THC emissions are significantly higher than levels measured in fossil-fuel-fired boilers. Reported AP-42 levels are 0.16 lb/MMBtu (327 ppm), on average.

**TABLE 4-6. AVERAGE NO<sub>x</sub> EMISSIONS FROM MUNICIPAL WASTE COMBUSTORS<sup>a</sup>**

Combustor type	Capacity (tons/day)	Uncontrolled NO <sub>x</sub> emissions, ppm @ 7% O <sub>2</sub>	
		Range	Average
Mass burn/refractory	56-375	59-240	155
Mass burn/rotary waterwall	100-165	146-165	156
Mass burn/waterwall	100-1,000	68-370	243
Refuse derived fuel (RDF)	300-1,000	195-345	270
Modular, excess air	50-120	105-280	140
Modular, starved air	36-90	86-280	215
All types	36-1,000	59-370	210

<sup>a</sup>Source of data: Reference 20.

#### 4.2.5 Other ICI Boilers

There are limited baseline NO<sub>x</sub> emissions data for small commercial and institutional boilers such as cast iron and tubeless units. This is due in part to the virtual lack of regulations on boilers in the capacity range below 10 MMBtu/hr (2.9 MWt), with the exception of recent rules adopted in Southern California in 1988 and 1990. Natural gas is the predominant fuel in this area for these combustion sources. Units of this capacity range, while numerous, have not historically been regulated due to their size; hence, little testing has been done to characterize their emissions.

Uncontrolled NO<sub>x</sub> emissions from natural-gas-fired TEOR steam generators range between 0.09 and 0.13 lb/MMBtu (75 and 110 ppm), while for crude-oil-fired steam generators, baseline NO<sub>x</sub> emissions generally range from 0.30 to 0.52 lb/MMBtu (240 to 400 ppm), depending on the nitrogen content of the crude oil.<sup>46,47</sup> Because there is less variability in the designs and configurations of TEOR steam generators, their NO<sub>x</sub> emissions, for a given fuel, are usually less variable than other boilers.

#### 4.3 SUMMARY

Table 4-7 summarizes baseline NO<sub>x</sub> emissions for the major ICI boiler equipment categories discussed in Chapter 3. Coal-fired cyclone boilers generally emit the highest levels

**TABLE 4-7. SUMMARY OF BASELINE NO<sub>x</sub> EMISSIONS**

Fuel	Boiler type	Uncontrolled	
		NO <sub>x</sub> range, lb/MMBtu	Average, lb/MMBtu
Pulverized coal	Wall-fired	0.46-0.89	0.69
	Tangential	0.53-0.68	0.61
	Cyclone	1.12 <sup>a</sup>	1.12
Coal	Spreader stoker	0.35-0.77	0.53
	Overfeed stoker	0.19-0.44	0.29
	Underfeed stoker	0.31-0.48	0.39
	Bubbling FBC	0.11-0.81	0.32
	Circulating FBC	0.14-0.60	0.31
Residual oil	Firetube	0.21-0.39	0.31
	Watertube:		
	10 to 100 MMBtu/hr	0.20-0.79	0.36
> 100 MMBtu/hr	0.31-0.60	0.38	
Distillate oil	Firetube	0.11-0.25	0.17
	Watertube:		
	10 to 100 MMBtu/hr	0.08-0.16	0.13
> 100 MMBtu/hr	0.18-0.23	0.21	
Crude oil	TEOR steam generator	0.30-0.52	0.46
Natural gas	Firetube	0.07-0.13	0.10
	Watertube:		
	≤ 100 MMBtu/hr	0.06-0.31	0.14
	> 100 MMBtu/hr	0.11-0.45	0.26
	TEOR steam generator	0.09-0.13	0.12
Wood	< 70 MMBtu/hr	0.010-0.050	0.022
	≥ 70 MMBtu/hr	0.17-0.30	0.24
Bagasse		0.15 <sup>b</sup>	0.15
MSW	Mass burn	0.40 <sup>b</sup>	0.40
	Modular	0.49 <sup>b</sup>	0.49

<sup>a</sup>Single data point.

<sup>b</sup>AP-42 emission factor.

of  $\text{NO}_x$ , followed by PC wall-fired units, PC tangential boilers, coal-fired stokers, MSW-burning units, and crude-oil-fired TEOR steam generators. The lowest  $\text{NO}_x$  emissions are from boilers fired on natural gas, distillate oil, and wood fuels.  $\text{NO}_x$  emissions from coal-fired FBC and stoker boilers are generally lower than from PC-fired boiler types. In general, few data are available for ICI boilers less than 10 MMBtu/hr (2.9 MWt) in thermal capacity, which includes many fossil- and nonfossil-fuel-fired firetube units, cast iron units, and tubeless types.

With the exception of distillate-oil-fired units, the data show that for a given fuel,  $\text{NO}_x$  emissions from firetube boilers are lower than from watertube boilers. This is likely due to the fact that most watertube boilers have larger capacities than firetube units. As discussed above, as boiler capacity increases,  $\text{NO}_x$  emissions also increase in most cases.

Actual emissions from individual boilers vary widely by boiler heat release rate, fuel quality and type, boiler design type, and operating factors such as excess air level or load. Fuel type is a major factor influencing baseline  $\text{NO}_x$  levels. Listed in descending order of  $\text{NO}_x$  emissions, the fuels are pulverized coal, stoker coal, MSW, crude oil, residual oil, distillate oil, natural gas, wood, and bagasse. It is important to recognize that large variations in baseline (uncontrolled)  $\text{NO}_x$  levels are possible due to several boiler design and operational factors, including variations in the chemical makeup of the fuel. The most important fuel property that influences  $\text{NO}_x$  is the fuel nitrogen content, which determines to a large degree the amount of fuel  $\text{NO}_x$  that may be formed during combustion.

#### 4.4 REFERENCES FOR CHAPTER 4

1. Evaluation and Costing of NO<sub>x</sub> Controls for Existing Utility Boilers in the NESCAUM Region. Publication No. EPA-453/R-92-010. U.S. Environmental Protection Agency. Research Triangle Park, NC. December 1992. pp. 3-5 to 3-6.
2. Yagiela, A. S., et al. (Babcock & Wilcox). Update on Coal Reburning Technology for Reducing NO<sub>x</sub> in Cyclone Boilers. Presented at the 1991 Joint Symposium on Stationary Combustion NO<sub>x</sub> Control. Washington, D.C. March 1991.
3. Evaluation and Costing of NO<sub>x</sub> Controls for Existing Utility Boilers in the NESCAUM Region. Publication No. EPA 453/R-92-010. U.S. Environmental Protection Agency. Research Triangle Park, NC. December 1992. p. 3-1.
4. Systems Evaluation of the Use of Low-Sulfur Western Coal in Existing Small and Intermediate-Sized Boilers. Publication No. EPA-600/7-78-153a. U.S. Environmental Protection Agency. Research Triangle Park, NC. July 1978. p. 30.
5. Fossil Fuel-Fired Industrial Boilers — Background Information. Publication No. EPA-450/3-82-006a. U.S. Environmental Protection Agency. Research Triangle Park, NC. March 1982. p. 3-39.
6. State of the Art Analysis of NO<sub>x</sub>/N<sub>2</sub>O Control for Fluidized Bed Combustion Power Plants. Acurex Report No. 90-102/ESD. Prepared by Acurex Corporation for the Electric Power Research Institute. Palo Alto, CA. July 1990. pp. 3-4 to 3-5.
7. Fossil Fuel-Fired Industrial Boilers — Background Information. Publication No. EPA-450/3-82-006a. U.S. Environmental Protection Agency. Research Triangle Park, NC. March 1982. p. 4-127.
8. Systems Evaluation of the Use of Low-Sulfur Western Coal in Existing Small and Intermediate-Sized Boilers. Publication No. EPA-600/7-78-153a. U.S. Environmental Protection Agency. Research Triangle Park, NC. July 1978. pp. 16 to 19.
9. Field Testing: Application of Combustion Modifications to Control Pollutant Emissions from Industrial Boilers — Phase II. Publication No. EPA-600/2-76-086a. U.S. Environmental Protection Agency. Research Triangle Park, NC. April 1976. pp. 164 to 169.
10. Industrial Boiler Combustion Modification NO<sub>x</sub> Controls, Volume I: Environmental Assessment. Publication No. EPA-600/7-81-126a. U.S. Environmental Protection Agency. Research Triangle Park, NC. July 1981. p. 3-4.
11. Evaluation and Costing of NO<sub>x</sub> Controls for Existing Utility Boilers in the NESCAUM Region. Publication No. EPA-453/R-92-010. U.S. Environmental Protection Agency. Research Triangle Park, NC. December 1992. pp. 3-1 to 3-2.

12. Field Testing: Application of Combustion Modifications to Control Pollutant Emissions from Industrial Boilers — Phase II. Publication No. EPA-600/2-76-086a. U.S. Environmental Protection Agency. Research Triangle Park, NC. April 1976. p. 218.
13. Field Testing: Application of Combustion Modifications to Control NO<sub>x</sub> Emissions from Utility Boilers. Publication No. EPA-650/2-74-066. U.S. Environmental Protection Agency. Research Triangle Park, NC. June 1974.
14. Emission Reduction on Two Industrial Boilers with Major Combustion Modifications. Publication No. EPA-600/7-78-099a. U.S. Environmental Protection Agency. Research Triangle Park, NC. June 1978.
15. Fuel Oil Manual. Industrial Press, Inc. New York, NY. 1969. p. 23.
16. Field Testing: Application of Combustion Modifications to Control Pollutant Emissions from Industrial Boilers — Phase I. Publication No. EPA-650/2-74-078a. U.S. Environmental Protection Agency. Research Triangle Park, NC. October 1974. p. 136.
17. Thirty-Day Field Tests of Industrial Boilers: Site 2 — Residual Oil-Fired Boiler. Publication No. EPA-600/7-80-085. U.S. Environmental Protection Agency. Research Triangle Park, NC. April 1980.
18. The Development of a Low NO<sub>x</sub> Burner Suitable for High Nitrogen Liquid Fuels. Prepared by Energy and Environmental Research Corporation under EPA Contract 68-02-3125. February 1981.
19. Urban, D. L., S. P. Huey, and F. L. Dryer. Evaluation of the Coke Formation Potential of Residual Fuel Oils. Paper No. 24-543. Presented at the 24th International Symposium on Combustion. Australia. 1992.
20. Municipal Waste Combustors — Background Information for Proposed Standards: Control of NO<sub>x</sub> Emissions. Publication No. EPA-450/3-89-27a. U.S. Environmental Protection Agency. Research Triangle Park, NC. August 1989. p. 2-1.
21. Fossil Fuel-Fired Industrial Boilers — Background Information. Publication No. EPA-450/3-82-006a. U.S. Environmental Protection Agency. Research Triangle Park, NC. March 1982. p. 4-128.
22. Technology Assessment Report for Industrial Boiler Applications: NO<sub>x</sub> Combustion Modification. Publication No. EPA-600/7-79-178f. U.S. Environmental Protection Agency. Research Triangle Park, NC. December 1979.
23. Industrial Boiler Combustion Modification NO<sub>x</sub> Controls, Volume I: Environmental Assessment. Publication No. EPA-600/7-81-126a. U.S. Environmental Protection Agency. Research Triangle Park, NC. July 1981. p. 3-33.
24. Ibid. p. 3-2.



25. Nonfossil Fuel-Fired Industrial Boilers — Background Information. Publication No. EPA-450/3-82-007. U.S. Environmental Protection Agency. Research Triangle Park, NC. March 1982. p. 3-21.
26. Johnson, N. H. and D. C. Reschly (Detroit Stoker Co.). MSW and RDF — An Examination of the Combustion Process. Publication No. 86-JPGC-Pwr-20. American Society of Mechanical Engineers. New York, NY. October 1986. p. 5.
27. Peavy, H. S., et al. Environmental Engineering. McGraw-Hill Publishing Company. New York, NY. 1985. p. 583.
28. Nonfossil Fuel-Fired Industrial Boilers — Background Information. Publication No. EPA-450/3-82-007. U.S. Environmental Protection Agency. Research Triangle Park, NC. March 1982. p. 3-39.
29. Municipal Waste Combustion Study. Publication No. EPA/530-SW-87-021c. U.S. Environmental Protection Agency. Washington D.C. June 1987. p. 3-4.
30. Dennis, C. B., et al. Analysis of External Combustion of Municipal Solid Waste. Publication No. ANL/CNSW-53. Argonne National Laboratory. Argonne, IL. December 1986. p. 12.
31. Composition and Properties of Municipal Solid Waste and its Components. Publication No. DOE/SF/11724-T1. U.S. Department of Energy. Oakland, CA. May 1984. p. 11.
32. Technical Support Document for a Suggested Control Measure for the Control of Emissions of Oxides of Nitrogen from Industrial, Institutional, and Commercial Boilers, Steam Generators and Process Heaters. Statewide Technical Review Group. California Air Resources Board. Sacramento, CA. April 1987. p. 36.
33. Guidelines for Industrial Boiler Performance Improvement. Publication No. EPA-600/8-77-003a. U.S. Environmental Protection Agency. Research Triangle Park, NC. January 1977. pp. 6 to 7.
34. Industrial Boiler Combustion Modification NO<sub>x</sub> Controls, Volume I: Environmental Assessment. Publication No. EPA-600/7-81-126a. U.S. Environmental Protection Agency. Research Triangle Park, NC. July 1981. pp. 3-13 to 3-68.
35. Fossil Fuel-Fired Industrial Boilers — Background Information. Publication No. EPA-450/3-82-006a. U.S. Environmental Protection Agency. Research Triangle Park, NC. March 1982. pp. 4-127 to 4-137.
36. Guidelines for Industrial Boiler Performance Improvement. Publication No. EPA-600/8-77-003a. U.S. Environmental Protection Agency. Research Triangle Park, NC. January 1977. pp. 38 to 40.

37. Field Testing: Application of Combustion Modifications to Control Pollutant Emissions from Industrial Boilers — Phase II. Publication No. EPA-600/2-76-086a. U.S. Environmental Protection Agency. Research Triangle Park, NC. April 1976. pp. 91 to 99.
38. Ibid. p. 91.
39. Industrial Boiler Combustion Modification NO<sub>x</sub> Controls, Volume I: Environmental Assessment. Publication No. EPA-600/7-81-126a. U.S. Environmental Protection Agency. Research Triangle Park, NC. July 1981. p. 3-68.
40. Fossil Fuel-Fired Industrial Boilers — Background Information. Publication No. EPA-450/3-82-006a. U.S. Environmental Protection Agency. Research Triangle Park, NC. March 1982. p. 4-117.
41. Field Testing: Application of Combustion Modifications to Control Pollutant Emissions from Industrial Boilers — Phase II. Publication No. EPA-600/2-76-086a. U.S. Environmental Protection Agency. Research Triangle Park, NC. April 1976. p. 146.
42. Compilation of Air Pollutant Emission Factors, Supplement A. Publication No. AP-42. U.S. Environmental Protection Agency. Research Triangle Park, NC. October 1986.
43. Compilation of Air Pollutant Emission Factors, Supplement B. Publication No. AP-42. U.S. Environmental Protection Agency. Research Triangle Park, NC. September 1988.
44. Compilation of Air Pollutant Emission Factors, Supplement C. Publication No. AP-42. U.S. Environmental Protection Agency. Research Triangle Park, NC. September 1990.
45. Compilation of Air Pollutant Emission Factors, Supplement D. Publication No. AP-42. U.S. Environmental Protection Agency. Research Triangle Park, NC. September 1991.
46. Hunter, S. C. and S. S. Cherry (KVB, Inc.). NO<sub>x</sub> Emissions from Petroleum Industry Operations. Publication No. 4311. Prepared for the American Petroleum Institute. Washington, D.C. October 1979.
47. Technical Support Document for a Suggested Control Measure for the Control of Emissions of Oxides of Nitrogen from Industrial, Institutional, and Commercial Boilers, Steam Generators and Process Heaters. Statewide Technical Review Group. California Air Resources Board. Sacramento, CA. April 1987. p. 45.

## 5. NO<sub>x</sub> CONTROL TECHNOLOGY EVALUATION

This chapter presents a survey of applicable control technologies to reduce NO<sub>x</sub> emissions from ICI boilers. A review of current knowledge on the effectiveness, applicability, and limitations of specific control techniques is presented for each major fuel/equipment category discussed in Chapter 3. These categories are as follows:

- Coal-fired:
  - PC, field-erected watertube
  - Stoker coal, packaged and field-erected
  - FBC
- Oil-fired:
  - Residual oil, packaged and field-erected watertube
  - Residual oil, packaged firetube
  - Distillate oil, packaged and field-erected watertube
  - Distillate oil, packaged firetube
  - Crude oil, TEOR steam generator
- Natural-gas-fired:
  - Packaged and field-erected watertube
  - Packaged firetube
- Nonfossil-fuel-fired:
  - Stoker-fed
  - FBC

NO<sub>x</sub> emissions data from more than 200 boilers were compiled from technical reports, NO<sub>x</sub> control equipment manufacturer literature, and compliance and rule development records available at California's South Coast Air Quality Management District (SCAQMD). These data are tabulated in Appendix B. Most of the data were obtained from boilers operating in the ICI sectors. However, some small utility boilers were included in the data base of Appendix B

because their heat input capacities are characteristic of large industrial boilers. The largest unit for which data are listed is a 1,250 MMBtu/hr PC-fired boiler. However, more than 90 percent of the units listed in Appendix B have heat capacities less than 400 MMBtu/hr. Most of the emissions data were obtained during short-term tests. Where noted, test data were collected from long-term tests based on 30-day continuous monitoring.

The control of NO<sub>x</sub> emissions from existing ICI boilers can be accomplished either through combustion modification controls, flue gas treatment controls, or a combination of these technologies. Combustion modification NO<sub>x</sub> controls such as SCA, LNB, and FGR modify the conditions under which combustion occurs to reduce NO<sub>x</sub> formation. Flue gas treatment controls—principally SNCR and SCR — are applied downstream of the combustion chamber and are based upon chemical reduction of already formed NO<sub>x</sub> in the flue gas. Other gas treatment controls, besides SNCR and SCR, that combine NO<sub>x</sub> and SO<sub>2</sub> reduction are being developed. However, these controls are generally expensive and are currently targeted primarily for coal-fired utility boilers. Several demonstrations of these technologies are underway at electrical power plants under the U.S. Department of Energy (DOE) Clean Coal Technology (CCT) demonstration program and other programs sponsored by industry. With the exception of reburning and SCR-based technologies, these advanced controls are not discussed here because they are not likely to be applied to the ICI boiler population in the foreseeable future.

In this section, the main discussion of NO<sub>x</sub> controls for ICI boilers is preceded by Section 5.1, which presents a brief overview of NO<sub>x</sub> formation and basic concepts for its reduction by combustion modifications. Sections 5.2, 5.3, and 5.4 discuss combustion modification NO<sub>x</sub> controls for coal-fired boilers, oil- and natural-gas-fired units, and nonfossil-fuel-fired boilers, respectively. Section 5.5 discusses flue gas treatment controls for ICI boilers.

## **5.1 PRINCIPLES OF NO<sub>x</sub> FORMATION AND COMBUSTION MODIFICATION NO<sub>x</sub> CONTROL**

NO<sub>x</sub> is formed primarily from the thermal fixation of atmospheric nitrogen in the combustion air (thermal NO<sub>x</sub>) or from the conversion of chemically bound nitrogen in the fuel (fuel NO<sub>x</sub>). Additionally, a third type of NO<sub>x</sub>, known as prompt NO, is often present, though to a lesser degree than fuel or thermal NO<sub>x</sub>. For natural gas, distillate oil, and nonfossil fuel firing, nearly all NO<sub>x</sub> emissions result from thermal fixation. With coal, residual oil, and crude oil firing, the proportion of fuel NO<sub>x</sub> can be significant and, under certain boiler operating conditions, may be predominant.

The actual mechanisms for NO<sub>x</sub> formation in a specific situation are dependent on the quantity of fuel bound nitrogen, if any, and the temperature and stoichiometry of the flame zone. Although the NO<sub>x</sub> formation mechanisms are different, both thermal and fuel NO<sub>x</sub> are promoted by rapid mixing of fuel and combustion air. This rate of mixing may itself depend on fuel characteristics such as the atomization quality of liquid fuels or the particle fineness of solid fuels.<sup>1</sup> Additionally, thermal NO<sub>x</sub> is greatly increased by increased residence time at high temperature, as mentioned earlier. Thus, primary combustion modification controls for both thermal and fuel NO<sub>x</sub> typically rely on the following control strategies:

- Decrease primary flame zone O<sub>2</sub> level:
  - Decreased overall O<sub>2</sub> level
  - Controlled (delayed) mixing of fuel and air
  - Use of fuel-rich primary flame zone
- Decrease residence time at high temperature:
  - Decreased peak flame temperature:
    - Decreased adiabatic flame temperature through dilution
    - Decreased combustion intensity
    - Increased flame cooling
    - Controlled mixing of fuel and air
    - Use of fuel-rich primary flame zone
  - Decreased primary flame zone residence time

Table 5-1 shows the relationship between these control strategies and currently available combustion modification NO<sub>x</sub> control techniques, which are categorized as either operational adjustments, hardware modifications, or techniques requiring major boiler redesign. The use of a secondary NO<sub>x</sub> reduction combustion zone is also included in the table. This strategy is based on a secondary low oxygen reducing zone where NO<sub>x</sub> is reduced to N<sub>2</sub>. This is accomplished with secondary injection of fuel downstream of the primary combustion zone. This control technique is referred to as fuel staging, or reburning, and is discussed in greater detail in the following subsections. Additionally, fuel switching is also considered a viable combustion control because of the reduction or elimination of fuel NO<sub>x</sub> with the burning or cofiring of cleaner fuels. Table 5-2 identifies combinations of NO<sub>x</sub> controls and major boiler fuel type categories for which retrofit experience is available and documented.

**TABLE 5-1. SUMMARY OF COMBUSTION MODIFICATION NO<sub>x</sub> CONTROL APPROACHES**

Primary control techniques						
NO <sub>x</sub> control approach	Control concept	Effect on thermal NO <sub>x</sub>	Effect on fuel NO <sub>x</sub>	Operational adjustments	Hardware modification	Major redesign
Decrease primary flame zone O <sub>2</sub> level	Decrease overall O <sub>2</sub> level	Reduces O <sub>2</sub> rich, high NO <sub>x</sub> pockets in the flame	Reduces exposure of fuel N intermediaries to oxygen	LEA firing and OT	FGR	Low excess air burners
	Delayed mixing of fuel and air	Flame cooling and dilution during delayed mixing reduces peak temperature	Volatile fuel N reduces to N <sub>2</sub> in absence of oxygen	Burner adjustments and timing	LNB	Optimum burner/firebox design
	Primary fuel-rich flame zone	Flame cooling in low O <sub>2</sub> , low temperature primary zone reduces peak temperature	Volatile fuel N reduces to N <sub>2</sub> in absence of oxygen	BOOS; biased burner firing	OFA ports	Burner/firebox design for SCA
Decrease peak flame temperature	Decrease adiabatic flame temperature	Direct suppression of thermal NO <sub>x</sub> mechanism	Minor	RAP	FGR, LNB, water injection	
	Decrease combustion intensity	Increased flame cooling; yields lower peak temperature	Minor direct effect; indirect effect on mixing	Load reduction	Enlarged firebox, increased burner spacing	Enlarged firebox, increased burner spacing
	Increase flame cooling; reduce residence time	Increased flame zone cooling; yields lower peak temperature	Minor	Burner tilt	WI or SI	Redesign heat transfer surface, firebox aerodynamics
Create secondary NO <sub>x</sub> reducing zone	Use of low O <sub>2</sub> secondary combustion zone	Primary zone NO <sub>x</sub> reduces to N <sub>2</sub> in absence of O <sub>2</sub>	Primary zone NO <sub>x</sub> reduces to N <sub>2</sub> in absence of O <sub>2</sub>		OFA ports	Install reburning burners, OFA ports; replace tube wall panels, piping ductwork
Fuel switching	Burn higher quality fuel with low or no nitrogen content	Minor or slight increase because of higher temperature flame	Large NO <sub>x</sub> reduction due to reduced fuel nitrogen conversion	Minor if dual-fuel capability exists		Only for installation of burner and fuel delivery system

TABLE 5-2. EXPERIENCE WITH NO<sub>x</sub> CONTROL TECHNIQUES ON ICI BOILERS

NO <sub>x</sub> control technique	Coal-fired			Oil-/natural-gas-fired			Nonfossil-fuel-fired			MSW-fired
	Field-erected PC-fired	Stoker	FBC	Field-erected watertube	Packaged watertube	Packaged firetube	Stoker	FBC	Mass burn	
BT/OT					X	X				
WI/SI					X	X				
SCA	X	X <sup>a</sup>	X	X	X <sup>b</sup>		X <sup>a</sup>	X		X <sup>a</sup>
LNB	X			X	X	X				
FGR				X	X	X				X <sup>b</sup>
NGR	X <sup>b</sup>									X <sup>b</sup>
SNCR	X <sup>b</sup>	X	X	X	X <sup>b</sup>		X	X		X
SCR	X <sup>b</sup>		X <sup>b</sup>	X <sup>b</sup>						

BT/OT = Burner tuning/oxygen trim

WI/SI = Water injection/steam injection

SCA = Staged combustion air, includes burners out of service (BOOS), biased firing, or overfire air (OFA)

LNB = Low-NO<sub>x</sub> burners

FGR = Flue gas recirculation

NGR = Natural gas reburning

SNCR = Selective noncatalytic reduction

SCR = Selective catalytic reduction

MSW = Municipal solid waste

<sup>a</sup>SCA is designed primarily for control of smoke and combustible fuel rather than for NO<sub>x</sub> control. Optimization of existing SCA (OFA) ports

can lead to some NO<sub>x</sub> reduction.

<sup>b</sup>Limited experience.

Typically, the simplest boiler operational adjustments rely on the reduction of excess oxygen used in combustion, often referred to as BT/OT. Figure 5-1 shows the results of several tests to determine the effect of excess air levels on NO<sub>x</sub> emissions from natural-gas and oil-fired firetube boilers.<sup>2</sup> These test results show that NO<sub>x</sub> emissions can be reduced 10 to 15 percent when the stack excess oxygen concentration is lowered from 5 to 3 percent, measured in the flue gas on a dry basis. The actual amount of NO<sub>x</sub> reduced by decreasing excess air varies significantly based on fuel and burner conditions. These reductions are due mainly to lower oxygen concentration in the flame, where NO<sub>x</sub> formation is highest.

Although LEA operation can produce measurable reductions in NO<sub>x</sub>, in this study, LEA will not be considered a separate control technology but a part of other retrofit technologies, since it accompanies the application of low NO<sub>x</sub> combustion hardware such as low NO<sub>x</sub> burners. Additionally, boiler operation with LEA is considered an integral part of good combustion air management that minimizes dry gas heat loss and maximizes boiler efficiency.<sup>3</sup> Therefore, most boilers should be operated on LEA regardless of whether NO<sub>x</sub> reduction is an issue. However, excessive reduction in excess air can be accompanied by significant increases in CO. As illustrated in Figure 5-2, when excess air is reduced below a certain level, CO emissions increase exponentially. This rapid increase in CO is indicative of reduced mixing of fuel and air that results in a loss in combustion efficiency. Each boiler type has its own characteristic "knee" in the CO versus excess oxygen depending on several factors such as fuel type and burner maintenance. In general, along with LEA, the application of combustion modifications that reduce NO<sub>x</sub> often result in reduced combustion efficiency (manifested by increased CO).

Another operational adjustment listed in Table 5-1, load reduction, when implemented, decreases the combustion intensity, which, in turn, decreases the peak flame temperature and the amount of thermal NO<sub>x</sub> formed. However, test results have shown that with industrial boilers, there is only slight NO<sub>x</sub> reduction available from this technique as the NO<sub>x</sub> reduction effect of lowering the load is often tempered by the increase in excess air required at reduced load.<sup>4</sup> Higher excess air levels are often required with older single-burner units because high burner velocity promotes internal gas recirculation and stable combustion. Multiple-burner boilers generally provide a greater load turndown capability. Operating at reduced load is often infeasible for many ICI boilers because steam load is dictated by process steam demands and cannot be controlled independently. Reduced load on one boiler must be compensated for by increased load on another boiler, unless energy conservation measures permit a net reduction



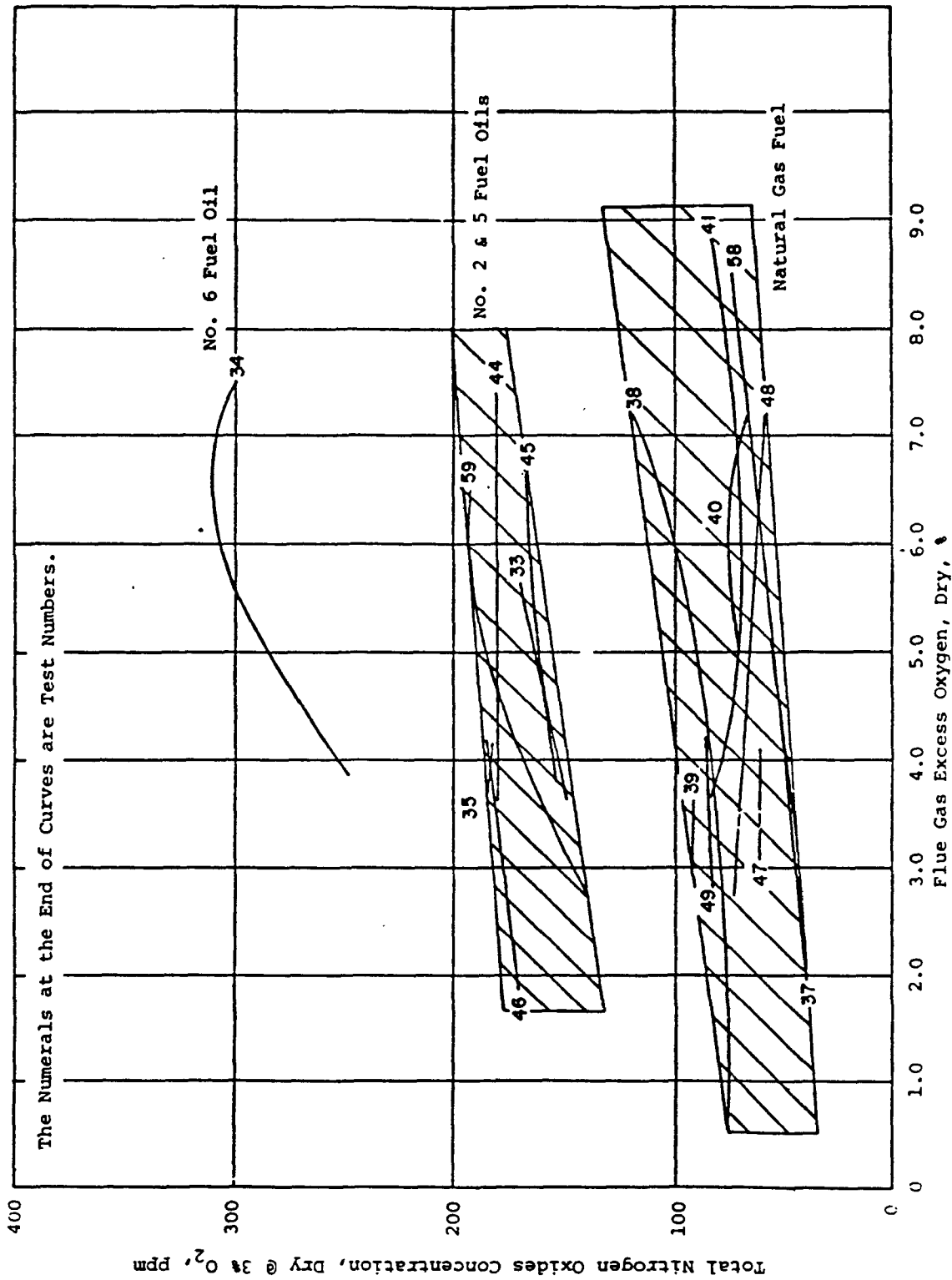
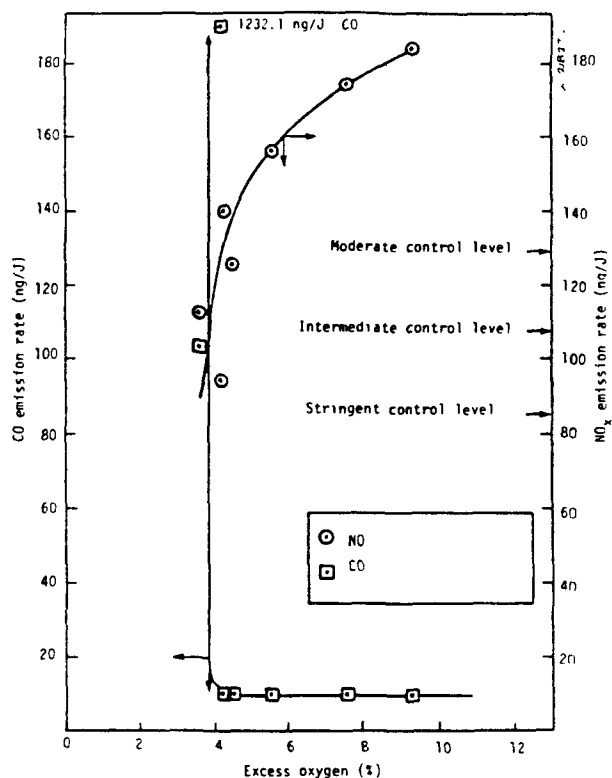

Figure 5-1. Effect of excess O<sub>2</sub> on NO<sub>x</sub> emissions for firetube boilers at baseline operating conditions, natural gas and oil fuels.<sup>2</sup>



**Figure 5-2. Changes in CO and NO<sub>x</sub> emissions with reduced excess oxygen for a residual oil-fired watertube industrial boiler.<sup>5</sup>**

in fuel consumption. Therefore, reduced load operation is not considered as a viable retrofit NO<sub>x</sub> control technology and will not be discussed further in this report.

Although the formations of fuel and thermal NO<sub>x</sub> are generally predominant, a third type of NO<sub>x</sub>, known as prompt NO, has also been reported. Prompt NO is so termed because of its early formation in the flame zone where the fuel and air first react, at temperatures too low to produce thermal NO<sub>x</sub>. C<sub>2</sub> and CH radicals present in hydrocarbon flames are believed to be the primary sources of prompt NO because they react with atmospheric nitrogen to form precursors such as HCN and NH<sub>3</sub>, which are rapidly oxidized to NO. The formation of prompt NO is greater in fuel-rich flames, and decreases with the increase in local O<sub>2</sub> concentrations.<sup>6</sup> Like fuel and thermal NO<sub>x</sub> formation, prompt NO formation has been shown to be a function of flame temperature and stoichiometry. Prompt NO, however, generally accounts for smaller levels of NO<sub>x</sub> than are due to thermal or fuel NO<sub>x</sub>. For example, in utility boiler systems, prompt NO is assumed to be less than 50 ppm, while the thermal NO<sub>x</sub> contribution can be as

high as 125 to 200 ppm.<sup>6</sup> In ICI boilers, prompt NO is believed to account for the first 15 to 20 ppm of NO<sub>x</sub> formed during combustion.<sup>7</sup> The control of prompt NO is not typically targeted because of prompt NO's minor contribution to total NO<sub>x</sub>. However, as NO<sub>x</sub> limits for ICI boilers grow stricter, especially in areas such as the South Coast Air Basin of Southern California, the control of prompt NO is gaining more importance as evidenced by the development of new techniques, such as fuel induced recirculation, as discussed in Section 5.5.

The following sections discuss retrofit NO<sub>x</sub> controls that are commercially available and the documented experience in NO<sub>x</sub> reduction performance for each major ICI boiler and fuel category mentioned earlier.

## **5.2 COMBUSTION MODIFICATION NO<sub>x</sub> CONTROLS FOR COAL-FIRED ICI BOILERS**

Coal rank plays an important role in the NO<sub>x</sub> reduction performance of combustion control technologies. Typically, controlled limits for low volatile bituminous coal differ from those attainable when burning high volatile subbituminous coal or lignites. However, the data available on coal-fired ICI boilers are insufficient to warrant a breakdown of achievable control levels based on coal type. Nearly all data compiled in this study were for boilers fired on bituminous coal. In comparison with ICI boilers fired on natural gas or oil, discussed in Section 5.3, there are relatively few reported emissions data for ICI coal-fired units operating with NO<sub>x</sub> controls. This section includes data from 18 field operating PC-fired units, 11 stoker units, and 10 field operating FBC boilers. Large PC-fired industrial boilers are similar in design to utility boilers.<sup>8</sup> Thus, control techniques applicable to many utility boilers can often be applied to large industrial boilers as well. Data from three pilot-scale PC-fired facilities are also included in Appendix B, because their firing capacities are in the ICI boiler range and test results are considered indicative of the ICI boiler population. Additionally, combustion modification tests for bubbling bed FBC (BFBC) units include results obtained at pilot-scale facilities. Pilot-scale research on retrofit combustion modification NO<sub>x</sub> control for FBC far exceeds published data on full-scale FBC installations. This is because commercial FBC boilers are relatively new, the majority having been installed after 1985, and many new units come already equipped with these controls. Little research on full-scale NO<sub>x</sub> control retrofit technologies has been undertaken. Pilot-scale research provides an in-depth view into the mechanisms of NO<sub>x</sub> formation and control in FBC. These data are used in this study to support conclusions with respect to NO<sub>x</sub> reduction efficiencies and controlled limits.

Sections 5.2.1 through 5.2.3 summarize the combustion modification techniques applicable to the three major coal-fired industrial boiler types: PC, stokers, and FBC units.

### **5.2.1 Combustion Modification NO<sub>x</sub> Controls for Pulverized Coal (PC)-fired ICI Boilers**

Table 5-3 summarizes test results of combustion modification techniques applicable to ICI PC-fired boilers. The table provides the ranges of percent NO<sub>x</sub> reduction and the controlled NO<sub>x</sub> levels achieved in these tests. More detailed data are contained in Appendix B. The following are brief discussions of each applicable control, the attained NO<sub>x</sub> reduction efficiency attained and potential operational limits and impacts of retrofit on existing ICI boilers.

#### **5.2.1.1 SCA**

One approach to reducing NO<sub>x</sub>, discussed in Section 5.1, is to decrease the primary flame zone oxygen level. The intent of SCA controls is to achieve a primary fuel-rich flame zone, where both fuel and thermal NO formations are suppressed, followed by an air-rich secondary zone where fuel combustion is completed. This is done by injecting air into the combustion zone in stages, rather than injecting all of it with the fuel through the burner. As a result, the primary flame zone becomes fuel-rich. SCA for PC-fired boilers includes two main techniques—OFA and BOOS.

OFA in PC-fired boilers typically involves the injection of secondary air into the furnace through OFA ports above the top burner level, coupled with a reduction in primary combustion airflow to the burners. OFA is applicable to both wall-fired and tangential-fired units. OFA is not applicable to cyclone boilers and other slagging furnaces because combustion staging significantly alters the heat release profile which changes the slagging rates and properties of the slag.<sup>9</sup> Additional duct work, furnace wall penetration or replacement, and extra fan capacity may be required when retrofitting boilers with OFA. To retrofit an existing PC-fired boiler with OFA involves installing OFA ports in the wall of the furnace and extending the burner windbox.

Data for two PC-fired boilers operating with and without OFA were obtained during this study. Using OFA, a 25 percent reduction in NO<sub>x</sub> was achieved at the first unit, a tangential-fired unit at the Kerr-McGee Chemical Corporation facility in Trona, California. This unit was retrofitted with a separated OFA system in conjunction with an LNB system. Separated OFA refers to the use of a separate OFA windbox mounted above but not an integral part of the main windbox, as opposed to "close coupled" OFA which is injected within the main windbox just above the top elevation of fuel. Controlled NO<sub>x</sub> emissions from this unit ranged from 211 to

**TABLE 5-3. COMBUSTION MODIFICATION NO<sub>x</sub> CONTROLS FOR FULL-SCALE PC-FIRED INDUSTRIAL BOILERS**

Control technique	Description of technique	Type of industrial boiler tested	% NO <sub>x</sub> reduction	Controlled NO <sub>x</sub> levels ppm @ 3% O <sub>2</sub> , lb/MMBtu	Comments
SCA	Fuel-rich firing burners with secondary air injection	Wall-fired	15	691 (0.93)	OFA.
		Wall-fired	27	250 (0.34)	BOOS, reduced load.
		Wall-fired	39	651 (0.88)	OFA, reduced load.
		Tangential	25	211-280 (0.29-0.38)	
LNB	Wall-fired boiler — LNB with distributed air for controlled mixing Tangential-fired boiler — uscs air on wall concept for controlled mixing	Wall-fired	49	280 (0.38)	Wall-fired boilers used staged air burners.
		Wall-fired	65	220 (0.30)	
		Wall-fired	67	190-225 (0.26-0.34)	Tangential-fired boiler used low-NO <sub>x</sub> concentric firing system (LNCFS).
		Wall-fired	49	370 (0.50)	
Tangential			18	269 (0.36)	
Reburn with SCA (OFA)	Injection of coal, natural gas, or oil downstream of the burner area	Wall-fired w/coal reburn	N.A. <sup>a</sup>	170-250 (0.23-0.34)	SCA (OFA) used with reburn in all tests.
		Wall-fired w/coal reburn	N.A.	215-385 (0.29-0.52)	
		Tangential-fired w/oil reburn	30	167 (0.23)	
LNB+SCA	Combination of LNB and SCA control techniques	Wall-fired	42	180-360 (0.24-0.49)	Data for wall-fired units do not show benefit of adding SCA to LNB.
		Wall-fired	66	220-264 (0.30-0.36)	
		Wall-fired	N.A.	220-370 (0.30-0.50)	
		Wall-fired	60	275 (0.37)	
		Wall-fired	62	275 (0.37)	
		Wall-fired	65	275 (0.37)	
		Wall-fired	44	330 (0.45)	
Tangential	55	148 (0.20)			

<sup>a</sup>N.A. = Not available. No baseline (uncontrolled) NO<sub>x</sub> data available.

Note: References, and greater detail including baseline emissions, for these data are included in Appendix B.

280 ppm<sup>a</sup> (0.29 to 0.38 lb/MMBtu); this unit was also LNB-equipped. The second unit, a 325 MMBtu/hr wall-fired boiler, achieved 15 percent NO<sub>x</sub> reduction using OFA. Controlled NO<sub>x</sub> emissions from this unit were 690 ppm (0.93 lb/MMBtu). The NO<sub>x</sub> reduction efficiencies of these two units are in agreement with OFA performance estimates for PC-fired utility boilers, which range between 15 and 30 percent NO<sub>x</sub> reduction.<sup>9,10</sup>

Two principal design requirements for the installation of OFA ports in an existing PC-fired boiler must be met in order for the technology to effectively reduce NO<sub>x</sub> without adversely affecting operation and equipment integrity. First, there must be sufficient height between the top row of burners and the furnace exit, not only to physically accommodate the OFA ports but also to provide adequate residence time for the primary stage NO to reduce to N<sub>2</sub>, and adequate residence time for the second stage gases to achieve carbon burnout before exiting the furnace. In order to maximize NO<sub>x</sub> reduction, previous studies have shown that the optimum location for OFA injection is 0.8 seconds (residence time of primary gas before OFA injection) above the top burner row.<sup>11</sup> Additionally, these studies have shown that to achieve carbon burnout, a minimum of 0.5 seconds residence time is required above the OFA ports.

The second design consideration for OFA retrofit is that good mixing of OFA with the primary combustion products must be achieved in order to ensure complete combustion and maximize NO<sub>x</sub> reduction. Some important parameters affecting the mixing of OFA and first stage gases are OFA injection velocity, OFA port size, number, shape, and location; and degree of staging.<sup>11</sup> Thus, OFA port design is critical in determining the effectiveness of OFA in reducing NO<sub>x</sub>. Additionally, OFA port design must take into account the effects of port installation on the structural integrity of the boiler walls. Structural loads may be transferred from the firing walls to the side walls of the furnace, and OFA port shapes may be designed to minimize structural modifications. Given the magnitude of retrofitting PC-fired boilers with OFA and the moderate NO<sub>x</sub> reduction efficiencies of 15 to 30 percent, OFA does not appear to be a primary retrofit technology for industrial sized PC-fired boilers. In general, the use of OFA is considered more feasible for new boilers than for retrofit applications.

The second major technique of staging combustion is BOOS, in which ideally all of the fuel flow is diverted from a selected number of burners to the remaining firing burners, keeping firing capacity constant. For maximum effectiveness, it is often the case that the top row of

---

<sup>a</sup>All ppm values in this study are referenced to 3 percent O<sub>2</sub>.

burners be set on air only, mimicking the operation of OFA discussed above (Figure 5-3). For PC-fired boilers, this means shutting down the pulverizer (mill), as fuel flow cannot be shut off at the individual burners as can be done with oil- and gas-fired units. This sometimes presents a problem when pulverizers serve burners located on two separate levels. With PC-firing, BOOS is commonly considered more of an operating practice for pulverizer maintenance than for NO<sub>x</sub> control, as pulverizers are routinely taken out of service because of maintenance requirements. The ability of boilers to operate units with one less pulverizer is generally very limited. For this reason, BOOS is not a popular control option for PC-fired units.

Data for two wall-fired units operating with one pulverizer out of service show NO<sub>x</sub> reduction efficiencies of 27 and 39 percent. For one 230 MMBtu/hr boiler, NO<sub>x</sub> was reduced from 340 ppm to 250 ppm (0.46 to 0.34 lb/MMBtu), while for a 260 MMBtu/hr unit, NO<sub>x</sub> was reduced from 1,065 ppm to 651 ppm (1.44 to 0.88 lb/MMBtu).<sup>12</sup> However, in order to achieve the 39 percent reduction rate with the larger boiler, it was necessary for that particular boiler to be operated at 50 percent load reduction. Additionally, airflow could not be easily controlled to the individual burners so that burner swirl and coal air mixing were affected.<sup>12</sup> Operating at reduced load when using BOOS is often required for industrial sized units due to the limited number of burners and pulverizers.

In summary, data from three wall-fired boilers operating with SCA techniques of OFA and BOOS showed NO<sub>x</sub> reduction ranges of 15 to 39 percent, while the single tangential-fired boiler with SCA showed 25 percent reduction (see Table 5-3). Although the two units operated with BOOS accounted for the higher NO<sub>x</sub> reduction efficiencies of 27 and 39 percent, both had to be operated at significantly reduced load. Because industrial units have fewer burners and typically have more limited pulverizer-burner arrangements, BOOS is not considered a widely applicable control technique.

#### **5.2.1.2 LNBS for PC-fired Boilers**

LNBS, principally designed for utility boiler applications, have also been retrofitted to several large industrial boilers over the past decade. All major manufacturers of utility type boilers offer LNB for PC firing. Some of the larger manufacturers are ABB-Combustion Engineering, Babcock & Wilcox, Foster Wheeler, and Riley Stoker. In order to achieve low NO<sub>x</sub> levels, LNBS basically incorporate into their design combustion techniques such as LEA, SCA, or recycling of combustion products. One of the most common types of LNB is the staged air burner.

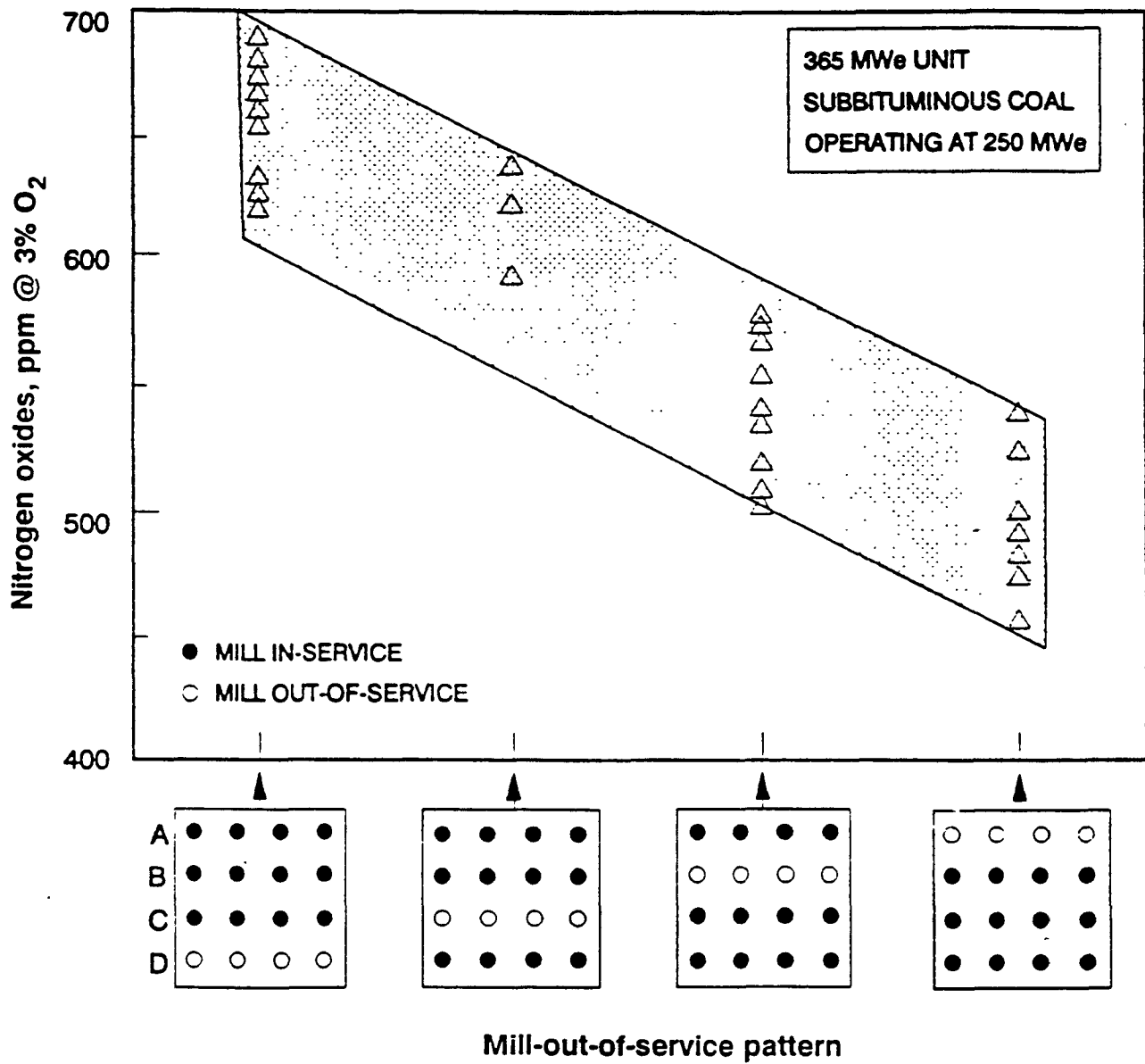

Figure 5-3. Effect of BOOS on emissions.



Air staging in this type of LNB is accomplished by dividing the combustion air into two or more streams within the burner, delaying the mixing of fuel and air. A portion of the air is used to create a fuel-rich primary combustion zone where the fuel is only partially combusted. Secondary combustion of this unburned fuel occurs downstream of the primary burnout zone, where the remainder of burner air is injected. Peak combustion temperatures are also lower with the staged air burner because flames are elongated and some heat from the primary combustion stage is transferred to the boiler tubes prior to the completion of combustion. As discussed in Section 5.1,  $\text{NO}_x$  formation is reduced due to the lowering of the peak flame temperature, the delayed air/fuel mixing, and the low oxygen primary zone, where volatile fuel bound nitrogen compounds reduce to form  $\text{N}_2$ . Thus, both thermal and fuel  $\text{NO}_x$  are reduced.

One example of a staged air LNB is Foster Wheeler's Controlled Flow/Split Flame (CF/SF) LNB, which has been retrofitted to at least two industrial units. The CF/SF burner, shown in Figure 5-4, is an internally staged dual register burner. The outer register, where secondary air is injected, controls the overall flame shape while the inner register controls ignition at the burner throat and the air/fuel mixture in the primary substoichiometric region of the flame.<sup>13</sup> The newer version of the CF/SF burner also incorporates a split flame nozzle that forms four distinct coal streams. The result is that volatiles are driven off and are burned under more reducing conditions than would occur without the split flame nozzle.<sup>9</sup> CF/SF burners have been retrofitted to a 110,000 lb (steam)/hr (about 140 MMBtu/hr heat input) single wall-fired boiler at a Dupont chemical plant in Martinsville, Virginia. This unit, fired on bituminous coal, utilizes four CF/SF burners. Nearly 50 percent  $\text{NO}_x$  reduction was achieved, with average post-retrofit  $\text{NO}_x$  emissions of 280 ppm (0.38 lb/MMBtu). Post-retrofit CO emissions were 25 ppm. CF/SF burners were also retrofitted to a 125,000 lb/hr (about 150 MMBtu/hr heat input) four-burner, wall-fired steam boiler, where 65 percent  $\text{NO}_x$  reduction from baseline was achieved. Post-retrofit  $\text{NO}_x$  emissions at this site averaged 220 ppm (0.30 lb/MMBtu).<sup>10</sup> Figure 5-5 shows the  $\text{NO}_x$  reduction performance of these two units—labeled as numbers 4 and 5 in the figure—as well as several utility sized boilers.

Babcock & Wilcox's DRB-XCL burner also utilizes dual registers to achieve internal staged combustion. The major elements of this burner are its use of a conical diffuser to disperse the fuel, which produces a fuel-rich ring near the walls of the nozzle and a fuel-lean core. Reducing species are formed by partial oxidation of coal volatiles from primary air and limited secondary air. The reducing zone created in the fuel-lean core prevents  $\text{NO}_x$  formation

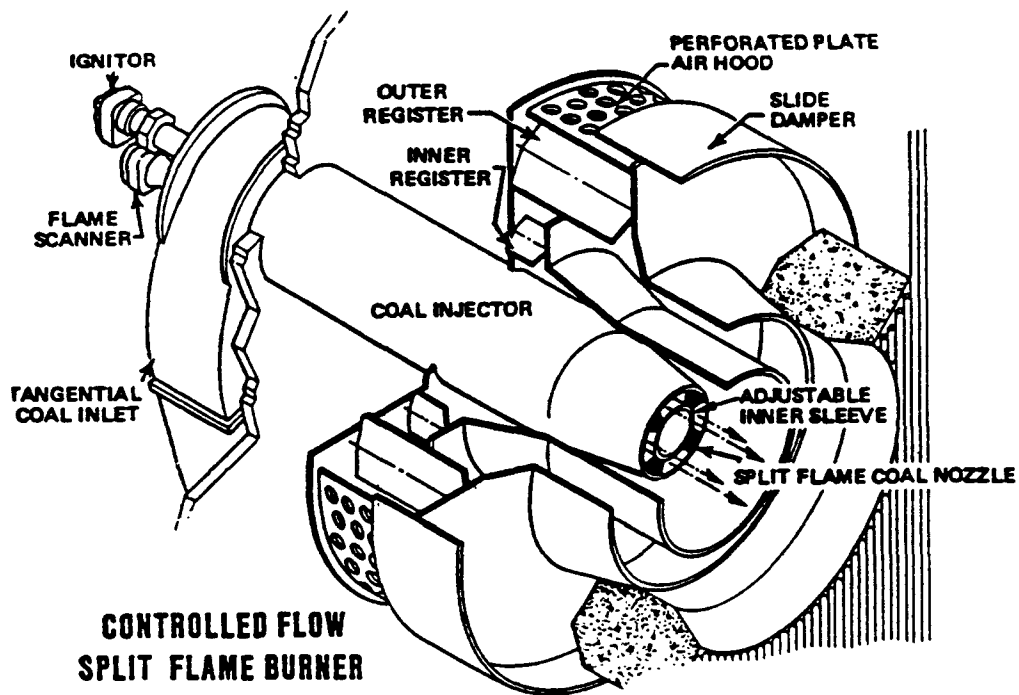

Figure 5-4. Foster Wheeler CF/SF LNB.<sup>9</sup>

- |                             |                             |
|-----------------------------|-----------------------------|
| (1) 800 MW Four Corners #4  | (4) 110,000 Lb/Hr. 4 Burner |
| (2) 626 MW Pleasants #2     | (5) 125,000 Lb/Hr. 4 Burner |
| ○ 275 MW Front Wall Fired   | (6) CETF                    |
| (3) 360 MW Front Wall Fired | (7) 500 MW Opposed Fired    |
| ● 525 MW Opposed Fired      |                             |

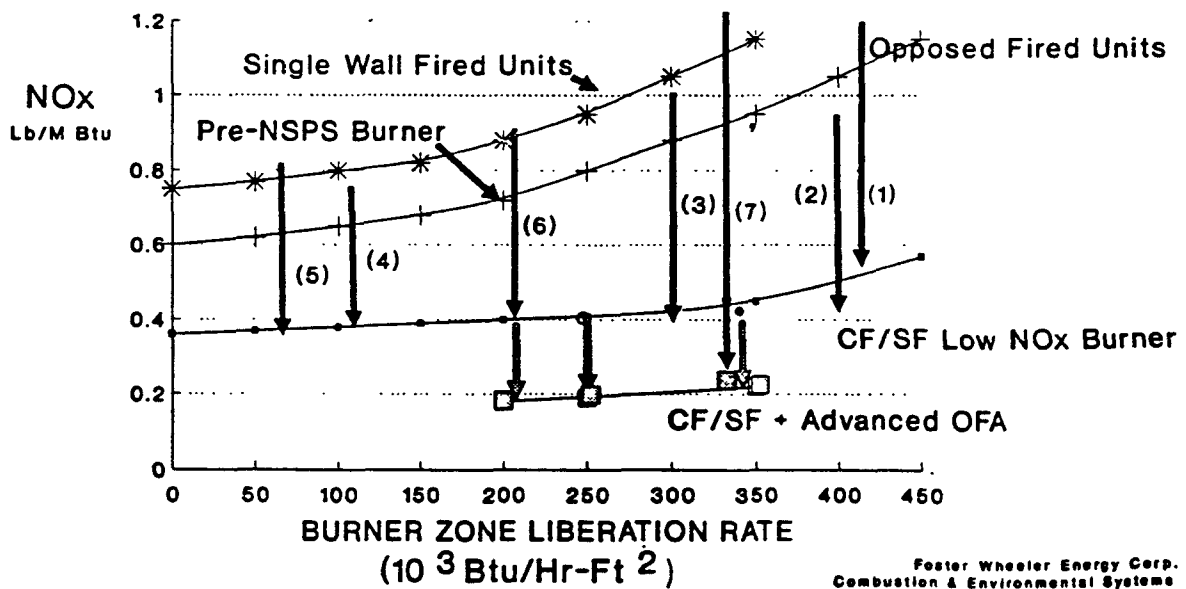

Figure 5-5. Performance of CF/SF LNB.<sup>10</sup>

during devolatilization, and the reducing species generated by oxidation decompose the formed  $\text{NO}_x$  as combustion continues.<sup>14</sup> In a DRB-XCL burner retrofit program to a 220,000 lb/hr (about 275 MMBtu/hr heat input) wall-fired boiler at the Neil Simpson Power Station in Wyoming, average  $\text{NO}_x$  emissions were reduced approximately 67 percent, when operating at the same excess air level. Controlled  $\text{NO}_x$  emissions for this unit ranged between 190 and 255 ppm (0.26 and 0.34 lb/MMBtu).<sup>15</sup>

Riley Stoker also manufactures a LNB for PC wall-fired units, known as the Controlled Combustion venturi (CCV™) burner. Figure 5-6 depicts this burner, which uses a single register, unlike the dual register burners already discussed. The key element of this burner design is a patented venturi coal nozzle and low swirl coal spreader located in the center of the burner. The venturi nozzle concentrates fuel and air in the center of the coal nozzle, creating a fuel-rich zone. As in the CF/SF LNB, the coal/air mixture is divided into four distinct streams which then enter the furnace in a helical pattern. This produces very slow mixing of the coal with secondary air, which is injected through the single register. Devolatilization of the coal in the fuel-rich mixture occurs at the burner exit in a substoichiometric primary combustion zone, resulting in lower fuel  $\text{NO}_x$  formation. Thermal  $\text{NO}_x$  formation is suppressed by the reduction of peak flame temperature which results from the staged combustion.<sup>16</sup>

Riley's Tertiary Staged Venturi (TSV) burner is similar to the CCV burner but uses additional tertiary air and an advanced air staging (OFA) system for reducing  $\text{NO}_x$  emissions. This burner was developed for use on Riley's TURBO furnaces as well as downfired and arch fired boilers. These boilers are characterized by downward tilted burner firing, which lengthens the residence time of combustion products in the furnace. As such, the inherently long furnace retention time combined with gradual or distributed air/fuel mixing typically results in lower  $\text{NO}_x$  emissions than a conventional wall-fired unit operating at similar conditions with identical fuel.<sup>16</sup> TURBO furnaces are commonly used to burn low volatile coals such as anthracite, which require longer residence time for complete combustion. Figure 5-7 shows a schematic of a TURBO furnace and the TSV LNB. Six TSV burners, in conjunction with OFA, were used in a 400,000 lb/hr (about 470 MMBtu/hr heat input) industrial TURBO furnace at a paper manufacturing facility in the Midwest. Firing bituminous coals, controlled  $\text{NO}_x$  emissions ranged between 220 and 370 ppm (0.30 and 0.50 lb/MMBtu).<sup>17</sup>

A different type of LNB has been developed for tangential-firing PC boilers, incorporated into the LNCFS system. The burner itself, manufactured by ABB Combustion

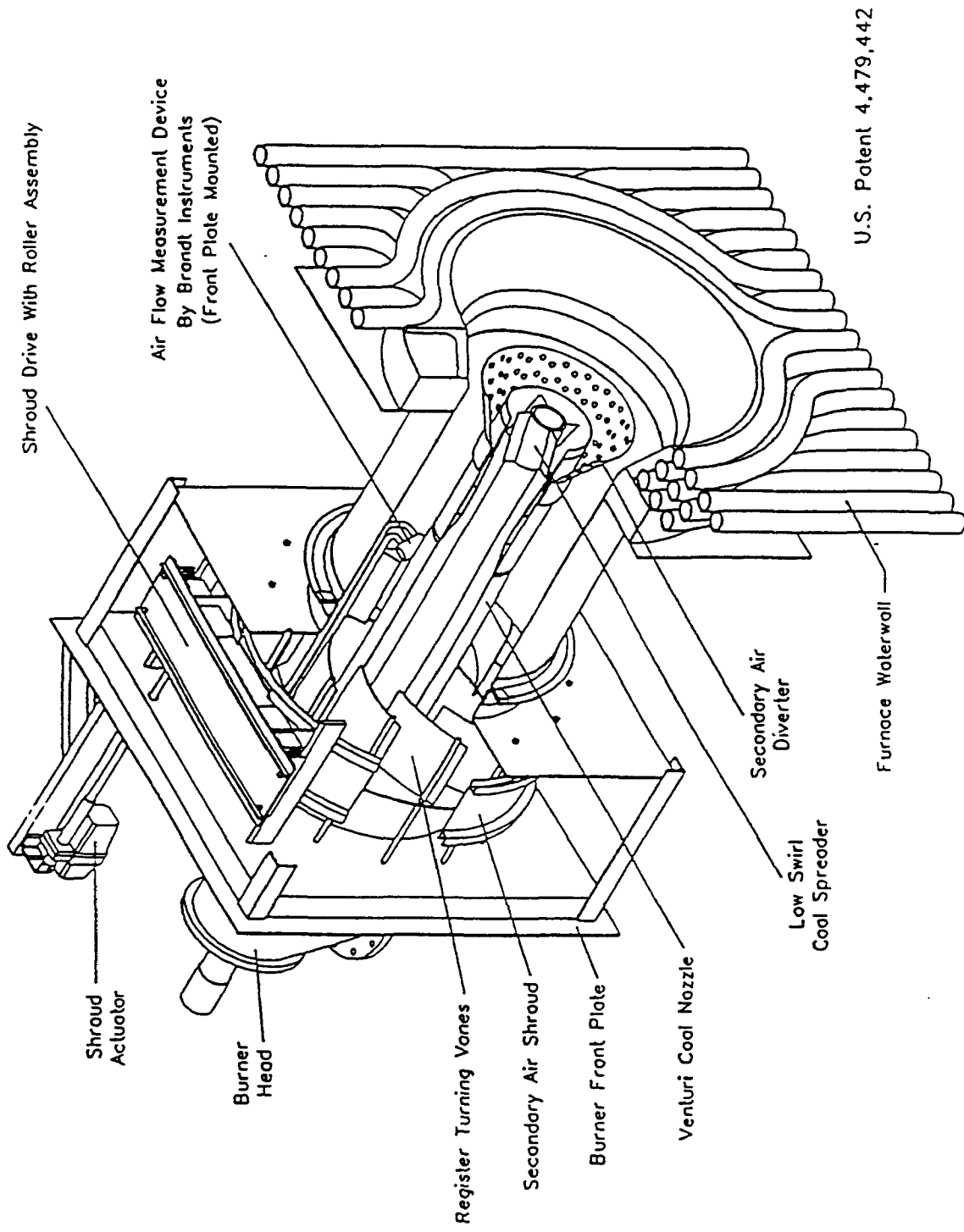

U.S. Patent 4,479,442

Figure 5-6. Riley low-NO<sub>x</sub> CCV™ burner with secondary air diverter.16

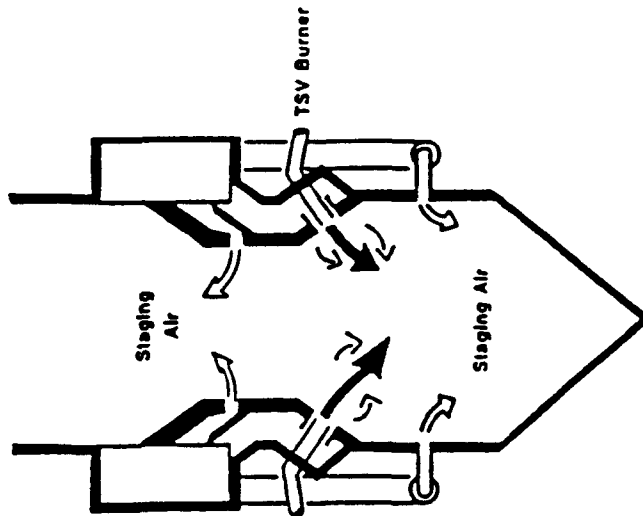

*Advanced TURBO Furnace Staging System*

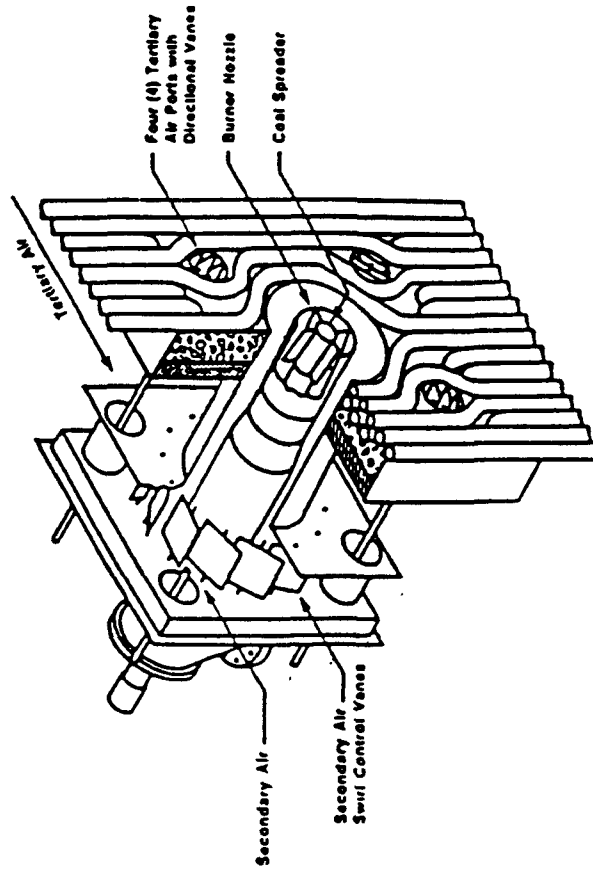

*TSV Burner*

**Figure 5-7. Riley low-NO<sub>x</sub> TSV burner with advanced air staging for turbo-furnace, down-fired and arch-fired installation. 16**

Engineering, is referred to as the Concentric Firing System (CFS). The CFS creates local staging by diverting a portion of secondary air horizontally away from the coal stream toward the furnace waterwall tubes. This delays the mixing of secondary air with the coal during the initial coal devolatilization stage of the combustion process, the stage when significant amounts of fuel nitrogen are typically released. Early ignition and devolatilization are achieved by using flame attachment coal nozzle tips. This early ignition and flame attachment feature provides greater control over volatile matter flame stoichiometry while enhancing flame stability and turndown.<sup>18</sup> The boiler at Kerr-McGee Chemical, mentioned in the above discussion on OFA, has been retrofitted with the LNCFS. Operating with the CFS LNB only, 18 percent NO<sub>x</sub> reduction was achieved, to 269 ppm (0.36 lb/MMBtu). When the full LNCFS was used (CFS+OFA), NO<sub>x</sub> reduction improved to 55 percent, with NO<sub>x</sub> at 148 ppm or 0.20 lb/MMBtu.<sup>18</sup>

The LNBs discussed were originally designed for use on utility boilers. However, as evidenced by the above industrial experiences, in most cases the burners are also applicable to larger industrial PC-fired boilers. In some cases, as with the Neil Simpson unit retrofitted with B&W DRB-XCL burners, modifications to the burner walls were necessary to accommodate the larger LNBs. Furnace wall openings of the Neil Simpson unit were enlarged by replacing two furnace wall tube panels, each containing two burner throats.<sup>15</sup> In general, however, because there are already existing burner ports, LNB retrofits to PC-fired units do not require as much rework of the furnace walls as does installation of new OFA ports. However, significant modifications may be required for the windbox in order to improve air distribution with changes in the fuel ducting. Consideration must also be given to LNB flame characteristics such as shape and length to avoid flame impingement on the furnace walls. Because flames from staged combustion burners are often longer than from conventional burners, this may be a particularly important issue to small-volume furnaces.

NO<sub>x</sub> emissions data for PC-fired units with LNB are summarized in Table 5-3. For four wall-fired units, NO<sub>x</sub> reductions ranged between 49 and 67 percent, with controlled NO<sub>x</sub> emissions of 190 to 370 ppm (0.26 to 0.50 lb/MMBtu). One tangential-fired unit experienced 18 percent reduction efficiency, with an NO<sub>x</sub> level of 269 ppm (0.36 lb/MMBtu). Again, the minimum long-term NO<sub>x</sub> level that can be reached with LNB retrofit depends on several factors, principally coal type, furnace dimension, boiler load, combustion air control, and boiler operating practice.

### 5.2.1.3 Reburn (Fuel Staging) with SCA, PC-fired Boilers

Reburning, also known as fuel staging, involves injecting a supplemental fuel into the main furnace above the primary combustion zone to produce a secondary combustion zone where a reducing atmosphere exists. The general idea is to provide a chemical path for the primary zone NO to convert to N<sub>2</sub> rather than NO<sub>2</sub>. Hydrocarbon radicals formed during secondary combustion provide this chemical path; hence, some of the NO<sub>x</sub> created in the primary combustion zone is reduced to molecular nitrogen. OFA is utilized in conjunction with reburning to complete combustion of supplemental fuel. Domestic experience in the ICI sector is nonexistent.

Reburning has been chiefly developed and applied to larger industrial boilers in Japan. Mitsubishi Heavy Industries (MHI) has developed the Mitsubishi Advanced Combustion Technology (MACT) process utilizing oil as the reburn fuel. Use of MACT in a 700,000 lb/hr (about 825 MMBtu/hr heat input) tangential-fired boiler at Taio Paper Company in Japan resulted in a 30-percent NO<sub>x</sub> reduction to a level of 167 ppm (0.23 lb/MMBtu), during bituminous coal firing.<sup>19</sup> MACT has been used in at least eight other wall or tangential coal-fired industrial boilers in Japan, with capacities ranging between 170 and 200 MMBtu/hr. In the United States, except for several utility demonstration projects and pilot scale test programs, reburning has not been applied to any commercial facility.<sup>20</sup> The results from one pilot-scale test are included in Appendix B—a test conducted at the 6 MMBtu/hr B&W Small Boiler Simulator facility.

This test analyzed the NO<sub>x</sub> reduction efficiencies of reburning in a cyclone furnace with three types of fuel—bituminous coal, residual oil, and natural gas. With the main burners of the furnace firing bituminous coal, NO<sub>x</sub> reduction efficiencies of 54 to 65 percent were achieved.<sup>21</sup> Results showed that reburning with natural gas produced the best NO<sub>x</sub> reduction and the lowest average NO<sub>x</sub> emissions, between 235 and 420 ppm (0.32 and 0.57 lb/MMBtu). This was due to the low nitrogen content of natural gas. Use of natural gas as the reburning fuel also brings the added benefit of reducing SO<sub>2</sub> emissions. The use of coal as a reburn fuel resulted in the lowest NO<sub>x</sub> removal efficiency. In general, the data suggest that the cleaner the reburn fuel, the more efficient the reburn process.

Prior to this pilot test, B&W had conducted a feasibility study of applying natural gas reburn technology to cyclone-fired boilers. Cyclone boilers are currently being used in both the utility and industrial sectors. Because cyclone boilers have a unique configuration that prevents

the application of standard low-NO<sub>x</sub> burner technology—combustion occurs within a water-cooled horizontally-tilted cylinder attached to the outside of the furnace—this study sought to assess the feasibility of retrofitting existing cyclone furnaces with reburn controls. Reburning technology prior to the pilot scale test had never been applied to cyclone-equipped boilers. From an industrial boiler standpoint, the most important result of this study was the conclusion that in general, it is unfeasible to retrofit cyclone boilers below 80 MWe capacity with natural gas reburn controls, which essentially excludes all but the largest industrial cyclones.<sup>16</sup> The reason for this is that cyclone units below this size range generally have insufficient furnace height to allow sufficient residence time for reburn and OFA to work effectively. For a 41 MWe boiler, it was determined that the furnace would have to be extended by over 50 percent, which is impractical.<sup>16</sup> From this study, it appears that gas reburn is most applicable to larger existing cyclone boilers.

Thus, reburn technology is generally not applicable for retrofit to smaller cyclone boilers in the ICI sector because of insufficient furnace heights. For wall-fired and tangential-fired units, however, natural gas or coal reburn may emerge as a viable NO<sub>x</sub> control technique for industrial PC-fired units as indicated by utility demonstrations.

#### 5.2.1.4 LNB with SCA

The use of LNBs with SCA (OFA) in PC-fired boilers combines the effects of staged burner combustion and staged furnace combustion. ABB-CE, B&W, and Foster Wheeler offer OFA with LNB systems for retrofit. OFA is an integral part of ABB-CE's LNCFS NO<sub>x</sub> reduction package for tangential-fired boilers, and in fact is responsible for the majority of NO<sub>x</sub> reduction achieved.<sup>18</sup> As mentioned earlier, in the Kerr-McGee boiler in California, 55 percent NO<sub>x</sub> reduction was achieved with the LNCFS, combining OFA and the CFS LNB. Note that the NO<sub>x</sub> reduction efficiencies for combined control techniques are not additive.

Emissions data for seven wall-fired units using LNB and SCA controls show NO<sub>x</sub> reductions in the range of 42 to 66 percent (see Table 5-3). No baseline data were reported, however, for one of the seven units. This reduction range reflects LNB and SCA performance for six boilers. The 66 percent reduction efficiency was obtained on an industrial size 250 MMBtu/hr unit at Western Illinois Power Cooperative's (WIPCO) Pearl Station. Field tests showed that under normal operation, 50 percent reduction of NO<sub>x</sub> was typically achieved while under carefully controlled conditions, the 66 percent NO<sub>x</sub> reduction level was possible. Retrofit of four distributed mixing burners with tertiary air ports required replacement of the front wall,



modifications to the windbox, replacement of the burner management system, and provision of an alternative support structure for the hopper.<sup>22</sup> Because of the extensive boiler modification required for this particular LNB+SCA system, it is generally intended for use in new boiler designs rather than in retrofit applications.

Controlled NO<sub>x</sub> levels for these wall-fired units ranged between 180 and 370 ppm (0.24 and 0.50 lb/MMBtu). Generally, on utility boilers, NO<sub>x</sub> reduction performance for this combination of controls can reach as high as 65 or 70 percent.<sup>23</sup> Thus, for large (greater than 250 MMBtu/hr) industrial boilers, this may be the maximum reduction achievable as well. However, insufficient data for PC-fired ICI boilers using LNB and SCA precludes reaching any definitive conclusions.

### **5.2.2 Combustion Modification NO<sub>x</sub> Controls for Stoker Coal-fired ICI Boilers**

The two most commonly used combustion modification NO<sub>x</sub> controls for stoker coal-fired ICI boilers are SCA and FGR. A third combustion modification, RAP, has not been utilized as often. Gas cofiring with burners above the grate is under active evaluation. Table 5-4 summarizes the data compiled for stoker coal-fired ICI boilers with combustion modification NO<sub>x</sub> controls. Available data are limited to 12 stoker units. The data show wide variability in NO<sub>x</sub> control efficiency, ranging from -1 to 60 percent reduction. Controlled NO<sub>x</sub> levels for spreader stokers with SCA ranged from 230 to 387 ppm (0.31 to 0.52 lb/MMBtu), while for spreaders with FGR+SCA, NO<sub>x</sub> ranged from 140 to 350 ppm (0.19 to 0.47 lb/MMBtu). Data were available for only one spreader unit with RAP. This unit had a controlled NO<sub>x</sub> level of 219 ppm (0.30 lb/MMBtu).

#### **5.2.2.1 SCA**

Stoker units naturally operate with a form of staged combustion due to their design. As the coal is fed onto the grate, volatile matter is driven from the fuel bed and burned above the bed level. The coal solids remaining are subsequently burned on a bed with lower combustion intensity. Because of this natural staging, NO<sub>x</sub> emissions from stoker units are generally lower than those from PC-fired units of the same size.<sup>24</sup> As presented in Appendix A, uncontrolled NO<sub>x</sub> emissions ranged from 341 to 659 ppm (0.46 to 30.89 lb/MMBtu) during nine tests of PC wall- and tangential-fired units ranging in size from 100 to 200 MMBtu/hr. For eight tests of similarly sized stoker units, uncontrolled NO<sub>x</sub> levels ranged from 158 to 443 ppm (0.21 to 0.60 lb/MMBtu).

**TABLE 5-4. COMBUSTION MODIFICATION NO<sub>x</sub> CONTROLS FOR STOKER COAL-FIRED INDUSTRIAL BOILERS**

Control technique	Description of technique	Type of Stoker boiler tested	% NO <sub>x</sub> reduction	Controlled NO <sub>x</sub> levels ppm @		Comments
				3% O <sub>2</sub> , lb/MMBtu	ppm @	
SCA	Reduction of combustion air under the grate and increase of overfire air flow	Spreader	6	350 (0.47)		Danger of grate overheating, clinker formation, corrosion, high CO emissions.
		Spreader	10	353 (0.48)		
		Spreader	26	237 (0.32)		
		Spreader	31	263 (0.36)		
		Spreader	35	369 (0.50)		
		Spreader	N.A. <sup>a</sup>	230-387 (0.31-0.52)		
FGR+SCA	Recirculation and mixing of stack flue gas with the undergrate or overgrate combustion air	Overfeed	-1	166 (0.22)		FGR primarily leads to NO <sub>x</sub> reduction by lowering achievable excess O <sub>2</sub> .
		Overfeed	N.A.	172-202 (0.23-0.27)		
		Spreader	0	300-345 (0.41-0.47)		
		Spreader	13	350 (0.47)		
		Spreader	60	140 (0.19)		
		Spreader	32	219 (0.30)		
RAP	Reduce temperature of preheated combustion air	Spreader	25	170 (0.23)		Limited applicability to larger units with air preheaters. Reduces boiler efficiency.
Gas cofiring	Achieves lower NO <sub>x</sub> with reduced excess air	Spreader	25	170 (0.23)		Applicable to all types of stokers. Cofiring 5 to 40 percent gas possible.

<sup>a</sup>N.A. = Not available. No baseline (uncontrolled) NO<sub>x</sub> data available.  
 Note: All test data were obtained from short-term tests.

The availability of existing OFA ports offers the opportunity for increased air staging. Additional staging can be achieved by injecting more overfire air above the fuel bed while reducing the undergrate airflow. Using OFA, the boilers for which data were collected show a NO<sub>x</sub> reduction range of zero to 35 percent, averaging 17 percent reduction. In two boilers, OFA did not affect NO<sub>x</sub>. Controlled NO<sub>x</sub> emissions ranged from 230 to 400 ppm (0.31 and 0.54 lb/MMBtu) for the spreader stokers tested and 166 to 202 ppm (0.22 to 0.27 lb/MMBtu) for the overfeed stokers. No data were collected for underfeed stoker type boilers in this study.

Many older stokers incorporate OFA ports as smoke control devices. Therefore, these OFA ports may not be optimally located for NO<sub>x</sub> control purposes. For example, in one test, injection of OFA through oil burner ports high above the grate reduced NO<sub>x</sub> by 25 percent. When OFA was injected through the actual OFA ports located closer to the grate, only 10 percent reduction was achieved.<sup>25</sup>

Because the use of SCA in stoker boilers requires reduced undergrate air flow for staging, there are certain operational limitations involved. First, with the exception of a water-cooled vibrating grate, the only grate cooling mechanism used in stoker units is the flow of combustion air under the grate. During SCA operation, if undergrate air is lowered too much, the grate can overheat. There is also the possibility of creating local reducing zones with low oxygen which may form harmful corrosion products.<sup>25</sup> Still another problem that may arise from reduced undergrate air firing is the formation of clinkers. For coals with low ash fusion temperatures, significant clinker formation can be caused by the excessively high bed temperatures resulting from combustion with insufficient amounts of excess air.<sup>26</sup> Thus, a minimum amount of undergrate air must be used to provide adequate mixing and cooling. As such, there is a limit to the degree of OFA used in stoker boilers and consequently achievable NO<sub>x</sub> reduction.

#### **5.2.2.2 FGR with SCA**

The requirements of mixing and cooling when using SCA can be met to a certain degree by recirculating a portion of the flue gas to the furnace and mixing it with the fresh combustion air. One effect of FGR in stoker units is that recirculated flue gas dilutes the oxygen concentration of the combustion air, allowing boiler operators to lower the overall excess air level which consequently reduces formation of NO<sub>x</sub>. FGR is primarily considered a thermal NO<sub>x</sub> control technique, reducing NO<sub>x</sub> by lowering the peak furnace temperature. Because

temperatures in ICI stoker units are lower than in PC-fired units, thermal NO<sub>x</sub> control has not been as high a priority for stoker coal-fired boilers.

Figure 5-8 depicts a schematic of a stoker boiler equipped with FGR. Flue gas is drawn from the entrance of the stack and mixed with the undergrate combustion air. This type of FGR system was used in a 100,000 lb/hr (125 MMBtu/hr heat input) spreader stoker fired on bituminous coal. Test results from this boiler illustrate the effect of FGR on allowable excess oxygen and consequently, its effects on NO<sub>x</sub>. In this unit, minimum excess oxygen levels and boiler load were restricted by opacity. To prevent opacity from reaching unacceptable levels, pre-retrofit load was limited to 80 percent of capacity and the boiler was operated at minimum stack excess oxygen of 8 percent. Figure 5-9 illustrates the effect of adding FGR to the boiler on allowable excess oxygen. After retrofit, boiler operators could lower excess oxygen levels to as low as 3 percent, keeping opacity the same as pre-retrofit levels. Not only does this represent a significant increase in boiler efficiency, but because NO<sub>x</sub> is dependent on the excess oxygen used, lower emission levels were achieved, as shown in Figure 5-10. Thus, at a constant load of 80 percent, using FGR allowed the excess oxygen level to be reduced from 8 percent to approximately 3.5 percent, resulting in a reduction of NO<sub>x</sub> by as much as 60 percent. A controlled emission level of 140 ppm (0.19 lb/MMBtu) was measured.<sup>27</sup> Another spreader stoker unit also displayed similar characteristics when operated with FGR, experiencing 13 percent NO<sub>x</sub> reduction. Less reduction was achieved in this unit because excess air was not reduced as much.<sup>26</sup> In a third spreader stoker, however, no NO<sub>x</sub> reduction was achieved using FGR, since initial excess oxygen levels were already quite low at 4 percent. FGR did not allow the boiler operators to reduce oxygen concentration, thus resulting in no measurable change in NO<sub>x</sub> emissions.<sup>26</sup>

FGR was also applied to an overfeed stoker, but test results showed the use of FGR on this boiler to be unsatisfactory. Unlike spreader stokers which utilize the entire length of the grate for primary combustion, overfeed stoker units often have shorter active grate combustion zones depending on the location of the furnace wall arch over the grate, as shown in Figure 5-11. The particular boiler tested had a very short active combustion zone limited to the front half of the grate, due to the location of its furnace arch. The lowering of excess oxygen in the combustion air with FGR caused the active combustion zone to lengthen beyond the furnace arch, resulting in flame quenching and impingement on the arch. Also, FGR caused unstable combustion at the front portion of the active combustion zone.<sup>26</sup> In contrast with overfeed

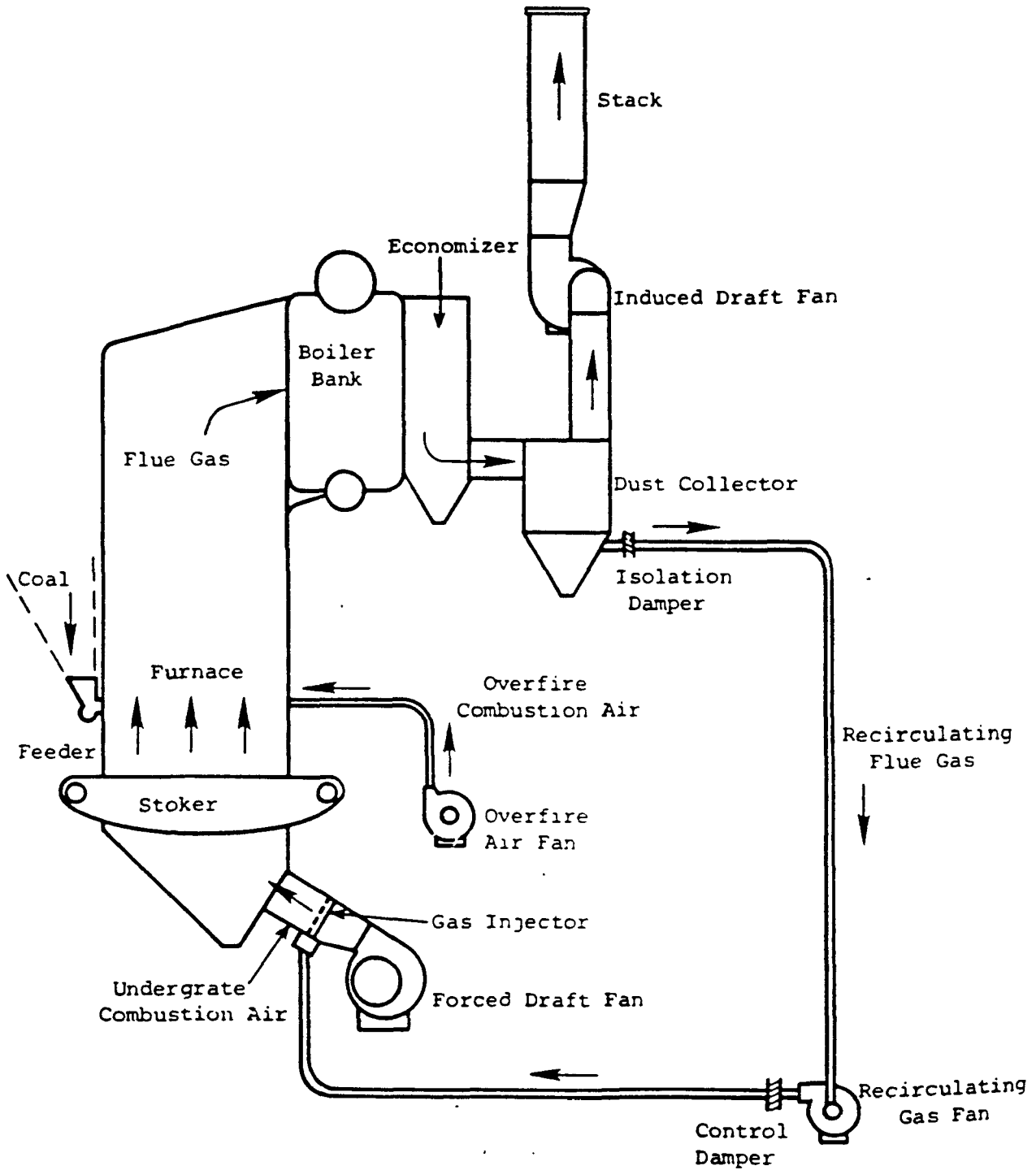

Figure 5-8. Schematic diagram of stoker with FGR.<sup>27</sup>

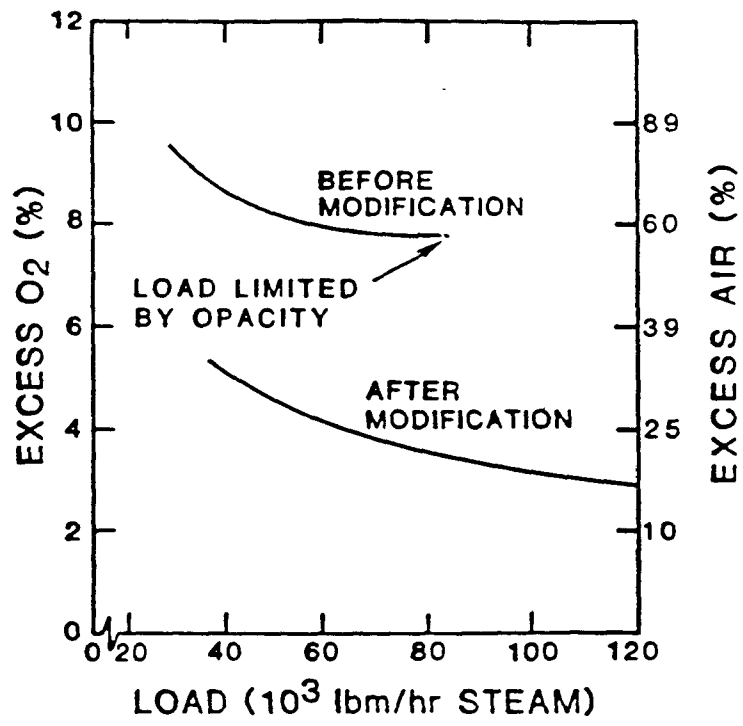

Figure 5-9. FGR effects on excess O<sub>2</sub>.<sup>27</sup>

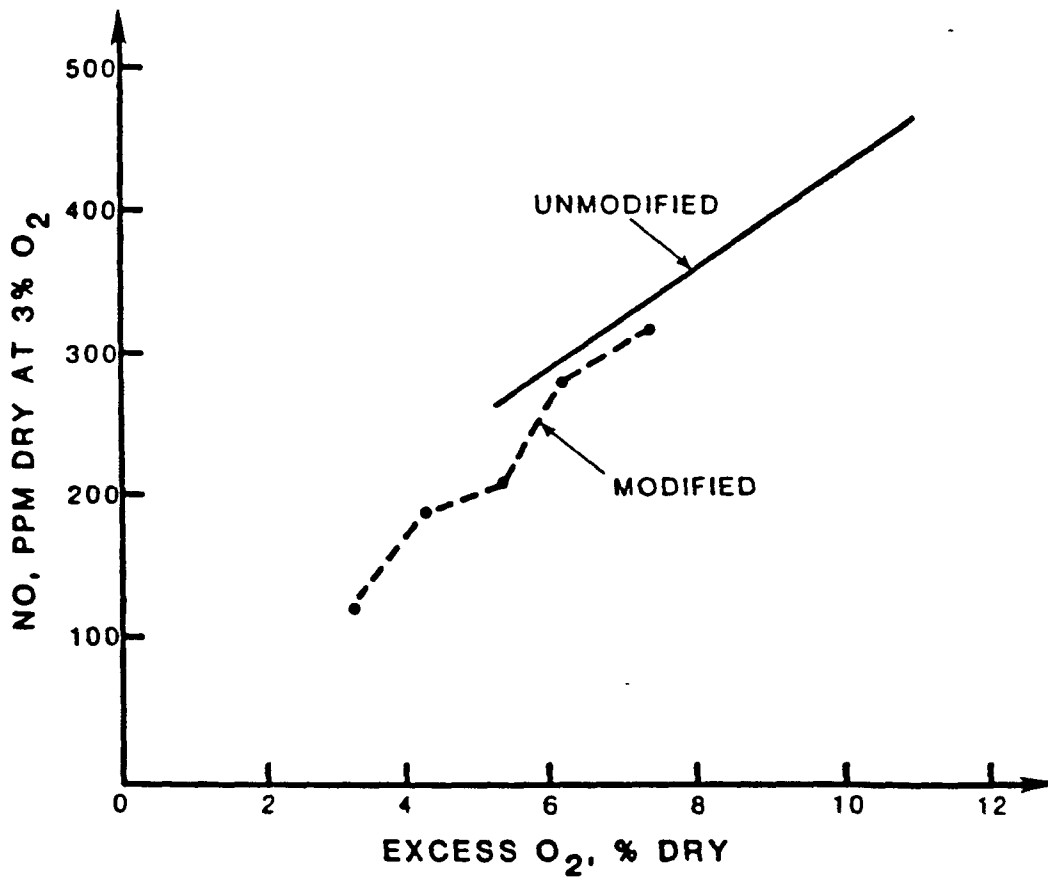

Figure 5-10. NO emission versus excess O<sub>2</sub>, stoker boiler with FGR.<sup>27</sup>

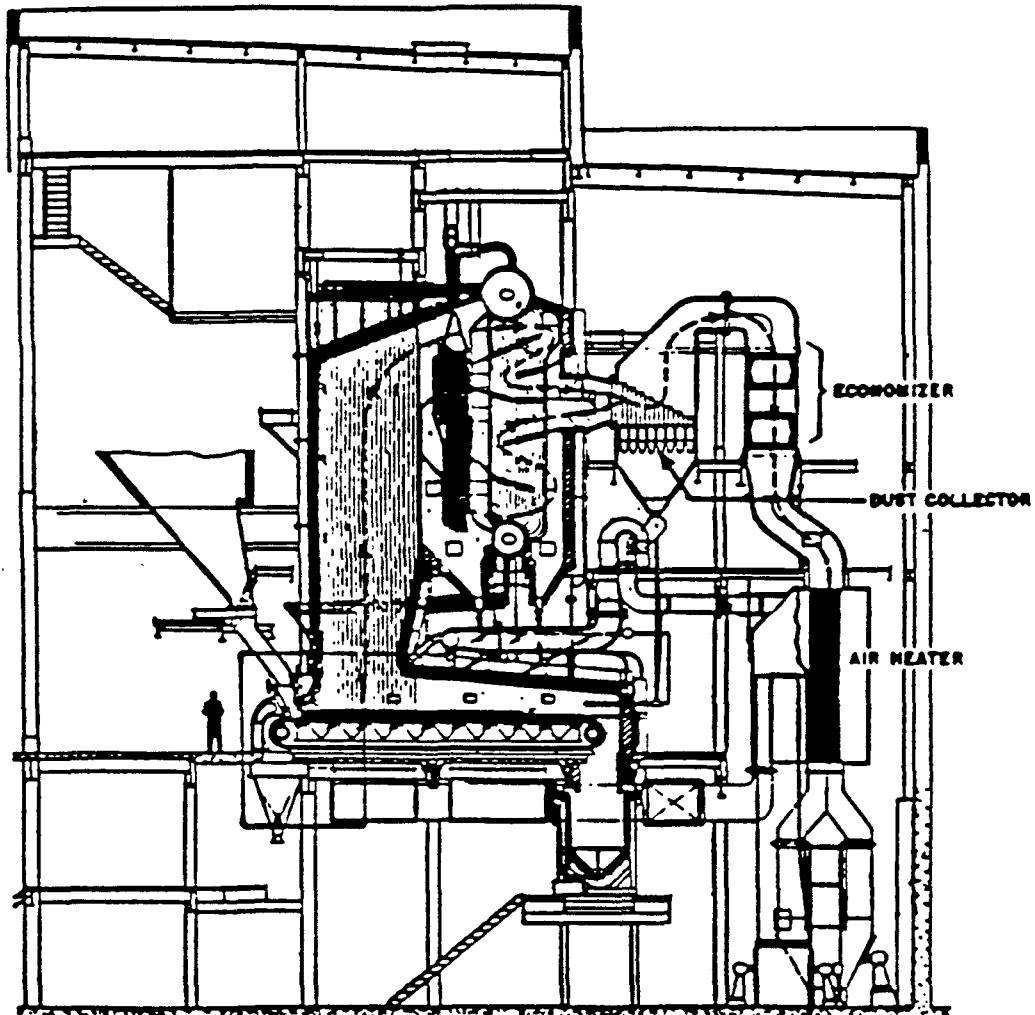

Figure 5-11. Overfeed stoker with short active combustion zone.<sup>26</sup>

stokers, FGR's effect of lengthening the active combustion zone in spreader stokers is of little consequence because the length required for the coal to burn out is much shorter than the length of the fuel bed.<sup>27</sup>

In summary, the use of FGR in stoker coal-fired ICI boilers has been demonstrated successfully in a limited number of boilers. NO<sub>x</sub> reduction on two of the spreader stokers ranged from 13 to 60 percent. For the overfeed stoker unit, FGR caused unsatisfactory combustion conditions including flame quenching, flame impingement, and unstable combustion. The primary effect of FGR is to allow reduction of the excess oxygen level of the boiler, thereby reducing NO<sub>x</sub> emissions and increasing boiler efficiency. FGR has also been shown to be beneficial in dealing with grate overheating.

### **5.2.2.3 RAP**

RAP is limited to stokers equipped with combustion air preheaters. Usually only larger stokers with heat input capacities greater than 100 MM $\dot{B}$ tu/hr tend to have air preheaters.<sup>28</sup> RAP is not commonly used in such boilers because significant losses in boiler efficiency occur when the flue gas bypasses the air preheaters. In bypassing the preheaters, recoverable heat from the flue gas is not utilized and the temperature of the flue gas leaving the stack is increased unless major equipment modifications are made to the heat transfer surfaces. Available emissions data for RAP is limited to one spreader stoker boiler. Reduction of preheated combustion air temperature reduced NO<sub>x</sub> by 32 percent.<sup>28</sup> Because of its limited applicability and negative effects on boiler efficiency, RAP is not considered a primary NO<sub>x</sub> control method for stoker coal-fired ICI boilers.

### **5.2.2.4 Natural Gas Cofiring**

Gas cofiring for stokers has only recently been investigated for improving boiler operation and reducing emissions. The technique involves burning a fraction of the total fuel, typically 5 to 15 percent, as natural gas above the grate. The cofiring improves boiler efficiency through reduced excess air, lower LOI in ash, and reduced flue gas exit temperature. The reduced excess air lowers NO<sub>x</sub> levels. Recent tests on a spreader stoker have shown that NO<sub>x</sub> emissions can be reduced by 20 to 25 percent.<sup>29</sup> More tests are planned.

## **5.2.3 Combustion Modification NO<sub>x</sub> Controls for Coal-fired Fluidized-bed Combustion (FBC) ICI Boilers**

In FBC boilers, the fuel is burned at low combustion temperatures, 790 to 900°C (1,450 to 1,650°F). At these low temperatures, NO<sub>x</sub> formation is limited to the conversion of fuel nitrogen (fuel NO<sub>x</sub>). At these low combustion temperatures, studies have shown little correlation



between temperature and  $\text{NO}_x$  emission, thus combustion modification  $\text{NO}_x$  controls for FBC boilers focus on the control of fuel  $\text{NO}_x$ .<sup>30,31</sup> The principal combustion modification controls used for  $\text{NO}_x$  reduction in FBC boilers are staged combustion, control of bed temperature, and FGR. Table 5-5 summarizes the performance and process requirements of these three techniques. Each of these control approaches is discussed in the following subsections. Process variables that impact  $\text{NO}_x$  formation are also discussed. As indicated earlier, most combustion modification research for FBC has been conducted on pilot scale facilities. Available data from full-scale units are limited; thus, the pilot-scale data offer the greatest insights into the control mechanisms and  $\text{NO}_x$  reduction potential of these controls.

#### 5.2.3.1 SCA in Coal-fired FBC Boilers

SCA is widely accepted as the most effective combustion modification control for reducing  $\text{NO}_x$  from FBC boilers. Nearly all new commercial FBC units come equipped with overfire air ports along the freeboard section of the combustor to inject secondary and sometimes tertiary combustion air.<sup>32</sup> The primary objective of using SCA in an FBC boiler is to reduce  $\text{NO}_x$  formation by operating the fluidized bed of a bubbling FBC (BFBC) boiler, or the lower portion of a circulating FBC (CFBC) boiler under substoichiometric conditions. Additionally, secondary air injection at high levels in the furnace help ensure good carbon, CO, and hydrocarbon burnout.<sup>33</sup>

SCA is generally more effective for high to medium volatile coals than for low volatile fuels such as anthracite. High-volatile-content fuels, also described as high-reactivity fuels (reactivity being defined as the ratio of volatile matter to fixed carbon), contain larger amounts of fuel nitrogen in the volatile matter. When introduced to the combustor, these fuels undergo thermal decomposition and quickly release the organically bound nitrogen in the volatile matter, whereupon it combines to form NO in the presence of oxygen. By using SCA, which lowers the excess oxygen level in the dense portion of the fluidized bed, this conversion of volatile nitrogen to NO is suppressed. For lower volatile fuels, the amount of fuel nitrogen in the volatile fraction is also lower. For these fuels, conversion of char nitrogen to  $\text{NO}_x$  dominates the overall fuel  $\text{NO}_x$ , and nitrogen is released at a much slower rate which is a function of the char combustion rate. Thus, SCA has less of a  $\text{NO}_x$  reducing effect for these lower reactivity fuels.<sup>33</sup>

$\text{NO}_x$  reductions due to SCA in coal-fired FBC boilers have been reported on the order of 40 percent for full scale units in the ICI sector.<sup>34</sup> For example, Figure 5-12 shows the effects of SCA on  $\text{NO}_x$  and CO emissions for a 16 MWe BFBC boiler firing bituminous coal at

TABLE 5-5. NO<sub>x</sub> CONTROL TECHNIQUES FOR FBC BOILERS<sup>30</sup>

Control technique	Control mechanism	Application limits	Potential limitations
SCA	Staged combustion reduces oxygen for conversion of volatile nitrogen; promotes heterogeneous NO reduction with CO over char; causes increase in CaO char concentration in dense bed	Secondary/primary air ratio limited by fluidization requirements in FBC and reheat steam temperatures	Increase in CO emissions, carbon loss, and reduced sulfur capture primarily in FBC under severe staging ( $SR_1 < 0.8$ ); excessive steam temperature
Control of dense bed temperature	Lower bed temperature reduces volatile nitrogen conversion and increases heterogeneous reduction between char and formed NO	Bed temperature is tied to fuel reactivity (ratio of volatiles/fixid carbon). Higher bed temperature or an increase in residence time is required for low reactivity coal. Optimum temperature is between 1,500 and 1,600°F for high sulfur capture.	Excessive temperature reduction increases CO and carbon loss (efficiency reduction), necessitating longer gas residence time for char combustion, especially with low reactivity coal
FGR	NO <sub>x</sub> lowered principally by diluting the combustion air, thus reducing oxygen in the lower bed where NO <sub>x</sub> is principally formed	Not a common control technology. FGR typically limited to 20 to 25 percent due to effects on fluidization velocity.	Excessive steam temperature, potential loss of fluidization with loss of FGR; FGR hardware reliability; reduced sulfur retention.

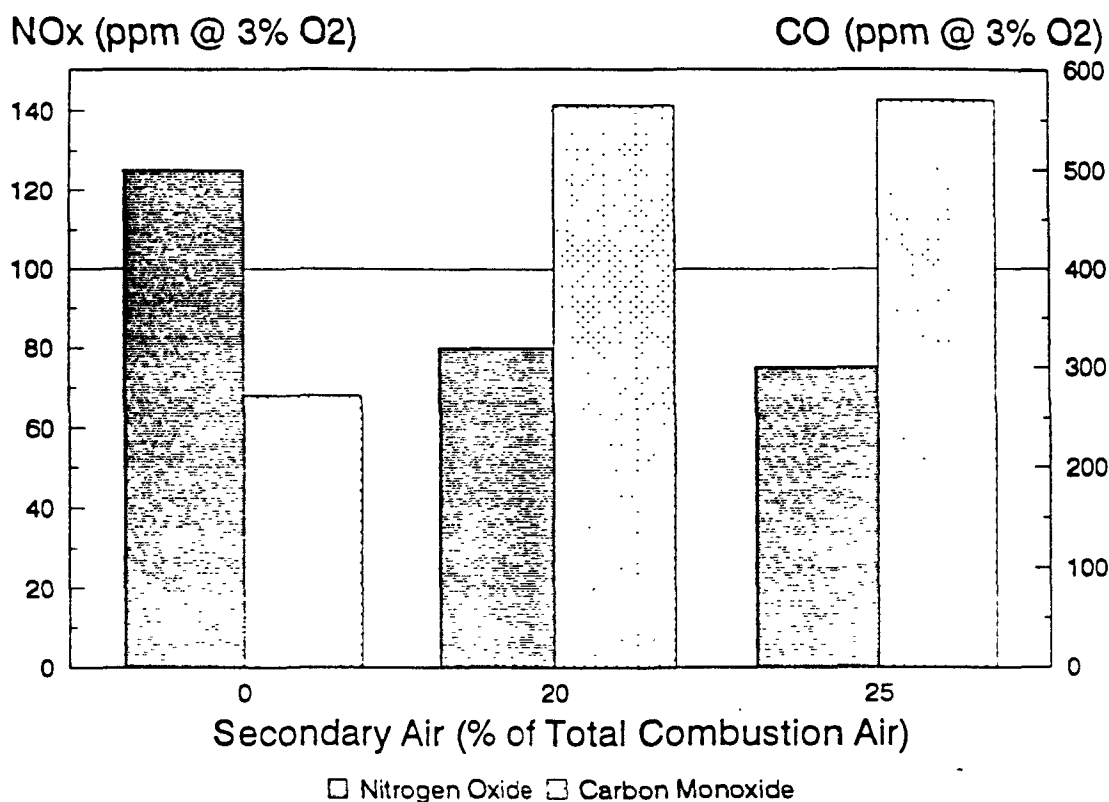

Figure 5-12. Effect of SCA on NO<sub>x</sub> and CO emissions, Chalmers University.<sup>34</sup>

Chalmers University in Sweden. Keeping the total excess air between 20 and 23 percent, NO<sub>x</sub> was reduced 40 percent from 125 to 75 ppm (0.17 to 0.10 lb/MMBtu) when 20 percent of the total air supply was injected through OFA ports. When the proportion of air injected as secondary air was increased to 25 percent, NO<sub>x</sub> reduction from baseline was only slightly more than 40 percent. Meanwhile, CO emissions more than doubled from a baseline level of 270 ppm to 565 ppm.<sup>34</sup> NO<sub>x</sub> reduction efficiencies of as high as 60 to 70 percent have also been reported in several pilot-scale tests.<sup>32</sup> For instance, at the TNO Research facility in Sweden, tests conducted on a 14 MMBtu/hr BFBC unit with SCA showed 67 percent NO<sub>x</sub> reduction.<sup>35</sup> Pilot-scale tests, however, generally involve much higher amounts of staging—i.e., lower primary zone stoichiometries—than are practically achieved in full scale units, due to concerns over combustion efficiency, corrosion of watertubes, and refractory integrity.<sup>32</sup>

Besides the amount of SCA used and fuel type, the location of the OFA ports can also have a significant impact on NO<sub>x</sub> reduction. Several tests have shown that the greater the distance to the secondary air ports, the greater is the NO suppression.<sup>36-38</sup> This is due to the

increased residence time between the primary and secondary air injection stages. However, there are practical limits on how high in the freeboard the OFA can be introduced without affecting combustion efficiency, corrosion, and steam temperature control. Additionally, because of the different rates of fuel nitrogen conversion for low- or high-reactivity coals mentioned earlier, in order to maximize NO<sub>x</sub> reduction the optimal secondary air location must be specifically designed for each type of fuel used, as well as for fuel with different size distributions.

Reported NO<sub>x</sub> emission levels for FBC units with SCA have been highly variable depending on the capacity, fuel type, OFA port location, and design type (i.e., CFBC or BFBC) of the boilers. For instance, controlled NO<sub>x</sub> emissions from a 222 MMBtu/hr CFBC unit fired on bituminous coal ranged from 51 to 335 ppm (0.07 to 0.45 lb/MMBtu), while an identical unit fired on brown coal emitted 103 to 155 ppm (0.14 to 0.21 lb/MMBtu) of NO<sub>x</sub>.<sup>33</sup> Another CFBC unit, rated at 140 MMBtu/hr and firing bituminous coal, emitted 280 ppm (0.38 lb/MMBtu) NO<sub>x</sub>.<sup>39</sup> Data obtained for full-scale units showed controlled NO<sub>x</sub> emissions ranging from 39 to 335 ppm for five CFBC boilers, and 75 to 100 ppm for two BFBC units. These data are tabulated in Table 5-6. Other sources have reported practical NO<sub>x</sub> limits achieved with SCA to be between 80 and 130 ppm (0.11 and 0.18 lb/MMBtu) for CFBC and 100 to 200 ppm (0.14 to 0.27 lb/MMBtu) for BFBC boilers.<sup>32</sup>

#### 5.2.3.2 Bed Temperature Control

The temperature within FBC boilers is determined primarily by the combustion requirements of the coal and the temperature required to maximize sulfur capture. The optimum temperature range for sulfur capture is 800 and 850°C (1,470 to 1,560°F).<sup>40</sup> In this range, the sulfur capture can be as high as 98 percent depending on the Ca/S ratio, sorbent reactivity and size, residence time, and ash recirculation rate.

Low bed combustion temperature lowers the formation of thermal NO<sub>x</sub>. The effects of bed temperature on NO<sub>x</sub> formation for a pilot-scale BFBC was reported to be about 2 to 3 ppm NO<sub>x</sub> reduction for every 10°C in temperature drop.<sup>41</sup> Figure 5-13 shows this effect, as well as the bed temperature's effect on CO emissions, which increase as temperature is lowered. The effects of bed temperature on NO<sub>x</sub> and CO are shown in Figure 5-14 for the full-scale 16 MWe BFBC test unit at Chalmers University, showing 54 percent NO<sub>x</sub> reduction when bed temperature was lowered from 880 to 780°C (1,620 to 1,440°F). This equates to 13 ppm NO<sub>x</sub> reduction per 10°C temperature drop, a greater effect than was experienced with the pilot-scale

TABLE 5-6. REPORTED CONTROLLED NO<sub>x</sub> EMISSION LEVELS, FULL-SCALE, COAL-FIRED FBC BOILERS

Control technique	FBC boiler type	Controlled NO <sub>x</sub> level, ppm @ 3% O <sub>2</sub> , lb/MMBtu
SCA	Circulating	39-245 (0.05-0.33)
	Circulating	51-335 (0.07-0.45)
	Circulating	100 (0.14)
	Circulating	103-155 (0.14-0.21)
	Circulating	280 (0.38)
	Bubbling bed	75 (0.10)
	Dual bubbling bed	100 (0.14)
FGR+SCA	Circulating	90-116 (0.12-0.16)
	Circulating	100-115 (0.14-0.16)

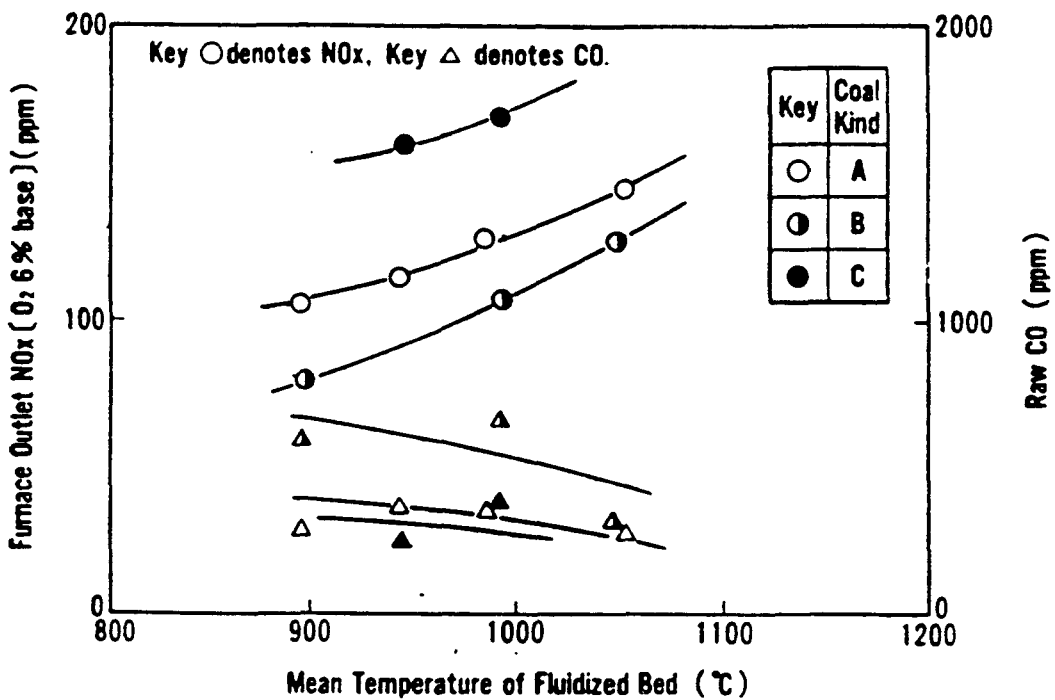

Figure 5-13. NO<sub>x</sub> and CO versus bed temperature, pilot-scale BFBC.<sup>41</sup>

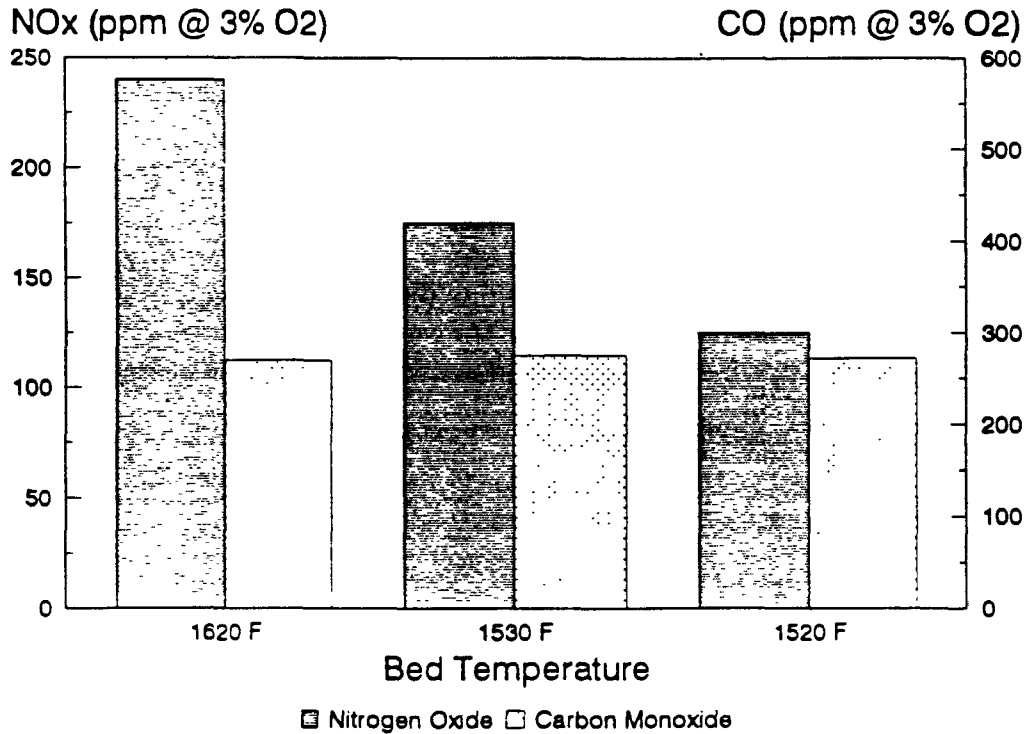

Figure 5-14. Effect of bed temperature on NO<sub>x</sub> and CO, Chalmers University.<sup>34</sup>

unit. The difference in temperature dependence is most likely due to differences in furnace geometry and the type of coal used. Unlike the pilot-scale results shown in Figure 5-13, CO emissions at Chalmers did not increase with lowered bed temperature, remaining fairly constant at 270 ppm.<sup>34</sup> For a CFBC pilot unit, the effect of bed temperature on NO<sub>x</sub> reduction was 8 ppm reduction per 10°C.<sup>42</sup> Similarly, tests conducted at the former 110 MWe CFBC Nuclear Power Station showed roughly 10 ppm NO<sub>x</sub> reduction per 10°C temperature drop in the bed.<sup>43</sup>

Although lowering bed temperature has shown measurable reductions in NO<sub>x</sub>, the lowering of bed and freeboard gas temperatures is not considered a primary NO<sub>x</sub> control method. Steam temperature control, sulfur capture, and combustion efficiency usually do not allow bed and freeboard temperatures much lower than 815°C (1,500°F).<sup>40</sup> Under staged combustion, lower bed and freeboard temperatures are not generally desired since temperature affects the rate of gas-solid catalytic reactions intended to reduce NO<sub>x</sub>.

### 5.2.3.3 FGR in Coal-fired FBC Boilers

FGR through the air distribution plate in a FBC boiler is not a widely accepted NO<sub>x</sub> control technology, or one that has received much research effort to date.<sup>40</sup> In general, FGR allows operation with reduced combustion oxygen levels in the dense portion of the bed, contributing to NO<sub>x</sub> reduction. To some extent, FGR also reduces thermal NO<sub>x</sub> by lowering the peak combustion temperature. When FGR is used in combination with SCA, the primary mechanism that results in NO<sub>x</sub> reduction is the gas temperature drop in the lower portion of the bed combined with a localized reduction in the oxygen concentration. However, thermal NO<sub>x</sub> reduction in FBC is not as high a priority as the control of fuel NO<sub>x</sub>. FGR application in FBC has been limited for the most part to pilot scale research. However, test results reported for two full scale CFBC units with SCA and FGR show a marked NO<sub>x</sub> reduction efficiency of nearly 70 percent for FGR rates in excess of 30 percent. Controlled NO<sub>x</sub> emissions ranged from 90 to 116 ppm (0.12 to 0.16 lb/MMBtu).<sup>33</sup> These data are listed in Table 5-6 and in Appendix B.

Several disadvantages of applying FGR to CFBC units have been identified<sup>33</sup>:

- Combustion efficiency and sulfur retention are generally lowered
- Larger combustor, backpassing boiler chamber, greater baghouse capacity, and fan size are required
- Greater power consumption is required for additional equipment
- Boiler capital and operating costs are increased

Because of these potential adverse side effects, FGR is generally not considered a viable NO<sub>x</sub> control technology for FBC boilers.<sup>40</sup>

### 5.2.3.4 Other Process Variables Affecting NO<sub>x</sub>

The actual NO<sub>x</sub> levels achieved by combustion modification or other controls will depend on several process variables which can influence NO<sub>x</sub> emissions in FBC boilers. These variables can be grouped into three major categories: chemical and physical coal properties, chemical and physical properties of sorbent and bed material, and FBC operational variables.

#### **Coal Properties**

Two important coal properties are the reactivity and size. Lower reactivity coals emit lower levels of NO<sub>x</sub> under both staged and unstaged conditions, due to the catalytic properties of char in reducing formed NO, and because of the rapid oxidation of volatile nitrogen to NO.<sup>43</sup> However, coals with low reactivity, and, hence, lower volatile content, are generally burned less efficiently in FBC boilers than high reactivity coals. Also, SCA is not as effective in reducing

NO<sub>x</sub> when low reactivity coals are burned, as discussed in Section 5.2.3.1. Generally, an increase in coal size tends to reduce NO<sub>x</sub> and improve thermal efficiency. NO<sub>x</sub> is reduced due to the reduced surface area of the char which acts as a catalyst in NH<sub>3</sub> oxidation to NO in the presence of excess oxygen.<sup>44</sup> Thermal efficiency tends to improve as a result of the lower levels of elutriated coal leaving the bed.<sup>44</sup>

NO<sub>x</sub> emissions also depend on the nitrogen content of the volatile fraction of the coal being used, generally increasing as this nitrogen content increases. Under staged combustion, fuel nitrogen conversion is significantly reduced from typically 6 to 7 percent to as low as 1.5 to 2.5 percent, depending on the degree of staging. Thus, the effect of nitrogen content on NO<sub>x</sub> emissions will tend to be less under staged conditions than for unstaged combustion.

The sulfur content of the coal does not in itself have any effect on NO<sub>x</sub> emissions. Indirectly, however, the use of high-sulfur coals requires more limestone sorbent to suppress SO<sub>2</sub> emissions, which will likely increase NO<sub>x</sub> unless the FBC boiler is operated with some degree of air staging. This is because under oxygen rich conditions, excessive calcined limestone (CaO) acts as a catalyst in the oxidation of NH<sub>3</sub> to NO, increasing the conversion rate of volatile nitrogen to NO.<sup>44</sup> With combustion staging, CO levels in the dense portion of the bed reduces formed NO over char and CaO surfaces.

#### **Sorbent/Bed Material**

NO<sub>x</sub> emissions are also affected by the chemical and physical properties of the bed material and sorbent used for sulfur capture. An increase in Ca/S ratio for improved sulfur capture, for example, will increase NO<sub>x</sub>, especially under unstaged combustion conditions, as discussed earlier. CFBC boilers utilize lower Ca/S levels than do BFBC units, and thus tend to emit less NO<sub>x</sub>. With staged combustion, however, the effect of Ca/S ratio on NO formation is reduced due to the catalytic effect of CaO and CaS on NO<sub>x</sub> reduction in the presence of high concentrations of CO.

#### **Operational Variables**

Several operational variables have been reported to affect NO<sub>x</sub> formation, including ash recirculation, coal distribution in the bed, and fluidization velocity. Of these, ash recirculation has the most effect. When CaO concentrations in the ash are low and char and CaSO<sub>4</sub> concentrations are high, a net reduction in NO<sub>x</sub> is achieved with increased ash recycle. The CaSO<sub>4</sub> acts as a catalyst in oxidation of NH<sub>3</sub> and reduction in NO in the freeboard section of the furnace, according to localized temperature and concentration of NH<sub>3</sub> and O<sub>2</sub>.<sup>45</sup> This was



demonstrated in a 125 MMBtu/hr BFBC boiler in Japan, where the use of ash reinjection resulted in a 67 percent NO<sub>x</sub> reduction, from 90 to 30 ppm (0.12 to 0.04 lb/MMBtu).<sup>41</sup>

Data on the effect of coal distribution in the bed are generally sparse and inconclusive. In small pilot-scale combustors, improved bed uniformity has been shown to increase NO<sub>x</sub>. However, under staged conditions, it is likely that better distribution of the coal and increasing the bed depth will offer improved NO<sub>x</sub> control and more efficient operation, although the reduction is anticipated to be small.<sup>46</sup>

The effect of fluidization velocity on NO<sub>x</sub> emissions from FBC boilers is generally small. At constant high excess air levels, an increase in fluidizing velocity has shown a small effect on NO<sub>x</sub>. When overall excess air is kept low, the effect is relatively insignificant.<sup>46</sup>

In summary, NO<sub>x</sub> emissions from FBC boilers are influenced by several design and process parameters to such an extent that NO<sub>x</sub> levels can vary significantly from one unit to the next. For a given type of FBC design, coal properties such as nitrogen content and reactivity; and FBC operating conditions such as bed temperature, ash recirculation, and coal distribution; are principal variables affecting NO<sub>x</sub>. Additionally, the sulfur content of the coal together with the required amount of sulfur capture determine the amount of sorbent used, which in turn influences NO<sub>x</sub>. Sorbent reactivity and size distribution also play important roles in NO<sub>x</sub> emissions since they affect calcium utilization in the fuel bed. Of the combustion modification NO<sub>x</sub> control techniques examined in this section, SCA is the most widely applicable and cost-effective method.

### **5.3 COMBUSTION MODIFICATION NO<sub>x</sub> CONTROLS FOR OIL- AND NATURAL-GAS-FIRED ICI BOILERS**

Combustion modification NO<sub>x</sub> controls for full-scale oil- and natural-gas-fired ICI boilers have been implemented primarily in California. Most of the retrofit activity has been in response to local air districts' rules restricting NO<sub>x</sub> emissions from boilers and process heaters. For example, SCAQMD Rules 1146 and 1146.1 regulate NO<sub>x</sub> emissions from boilers as small as 2 MMBtu/hr in capacity. Rule 1146 restricts NO<sub>x</sub> emissions from ICI boilers with heat input capacities of 5 MMBtu/hr or more to 40 ppm (0.05 lb/MMBtu), unless the unit is greater than or equal to 40 MMBtu/hr capacity and has more than a 25 percent annual capacity factor, in which case NO<sub>x</sub> emissions are limited to 30 ppm. Rule 1146.1 mandates a 30 ppm (0.04 lb/MMBtu) limit for ICI boilers of at least 2 MMBtu/hr capacity but less than 5 MMBtu/hr. Additionally, several districts restrict NO<sub>x</sub> from boilers used in the petroleum refining industry. It should be noted that these limits are possible in Southern California only

because of the reliance on clean burning natural gas and light distillate oil. Applicable controls include WI/SI; FGR; LNB; SCA, including BOOS and OFA; and a combination of these.

The control of  $\text{NO}_x$  from fuel oil combustion relies on the suppression of both fuel and thermal  $\text{NO}_x$ , while with natural gas combustion,  $\text{NO}_x$  control focuses primarily on thermal  $\text{NO}_x$  only. In order to achieve this suppression, control methods involve combustion staging or reduction of peak flame temperature. Applicable combustion modification control techniques are SCA, including BOOS and OFA; use of LNBs; FGR; and combinations of these techniques. As explained earlier in this chapter, load reduction, reduced air preheat, and low excess air firing are not considered independent or viable control technologies. Fuel switching has traditionally not been viewed as a control technology. However, the switching from coal to oil or gas and from high-nitrogen residual oil to lighter oil fractions or gas have come under increased consideration in regional and seasonal  $\text{NO}_x$  compliance options. Fuel switching is discussed in this section along with more traditional combustion modification controls.

Tables 5-7 and 5-8 summarize the information available on the performance and applicability of these techniques for natural-gas-fired and oil-fired ICI boilers, respectively. For natural-gas-fired boilers, more data were available for watertube units equipped with LNB or combined LNB and FGR. Controlled  $\text{NO}_x$  levels for these units ranged from as low as 13 ppm (0.02 lb/MMBtu) to as high as 170 ppm (0.20 lb/MMBtu). The limited data available for gas-fired watertube units with SCA show controlled  $\text{NO}_x$  levels of 50 to 200 ppm (0.06 to 0.24 lb/MMBtu). Controlled  $\text{NO}_x$  emissions from gas-fired firetube units, most equipped with FGR, ranged from 15 to 68 ppm (0.02 to 0.08 lb/MMBtu).

The data presented in Table 5-8 also show wide variability in controlled  $\text{NO}_x$  levels. For example, units fired on distillate oil with LNB showed  $\text{NO}_x$  ranging from 60 to 260 ppm (0.08 to 0.33 lb/MMBtu). With combined LNB and FGR,  $\text{NO}_x$  ranged from 30 to 200 ppm (0.04 to 0.25 lb/MMBtu).

The following subsections, 5.3.1 through 5.3.7, describe each of these methods as they are applied to both oil and natural gas combustion. Although differences in fuel type are acknowledged and affect  $\text{NO}_x$  emission levels, in general the control equipment and techniques used for oil and natural gas firing are similar. In fact, a large percentage of industrial boilers are capable of burning gas and oil individually or in combination.<sup>47</sup> All data collected for this section are contained in Appendix B. Additionally, data provided by Coen Company and

**TABLE 5-7. COMBUSTION MODIFICATION NO<sub>x</sub> CONTROLS FOR FULL-SCALE NATURAL-GAS-FIRED INDUSTRIAL BOILERS**

Control technique	Description of technique	Number of industrial boilers tested	% NO <sub>x</sub> reduction	Controlled NO <sub>x</sub> levels ppm @ 3% O <sub>2</sub> , lb/MMBtu	Comments
WI	Water injected into the flame in amounts equivalent to a fraction of the fuel.	Watertube—2 <sup>a</sup>	50-77	35-45 (0.04-0.056)	Thermal efficiency loss of 0.5 to 2.5%. Often implemented with OT, LNB, or BOOS. CO increase is expected. Experience limited to Southern California.
SCA	Fuel-rich firing burners with secondary air injection.	Watertube—5 <sup>b</sup> Watertube—7 <sup>c</sup>	17-46 N.A. <sup>d</sup>	50-200 (0.06-0.24) 67-170 (0.08-0.20)	Includes BOOS and OFA. BOOS applies to multi-burner units only.
LNB	LEA burners operate at lower oxygen concentrations. Staged combustion burners control mixing of primary combustion air and fuel. Also have radiant ceramic fiber burner which reduces peak furnace temperature.	Firetube—1 <sup>b</sup> Watertube—18 <sup>b</sup> Watertube—17 <sup>c</sup> Watertube—21 <sup>b</sup>	5 39-71 (for 5 boilers) <sup>e</sup> N.A. N.A.	67 (0.08) 25-140 (0.03-0.17) 30-170 (0.04-0.20) <sup>f</sup> <40 (<0.05)	LEA LNBs more applicable to single-burner systems. Staged air burners could result in flame impingement on furnace walls of smaller units.
Radiant LNB	Flameless premix ceramic radiant burner	Firetube—5 <sup>b</sup> Firetube—2 <sup>g</sup>	32 <sup>c</sup> N.A.	23-68 (0.03-0.08) <40 (<0.05)	
FGR	Recirculation and mixing of stack flue gas with burner combustion air.	Firetube—6 Watertube—20 <sup>b</sup> Watertube—13 <sup>c</sup>	53-82 53-74 (for 2 boilers) <sup>e</sup> N.A.	9-30 (0.01-0.036) 18-67 (0.02-0.08) 30-85 (0.04-0.10)	Special design LNB limited to firetube applications (<10 MMBtu/hr). Requires motor, fan, and connecting ducting. Reported NO <sub>x</sub> data is for FGR rates of 10 to 30%.
LNB + FGR	Combination of LNB and FGR control techniques.	Firetube—57 Watertube—22 <sup>b</sup> Watertube—50 <sup>c</sup> Firetube—5 <sup>b</sup>	55-76 (for 10 boilers) <sup>e</sup> 55-84 (for 5 boilers) <sup>e</sup> N.A. N.A.	16-61 (0.02-0.08) 13-39 (0.02-0.05) 25-170 (0.03-0.20) 20-37 (0.02-0.04)	Combined methods are not additive in their effectiveness.
LNB + SCA	Combination of LNB and SCA control techniques.	Watertube—9 <sup>c</sup>	N.A.	85-170 (0.10-0.20)	Applicable principally to multi-burner boilers.

<sup>a</sup>Data primarily from Reference 48.

<sup>b</sup>Data primarily from test reports. See Appendix B.

<sup>c</sup>Data from LNB vendor (Coen Company). See Appendix C. NO<sub>x</sub> levels are not necessarily actual. Often represent vendor-guaranteed levels.

<sup>d</sup>N.A. = Not available. No baseline (uncontrolled) NO<sub>x</sub> data available.

<sup>e</sup>No baseline (uncontrolled) NO<sub>x</sub> data available for remainder of boilers.

<sup>f</sup>Range for 95 percent of units listed in Appendix C.

<sup>g</sup>Data from LNB vendor (Lampella Power Corp.). See Appendix C.

Note: Watertube boilers include both single-burner packaged boilers and multi-burner field-erected boilers. For more detail on emission results from single-burner (PKG-WT) and multi-burner (FE-WT) units, see Section 5.6 and Appendix B.

**TABLE 5-8. COMBUSTION MODIFICATION NO<sub>x</sub> CONTROLS FOR OIL-FIRED INDUSTRIAL BOILERS**

Control technique	Description of technique	Number of industrial boilers tested	% NO <sub>x</sub> reduction	Controlled NO <sub>x</sub> levels ppm @ 3% O <sub>2</sub> lb/MMBtu	Comments
LNB	Staged combustion burners control mixing of primary combustion air and fuel	Residual WT, FT-18 <sup>a,b</sup>	30-60	69-200 (0.09-0.25)	Staged air burners could result in flame impingement on furnace walls of smaller units.
		Residual WT-24 <sup>c</sup>	N.A. <sup>d</sup>	80-475 (0.10-0.60) <sup>e</sup>	
		Distillate WT-7 <sup>f</sup>	N.A.	60-119 (0.08-0.15)	
		Distillate WT-71 <sup>c</sup>	N.A.	65-260 (0.08-0.33) <sup>f</sup>	
FGR	Recirculation and mixing of stack flue gas with combustion air	Distillate FT-1 <sup>b</sup>	15	120 (0.15)	
		Residual WT-2 <sup>b</sup>	4-30	91-197 (0.12-0.25)	Requires motor, fan, and connecting ducting. Reported data are for FGR rates of 10 to 30%.
		Residual WT-1 <sup>c</sup>	N.A.	275 (0.35)	
		Distillate WT-6 <sup>b</sup>	20-68	28-120 (0.04-0.15)	
		Distillate WT-2 <sup>c</sup>	N.A.	240 (0.30)	
		Distillate FT-11 <sup>b</sup>	N.A.	28-126 (0.04-0.16)	
SCA	Fuel-rich firing burners with secondary air injection	Residual WT-11 <sup>b</sup>	5-42	157-588 (0.20-0.74)	Includes BOOS and OFA.
		Residual WT-3 <sup>c</sup>	N.A.	160-240 (0.20-0.30)	BOOS applicable for boilers with multiple burners only.
		Residual FT-1 <sup>b</sup>	49	90 (0.11)	Firetube test experimental.
LNB+FGR	Combination of LNB and FGR control techniques	Distillate WT-1 <sup>b</sup>	30	77 (0.10)	
		Distillate WT-3 <sup>c</sup>	N.A.	70-95 (0.09-0.12)	
		Residual WT-1 <sup>b</sup>	N.A.	180 (0.23)	Combined methods are not additive in their effectiveness.
		Residual WT-4 <sup>c</sup>	N.A.	80-435 (0.10-0.55)	
LNB+SCA	Combination of LNB and SCA control techniques	Distillate WT-10 <sup>b</sup>	N.A.	20-103 (0.03-0.13)	
		Distillate WT-26 <sup>c</sup>	N.A.	30-200 (0.04-0.25)	
		Residual WT-11 <sup>c</sup>	N.A.	160-315 (0.20-0.40)	Applicable principally to multi-burner boilers.
		Distillate WT-6 <sup>c</sup>	N.A.	160 (0.20)	

<sup>a</sup>WT = watertube; FT = firetube. Watertube boilers include both single-burner packaged (PKG-WT) boilers and multi-burner field-erected (FE-WT) boilers.

<sup>b</sup>Data primarily from test reports. See Appendix B.

<sup>c</sup>Data from Coen Company. See Appendix C. NO<sub>x</sub> levels are not necessarily actual. Often represent vendor-guaranteed levels.

<sup>d</sup>N.A. = Not available. No baseline (uncontrolled) NO<sub>x</sub> data available.

<sup>e</sup>Range for 90 percent of units listed in Appendix C.

<sup>f</sup>Range for 96 percent of units listed in Appendix C.

Tampella Power Corporation are contained in Appendix C. These data include emission levels based on vendor guarantees, and actual recorded emissions.

### **5.3.1 Water Injection/Steam Injection (WI/SI)**

WI/SI are effective control techniques for reducing thermal  $\text{NO}_x$  in natural-gas-fired ICI boilers. When water or steam are injected in the flame, they reduce the peak flame temperature and the oxygen concentration. The quenching of the flame reduces the  $\text{NO}_x$  by as much as 75 percent, depending on the amount of water or steam injected. Less water than steam is needed to achieve the same quenching effect because of the heat of vaporization required to change water into steam.

WI has seen very limited application in Southern California, where  $\text{NO}_x$  emission regulations are the most stringent. Because of low initial cost, the technique is considered particularly effective for small single-burner packaged boilers operated infrequently.<sup>48</sup> In these applications, the oil gun positioned in the center of the natural gas ring burner is used to inject the water at high pressure. The amount of water injected normally varies between 25 and 75 percent of the natural gas feedrate, on a mass basis. Figure 5-15 illustrates the general trend of  $\text{NO}_x$  reduction with water injection rate. However, the technique has some important environmental and energy impacts. For example, CO emissions increase because of the quenching effect on combustion, and the thermal efficiency of the boiler decreases because the moisture content of the flue gas increases, contributing to greater thermal losses at the stack. Another concern related to the technique is its potential for unsafe combustion conditions that can result from poor feedrate control.

### **5.3.2 Low- $\text{NO}_x$ Burners (LNBs) in Natural-gas- and Oil-fired ICI Boilers**

LNBs for natural-gas- and oil-fired ICI units are becoming more widespread as the technology has been commercialized and improved, and as regulatory requirements become stricter. LNBs in the ICI sector have been applied primarily to packaged watertube ICI boilers, and to a lesser extent, to packaged firetube and field erected watertube boilers. Most of the available data are from gas-fired boilers located in California. Some of the principal types of LNB available are staged combustion burners, relying on either staged air or staged fuel, LNB with FGR, and ceramic fiber burners. Additionally, another type of burner known as the cyclonic combustion burner has recently been introduced. Major manufacturers of staged combustion burners for ICI sized boilers include Coen Company, Inc., Faber Burner (Tampella Power), Todd Combustion, Peabody, Riley Stoker, Industrial Combustion, and the John Zink Company. Alzeta

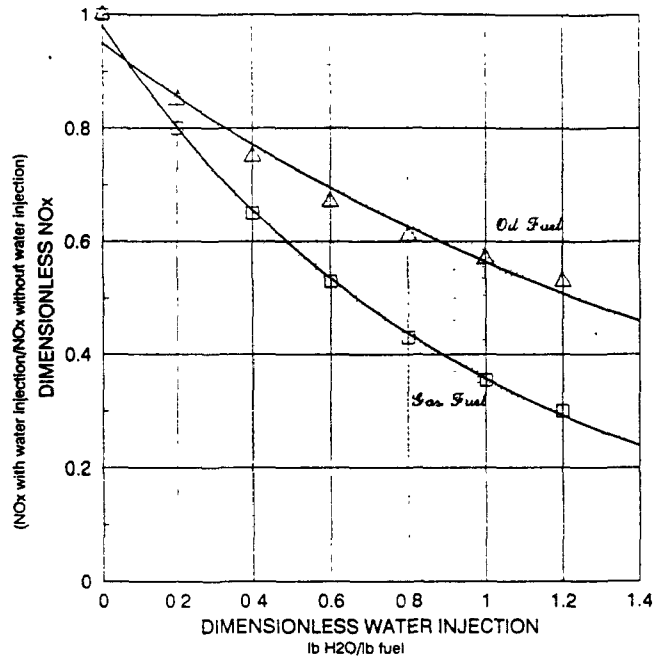

Figure 5-15. As the rate of water injection increases, NO<sub>x</sub> decreases.<sup>48</sup>

Corporation has developed the radiant ceramic burner, while York-Shipley has recently introduced the cyclonic burner, both of which are for use primarily in smaller packaged firetube boilers.

There are also burners known as LEA burners, which reduce NO<sub>x</sub> formation by operating at low oxygen concentrations. An added benefit of LEA burners is improved thermal efficiency. When compared to conventional burners, however, these burners provide moderate reductions in NO<sub>x</sub>, reportedly on the order of 10 to 25 percent reduction.<sup>49</sup> The primary benefits of LEA burners are their increased efficiency and fuel saving characteristics. Because of the greater difficulty in achieving equal air distribution in multiple burner systems, LEA burners are generally more applicable to single burner systems.

The data in Tables 5-7 and 5-8 indicate that ICI boiler LNB experience includes the reported NO<sub>x</sub> levels and reduction efficiencies shown in Table 5-9, exclusive of LNB vendor data from Appendix C. There are many factors that affect the level of NO<sub>x</sub> achieved with these burners. The nitrogen content of residual oil, the heat release rate, and the amount of combustion air preheat combined with level of FGR used for gas fuel are among the more

**TABLE 5-9. REPORTED NO<sub>x</sub> LEVELS AND REDUCTION EFFICIENCIES IN ICI BOILERS WITH LNBS**

<b>Fuel</b>	<b>Performance levels</b>
Residual oil	30-60% 0.09-0.60 lb/MMBtu
Distillate oil	N.A. <sup>a</sup> 0.08-0.33 lb/MMBtu
Natural gas conventional burners	32-71% 0.03-0.20 lb/MMBtu
Natural gas radiant burners	53-82% 0.01-0.036 lb/MMBtu

<sup>a</sup>N.A. = Not available.

critical factors contributing to the wide range in controlled NO<sub>x</sub> levels. The following subsections highlight the principal design features of LNB types.

### 5.3.2.1 Staged Combustion Burners

Staged combustion burners, the most common type of LNB, achieve lower NO<sub>x</sub> emissions by staging the injection of either air or fuel in the near burner region. Hence, staged combustion burners may be further classified as either staged air burners or staged fuel burners. Staged air burners have been applied to watertube boilers since 1979.<sup>50</sup> Figure 5-16 is a schematic of a typical staged air burner, in which primary, secondary, and tertiary (denoted as staged air in the figure) air are injected into the burner. As the figure notes, the division of combustion air reduces the oxygen concentration in the primary burner combustion zone, lowering the amount of NO formed and increasing the amount of NO reducing agents. Secondary and tertiary air complete the combustion downstream of the primary zone, lowering the peak temperature and reducing thermal NO<sub>x</sub> formation. Besides the basic staged air burner shown, there are variations on staged air burners which incorporate internal recirculation of combustion products to aid in NO<sub>x</sub> reduction.

Due to the staging effect of staged air burners, flame lengths tend to be longer than those of conventional burners.<sup>51</sup> This is of particular concern for packaged units because there is the possibility that flame impingement will occur on the furnace walls, resulting in tube failure and corrosion. Additionally, staged air burners are often wider and longer than conventional burners, requiring significant modifications to existing waterwalls and windboxes. Burner size

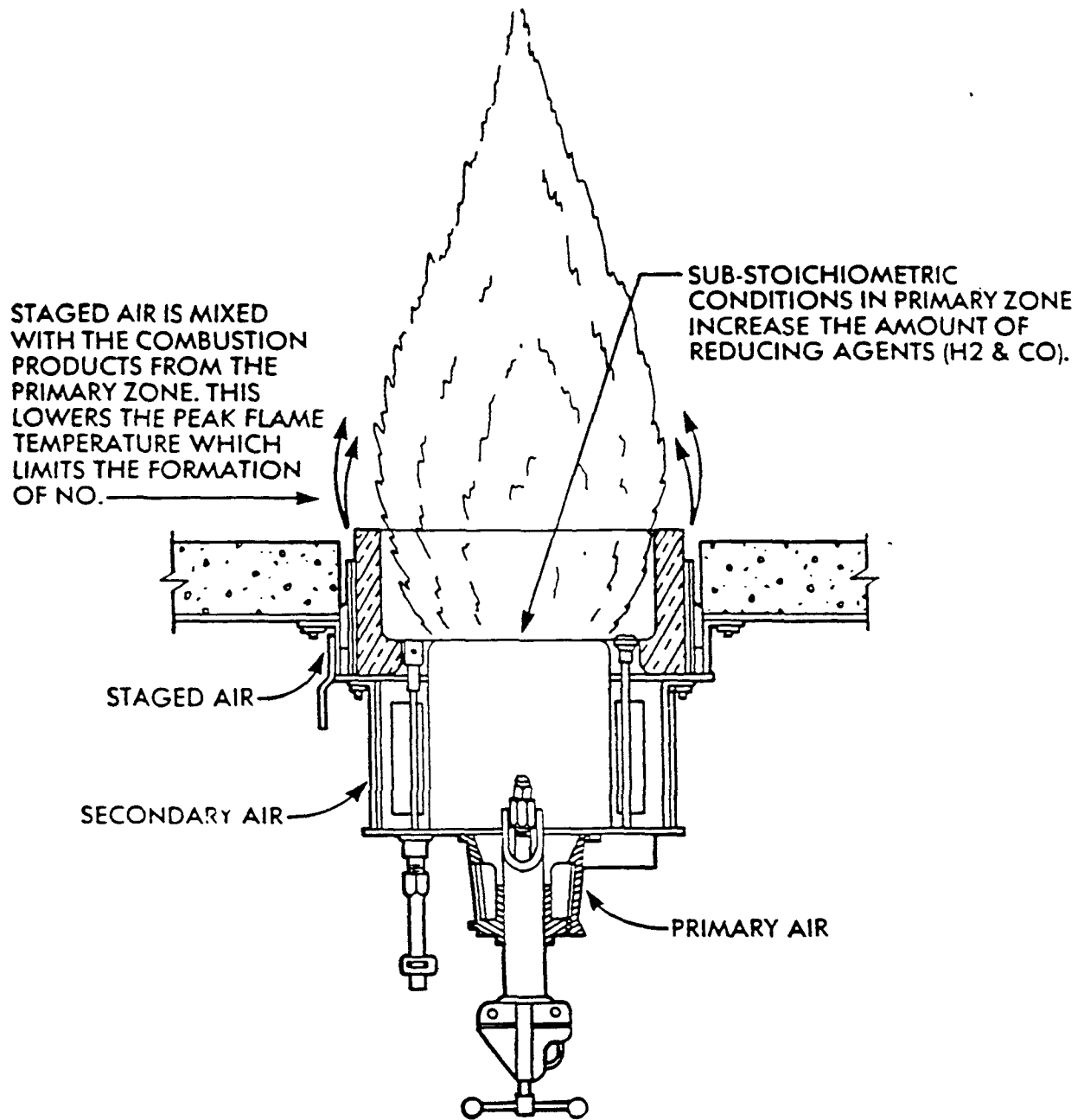

Figure 5-16. Staged air LNB.<sup>53</sup>



may also be an important factor when assessing the feasibility of retrofitting boilers located in restricted spaces.

Staged fuel burners are a slightly more recent development in staged combustion LNBs. These burners were originally developed for use on process heaters in the refining and petrochemical industries, and hence have been applied primarily to process heaters rather than boilers. Figure 5-17 is a schematic of a staged fuel burner, manufactured by the John Zink Company. Here, combustion air is introduced without separation and instead the fuel is divided into primary and secondary streams. Despite the high oxygen concentration in the primary combustion zone, thermal  $\text{NO}_x$  formation is limited by low peak flame temperatures which result from the fuel-lean combustion. Quenching of the flame by the high excess air levels also occurs, further limiting the peak flame temperatures and providing active reducing agents for  $\text{NO}_x$  reduction.<sup>52</sup> Inerts from the primary zone then reduce peak flame temperatures and localized oxygen concentration in the secondary combustion zone, thereby reducing  $\text{NO}_x$  formation. An advantage of staged fuel burners over staged air burners is that they tend to have shorter flame lengths, decreasing the likelihood of flame impingement.<sup>54</sup>

Data collected on natural-gas- and oil-fired ICI boilers with staged air LNBs show a wide range in performance and emission levels. For natural gas firing,  $\text{NO}_x$  reductions of 39 to 71 percent were reported for three existing and one new watertube boiler. Controlled  $\text{NO}_x$  levels for these and 10 other gas-fired watertube boilers, five of which were existing units retrofitted with LNBs, ranged from 25 ppm (0.03 lb/MMBtu), for a 10 MMBtu/hr boiler in Taiwan, to 140 ppm (0.17 lb/MMBtu), for a 100 MMBtu/hr floor firing unit in Germany. This range is quite wide due to differences in boiler design, capacity, and burner type. An example of the levels of performance achievable with different burners is that when a different LNB was tested in the German boiler mentioned above, the controlled  $\text{NO}_x$  level was 112 ppm (0.13 lb/MMBtu) instead of 140 ppm (0.17 lb/MMBtu).<sup>55</sup>

All but one of the above 14 units were packaged. The only field-erected unit, a 380 MMBtu/hr dual burner unit at Luz-Segs II in California, reported a controlled  $\text{NO}_x$  level of 80 ppm (0.10 lb/MMBtu) when retrofitted with an LNB.<sup>56</sup> Test results from one gas-fired firetube unit at Fort Knox retrofitted with a staged air burner showed a 32 percent reduction in  $\text{NO}_x$ , from 100 ppm down to 68 ppm (0.12 to 0.08 lb/MMBtu). No other data are available for firetube units with staged air LNB.

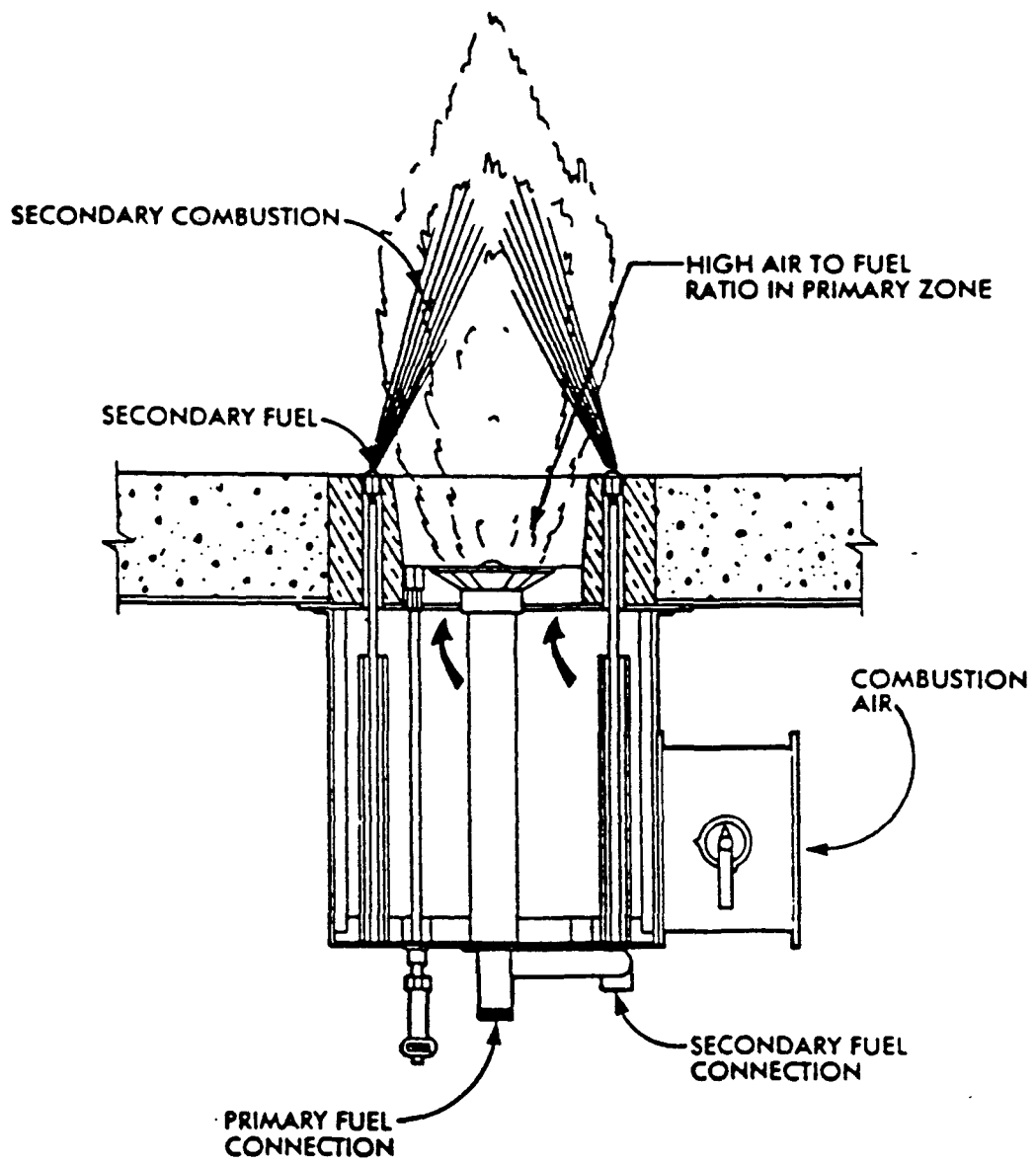

Figure 5-17. Staged fuel LNB.<sup>52</sup>

Additional data supplied by Coen Company (see Appendix C) for 177 natural-gas-fired LNB installations showed guaranteed or actual NO<sub>x</sub> levels typically between 30 and 170 ppm (0.04 to 0.20 lb/MMBtu) with LNB.<sup>57</sup> These data include emissions levels for boilers of various types and sizes, ranging from packaged to field erected units producing 25,000 to 520,000 lb/hr of steam (approximately 30 to 600 MMBtu/hr heat input). All units used Coen DAF LNBs. Appendix C also contains a list of 23 Tampella Power Corp. Faber LNB installations that reportedly emit 40 ppm NO<sub>x</sub> (0.05 lb/MMBtu) or less when firing natural gas. All of these boilers are packaged units ranging from 9,000 to 100,000 lb/hr steam capacity.<sup>58</sup>

For smaller industrial gas-/oil-fired boilers, Riley Stoker has also introduced the Axial Staged Return (ASR™) flow burner, the Axial Flame Staged (AFS™) burner, and the Swirl Tertiary Staged (STS™) burner. The ASR burner is based on patented Deutsche Babcock technology that uses axial staging of primary and secondary air streams and internal recirculation of self-aspirated hot furnace gases. The burner, illustrated in Figure 5-18, has a maximum design capacity of 275 MMBtu/hr, with controlled NO<sub>x</sub> levels in the 20 to 30 ppm (0.025 to 0.035 lb/MMBtu) range when firing natural gas with 12 to 30 percent FGR assistance.<sup>59</sup> The AFS burner incorporates axial staging of primary and secondary air and staged fuel addition. The burner, illustrated in Figure 5-19, has a firing capacity in the 20 to 40 MMBtu/hr range.<sup>59</sup> With FGR addition, NO<sub>x</sub> emissions in the 30 to 40 ppm (0.035 to 0.048 lb/MMBtu) range have been reported in full-scale retrofits.<sup>59</sup> The STS burner, illustrated in Figure 5-20, is designed for retrofit on multiple burner wall-fired boilers with 500°F air preheat. In one full-scale STS burner retrofit at a paper mill, reported NO<sub>x</sub> emissions ranged from 90 to 110 ppm (about 0.1 to 0.13 lb/MMBtu) with high air preheat and heat release rate and without FGR.<sup>59</sup>

In summary, LNB NO<sub>x</sub> reduction efficiencies for natural-gas-fired boilers including one firetube boiler and five watertube units range from 32 to 71 percent, in agreement with previously reported performance levels for natural gas firing. LNB reduction efficiencies for 13 additional watertube units listed in Appendix B could not be computed because of a lack of baseline (uncontrolled) emissions data. Controlled NO<sub>x</sub> emissions for the 18 watertube units ranged from 25 to 30 ppm (0.03 to 0.04 lb/MMBtu), for the smaller units (10 to 31 MMBtu/hr input), and from 58 to 140 ppm (0.07 to 0.17 lb/MMBtu), for the remaining boilers, which ranged in size from 45 to 380 MMBtu/hr input. Controlled NO<sub>x</sub> emissions reported by two LNB manufacturers for nearly 200 units ranged between 30 and 170 ppm (0.04 to 0.20 lb/MMBtu). Some burner manufacturers have reported NO<sub>x</sub> reduction efficiencies of anywhere from 50 to

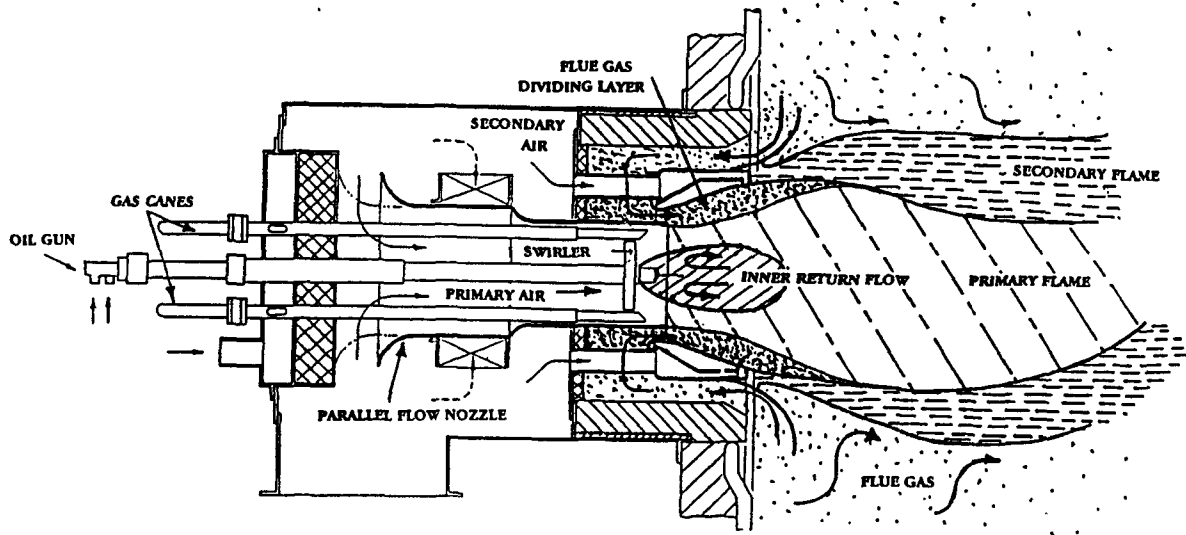

Figure 5-18. Low-NO<sub>x</sub> ASR burner.<sup>59</sup>

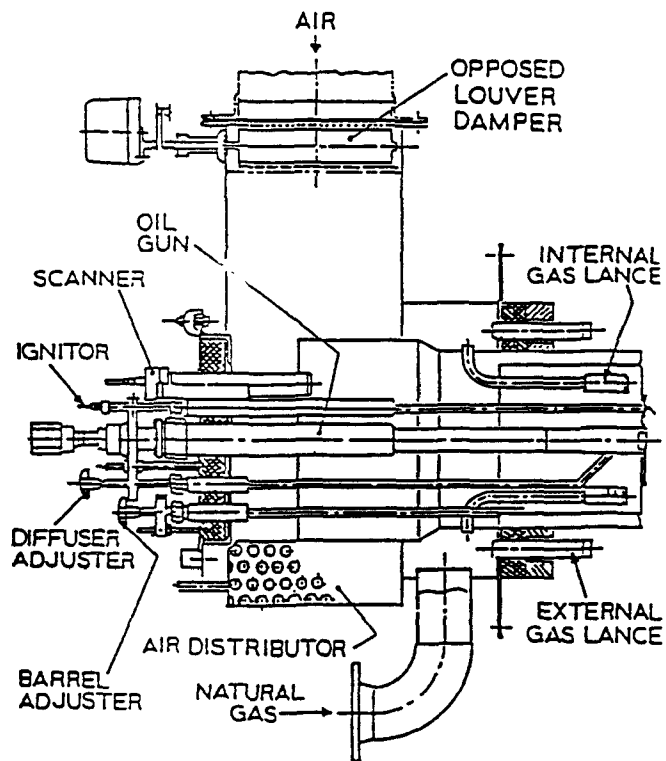

Figure 5-19. AFS air- and fuel-staged burner.<sup>59</sup>

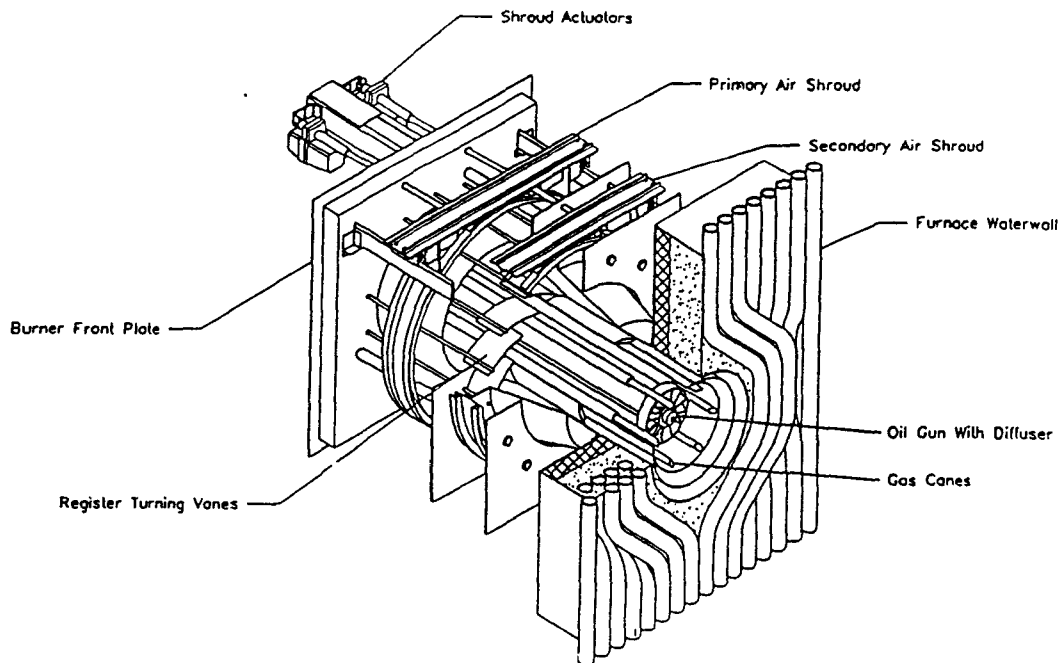

Figure 5-20. Riley Stoker STS burner.<sup>59</sup>

90 percent. In fact, several manufacturers guarantee  $\text{NO}_x$  emissions below 40 ppm (0.05 lb/MMBtu) when firing natural gas in smaller industrial packaged boilers, primarily in response to the SCAQMD regulations in California. For example, Faber, a division of Tampella Power, guarantees less than 40 ppm  $\text{NO}_x$  on any burner system and will guarantee less than 30 ppm (0.04 lb/MMBtu) of  $\text{NO}_x$  on a case-by-case basis.<sup>60</sup> Similarly, Coen Company states that less than 30 ppm of  $\text{NO}_x$  will be emitted from its Micro- $\text{NO}_x$ ® LNB.<sup>61</sup> Performance levels of less than 20 ppm are achievable on a case-by-case basis.

For oil firing with staged air LNBs, data were collected for 84 boilers firing distillate oil and 46 boilers firing residual oil. The distillate-fuel-fired boilers with staged air LNBs showed controlled  $\text{NO}_x$  levels of 60 to 260 ppm (0.08 to 0.33 lb/MMBtu). The 25 domestic units fired on No. 6 residual oil (fuel nitrogen contents of 0.14 to 0.3 percent) had controlled emissions of 80 to 475 ppm (0.10 to 0.60 lb/MMBtu). Due to a lack of baseline uncontrolled emissions data for these domestic units, it was not possible to calculate  $\text{NO}_x$  reduction efficiencies for the boilers. Additionally, overall performance results of 17 firetube and watertube boilers in Japan firing residual oil have been reported. For these units, which ranged in size from 5 to 40 MMBtu/hr, test results showed  $\text{NO}_x$  reductions between 30 and 60 percent, with controlled emissions between 69 and 185 ppm (0.09 and 0.23 lb/MMBtu).<sup>62</sup>

The retrofit of LNBs usually involves removing the original burner and bolting the LNB in. Most LNBs for ICI boilers are designed as self-contained units to allow easy bolt-on retrofit without boiler tube wall modifications. For applications where new fan or ducting equipment are desired, some manufacturers offer complete packaged burner units, in which the retrofit burner is combined with combustion controls, flame safeguard equipment, fuel piping, and a combustion air fan. These are sold together as factory assembled, self-contained packages.

### 5.3.2.2 Ceramic Fiber Burners

Alzeta Corporation has developed a ceramic fiber burner known as the Pyrocore® burner, applicable for use in gas-fired packaged boilers of up to 10 MMBtu/hr input. Although applicable to both watertube and firetube units, the Pyrocore burner has been demonstrated primarily in firetube boilers and process heaters. This burner, depicted in Figure 5-21, is a gas-fired infrared (IR) burner. An IR burner uses energy released from the fuel to elevate the temperature of the radiant surface of the burner, which in turn emits energy in the form of IR radiation. In the Pyrocore burner, fuel gas is premixed with combustion air before entering the burner. The mixture passes through a porous burner material and is ignited, establishing a thin combustion layer in contact with the surface. Because the surface material is cooled by the incoming air/fuel mixture and the material has a low thermal conductivity, radiant temperatures of 1,700 to 2,000°F occur only on the outer surface.<sup>63</sup> The low combustion temperature limits thermal NO<sub>x</sub> formation.

Field tests of this burner retrofitted to a 3.3 MMBtu/hr firetube boiler at Hall Chemical in Ohio showed NO<sub>x</sub> reduction of 78 percent, with controlled emission levels of 15 ppm (0.02 lb/MMBtu). Another field test conducted on an 8 MMBtu/hr boiler retrofitted with the Pyrocore burner showed 53 percent reduction in NO<sub>x</sub>, to a controlled level of 24 ppm (0.03 lb/MMBtu), while a third test on a 2 MMBtu/hr unit resulted in a controlled emission level of 17 ppm. On the average, results from five field tests and one laboratory test showed that NO<sub>x</sub> was reduced by 71 percent and CO by 94 percent.<sup>64</sup> To date, most burners supplied by Alzeta have been designed to achieve less than 30 ppm NO<sub>x</sub> at full rated load, although the actual emissions for many are reported to be below 20 ppm. Currently, the single-burner applications of this burner are limited to small packaged boilers of less than 20 MMBtu/hr because of physical limits on the size of the radiant burner. Structural issues are the major concern with larger applications. Further research and tests are being conducted to extend the

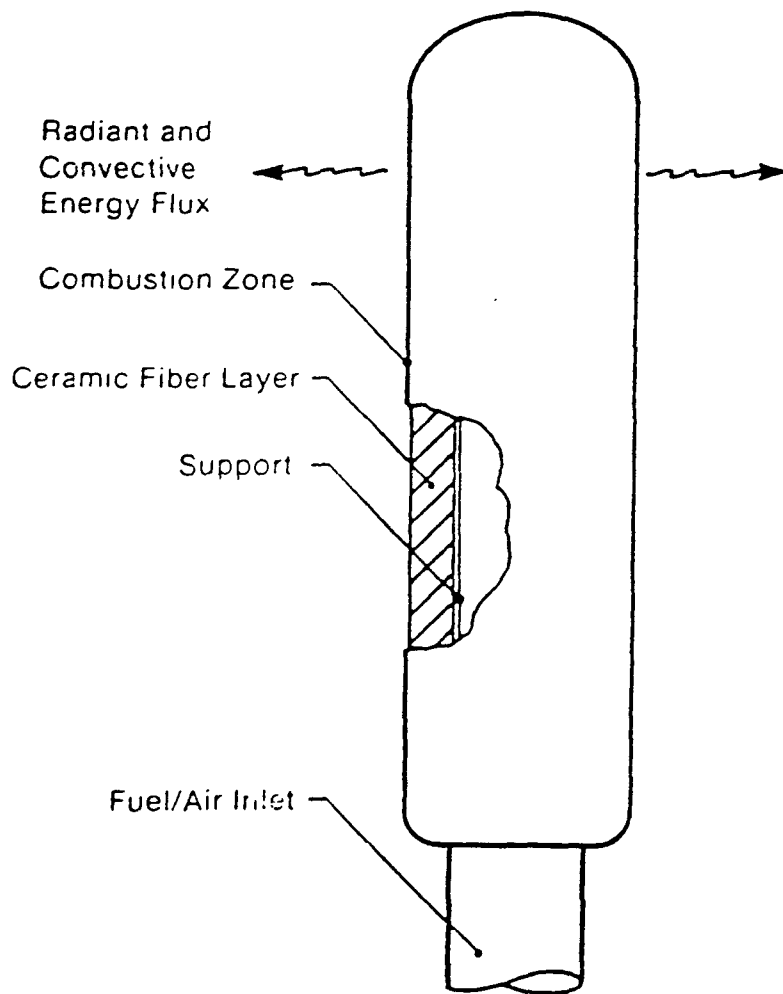

Figure 5-21. Pyrocore LNB schematic.<sup>63</sup>

Pyrocore burner's applicability to larger firetube and watertube boilers, including the use of multiple burners.

Additional research is currently focusing on the use of lower surface firing rates, moderate temperature environments, and modest excess air to attain ultra-low NO<sub>x</sub> levels of 9 ppm and below. Alzeta Corporation and Zurn Industries have recently commissioned an ultra-low-NO<sub>x</sub> boiler, the Radiant Cell Boiler™, that utilizes the Alzeta flameless Pyrocore radiant burners and has a reported capability of 9 ppm of NO<sub>x</sub> and less than 50 ppm of CO.<sup>65</sup>

### **5.3.2.3 Other LNBs**

An LNB type known as a cyclonic burner has recently been developed by York-Shipley for packaged firetube boilers. The burners are available up to 16.6 MMBtu/hr heat input. In cyclonic combustion, high tangential velocities are used in the burner to create a swirling flame pattern in the furnace. This causes intense internal mixing as well as recirculation of combustion gases, diluting the temperature of the near-stoichiometric flame and lowering thermal NO<sub>x</sub> formation. The tangential flame causes close contact between combustion gases and the furnace wall, adding a convective component to the radiant heat transfer within the furnace. The increased heat transfer and low excess air operation of the cyclonic burner result in increased boiler efficiency.

To achieve ultra-low NO<sub>x</sub> levels, a small quantity of low-pressure steam is injected into the burner, which further reduces the local flame temperature and NO<sub>x</sub> formation. Testing revealed that NO<sub>x</sub> emissions during natural gas firing could be reduced from 70 ppm to less than 20 ppm without affecting burner stability, low excess air operation, or turndown performance. However, the use of steam did result in a boiler heat efficiency loss of roughly 5 percent.<sup>66</sup> The cyclonic burner is available as a stand-alone retrofit burner with a bolt-on feature. However, no retrofit emissions data were obtained during this study.

### **5.3.3 Flue Gas Recirculation (FGR) in Natural-gas- and Oil-fired ICI Boilers**

FGR involves recycling a portion of the combustion gases from the stack to the boiler windbox. These low oxygen combustion products, when mixed with combustion air, lower the overall excess oxygen concentration and act as a heat sink to lower the peak flame temperature and the residence time at peak flame temperature. These effects result in reduced thermal NO<sub>x</sub> formation. However, there is little effect on fuel NO<sub>x</sub> emissions. The amount of NO<sub>x</sub> reduction achievable depends primarily on the fuel nitrogen content and amount of FGR used. Other thermal NO<sub>x</sub> control concepts similar to FGR are such control techniques as WI and SI, in which



water, rather than recirculated flue gas, is used as an inert substance to lower the peak flame temperature. FGR is much more commonly used, however.

FGR is currently being used on a number of watertube and firetube boilers firing natural gas. Only limited NO<sub>x</sub> reduction efficiency data are available, however, as baseline (uncontrolled) NO<sub>x</sub> data for most units are unreported. Data for four natural-gas-fired watertube boilers equipped with FGR show a range in NO<sub>x</sub> reduction of 53 to 74 percent, while for 10 gas-fired firetube units with FGR, NO<sub>x</sub> reduction efficiency ranged from 64 to 76 percent. In all, controlled NO<sub>x</sub> emission data were collected for a total of 33 gas-fired watertube and 57 gas-fired firetube units operating with FGR. Four of the watertube units and 26 of the firetube units were identified as retrofit applications. Controlled NO<sub>x</sub> levels ranged from 20 to 85 ppm (0.02 to 0.10 lb/MMBtu) for the watertube units and 16 to 37 ppm (0.02 to 0.04 lb/MMBtu) for the firetube boilers. FGR rates were typically on the order of 20 percent during these tests. However, one firetube unit—which achieved 68 percent reduction—was run on 30 percent FGR during the emissions test. Boilers are usually not operated with more than 20 percent FGR due to flame stability considerations.<sup>67</sup>

NO<sub>x</sub> reduction efficiency data for oil-fired units with FGR are also very-limited. In one test program, a single boiler was fired on both residual oil and distillate oil, using FGR and keeping all other variables constant. NO<sub>x</sub> was reduced by 68 percent for distillate oil firing, yet was only reduced by 11 percent when residual oil was used. These data illustrate that FGR is more effective when used with low nitrogen content fuels such as natural gas or distillate oil, since FGR is more effective in controlling thermal NO<sub>x</sub> rather than fuel NO<sub>x</sub>. The 68 percent reduction was obtained with a relatively high FGR rate of 28 percent. Another boiler firing distillate oil reported NO<sub>x</sub> reduction of only 20 percent, using 10 percent FGR. Available data are too limited to estimate typical NO<sub>x</sub> reduction efficiencies for oil-firing boilers with FGR. In general, however, thermal NO<sub>x</sub> reductions from distillate-oil-fired boilers with FGR are somewhat less than from natural-gas-fired units.<sup>68</sup> This is due to the greater potential for flame instability and emissions of unburned combustibles from distillate-oil-fired units, which limits the practical rate of FGR that can be used. Controlled NO<sub>x</sub> emissions for distillate oil firing with FGR were between 28 and 240 ppm (0.04 to 0.30 lb/MMBtu) for 19 boilers. For three units firing residual oil, controlled NO<sub>x</sub> levels ranged from 125 to 275 ppm (0.16 to 0.35 lb/MMBtu).

When compared to the number of LNB or combined LNB and FGR installations listed in Tables 5-7 and 5-8, the number of watertube boilers equipped only with FGR is relatively

small. In general, for retrofit cases to existing packaged watertube ICI boilers, FGR is rarely applied without the installation of a new LNB as well. This is because the performance of many older burner systems tend to be adversely affected when an inert such as fuel gas is injected into the combustion zone.<sup>57</sup> Oxygen trim systems have been installed to allow use of an existing burner with FGR and LNB together. Thus, the most common combustion modification  $\text{NO}_x$  controls for packaged watertube boilers are either LNB or combined LNB and FGR. FGR systems have been applied more commonly to smaller firetube units. A typical FGR system is shown in Figure 5-22. In order to retrofit a boiler with FGR, the major additional equipment needed are a gas recirculation fan and ducting. Major companies that supply FGR equipment for packaged gas- and oil-fired boilers are Cleaver Brooks, Coen Company, Industrial Combustion, Keeler (Tampella Power), and Todd Combustion.

#### **5.3.4 Fuel Induced Recirculation (FIR)**

Fuel induced recirculation (FIR) is a control technology for natural-gas-fired boilers recently introduced by the John Zink and Holman Boiler Companies. FIR involves the recirculation of a portion of the boiler flue gas and mixing it with the gas fuel at some point upstream of the burner. Although FIR has not yet been widely applied, it has been demonstrated commercially in an industrial unit in California, achieving  $\text{NO}_x$  emission readings as low as 17 ppm with little adverse affect on CO emissions.<sup>69</sup>

The primary difference between FIR and FGR is that in FIR the flue gas is mixed with the fuel stream, whereas in FGR the flue gas is recirculated into the combustion air. By diluting the fuel prior to combustion, which lowers the volatility of the fuel mixture, FIR reduces the concentration of hydrocarbon radicals that produce prompt  $\text{NO}$ .<sup>6</sup> Additionally, FIR reduces thermal  $\text{NO}_x$  in the same manner as FGR, by acting as a thermal diluent. Thus, one of the main benefits of FIR technology is that it impacts both prompt  $\text{NO}$  and thermal  $\text{NO}_x$  formation in gas-fired boilers.

A second fundamental feature of FIR is that flue gas recirculation is induced using the natural gas dynamics of the burner flow streams, without additional equipment such as recirculation fans. According to the manufacturer, FIR tends to be self-adjusting at various firing rates, as natural gas introduction is dependent on the mass and pressure of the fuel.<sup>70</sup>

#### **5.3.5 Staged Combustion Air (SCA) in Natural-gas- and Oil-fired ICI Boilers**

Staged combustion for oil- and natural-gas-fired boilers in the ICI sector consists of injecting a portion of the total combustion air downstream of the fuel-rich primary combustion

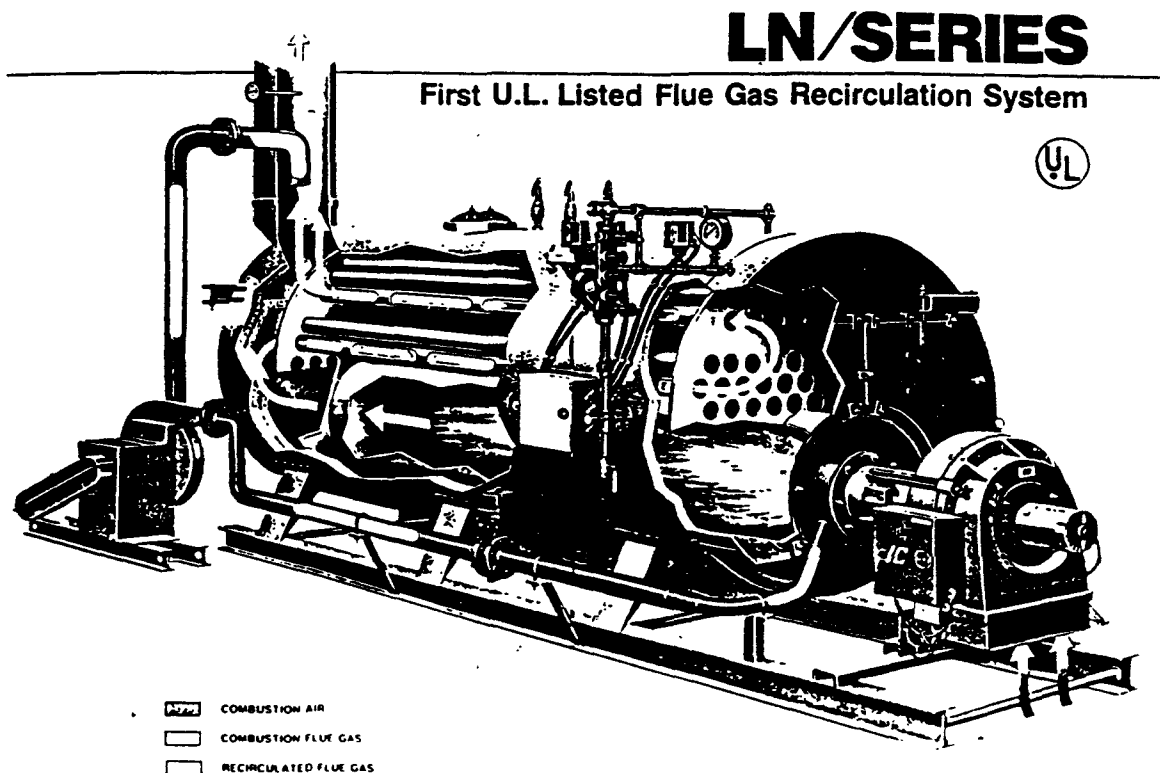

**Figure 5-22. FGR system for gas- or oil-fired boiler.<sup>71</sup>**

zone. Staged combustion can be accomplished using secondary OFA or side-fired air ports, or by using the BOOS technique. The applicability of OFA, side-fired air, or BOOS (collectively grouped under the term SCA) depends primarily on the type of furnace design involved — i.e., watertube or firetube — and the size of the boiler. Generally, SCA is not considered viable for retrofit to packaged boiler units due to installation difficulties. The following subsections summarize the performance, applicability, and availability of the various methods of implementing SCA on the major types of natural-gas- or oil-fired ICI boilers.

**5.3.5.1 Firetube Boilers**

SCA is not considered a primary NO<sub>x</sub> control method for existing firetube boilers because of the major modifications required to retrofit staged air to these boilers.<sup>72</sup> BOOS is not applicable because these units rarely have more than one burner. Side-fired air application is difficult as retrofit requires penetration of the firetube boiler water shell. Performance data are available only for one experimental application of side-fired air to a 12 MMBtu/hr firetube

boiler fired on residual oil and natural gas. In this test program, sponsored by the U.S. EPA, secondary air was injected at the rear of the furnace opposite the burner through eight pipes connected to a forced-draft fan. In this way the secondary air was independent of the primary burner air. Test results for residual oil firing showed that  $\text{NO}_x$  was reduced from 177 ppm to 90 ppm (0.22 to 0.11 lb/MMBtu), a 49 percent reduction in  $\text{NO}_x$ . During these residual oil combustion tests, the burner was operated at 76 percent of stoichiometric conditions, and the overall excess oxygen level was 4 percent.<sup>73</sup> However, boiler load was reduced to 50 percent due to combustion instabilities at high loads.

Tests conducted on the same boiler but firing natural gas at 71 percent load had almost no effect on  $\text{NO}_x$ , showing only 5 percent  $\text{NO}_x$  reduction, from 70 to 67 ppm (0.084 to 0.080 lb/MMBtu).  $\text{NO}_x$  reduction for gas-firing may not have been as high as the residual oil-firing case because of the slightly higher test load and because the burner oxygen level was higher, at 90 percent stoichiometry. Also, because natural gas combustion emits lower levels of  $\text{NO}_x$  than residual oil firing to begin with, it is generally more difficult to achieve as much percentage  $\text{NO}_x$  reduction with natural gas.

#### **5.3.5.2 Packaged Watertube Boilers**

Packaged watertube boilers generally use only one burner, so BOOS is not applicable as a means of achieving staged combustion. As was the case with firetube boilers, retrofit of SCA to smaller packaged watertube units is generally not considered a primary  $\text{NO}_x$  control option due to the difficulty of retrofitting SCA hardware. Hence, experience on these units has been limited. Data are available for two experimental retrofit applications of SCA in single-burner oil- and gas-fired packaged watertube units. The first application, in a 22 MMBtu/hr unit (Location 19), involved the injection of secondary air through four steel lances which were inserted through the windbox and the refractory firing face. At 83 percent load,  $\text{NO}_x$  emissions were reduced by 29 percent (controlled  $\text{NO}_x = 157$  ppm or 0.20 lb/MMBtu) when residual oil was fired, by 30 percent (controlled  $\text{NO}_x = 77$  ppm or 0.10 lb/MMBtu) when distillate oil was fired, and by 46 percent (controlled  $\text{NO}_x = 50$  ppm or 0.07 lb/MMBtu) when natural gas was fired.<sup>74</sup>

At the second site, identified as "Location 38," secondary air was injected into a 56 MMBtu/hr boiler through any of 10 SFA ports. This unit was equipped with combustion air preheating, which could vary the temperature from roughly 65 to 176°C (150 to 350°F). At operating conditions of 89 percent load, 2.3 percent excess oxygen, and 14 percent SCA flow,

NO<sub>x</sub> was reduced by 42 percent from the baseline, when residual oil was fired. During natural gas firing, staged combustion resulted in a reduction of 32 percent from the baseline conditions at 2.4 percent excess oxygen and 14 percent SCA.<sup>74</sup> Results from these two applications showed that in order to maximize NO<sub>x</sub> reduction using SCA in packaged watertube units, it is necessary to operate the burner at substoichiometric levels, and secondary air must be injected sufficiently downstream of the burner exit to allow for cooling of combustion gases. These types of SCA retrofits on full-scale packaged watertube boilers are generally not considered practical from installation and operational standpoints.

### **5.3.5.3 Field-erected Watertube Boilers**

For field-erected watertube boilers equipped with more than one burner, staged combustion can be achieved by using OFA, BOOS, or biased burner firing. Biased burner firing consists of firing certain burners fuel-rich while other burners are fired fuel-lean. This may be accomplished by maintaining normal air distribution to the burners while adjusting fuel flow so that more fuel is sent to desired burners. Usually, the upper row of burners is fired fuel-lean, but this varies from boiler to boiler.

BOOS is more applicable as an NO<sub>x</sub> control technique for natural-gas- and oil-fired boilers than it is for coal-fired units. As mentioned previously, with PC-fired ICI boilers the mill-burner arrangement usually determines which burners can be taken out of service. For this reason, BOOS is more often used as a maintenance operation than a direct NO<sub>x</sub> control method. In contrast, with oil or natural gas firing, burners can be shut off individually or fuel flow adjusted to achieve optimum biased burner firing or BOOS operation.

For large wall-fired units, BOOS or biased firing are attractive first level retrofit NO<sub>x</sub> control techniques because few equipment modifications are required. For natural gas firing, data compiled for three industrial boilers with BOOS showed NO<sub>x</sub> reductions ranging from 17 to 44 percent, with an average of 29 percent reduction from uncontrolled NO<sub>x</sub> levels. Controlled NO<sub>x</sub> emissions from these units, ranging in size from 60 to 120 MMBtu/hr, were between 117 and 200 ppm (0.14 and 0.27 lb/MMBtu).<sup>75</sup> For residual oil firing, data from nine boilers using BOOS showed NO<sub>x</sub> reduction efficiencies of 5 to 40 percent.

The wide range in control efficiencies is attributed to several factors, including the burner arrangement, the percentage of burners taken out of service, and the overall excess air. Some burner arrangements are more effective in reducing NO<sub>x</sub> with BOOS. For example, a

square burner matrix is more effective than an arrangement in which all of the burners are located at the same level. Another controlling factor is stoichiometry of the active burners.

Although operation with BOOS can measurably reduce  $\text{NO}_x$ , the operating performance of the boiler can be somewhat degraded because of the need to increase excess air in order to control CO, hydrocarbon, and smoke emissions.<sup>76</sup> Adjustments to the airflow controls, such as burner registers, may be required to achieve the desired burner stoichiometry without increasing these emissions. Also, operation with BOOS usually requires that the unit be derated unless modification to the fuel delivery system is made.<sup>77</sup>

Data on  $\text{NO}_x$  reductions from field-erected oil- or gas-fired ICI boilers using OFA are very limited. Controlled emissions from two units firing residual oil were from 160 to 180 ppm (0.20 to 0.23 lb/MMBtu).<sup>57</sup> Application of the technique to utility boilers in California has reportedly resulted in average  $\text{NO}_x$  reductions of 24 percent for oil and nearly 60 percent for gas.<sup>78</sup> Generally, OFA is applicable only to large furnaces with sufficient volume above the burners to allow complete combustion and steam temperature control. Because of required hardware modifications, OFA for large gas and oil wall-fired units is often not a preferred retrofit control as BOOS can offer similar reduction efficiency at less cost.<sup>79</sup>

### **5.3.6 Combined Combustion Modification $\text{NO}_x$ Controls for Natural-gas- and Oil-fired ICI Boilers**

Many retrofits have utilized combinations of the above combustion modification methods. The most demonstrated combination is the use of LNB with FGR. As mentioned earlier, retrofit of combined LNB and FGR controls to existing packaged boilers is often more feasible than using FGR alone. Also, combined retrofit of FGR and LNB to ICI boilers is considered by some to be a way of meeting stringent  $\text{NO}_x$  control regulations without using flue gas treatment controls.<sup>80</sup> Data have been collected for 101 natural-gas-fired units, 44 distillate-oil-fired boilers, and 13 residual-oil-fired boilers (see Appendices B and C). All were watertube boilers, the majority located in California. Many of the California boilers were existing units retrofitted with LNB/FGR controls.

$\text{NO}_x$  reduction efficiencies of 55 to 84 percent were reported for five units firing natural gas. No baseline uncontrolled  $\text{NO}_x$  data were available for the other boilers; thus, reduction efficiencies could not be calculated. Nearly all California units reported controlled  $\text{NO}_x$  emissions at or below 40 ppm (0.05 lb/MMBtu), while the non-California units reported  $\text{NO}_x$  levels between 40 and 170 ppm (0.05 to 0.20 lb/MMBtu). For the distillate-oil-firing units, baseline uncontrolled  $\text{NO}_x$  levels were not available; thus,  $\text{NO}_x$  reduction efficiencies could not

be determined. Controlled emissions ranged from 30 to 200 ppm (0.04 to 0.25 lb/MMBtu). For the residual-oil-firing units, controlled NO<sub>x</sub> levels were between 80 and 435 ppm (0.10 to 0.55 lb/MMBtu).

While some experience has been obtained in combining SCA with LNB or FGR, these have involved new or experimental test units. In general, applications of SCA with LNB or FGR are limited to new units because of the costs involved in installing SCA in existing units, especially in packaged boilers. The use of SCA with an LNB in a new 140 MMBtu/hr natural-gas-fired watertube boiler resulted in controlled NO<sub>x</sub> emissions of 64 ppm (0.08 lb/MMBtu), while in a new 150 MMBtu/hr residual-oil-fired boiler the controlled NO<sub>x</sub> level was 175 ppm (0.22 lb/MMBtu).<sup>81</sup> Coen Company reports controlled NO<sub>x</sub> emissions from 85 to 170 ppm (0.10 to 0.20 lb/MMBtu) for nine boilers with LNB and SCA, firing natural gas or distillate oil. For 11 units firing residual oil, NO<sub>x</sub> ranged from 160 to 315 ppm (0.20 to 0.40 lb/MMBtu).<sup>57</sup> In general, however, the retrofit of SCA is applicable mainly to large industrial boilers.

### 5.3.7 Fuel Switching

Because fuel-bound nitrogen plays such an important role in total NO<sub>x</sub> emissions from fuel combustion in boilers, switching from high-nitrogen fuels, such as coal or residual oil, to lower nitrogen fuels, such as distillate oil or natural gas, is a strategy that can be as effective in reducing NO<sub>x</sub> as any other combustion control. Low-nitrogen fuels, such as distillate oil and natural gas, can be used to displace a fraction of the coal or residual oil, or replace them entirely. In either case, significant NO<sub>x</sub> reductions are possible. For example, the cofiring of natural gas with coal in utility boilers has reduced NO<sub>x</sub> emissions by a minimum of 10 to 30 percent, depending on the boiler, coal, cofiring configuration, and amount of gas firing.<sup>82</sup> The use of 33 percent natural gas in a gas cofiring configuration in the top row of burners of a PC-fired boiler (representing a more strategic way to maximize NO<sub>x</sub> reduction efficiency with reburning techniques) can result in larger NO<sub>x</sub> reductions reaching 35 to 60 percent from uncontrolled levels.<sup>82</sup> Figure 5-23 illustrates NO<sub>x</sub> reduction as a function of gas cofiring rate, expressed as a percentage of total heat input, measured during six full-scale utility boiler cofiring field tests. These results are applicable, in theory, to large PC-fired industrial boilers.

The replacement of high-nitrogen residual oil with a lower nitrogen fuel or natural gas is also very effective in reducing NO<sub>x</sub>. To illustrate, the data shown in Table 5-10 were obtained from industrial boilers firing a residual oil first, and then switching to a distillate fuel.<sup>2</sup> NO<sub>x</sub> reductions ranged from about 50 to 80 percent for reductions in fuel oil nitrogen of

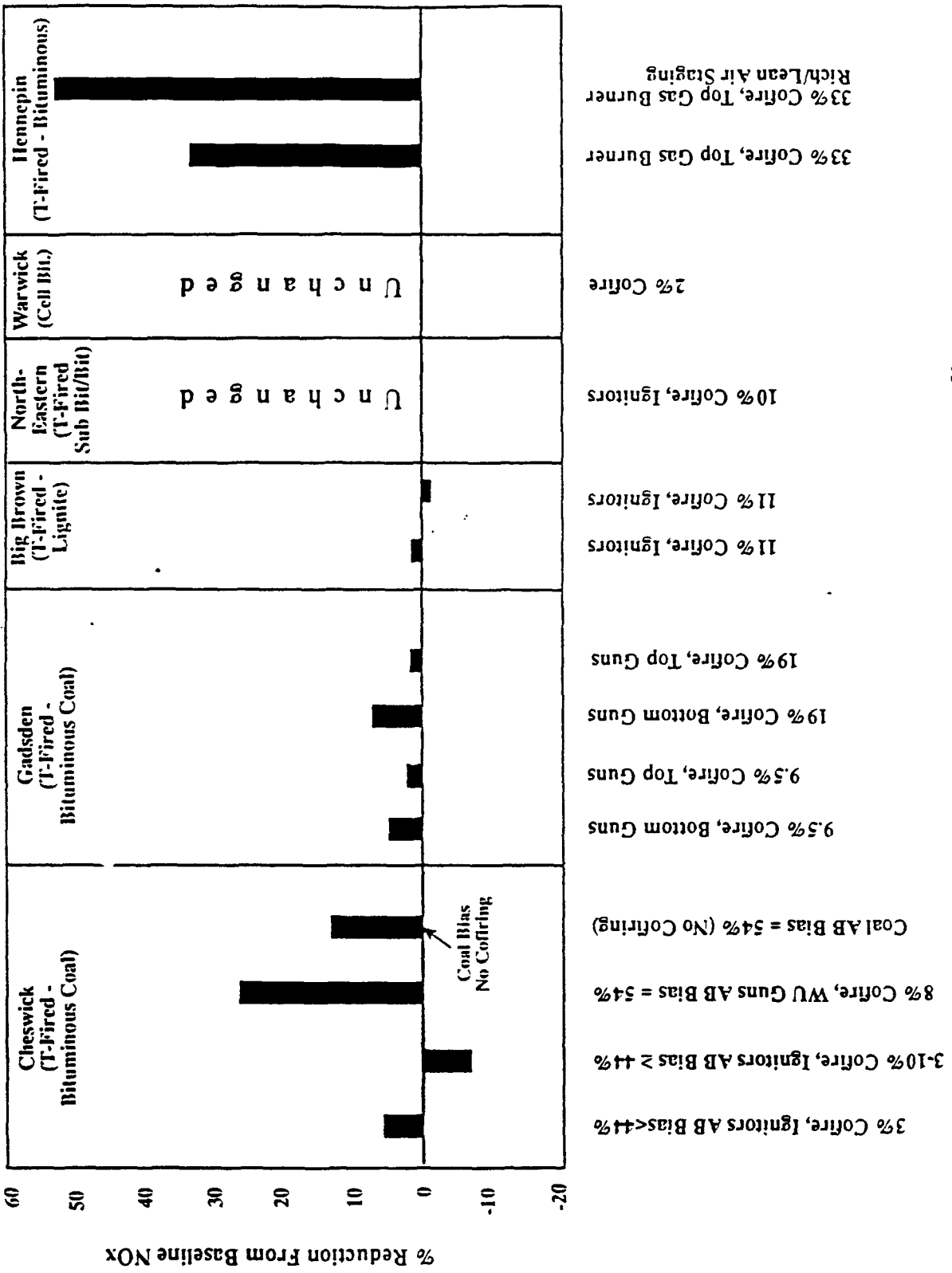

Figure 5-23. Effects of corfiring on NO<sub>x</sub> emissions.<sup>82</sup>



**TABLE 5-10. EFFECTS OF SWITCHING FROM RESIDUAL OIL TO DISTILLATE FUEL ON INDUSTRIAL BOILERS**

<b>Fuel type</b>	<b>Fuel nitrogen, % weight</b>	<b>NO<sub>x</sub> emissions @ 3% O<sub>2</sub></b>
Residual oil	0.44	350
Distillate oil	0.006	65
Residual oil	0.27	298
Distillate oil	0.015	127
Residual oil	0.20	186
Distillate oil	0.014	84
Residual oil	0.20	220
Distillate oil	0.008	114

Source: Reference 2.

approximately 0.19 to 0.436 percent by weight. If all the recorded NO<sub>x</sub> reduction is attributed to the drop in fuel nitrogen, about 55 to 65 ppm reduction in NO<sub>x</sub> results from each 0.1 percentage point reduction in the nitrogen content of the oil. Table 5-11 lists estimates of NO<sub>x</sub> reductions attainable from ICI boilers cofiring or switching to a cleaner fuel.

In addition to natural gas and low-nitrogen fuel oil, the Shell Oil Company is marketing a proprietary liquid fuel for industrial boilers. This proprietary fuel is similar to distillate oil in thermal energy and physical properties, but contrary to distillate oil it contains essentially no fuel-bound nitrogen (3 to 9 ppm). Therefore, its NO<sub>x</sub> emissions are similar to those achievable with natural gas.<sup>83</sup> Short-term performance with this proprietary fuel show FGR-controlled emissions in the range of 18 to 35 ppm corrected to 3 percent O<sub>2</sub> (0.022 to 0.042 lb/MMBtu). It is used as a standby liquid fuel for many boilers in Southern California in cases where natural gas is curtailed.

**5.3.8 Combustion Modification NO<sub>x</sub> Controls for Thermally Enhanced Oil Recovery (TEOR) Steam Generators**

NO<sub>x</sub> controls for TEOR steam generators have also been implemented primarily in California, due to stringent NO<sub>x</sub> emission regulations. For instance, in Kern County, California, over 2,000 oil field steam generators are in use, the majority fired on crude oil.<sup>84,85</sup> Other fuels

**TABLE 5-11. ESTIMATES OF NO<sub>x</sub> REDUCTIONS WITH FUEL SWITCHING**

<b>Base fuel</b>	<b>Replacement fuel</b>	<b>Quantity used, %</b>	<b>Estimated NO<sub>x</sub> reduction, %</b>
PC	Natural gas	10-20	10-30
		10-20 (reburning zone)	30-60
		100	60-70
Residual oil with 0.6% N	Natural gas	100	50-80
	Distillate oil	100	50-80
	Residual oil with 0.3% N	100	30-40

Note: All emissions data were obtained from short-term tests.

used in these boilers include natural gas and refinery gas. Nearly all units in Kern County utilize some form of combustion modification NO<sub>x</sub> control, including OT systems, LNB, or FGR.<sup>84</sup>

#### 5.3.8.1 OT Systems

OT systems or controllers limit the excess oxygen during combustion to reduce the formation of NO<sub>x</sub>. It has been reported that these devices typically reduce the formation of NO<sub>x</sub> from small steam generators (<35 MMBtu/hr input capacity) by 15 to 25 percent.<sup>86</sup> Controlled NO<sub>x</sub> emissions from 71 tests conducted on small crude-oil-fired steam generators in Kern County ranged from 166 to 398 ppm (0.21 to 0.50 lb/MMBtu).<sup>87</sup> For larger units greater than 35 MMBtu/hr (most 62.5 MMBtu/hr), Kern County data from 326 tests showed controlled NO<sub>x</sub> levels ranging between 174 and 340 ppm (0.22 and 0.43 lb/MMBtu). No uncontrolled data were reported for these units; thus, it was not possible to report actual NO<sub>x</sub> reduction efficiencies. However, assuming a typical uncontrolled NO<sub>x</sub> level of 300 ppm (0.38 lb/MMBtu), as reported in References 49 and 88 for large TEOR units in Kern County, average NO<sub>x</sub> reduction on the order of 17 percent was achieved. It should be remembered that this is only an average value, based on average emission levels and average reported baseline levels. Actual NO<sub>x</sub> reduction efficiencies may have been significantly higher or lower depending on the fuel characteristics, combustion conditions, and design type of each unit. The average levels are illustrative to a certain degree, however, as most TEOR steam generators are similar in design and all of the units tested fired Kern County crude.<sup>84</sup>

### 5.3.8.2 LNBS with SCA and OT

LNB systems, which generally are used with O<sub>2</sub> controllers, have been applied primarily to large (35 to 62.5 MMBtu/hr) crude oil-fired steam generators. The most effective and widely used LNB systems also incorporate SCA, usually using sidewire air injection. In fact with TEOR steam generators it is common to describe a combined LNB+SCA system as either an LNB or an SCA system.<sup>86,87,89</sup> Figure 5-24 depicts one type of LNB+SCA system, manufactured by the North American Company, the principal vendor of LNB systems for TEOR steamers. This burner system is being used on over 100 crude oil-fired generators in Kern County. Minor modifications are made to a standard burner and secondary air injection nozzles are inserted around the circumference of the furnace at various locations in the radiant heat transfer section. In a 62.5 MMBtu/hr steam generator, 28 secondary air injection ports are used, positioned 17 to 27 feet downstream of the burner. In most applications of this burner system, O<sub>2</sub> controllers are used to keep excess oxygen at the stack below 2 percent. NO<sub>x</sub> emission levels of 100 to 160 ppm (0.13 to 0.20 lb/MMBtu) have been reported when crude oil is fired, representing 50 to 70 percent NO<sub>x</sub> reduction when compared to unstaged conventional North American burners.<sup>89</sup>

Another type of LNB system applicable for retrofit to TEOR steam generators is the single toroidal combustor, developed by Process Combustion Corporation (Figure 5-25). The single toroidal combustor is a two-stage burner in which approximately one-third of the fuel is combusted under highly reducing, turbulent conditions inside a precombustion chamber. The remaining two-thirds of the fuel is combusted in a secondary burnout zone at the entrance to the steam generator. The second stage is arranged so that the addition and mixing of 5 to 10 percent secondary excess air takes place in the high-velocity jet of flame emitted from the chamber throat inside the firebox.<sup>90</sup> The vigorous internal recirculation and mixing within the fuel-rich precombustion chamber aids in NO<sub>x</sub> reduction, while combustion gases are entrained into the high-velocity flame of the secondary combustion zone, lowering the peak flame temperature. Results of 50 separate field tests using this burner showed average NO<sub>x</sub> reductions of 60 percent, with average emissions of 125 ppm (0.16 lb/MMBtu) for 62.5 MMBtu/hr sized units and 150 ppm (0.19 lb/MMBtu) for 25 to 30 MMBtu/hr units. Controlled NO<sub>x</sub> levels ranged from 90 to 225 ppm (0.11 to 0.28 lb/MMBtu).<sup>91</sup>

A third type of LNB for TEOR steam generators utilizes a split flame arrangement, whereby an inner fuel-rich diffusion flame is separated from an outer fuel-lean premix flame

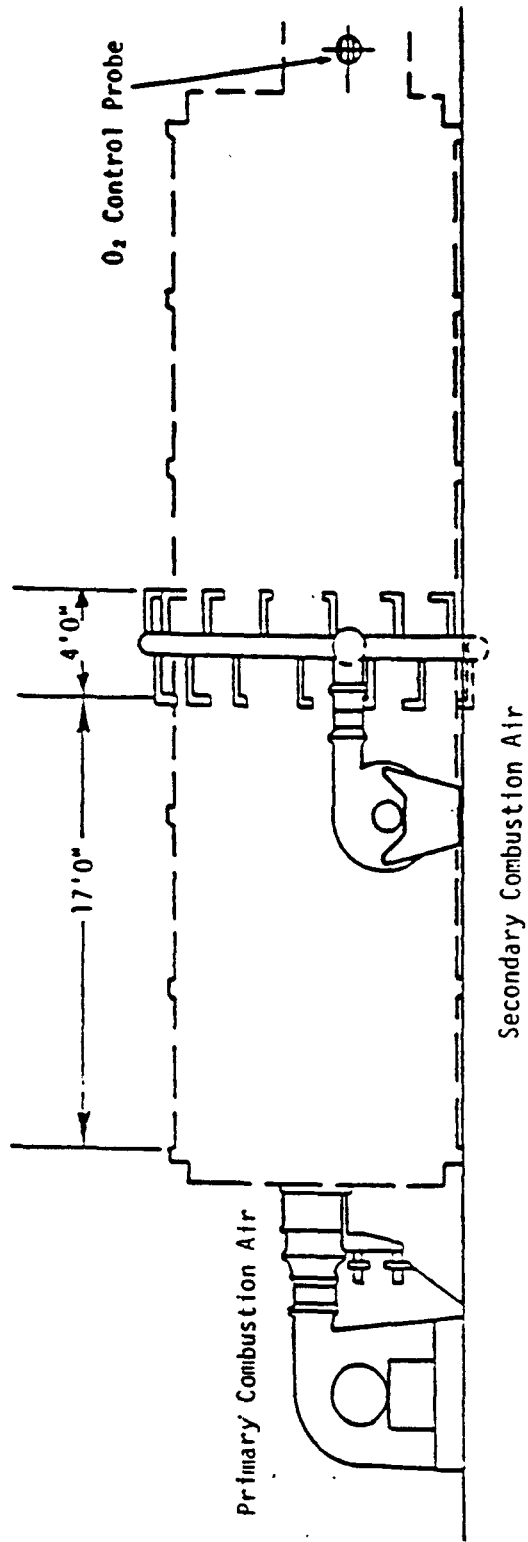

Figure 5-24. North American LNB on oil field steam generator.<sup>92</sup>

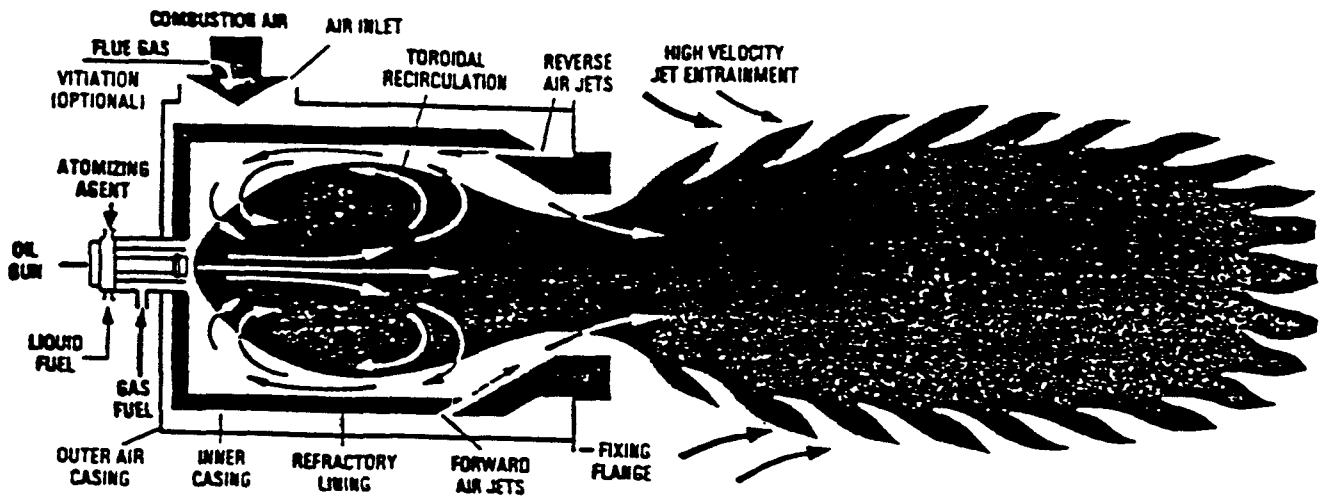

Figure 5-25. Process Combustion Corporation toroidal combustor.<sup>90</sup>

by a blanket of recirculated flue gas. This burner, the MHI PM low- $\text{NO}_x$  burner, illustrated schematically in Figure 5-26, was retrofitted to a 62.5 MMBtu/hr crude-oil-fired steam generator as part of an EPA-sponsored test program on a demonstration unit. No additional TEOR steamers have been retrofitted with this burner. Full-load  $\text{NO}_x$  emissions of 110 ppm (0.14 lb/MMBtu) were obtained with what were deemed "acceptable" smoke and CO emissions (<100 ppm CO). This compares to emissions of approximately 300 ppm (0.38 lb/MMBtu) measured from an identical generator equipped with a conventional burner.<sup>93</sup> Thus,  $\text{NO}_x$  was reduced by 63 percent.

Most LNB retrofit experiences have been with crude-oil-fired units larger than 35 MMBtu/hr. Results from 134 tests conducted on such units in Kern County show controlled  $\text{NO}_x$  levels of 87 to 232 ppm (0.11 to 0.29 lb/MMBtu). Because no baseline data were available, it was impossible to calculate  $\text{NO}_x$  reduction efficiencies for these tests. However, these controlled emissions may be compared to the generally accepted average baseline of 300 ppm for Kern County crude oil firing.<sup>84,88</sup> For illustrative purposes, comparing average controlled emissions to this average baseline, 59 percent  $\text{NO}_x$  reduction was achieved with LNB systems. Again, however, it must be remembered that actual efficiencies may have varied significantly from unit to unit. Limited test data are available for natural gas fired units equipped with LNB. Data for two 62.5 MMBtu/hr gas-fired generators showed  $\text{NO}_x$  reductions of 8 and 28 percent.

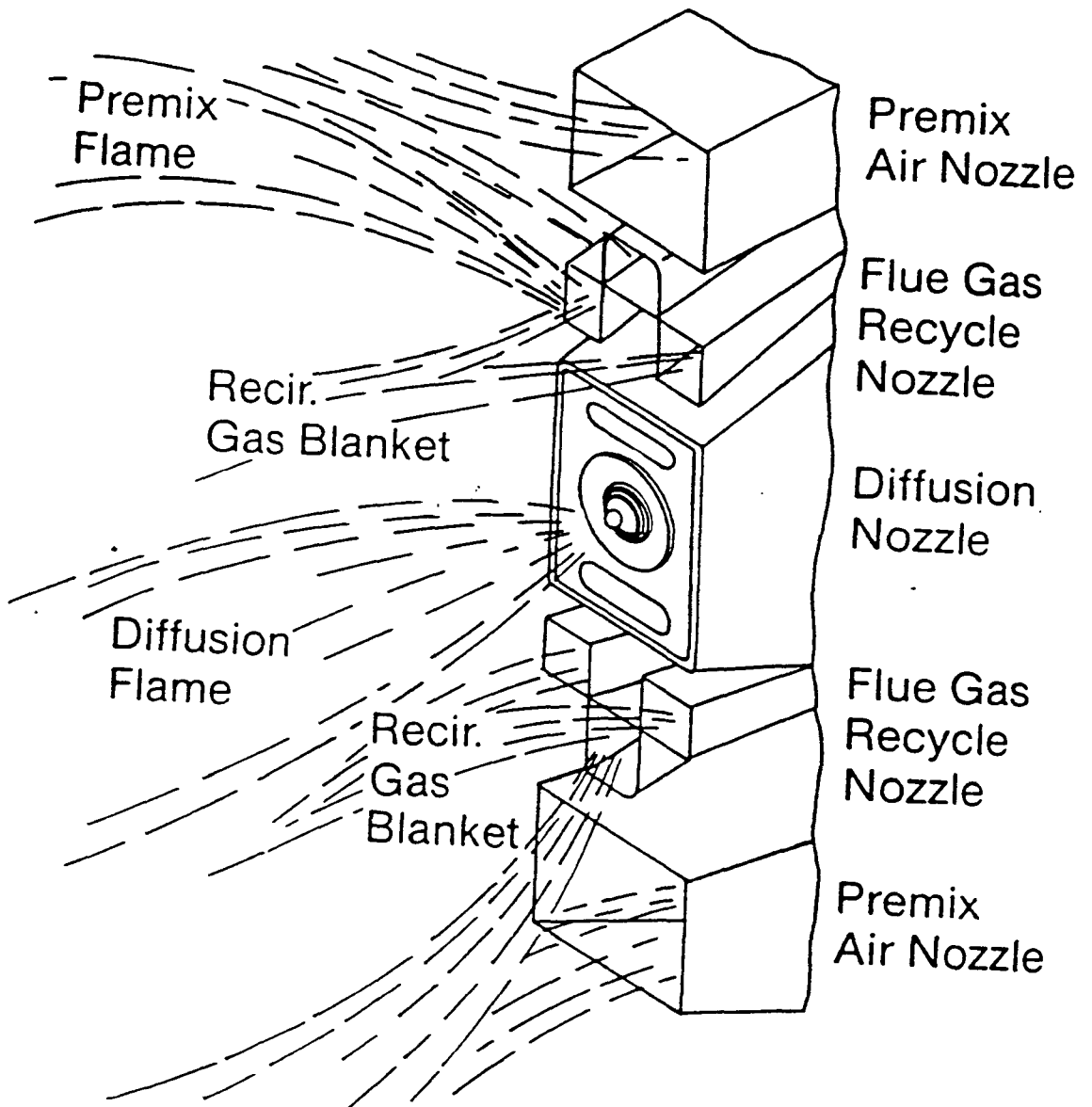

Figure 5-26. The MHI PM burner nozzle.<sup>93</sup>

Because of the limited data, however, no conclusions can be drawn about typical reduction efficiencies for LNB gas firing.

LNB systems have also been applied on a very limited basis to steam generators smaller than 35 MMBtu/hr. Reported  $\text{NO}_x$  emission reductions range from 30 to 60 percent for these units.<sup>86</sup> The limited application of LNB to small generators is due to the longer and wider flame produced by the LNB and the geometry of small steam generators. Because the radiant section in small generators is shorter in length and diameter than the radiant section in large generators, flame impingement is more of a problem.<sup>86</sup> Thus, LNB retrofits are primarily applicable to TEOR steam generators larger than 35 MMBtu/hr.

### 5.3.8.3 FGR and OT

FGR systems have been applied to TEOR steam generators on a more limited basis than LNB systems. Results from Kern County tests of 36 crude-oil-fired steam generators with FGR and  $\text{O}_2$  trim showed controlled  $\text{NO}_x$  levels similar to those obtained with LNB systems, ranging from 79 to 264 ppm (0.10 to 0.33 lb/MMBtu).<sup>87</sup> Thus, for crude oil firing, FGR controls appear as effective as LNB systems in reducing  $\text{NO}_x$ . For natural gas firing, tests of three large units using FGR in combination with LNB measured controlled emission levels of 25 to 35 ppm (0.03 to 0.04 lb/MMBtu).  $\text{NO}_x$  reduction for two of these units ranged from 50 to 68 percent. For these particular units, these reductions in  $\text{NO}_x$  represent significant improvement over  $\text{NO}_x$  reduction efficiencies obtained using LNB alone.<sup>56,88</sup> Data are too limited, however, to characterize the performance of FGR controls used with natural-gas-fired TEOR steam generators.

### 5.3.9 Gas Fuel Flow Modifiers

In addition to the combustion techniques discussed thus far, a device known as a gas turbulator has been demonstrated to reduce  $\text{NO}_x$  formation in natural-gas-fired packaged boilers. Originally designed to produce savings in fuel consumption, the turbulator is a small stainless steel venturi incorporating strategically placed fins. The turbulator is inserted in the gas pipe directly upstream of the burner, creating highly turbulent fuel flow. This turbulence facilitates the bonding of hydrocarbon particles with the oxygen molecules of the combustion air, resulting in increased combustion efficiency.<sup>94</sup> Fuel savings typically range between 2 and 10 percent, but have been as high as 35 percent.<sup>95</sup>

From an  $\text{NO}_x$  standpoint, the more efficient turbulent mixing of the fuel and air results in lower excess air requirements for efficient combustion, producing lower levels of  $\text{NO}_x$ .<sup>94,95</sup>

The only turbulator-related NO<sub>x</sub> emissions data available to date are for a 33.5 MMBtu/hr natural-gas-fired firetube boiler at Duncan Boiler Service, Inc., in Kenner, Louisiana. At this site, the use of a turbulator raised full-load boiler efficiency by 3 percent, and the improved air/fuel mixing reduced the required excess oxygen by 27 percent. Consequently, NO<sub>x</sub> emissions were reduced from 58 to 35 ppm at 3-percent oxygen, a 40-percent decrease.<sup>96</sup>

#### 5.4 COMBUSTION MODIFICATIONS FOR NONFOSSIL-FUEL-FIRED ICI BOILERS

Application of combustion modification NO<sub>x</sub> controls to nonfossil-fuel-fired ICI boilers is very limited. Many waste-fuel-fired boilers are not easily modified to reduce NO<sub>x</sub> without compromising combustion efficiency and byproduct emissions. Furthermore, nonfossil fuels include a variety of waste fuels with varying combustion characteristics and pollutant profiles. Consequently, adaptation of conventional combustion controls can be difficult and very site-specific. Currently, more attention has focused on the application of flue gas treatment controls to nonfossil-fuel-fired ICI boilers, especially in California, where flue gas treatment controls have been applied to at least 17 units fired on wood or MSW. These applications are discussed in Section 5.3.

Combustion modification retrofit experience has been limited to the use of SCA. In one wood-/natural-gas-fired overfeed stoker unit, equipped with four gas burners as well as a traveling grate for wood firing, staged combustion was achieved by removing one of the four gas burners from service. Although 20 percent NO<sub>x</sub> reduction was achieved, it should be noted that combustion modification was applied to the gas burners without any change to the wood-firing stoker system. This control approach would not be possible on boilers without supplemental gas firing. Difficulties were experienced with fluctuating bark flows, resulting in unsteady combustion conditions.<sup>74</sup>

Applications of combustion modifications to new nonfossil-fuel-fired units involve MSW-fired boilers equipped with FGR and natural gas reburn controls. Gas reburn for MSW boilers is being developed by Riley Stoker and Takuma Company, for NO<sub>x</sub> control purposes and to suppress the formation of air toxic organics and combustible emissions.<sup>97</sup> In a 45 MMBtu/hr overfeed stoker MSW facility in Minnesota, NO<sub>x</sub> emissions were reduced by 40 percent using FGR. When natural gas reburn was used in combination with FGR, NO<sub>x</sub> was reduced by 60 percent, to a controlled level below 50 ppm. CO emissions were also decreased by 50 percent, to levels below 25 ppm. Natural gas reburn represented 12 to 15 percent of the total heat input, and FGR rates during these tests were roughly 8 percent.<sup>97</sup> Test results from a pilot-scale



MSW-fired stoker boiler equipped with FGR and natural gas reburn showed 49 percent NO<sub>x</sub> reduction efficiency, utilizing 17 percent FGR.<sup>98,99</sup> Because of the limited documented experiences regarding the retrofit of combustion modifications to existing nonfossil-fuel-fired boilers, no meaningful conclusions can be reached as far as NO<sub>x</sub> control effectiveness or feasibility.

## **5.5 FLUE GAS TREATMENT NO<sub>x</sub> CONTROLS FOR ICI BOILERS**

NO<sub>x</sub> control with flue gas treatment involves the reduction of NO<sub>x</sub> in the flue gas by injecting a chemical reducing agent into the post-combustion region of a combustion unit. The reducing agents, primarily ammonia and urea, convert the NO in the flue gas to molecular nitrogen at high temperatures, between 870 and 1,100°C (1,600 and 2,000°F), without a catalyst. When a catalyst is used, this conversion takes place at a lower temperature range, roughly 300 and 425°C (575 to 800°F). Flue gas treatment methods without a catalyst are SNCR, while those with a catalyst are termed SCR. These methods are discussed in the following subsections.

Retrofitting these technologies to boilers typically involves installation of reagent injection nozzles, reagent storage and control equipment, and, in the case of SCR, catalytic reactors. Because flue gas treatment NO<sub>x</sub> reduction efficiency depends in large part on flue gas temperature, injection nozzle placement is limited to those locations where acceptable process temperatures are present. Generally, in packaged ICI boilers, available locations for reagent injection and catalyst placement are further limited by space considerations. These units may also operate with wide ranges in boiler steam load that cause flue gas temperature shifts outside the optimum temperature window. Injection of reagents outside the optimum reaction temperature window results in lowered NO<sub>x</sub> reduction efficiency and emissions of unreacted ammonia. SNCR and SCR controls have been applied primarily to larger boilers or new packaged boilers because these applications offer better control of temperature window and steady load demands.

### **5.5.1 Selective Noncatalytic Reduction (SNCR)**

Two primary types of SNCR control technologies are currently available for retrofit to ICI boilers. The first is based on the use of ammonia (NH<sub>3</sub>) as the reducing agent, while the second, more recently introduced, is based on the use of urea (NH<sub>2</sub>CONH<sub>2</sub>). Several urea-based systems have been patented and are commercially offered by several domestic vendors. The following subsections briefly describe the experience to date using these controls on ICI boilers. Available data for SNCR application to industrial boilers are contained in Appendix B and

summarized in Table 5-12. Generally, similar  $\text{NO}_x$  reduction efficiencies were obtained whether ammonia or urea was used. For ammonia injection,  $\text{NO}_x$  reduction ranged from 50 to 80 percent, depending on fuel type. For urea-based systems, most reported  $\text{NO}_x$  reduction efficiencies also fell within this range, although some were as low as 25 percent and as high as 88 percent. Experience with SNCR on smaller capacity boilers is minimal. Low-load operation and frequent load changes on such boilers pose additional complexities on the retrofit of SNCR for these boilers.

#### 5.5.1.1 Ammonia-based SNCR

Exxon Research and Engineering Company developed and patented an ammonia-based SNCR process known as Thermal De $\text{NO}_x$ .<sup>99</sup> The Thermal De $\text{NO}_x$  process is based on a gas phase homogeneous reaction between  $\text{NO}_x$  and ammonia which produces molecular nitrogen and water at high temperature. In this process, aqueous or anhydrous ammonia is vaporized and injected into the flue gas through wall-mounted nozzles at a location selected for optimum reaction temperature and residence time. The optimum reaction temperature range for this process is 870 to 1,100°C (1,600 to 2,000°F), although this can be lowered to 700°C (1,300°F) with additional injection of gaseous hydrogen.<sup>100</sup> At temperatures above 1,100°C (2,000°F), ammonia injection becomes counterproductive, resulting in additional NO formation. Below 870°C (1,600°F), the reaction rate drops and undesired amounts of ammonia are carried out in the flue gas. Unreacted ammonia is commonly referred to as ammonia slip, breakthrough, or carryover.<sup>101</sup> The amount of ammonia slip also depends in part on the amount of ammonia injected. Although the chemical reaction requires one mole of  $\text{NH}_3$  for each mole of NO, the  $\text{NH}_3/\text{NO}_x$  ratio used is usually greater than 1 to avoid an undesired reaction which results in formation of NO.<sup>100</sup>  $\text{NH}_3/\text{NO}_x$  ratios of 4 to 1 have been reported in fluidized bed applications.<sup>102</sup> Ratios used are usually greater than 1 due to competing reactions at the temperatures involved.

The Thermal De $\text{NO}_x$  process has been applied to a number of boilers firing both fossil and nonfossil fuels. In the U.S., most Thermal De $\text{NO}_x$  applications have been on new units, many located in California. At least two retrofit applications on wood-fired industrial boilers have also been reported, one to a 375 MMBtu/hr wood-fired stoker unit and one to a 210 MMBtu/hr boiler, also a wood-fired stoker.<sup>100</sup> Both retrofits resulted in 50 percent  $\text{NO}_x$  reduction, with controlled emissions of 45 and 50 ppm (0.06 and 0.07 lb/MMBtu).

TABLE 5-12. SNCR NO<sub>x</sub> CONTROL FOR ICI BOILERS

Reagent	Description of technique	Fuel type	Number of industrial boilers tested	% NO <sub>x</sub> reduction	Controlled NO <sub>x</sub> levels		Comments		
					ppm @ 3% O <sub>2</sub>	lb/MMBtu			
Ammonia	Injection of ammonia into flue gas to chemically reduce NO <sub>x</sub>	Natural gas/oil	11 FE-WT <sup>a</sup>	50-72	25-160	0.03-0.20	Temperature window between 870 and 1,100°C (1,600 and 2,000°F). Most data are for Thermal DeNO <sub>x</sub> <sup>e</sup> .		
			5 PKG-WT <sup>b</sup>	30-65	N.A. <sup>c</sup>	N.A.			
		Coal	4 FBC	76-80	30-65	0.04-0.087			
			4 stoker	50-66	110-132	0.15-0.18			
Wood			1 PC <sup>d</sup>	57	135	0.18			
			10 stoker	50-80	25-160	0.035-0.23			
			8 FBC	44-80	24-140	0.035-0.20			
MSW			13 stoker	45-79	48-195	0.068-0.28			
Urea	Injection of urea into flue gas to chemically reduce NO <sub>x</sub>	Natural gas/oil	7 FE-WT	50-60	41-104	0.049-0.13	Most data are for NOxOUT <sup>e</sup> .		
			4 FBC	57-88	21-106	0.028-0.14			
		Coal	4 PC	30-83	110-300	0.15-0.41			
			9 stoker	40-74	105-210	0.14-0.28			
		Wood	14 stoker	25-78	60-118	0.084-0.17			
			2 PKG-WT	50	178-187	0.24-0.26			
			2 FBC	60-70	45-50	0.063-0.070			
		MSW			1 cell	52		96	0.14
					13 stoker	41-75		44-210	0.062-0.30

<sup>a</sup>FE-WT = field-erected watertube.

<sup>b</sup>PKG-WT = packaged watertube.

<sup>c</sup>N.A. = Not available in reference source used.

<sup>d</sup>Boiler burning coke in Japan.

Overall, experience with ammonia-based SNCR on both new and existing units has shown the following results, listed in Table 5-12.  $\text{NO}_x$  reduction ranged from 50 to 80 percent for 10 wood-firing stokers and between 44 and 80 percent for eight wood-firing FBC units. For 13 MSW-fired units,  $\text{NO}_x$  reduction ranged from 45 to 79 percent, while for four coal-fired FBC units, 76 to 80 percent reductions were achieved. Several natural-gas-fired furnaces experienced 30 to 72 percent  $\text{NO}_x$  reduction. In addition to these applications, it has been reported that ammonia-based SNCR has been used on over 100 TEOR steam generators burning crude oil in Kern County, achieving reductions of approximately 70 percent.<sup>103</sup> Thus, for all applications, ammonia-based De $\text{NO}_x$  reduced  $\text{NO}_x$  by roughly 30 to 80 percent. The upper range of  $\text{NO}_x$  reduction efficiency range is more characteristic of boilers operating at steady load such as cogeneration FBC units.

Achievable  $\text{NO}_x$  reductions for an individual boiler depend on the flue gas temperature, the residence time at that temperature, the initial  $\text{NO}_x$  concentration, the  $\text{NH}_3/\text{NO}_x$  ratio, the excess oxygen level, and the degree of ammonia/flue gas mixing. Also, stratification of both temperature and  $\text{NO}_x$  in the flue gas can affect the performance of the SNCR control.<sup>104</sup> The optimum placement of SNCR injectors requires a detailed mapping of the temperature profile in the convective passes of the boiler, because of the narrow temperature window. According to Exxon, the Thermal De $\text{NO}_x$  process has no measurable effect on  $\text{CO}$ ,  $\text{CO}_2$ , or  $\text{SO}_x$  emissions.<sup>100</sup>

The feasibility of retrofitting an existing boiler with SNCR often hinges on the ability to accommodate injection nozzles at a location where flue gas temperatures and residence time are optimum for the reaction to take place. In field-erected boilers, the ammonia is usually injected into either a superheater tube bank or between a superheater tube bank and the steam generator tube bank,<sup>103</sup> while, for a typical wood-fired stoker boiler, injectors are usually located before the first superheater coil. In a coal or wood-fired CFBC boiler, ammonia injectors are usually located after the cyclone to avoid high solids and  $\text{NH}_3$  recirculation.<sup>100</sup> Smaller units, especially packaged watertube and firetube boilers, have limited space and access for the injection nozzles.

#### **5.5.1.2 Urea-based SNCR**

Originally developed by the Electric Power Research Institute (EPRI), a newer SNCR technology for flue gas treatment  $\text{NO}_x$  control utilizes urea as a reagent rather than ammonia. One urea-based SNCR process, known by the trade name of NOxOUT<sup>®</sup>, is offered by Nalco

Fuel Tech, Inc., and its licensees (Foster Wheeler, Wheelabrator Air Pollution Control, Research Cottrell, Todd Combustion, RJM Corporation, and several others internationally). Other vendors, such as Applied Utility Systems and Noell, Inc., have also developed and installed urea-based SNCR processes. In the NO<sub>x</sub>OUT process, an aqueous solution containing urea and chemical enhancers is injected into the furnace or boiler at one or more locations, depending on the boiler type and size. The urea reacts with NO<sub>x</sub> in the flue gas to produce nitrogen, carbon dioxide, and water. The main advantage of urea injection over ammonia injection is that urea is a nontoxic liquid that can be safely stored and handled.

Like ammonia injection, NO<sub>x</sub>OUT is effective only within a certain temperature range. Without the use of chemical enhancers, urea injection effectively reduces NO<sub>x</sub> at temperatures between 900 and 1,150°C (1,650 and 2,100°F). Residence time at temperature of interest is important. By using proprietary enhancers and adjusting concentrations, greater NO<sub>x</sub> reduction efficiency can be achieved over a wider temperature window. If the urea is released at too high a temperature, the chemical species can actually be oxidized to form NO<sub>x</sub>. Below this temperature, urea reacts with NO<sub>x</sub> to form undesired amounts of ammonia. Table 5-12 lists NO<sub>x</sub> reduction efficiencies of 25 to 88 percent, reported for different types of boilers burning coal, oil, MSW, and wood which have been retrofitted with urea injection. As with Thermal DeNO<sub>x</sub>, actual reduction performance is highly dependent on temperature, amount of reagent used, and level of reagent/NO<sub>x</sub> mixing.<sup>105</sup> Most of the commercial experience includes MSW-, wood-, and coal-fired stokers, and gas-fired boilers and incinerators. These applications have been on new and existing units. Successful demonstrations are documented on oil- and coal-fired boilers in the utility industry. NO<sub>x</sub> reductions of as low as 10 percent to as high as 76 percent have been recorded for utility boilers. An average NO<sub>x</sub> reduction performance of 45 percent is estimated for PC-fired boilers.<sup>106</sup> Due to residence time and temperature constraints, small packaged watertube and firetube boilers with fluctuating steam loads are difficult applications, and require case-by-case determinations for cost and performance levels.

### **5.5.2 Selective Catalytic Reduction (SCR)**

The SCR process takes advantage of the selectivity of ammonia to reduce NO<sub>x</sub> to nitrogen and water at lower temperature in the presence of a catalytic surface. Two catalyst formulations are denoted "base metal," this category including oxides of titanium, molybdenum, tungsten, and vanadium, and zeolites, which are alumina-silicate-based. These formulations may include other components that impart structural stability. Catalysts come in various shapes and

sizes, according to the particular application. Gaseous ammonia is injected with a carrier gas, typically steam or compressed air, into the flue gas upstream of the catalyst. The ammonia/flue gas mixture enters the catalyst, where it is distributed through the catalytic bed. The flue gas then leaves the catalytic reactor and continues to the exit stack or air preheater. SCR technology is capable of achieving similar NO<sub>x</sub> reductions as Thermal DeNO<sub>x</sub> SNCR using a much smaller amount of ammonia, due to the positive effects of the lower reaction temperature and the selective catalyst.<sup>101</sup> Because of this, ammonia slip tends to be less with SCR than with SNCR.

SCR operates most efficiently at temperatures between 300 and 425°C (575 and 800°F) and when the flue gas is relatively free of particulate matter, which tends to contaminate or "poison" the catalytic surfaces.<sup>101,107</sup> Recent catalyst formulations can resist poisoning and abrasion in flue gas environments with high ash loading and trace metals, while maintaining NO<sub>x</sub> reduction performance. Typically, the catalytic reactor is located ahead of the air heater, to take advantage of the temperature regime. Sometimes, however, the reactor may be placed just ahead of the stack and downstream of particulate collection devices, avoiding catalyst contamination. In most cases, however, such placement requires reheating of the flue gas to meet temperature requirements, impacting the cost of the system. To avoid reheat requirements, some manufacturers are currently developing or have already developed special low-temperature catalysts which can be used at temperatures as low as 200°C (400°F).<sup>107</sup>

SCR has seen very limited application on domestic ICI boilers. Table 5-13 shows a selected list of SCR applications on industrial boilers in California. A more complete list of SCR installations on ICI boilers is included in Appendix B. Most of the industrial applications of this control technology have been in Japan, where much of the original SCR technology development took place. Within the industrial sector, SCR has been applied primarily to gas- or oil-fired units, as well as a few PC-fired units or coal-fired BFBCs. SCR has not yet been demonstrated in CFBC units or stoker coal-fired boilers. However, it was recently announced that SCR will be incorporated into the design of a 220 MWe stoker coal-fired power plant in Virginia, as well as a 125 MWe CFBC in Sweden.<sup>108,109</sup> Major suppliers of SCR catalysts include MHI, Babcock Hitachi, Cormetech, Engelhard, Johnson Matthey, and Norton.

Table 5-14 summarizes performance data for SCR applications to boilers in the ICI sector. Data from Japanese oil-fired industrial boilers retrofitted with SCR show NO<sub>x</sub> reductions ranging from 85 to 90 percent. These units had controlled NO<sub>x</sub> levels between 17 and 25 ppm (0.02 and 0.03 lb/MMBtu), operating with flue gas treatment temperatures of 300 to 370°C (575

**TABLE 5-13. SELECTED SCR INSTALLATIONS, CALIFORNIA ICI BOILERS**

Boiler ID	Boiler type	Capacity, MMBtu/hr	Fuel used	Controlled NO <sub>x</sub> emissions	
				ppm @ 3% O <sub>2</sub>	lb/MMBtu
Darling-Delaware	PKG-WT <sup>a</sup>	110	Natural gas/ propane	9	0.011
Fletcher Oil and Refining	Unknown	49	Distillate oil	20	0.025
Lockheed	PKG-WT	N.A. <sup>b</sup>	Natural gas/ distillate oil	9	0.011
Kalkan Foods, Inc.	PKG-WT	78.6	Natural gas/ methanol	9	0.011
Ultramar Refinery	PKG-WT	N.A.	Refinery gas	11	0.011
Southern California Edison	Unknown	107 MWe	Natural gas	20	0.024

<sup>a</sup>PKG-WT = Packaged watertube boiler.

<sup>b</sup>N.A. = Not available.

**TABLE 5-14. SCR NO<sub>x</sub> CONTROLS FOR ICI BOILERS**

Description of technique	Fuel type	Number of industrial boilers tested	% NO <sub>x</sub> reduction	Controlled levels		Comments
				ppm @ 3% O <sub>2</sub>	lb/MMBtu	
Injection of ammonia into flue gas to chemically reduce NO <sub>x</sub>	Oil	7	85-90	17-25	0.022-0.032	Temperature window between 300 and 425°C (575 and 800°F).
	Natural Gas	3	53-80	9-46	0.011-0.055	
	Coal	2	53-63	72-110	0.097-0.15	
	Ref. gas	4	83-94	9-11	0.011-0.013	
	MSW	1	53	36	0.051	
	Wood waste	2	80	154	0.22	

to 700°F).<sup>109</sup> Specific information was not available on the types of oil fired in these boilers or on boiler operating conditions; therefore, these reported NO<sub>x</sub> levels should not be used to extrapolate controlled NO<sub>x</sub> levels for all oil-fired boilers.

Similar reduction efficiencies of 83 and 94 percent were obtained on units firing refinery gas.<sup>110</sup> One of these units was located in Japan, the others at a California refinery. Results from tests conducted on three natural-gas- and two coal-fired boilers with SCR showed more moderate reduction efficiencies of 53 to 80 percent. Likewise, a single MSW-fired unit experienced 53 percent NO<sub>x</sub> reduction with SCR.<sup>101</sup> In summary, NO<sub>x</sub> reduction efficiencies with SCR have been reported in the range between 53 and 90 percent. Available data are too limited, however, to allow any correlations between fuel type, boiler type, and SCR effectiveness to be made.

The retrofit of SCR to an existing boiler requires far more extensive modifications than does SNCR, as the SCR reactor must be placed in the existing flue gas path where the temperature is sufficiently high for efficient NO<sub>x</sub> control. This is in addition to the required installation of reagent injectors and storage and control equipment. The difficulty in retrofitting SCR to existing boilers was reflected in the compliance plans put forth by petroleum refiners in California's South Coast Air Basin, in response to the SCAQMD Rule 1109. Rather than retrofit existing boilers with SCR, many refiners instead opted to replace their old boilers with new units already incorporating SCR.<sup>111</sup> Because catalysts lose their effectiveness over time due to contamination or clogging of catalyst pores, they must be replaced periodically. On large boilers, it has been reported that catalyst replacement may be necessary every 1 to 5 years, depending on the application and the level of contaminants in the fuel.<sup>112</sup>

## 5.6 SUMMARY OF NO<sub>x</sub> REDUCTION PERFORMANCE

Table 5-15 summarizes the reduction efficiencies and controlled NO<sub>x</sub> levels for each boiler, fuel, and control combination investigated in this report. Arithmetic average performances are listed, but care must be used in interpreting them. Because these are averages, the data do not represent the NO<sub>x</sub> control performance attainable in all cases. Actual performance will be influenced by several factors, including fuel type, degree of control applied, and the boiler's design and operating condition. Because coal and residual oil can vary in nitrogen content and other properties, the actual NO<sub>x</sub> level achieved with these fuels will be very much a function of these fuel properties. Certainly, the degree of FGR and air staging applied,



TABLE 5-15. SUMMARY OF NO<sub>x</sub> REDUCTION PERFORMANCE

Boiler and fuel	NO <sub>x</sub> control	Range in performance		Average performance <sup>a</sup>	
		Reduction efficiency, %	Controlled NO <sub>x</sub> , lb/MMBtu	Reduction efficiency, %	Controlled NO <sub>x</sub> , lb/MMBtu
PC-fired boilers: all firing types with wall or corner burners	SCA	15-39	0.33-0.93	27	0.62
	LNB	18-67	0.26-0.50	55	0.35
	Reburn + OFA	30-65	0.23-0.52	52	0.34
	LNB + SCA	42-66	0.24-0.49	60	0.38
	SNCR	30-83	0.15-0.40	45 <sup>b</sup>	0.39
Coal-fired stokers	SCA	-1-35	0.22-0.52	18	0.38
	FGR + SCA	0-60	0.19-0.47	24	0.54
	SNCR	40-74	0.14-0.28	58	0.22
Coal-fired FBC	SCA	40-67	0.05-0.45	58	0.18
	FGR + SCA	N.A. <sup>c</sup>	0.12-0.16	N.A.	0.14
	SNCR	57-88	0.03-0.14	74	0.08
	SCR	53-63	0.10-0.15	60	0.12
Gas-fired firetube	LNB	32-78	0.02-0.08	50	0.03
	Radiant LNB	53-82	0.011-0.036	71	0.02
	FGR	55-76	0.02-0.08	65	0.07
	LNB + FGR	N.A.	0.02-0.04	N.A.	0.03
Gas-fired SBWT <sup>d,e</sup>	WI	50-77	0.04-0.056	64	0.05
	FGR	53-74	0.02-0.08	64	0.05
	LNB	46-71	0.03-0.11	58	0.08
	LNB + FGR	55-84	0.018-0.09	76	0.06
	SCR	80-91	0.011-0.06	85	0.024

(continued)

<sup>a</sup>Arithmetic averages of reported control efficiency NO<sub>x</sub> levels with specified controls. Values do not necessarily reflect emission targets that can be achieved in all cases.

<sup>b</sup>Average NO<sub>x</sub> reduction is based on utility boiler PC experience.

<sup>c</sup>N.A. = Not available.

<sup>d</sup>SBWT = Single-burner watertube. Also referred to as packaged watertube (PKG-WT).

<sup>e</sup>Data for gas- and oil-fired watertube boilers are limited to performance reported in Appendix B, exclusive of equipment vendor data reported in Appendix C.

TABLE 5-15. (continued)

Boiler and fuel	NO <sub>x</sub> control	Range in performance		Average performance <sup>a</sup>	
		Reduction efficiency, %	Controlled NO <sub>x</sub> , lb/MMBtu	Reduction efficiency, %	Controlled NO <sub>x</sub> , lb/MMBtu
Gas-fired MBWT <sup>e,f</sup>	SCA (BOOS)	17-46	0.06-0.24	31	0.15
	LNB <sup>g</sup>	39-52	0.10-0.17	46	0.12
	SNCR	50-72	0.03-0.19	58	0.10
	SCR <sup>h</sup>	N.A. <sup>c</sup>	0.024	N.A.	0.024
	LNB + SCA	N.A.	0.10-0.20	N.A.	0.15
Distillate firetube	LNB <sup>g</sup>	15	0.15	15	0.15
	FGR	N.A.	0.04-0.16	N.A.	0.12
Distillate SBWT <sup>d,e</sup>	LNB	N.A.	0.08-0.33	N.A.	0.10
	FGR	20-68	0.04-0.15	44	0.08
	LNB + FGR	N.A.	0.03-0.13	N.A.	0.07
	SCR <sup>h</sup>	N.A.	0.011	N.A.	0.011
Residual oil firetube	LNB <sup>i</sup>	30-60 <sup>j</sup>	0.09-0.25	40	0.17
Residual oil SBWT <sup>d,e</sup>	LNB	30-60	0.09-0.23	40	0.19
	FGR	4-30	0.12-0.25	15	0.17
	LNB + FGR <sup>h</sup>	N.A.	0.23	N.A.	0.23
Residual oil MBWT <sup>e,f</sup>	SCA	5-40	0.22-0.74	20	0.34
	LNB <sup>i</sup>	30-60	0.09-0.23	40	0.19
	LNB + SCA <sup>h</sup>	N.A.	0.22	N.A.	0.22
	SCR <sup>i</sup>	58-90	0.025-0.15	85	0.045
Wood-fired stoker	SNCR	25-80	0.04-0.23	58	0.13
Wood-fired FBC	SNCR	44-80	0.035-0.20	64	0.09
MSW-fired stoker	SNCR	41-79	0.06-0.31	60	0.18

<sup>a</sup>Arithmetic averages of reported control efficiency NO<sub>x</sub> levels with specified controls. Values do not necessarily reflect emission targets that can be achieved in all cases.

<sup>c</sup>N.A. = Not available.

<sup>d</sup>SBWT = Single-burner watertube. Also referred to as packaged watertube (PKG-WT).

<sup>e</sup>Data for gas- and oil-fired watertube boilers are limited to performance reported in Appendix B, exclusive of equipment vendor data reported in Appendix C.

<sup>f</sup>MBWT = Multi-burner watertube. Also referred to as field-erected watertube (FE-WT).

<sup>g</sup>Most LNB applications include FGR.

<sup>h</sup>Only one data point available.

<sup>i</sup>Experience relies primarily on Japanese industrial installations.

<sup>j</sup>No data available. NO<sub>x</sub> levels assumed to be on the same order as those reported for single-burner packaged watertubes.

or the amount of ammonia or urea reagent used, will influence the percent reduction efficiency and the NO<sub>x</sub> level achieved.

NO<sub>x</sub> from pulverized coal combustion in industrial boilers with LNB controls was shown to be controlled to levels ranging from 0.26 to 0.50 lb/MMBtu. These data include results for both tangential- and wall-fired boilers. The average, 0.35 lb/MMBtu, is lower than reported average control levels for utility boilers.<sup>113</sup> Therefore, this average efficiency should be used cautiously, considering the limited data available to this study. Other data show SNCR to be quite effective in reducing NO<sub>x</sub> from coal- and waste-fuel-fired FBC and stoker boilers. Average levels for these sources controlled with either ammonia or urea range from 0.08 to 0.22 lb/MMBtu. For gas- and distillate-oil-fired ICI boilers, FGR and LNB controls operating alone or in combination can attain NO<sub>x</sub> levels averaging 0.02 to 0.15 lb/MMBtu. Data on residual oil are somewhat more sparse. NO<sub>x</sub> control levels from residual-oil-fired boilers are largely influenced by the nitrogen content of the fuel. Combustion controls for these boilers show average controlled levels ranging from 0.17 to 0.34 lb/MMBtu.

## 5.7 REFERENCES FOR CHAPTER 5

1. Natcher, P. B. High Technology Low NO<sub>x</sub> Burner Systems for Fired Heaters and Steam Generators. Process Combustion Corp. Pittsburgh, PA. Presented at the Pacific Coast Oil Show and Conference. Los Angeles, CA. November 1982. p. 4.
2. Cato, G. A., et al. (KVB, Inc). Field Testing: Application of Combustion Modifications to Control Pollutant Emissions from Industrial Boilers—Phase I. Publication No. EPA-600/2-74-078a. U.S. Environmental Protection Agency. Research Triangle Park, NC. October 1974. p. 86.
3. Castaldini, C. Evaluation and Costing of NO<sub>x</sub> Controls for Existing Utility Boilers in the NESCAUM Region. Publication No. EPA 453/R-92-010. U.S. Environmental Protection Agency. Research Triangle Park, NC. December 1992. p. 4-2.
4. Cato, G. A., et al. (KVB Inc). Field Testing: Application of Combustion Modifications to Control Pollutant Emissions from Industrial Boilers—Phase II. Publication No. EPA-600/2-72-086a. U.S. Environmental Protection Agency. Research Triangle Park, NC. April 1976. p. 162.
5. Heap, M. P., et al. Reduction of Nitrogen Oxide Emissions from Package Boilers. Publication No. EPA-600/2-77-025, NTIS-PB 269 277. January 1977.
6. Hopkins, K. C., et al. (Carnot). NO<sub>x</sub> Reduction on Natural Gas-Fired Boilers Using Fuel Injection Recirculation (FIR) — Laboratory Demonstration. Presented at the International Power Generation Conference. San Diego, CA. October 1991. p. 2.
7. Low-NO<sub>x</sub> Burner Design Achieves Near SCR Levels. Publication No. PS-4446. John Zink Company April 1993. p. 2.
8. Lim, K. J., et al. (Acurex Corp.) Industrial Boiler Combustion Modification NO<sub>x</sub> Controls—Volume I, Environmental Assessment. Publication No. EPA-600/ 7-81-126a. U.S. Environmental Protection Agency. Research Triangle Park, NC. July 1981. pp. 2-12 to 2-14.
9. Vatsky, J., and E. S. Schindler (Foster Wheeler Corp.). Industrial and Utility Boiler NO<sub>x</sub> Control. Proceedings: 1985 Symposium on Stationary Combustion NO<sub>x</sub> Control. Publication No. EPRI CS-4360. U.S. Environmental Protection Agency/Electric Power Research Institute. Palo Alto, CA. January 1986.
10. Vatsky, J. (Foster Wheeler Energy Corporation). NO<sub>x</sub> Control: The Foster Wheeler Approach. Proceedings: 1989 Symposium on Stationary Combustion NO<sub>x</sub> Control. Publication No. EPRI GS-6423. U.S. Environmental Protection Agency/Electric Power Research Institute. Palo Alto, CA. July 1989.

11. Lisauskas, R. A., et al. (Riley Stoker Corp.). Engineering and Economic Analysis of Retrofit Low-NO<sub>x</sub> Combustion Systems. Proceedings: 1987 Symposium on Stationary Combustion NO<sub>x</sub> Control. Publication No. EPRI CS-5361. U.S. Environmental Protection Agency/Electric Power Research Institute. Palo Alto, CA. August 1987.
12. Lim, K. J., et al. (Acurex Corp.) Industrial Boiler Combustion Modification NO<sub>x</sub> Controls—Volume I, Environmental Assessment. Publication No. EPA-600/7-81-126a. Prepared for the U.S. Environmental Protection Agency. Research Triangle Park, NC. July 1981. pp. 3-18 and 3-19.
13. Vatsky, J., and E. S. Schindler (Foster Wheeler Energy Corporation). Industrial and Utility Boiler Low NO<sub>x</sub> Control Update. Proceedings: 1987 Symposium on Stationary Combustion NO<sub>x</sub> Control. Publication No. EPRI CS-5361. U.S. Environmental Protection Agency/Electric Power Research Institute. Palo Alto, CA. August 1987.
14. LaRue, A. (Babcock & Wilcox). The XCL Burner—Latest Developments and Operating Experience. Proceedings: 1989 Symposium on Stationary Combustion NO<sub>x</sub> Control. Publication No. EPRI GS-6423. U.S. Environmental Protection Agency/Electric Power Research Institute. Palo Alto, CA. July 1989.
15. Schild, V., et al. (Black Hills Power and Light Co.). Western Coal-Fired Boiler Retrofit for Emissions Control and Efficiency Improvement. Technical Paper No. 91-JPGC-FACT-7. American Society of Mechanical Engineers. New York, NY. 1991.
16. Penterson, C. A., and R. A. Lisauskas (Riley Stoker Corp.) Application and Further Enhancement of the Low-NO<sub>x</sub> CCV Burner. Proceedings: 1993 Symposium on Stationary Combustion NO<sub>x</sub> Control. U.S. Environmental Protection Agency/Electric Power Research Institute. May 1993.
17. Penterson, C. A. (Riley Stoker Corp.) Controlling NO<sub>x</sub> Emissions to Meet the 1990 Clean Air Act. Technical Paper No. 91-JPGC-FACT-11. American Society of Mechanical Engineers. New York, NY. 1991.
18. Buchs, R. A., et al. (Kerr-McGee Chemical Corporation). Results From a Commercial Installation of Low NO<sub>x</sub> Concentric Firing System (LNCFS). ABB Combustion Engineering Services, Inc. Windsor, CT. 1991.
19. Araoka, M., et al. (Mitsubishi Heavy Industries, Inc.). Application of Mitsubishi "Advanced MACT" In-Furnace NO<sub>x</sub> Removal Process at Taio Paper Co., Ltd. Mishima Mill No. 118 Boiler. Proceedings: 1987 Symposium on Stationary Combustion NO<sub>x</sub> Control. Publication No. EPRI CS-5361. U.S. Environmental Protection Agency/Electric Power Research Institute. Palo Alto, CA. August 1987.
20. EERC. Gas Reburning Technology Review. Prepared for the Gas Research Institute. Chicago, IL. July 1991.
21. Farzan, H., et al. (Babcock & Wilcox Company). Pilot Evaluation of Reburning for Cyclone Boiler NO<sub>x</sub> Control. Proceedings: 1989 Symposium on Stationary Combustion

- NO<sub>x</sub> Control. Publication No. EPRI GS-6423. U.S. Environmental Protection Agency/Electric Power Research Institute. Palo Alto, CA. July 1989.
22. Folsom, B., et al. (Energy and Environmental Research Corporation). Field Evaluation of the Distributed Mixing Burner. Proceedings: 1985 Symposium on Stationary Combustion NO<sub>x</sub> Control. Publication No. EPRI CS-4360. U.S. Environmental Protection Agency/Electric Power Research Institute. Palo Alto, CA. January 1986.
  23. Vatsky, J., and T. W. Sweeney. Development of an Ultra-Low NO<sub>x</sub> Pulverized Coal Burner. Foster Wheeler Energy Corporation. Clinton, NJ. Presented at the 1991 Joint Symposium on Stationary Combustion NO<sub>x</sub> Control—EPA/EPRI. Washington, D.C. March 25-28, 1991.
  24. Lim, K. J., et al. (Acurex Corp.) Industrial Boiler Combustion Modification NO<sub>x</sub> Controls—Volume I, Environmental Assessment. Publication No. EPA-600/7-81-126a. U.S. Environmental Protection Agency. Research Triangle Park, NC. July 1981. pp. 3-26.
  25. Ibid. p. 3-30.
  26. Quartucy, G. C., et al. (KVB, Inc). Combustion Modification Techniques for Coal-Fired Stoker Boilers. Proceedings: 1985 Symposium on Stationary Combustion NO<sub>x</sub> Control. Publication No. EPRI CS-4360. U.S. Environmental Protection Agency/Electric Power Research Institute. Palo Alto, CA. January 1986.
  27. Maloney, K. L. (KVB, Inc.). Combustion Modifications for Coal-Fired Stoker Boilers. Proceedings of the 1982 Joint Symposium on Stationary Combustion NO<sub>x</sub> Control. Publication No. EPRI CS-3182. U.S. Environmental Protection Agency/ Electric Power Research Institute. Palo Alto, CA. July 1983.
  28. Lim, K. J., et al. (Acurex Corp.) Industrial Boiler Combustion Modification NO<sub>x</sub> Controls— Volume I, Environmental Assessment. Publication No. EPA-600/7-81-126a. U.S. Environmental Protection Agency. Research Triangle Park, NC. July 1981. p. 3-31.
  29. Energy Systems Associates. Characterization of Gas Cofiring in a Stoker-Fired Boiler. Publication No. GRI-93/0385. Gas Research Institute. Chicago, IL. November 1993. p. 6.
  30. State of the Art Analysis of NO<sub>x</sub>/N<sub>2</sub>O Control for Fluidized Bed Combustion Power Plants. Acurex Report No. 90-102/ESD. Acurex Corporation. Prepared for the Electric Power Research Institute. Palo Alto, CA. July 1990. p. 3-1.
  31. Martin, A. E. Emission Control Technology for Industrial Boilers. Noyes Data Corporation. Park Ridge, New Jersey. 1981. p. 3-39.

32. State of the Art Analysis of  $\text{NO}_x/\text{N}_2\text{O}$  Control for Fluidized Bed Combustion Power Plants. Acurex Report No. 90-102/ESD. Acurex Corporation. Prepared for the Electric Power Research Institute. Palo Alto, CA. July 1990. pp. 3-6 to 3-10.
33. Hiltunen, M., and J. T. Tang.  $\text{NO}_x$  Abatement in Ahlstrom Pyroflow Circulating Fluidized Bed Boilers. Ahlstrom Pyropower Corp. Finland.
34. Leckner, B., and L. E. Anand (Chalmers University, Sweden). Emissions from a Circulating and Stationary Fluidized Bed Boiler: A Comparison. Proceedings of the 1987 International Conference on Fluidized Bed Combustion. The American Society of Mechanical Engineers/Electric Power Research Institute/Tennessee Valley Authority. New York, NY. 1987.
35. Bijvoet, U. H. C., et al. (TNO Organization for Applied Scientific Research). The Characterization of Coal and Staged Combustion in the TNO 4-MWth AFBB Research Facility. Proceedings of the 1989 International Conference on Fluidized Bed Combustion. The American Society of Mechanical Engineers/Electric Power Research Institute/Tennessee Valley Authority. New York, NY. 1989.
36. Salam, T. F., et al. (University of Leeds, U.K.). Reduction of  $\text{NO}_x$  by Staged Combustion Combined with Ammonia Injection in a Fluidised Bed Combustor: Influence of Fluidising Velocity and Excess Air Levels. Proceedings of the 1989 International Conference on Fluidized Bed Combustion. The American Society of Mechanical Engineers/Electric Power Research Institute/Tennessee Valley Authority. New York, NY. 1989.
37. Tetebayashi, T., et al. Simultaneous  $\text{NO}_x$  and  $\text{SO}_2$  Emission Reduction with Fluidized-Bed Combustion. Presented at the 6th International Conference on Fluidized Bed Combustion. Atlanta, GA. 1980.
38. Katayama, H., et al. Correlation Between Bench-Scale Test FBC Boiler and Pilot Plant FBC Boiler Combustion Characteristics. Presented at the 7th International Conference on Fluidized Bed Combustion. San Francisco, CA. 1989.
39. Linneman, R. C. (B. F. Goodrich Chemical). B. F. Goodrich's FBC experience. Proceedings: 1988 Seminar on Fluidized Bed Combustion Technology for Utility Opns. Publication No. EPRI GS-6118. Electric Power Research Institute. Palo Alto, CA. February 1989.
40. State of the Art Analysis of  $\text{NO}_x/\text{N}_2\text{O}$  Control for Fluidized Bed Combustion Power Plants. Acurex Report No. 90-102/ESD. Acurex Corporation. Prepared for the Electric Power Research Institute. Palo Alto, CA. July 1990. pp. 3-11 to 3-15.
41. Hasegawa, T., et al. (Mitsubishi Heavy Industries, Ltd.). Application of AFBC to Very Low  $\text{NO}_x$  Coal Fired Industrial Boiler. Proceedings of the 1989 International Conference on Fluidized Bed Combustion. The American Society of Mechanical Engineers/Electric Power Research Institute/Tennessee Valley Authority. New York, NY. 1989.

42. Zhao, J. et al. (University of British Columbia). NO<sub>x</sub> Emissions in a Pilot Scale Circulating Fluidized Bed Combustor. Publication No. EPRI GS-6423. 1989 Symposium on Stationary Combustion NO<sub>x</sub> Control. U.S. Environmental Protection Agency/Electric Power Research Institute. Palo Alto, CA. July 1989.
43. Friedman, M. A., et al. Test Program Status at Colorado — Ute Electric Association 110 MWe Circulating FBC Boilers. Proceedings of the 1989 International Conference on Fluidized Bed Combustion. The American Society of Mechanical Engineers/Electric Power Research Institute/Tennessee Valley Authority. New York, NY. 1989.
44. State of the Art Analysis of NO<sub>x</sub>/N<sub>2</sub>O Control for Fluidized Bed Combustion Power Plants. Acurex Report No. 90-102/ESD. Acurex Corporation. Prepared for the Electric Power Research Institute. Palo Alto, CA. July 1990. pp. 3-17 and 3-18.
45. Johnsson, J. E. A Kinetic Model for NO<sub>x</sub> Formation in Fluidized Bed Combustion. Proceedings of the 1989 International Conference on Fluidized Bed Combustion. The American Society of Mechanical Engineers/Electric Power Research Institute/Tennessee Valley Authority. New York, NY. 1989.
46. State of the Art Analysis of NO<sub>x</sub>/N<sub>2</sub>O Control for Fluidized Bed Combustion Power Plants. Acurex Report No. 90-102/ESD. Acurex Corporation. Prepared for the Electric Power Research Institute. Palo Alto, CA. July 1990. p. 3-19.
47. Lim, K. J., et al. (Acurex Corp.) Industrial Boiler Combustion Modification NO<sub>x</sub> Controls — Volume I, Environmental Assessment. Publication No. EPA-600/7-81-126a. U.S. Environmental Protection Agency. Research Triangle Park, NC. July 1981. pp. 2-38.
48. Colannino, J. Low-Cost Techniques Reduce Boiler NO<sub>x</sub>. Chemical Engineering. February 1993. p. 100.
49. Statewide Technical Review Group. Technical Support Document for Suggested Control Measure for the Control of Emissions of Oxides of Nitrogen from Industrial, Institutional, and Commercial Boilers, Steam Generators, and Process Heaters. California Air Resources Board and the South Coast Air Quality Management District. Sacramento, CA. April 29, 1987. p. 48.
50. Ibid. p. 51.
51. Statewide Technical Review Group. Technical Support Document for Suggested Control Measure for the Control of Emissions of Oxides of Nitrogen from Industrial, Institutional, and Commercial Boilers, Steam Generators, and Process Heaters. California Air Resources Board and the South Coast Air Quality Management District. Sacramento, CA. April 29, 1987. p. 53.
52. Waibel, R., et al. (John Zink Co.). Fuel Staging Burners for NO<sub>x</sub> Control. ASM International. Metals Park, OH. April 1986.



53. Southern California Edison. NO<sub>x</sub> Emission Control for Boilers and Process Heaters—A Training Manual. Southern California Edison. Rosemead, CA. April 1991.
54. Statewide Technical Review Group. Technical Support Document for Suggested Control Measure for the Control of Emissions of Oxides of Nitrogen from Industrial, Institutional, and Commercial Boilers, Steam Generators, and Process Heaters. California Air Resources Board and the South Coast Air Quality Management District. Sacramento, CA. April 29, 1987, p. 61.
55. Oppenberg, R. Primary Measures Reducing NO<sub>x</sub> Levels in Oil- and Gas-Fired Water Tube Boilers. Report No. 176. Deutsche-Babcock. Germany. September 1986.
56. Londerville, S. B., and J. H. White (Coen Company). Coen Company Overview and Burner Design developments for NO<sub>x</sub> Control. Proceedings: Third Annual NO<sub>x</sub> Control Conference. Council of Industrial Boiler Owners. Burke, VA. February 1990.
57. Personal communication with Brizzolara, L., A. H. Merrill & Associates, Inc. Coen Company Low NO<sub>x</sub> Installation List. June 22, 1992.
58. Tampella Power. Faber Burner-LNB Projects List. Tampella Power Corporation. Williamsport, PA. 1992.
59. Lisauskas, R. A., and Green, R. W. Recent Low-NO<sub>x</sub> Gas and Oil Burner Applications. Proceedings: 1993 Joint Symposium on Stationary Combustion NO<sub>x</sub> Control. U.S. Environmental Protection Agency/Electric Power Research Institute. May 1993.
60. Nationwide Boiler, Inc. Faber Low NO<sub>x</sub> Burner Summary. Nationwide Boiler Inc. Tustin, CA. 1989.
61. Micro-NO<sub>x</sub> Low NO<sub>x</sub> Burners. Publication No. Micro-NO<sub>x</sub>/11-89. Coen Co., Inc. Stockton, CA. November 1989.
62. Suzuki, T., et al (Kobe Steel). Development of Low-NO<sub>x</sub> Combustion for Industrial Application. Proceedings: 1985 Symposium on Stationary Combustion NO<sub>x</sub> Control. Publication No. EPRI CS-4360. U.S. Environmental Protection Agency/Electric Power Research Institute. Palo Alto, CA. January 1986.
63. Alzeta Corp. Commercial Status of the Radiant Pyrocore Burner in Process Heaters and Boilers. Alzeta Corp. Santa Clara, CA. May 1988.
64. Gas Research Institute. Field Test Update: Ceramic Fiber Burner for Firetube Boilers. Gas Research Institute. Chicago, IL. August 1987.
65. Letter and attachments from Moreno, F. E., Alzeta Corporation, to Castaldini, C., Acurex Environmental Corporation. July 26, 1993.

66. Chojnacki, D., et al. (Donlee Technologies, Inc.). Developments in Ultra-Low NO<sub>x</sub> Burner/Boilers. Proceedings of the 1992 International Gas Research Conference. 1992. p. 352.
67. Statewide Technical Review Group. Technical Support Document for Suggested Control Measure for the Control of Emissions of Oxides of Nitrogen from Industrial, Institutional, and Commercial Boilers, Steam Generators, and Process Heaters. California Air Resources Board and the South Coast Air Quality Management District. Sacramento, CA. April 29, 1987. p. 63.
68. Ibid. p. 65.
69. Low-NO<sub>x</sub> Burner Design Achieves Near SCR Levels. Publication No. PS-4446. John Zink Company. April 1993. P. 4.
70. Ibid. p. 5.
71. Ln/Series-Low NO<sub>x</sub> Flue Gas Recirculation. Brochure 34. Industrial Combustion. Monroe, WI. October 1989.
72. Lim, K. J., et al. (Acurex Corp.) Industrial Boiler Combustion Modification NO<sub>x</sub> Controls—Volume I, Environmental Assessment. Publication No. EPA-600/7-81-126a. U.S. Environmental Protection Agency. Research Triangle Park, NC. July 1981. pp. 3-69.
73. Ibid. p. 3-39.
74. Hunter, S. C., et al. Application of Combustion Modifications to Industrial Combustion Equipment. KVB, Inc. Irvine, CA. 1977.
75. Lim, K. J., et al. (Acurex Corp.) Industrial Boiler Combustion Modification NO<sub>x</sub> Controls—Volume I, Environmental Assessment. Publication No. EPA-600/7-81-126a. U.S. Environmental Protection Agency. Research Triangle Park, NC. July 1981. p. 7-39.
76. Castaldini, C. Evaluation and Costing of NO<sub>x</sub> Controls for Existing Utility Boilers in the NESCAUM Region. Publication No. EPA 453/R-92-010. U.S. Environmental Protection Agency. Research Triangle Park, NC. December 1992. p. 4-26.
77. Lim, K. J., et al. (Acurex Corp.) Industrial Boiler Combustion Modification NO<sub>x</sub> Controls—Volume I, Environmental Assessment. Publication No. EPA-600/7-81-126a. U.S. Environmental Protection Agency. Research Triangle Park, NC. July 1981. p. 3-43.
78. Environmental Assessment of Utility Boiler Combustion Modification NO<sub>x</sub> Controls. Publication No. EPA-600/7-80-075a and b. U.S. Environmental Protection Agency. Research Triangle Park, NC. April 1980.

79. Castaldini, C. Evaluation and Costing of NO<sub>x</sub> Controls for Existing Utility Boilers in the NESCAUM Region. Publication No. EPA 453/R-92-010. U.S. Environmental Protection Agency. Research Triangle Park, NC. December 1992. p. 4-27.
80. Statewide Technical Review Group. Technical Support Document for Suggested Control Measure for the Control of Emissions of Oxides of Nitrogen from Industrial, Institutional, and Commercial Boilers, Steam Generators, and Process Heaters. California Air Resources Board and the South Coast Air Quality Management District. Sacramento, CA. April 29, 1987. p. 75.
81. Letter and attachments from DeHaan, T., Coen Co., Inc, to Seu, S., Acurex Environmental Corporation. Low NO<sub>x</sub> Retrofits. February 6, 1992.
82. Folsom, B. A., et al. Preliminary Guidelines for Gas Cofiring in Coal-Designed Boilers. Gas Research Institute Report prepared under GRI Contract No. 5091-254-2368. September 1992. p. 3-9.
83. Letter and attachments from Chant, P., the FReMCo Corporation, Inc., to Neuffer, B. J., U.S. Environmental Protection Agency. October 13, 1993.
84. Statewide Technical Review Group. Technical Support Document for Suggested Control Measure for the Control of Emissions of Oxides of Nitrogen from Industrial, Institutional, and Commercial Boilers, Steam Generators, and Process Heaters. California Air Resources Board and the South Coast Air Quality Management District. Sacramento, CA. April 29, 1987. p. 45.
85. Natcher, P., and H. Shelton. NO<sub>x</sub> Reduction Technologies for the Oil Patch. Process Combustion Corporation. Presented at the Pacific Coast Oil Show and Conference. Bakersfield, CA. November 1985.
86. Collins, J. (Radian Corp.). Technology Study of NO<sub>x</sub> Controls for "Small" Oil Field Steam Generators. Document No. 87-243-101-02. Prepared for Western Oil and Gas Association. Bakersfield, CA. January 1987.
87. Kern County Air Pollution Control District. 1986 Pollutant Survey (TEOR steam generators). November 1986.
88. Natcher, P. High Temperature Low NO<sub>x</sub> Burner Systems for Fired Heaters and Steam Generator. Process Combustion Corp. Presented at the Pacific Coast Oil Show and Conference. Los Angeles, CA. November 1982.
89. Statewide Technical Review Group. Technical Support Document for Suggested Control Measure for the Control of Emissions of Oxides of Nitrogen from Industrial, Institutional, and Commercial Boilers, Steam Generators, and Process Heaters. California Air Resources Board and the South Coast Air Quality Management District. Sacramento, CA. April 29, 1987. pp. 53-56.

90. Letter and attachments from Nutcher, P. B., Process Combustion Corporation, to Votluka, P., South Coast Air Quality Management District. Description of a Single Toroidal Combustor Low-NO<sub>x</sub> Burner used in TEOR Steam Generators. July 1987.
91. Nutcher, P. B. High Technology Low NO<sub>x</sub> Burner Systems for Fired Heaters and Steam Generators. Process Combustion Corp. Pittsburgh, PA. Presented at the Pacific Coast Oil Show and Conference. Los Angeles, CA. November 1982. p. 14.
92. Statewide Technical Review Group. Technical Support Document for Suggested Control Measure for the Control of Emissions of Oxides of Nitrogen from Industrial, Institutional, and Commercial Boilers, Steam Generators, and Process Heaters. California Air Resources Board and the South Coast Air Quality Management District. Sacramento, CA. April 29, 1987. p. 55.
93. Castaldini, C., et al. Environmental Assessment of an Enhanced Oil Recovery Steam Generator Equipped with a Low NO<sub>x</sub> Burner. Acurex Report No. TR-84-161/EE. Acurex Corporation. Prepared for the U.S. Environmental Protection Agency. Research Triangle Park, NC. January 1985.
94. Swientek, R. J. Turbulence Device Cuts Gas Consumption. Food Processing Magazine. May 1992. p. 201.
95. Summary of Meeting Between Neuffer, W., U.S. Environmental Protection Agency, and Rosborne, J., Utilicon Associates, Inc. GASPROFLO<sup>TM</sup> Fuel Turbulator Information. April 1993.
96. Flow Modifier Ups Efficiency in Gas-Fired Boilers. Power Magazine. January 1992. p. 101.
97. Abbasi, H., and F. J. Zone. Emission Reduction from MSW Combustion Systems Using Natural Gas. Gas Research Institute Report No. 92/0370. Institute of Gas Technology and Riley Stoker Corporation. Chicago, IL. December 1992.
98. Penterson, C.A., et al. (Riley Stoker Corporation). Reduction of NO<sub>x</sub> Emissions From MSW Combustion Using Gas Reburning. Proceedings: 1989 Symposium on Stationary Combustion NO<sub>x</sub> Control. Publication No. EPRI GS-6423. U.S. Environmental Protection Agency/Electric Power Research Institute. Palo Alto, CA. July 1989.
99. Lisauskas, R. A., et al. (Riley Stoker Corporation). Status of NO<sub>x</sub> Control Technology at Riley Stoker. Proceedings: 1989 Symposium on Stationary Combustion NO<sub>x</sub> Control. Publication No. EPRI GS-6423. U.S. Environmental Protection Agency/Electric Power Research Institute. Palo Alto, CA. July 1989.
100. Haas, G. Selective Non-Catalytic Reduction (SNCR): Experience with the Exxon Thermal DeNO<sub>x</sub> Process. Exxon Research and Engineering Co. Presented at the Fifth NO<sub>x</sub> Control Conference Council of Industrial Boiler Owners. Long Beach, CA. February 1992.

101. Clarke, M. (Environmental Research and Education). Technologies for Minimizing the Emission of NO<sub>x</sub> from MSW Incineration. Technical Paper No. 89-167.4. Air and Waste Management Association. Pittsburgh, PA. June 1989.
102. Hurst, B. E., et al. Exxon Thermal DeNO<sub>x</sub> Effectiveness Demonstrated in a Wood-Fired Boiler. Exxon Research and Engineering Company. Florham Park, NJ. Presented at the 13th National Waste Processing Conference and Exhibit. May 1-4, 1988.
103. Statewide Technical Review Group. Technical Support Document for Suggested Control Measure for the Control of Emissions of Oxides of Nitrogen from Industrial, Institutional, and Commercial Boilers, Steam Generators, and Process Heaters. California Air Resources Board and the South Coast Air Quality Management District. Sacramento, CA. April 29, 1987. p. 70.
104. Mason, H. NO<sub>x</sub> Control by Non-Catalytic Reduction. Acurex Corp. Presented at the Second NO<sub>x</sub> Control Conference, Council of Industrial Boiler Owners. City of Industry, CA. February 1989.
105. Epperly, W. R., et al. Control of Nitrogen Oxides Emissions from Stationary Sources. Fuel Tech, Inc. Presented at the Annual Meeting of the American Power Conference. Illinois. April 1988.
106. Alternative Control Techniques Document--NO<sub>x</sub> Emissions from Utility Boilers. Publication No. EPA-453/R-94-023. U.S. Environmental Protection Agency. Office of Air Quality Planning and Standards. Research Triangle Park, NC. March 1994.
107. Statewide Technical Review Group. Technical Support Document for Suggested Control Measure for the Control of Emissions of Oxides of Nitrogen from Industrial, Institutional, and Commercial Boilers, Steam Generators, and Process Heaters. California Air Resources Board and the South Coast Air Quality Management District. Sacramento, CA. April 29, 1987. p. 72.
108. Cogentrix Eyes SCR for 220-MW Coal Plant; To Seek Permits Before Power Sales Deal. Utility Environment Report. January 24, 1992.
109. Sweden Gets SCR for CFBs. Coal and Synfuels Technology. Volume 13, No. 12. March 23, 1992.
110. Letter and attachments from confidential company to Votlucka, P., South Coast Air Quality Management District. Industrial SCR Experience. October 1988.
111. Statewide Technical Review Group. Technical Support Document for Suggested Control Measure for the Control of Emissions of Oxides of Nitrogen from Industrial, Institutional, and Commercial Boilers, Steam Generators, and Process Heaters. California Air Resources Board and the South Coast Air Quality Management District. Sacramento, CA. April 29, 1987. p. 73.

112. Makansi, J. Reducing NO<sub>x</sub> Emission. Power Magazine. September 1988.
113. Castaldini, C. Evaluation and Costing of NO<sub>x</sub> Controls for Existing Utility Boilers in the NESCAUM Region. Publication No. EPA 453/R-92-010. U.S. Environmental Protection Agency. Research Triangle Park, NC. December 1992. pp. 1-12, 13.

## 6. COSTS OF RETROFIT NO<sub>x</sub> CONTROLS

This chapter evaluates the economic impacts of controlling NO<sub>x</sub> from existing ICI boilers. Costing methodologies and assumptions are discussed in Section 6.1. Section 6.2 presents the costs calculated for various NO<sub>x</sub> controls retrofitted to ICI boilers. Section 6.3 discussed the capital and total annual costs of NO<sub>x</sub> controls. Section 6.4 presents the cost effectiveness of NO<sub>x</sub> controls. Supporting documentation, including costing spreadsheets, are included as appendices. Appendix D contains cost effectiveness data for the boilers and control systems analyzed, scaled from annual cost data of Appendices E, F, and G. The latter appendices contain detailed cost analysis spreadsheets developed from actual data provided by vendors, boiler owners, and regulatory agencies.

Whenever possible, cost data from actual retrofit projects were used to develop the cost effectiveness figures presented in Section 6.4. When key cost figures from actual projects were unavailable or not accounted for, however, the cost algorithms and assumptions described in Section 6.1 were used to supplement the available cost data.

### 6.1 COSTING METHODOLOGY

The costing methodology used in this study is based primarily on the U.S. EPA's OAQPS Control Cost Manual,<sup>1</sup> although certain cost components have been modified specifically for this study, based on conventional costing practice and actual cost data. Costs of retrofit NO<sub>x</sub> controls for ICI boilers can be divided into two major cost categories — capital investment costs and annual operations and maintenance (O&M) costs. Capital costs are the total investment necessary to purchase, construct, and make operational a control system. O&M costs are the total annual costs necessary to operate and maintain the control system, above what was required to operate the pre-retrofit boiler without NO<sub>x</sub> control. Each of these cost categories can be further subdivided into individual cost components. Section 6.1.1 discusses capital cost components, Section 6.1.2 discusses elements of O&M costs, and Section 6.1.3 describes the methodology for evaluating a control technology's overall cost effectiveness based on these capital and O&M costs.

### **6.1.1 Capital Costs of Retrofit NO<sub>x</sub> Controls**

Capital costs of NO<sub>x</sub> controls include both direct and indirect cost components. Direct capital costs are expenses required to purchase equipment for the control system, referred to as purchased equipment costs, as well as those expenses required for installing the equipment in the existing boiler, known as direct installation costs. Indirect capital costs are costs entailed in the development of the overall control system, but not attributable to a specific equipment item. These costs are also referred to as indirect installation costs. In addition to direct and indirect components of capital investment costs, contingency costs are also added to account for unpredictable expenses. Figure 6-1 illustrates these principal elements of total capital investment and lists common sub-elements which comprise them. The major capital cost elements are described in detail below.

All costs in this chapter and the appendices are presented in 1992 dollars. When available cost data were referenced to other years, the Chemical Engineering Plant Cost Index was used to convert costs to 1992 dollars.<sup>2-4</sup>

#### **6.1.1.1 Purchased Equipment Costs**

Purchased equipment costs include the costs of primary control equipment, such as low-NO<sub>x</sub> burners, FGR fans, or catalytic converters; auxiliary control equipment; instrumentation; and applicable sales taxes and shipping charges. When data were provided, the cost of CEM equipment was also included in the purchased equipment cost. For this study, instrumentation, tax, and freight charges were estimated as being 18 percent of the total primary and auxiliary equipment costs.<sup>1</sup>

#### **6.1.1.2 Direct Installation Costs**

The second major component of direct capital costs, direct installation costs include both labor and materials costs for foundations, supporting structures, piping, insulation, painting, handling and erection, and electrical work. Direct installation costs vary considerably from site to site and depend on such factors as availability of space, the amount of boiler modification that must be done to accommodate the control system, and existing facilities. Although direct installation costs may vary widely, they were estimated as 30 percent of purchased equipment cost in this study, unless an actual cost figure was provided. This is towards the low end of reported ranges for direct installation cost.<sup>1,5</sup> When direct installation cost data for new boiler applications were provided by vendors, the figures were doubled to account for additional retrofit



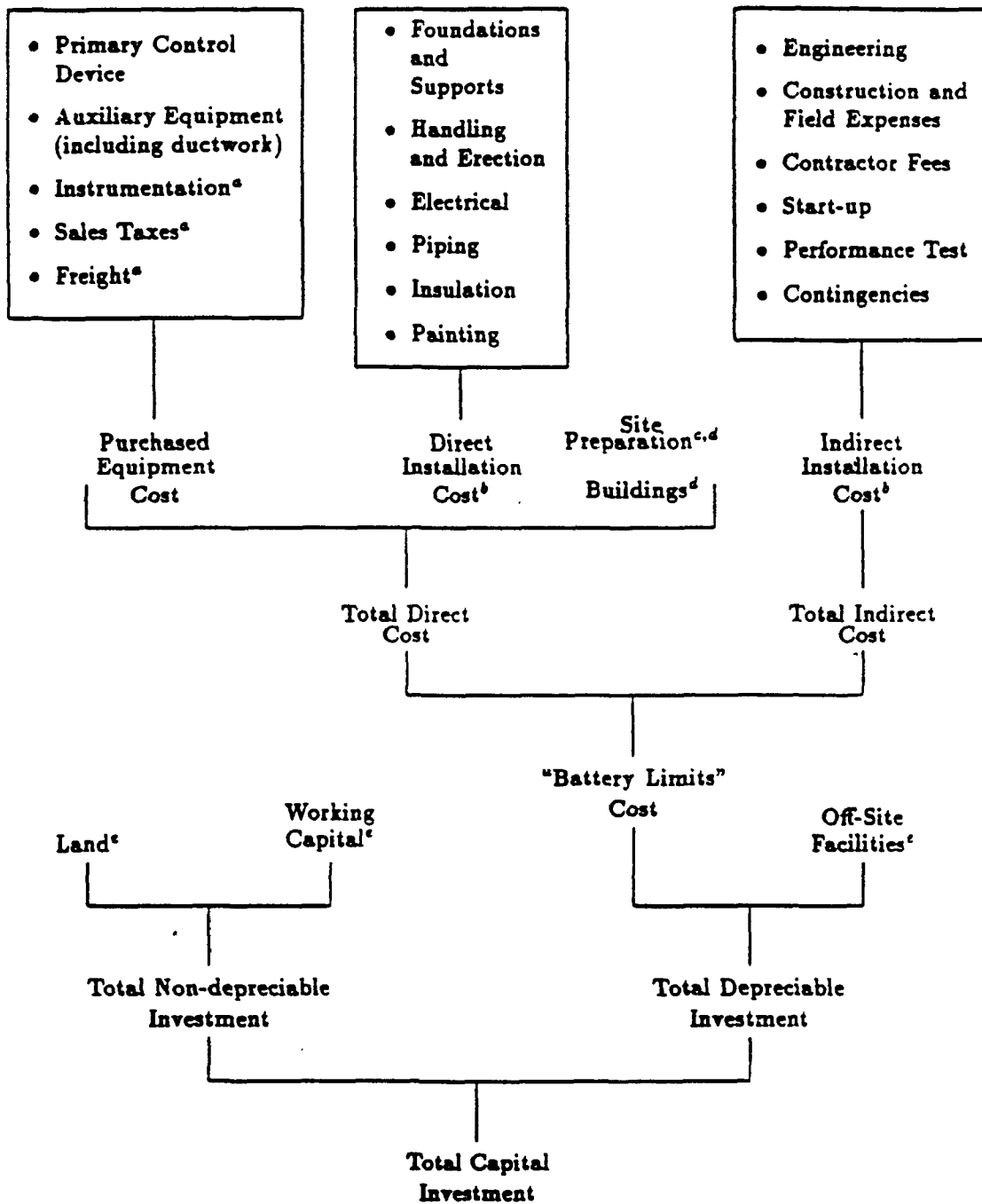

- <sup>a</sup> Typically factored from the sum of the primary control device and auxiliary equipment costs.
- <sup>b</sup> Typically factored from the purchased equipment cost.
- <sup>c</sup> Usually required only at "grass roots" installations.
- <sup>d</sup> Unlike the other direct and indirect costs, costs for these items usually are not factored from the purchased equipment cost. Rather, they are sized and costed separately.
- <sup>e</sup> Normally not required with add-on control systems.

Figure 6-1. Elements of total capital investment cost.<sup>1</sup>

expenses.<sup>1,6</sup> Costs of research and development and the cost of lost production during installation and startup were not included in direct installation cost.

#### **6.1.1.3 Indirect Installation Costs**

Indirect installation costs consist of engineering costs, construction and field expenses, construction fees, and expenses associated with startup, performance tests, and permitting. When actual cost data were unavailable, these costs were estimated to be approximately 33 percent of the purchased equipment cost.<sup>1</sup> For SCR retrofits, indirect installation was estimated as 66 percent of purchased equipment cost to account for additional engineering and construction requirements.

#### **6.1.1.4 Contingencies**

Contingency costs were added to capital cost estimates to account for additional expenses due to such things as price changes, small design changes, errors in estimation, strikes, or adverse weather conditions. These are unpredictable costs likely to occur.<sup>5</sup> In the cost spreadsheets of Appendices E, F, and G, contingency costs were estimated primarily as 20 percent of the total direct and indirect capital cost.<sup>7,8</sup> Cost estimates obtained from selected control vendors already included contingencies. To avoid double accounting, no additional contingency costs were added.

#### **6.1.1.5 Other Capital Costs**

Other costs which may be included as capital costs are expenditures for site preparation, buildings, land, and working capital. Site preparation costs are sometimes accounted for in direct installation costs, and in most cases are unreported. Additional buildings are usually not required for retrofit NO<sub>x</sub> control systems for ICI boilers, except in cases where existing facilities are absolutely unable to accommodate additional equipment installation. For the purposes of this study, site preparation and building costs were listed in the cost spreadsheets, but were only used if sources provided costs for these items.

Working capital is a fund set aside to cover the initial O&M costs of labor, fuel, chemicals, and other materials for a given time, usually on the order of 90 days.<sup>7</sup> This fund is primarily used in cost analyses for large systems which require significant amounts of utilities, O&M labor, and materials.<sup>1</sup> Because most of the control systems considered in this study do not require large amounts of utilities, O&M labor and materials, working capital costs were not included in this study. Costs of additional land were also not included since most retrofit control systems do not require much space. These omissions are consistent with U.S. EPA OAQPS costing methodologies.<sup>1</sup>

### 6.1.2 Annual Operations and Maintenance (O&M) Costs

Annual O&M costs of NO<sub>x</sub> control systems are classified as either direct or indirect annual costs. For this study, O&M costs were considered to be costs resulting from the use of the NO<sub>x</sub> control equipment only, and are separate from the annual O&M costs of the existing boiler. Figure 6-2 displays common elements of annual O&M costs. Included as direct annual O&M costs are expenses for labor and maintenance materials, utilities such as electricity or steam, fuel or chemicals which may be required for the control system, and waste disposal which may be required with SCR system catalysts. With FGR NO<sub>x</sub> control systems, boiler fuel consumption may actually decrease due to increased boiler efficiency, resulting in an overall fuel savings. Two sources estimated fuel savings of 1 to 2 percent when FGR was retrofitted.<sup>9,10</sup> In the cost calculations of Appendices E, F, and G, fuel savings of 1 percent were included for all FGR systems.

Prices for fuels and electricity in the U.S. were obtained from Energy User News.<sup>11</sup> The cost of electricity was estimated as \$0.05/kWh, while the cost per MMBtu for natural gas, distillate oil, and residual oil were estimated as \$3.63, \$4.83, and \$2.35, respectively. The price of bulk anhydrous ammonia used for ammonia injection systems was estimated at \$250 per ton, while the price of bulk urea was estimated at \$220 per ton.<sup>12</sup>

Indirect annual O&M costs include overhead, administrative charges, property taxes, and insurance. Following the cost methodology developed by OAQPS, overhead charges were estimated as 60 percent of the annual labor and maintenance materials costs, while administrative, property tax, and insurance costs were estimated as 4 percent of the total capital investment cost described in Section 6.1.1.<sup>1</sup>

Table 6-1 summarizes the assumptions made for estimating capital and O&M costs for retrofit NO<sub>x</sub> control systems. When developing a NO<sub>x</sub> control cost spreadsheet based on data from a particular reference source, these estimates were used whenever data were not provided by the source.

### 6.1.3 Total Annualized Cost and Cost Effectiveness

Total capital investment and total annual O&M costs may be combined to give a total annualized cost. Total capital investment is converted into uniform annual capital recovery costs which represent the payments necessary to repay the capital investment over a given time period at a given interest rate. This is done by multiplying the total capital investment cost by a capital recovery factor. For this analysis, a 10-percent interest rate and an amortization period of 10

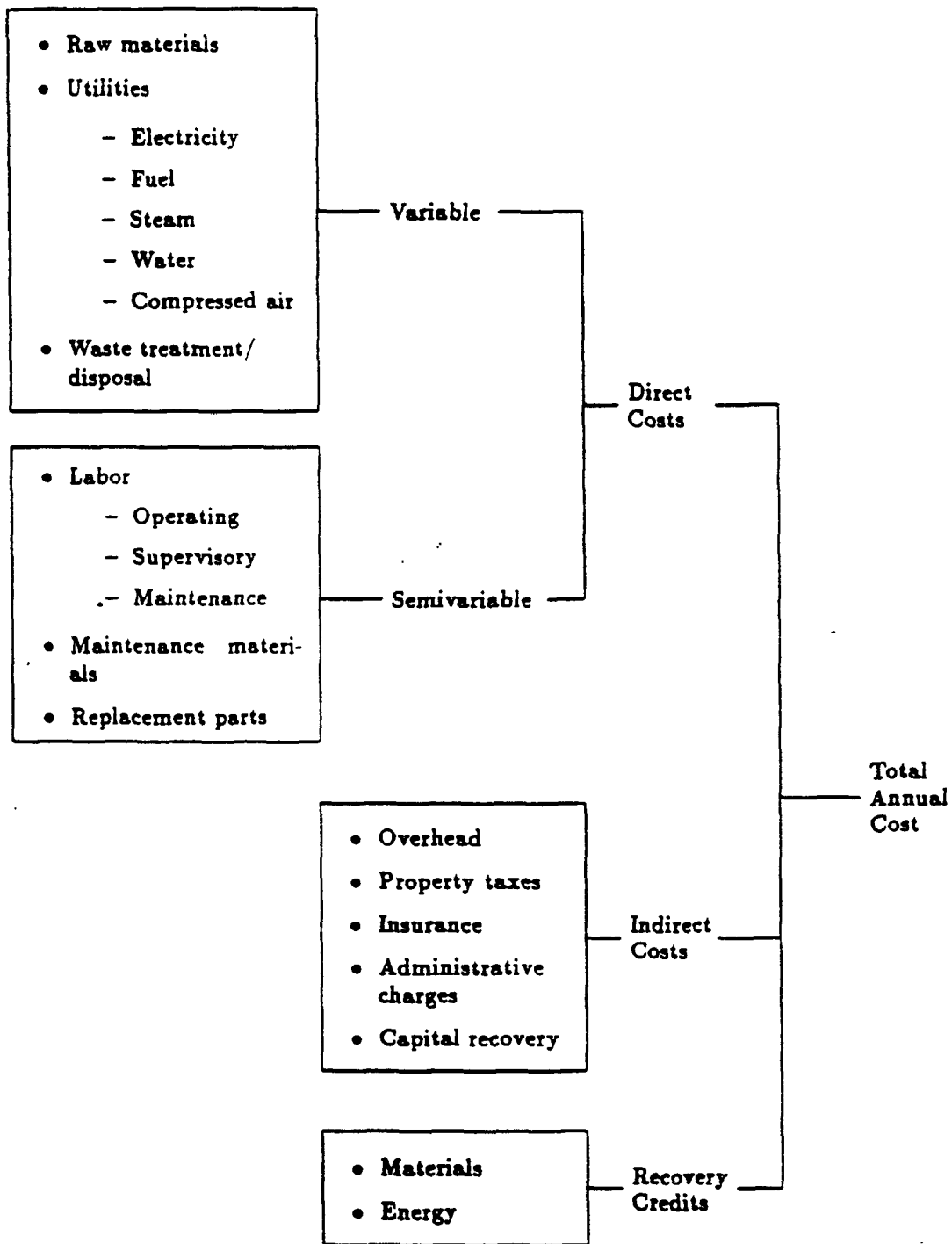

Figure 6-2. Elements of total annual O&M cost.<sup>1</sup>

**TABLE 6-1. ASSUMPTIONS FOR ESTIMATING CAPITAL AND ANNUAL O&M COSTS**

<b>Cost element</b>	<b>Cost assumption</b>
<b>Direct capital costs</b>	
NO <sub>x</sub> control equipment	Given
Instrumentation	10% of equipment cost
Sales taxes	3% of equipment cost
<u>Freight</u>	5% of equipment cost
Total = Purchased Equipment Cost (PEC)	
Direct installation cost	30% of PEC
Site preparation	0 unless given
Buildings	0 unless given
<b>Indirect capital costs</b>	
Engineering	10% of PEC <sup>a</sup>
Construction and field expenses	10% of PEC <sup>a</sup>
Construction fee	10% of PEC <sup>a</sup>
Startup	2% of PEC <sup>a</sup>
Performance test	1% of PEC <sup>a</sup>
<b>Contingency</b>	20% of direct and indirect capital costs
<b>O&amp;M costs</b>	
FGR fuel savings	1% of boiler fuel cost
Overhead	60% of labor and maintenance material cost
Administrative	2% of total capital cost
Property tax	1% of total capital cost
Insurance	1% of total capital cost

<sup>a</sup>Increased by a factor of 2 for SCR installations.

years was assumed for the NO<sub>x</sub> control systems, which results in a capital recovery factor of 0.1627.<sup>13</sup> The interest rate of 10 percent was selected as a typical constant dollar rate of return on investment to provide a basis for calculation of annualized capital investment cost. Although 10 years was chosen as the capital amortization period, other periods could have been selected if desired, as long as the same amortization period is used when comparing costs of different control systems. When the annualized capital cost is added to the total annual O&M costs discussed in Section 6.1.2, the resulting figure is the total annualized cost of the NO<sub>x</sub> control system.

In order to compare the cost effectiveness of different controls on a given boiler, the total annualized cost of each control system was divided by the amount of NO<sub>x</sub> removed by the

system over 1 year. The amount of  $\text{NO}_x$  removed from a boiler is a function of the achievable  $\text{NO}_x$  reduction of the control system and of the annual capacity of that unit. An annual capacity factor represents the ratio of the amount of heat input a unit uses in a year to the amount it could have used if it was operated at full rated capacity 24 hours a day, 365 days per year. For the purposes of this study, it was assumed that all boilers, when operated, ran at full rated capacity, as opposed to being run at half load, for example. However, the annual capacity factors of all boilers were assumed to be less than 1.

The actual amount of boiler operating time over a year typically depends on the boiler size and application. For example, smaller capacity boilers used in commercial or institutional sectors are often operated intermittently, providing power for daily needs of office buildings, schools, etc. as needed. On the other hand, larger units located in large manufacturing facilities may operate almost continuously during the workweek. To illustrate the effect of capacity factor on  $\text{NO}_x$  control cost effectiveness, cost effectiveness was calculated for each boiler test case at capacity factors of 0.33, 0.5, 0.66, and 0.8. While data for the complete range of capacity factors are presented in the appendices, the summary tables in this chapter show cost effectiveness calculated for the mid-range capacity factors of 0.5 and 0.66 only.

To estimate the amount of  $\text{NO}_x$  removed by a control system per year, pre-retrofit and post-retrofit  $\text{NO}_x$  emission levels must be known, in addition to the boiler capacity factor and heat input capacity rating. Assumed baseline  $\text{NO}_x$  levels were selected for each fuel and boiler type based on data contained in Appendices A and B and summarized in Table 4-7 of Chapter 4. Table 6-2 lists the average baseline  $\text{NO}_x$  levels assumed for the purposes of calculating cost effectiveness. For natural-gas-fired watertube boilers, five boiler size categories were considered in the retrofit cost analyses. Average baseline  $\text{NO}_x$  emissions increase with boiler size because of the higher heat release rate and greater thermal  $\text{NO}_x$  formation.  $\text{NO}_x$  reduction efficiencies for each type of control were selected based on data contained in Chapter 5 and Appendix B, and are listed in Table 6-3. These  $\text{NO}_x$  reduction efficiencies are assumed levels only; actual  $\text{NO}_x$  reduction performance of particular control systems may vary depending on boiler, fuel, and operating characteristics, as discussed in Chapter 5.

Total annualized costs are divided by the amount of  $\text{NO}_x$  emission reduction per year to obtain the cost effectiveness in terms of dollars per ton of  $\text{NO}_x$  reduced. As stated earlier, all costs in this analysis are expressed in terms of 1992 dollars.

**TABLE 6-2. BASELINE (UNCONTROLLED) NO<sub>x</sub> EMISSIONS USED FOR COST CASES**

Fuel	Boiler type	Baseline NO <sub>x</sub> , lb/MMBtu <sup>a</sup>
Natural gas	Firetube	0.12
	Watertube	
	10 to <75 MMBtu/hr	0.16
	75 to 150 MMBtu/hr	0.18
	>150 to <350 MMBtu/hr	0.24
	350 to <750 MMBtu/hr	0.30
	≥750 MMBtu/hr	0.40
Distillate oil	All	0.20
Residual oil	All	0.38
Pulverized coal	Wall-fired	0.70
Coal	Spreader stoker	0.53
Coal	FBC	0.32
Wood	Stoker	0.25
Wood	FBC	0.25
Wood/natural gas	Stoker	0.20
Paper	Packaged watertube	0.50
MSW	Stoker	0.40

<sup>a</sup>To convert to ppm at 3 percent O<sub>2</sub>, multiply by the following factors: natural gas, 835; distillate oil, 790; residual oil, 790; coal, 740; wood, 710; paper, 710; MSW, 705 (approximate).

**TABLE 6-3. NO<sub>x</sub> REDUCTION EFFICIENCIES USED FOR COST CASES**

NO <sub>x</sub> control technology	Applicable boiler equipment	NO <sub>x</sub> reduction efficiency, % <sup>a</sup>
BT/OT	PKG-WT and FT	15
BT/OT and WI	PKG-WT and FT	65
BOOS with OT	FE-WT	50
BOOS/WI with OT	FE-WT	75
LNB	PC: wall-fired	50
	Nat. gas/oil: PKG-WT, FE-WT <sup>b</sup>	50
FGR	Nat. gas/oil: PKG-FT <sup>c</sup>	40
LNB and FGR	Nat. gas/oil: PKG-WT	60
SNCR	PC: wall-fired	45
	Coal: FBC	75
	Coal: Stoker	58
	Nonfossil: stoker, PKG-WT, FBC	55
SCR	PC: wall-fired	80
	Nat. gas/oil: PKG-WT	85

<sup>a</sup>See Chapter 5 and Appendix B.

<sup>b</sup>PKG-WT = packaged watertube; FE-WT = field-erected watertube.

<sup>c</sup>PKG-FT = packaged firetube.

## 6.2 NO<sub>x</sub> CONTROL COST CASES AND SCALING METHODOLOGY

NO<sub>x</sub> control cost cases were selected based on the prevalence of control system applications to specific types and sizes of boilers and on the availability of cost data. Table 6-4 lists the cost cases analyzed and data sources from which various cost figures, principally capital and annual costs, were obtained. Cost data were compiled primarily from published reports and communications with selected boiler operators and control system manufacturers. Cost data for PC-fired boilers were limited to LNB, SNCR, and SCR control technologies. Capital and O&M costs for LNB and SCR were provided by the Council of Industrial Boiler Owners (CIBO)<sup>14</sup>, and recent costs were developed for small utility PC-fired boilers.<sup>15</sup> Cost estimates for SNCR with urea and ammonia reagents were provided by vendors of these technologies. Experience with NO<sub>x</sub> controls for ICI PC-fired boilers is generally very sparse; therefore, these cost estimates should be used with caution. Data on NO<sub>x</sub> controls for FBC boilers were limited to SNCR, since combustion staging is usually integrated into the original FBC boiler design and operation. For firetube boilers, data were also limited primarily to FGR only. Cost estimates of WI+OT for firetube boilers were based on the data reported for packaged watertube boilers.

Raw data from the referenced sources listed were used to calculate the annual cost effectiveness figures presented in Appendices E, F, and G. Cost effectiveness estimates for each of the NO<sub>x</sub> control cost cases were then obtained from these values, using the logarithmic scaling law known as the "six-tenths power rule," to account for differences in boiler capacity size.<sup>5</sup> Cost effectiveness was calculated for each cost case, using each applicable source of raw cost data. For example, the cost effectiveness of LNB used in 10 to 250 MMBtu/hr (2.9 to 73 MWt) natural-gas-fired packaged watertube units was calculated using annual costs derived from References 6 and 14, each of which provided data on more than one LNB retrofit project. Each individual retrofit project was used to calculate a cost effectiveness value. Results obtained for each cost case from each source are contained in Appendix D. The ranges in cost effectiveness obtained from all sources are summarized in the following subsections. In all, cost data for 42 different boiler/NO<sub>x</sub> control configurations were used to develop these ranges, varying in boiler type, size, fuel, and NO<sub>x</sub> control technology.

Most of the data obtained were for natural-gas-fired units, in part because of boiler retrofit activity in California's South Coast Air Basin, where natural gas is the primary fuel used. Cost effectiveness figures for distillate- and residual-oil-fired units were estimated using the annual costs for natural-gas-fired units. Appropriate baseline NO<sub>x</sub> levels for fuel oil firing were



**TABLE 6-4. NO<sub>x</sub> CONTROL COST EFFECTIVENESS CASES**

Fuel type	Boiler type	Boiler capacity, MMBtu/hr	NO <sub>x</sub> control technology	Cost data reference
PC	Wall-fired	250-750	LNB	14
		250-750	SNCR-ammonia	16
		250-750	SNCR-urea	17
		250-750	SCR	15
Coal	FBC	250-750	SNCR-urea	18
	Spreader stoker	250-750	SNCR-urea	17
Natural gas/distillate oil/residual oil	Packaged watertube	10-250	OT	19
	Packaged watertube	10-250	OT+ WI	19
	Packaged firetube	3-34	OT	19
	Packaged firetube	3-34	OT+ WI	19
	Packaged firetube	3-34	FGR	20
	Packaged watertube	10-250	LNB	6,14
	Packaged watertube	10-250	LNB+FGR	6,14,21
	Packaged watertube	10-250	SCR	9,22
	Field-erected wall-fired	250-750	LNB	14
Nonfossil fuel	Stoker	50-500	SNCR-urea	16
	Packaged watertube	10-250	SNCR-urea	16
	FBC	250-750	SNCR-ammonia	23

used to calculate annual NO<sub>x</sub> reduction. For FGR, fuel oil prices were used to estimate the annual fuel savings.

### 6.3 CAPITAL AND TOTAL ANNUAL COSTS OF NO<sub>x</sub> CONTROLS

Table 6-5 summarizes the capital and total annualized costs of retrofit controls on selected "model" size boilers. The table also lists the anticipated NO<sub>x</sub> control levels applicable to each control technology and model boiler. This information corresponds to data presented in Chapter 5. The total annualized cost includes the payments for the initial investment and the recurring direct and indirect O&M costs. The references indicate the sources of the capital cost data, and, in some cases, the O&M cost data, used in the analysis. As indicated earlier, when the reference cost data were for a different year or size of boiler, the capital costs were first updated to 1992 base year and then adjusted for boiler size using the "six-tenths" power law. That is:

**TABLE 6-5. CAPITAL AND TOTAL ANNUAL COSTS OF RETROFIT NO<sub>x</sub> CONTROLS FOR ICI BOILERS, 1992 DOLLARS**

Boiler type, size, and fuel	NO <sub>x</sub> control	Controlled NO <sub>x</sub> , lb/MMBtu <sup>a</sup>	Capital cost, \$/MMBtu/hr	Total annual cost, \$/yr/MMBtu/hr <sup>b</sup>	Reference
400 MMBtu/hr PC-fired wall-fired watertube	LNB	0.35	5,300	1,220	14
	SNCR	0.28	1,600-2,100	950-1,200	16,17
	SCR	0.14	20,000	5,800	15
400 MMBtu/hr FBC	SNCR	0.08	1,600	680	18
400 MMBtu/hr stoker	SNCR	0.22	1,100	1,200	17
10.5 MMBtu/hr oil/gas firetube	OT+WI	0.04 (Gas)	2,400	690	19
	OT+FGR	0.07 (Gas) 0.12 (No. 2 oil)	5,400	1,100	20
50 MMBtu/hr oil/gas packaged watertube	OT+WI	0.06 (Gas)	530	210	19
	LNB	0.08 (Gas) 0.10 (No. 2 oil) 0.19 (No. 6 oil)	650-2,300	340-420	6,14
	LNB+FGR	0.06 (Gas) 0.07 (No. 2 oil) 0.15 (No. 6 oil)	2,100-4,700	430-890	6,14,21
	SCR	0.02 (Gas) 0.03 (No. 2 oil) 0.06 (No. 6 oil)	2,400-6,900	1,500-1,900	9,22
300 MMBtu/hr oil/gas field-erected watertube	OT+SCA (BOOS)	0.15 (Gas)	190	96	19
	LNB	0.12 (Gas) 0.10 (No. 2 oil) 0.19 (No. 6 oil)	5,100-8,300	990-1,500	14
150 MMBtu/hr wood- fired stoker	SNCR	0.11	2,100-2,500	500-800	16
400 MMBtu/hr wood- fired FBC	SNCR	0.11	970	590	23
500 MMBtu/hr MSW stoker	SNCR	0.18	2,100-3,300	940-1,100	15

<sup>a</sup>Arithmetic average of reported NO<sub>x</sub> control performance. Not indicative of levels achievable in all cases.

<sup>b</sup>Calculated based on 0.66 capacity factor or 5,460 operating hours per year at the boiler capacity.

Note: All estimates are rounded to two significant figures.

$$Capital\ cost_2 = \left[ \frac{(MMBtu/hr)_2}{(MMBtu/hr)_1} \right]^{0.6} Capital\ cost_1 \quad (6-1)$$

The ranges in both capital and operating costs indicate that the references provided more than one cost case from which data could be extrapolated to the model boilers.

The reported capital cost of retrofit NO<sub>x</sub> controls has been found to vary by two orders of magnitude, from the low cost of BOOS (\$190/MMBtu) and WI (\$530/MMBtu), on small- to medium-sized gas-fired boilers, to the high estimate for SCR retrofit (\$20,000/MMBtu/hr), on PC-fired boilers. As shown, even the cost of SCR shows some large variations. Estimates from vendors and installers of the technology indicated that SCR can cost as little as \$2,400 to \$6,900/MMBtu for a relatively small gas-fired industrial boiler of 50 MMBtu/hr capacity (about 24 MWt), compared to an estimate of \$20,000/MMBtu based on estimates from a comparable-sized utility boiler.<sup>15</sup> However, because of the lack of experience with SCR on coal-fired industrial boilers, it is difficult to draw any definitive conclusions with respect to the actual retrofit cost of SCR on these boiler types. Recent experience with utility boilers indicates that the cost of SCR has lowered due to technology improvements and market competition. These benefits are likely to transfer into the industrial boiler sector.

Where applicable, the capital cost of SNCR has been found to be in the same range as the capital costs of such combustion controls as LNB and FGR. Both SNCR-urea and SNCR-ammonia estimates were based on costs provided by vendors, and escalated to account for boiler size differences. For example, for a PC-fired 800 MMBtu/hr (234 MWt) boiler, the capital cost for SNCR-ammonia was estimated by Exxon to be about \$900/MMBtu/hr.<sup>16</sup> For an 812 MMBtu/hr (238 MWt) tangential boiler, the capital cost for SNCR-urea was estimated by Nalco Fuel Tech to be about \$600/MMBtu/hr.<sup>17</sup>, while a smaller, 400 MMBtu/hr boiler will require an investment of \$830,000.<sup>17</sup> Figure 6-3 plots the actual or estimated capital cost for the Thermal DeNO<sub>x</sub> process for several boiler types. These costs were prepared by Exxon Research and Engineering (ER&E) for new and retrofit installations on large, >250 MMBtu/hr (73 MWt), industrial and utility boilers burning a variety of fuels, including waste fuels.<sup>24,25</sup> These data show the exponential increase in capital cost with decreasing boiler size (boiler capacity is plotted on a logarithmic scale).

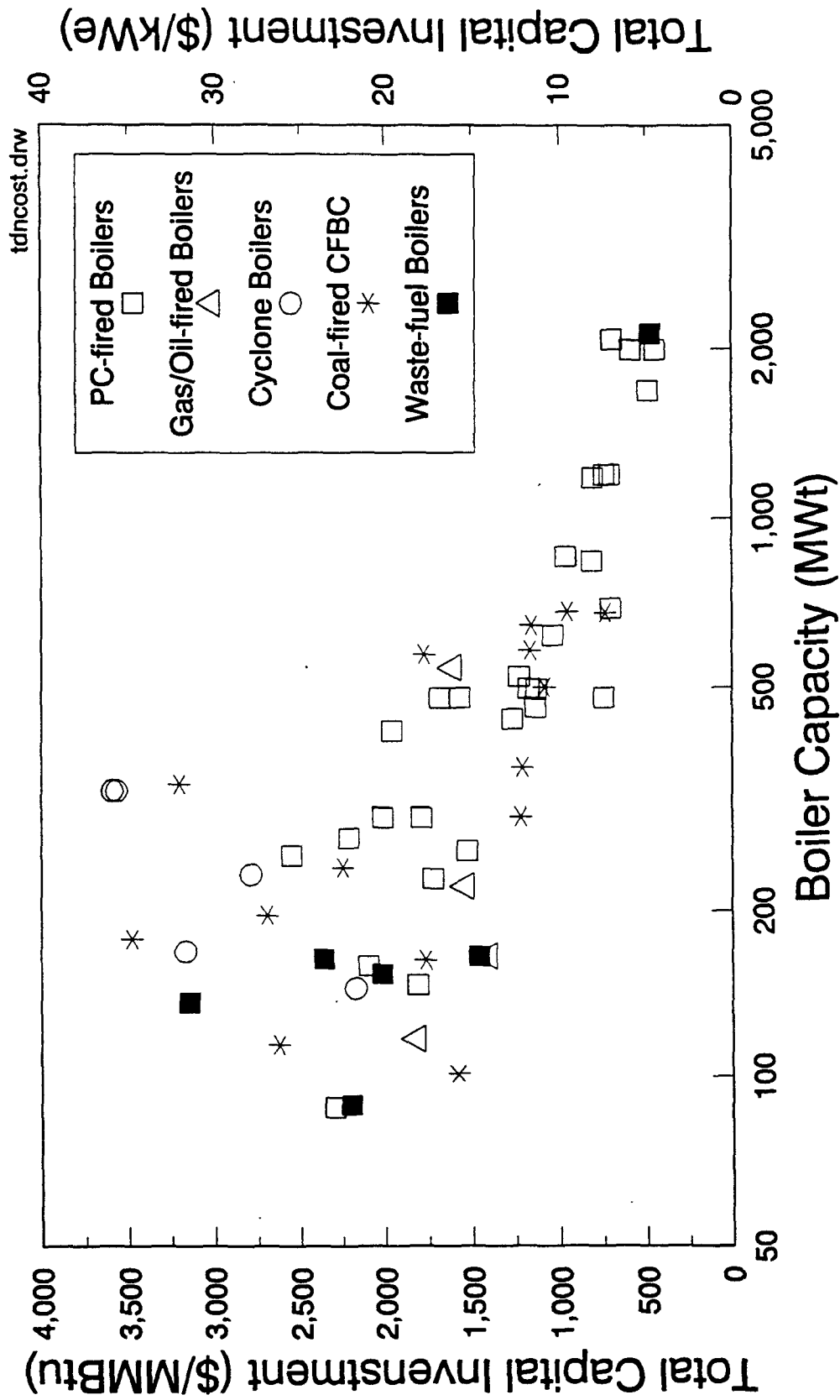

Source: Reference 22  
 Cost in \$/kWe assumes heat rate = 10,000 Btu/kWhr  
 Costs are based on 1989 and 1992 ER&E estimates

Figure 6-3. Total capital cost reported by Exxon for SNCR-ammonia on a variety of industrial boilers.

## 6.4 COST EFFECTIVENESS OF NO<sub>x</sub> CONTROLS

This section presents the cost effectiveness of various NO<sub>x</sub> controls retrofitted to a range of ICI boilers, using the costing methodology and assumptions discussed earlier. Section 6.4.1 describes the boiler NO<sub>x</sub> control cases analyzed, and Sections 6.4.2 through 6.4.6 discuss the cost analyses results.

### 6.4.1 NO<sub>x</sub> Control Cost Effectiveness: Coal-fired ICI Boilers

Table 6-6 summarizes the results obtained for coal-fired ICI boilers retrofitted with various NO<sub>x</sub> controls. The cost effectiveness values presented here and in all subsequent tables and figures in this chapter were calculated using capacity factors of 0.50 to 0.66. These capacity factors were chosen as mid-range capacity levels for this analysis, although it is likely that small ICI boilers such as packaged firetube units will have capacity factors less than 0.50.<sup>7</sup> In all cost cases, costs per ton of NO<sub>x</sub> control were higher as the capacity factor decreased, due to the reduced amount of NO<sub>x</sub> removed. Thus, costs for boilers with capacity factors such as 0.33 will be higher than those presented in this section. See Appendix D for calculated cost effectiveness values for capacity factors of 0.33 and 0.80.

Figure 6-4 graphically shows the relationship of cost effectiveness and boiler capacity for NO<sub>x</sub> controls retrofitted to PC wall-fired boilers. The cost estimates depicted are based on data from a detailed cost study for a 766 MMBtu/hr (224 MWt) PC wall-fired unit.<sup>14</sup> Cost estimates for other boiler sizes were extrapolated using the 0.6 power law for capital cost and a proportional dependence for O&M cost. The data show reduced costs per ton of NO<sub>x</sub> removed as boiler capacity increases, due to greater amounts of NO<sub>x</sub> removed and economies of scale. SNCR controls were the most cost effective per ton of NO<sub>x</sub> removed, with costs ranging from a low of \$950 per ton of NO<sub>x</sub> removed, for a 750 MMBtu/hr (220 MWt) unit, to a high of \$1,340 per ton, for a smaller, 250 MMBtu/hr (73 MWt) unit. The difference in cost effectiveness between SNCR with urea and SNCR with ammonia is well within the margin of error for this cost analysis.

LNB controls required greater expenditures for equivalent NO<sub>x</sub> removal, ranging from \$980 to \$1,760 per ton of NO<sub>x</sub> removed. LNB costs were developed based on estimates provided by CIBO.<sup>14</sup> SCR has the highest costs per ton of NO<sub>x</sub> removal, ranging from \$4,610 to \$7,810 per ton of NO<sub>x</sub>. These estimates were also developed from EPA cost estimates for a 100 MWe utility boiler.<sup>15</sup> Recent trends in SCR applications have shown significant decreases in capital investment for this technology. However, due to the lack of experience in SCR application on

**TABLE 6-6. SUMMARY OF NO<sub>x</sub> CONTROL COST EFFECTIVENESS, COAL-FIRED ICI BOILERS**

Boiler type	Boiler capacity, MMBtu/hr	NO <sub>x</sub> control technology	Controlled NO <sub>x</sub> level, lb/MMBtu	Cost effectiveness, \$/ton NO <sub>x</sub> removed <sup>a, b</sup>
PC wall-fired	250	LNB	0.35	1,340-1,760
	400	LNB	0.35	1,170-1,530
	500	LNB	0.35	1,090-1,430
	750	LNB	0.35	980-1,280
	250	SNCR-ammonia	0.39	1,360-1,450
	400	SNCR-ammonia	0.39	1,310-1,400
	500	SNCR-ammonia	0.39	1,300-1,370
	750	SNCR-ammonia	0.39	1,270-1,330
	250	SNCR-urea	0.39	1,120-1,340
	400	SNCR-urea	0.39	1,040-1,240
	500	SNCR-urea	0.39	1,010-1,190
	750	SNCR-urea	0.39	960-1,130
	250	SCR	0.14	3,800-4,800
	400	SCR	0.14	3,400-4,200
	500	SCR	0.14	3,200-4,000
	750	SCR	0.14	3,000-3,700
CFBC	250	SNCR-urea	0.08	960-1,130
	400	SNCR-urea	0.08	890-1,030
	500	SNCR-urea	0.08	860-980
	750	SNCR-urea	0.08	810-920
Spreader stoker	250	SNCR-urea	0.22	1,360-1,440
	400	SNCR-urea	0.22	1,320-1,380
	500	SNCR-urea	0.22	1,300-1,360
	750	SNCR-urea	0.22	1,280-1,320

<sup>a</sup>Capacity factor: 0.50-0.66. Costs based on 10-percent interest rate and 10-year capital amortization.

<sup>b</sup>1992 dollars.

PC-fired boilers, the actual cost of this control option is speculative at this stage. Overall, on a per-ton of NO<sub>x</sub> removed basis of comparison, SNCR controls were the most cost effective for PC wall-fired boilers.

It should be noted that the controlled NO<sub>x</sub> levels achieved using LNB were higher than those achieved using SNCR or SCR. This lower reduction efficiency, coupled with higher capital costs, results in higher cost effectiveness for LNB technology. For SCR controls, the most

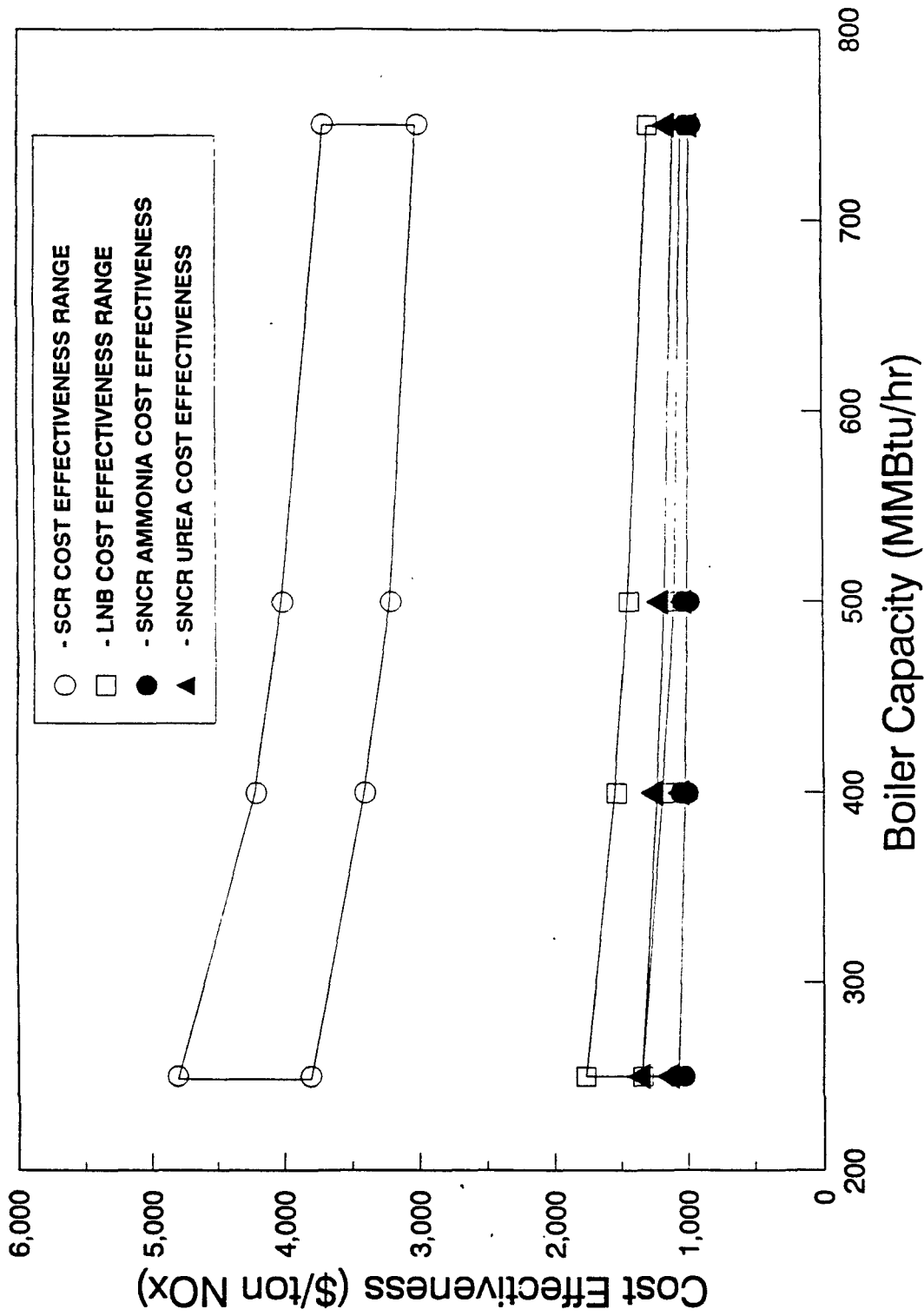

Boiler capacity factor = 0.50 to 0.66

Figure 6-4. Cost effectiveness versus boiler capacity, PC wall-fired boilers.

expensive cost elements were purchased equipment cost and annual chemical or catalyst replacement costs. SCR catalyst replacement was based on a 4-year catalyst life. Both capital and O&M SCR costs are in line with EPA estimates for small PC-fired utility boilers. In general, costs per ton of NO<sub>x</sub> control for tangential-fired PC boilers may be expected to be slightly higher than those estimated for the PC wall-fired units, since baseline NO<sub>x</sub> levels are generally lower for tangential firing, and, hence, the amount of NO<sub>x</sub> removed will be slightly lower.

#### 6.4.2 NO<sub>x</sub> Control Cost Effectiveness: Natural-gas-fired ICI Boilers

Cost effectiveness estimates were made for packaged watertube, packaged firetube, and field-erected wall-fired units firing natural gas, and are summarized in Table 6-7. Cost data for 26 different boilers were used to derive these estimates. Section 6.4.2.1 describes the results obtained for packaged watertube units equipped with WI+OT, LNB, LNB+FGR, and SCR. Section 6.4.2.2 presents cost effectiveness estimates for packaged firetube units retrofitted with WI+OT, and FGR controls, and Section 6.4.2.3 discusses field erected wall-fired units retrofitted with LNB. These estimates do not include the cost of purchasing and maintaining a fully instrumented CEM system to monitor compliance with an emission limit. The impact of CEMs on these costs is discussed in Section 6.4.6.

**TABLE 6-7. SUMMARY OF NO<sub>x</sub> CONTROL COST EFFECTIVENESS, NATURAL-GAS-FIRED ICI BOILERS**

Boiler type	Boiler capacity, MMBtu/hr	NO <sub>x</sub> control technology	Controlled NO <sub>x</sub> level, lb/MMBtu	Cost effectiveness, \$/ton NO <sub>x</sub> removed <sup>a,b</sup>
Packaged watertube (single-burner)	10	WI+OT	0.06	960-1,160
	25	WI+OT	0.06	800-940
	50	WI+OT	0.06	710-820
	100	WI+OT	0.06	570-650
	150	WI+OT	0.06	540-610
	250	WI+OT	0.08	380-430
	10	LNB	0.08	990-4,300
	25	LNB	0.08	720-3,070
	50	LNB	0.08	570-2,390
	100	LNB	0.09	410-1,670
	150	LNB	0.09	360-1,450
	250	LNB	0.12	240-920

<sup>a</sup>Capacity factor: 0.50-0.66. Costs based on 10-percent interest rate and 10-year capital amortization.

<sup>b</sup>1992 dollars.

(continued)



TABLE 6-7. (continued)

Boiler type	Boiler capacity, MMBtu/hr	NO <sub>x</sub> control technology	Controlled NO <sub>x</sub> level, lb/MMBtu	Cost effectiveness, \$/ton NO <sub>x</sub> removed <sup>a,b</sup>
Packaged watertube (single-burner) (continued)	10	LNB+FGR	0.06	2,630-7,630
	25	LNB+FGR	0.06	1,930-5,510
	50	LNB+FGR	0.06	1,540-4,350
	100	LNB+FGR	0.07	1,110-3,090
	150	LNB+FGR	0.07	990-2,730
	250	LNB+FGR	0.10	650-1,760
	10	SCR	0.02	7,400-10,090
	25	SCR	0.02	5,730-8,010
	50	SCR	0.02	4,830-6,880
	100	SCR	0.03	3,040-5,350
	150	SCR	0.03	2,690-4,990
	250	SCR	0.04	1,810-3,460
Packaged firetube	2.9	WI+OT	0.04	4,190-5,240
	5.2	WI+OT	0.04	3,600-4,450
	10.5	WI+OT	0.04	3,050-3,720
	20.9	WI+OT	0.04	2,640-3,180
	33.5	WI+OT	0.04	2,410-2,890
	2.9	FGR+OT	0.07	26,570-35,410
	5.2	FGR+OT	0.07	15,160-20,380
	10.5	FGR+OT	0.07	7,970-10,830
	20.9	FGR+OT	0.07	4,520-6,100
	33.5	FGR+OT	0.07	3,000-4,080
Field-erected wall-fired (multiple-burner)	100	BOOS+OT	0.09	440-510
	250	BOOS+OT	0.12	280-330
	400	BOOS+OT	0.15	210-240
	500	BOOS+OT	0.15	210-240
	750	BOOS+OT	0.20	150-170
	100	BOOS+WI+OT	0.05	750-820
	250	BOOS+WI+OT	0.06	530-570
	400	BOOS+WI+OT	0.08	410-440
	500	BOOS+WI+OT	0.08	400-430
	750	BOOS+WI+OT	0.10	300-310
	250	LNB	0.12	3,030-6,210
	400	LNB	0.15	2,070-4,210
	500	LNB	0.15	1,920-3,900
	750	LNB	0.20	1,690-3,400

<sup>a</sup>Capacity factor: 0.50-0.66. Costs based on 10-percent interest rate and 10-year capital amortization.

<sup>b</sup>1992 dollars.

#### 6.4.2.1 Natural-gas-fired Packaged Watertube Boilers

NO<sub>x</sub> control cost data for natural-gas-fired packaged (single-burner) watertube boilers are more available than for other boiler and fuel types, primarily due to retrofit activity in California. Cost data from four boilers were used to estimate costs of WI and LNB retrofit, while data from six units were used to estimate combined LNB and FGR retrofit costs. SCR retrofit cost estimates were based on data supplied by a major manufacturer of SCR systems, with experience installing SCR systems on packaged boilers rated as small as 66,000 lb steam/hr (8.3 kg/s).

As tabulated in Table 6-7 and shown in Figure 6-5, cost effectiveness estimates for packaged watertube units fired by natural gas were highest for SCR NO<sub>x</sub> control and lowest for LNB and WI+OT, with LNB+FGR falling in between. WI+OT is considered cost-competitive with LNB because of its low initial capital investment. In spite of the thermal efficiency loss of 0.5 to 1.0 percent associated with WI, this technique can be cost effective especially for small boilers with a low capacity factor.

As was the case with coal-fired units, costs per ton of NO<sub>x</sub> reduction decreased with increased boiler capacity, due to the increased amount of NO<sub>x</sub> removed from the larger units and general economies of scale. For packaged watertube units, the effect of boiler capacity on cost effectiveness becomes significant below about 50 MMBtu/hr (15 MWt) capacity. For units smaller than this capacity, costs of NO<sub>x</sub> control increase rapidly as capacity decreases, especially when SCR is used. The costs per ton of NO<sub>x</sub> control for a 250 MMBtu/hr (73 MWt) single-burner packaged boiler with LNB are much lower than those estimated for a multiple-burner field-erected unit of similar size. Some of the discrepancy between the figures can be attributed to the different data sources; however, the principal reason lies in the number of burners to be retrofitted. A field-erected unit with four or more burners, for example, will tend to require capital equipment and installation costs several times higher than a single-burner unit.

On average, LNB+FGR control costs per ton of NO<sub>x</sub> removed were twice as high as for LNB and WI+OT, while SCR control costs per ton of NO<sub>x</sub> removed were 3 times higher. Cost effectiveness of WI+OT ranged from \$380 to \$1,160 per ton of NO<sub>x</sub> removed. Cost effectiveness for LNB controls ranged from \$240 to \$4,300 per ton of NO<sub>x</sub> removed, across the capacity range of 10 to 250 MMBtu/hr (2.9 to 73 MWt). LNB+FGR cost effectiveness ranged from about \$650 to \$7,630/ton, while SCR had the highest range in cost per ton of NO<sub>x</sub>

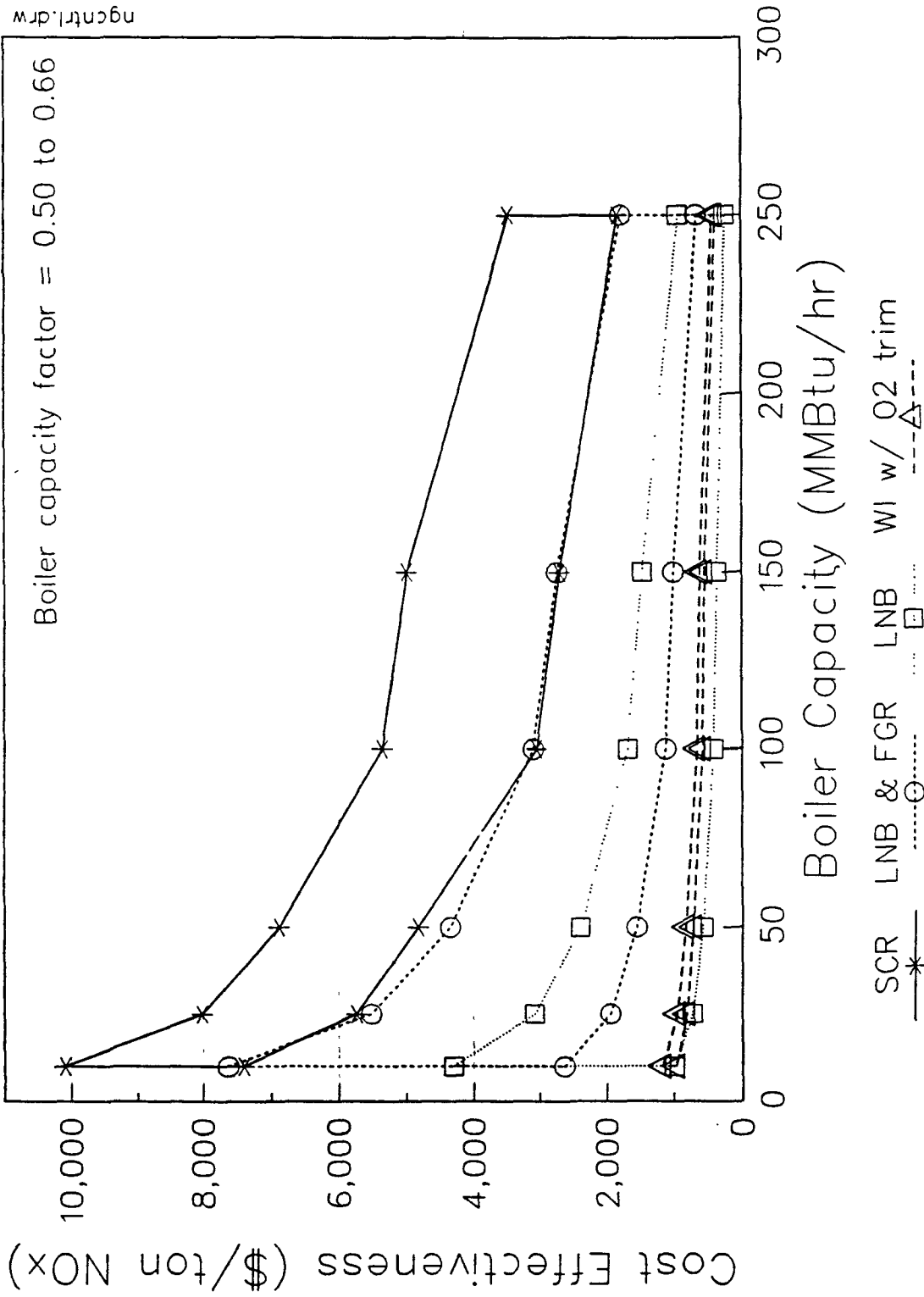

Figure 6-5. Cost effectiveness versus boiler capacity, natural-gas-fired packaged watertube boilers.

removed, approximately \$1,810 to \$10,090/ton. The high-end costs of these ranges were for the smallest, 10 MMBtu/hr (2.9 MWt) units at a 0.50 capacity factor. Because it is likely that many units this small are operated at even lower capacity factors, actual costs of NO<sub>x</sub> control may be much higher than these estimates. For these lower capacity factor boilers, controls with a high initial capital investment, such as SCR, LNB, and LNB+FGR, are particularly penalized when compared on a cost-effectiveness basis.

Figure 6-5 illustrates the overall trend of cost effectiveness with boiler capacity. The enclosed areas reflect the ranges in cost and are representative of the uncertainty in these estimates. Cost-effectiveness ranges for LNB and for LNB+FGR overlap, due to the wide range of cost effectiveness values obtained. These cost-effectiveness data illustrate the potential variability in the costs of retrofitting boilers with NO<sub>x</sub> controls, which are highly dependent on site-specific installation and operating factors. Figure 6-6 illustrates the variability of the cost effectiveness of SCR controls, assuming various catalyst lifetimes. As catalyst life increases, cost effectiveness slowly decreases.

#### **6.4.2.2 Natural-gas-fired Firetube Boilers**

Cost data were obtained for retrofitting WI+OT and FGR+OT controls to packaged firetube units ranging in size from approximately 3 to 34 MMBtu/hr (0.9 to 10 MWt) capacity. The data for FGR+OT controls were obtained from a distributor of industrial boilers and NO<sub>x</sub> control systems, and are based on experiences with nearly 20 units operating with FGR.<sup>20</sup> Costs for WI+OT are based on recently reported NO<sub>x</sub> retrofit experiences in Southern California.<sup>19</sup>

FGR+OT is one of the most common retrofit NO<sub>x</sub> control strategies for natural-gas-fired firetube units, besides LNB or combined LNB and FGR. Costs per ton of NO<sub>x</sub> removed for these units firing natural gas were relatively high, ranging from \$3,000 to \$35,410, with the highest costs being for units 5 MMBtu/hr (1.5 MWt) and smaller. The most significant cost components for these cost cases were equipment and installation costs. The costs of NO<sub>x</sub> control for a 10 MMBtu/hr (2.9 MWt) firetube unit retrofitted with FGR+OT are relatively similar to the high-end costs estimated for a 10 MMBtu/hr (2.9 MWt) watertube unit retrofitted with LNB and FGR, as discussed above. Although no cost estimates were made for firetube units retrofitted with LNB or LNB+FGR controls, it is likely that cost effectiveness for these control cases will be comparable to those estimated for packaged watertube units of similar capacity.

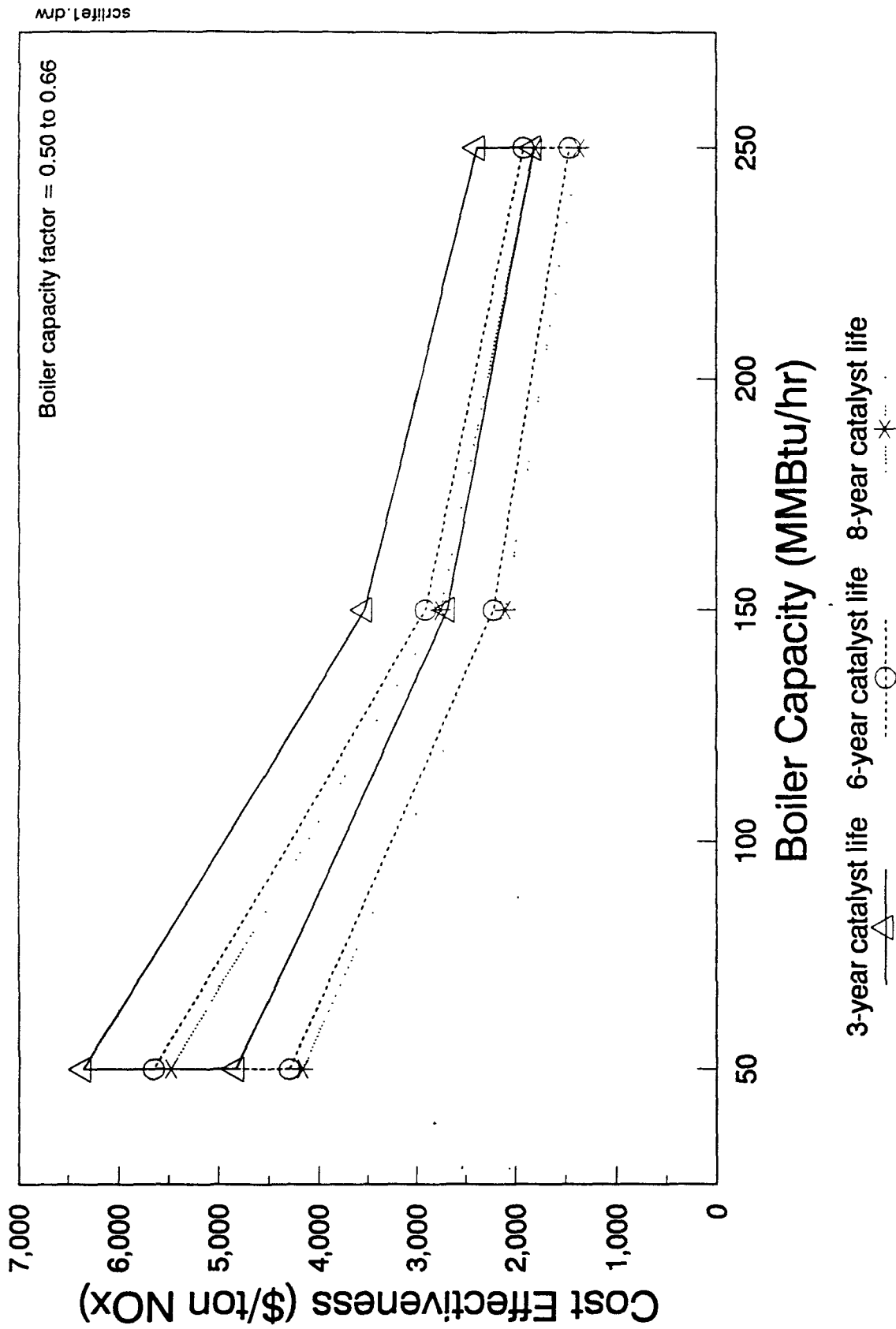

Figure 6-6. Cost effectiveness versus boiler capacity, natural-gas-fired packaged watertube boilers using SCR controls.

The estimated costs for WI+OT for these firetube boilers are based on a retrofit investment of \$35,000, irrespective of boiler size, and an efficiency penalty of 1.0 percent. It is difficult to predict the actual thermal efficiency impact in a retrofit situation. The actual impact will depend on current unit operating practices; given a poor operating condition with high excess air combustion, the retrofit of this control may, in some cases, result in an improvement. However, it was considered prudent to associate an efficiency loss with the use of WI in spite of potential gains with an OT control. As shown in Table 6-7, the estimated cost for this control strategy is similar to that for LNB retrofit, but still slightly higher than comparable controls for watertube units. This is due to lower baseline NO<sub>x</sub> levels for firetube boilers compared with watertube units (see Table 6-2).

#### 6.4.2.3 Natural-gas-fired Field-erected Wall-fired Boilers

The implementation of BOOS or biased firing and WI on large multi-burner gas-fired boilers will depend on the number of burners available and the load requirements of the boiler. Units with several burners with small heat input ratings per burner offer the greater opportunity for implementation of these effective control techniques. Where possible, the retrofit of BOOS and BOOS+WI+OT is likely to be the more cost effective options in spite of thermal efficiencies, here assumed to range between 0.25 and 1.0 percent. The lower the capacity factor of these boilers, the more cost-competitive these controls may prove to be. Estimates in this study range between about \$150 and \$510 per ton for BOOS+OT, and between \$300 and \$820 per ton for BOOS+WI+OT.

Cost estimates per ton of NO<sub>x</sub> removed for natural-gas-fired field-erected units with LNB, listed in Table 6-7, range from \$1,690 to \$6,210 per ton of NO<sub>x</sub> removed for boilers ranging in size from 250 to 750 MMBtu/hr (73 to 220 MWt). The costs per ton of NO<sub>x</sub> control for a multiple-burner field-erected 250 MMBtu/hr (73 MWt) unit are much higher than the costs estimated for a single-burner packaged unit due to greater capital equipment and installation costs as discussed in Section 6.4.2.1. Although the listed cost effectiveness ranges are for a capacity factor as low as 0.50, most field-erected units have factors closer to 0.66.<sup>7</sup> The high end of the cost effectiveness ranges listed in Table 6-7 represent a 0.50 capacity factor. If considering a 0.66 capacity factor only, the high-end cost effectiveness estimates are roughly 25 percent lower. The estimates presented are based on capital cost data supplied for two boilers retrofitted with LNB.<sup>14</sup>

#### **6.4.3 NO<sub>x</sub> Control Cost Effectiveness: Fuel-oil-fired ICI Boilers**

As discussed earlier, NO<sub>x</sub> control cost effectiveness estimates for fuel-oil-firing units were made based on cost data for natural-gas-fired boilers, using appropriate baseline NO<sub>x</sub> emission levels and fuel oil prices. Tables 6-8 and 6-9 summarize these estimates, and Figures 6-7 and 6-8 graphically show the results for packaged watertube boilers. NO<sub>x</sub> controls that use water injection were not considered for oil-fired units because of lack of experience and greater operational and environmental impacts that are likely with these fuels compared with natural gas. Comparative cost results for the different NO<sub>x</sub> control technologies are similar to those obtained for natural-gas-fired units, as expected, with SCR showing the highest costs per ton of NO<sub>x</sub> removed and LNB showing the lowest. Like the cost estimates for natural gas firing, LNB+FGR control costs were, on average, twice as high as the costs of LNB controls, while SCR controls were 3 times as high.

Overall costs of NO<sub>x</sub> control per ton removed are lower for fuel oil firing than for natural gas firing due to higher baseline NO<sub>x</sub> emission levels, and, hence, greater amounts of NO<sub>x</sub> removal per MMBtu heat input. As discussed for natural gas-fired boilers, the cost effectiveness discrepancy between a 250 MMBtu/hr (73 MWt) packaged boiler and a 250 MMBtu/hr (73 MWt) field-erected unit equipped with LNB is primarily due to the greater capital equipment and installation costs associated with retrofitting multiple burners rather than a single burner. Multiple-burner field-erected boilers are likely to benefit from selected BOOS. Where applicable, this technique can result in considerable NO<sub>x</sub> reduction at much lower cost than LNB retrofit.

#### **6.4.4 NO<sub>x</sub> Control Cost Effectiveness: Nonfossil-fuel-fired ICI Boilers**

Limited cost data were available for nonfossil-fuel-fired boilers retrofitted with NO<sub>x</sub> controls. For this reason, cost estimates could only be made for the application of SNCR controls to several types of nonfossil-fuel-fired boilers. Data were obtained directly from leading SNCR system manufacturers, and reflect cost experiences for nine different installations. NO<sub>x</sub> control performance and cost are considered the same regardless of the reagent used. Typical applications use either ammonia or urea in aqueous solution. Table 6-10 summarizes the cost effectiveness ranges for these boilers. Cost effectiveness estimates made for wood-fired stokers with urea injection are comparable to those calculated for wood-fired FBC boilers with ammonia injection, ranging between \$890 and \$2,130 per ton of NO<sub>x</sub> removed for boilers 250 to 500 MMBtu/hr (73 to 146 MWt). The range in cost effectiveness for MSW-fired stokers of the

TABLE 6-8. SUMMARY OF NO<sub>x</sub> CONTROL COST EFFECTIVENESS, DISTILLATE-OIL-FIRED ICI BOILERS

Boiler type	Boiler capacity, MMBtu/hr	NO <sub>x</sub> control technology	Controlled NO <sub>x</sub> level, lb/MMBtu	Cost effectiveness, \$/ton NO <sub>x</sub> removed <sup>a,b</sup>
Packaged watertube (single burner)	10	LNB	0.10	790-3,440
	25	LNB	0.10	580-2,450
	50	LNB	0.10	460-1,910
	100	LNB	0.10	370-1,500
	150	LNB	0.10	330-1,310
	250	LNB	0.10	280-1,110
	10	LNB+FGR	0.08	1,900-5,900
	25	LNB+FGR	0.08	1,340-4,210
	50	LNB+FGR	0.08	1,030-3,280
	100	LNB+FGR	0.08	800-2,580
	150	LNB+FGR	0.08	690-2,250
	250	LNB+FGR	0.08	580-1,910
	10	SCR	0.03	5,920-8,070
	25	SCR	0.03	4,590-6,410
	50	SCR	0.03	3,860-5,500
	100	SCR	0.03	2,740-4,820
	150	SCR	0.03	2,420-4,490
	250	SCR	0.03	2,170-4,150
Packaged firetube	2.9	FGR+OT	0.12	15,640-20,940
	5.2	FGR+OT	0.12	8,800-11,930
	10.5	FGR+OT	0.12	4,490-6,200
	20.9	FGR+OT	0.12	2,410-3,360
	33.5	FGR+OT	0.12	1,500-2,150
Field-erected wall-fired (multiple burner)	250	LNB	0.10	3,630-7,450
	400	LNB	0.10	3,100-6,320
	500	LNB	0.10	2,880-5,850
	750	LNB	0.10	2,530-5,100

<sup>a</sup>Capacity factor: 0.50-0.66. Costs based on 10-percent interest rate and 10-year capital amortization.

<sup>b</sup>1992 dollars.



**TABLE 6-9. SUMMARY OF NO<sub>x</sub> CONTROL COST EFFECTIVENESS, RESIDUAL-OIL-FIRED ICI BOILERS**

Boiler type	Boiler capacity, MMBtu/hr	NO <sub>x</sub> control technology	Controlled NO <sub>x</sub> level, lb/MMBtu	Cost effectiveness, \$/ton NO <sub>x</sub> removed <sup>a, b</sup>	
Packaged watertube (single burner)	10	LNB	0.19	420-1,810	
	25	LNB	0.19	300-1,290	
	50	LNB	0.19	240-1,010	
	100	LNB	0.19	190-790	
	150	LNB	0.19	170-690	
	250	LNB	0.19	150-580	
	10	LNB+FGR	0.23	1,220-3,320	
	25	LNB+FGR	0.23	920-2,430	
	50	LNB+FGR	0.23	760-1,950	
	100	LNB+FGR	0.23	640-1,580	
	150	LNB+FGR	0.23	580-1,400	
	250	LNB+FGR	0.23	520-1,220	
	10	SCR	0.06	3,110-4,240	
	25	SCR	0.06	2,420-3,370	
	50	SCR	0.06	2,030-2,900	
	100	SCR	0.06	1,440-2,530	
	150	SCR	0.06	1,270-2,360	
	250	SCR	0.06	1,140-2,190	
	Packaged firetube	2.9	FGR+OT	0.23	8,560-11,350
		5.2	FGR+OT	0.23	4,960-6,600
		10.5	FGR+OT	0.23	2,690-3,590
20.9		FGR+OT	0.23	1,600-2,100	
33.5		FGR+OT	0.23	1,120-1,460	
Field-erected wall-fired (multiple burner)	250	LNB	0.19	1,910-3,920	
	400	LNB	0.19	1,630-3,330	
	500	LNB	0.19	1,520-3,080	
	750	LNB	0.19	1,330-2,680	

<sup>a</sup>Capacity factor: 0.50-0.66. Costs based on 10-percent interest rate and 10-year capital amortization.

<sup>b</sup>1992 dollars.

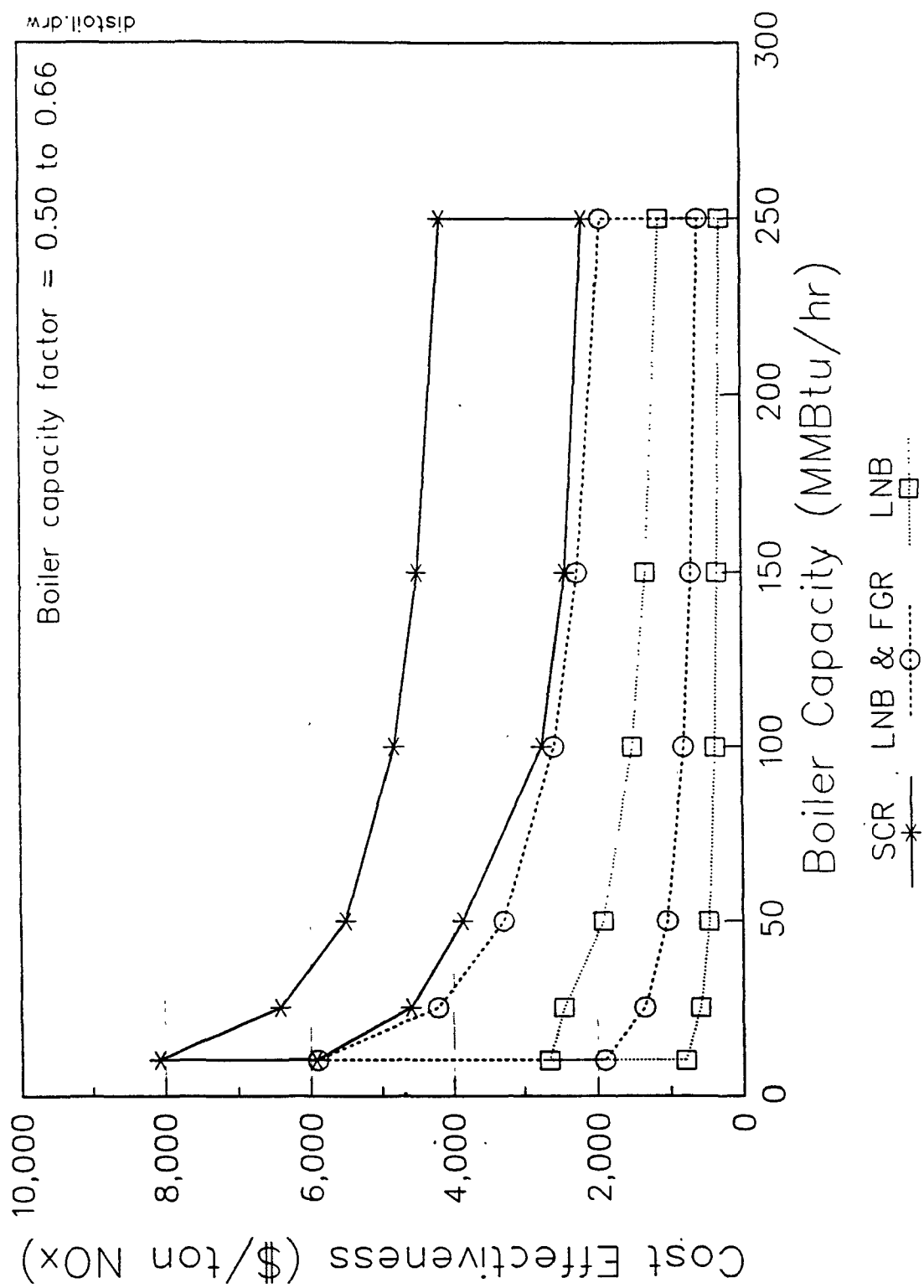

Figure 6-7. Cost effectiveness versus boiler capacity, distillate-oil-fired boilers.

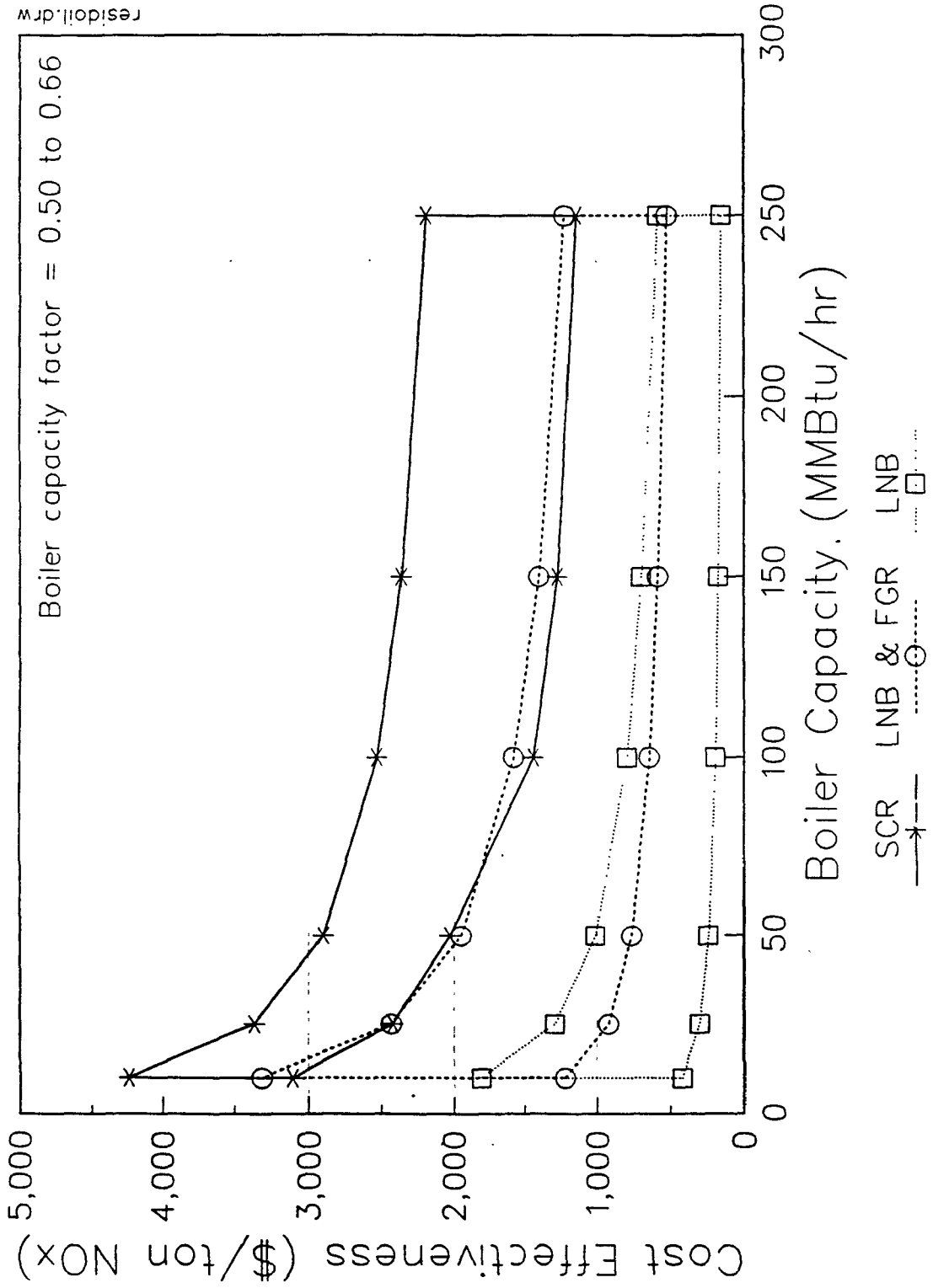

Figure 6-8. Cost effectiveness versus boiler capacity, residual-oil-fired boilers.

**TABLE 6-10. SUMMARY OF NO<sub>x</sub> CONTROL COST EFFECTIVENESS, NONFOSSIL-FUEL-FIRED ICI BOILERS**

Boiler type	Fuel type	Boiler capacity, MMBtu/hr	NO <sub>x</sub> control technology	Controlled NO <sub>x</sub> level, lb/MMBtu	Cost effectiveness, \$/ton NO <sub>x</sub> removed <sup>a,b</sup>
Stoker	Wood	50	SNCR-urea	0.11	1,810-3,130
		150	SNCR-urea	0.11	1,270-2,380
		250	SNCR-urea	0.11	1,080-2,130
		350	SNCR-urea	0.11	980-2,000
		500	SNCR-urea	0.11	890-1,870
	MSW	50	SNCR-urea	0.18	3,390-3,800
		150	SNCR-urea	0.18	1,890-2,790
		250	SNCR-urea	0.18	1,690-2,450
		350	SNCR-urea	0.18	1,580-2,270
		500	SNCR-urea	0.18	1,470-2,090
Packaged watertube	Paper	10	SNCR-urea	0.23	2,220-3,520
		25	SNCR-urea	0.23	1,780-2,710
		50	SNCR-urea	0.23	1,550-2,270
		100	SNCR-urea	0.23	1,370-1,930
		150	SNCR-urea	0.23	1,280-1,770
		250	SNCR-urea	0.23	1,190-1,610
BFBC	Wood	250	SNCR-ammonia	0.11	1,560-1,750
		350	SNCR-ammonia	0.11	1,480-1,650
		400	SNCR-ammonia	0.11	1,450-1,600
		500	SNCR-ammonia	0.11	1,390-1,530
		750	SNCR-ammonia	0.11	1,110-1,310

<sup>a</sup>Capacity factor: 0.50-0.66. Costs based on 10-percent interest rate and 10-year capital amortization.

<sup>b</sup>1992 dollars.

same capacity retrofit with urea injection is \$1,470 and \$2,450 per ton of NO<sub>x</sub> removed. For wood- or MSW-fired boilers smaller than 250 MMBtu/hr (73 MWt) but at least 50 MMBtu/hr (15 MWt), SNCR control costs ranged from approximately \$1,270 to \$3,800 per ton of NO<sub>x</sub> removed. Cost estimates for similarly sized paper-fired units were lower, ranging from \$1,280 to roughly \$2,270 per ton of NO<sub>x</sub> removed.

#### 6.4.5 NO<sub>x</sub> Control Cost Effectiveness: Oil-fired Thermally Enhanced Oil Recovery (TEOR) Steam Generators

No cost analyses were performed for NO<sub>x</sub> controls for TEOR steam generators. However, it has been estimated that for a 25 MMBtu/hr (7.3 MWt) crude-oil-fired TEOR unit, annual costs would be \$52,000 for LNB retrofit, \$88,000 for SNCR, and \$400,000 for SCR.<sup>26</sup>

Based on these estimates, and assuming a baseline NO<sub>x</sub> emission level of 0.38 lb/MMBtu (see Chapter 4) and the NO<sub>x</sub> reduction efficiencies listed in Table 6-3, cost effectiveness is \$3,790 per ton of NO<sub>x</sub> removed for LNB at 0.66 capacity factor, \$8,000/ton for SNCR, and \$19,400/ton for SCR.

#### 6.4.6 Cost Effect of Continuous Emissions Monitoring (CEM) System

Addition of a CEM system to an NO<sub>x</sub> control retrofit package can increase the costs of NO<sub>x</sub> control. For example, Table 6-11 shows the cost effect of adding a CEM system to a natural-gas-fired packaged watertube boiler, equipped with LNB or with LNB and FGR. The cost estimates are based on data from one source, for a 265 MMBtu/hr (77.7 MWt) unit, that showed a total CEM system capital cost of roughly \$200,000, including installation.<sup>14</sup> Average cost increased by roughly 65 percent when a CEM system was included. While it is not possible to draw conclusions from one source about the extent to which CEM systems will increase costs, the data nevertheless show that CEM cost impact is considerable. For small-capacity boilers, in particular, the additional cost of CEM may be disproportionately large when compared to the overall cost of the boiler itself. At least one California air district requires CEM systems only for boilers that are 40 MMBtu/hr (12 MWt) or greater in capacity.<sup>27</sup>

**TABLE 6-11. NO<sub>x</sub> CONTROL COST EFFECTIVENESS WITHOUT/WITH CEM SYSTEM, NATURAL-GAS-FIRED ICI BOILERS<sup>a</sup>**

Boiler type	Boiler capacity, MMBtu/hr	NO <sub>x</sub> control technology	Controlled NO <sub>x</sub> level, lb/MMBtu	Cost effectiveness without CEM, \$/ton NO <sub>x</sub> removed <sup>b,c</sup>	Cost effectiveness with CEM, \$/ton NO <sub>x</sub> removed <sup>b,c</sup>
Packaged watertube	10	LNB	0.08	3,260-4,300	5,410-7,140
	25	LNB	0.08	2,320-3,070	3,850-5,080
	50	LNB	0.08	1,810-2,390	3,000-3,960
	100	LNB	0.09	1,260-1,670	2,090-2,760
	150	LNB	0.09	1,100-1,450	1,830-2,410
	250	LNB	0.12	700-920	1,160-1,530
	10	LNB+FGR	0.06	3,700-5,000	5,480-7,360
	25	LNB+FGR	0.06	2,530-3,460	3,800-5,140
	50	LNB+FGR	0.06	1,900-2,620	2,890-3,930
	100	LNB+FGR	0.07	1,260-1,760	1,950-2,680
	150	LNB+FGR	0.07	1,050-1,500	1,660-2,290
	250	LNB+FGR	0.10	630-910	1,020-1,420

<sup>a</sup>Based on data contained in Reference 19, for a 265 MMBtu/hr (7.7 MWt) natural-gas-fired unit.

<sup>b</sup>Capacity factor: 0.50-0.66. Costs based on 10-percent interest rate and 10-year capital amortization.

<sup>c</sup>1992 dollars.

## 6.5 REFERENCES FOR CHAPTER 6

1. OAQPS Control Cost Manual — Fourth Edition. Publication No. EPA-450/3-90-006. U.S. Environmental Protection Agency. Office of Air Quality Planning and Standards. Research Triangle Park, NC. January 1990.
2. Economic Indicators — CE Plant Cost Index. Chemical Engineering. March 19, 1984.
3. Economic Indicators — CE Plant Cost Index. Chemical Engineering. January 16, 1989.
4. Economic Indicators — CE Plant Cost Index. Chemical Engineering. December 1993.
5. Peters, M. and K. Timmerhaus. Plant Design and Economics for Chemical Engineers. McGraw-Hill Book Company. New York, NY. 1980.
6. Technical Support Document for a Suggested Control Measure for the Control of Emissions of Oxides of Nitrogen from Industrial, Institutional, and Commercial Boilers, Steam Generators, and Process Heaters. (California ARB, 1987) Statewide Technical Review Group. California Air Resources Board. Sacramento, CA. April 1987.
7. Devitt, T., et al (PEDCo Environmental, Inc.). Population and Characteristics of Industrial/Commercial Boilers in the U.S. Publication No. EPA-600/7-79-178a. Prepared for the U.S. Environmental Protection Agency. Research Triangle Park, NC. August 1979.
8. Bowen, M. and M. Jennings. (Radian Corp.). Costs of Sulfur Dioxide, Particulate Matter, and Nitrogen Oxide Controls on Fossil Fuel Fired Industrial Boilers. Publication No. EPA-450/3-82-021. Prepared for the U.S. Environmental Protection Agency. Research Triangle Park, NC. August 1982.
9. Damon, J., et al. (United Engineers and Constructors). Updated Technical and Economic Review of Selective Catalytic  $\text{NO}_x$  Reduction Systems. Proceedings: 1987 Symposium on Stationary Combustion  $\text{NO}_x$  Control. Publication No. EPRI CS-5361. U.S. Environmental Protection Agency/Electric Power Research Institute. Palo Alto, CA. August 1987.
10. Letter and attachments from Dean, H., Hugh Dean & Co., Inc., to Votlucka, P., South Coast Air Quality Management District. Cost Analyses of FGR Retrofit to Natural-gas-fired Firetube Boilers. January 15, 1988.
11. Current Prices Estimated. Energy User News. April 1991.
12. Makansi, J. Ammonia: It's Coming to a Plant Near You. Power. May 1992.
13. Grant, E., et al. Principles of Engineering Economy. John Wiley & Sons. New York, NY. 1982.
14. Letter and Attachments from Marx, W., CIBO, to Seu, S., Acurex Environmental Corporation.  $\text{NO}_x$  Control Technology Costs. June 12, 1992.

15. Alternative Control Techniques Document--NO<sub>x</sub> Emissions from Utility Boilers. Publication No. EPA-453/R-94-023. U.S. Environmental Protection Agency. Office of Air Quality Planning and Standards. Research Triangle Park, NC. March 1994.
16. Letter and attachments from Shaneberger, D., Exxon Research and Engineering Company, to Castaldini, C., Acurex Environmental Corporation. Thermal DeNO<sub>x</sub> Costs. December 3, 1993.
17. Letter and attachments from Pickens, R., Nalco Fuel Tech, to Castaldini, C., Acurex Environmental Corporation. NO<sub>x</sub> Control Technology Costs. March 15, 1994.
18. Letter and Attachments from Pickens, R., Nalco Fuel Tech, to Castaldini, C., Acurex Environmental Corporation. SNCR-urea (NO<sub>x</sub>OUT) Control Costs. June 9, 1992.
19. Colannino, J. Low-Cost Techniques-Reduce Boiler NO<sub>x</sub>. Chemical Engineering. February 1993. p. 100.
20. Letter and Attachments from Dean, H., Hugh Dean & Co., Inc., to Votlucka, P., South Coast Air Quality Management District. Cost Effectiveness of FGR NO<sub>x</sub> Control for Firetube Boilers. January 12, 1988.
21. University of California at Riverside Central Utility Plant Boiler System Study. Impell Corporation. Walnut Creek, CA. June 1989.
22. Letter and Attachments from Burlage, P., Peerless Mfg. Co., to Brizzolara, L., A.H. Merrill & Associates. SCR Equipment and Installation Costs. June 22, 1992.
23. Hurst, B., et al. (Exxon Research and Engineering Co.). Exxon Thermal DeNO<sub>x</sub> Effectiveness Demonstrated in a Wood-Fired Boiler. Presented at the 13th National Waste Processing Conference and Exhibit. May 1988.
24. Letter and attachments from G. A. Haas, Exxon Research and Engineering Company, to B. Jordan, U.S. EPA, OAQPS, Durham, NC. NO<sub>x</sub> Control Technologies Questionnaire. February 18, 1993.
25. Bodylski, J. A. and G. A. Haas. The Selective Non-Catalytic Reduction (SNCR) Process: Experience with Exxon Thermal DeNO<sub>x</sub> Process at Two Circulating Fluidized Bed Boiler Commercial Applications. Presented at the American Flame Research Committee 1992 Fall International Symposium on Emission Reduction and Energy Conservation: Progress in Combustion Technology. Cambridge, MA. October 1992.
26. Collins, J. (Radian Corp.). Technology Study of NO<sub>x</sub> Controls for "Small" Oil-Fired Steam Generators. Prepared for the Western Oil and Gas Association. Bakersfield, CA. January 6, 1987.
27. Rule 1146 — Emissions of Oxides of Nitrogen from Industrial, Institutional, and Commercial Boilers, Steam Generators, and Process Heaters. South Coast Air Quality Management District. El Monte, CA. January 1989.

## **7. ENVIRONMENTAL AND ENERGY IMPACTS**

This chapter presents environmental and energy impacts for the NO<sub>x</sub> emissions control techniques described in Chapter 5. These control techniques are specific to certain boiler and fuel equipment, as shown in Table 7-1. For example, LNB is not applicable to stoker and FBC boilers. WI and FGR are rarely considered when burning coal in any type of industrial combustion equipment. Similarly, among ICI boilers reburning with natural gas has only limited application potential to boilers burning municipal solid waste or stoker coal. Flue gas treatment controls have limited application experience, especially for SCR, on small boilers and boilers burning fuels other than natural gas. SNCR, instead, is generally limited to application on larger boilers with the greatest performance success recorded on FBC boilers.

This chapter is organized in four major sections. Section 7.1 presents the air pollution impacts, Section 7.2 the solid waste disposal impacts, Section 7.3 the water pollution impacts, and Section 7.4 the energy impacts.

### **7.1 AIR POLLUTION**

#### **7.1.1 NO<sub>x</sub> Reductions**

Control techniques presented in this document can result in significant NO<sub>x</sub> reductions for selected ICI boilers. The actual NO<sub>x</sub> reduction that can be achieved at each site will depend on many factors including the extent of the equipment upgrade, the degree of control applied, and the boilers current configuration such as furnace size, number of burners and burner matrix. For example, the amount of flue gas recirculated has a strong influence on the percent NO<sub>x</sub> reduction. Also, the amount that can be safely recirculated will depend on the optimization of the burner design in order to maintain safe flame conditions, and low emissions of other pollutants such as CO. In another example, the amount of SCR catalyst that can be retrofit may depend on site accessibility. Many ICI boilers are often located inside buildings making access for large retrofit difficult at best.

Table 7-2 lists the anticipated NO<sub>x</sub> reductions that can be achieved on a yearly basis with the retrofit of candidate control techniques. These estimates are based on "model size"



TABLE 7-1. EXPERIENCE WITH NO<sub>x</sub> CONTROL TECHNIQUES ON ICI BOILERS

NO <sub>x</sub> control technique	Coal-fired			Oil-/natural-gas-fired			Nonfossil-fuel-fired			MSW-fired
	Field-erected PC-fired	Stoker	FBC	Field-erected watertube	Packaged watertube	Packaged firetube	Stoker	FBC	Mass burn	
BT/OT					X	X				
WI/SI					X	X				
SCA	X	X <sup>a</sup>	X	X	X <sup>b</sup>		X <sup>a</sup>	X	X <sup>a</sup>	
LNB	X			X	X	X				
FGR				X	X	X			X <sup>b</sup>	X <sup>b</sup>
NGR	X <sup>b</sup>									X <sup>b</sup>
SNCR	X <sup>b</sup>	X	X	X	X <sup>b</sup>		X	X	X	X
SCR	X <sup>b</sup>		X <sup>b</sup>	X <sup>b</sup>						

BT/OT = Burner tuning/oxygen trim

WI/SI = Water injection/steam injection

SCA = Staged combustion air, includes burners out of service (BOOS), biased firing, or overfire air (OFA)

LNB = Low-NO<sub>x</sub> burners

FGR = Flue gas recirculation

NGR = Natural gas reburning

SNCR = Selective noncatalytic reduction

SCR = Selective catalytic reduction

MSW = Municipal solid waste

<sup>a</sup>SCA is designed primarily for control of smoke and combustible fuel rather than NO<sub>x</sub>. Optimization of existing SCA (OFA) ports can lead to some NO<sub>x</sub> reduction.

<sup>b</sup>Limited experience.

TABLE 7-2. NO<sub>x</sub> EMISSIONS REDUCTION FROM MODEL BOILERS

Boiler type and size, MMBtu/hr	Baseline NO <sub>x</sub>			NO <sub>x</sub> control technique	Control NO <sub>x</sub> level, lb/MMBtu	NO <sub>x</sub> reduction			
	lb/MMBtu	Tons/yr (0.50 CF <sup>a</sup> )				%	Tons/yr (0.33 CF)	Tons/yr (0.50 CF)	Tons/yr (0.66 CF)
PC	400	0.70	610	BT/OT	0.62	15	46	70	93
				LNB	0.35	50	200	310	400
				NGR	0.28	60	240	370	490
				SNCR	0.39	45	180	270	360
				SCR	0.14	85	320	490	650
Stoker coal	250	0.53	290	SCA	0.42	20	40	60	79
				SNCR	0.29	45	86	130	170
FBC coal	400	0.32	280	SCA	0.19	40	75	110	150
				SNCR	0.13	75	110	170	220
FE-WT gas	300	0.26	150	BT/OT	0.20	15	13	20	26
				SCA	0.15	35	35	53	69
				LNB	0.12	55	60	92	120
				LNB+FGR	0.10	60	69	110	140
				SNCR	0.10	60	69	110	140
				SCR	0.04	85	95	140	190
FE-WT No. 2 oil	300	0.21	140	BT/OT	0.18	15	13	20	26
				SCA	0.13	40	35	53	69
				LNB	0.10	50	48	72	95
				LNB+FGR	0.08	60	56	85	110
				SNCR	0.10	50	48	72	95
				SCR	0.03	80	78	120	160
FE-WT No. 6 oil	300	0.38	250	BT/OT	0.32	15	26	34	52
				SCA	0.29	25	39	59	78
				LNB	0.19	50	82	120	160
				FGR	0.34	10	17	26	35
				LNB+FGR	0.15	60	100	150	200
				SCR	0.08	80	130	200	260
PK-WT gas	50	0.14	15	BT/OT	0.12	15	1.4	2.2	2.8
				WI/SI	0.06	55	5.8	8.8	12
				LNB	0.08	45	4.3	6.6	8.7
				LNB+FGR	0.06	57	5.8	8.8	12
				SNCR	0.07	50	5.1	7.7	10
				SCR	0.02	85	8.7	13	17
PK-WT No. 2 oil	50	0.13	14	BT/OT	0.11	15	1.4	2.2	2.8
				LNB	0.10	25	2.2	3.3	4.3
				FGR	0.07	45	4.3	6.6	8.6
PK-WT No. 6 oil	50	0.36	39	BT/OT	0.31	15	3.6	5.5	7.2
				LNB	0.19	45	12	19	25
				LNB+FGR	0.15	60	15	23	30
				SCR	0.06	85	22	33	43
FT gas	15	0.10	3.3	BT/OT	0.09	15	0.22	0.33	0.44
				WI/SI	0.04	65	1.3	2.0	2.6
				LNB	0.08	20	0.43	0.66	0.87
				FGR	0.07	30	0.65	1.0	1.3
				LNB+FGR	0.03	70	1.5	2.3	3
FT No. 2 oil	15	0.17	5.6	BT/OT	0.15	15	0.43	0.66	0.86
				LNB	0.09	50	1.7	2.6	3.5
				FGR	0.12	30	1.1	1.6	2.2
FT No. 6 oil	15	0.31	10	BT/OT	0.26	15	1.1	1.6	2.2
				LNB	0.17	45	3.0	4.6	6.1
Stoker nonfossil	150	0.24	79	SNCR	0.11	55	28	43	56
FBC nonfossil	200	0.25	110	SNCR	0.11	55	40	61	80
Mass MSW	500	0.40	440	NGR	0.16	60	170	260	350
				SNCR	0.18	55	160	240	320

<sup>a</sup>CF = capacity factor.

boilers, baseline emissions presented in Chapter 4, and NO<sub>x</sub> reduction potentials presented in Chapter 5. Thus, a 400 MMBtu/hr (73 MWt) circulating FBC boiler burning coal with a baseline level of 0.32 lb/MMBtu could successfully employ SNCR to reduce emission levels to approximately 0.10 lb/MMBtu, corresponding to 210 tons/yr NO<sub>x</sub> reduction at a capacity factor of 0.50.

### 7.1.2 CO Emissions

The CO emissions from ICI boilers are normally near zero, with the exception of a few boilers that have poor combustion air control or burner problems.<sup>1</sup> In an extensive study of industrial boilers' emissions, oil-fired units were found to have the lowest baseline CO emissions than either coal- or gas-fired units. This was attributed to higher excess air levels typically used to avoid visible smoke emissions when oil is burned.<sup>1</sup> CO emissions are generally caused by poor fuel-air mixing, flame quenching, and low residence time at elevated temperatures. Additionally, in some ICI furnace designs, CO emissions can also occur because of furnace gas leaks between furnace tubes.

The modification of combustion conditions aimed at reducing NO<sub>x</sub> formation can result in increases in emissions of CO and hydrocarbons. This is because controls that reduce peak flame temperature and delay the mixing of fuel and air for NO<sub>x</sub> reduction can cause some incomplete combustion of the fuel. However, the actual impact of NO<sub>x</sub> control retrofits often depends on the operating conditions of the ICI boiler and the extent of improvements made to the combustion control system. In some cases, combustion NO<sub>x</sub> control can also result in lower emissions of CO and other unburned fuel emissions.

Tables 7-3 through 7-5 list changes in emissions of CO measured following the retrofit of selected controls. These data can also be found in Appendix A of this document. As shown in Table 7-3, LNB, SCA and NGR controls achieved NO<sub>x</sub> reductions in the range of 10 to 67 percent, with lowest reductions reported for the spreader stoker. Emissions of CO increased in nearly all cases, except for the retrofit of NGR on the cyclone boiler and one minor application of OFA for 10 percent reduction in NO<sub>x</sub> in the spreader stoker. The implementation of staged air will typically result in increased CO emissions.

Data on the effect of NO<sub>x</sub> controls on CO emissions from natural gas-fired ICI boilers were limited to the retrofit of FGR, LNB and FGR+LNB controls. Bulk dilution of combustion mixtures with FGR is limited by flame instability and reduced flammability. Slightly higher

**TABLE 7-3. CO EMISSION CHANGES WITH NO<sub>x</sub> CONTROL RETROFIT —  
COAL-FIRED BOILERS**

Boiler type	NO <sub>x</sub> control	NO <sub>x</sub> reduction, %	CO emissions impact		Reference
			Baseline/low NO <sub>x</sub> , ppm	Average change, %	
WT	LNB	67	20-27/13-420	+800	2
	LNB+SCA	66	35/60-166	+215	3
Cyclone	NGR	65	30/30	0	4
Spreader stoker	SCA (OFA)	31	231-252/429	+80	5
		10	313/300	-4	6
		26	0/49	NA <sup>a</sup>	1
FBC	SCA	67	387-500/550-1,100	+86	7

<sup>a</sup>NA = Not applicable.

**TABLE 7-4. CO EMISSION CHANGES WITH NO<sub>x</sub> CONTROL RETROFIT — GAS-FIRED BOILERS**

Boiler type	NO <sub>x</sub> control	NO <sub>x</sub> reduction, %	CO emissions impact		Reference
			Baseline/ low NO <sub>x</sub> , ppm	Average change, %	
PKG-FT	FGR	59	16/13	-18	8
	FGR	73	205/77	-62	9
	FGR	71	205/192	-6.3	9
	FGR	64	205/103	-50	9
	FGR	74	205/84	-59	9
	FGR	67	23/3	-87	8
	FGR	73	105/7	-93	8
	FGR	76	205/67	-67	9
	FGR	69	205/49	-76	9
	FGR	73	51/12	-76	10
	LNB	82	9/9	0	11
	LNB	53	51/24	-53	12
	LNB	32	39/8	-80	13
	LNB	78	856/30	-97	11
	LNB	NA <sup>a</sup>	342/30	-91	11
	LNB	NA	205/0	-100	11
	LNB	NA	9/9	0	12
	PKG-WT	FGR	74	205/62	-70
FGR		62	20/20	0	14
FGR		78	10/55	+450	14
FGR		53	205/205	0	9
FGR		73	14/22	+57	10
FGR		56	132/77	-42	10
LNB+FGR		55	60-125/2	-98	15

<sup>a</sup>NA = Not applicable.

**TABLE 7-5. CO EMISSION CHANGES WITH NO<sub>x</sub> CONTROL RETROFIT — OIL-FIRED BOILERS**

Oil/boiler type	NO <sub>x</sub> control	NO <sub>x</sub> reduction, %	CO emissions impact		Reference
			Baseline/low NO <sub>x</sub> , ppm	Average change, %	
Distillate/WT	FGR	68	4/46	+1,000	16
	FGR	20	20/24	+20	14
Distillate/FT	LNB	15	6/13	+120	13
Residual/WT	FGR	4	20/20	0	14
	FGR	30	10/145	+1,400	14
	SCA (BOOS)	8	0/100	NA <sup>a</sup>	1
	SCA (BOOS)	40	0/20	NA	1

<sup>a</sup>NA = Not applicable.

excess air levels at high rates of FGR (typically 15 to 20 percent) coupled with improved burner settings often can result in decreased CO emissions in addition to lower NO<sub>x</sub>.

The data in Table 7-4 suggest that baseline CO emission levels from these units ranged from 9 to 856 ppm, and that the application of these controls, along with an increase in excess air, resulted in a reduction of CO in most cases. The average CO reduction for these retrofits was nearly 70 percent. One of the boilers with an initial low CO level, 10 ppm, showed an increase in CO to 55 ppm when FGR was implemented. In another application, the CO level in the low-NO<sub>x</sub> configuration increased to only 22 ppm. Excess air is an important operational parameter that determines the level of CO emissions following the retrofit of NO<sub>x</sub> controls. As suggested above, most of the reductions in CO levels from these gas-fired boilers resulted from increases in excess air. Low-NO<sub>x</sub> firing with LNB typically causes an increase in CO at equivalent excess air levels. Also, there is the possibility of CO emissions occurring due to gas leaks between tubes from furnace to convective section.

Figure 7-1 illustrates the dependence of CO emissions on excess air. The rapid increase in CO is indicative of reduced fuel and air mixing that often accompanies low-NO<sub>x</sub> combustion controls such as LNB and SCA. Each boiler type has its own characteristic "knee" in CO versus

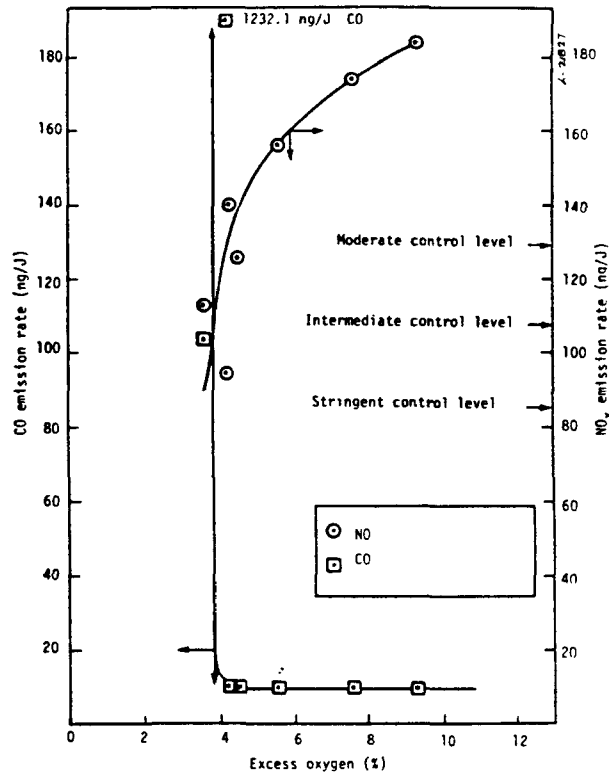

**Figure 7-1. Changes in CO and NO<sub>x</sub> emissions with reduced excess oxygen for a residual-oil-fired watertube industrial boiler.<sup>17</sup>**

excess oxygen, depending on several factors such as fuel type and burner maintenance. California's SCAQMD permits CO levels up to 400 ppm from ICI boilers when NO<sub>x</sub> emissions are reduced to strict levels.<sup>18</sup> Also, the ABMA recommends an equivalent permitted level for CO for ICI boilers retrofitted with combustion controls.<sup>19</sup>

As shown in Table 7-5, the limited data base on fuel oil-fired ICI boilers indicates that baseline CO emission levels for these selected boilers were below 20 ppm. When NO<sub>x</sub> controls such as LNB, FGR, and BOOS were applied, the CO emission levels increased in nearly all cases. The increase in CO, however, did not result in emission levels greater than 200 ppm, considered a safe limit for boiler operation.

### 7.1.3 Other Air Pollution Emissions

Other air pollution emissions that are a concern when NO<sub>x</sub> controls are applied to ICI boilers are: ammonia (NH<sub>3</sub>) and nitrous oxide (N<sub>2</sub>O), unburned hydrocarbon (HC), particulate matter (PM), and air toxic emissions. Ammonia and N<sub>2</sub>O emissions are associated with the use

of the SNCR process, primarily, and with SCR to a lesser extent. With either urea or ammonia hydroxide, unreacted ammonia emissions escape the SNCR temperature window resulting in direct emissions to the atmosphere. When sulfur-bearing fuels are burned, these emissions also pose an operational concern because of cold end corrosion and reduced heat transfer due to ammonium sulfate deposits.  $N_2O$  emissions are often a byproduct of the SNCR reaction, and, because of this, some  $N_2O$  emissions are likely with the process. In fact, the emissions have been reported with all reagents, particularly with urea reagents.<sup>20</sup> Some urea-based SNCR processes offer proprietary additives to minimize  $N_2O$  and  $NH_3$  emissions.

SNCR vendors have paid particular attention to minimizing the breakthrough of unreacted ammonia considering the potentially negative impacts on the operation of the boiler. This is typically accomplished by careful selection of the injection location, method of injection to maximize mixing and residence time, and by careful control of reagent use with boiler load and operating conditions. Table 7-6 lists  $NH_3$  slip levels reported for several retrofit installations. Boilers best suited for retrofit of SNCR are FBC, bubbling and circulating designs. Stokers and mass burning equipment have also been targets for application of SNCR because combustion modifications have traditionally been limited and ineffective. In spite of large  $NO_x$  reductions achieved in the units with the retrofit of SNCR, typically in the range of 50 to 70 percent,  $NH_3$  slip levels have been reported mostly in the range of less than 30 ppm, and often less than 20 ppm. Monitoring of  $NH_3$  emissions is often difficult because direct on line measurement methods are only now being introduced into the market place and are often very expensive, therefore not a part of the monitoring system at these facilities.

Pilot-scale and field tests have clearly shown that a portion of the  $NO_x$  reduced by the SNCR process is merely transformed into  $N_2O$  emissions. Figure 7-2 illustrates the amount of  $N_2O$  produced in relation to the amount of  $NO_x$  reduction with three types of SNCR chemicals: cyanuric acid, urea, and ammonia. These test results obtained in a pilot-scale facility, show that nearly 30 percent of the  $NO_x$  reduced can actually be transformed to  $N_2O$  with urea, less when using ammonia. Cyanuric acid is not a preferred chemical because of its obvious disadvantage in  $N_2O$  formation compared with the other two more popular SNCR chemicals. In addition, cyanuric acid is 6 to 8 times more expensive than urea.

Increases in HC, PM and air toxic emissions are primarily of concern with the application of combustion modification controls. Information on HC and air toxic emissions is sparse at best. However, the limited data suggest that HC emissions do not change when  $NO_x$



**TABLE 7-6. AMMONIA EMISSIONS WITH UREA-BASED  
SNCR RETROFIT<sup>a</sup>**

<b>Fuel/boiler type</b>	<b>NO<sub>x</sub> reduction, %</b>	<b>Ammonia emission level, ppm</b>	<b>Reference</b>
Coal/CFBC	57	<18	21
	70	<10	21
	30	<5	21
Wood/stoker	50	<40	21
	60	<27	21
	25	<21	21
	47	<10	21
	35	<21	21
	50	<40	21
	52	<30	21
	69	<25	21
MSW/mass	48	<10	21
	60	<10	21
	75	22	22
	70	17	21
	41	<5	21
	60	<7	21
	60	12	22
	60	<15	21
	50	<21	21
	58	22	22
	Paper/PKG-WT	50	<10
Fiber/PKG-WT	50	<10	21

<sup>a</sup>Test data are included in Appendix A.

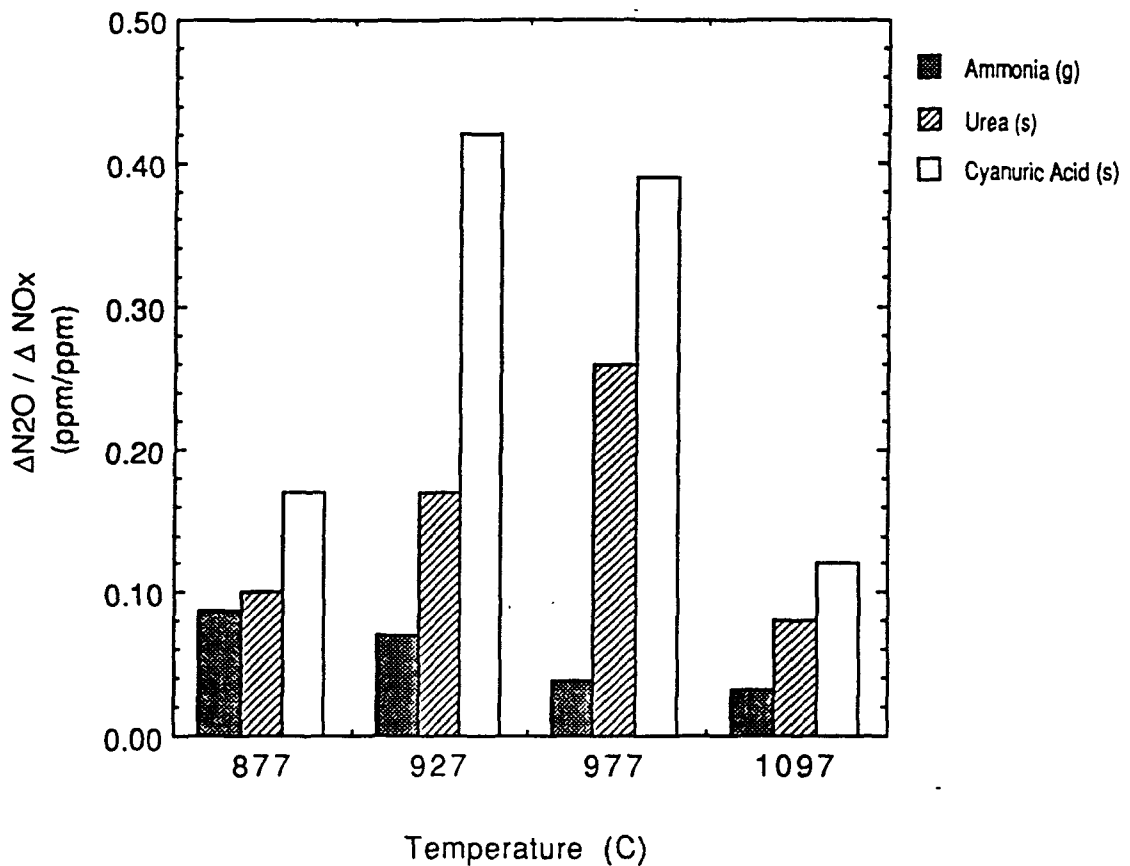

**Figure 7-2. Pilot-scale test results, conversion of NO<sub>x</sub> to N<sub>2</sub>O (NO<sub>i</sub> = 300 ppm, N/NO = 2.0).<sup>20</sup>**

controls are implemented. HC emissions are the result of poor combustion conditions such as inefficient fuel-air mixing, low temperatures, and short residence time. These emissions are most often preceded by large increases in CO, soot, and unburned carbon content. Thus, by limiting CO, smoke and unburned carbon in the flyash, HC emissions are also suppressed, and changes with retrofit of NO<sub>x</sub> controls become imperceptible.

A comprehensive test program in the mid-1970s reported on the effect of combustion modification controls for industrial boilers. The results of this program revealed the following trends with respect to filterable PM<sup>23</sup>:

- LEA reduced PM emissions on the order of 30 percent
- SCA, including BOOS, increased PM by 20 to 95 percent

- Burner adjustments and tuning had no effect on PM. However, the lower CO emission levels generally achieved with these adjustments would tend to lower PM as well.
- FGR resulted in an increase in PM from oil-fired packaged boilers by 15 percent over baseline levels

Information on the effects of LNB on PM is unavailable. However, newer burner designs have improved combustion air control and distribution. These features tend to compensate for the potential increase in PM from oil- and coal-burning equipment due to delayed mixing and lower peak temperatures that are needed to suppress NO<sub>x</sub> formation.

## 7.2 SOLID WASTE DISPOSAL

NO<sub>x</sub> reduction techniques that have a potential impact on the disposal of solid waste are combustion controls for PC-fired boilers and flue gas treatment systems for all applicable boilers. Combustion controls for PC-fired boilers are principally LNB and LNB+OFA. These controls can result in an increase in the carbon content of flyash that can preclude its use in cement manufacturing. Although primarily a practice of coal-fired power plants, the use of flyash for cement manufacturing reduces the ash disposal requirements. The impact of increased carbon content in the flyash from ICI boilers can result in an ash disposal requirement where one did not exist before. The environmental and economic impact of this requirement cannot be easily quantified.

An increase in flyash disposal can also occur with the use of flue gas treatment NO<sub>x</sub> controls such as SNCR and SCR on coal-fired boilers. Both of these control options use ammonia-based reagents to reduce NO to N<sub>2</sub> and water. Excessive use of reagent can result in ammonia slip emissions, as discussed in Section 7.1.3. This excessive ammonia condenses on the flyash and, when present in quantities exceeding the odor threshold, would preclude its use as a cement additive. The likelihood or extent of this potential problem is not known because there is little experience in this country with the use of either SNCR or SCR for coal-fired boilers, especially PC-fired industrial boilers.

Finally, one potential solid waste impact is the result of catalyst replacement when the SCR process is used. With continuous use, the catalyst material will become less active. That is, the efficiency of the catalyst in reducing NO<sub>x</sub> will gradually deteriorate. When this happens, the catalyst material must be replaced. This is often accomplished by replacing layers of individual modules starting with the most exposed layer (at the inlet), until all the catalyst

material is finally replaced. Performance guarantees for SCR catalysts are often set at 3 years, or 24,000 hours, for natural-gas-fired applications, and 2 years, or 16,000 hours, for oil and coal applications. However, some catalysts have shown longer life, 8 to 10 years, when applied on clean-burning fuel.<sup>24</sup>

The disposal of spent catalyst can present a potential environmental impact because some of the catalyst formulations are potentially toxic and subject to hazardous waste disposal regulations under RCRA and its amendments. For example, vanadia and titania catalysts are considered hazardous material. However, recent industry trends have shown that these material are readily regenerable. In fact, many catalyst vendors recycle this material thus avoiding any disposal problem for the user. Some of the catalysts, especially those that use rare earth material such as zeolites, are not hazardous and their disposal does not present an adverse environmental impact.

### **7.3 WATER USAGE AND WASTEWATER DISPOSAL**

The only increase in water use is associated with the use of WI or SI and potentially with the use of flue gas treatment NO<sub>x</sub> controls, especially SNCR. The use associated with WI or SI injection is an obvious one. The amount of water used does often not exceed 50 percent of the total fuel input on a weight basis. This is because excessive use of flame quenching with water can result in high emissions of CO and high thermal efficiency loss. Therefore, a 50 MMBtu/hr (15 MWt) boiler would use approximately 600,000 gal (2.2 million L) of water per year when operating with a 50 percent capacity factor.

An increase in water use and wastewater disposal requirement could result from the use of SNCR techniques, either urea or ammonia based. This is because ammonia slip when combined with SO<sub>3</sub> in the flue gas will form corrosive salts that deposit on heat transfer surfaces such as air heaters. These deposits must be removed to minimize pressure drop and material corrosion. Air heater acid washing could become more frequent. This practice would result in greater generation of wastewater requiring treatment and disposal. However, urea-based SNCR can actually use wastewater as reagent dilution water prior to injection, thus minimizing the amount of wastewater generated. Increased air heater washing has not been reported in the more than 80 combustion sources equipped with SNCR in the United States.

### **7.4 ENERGY CONSUMPTION**

This section discusses the energy consumption associated with NO<sub>x</sub> control techniques for ICI boilers. Energy consumption can come in various forms: a boiler fuel consumption

penalty caused by reduced thermal or combustion efficiency; an increase in electrical power to operate fans and pumps; an increase in fuel consumption due to reheat of flue gas; an increase in energy for treatment and disposal of solid or liquid wastes generated by the control technology. Some controls offer the potential for a reduction in energy consumption. Trimming the excess oxygen necessary to assure complete combustion is the most noted of these energy savings techniques. Others include the installation of economizers and air preheaters to recover waste heat in some older and smaller boilers. However, contrary to oxygen trim, these other techniques do not offer a potential for NO<sub>x</sub> reduction as well.

#### **7.4.1 Oxygen Trim (OT)**

ICI boilers are operated at various excess air levels, ranging from about 10 to over 100 percent of the theoretical amount of air needed to complete combustion. Some amount of excess air is required regardless of fuel burned and method of burning because fuel and air do not perfectly mix and the residence time in the combustion chamber is not infinite. This additional air provides a safe method to increase flame turbulence and assure near complete combustion of fuel. The type of fuel burned and the method of burning determines the minimum amount of excess air required for safe and near complete combustion. For example, the following minimum excess O<sub>2</sub> levels are considered typical for these fuels<sup>25</sup>:

- Natural gas, 0.5 to 3.0 percent
- Oil fuels, 2.0 to 4.0 percent
- Pulverized coal, 3.0 to 6.0 percent
- Coal stoker, 4.0 to 8.0 percent

Generally, excessive combustion air are found in poorly maintained, unattended boilers. This added air provides some measure of safety for burning all the fuel, especially when the operation of boilers is poorly supervised. In many such instances, burner tuning and combustion control adjustments and equipment improvements can be readily made that reduce the amount of excess air resulting in a thermal efficiency improvement and reduced NO<sub>x</sub> emissions without compromising the safety of the operation of the unit. Qualified boiler and burner engineers and consultants can upgrade key components of the combustion air control system, including the installation of monitors for O<sub>2</sub> and CO levels in the stack.

Figure 7-3 illustrates the efficiency improvement that can be obtained by reducing excess combustion air in ICI boilers. For example, a 10-percent reduction in excess air (say, from O<sub>2</sub> of 3.5 to 2.0 percent) would result in an efficiency improvement of approximately 0.6 percent

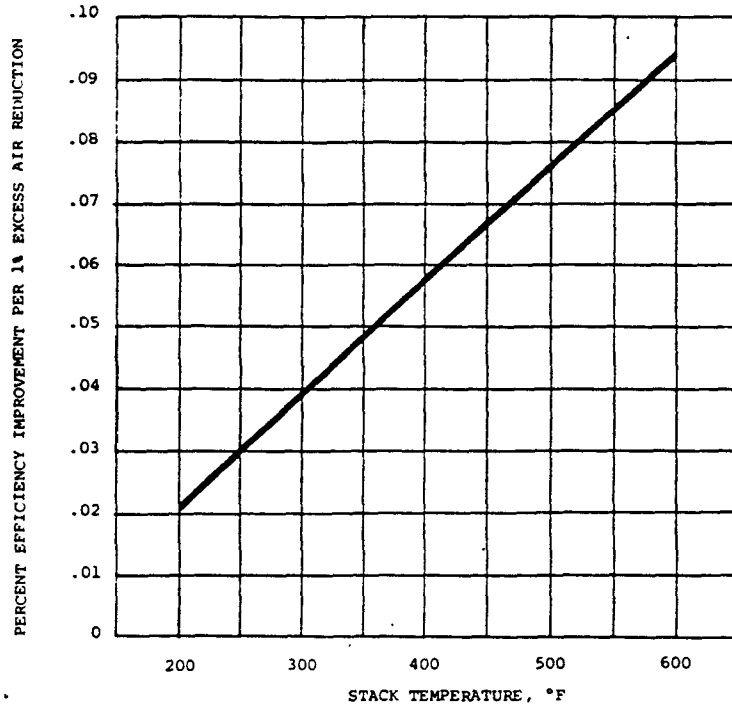

**Figure 7-3. Curve showing percent efficiency improvement per every 1 percent reduction in excess air. Valid for estimating efficiency improvements on typical natural gas, No. 2 through No. 6 oils, and coal fuels.<sup>25</sup>**

when the stack temperature is at 200°C (400°F). For a natural-gas-fired boiler with a capacity of 150 MMBtu/hr and a capacity factor of 0.5, this improvement will result in fuel savings of about 3.7 million ft<sup>3</sup> of natural gas per year or about \$13,600/yr savings. Algebraically, the relationship between boiler efficiency and excess air can be expressed as follows<sup>26</sup>:

$$\Delta E = \frac{(T - 70)}{63.1} \times \frac{\%EA}{89.5} \quad (7-1)$$

Where:

T = stack temperature in °F

% EA = the change in percent excess air

The reduction in excess air, however, can result in some increase in unburned fuel primarily in the form of CO emissions, when gas or fuel oil is burned, and in unburned carbon in the flyash, when coal is burned. Increased emissions of CO have a detrimental effect on the

efficiency, as illustrated in Figure 7-4. For example, the example boiler describe above operating at 2.0 percent oxygen might have an increase in CO to about 350 ppm, measured on a dry basis in the flue gas. This amount of CO would reduce the efficiency gain of 0.6 percent described above by about 0.1 percent. Besides this efficiency loss, the air quality impact of increased CO must be considered. The objective of boiler/burner tuning, however, is to reduce excess air without increasing CO emissions or unburned carbon, as discussed in Chapter 5. Algebraically, the relationship between boiler efficiency and CO can be expressed as follows<sup>26</sup>:

$$\Delta E = \frac{CO}{3,682} \times \left[ 1 + \frac{\%EA}{89.5} \right] \quad (7-2)$$

Where:

T = stack temperature in °F

% EA = the change in percent excess air

#### 7.4.2 Water Injection/Steam Injection (WI/SI)

The injection of water or steam in the burner zone to reduce peak flame temperature and NO<sub>x</sub> will have a detrimental impact on the efficiency of the boiler. Figure 7-5 illustrates the relationship between the amount of water or steam injected and the reduction in the thermal efficiency of the boiler. The data were developed using standard American Society of Mechanical Engineers (ASME) boiler efficiency calculation procedures.<sup>27</sup> The amount of water injected is typically in the range of 20 to 50 percent of the fuel input on a weight basis. Higher injection levels can cause large increases in CO and HC emissions. The corresponding loss in thermal efficiency when using water is in the range of about 1 to 2.5 percent. The efficiency loss when using an equivalent amount of steam is lower. However, the NO<sub>x</sub> reduction efficiency is also lower.

#### 7.4.3 Staged Combustion Air (SCA)

The operation of an ICI boiler with staged combustion air, whether BOOS or OFA, will likely not require additional energy. Taking selected burners out of service will not influence the air distribution. Also any increase in fan power associated with the operation of OFA ports will likely be compensated, for the most part, with reduction of air flow at the original burners.

#### 7.4.4 Low-NO<sub>x</sub> Burners (LNBS)

Minor or no increases in energy consumption are anticipated with the retrofit of LNB technology. This is because newer LNB designs operate at lower excess air levels, thus requiring lower fan power. Some increases in windbox pressures are likely with some retrofits because of

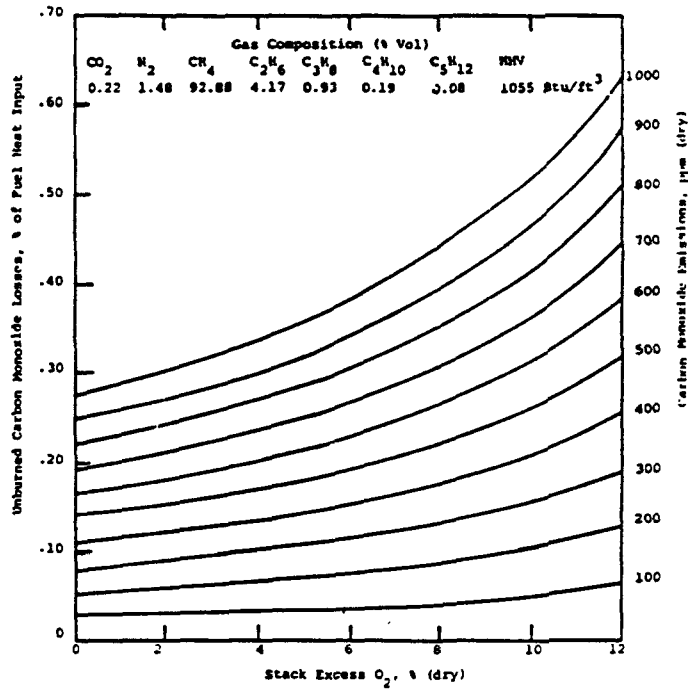

Figure 7-4. Unburned carbon monoxide loss as a function of excess O<sub>2</sub> and carbon monoxide emissions for natural gas fuel.<sup>28</sup>

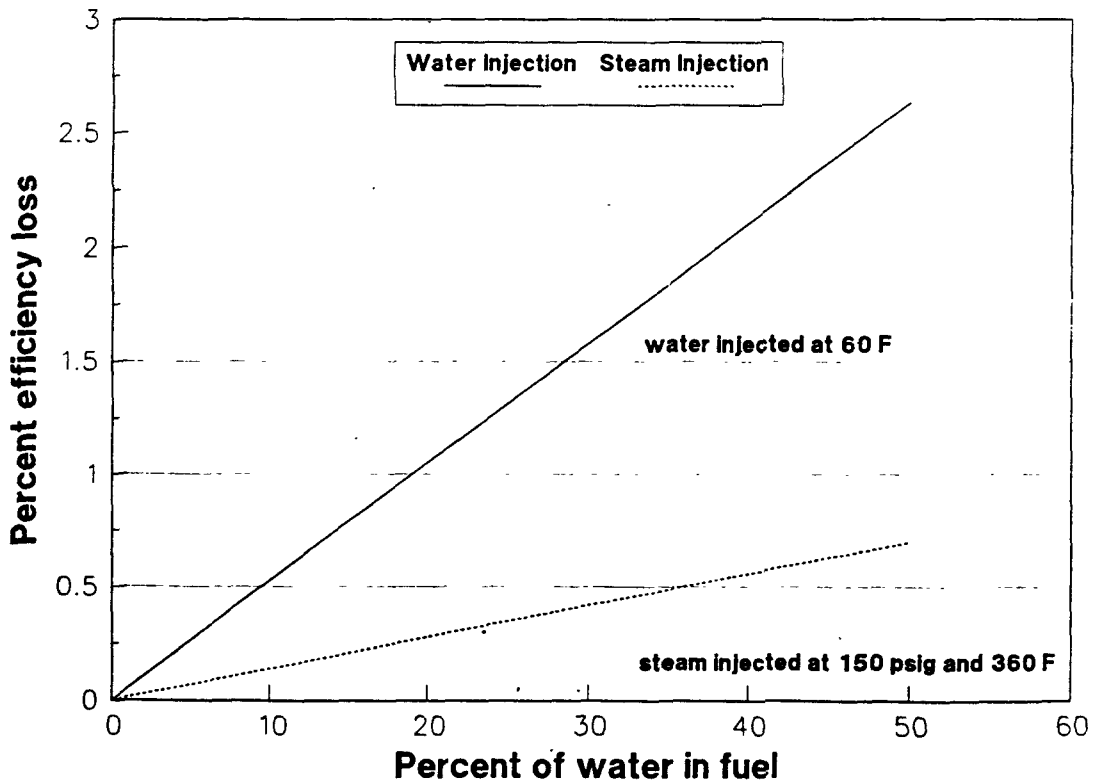

Figure 7-5. Energy penalty associated with the use of WI or SI for NO<sub>x</sub> control in ICI boilers.



higher gas velocities and more register control. This increase in pressure drop will tend to increase fan power somewhat, or compensate for the reduction in energy consumption at lower combustion air levels.

#### 7.4.5 Flue Gas Recirculation (FGR)

The retrofit of FGR requires the installation of a fan to recirculate a portion of the hot flue gas back to the burner(s). The operation of the fan will result in an increase in energy consumption. Figure 7-6 illustrates the calculated power requirements with the use of FGR. The relationship between power consumption and FGR rate is based on the following equation:

$$\frac{kWh}{yr} = (0.5) (8,760 \text{ hr/yr}) (0.0013558 \text{ kW/ft-lb}) (FGR \text{ ft}^3/\text{s}) (\Delta P \text{ lb/ft}^2) \quad (7-3)$$

Where:

0.5 = The capacity factor

$\Delta P$  = Assumed to be 10 inches of water to account for efficiency loss

Some additional energy penalty will also be incurred with an increase in pressure drop in the windbox. However, any additional penalty is minor compare to the energy consumption for the FGR fan.

#### 7.4.6 Selective Noncatalytic Reduction (SNCR)

Energy consumption in the SNCR process is related to pretreatment and injection of ammonia-based reagents and their carrier gas or liquids. Liquid ammonia or urea are injected in liquid form at high pressures to ensure efficient droplet atomization and dispersion. In some Thermal DeNO<sub>x</sub> installations, anhydrous ammonia is stored in liquid form under pressure. The liquid ammonia must be vaporized with some heat, mixed with carrier gas (air or steam) and then injected for adequate mixing. The amount of electricity used depends on whether the process uses air or steam for carrier gas. If steam is used, less electricity is needed but power consumption must take into consideration the amount of steam used.

Data supplied by Exxon suggest that the amount of electricity needed for the Thermal DeNO<sub>x</sub> Process is on the order of 1.0 to 1.5 kW for each MWt of boiler capacity (or 0.29 to 0.44 kW/MMBtu/hr) when using compressed air as the carrier medium.<sup>29</sup> The actual amount of electricity will depend on the baseline NO<sub>x</sub> emission level, the NH<sub>3</sub>/NO ratio used, and the NO<sub>x</sub> reduction target. Therefore, a 250 MMBtu/hr (73 MWt) boiler operating with a capacity factor of 0.5 will use approximately:

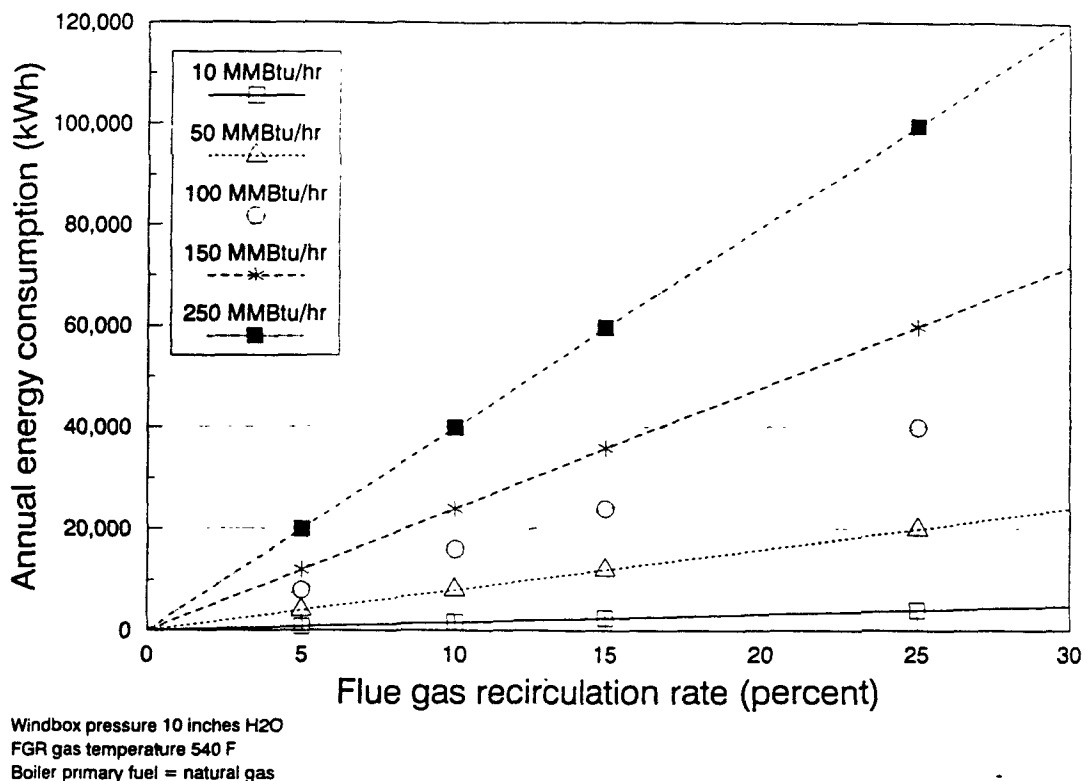

Figure 7-6. Estimated energy consumption in FGR use.

$$0.29 \text{ kW/MMBtu/hr} \times 250 \text{ MMBtu/hr} \times 0.5 \times 8,760 \text{ hr/yr} = 319,740 \text{ kWh} \quad (7-4)$$

which corresponds to about \$16,000/yr electricity cost. For steam-assisted ammonia injection, electricity use reduces to about 0.2 to 0.3 kW/MWt or 0.05 to 0.08 kW/MMBtu/hr boiler capacity. The amount of steam used is on the order of 25 to 75 lb/hr/MWt. In general, ammonia is most economically injected using compressed air rather than steam. Data supplied by Nalco Fuel Tech suggest that the urea-based SNCR process uses much lower levels of electricity than either ammonia-based SNCR or SCR. Typical auxiliary power requirements for an ICI boiler using urea-based SNCR ranges from 20 to 60 kW.<sup>30</sup>

#### 7.4.7 Selective Catalytic Reduction (SCR)

Energy consumption for the use of SCR systems consists of three principal areas: (1) the energy needed to store, pretreat and inject the chemical reagent ammonia or ammonia hydroxide; (2) the increased fan power to overcome the added pressure drop of the catalyst reactor in the flue gas; and (3) the thermal efficiency loss associated with maintaining the

catalyst reactor temperature within the specifications for optimum performance at variable boiler load. The energy to store, pretreat, and inject the reagent is equivalent to that of an SNCR system. Estimates of increased pressure drop across the catalyst vary with the various catalyst vendors and applications, primarily fuel. Typically, the pressure drop across a catalyst is on the order of 3 to 6 inches of water. Figure 7-7 illustrates the energy consumption associated with the additional pressure drop. The relationship between energy consumption and pressure drop across the catalyst is based on the following equation:

$$\frac{kWh}{yr} = (\Delta P \text{ in } H_2O) \left( 0.0361 \frac{lb}{in^2} \text{ in } H_2O \right) \left( 144 \frac{in^2}{ft^2} \right) \left( Q \frac{ft^3}{s} \right) \frac{0.5}{0.85} \times 8.760 \quad (7-5)$$

Where:

$\Delta P$  = Pressure drop across catalyst, in inches of water

$Q$  = Flue gas flowrate in actual  $ft^3/s$

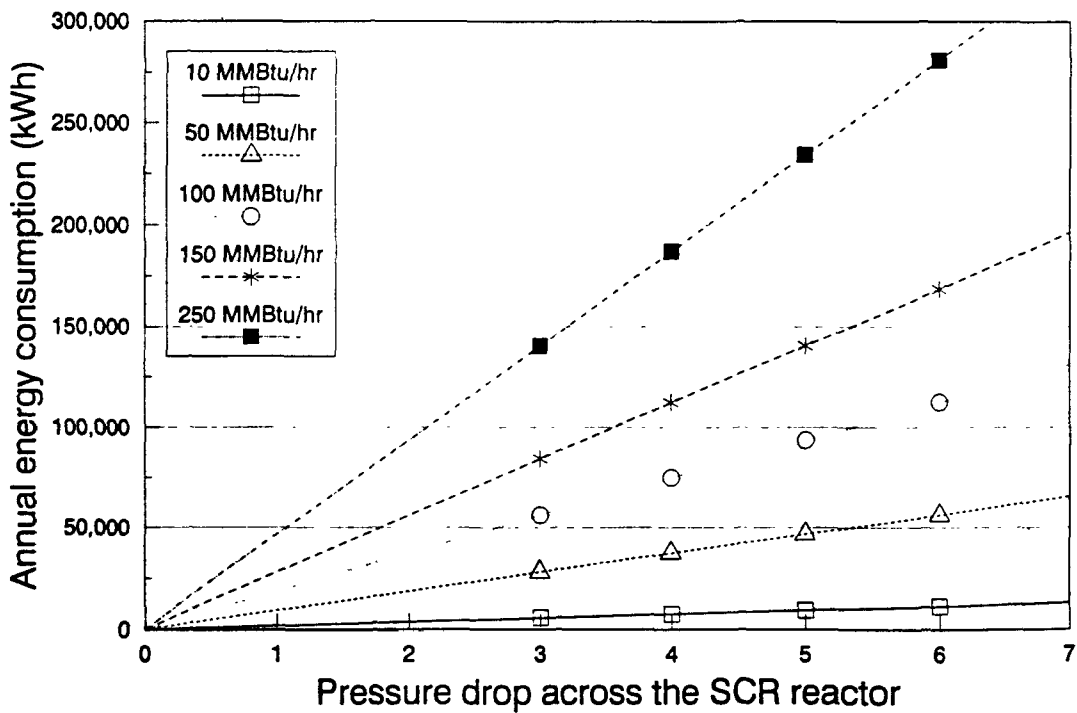

Flue gas temperature = 540 F  
 Fan efficiency 85 percent  
 Primary fuel = natural gas

Figure 7-7. Estimated increase in energy consumption with SCR pressure drop.

Finally, the third potentially large source of energy consumption is the result of increased flue gas temperature at the stack at low boiler loads. This increase in stack temperature is associated with the bypass of heat exchange areas or increased fuel consumption to maintain the catalyst at optimum reaction temperature. Figure 7-8 illustrates the loss in boiler thermal efficiency as stack temperature increases. For example, at 20 percent excess air level the thermal efficiency loss is approximately 1.2 percent for an increase in flue gas temperature of 50°F. From an efficiency effect standpoint, each 10°F increase in stack temperature is equivalent to a 583-ppm increase in CO emissions. Whether a facility will incur in this energy penalty will depend on the retrofit configuration, the boiler's load cycle, and the operating temperature window of the catalyst.

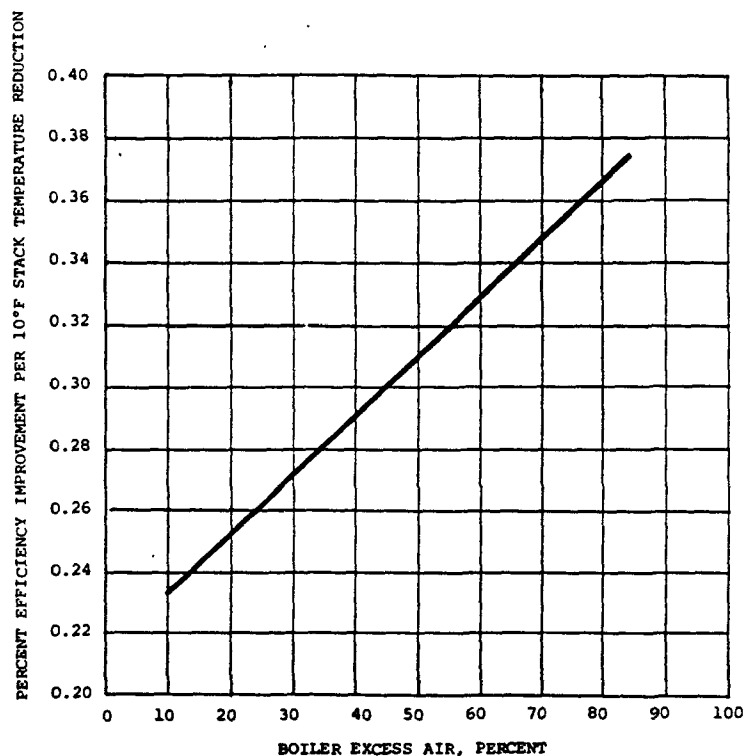

**Figure 7-8. Curve showing percent efficiency improvement per every 10°F drop in stack temperature. Valid for estimating efficiency improvements on typical natural gas, No. 2 through No. 6 oils, and coal fuels.<sup>25</sup>**

## 7.5 REFERENCES FOR CHAPTER 7

1. Cato, G. A., et al. (KVB, Inc). Field Testing: Application of Combustion Modifications to Control Pollutant Emissions from Industrial Boilers—Phase II. Publication No. EPA-600/2-72-086a. Prepared for the U.S. Environmental Protection Agency. Research Triangle Park, NC. April 1976.
2. Schild, V., et al. (Black Hills Power and Light Co.). Western Coal-Fired Boiler Retrofit for Emissions Control and Efficiency Improvement. Technical Paper No. 91-JPGCF-FACT-7. American Society of Mechanical Engineers. New York, NY. 1991.
3. Folsom, B., et al. (Energy and Environmental Research Corporation). Field Evaluation of the Distributed Mixing Burner. Proceedings: 1985 Symposium on Stationary Combustion  $\text{NO}_x$  Control. Publication No. EPRI CS-4360. U.S. Environmental Protection Agency/Electric Power Research Institute. Palo Alto, CA. 1989.
4. Farzan, H., et al. (Hitachi Zosen Corporation). Three Stage Pulverized Coal Combustion System for In-Furnace  $\text{NO}_x$  Reduction. Proceedings: 1985 Symposium on Stationary Combustion  $\text{NO}_x$  Control. Publication No. EPRI CS-5361. U.S. Environmental Protection Agency/Electric Power Research Institute. Palo Alto, CA. January 1986.
5. Langsjoen, J. E., et al. (KVB, Inc.). Field Testing of Industrial Stoker Coal-Fired Boilers for Emissions Control and Efficiency Improvement—Site F. Publication No. EPA-600/7-80-065a. Prepared for the U.S. Environmental Protection Agency, U.S. Department of Energy, and the American Boiler Manufacturers Association. Washington, D.C. November 1979.
6. Goldberg, P. M., and E. H. Higginbotham. Field Testing of an Industrial Stoker Coal-Fired Boiler—Effects of Combustion Modification  $\text{NO}_x$  Control on Emissions—Site A. Report No. TR-79-25/EE. Acurex Corporation. Mountain View, CA. August 1979.
7. Bijvoet, U. H. C., et al. (TNO Organization for Applied Scientific Research). The Characterization of Coal and Staged Combustion in the TNO 4-MWth AFBB Research Facility. Proceedings of the 1989 International Conference on Fluidized Bed Combustion. The American Society of Mechanical Engineers/Electric Power Research Institute/ Tennessee Valley Authority. New York, NY. 1989.
8. Dean, H. G. (Hugh Dean and Company, Inc.). Flue Gas Recirculation. Presented to South Coast Air Quality Management District. March 23, 1989. pp. 15-16.
9. Letter from Coffey, A., Cleaver Brooks, to Herbert, E. L. & Conway, Inc. Cleaver Brooks FGR Experience. September 14, 1992.
10. Letter and attachments from Stoll, F. R., Hugh Dean & Co., Inc., to Briggs, A., Acurex Environmental Corporation. Cleaver-Brooks FGR. April 5, 1993.
11. Kesselring, J. P., and W. V. Krill (Alzeta Corporation). A Low- $\text{NO}_x$  Burner for Gas-Fired Firetube Boilers. Proceedings: 1985 Symposium on Stationary Combustion  $\text{NO}_x$

- Control. Publication No. EPRI CS-4360. U.S. Environmental Protection Agency/Electric Power Research Institute. Palo Alto, CA. January 1986.
12. Field Tests Update: Ceramic Filter Burner for Firetube Boilers. Gas Research Institute. Chicago, IL. August 1987.
  13. Potts, N. L., and M. J. Savoie (U.S. Army Construction Engineering Research Laboratory). Low NO<sub>x</sub> Burner Retrofits: Case Studies. Technical Paper No. 91-10.22. Air and Waste Management Association. Pittsburgh, PA. June 1991.
  14. Office of Air Quality Planning and Standards. Overview of the Regulatory Baseline, Technical Basis, and Alternative Control Levels for Nitrogen Oxides (NO<sub>x</sub>) Emissions Standards for Small Steam Generating Units. Publication No. EPA-450/3-89-13. U.S. Environmental Protection Agency. Research Triangle Park, NC. May 1989.
  15. Roman, V. (KVB, Inc.). Compliance Test Report: Oxides of Nitrogen and Carbon Monoxide Emissions from Primary Boiler — Source Location: Miller Brewing Company, Irwingdale, CA. Submitted to the South Coast Air Quality Management District, El Monte, CA. August 13, 1990.
  16. Hunter, S. C., et al. Application of Combustion Modifications to industrial combustion equipment. KVB, Inc., Irvine, CA. 1977.
  17. Heap, M. P., et al. Reduction of Nitrogen Oxide Emissions from Package Boilers. Publication No. EPA-600/2-77-025, NTIS-PB 269 277. January 1977.
  18. Technical Review Group, State of California. A Suggested Control Measure for the Control of Emissions of Oxides of Nitrogen from Industrial Institutional & Commercial Boilers, Steam Generators & Process Heaters. April 29, 1987. p. 18.
  19. American Boiler Manufacturers Association (ABMA). Guidelines on Carbon Monoxide Emissions for Oil- and Gas-Fired Industrial Boilers. 1991. p. 4.
  20. Muzio, L. J., et al. (Fossil Energy Research Corporation). N<sub>2</sub>O Formation in Selective Non-Catalytic NO<sub>x</sub> Reduction Processes. Proceedings: 1991 Joint Symposium on Stationary Combustion NO<sub>x</sub> Control — EPA/EPRI. March 1992.
  21. Letter and attachments from Pickens, R. D., Nalco Fuel Tech, to Castaldini, C., Acurex Environmental Corporation. NO<sub>x</sub>OUT Urea-Based SNCR Performance. June 9, 1992.
  22. Hofmann, J. E., et al. (Nalco Fuel Tech). NO<sub>x</sub> Control for Municipal Solid Waste Combustors. Technical Paper No. 90-25-2. Air and Waste Management Association. Pittsburgh, PA. June 1990.
  23. Cato, G. A., et al. (KVB Engineering Inc.). Field Testing: Application of Combustion Modifications to Control Pollutant Emissions From Industrial Boilers — Phase II. Publication No. EPA-600/2-76-086a. April 1976. p. 192.

24. Smith J. C., Response to U.S. Questionnaire on SCR, NSCR, and CO/HC Catalysts. Institute of Clean Air Companies. Washington, D.C. May 14, 1992. p. 2.
25. McElroy, M. W. and D. E. Shore. Guidelines for Industrial Boiler Performance Improvement. Publication No. EPA-600/8-77-003a. January 1977. p. 44.
26. Coen Company. Sales Meeting Proceedings of 1991.
27. Performance Test Codes (ASME). Boiler Efficiency. PTC 4.1a. 1964.
28. Payne, W. F. Efficient Boiler Operations Sourcebook. Fairmont Press, Atlanta, GA. May 1985. p. 61.
29. Letter and attachments from Haas, G. A., Exxon Research and Engineering Company, to Jordan, B., U.S. EPA, Office of Air Quality Planning and Standards, Durham, NC. NO<sub>x</sub> Control Technologies Questionnaire. February 18, 1993.
30. Letter and attachments from Pickens, R. D., Nalco Fuel Tech, to Neuffer, W. J., U.S. EPA, Office of Air Quality Planning and Standards, Durham, NC. Comments on Draft Alternative Control Techniques Document. October 27, 1993. p. 5.

## APPENDIX A. ICI BOILER BASELINE EMISSION DATA

This appendix lists baseline NO<sub>x</sub>, CO, and unburned THC data for more than 200 ICI boilers. The data were obtained primarily from published technical papers and EPA documents summarizing data from numerous test programs. Boiler data are listed by fuel type, with the exception of FBC boilers which are listed separately. More detailed data may be obtained by referring directly to the individual references.



UNCONTROLLED EMISSIONS DATA  
COAL-FIRED ICI BOILERS

BOILER ID	BOILER TYPE	FIRING METHOD	RATED INPUT CAPACITY (MMBtu/hr)	OPERATING INPUT LOAD (MMBtu/hr)	EMISSIONS				UHC (lb/MMBtu)	REFERENCE	
					NOx (ppm@3XO2)	NOx (lb/MMBtu)	CO (ppm@3XO2)	CO (lb/MMBtu)			
200	WT	PC WALL	111	99	540	0.865	40	0.033	29.8	0.014	1
FREMONT 6	WT	PC WALL	160	108	591	0.799	11	0.009	40.4	0.019	2
FREMONT 6	WT	PC WALL	160	112	438	0.592	10	0.008			2
FREMONT 6	WT	PC WALL	160	113	341	0.461	61	0.050			2
FREMONT 6	WT	PC WALL	160	140	488	0.659	14	0.012			2
FREMONT 6	WT	PC WALL	160	115	390	0.527	12	0.010			2
FREMONT 6	WT	PC WALL	160	134	659	0.891	20	0.016			2
224	WT	PC WALL	194	126			0	0.000	4.3	0.002	1
225	WT	PC WALL	194	126			0	0.000	2.1	0.001	1
ALMA 3	WT	PC WALL	230	200	597	0.807	17	0.014	28.0	0.013	2
223	WT	PC WALL	260	158			0	0.000	2.1	0.001	1
9	WT	PC WALL	624	499	601	0.812	0	0.000	6.4	0.003	1
15	WT	PC WALL	371	499			0	0.000			1
343	WT	PC TANG	117	110	482	0.651	170	0.140	10.6	0.005	3
321	WT	PC TANG	184	145	427	0.577	0	0.000	12.8	0.006	3
6	WT	PC TANG	281	225	392	0.530	70	0.058	19.1	0.009	1
341	WT	PC TANG	303	243			0	0.000	8.5	0.004	1
13	WT	PC TANG	401	325	501	0.677	0	0.000	10.6	0.005	1
10	WT	CYCLONE	640	512	830	1.121	0	0.000			1
344	S	S	20	20					31.9	0.015	3
345	S	S	20	20					8.5	0.004	3
320	S	S	24	24					31.9	0.015	3
24	S	S	444	311	306	0.414	435	0.358			1
20	WT	SS	14	9			164	0.135			1
325	WT	SS	30	21	446	0.602	36	0.030	27.7	0.013	3
4	WT	SS	63	50	482	0.651	41	0.036	14.9	0.007	3
FAIRMONT	WT	SS	80	57	317	0.428	56	0.046			2
FAIRMONT	WT	SS	80	59	312	0.422	56	0.046			2
FAIRMONT	WT	SS	80	60	260	0.351	77	0.063			2
FAIRMONT	WT	SS	80	61	311	0.420	57	0.047			2
5	WT	SS	89	75	482	0.651	130	0.107	14.9	0.007	1
SITE F	WT	SS	98	74	346	0.488	146	0.12			4
SITE F	WT	SS	98	74	336	0.454	139	0.114			4
SITE G	WT	SS	99	98	400	0.54					4
SITE G	WT	SS	99	98	423	0.572					4
SITE G	WT	SS	100	443							4
MADISON	WT	SS	100	438							4
MADISON	WT	SS	100	90							4
226	WT	SS	154	62	177	0.146	177	0.146	38.3	0.018	4
WILMAR	WT	SS	160	124	455	0.374	455	0.374			4
WILMAR	WT	SS	160	125	0	0.000	0	0.000	0.0	0.000	2
WILMAR	WT	SS	160	125	289	0.561	289	0.238			2
WILMAR	WT	SS	160	126	395	0.534	509	0.419			2
WILMAR	WT	SS	160	128	366	0.495	642	0.528			2
WILMAR	WT	SS	160	128	315	0.426	2200	1.811			2
WILMAR	WT	SS	166	135	384	0.519	36	0.030	29.8	0.014	1
3	WT	SS	181	145			173	0.142	8.5	0.004	1
340	WT	SS	186	170			0	0.000	10.6	0.005	1
221	WT	SS	232	142	477	0.645	81	0.067			5
SITE E	WT	SS	254	168	337	0.456	0	0.000			5
14	WT	SS	395	277	566	0.765	0	0.000			1
8	WT	SS									1

\*\*\* CONTINUED \*\*\*

UNCONTROLLED EMISSIONS DATA  
COAL-FIRED ICI BOILERS

BOILER ID	BOILER TYPE	FIRING METHOD	RATED INPUT CAPACITY (MMBtu/hr)	OPERATING INPUT LOAD (MMBtu/hr)	EMISSIONS					REFERENCE
					NOx (ppm@3%O <sub>2</sub> ) (lb/MMBtu)	CO (ppm@3%O <sub>2</sub> ) (lb/MMBtu)	CO (lb/MMBtu)	UHC (ppm@3%O <sub>2</sub> ) (lb/MMBtu)	UHC (lb/MMBtu)	
342	WT	OFS	18	18	325	1	0.001	46.8	0.022	3
STOUT 2	WT	OFS	45	33	160	0.216	0.077			2
STOUT 2	WT	OFS	45	36	176	0.238	1.646			2
STOUT 2	WT	OFS	45	30	156	0.211	1.646			2
STOUT 2	WT	OFS	45	30	158	0.214	1.646			2
STOUT 2	WT	OFS	45	30	143	0.193	1.646			2
STOUT 2	WT	OFS	45	40	221	0.299				2
STOUT 2	WT	OFS	45	44	185	0.250	0.922			2
STOUT 2	WT	OFS	45	30	187	0.253	0.019		0.024	2
STOUT 2	WT	OFS	60	60	308	0.416	0.197			6
SITE H	WT	OFS	63	64	240	0.324	0.114			4
SITE K	WT	OFS	70	43	233	0.315	0.110			4
EAU CLAIRE	WT	OFS	70	45	255	0.345	0.034			2
EAU CLAIRE	WT	OFS	70	49	211	0.285	0.084			2
EAU CLAIRE	WT	OFS	77	77	261	0.353				4
SITE J	WT	OFS	95	97	169	0.229				4
SITE I	WT	OFS	95	99	296	0.4				4
SITE I	WT	OFS	102	81	158	0.214	0.030			1
25										
220	FT	UFS	3	1				21.3	0.010	3
12	FT	UFS	12	10	358	0.484	0.935			1
11	FT	UFS	12	10	282	0.381	0.281			1
1	WT	UFS	75	60	275	0.372	0.000			1
2	WT	UFS	78	60	232	0.314	0.000			1

WT: WATERTUBE  
FT: FIRETUBE  
PC: PULVERIZED COAL  
WALL: WALL FIRED  
TANG: TANGENTIAL FIRED

OFS: OVERFEED STOKER  
SS: SPREADER STOKER  
UFS: UNDERFEED STOKER  
S: STOKER

UNCONTROLLED EMISSIONS DATA  
RESIDUAL OIL-FIRED ICI BOILERS

BOILER ID	BOILER TYPE	BOILER CAPACITY (MMBtu/hr)	OPERATING LOAD (MMBtu/hr)	EMISSIONS					REFERENCE
				NOx (lb/MMBtu) (ppm <sup>3</sup> /O <sub>2</sub> )	CO (lb/MMBtu) (ppm <sup>3</sup> /O <sub>2</sub> )	UHC (lb/MMBtu) (ppm <sup>3</sup> /O <sub>2</sub> )	CO (ppm <sup>3</sup> /O <sub>2</sub> )	UHC (ppm <sup>3</sup> /O <sub>2</sub> )	
25	FT	3.9	3.0	0.372	294	0.016	21	1	
25	FT	3.9	3.0	0.307	243	0.019	25	1	
25	FT	3.9	3.6	0.37*	298	0.021	27	1	
25	FT	3.9	3.6	0.356	281	0.023	30	1	
10	FT	7.3	7.0	0.381	301	0.017	22	7	
10	FT	7.3	7.0	0.354	280	0.000	0	1	
23-1	FT	9.0	8.6	0.389	307	0.016	21	7	
11	FT	10.1	11.0	0.235	186	0.000	0	1	
24-TV	FT	13.0	13.5	0.239	189	0.000	0	7	
13	FT	15.4	13.0	0.233	184	0.000	0	5	
12	FT	18.5	18.0	0.228	180	0.000	0	1	
12	FT	18.5	18.0	0.207	164	0.010	13	1	
346	FT	22.6	18	0.207	164	0.007	9	3	
26-1	FT	23.0	21.6	0.213	168	0.010	13	7	
14	WT	12.9	10.0	0.793	626	0.028	36	1	
1	WT	21.8	17.5	0.449	355	0.000	0	70	
1	WT	21.8	17.5	0.428	338	0.000	0	32	
22	WT	21.9	17.5	0.212	167	0.000	0	0	
22	WT	21.9	17.5	0.221	175	0.000	0	1	
LOC 19	WT	22.0	17.6	0.278	220	0.003	4	7	
19-2	WT	22.0	17.8	0.217	171	0.015	19	7	
19-1	WT	22.0	18.3	0.459	363	0.000	0	7	
19-1	WT	22.0	18.3	0.436	344	0.000	0	7	
23	WT	23.7	19.0	0.286	226	0.003	4	7	
23	WT	23.7	18.9	0.280	221	0.003	4	11	
23	WT	23.7	20.7	0.274	216	0.016	21	0	
23	WT	23.7	19.5	0.314	248	0.028	36	7	
337	WT	24.8	16.1	0.314	248	0.114	148	36	
2	WT	30.5	19.2	0.256	202	0.000	0	1	
ECCC	WT	31.0	24.2	0.200	158	0.008	10	7	
20	WT	49.8	39.8	0.254	201	0.000	0	16	
37-2	WT	50.0	40.5	0.251	198	0.000	0	1	
153	WT	52.4	43	0.451	356	0.014	18	34	
152	WT	53.1	43	0.437	345	0.012	16	30	
LOC 38	WT	56.0	47.6	0.386	305	0.017	22	7	
38-2	WT	56.0	45.4	0.419	331	0.000	0	7	
21	WT	56.3	45.0	0.426	337	0.000	0	1	
6	WT	78.4	65.0	0.240	190	0.000	0	1	
24	WT	79.1	66.4	0.240	190	0.017	22	1	
15-2	WT	81.0	67.2	0.256	202	0.000	0	7	
2-4	WT	81.0	64.8	0.641	506	0.000	0	7	
15	WT	85.7	66.0	0.598	472	0.000	0	1	
124	WT	86.2	57.8	0.263	208	0.000	0	52	
28-1	WT	88.0	36.1	0.263	208	0.000	0	3	
163	WT	92.8	45	0.254	201	0.014	18	7	
160	WT	93.4	62.6	0.340	269	0.016	21	2	
138	WT	93.7	86.2	0.340	269	0.016	21	1	
20-4	WT	100.0	64.0	0.398	314	0.000	0	5	

\*\*\* CONTINUED \*\*\*

UNCONTROLLED EMISSIONS DATA  
RESIDUAL OIL-FIRED ICI BOILERS

BOILER ID	BOILER TYPE	BOILER CAPACITY (MMBtu/hr)	OPERATING LOAD (MMBtu/hr)	EMISSIONS					REFERENCE
				NOx (lb/MMBtu)	NOx (ppm83%O2)	CO (lb/MMBtu)	CO (ppm83%O2)	UHC (lb/MMBtu)	
5	WT	114.0	90.0	0.316	250	0.000	0		1
17	WT	118.2	100.5	0.598	472				1
3	WT	123.6	85.3	0.421	333	0.066	86		1
4	WT	125.0	80.0	0.391	309	0.000	0		1
202	WT	136.5		0.374	295	0.012	16	0.007	16
7	WT	138.5	105.2	0.321	254	0.000	0		1
19	WT	155.1	121.0	0.344	272	0.000	0	0.004	9
120	WT	159.0	127					0.002	5
16	WT	164.9	131.9	0.430	340				3
8	WT	208.4	168.8	0.307	243	0.000	0		1
18	WT	216.4	158.0	0.384	303	0.000	0	0.016	36
9	WT	656.8	527.0	0.342	270			0.003	7

WT: WATERTUBE  
FT: FIRETUBE

UNCONTROLLED EMISSIONS DATA  
DISTILLATE OIL-FIRED ICI BOILERS

BOILER ID	BOILER TYPE	BOILER CAPACITY (MMBtu/hr)	OPERATING LOAD (MMBtu/hr)	EMISSIONS						REFERENCE
				NOx (lb/MMBtu)	NOx (ppm3%O2)	CO (lb/MMBtu)	CO (ppm3%O2)	UHC (lb/MMBtu)	UHC (ppm3%O2)	
14	FT	3.7	2.5	0.149	118	0.007	9	0.001	1	
14	FT	3.7	2.5	0.114	90	0.007	9	0.001	1	
14	FT	3.7	2.0	0.119	94	0.014	18	0.000	1	
8	FT	7.3	7.0	0.163	129	0.000	0	0.000	1	
4	FT	10.7	11.0	0.165	130	0.000	0	0.000	1	
3-2	FT	13.0	6.5	0.221	175	0.000	0	0.000	4	
2	FT	14.4	10.0	0.216	171	0.000	0	0.000	1	
11	FT	15.3	13.0	0.107	85	0.000	0	0.000	1	
5	FT	20.6	18.0	0.149	118	0.000	0	0.000	1	
5	FT	20.6	18.0	0.151	119	0.000	0	0.000	1	
6	FT	25.0	20.0	0.247	195	0.000	0	0.012	1	
4-4	FT	25.0	11.8	0.224	177	0.000	0	0.012	27	
12	VT	21.5	17.8	0.157	124	0.003	4	0.001	2	
3	VT	21.9	17.5	0.102	81	0.000	0	0.000	0	
3	WT	21.9	17.5	0.126	100	0.000	0	0.001	2	
3	WT	21.9	17.5	0.084	66	0.038	49	0.000	1	
19-1	WT	22.0	17.6	0.134	106	0.000	0	0.000	4	
19-1	WT	22.0	14.5	0.107	85	0.000	0	0.000	4	
LOC 19	WT	22.0	18.3	0.154	122	0.003	4	0.000	4	
19-1	WT	22.0	17.6	0.098	77	0.000	0	0.000	4	
13	WT	22.5	18.0	0.150	119	0.010	13	0.003	7	
7	WT	33.7	29.0	0.111	88	0.000	0	0.000	1	
1-2	WT	36.0	18.0	0.136	107	0.000	0	0.000	4	
1-3	WT	38.0	30.0	0.158	125	0.000	0	0.000	4	
10	WT	47.1	33.0	0.158	125	0.000	0	0.000	1	
140	WT	48.6	38.9	0.158	125	0.000	0	0.001	1	
173	WT	48.9	45.5	0.228	180	1.177	1528	0.001	2	
139	WT	53.3	42.7	0.228	180	0.837	1086	0.003	2	
174	WT	127.3	89.1	0.228	180	0.507	658	0.001	7	
170	WT	136.9	98.6	0.228	180	0.837	1086	0.001	2	
1	WT	137.4	109.9	0.228	180	0.507	658	0.001	20	
172	WT	183.2	109.9	0.233	184	0.623	809	0.001	1	
9	WT	219.4	160.2	0.180	142	0.000	0	0.001	2	
JAMES RIVER	WT	240.0	160.2	0.180	142	0.000	0	0.004	9	
339	CI	5.9	4.7	0.158	125	0.158	205	0.022	50	
									3	

WT: WATERTUBE  
FT: FIRETUBE  
CI: CAST IRON

UNCONTROLLED EMISSIONS DATA  
NATURAL GAS-FIRED ICI BOILERS

BOILER ID	BOILER TYPE	BOILER CAPACITY (MMBtu/hr)	OPERATING LOAD (MMBtu/hr)	EMISSIONS					UHC (lb/MMBtu)	UHC (ppm <sup>3</sup> XO <sub>2</sub> )	REFERENCE
				NO <sub>x</sub> (lb/MMBtu)	CO (lb/MMBtu)	CO (ppm <sup>3</sup> XO <sub>2</sub> )	UHC (lb/MMBtu)	UHC (ppm <sup>3</sup> XO <sub>2</sub> )			
SITE 6	FT	8	3	0.11	0.02	88	0.024	27	58	4	
	FT	13	7	0.09	0.15	76	0.024	207	58	1	
	FT	8		0.10	0.15	84	0.024	205	58	9	
	FT	10	6	0.09	0.00	72	0.024	0	216	1	
OHIO UNIV	FT	151	8	0.08	0.00	63	0.014	0	34	1	
	FT	18	11	0.11	0.12	94	0.014	159	34	1	
	FT	12	10	0.07	0.00	56	0.014	0	14	4	
	FT	10	7	0.12	0.01	102	0.014	14	14	1	
5-248-1	FT	13	13	0.10	0.15	84	0.006	205	14	4	
	FT	14	13	0.07	0.00	60	0.006	0	24	9	
	FT	14	10	0.11	0.13	94	0.006	176	281	1	
	FT	17	5	0.10	0.37	84	0.006	508	12	1	
DISNEY STUDIO	FT	17	18	0.10	0.15	84	0.011	205	26	9	
	FT	19	18	0.07	0.01	60	0.011	14	26	1	
	FT	21	22	0.07	0.01	84	0.011	205	26	9	
	FT	23	18	0.13	0.01	110	0.011	15	26	4	
LOCKHEED, CA	FT	25	20	0.13	0.15	109	0.011	205	62	9	
	FT	29	18	0.10	0.00	84	0.011	0	62	1	
	FT	29	29	0.10	0.03	84	0.011	45	10	1	
	FT	32	20	0.10	0.11	84	0.011	144	10	9	
ST. JOSEPH MED	FT	33	20	0.10	0.04	80	0.011	51	10	1	
	FT	5	14	0.09	0.01	73	0.011	14	31	11	
	FT	6	14	0.06	0.15	50	0.011	205	43	1	
	FT	22	18	0.07	0.01	58	0.011	10	55	3	
SHARP HOSP, CA	WT	22	20	0.08	0.01	63	0.002	10	5	1	
	WT	24	20	0.15	0.02	126	0.002	23	0	4	
	WT	24	14	0.16	0.01	137	0.002	19	0	1	
	WT	24	15	0.17	0.00	144	0.002	4	5	1	
ROYALTY CARPET	WT	31	20	0.10	0.00	81	0.002	0	5	1	
	WT	31	25	0.09	0.13	73	0.002	173	31	4	
	WT	35	29	0.12	0.11	99	0.002	147	43	1	
	WT	35	29	0.09	0.35	73	0.002	486	43	1	
CLEAVER BROOKS	WT	36	29	0.10	0.00	84	0.002	5	5	4	
	WT	36	21	0.10	0.01	84	0.002	10	5	4	
	WT	38	30	0.12	0.00	98	0.002	0	5	4	
	WT	38	29	0.09	0.12	72	0.002	166	5	1	
5-716-3	WT	42	32	0.12	0.01	99	0.002	10	5	1	
	WT	45	40	0.11	0.10	91	0.002	139	5	1	
	WT	45	33	0.11	0.00	91	0.002	0	5	1	
	WT	50	43	0.10	0.02	85	0.002	29	2	3	
MARTIN MARILETTA	WT	51	45	0.26	0.00	218	0.001	0	10	3	
	WT	56	50	0.27	0.00	224	0.001	0	10	1	
	WT	62	58	0.10	0.15	84	0.001	205	10	4	
	WT	64	58	0.10	0.10	84	0.001	132	19	9	
CLEAVER BROOKS	WT	72	60	0.11	1.45	95	0.008	1988	19	1	
	WT	73	58	0.11	0.38	95	0.003	527	7	1	
	WT	74	60	0.14	0.76	118	0.012	1044	29	1	
	WT	74	60	0.14	0.76	118	0.012	1044	29	1	

UNCONTROLLED EMISSIONS DATA  
NATURAL GAS-FIRED ICI BOILERS

BOILER ID	BOILER TYPE	BOILER CAPACITY (MMBtu/hr)	OPERATING LOAD (MMBtu/hr)	EMISSIONS					UHC (lb/MMBtu)	UHC (ppm <sup>3</sup> /O <sub>2</sub> )	REFERENCE
				NOx (lb/MMBtu)	NOx (ppm <sup>3</sup> /O <sub>2</sub> )	CO (lb/MMBtu)	CO (ppm <sup>3</sup> /O <sub>2</sub> )	CO (lb/MMBtu)			
5	WT	75	60	0.13	105	0.00	0	0.002	5	1	
10-4	WT	61	0.13	106	0.00	0	0.000	0	0	4	
9-RC-1	WT	75	59	0.31	256	0.00	0	0.005	12	4	
6	WT	78	60	0.29	245	0.01	10	0.001	2	1	
20	WT	80	66	0.12	99	0.07	99	0.000	0	1	
159	WT	85	60	0.24	200			0.002	5	1	
161	WT	85	60	0.19	157			0.005	12	1	
162	WT	85	60	0.03	23	0.01	19	0.001	2	1	
122	WT	87	67					0.000	0	3	
28-1	WT	88	80	0.26	215	0.00	0	0.000	0	4	
123	WT	100	71					0.000	0	3	
25	WT	134	106	0.13	110	0.00	0	0.000	0	1	
23	WT	143	116	0.11	95	0.00	0	0.000	0	1	
121	WT	158	133					0.000	0	3	
26	WT	187	158	0.18	153	0.00	0	0.051	122	1	
7	WT	188	169	0.35	379	0.04	55	0.014	34	1	
8	WT	203	169	0.35	291	0.00	0	0.014	34	1	
157	WT	222	117					0.002	5	1	
JAMES RIVER	WT	240		0.06	50					8	
SO CAL ED	WT	240		0.04	33					8	
27	WT	247	180	0.27	227	0.00	0			1	
#1	WT	265	260	0.24	200			0.003	7	1	
21	WT	281	237	0.26	215			0.016	38	1	
28	WT	321	264	0.22	187	0.23	320	0.001	2	1	
9	WT	349	317	0.24	202	0.00	0	0.001	2	1	
22	WT	401	343	0.39	324	0.00	0	0.002	5	1	

WT: WATERTUBE  
FT: FIRETUBE

UNCONTROLLED EMISSIONS DATA  
WOOD-FIRED ICI BOILERS

BOILER ID	BOILER HEAT INPUT (MMBtu/hr)	BOILER OUTPUT CAPACITY (MMBtu/hr)	FUEL TYPE	EMISSIONS					REFERENCE
				NOx (lb/MMBtu)	NOx (ppm@3%O2)	CO (lb/MMBtu)	CO (ppm@3%O2)	THC (lb/MMBtu)	
A	6.8	5.1	SHAV	0.01	8				12
B	8.2	8.5	SHAV, SAW	0.01	9				12
C	7.4	6.8	SHAV, SAW	0.01	9				12
D	10.4	8.5	WW	0.09	62				12
E	20.8	9.9	WW	0.02	11				12
F	5.8	5.1	SHAV, SAW	0.00	3				12
G	1.7	5.1	SAW	0.00	3				12
H	94.0	39.5	WW	0.15	104				12
I	141.0	57.3	SAW	0.13	90				12
J	19.1	22.5	SAW	0.01	8				12
K	23.5	19.4	WW	0.03	23				12
L	134.0	112.6	80%WOOD/20%DIST	0.29	200				13
LFC	190		WW	0.24	84				12
YANKEE ENERGY	190		WW	0.17	170				13
KENETECH ENERGY	225		WW	0.30	210				13
RYEGATE POWER	300		WW	0.30	210				13
BLACK & VEATCH	440		WW	0.21	150				13
HONEY LAKE PWR	480		WW	0.20	140				13
ALT ENERGY	500		WW	0.18	128				13
ALT ENERGY	500		WW	0.18	128				13
M	NA	229.0	85%BARK/15%NG	0.29	206				12
N	NA	112.6	20%BARK/80%COAL	0.39	277				12

NA: NO DATA AVAILABLE  
SHAV: WOOD SHAVINGS  
SAW: SAWDUST  
WW: WOOD WASTE  
DIST: DISTILLATE OIL  
NG: NATURAL GAS



UNCONTROLLED EMISSIONS,  
BUBBLING BED FBC BOILERS

FBC ID	MAXIMUM CAPACITY (MMBtu/hr)	PRIMARY FUEL TYPE	NOx (lb/MMBtu)	NOx (ppm @3%O2)	CO (lb/MMBtu)	CO (ppm @3%O2)	REFERENCE
B&W Pilot		coal RDF	0.81 0.44	600 315	0.49 4.68	600 5523	14
Canadian Forces Base, P. Edward Is., Canada	50	coal	0.62	460	0.37	453	4
Colmac, CA	330	biomass	0.10	70	0.15	173	15
CCRL Pilot, Canada	3.4	rice hulls	0.20	140	3.10	3655	7
Dong Chang Paper, Korea	55	coal	0.17	125			16
HBCM Le Bec, France	6.8	coal	0.11	80	0.49	600	17
Mesquite Lk, CA	160	cow manure	0.42	294	0.38	437	18
Mitsui Toatsu, Japan	75	coal	0.46	340			16
Saarbruecken, Germany	289	coal	0.12	90	0.17	204	19
Sakito Salt, Japan	145	coal	0.23	170			16
SOHIO Refinery, OH	97	coal	0.56	415			4
Sumitomo Power, Japan	245	coal	0.27	200			16
Sumitomo Metal, Japan	150	coal	0.30	220			16
TNO	14	coal	0.28	210	0.30	365	20
TVA Pilot, KY	134	coal	0.17	125	0.41	495	21

RDF: REFUSE DERIVED FUEL

UNCONTROLLED EMISSIONS,  
CIRCULATING FBC BOILERS

FBC ID	MAXIMUM CAPACITY (MMBtu/hr)	PRIMARY FUEL TYPE	NOx (lb/MMBtu)	NOx (ppm @3%O2)	CO (lb/MMBtu)	CO (ppm @3%O2)	REFERENCE
ADM, Cedar Rapids, IA	500	coal	0.30	222	0.02	26	22
A.E. Staley	394	coal	0.60	444	0.17	207	23
Ansaldo/Studovik	8.5	coal	0.20	150	0.17	210	24
Archbald Cogen	210	culm	0.25	180			23
BF Goodrich	130	coal	0.34 0.22	252 164	0.03 0.03	38 31	25
Energieversorgung, Germany	250	coal	0.16	118			16,26
Ft. Howard Co.	362	coal	0.16	118	0.08	100	27
Foster Wheeler	400	culm	0.20	140			28
GM-Ft. Wayne, IN	157	coal	0.40	296	0.20	243	23
Idemitsu, Japan	693	coal	0.18	133			23
Ione Cogen., CA	155	coal	0.14	101	0.03	33	29
Kerry Coop, Ireland	122	coal/peat/ww	0.09	65	0.06	75	23
Kuk Dong Oil, Korea	280	petroleum coke	0.34	250			16,26
Kuraray, Japan	162	coal	0.20	148			23
Lauoff Grain, IL	250	coal	0.20	150	0.08	100	30
Montana One	476	coal waste	0.28	200	0.00	2	31
Paper mill, U.S.	340	coal	0.49	362	0.25	300	32
Pyropower Corp.		coal petroleum coke	0.27 0.12	200 90	0.25 0.21	300 250	33
Scott Paper	683	culm	0.60	430			34
Sun Kyong Fibers, Korea	300	coal	0.27	200			16,26
Thyssen Industrie, Germany	84	coal	0.18	135	0.23	276	35
Ultra Systems, CA	280	wood	0.21	150			13
U. of Iowa	179	coal	0.40	296	0.17	207	23
U. of Missouri	210	coal	0.50	370	0.17	207	23
Wheelabrator Energy	430	coal	0.50	370	0.10	122	22

ww: WOOD WASTE

## REFERENCES FOR APPENDIX A

1. Emissions Assessment of Conventional Stationary Combustion Systems, Volume V: Industrial Combustion Sources. Publication No. EPA-600/7-81-003c. U.S. Environmental Protection Agency. Research Triangle Park, NC. 1981.
2. Technology Assessment Report for Industrial Boiler Applications: NO<sub>x</sub> Combustion Modification. Publication No. EPA-600/7-79-178f. U.S. Environmental Protection Agency. Research Triangle Park, NC. December 1979.
3. Emissions Assessment of Conventional Stationary Combustion Systems, Volume IV: Commercial/Institutional Combustion Sources. Publication No. EPA-600/7-71-003c. Prepared by TRW, Inc., for the U.S. Environmental Protection Agency. Research Triangle Park, NC. January 1981.
4. Overview of the Regulatory Baseline, Technical Basis, and Alternative Control Levels for Nitrogen Oxides Emission Standards for Small Steam Generating Units. Publication No. EPA-450/3-89-13. Office of Air Quality Planning and Standards. U.S. Environmental Protection Agency. Research Triangle Park, NC. May 1989.
5. Field Tests of Industrial Stoker Coal-Fired Boilers for Emission Control and Efficiency Improvement—Site E. Publication No. EPA-600/7-80-064a. U.S. Environmental Protection Agency. Research Triangle Park, NC. March 1980.
6. Field Tests of Industrial Stoker Coal-Fired Boilers for Emission Control and Efficiency Improvement—Site H. Publication No. EPA-600/7-80-112a. U.S. Environmental Protection Agency. Research Triangle Park, NC. May 1980.
7. Industrial Boiler Combustion Modification NO<sub>x</sub> Controls, Volume I: Environmental Assessment. Publication No. EPA-600/7-81-126a. U.S. Environmental Protection Agency. Research Triangle Park, NC. July 1981.
8. Letter from LeBlanc, B., Riley Stoker Corp., to Sanderford, E., MRI. NO<sub>x</sub> Emissions from Utility and Industrial Boilers. April 15, 1992.
9. Letter from Coffey, A., Cleaver Brooks, to Herbert, E. L., Herbert & Conway, Inc. Cleaver Brooks FGR Experience. September 14, 1992.
10. Letter from Eichamer, P., Exxon Chemical Co., to Snyder, R., MRI. ACT NO<sub>x</sub> Data. July 10, 1992.
11. Cleaver Brooks System 20 FGR. Cleaver Brooks Co. 1993.
12. NO<sub>x</sub> Emission Factors for Wood-Fired Boilers. Publication No. EPA-600/7-79-219. U.S. Environmental Protection Agency. Research Triangle Park, NC. September 1979.
13. Letter and attachments from Pickens, R. D., Nalco Fuel Tech, to Castaldini, C., Acurex Environmental Corp. NO<sub>x</sub>OUT Urea-Based SNCR Performance. June 9, 1992.

14. McGavin, C. R., et al. FBC Testing of Coal/RDF Mixtures. Presented at the 10th International Conference on Fluidized Bed Combustion. San Francisco, CA. May 1989.
15. Dahl, J. Agricultural Waste Fueled Energy Projects. Presented at the Second CIBO Alternate Fuels Conference. Arlington, VA. May 1989.
16. Makansi, J. and R. Schwieger. Fluidized Bed Boilers. Power Magazine. May 1987.
17. Marlair, G., et al. The Lardet-Babcock/Cerchar 2.5 MWt Package Fluidized Bed Boiler. Presented at the 9th International Conference on Fluidized Bed Combustion. Boston, MA. May 1987.
18. Cooke, R. C. Mesquite Lake Resource Recovery Project, a Case History. Presented at the Second CIBO Alternate Fuels Conference. Arlington, VA. May 1989.
19. Tigges, K. D. and D. Kestner. Experience with the Commissioned Operation of the Saarbruecken Circofluid Boiler. Presented at the 10th International Conference on Fluidized Bed Combustion. San Francisco, CA. May 1989.
20. Bijvoet, U. H. C., et al. Characterization of Coal and Staged Combustion in the TNO 4 MWt AFBB Research Facility. Presented at the 10th International Conference on Fluidized Bed Combustion. San Francisco, CA. May 1989.
21. Tavoulareas, S., et al. EPRI's Research on AFBC By-Product Management. Presented at the 9th International Conference on Fluidized Bed Combustion. Boston, MA. May 1987.
22. Lombardi, C. Tampella-Keeler Operating Experience with CFB Boilers. Presented at the Fifth Annual CIBO Fluidized Bed Conference. Sacramento, CA. December 1989.
23. Place, W. J. CFBC via Multi Solid Fluidized Beds in the Industrial Sector. Presented at the 9th International Conference on Fluidized Bed Combustion. Boston, MA. May 1987.
24. Adams, C., et al. Full Load Firing of Coal, Oil, and Gas in a Circulating Fluidized Bed Combustor. Presented at the 10th International Conference on Fluidized Bed Combustion. San Francisco, CA. May 1989.
25. Hutchinson, B. The Pyroflow Boiler at B.F. Goodrich Co.—The First 18 Months of Steaming at Henry, IL. Presented at the 9th International Conference on Fluidized Bed Combustion. Boston, MA. May 1987.
26. Worldwide List of Fluid Bed Boiler Installations. Council of Industrial Boiler Owners (CIBO). Burke, VA. 1990.
27. Abdulally, I. F. and D. Parham. Design and Operating Experience of a Foster Wheeler CFB Boiler. Presented at the 10th International Conference on Fluidized Bed Combustion. San Francisco, CA. May 1989.

28. Studley, B. and D. Parham. Foster Wheeler Mt. Carmel Anthracite Culm-Fired CFB Steam Generation Experience. Presented at the Sixth Annual CIBO Fluidized Bed Conference. Harrisburg, PA. December 1990.
29. Bashar, M. and T. S. Czarnecki. Design and Operation of a Lignite Fired CFB Boiler Plant. Presented at the 10th International Conference on Fluidized Bed Combustion. San Francisco, CA. May 1989.
30. Belin, F., et al. Lauhoff Grain Coal-Fired CFB Boiler—Design, Startup, and Operation. Presented at the Sixth Annual CIBO Fluidized Bed Conference. Harrisburg, PA. December 1990.
31. Syngle, P. V. and B. T. Sinn. Case History of the Montana One CFB Project. Presented at the Sixth Annual CIBO Fluidized Bed Conference. Harrisburg, PA. December 1990.
32. Abdually, I. F. and D. Parham. Operating Experience of a CFB Boiler Designed by Foster Wheeler. Presented at the Fifth Annual CIBO Fluidized Bed Conference. Sacramento, CA. December 1989.
33. Tang, J. and F. Engstrom. Technical Assessment on the Ahlstrom Pyroflow Circulating and Conventional Bubbling FBC System. Presented at the 9th International Conference on Fluidized Bed Combustion. Boston, MA. May 1987.
34. Darling, S. L., et al. Design of the Scott Paper CFB. Presented at the 9th International Conference on Fluidized Bed Combustion. Boston, MA. May 1987.
35. Geisler, O. J., et al. 40 MW FBC Boiler for the Combustion of High Sulfur Lignite. Presented at the 10th International Conference on Fluidized Bed Combustion. San Francisco, CA. May 1989.
36. Emissions and Efficiency Performance of Industrial Coal Stoker Fired Boilers. Publication No. EPA-600/7-81-111a. July 1981.

## APPENDIX B. CONTROLLED NO<sub>x</sub> EMISSION DATA

This appendix lists controlled emissions data for boilers used in the ICI sector. Where appropriate, data for small utility boilers and representative pilot-scale units are also included. The data were compiled primarily from technical reports, EPA documents, compliance records, and manufacturers' literature, as listed in the references at the end of this appendix. Additional low-NO<sub>x</sub> performance data specific to low-NO<sub>x</sub> burners (LNB) marketed by Coen Company, of California, and Tampella Power Corporation, Faber Burner Division, of Pennsylvania, are in Appendix C. Boiler emissions data are listed by fuel type and whether the NO<sub>x</sub> control method used was a combustion modification or a flue gas treatment method.

NOx EMISSIONS DATA - PULVERIZED COAL FIRED ICI BOILERS WITH COMBUSTION MODIFICATION NOx CONTROLS

BOILER ID	FUEL TYPE	BOILER TYPE	HEAT INPUT CAPACITY (MMBTU/HR)	CONTROL TYPE	NEW (N) OR RETROFIT (R)	AVERAGE LOAD (%)	STACK O2		UNCONTROLLED/CONTROLLED NOx (ppm@3XO2)*	AVERAGE NOx REDUCTION (%)	REF. NO.	
							UNCONTROLLED (%)	CONTROLLED (%)				
UNITS WITH LOW NOx BURNERS (LNB)												
DUPONT CHEMICAL	BITUM	WT/SW	140	LNB	R				550/280	NA/25	49	1
FOSTER WHEELER CETF (CF/SF LNB) PILOT	BITUM	WT/SW	80	LNB	R				700/260		63	2
FOSTER WHEELER CETF (IFS LNB) PILOT	BITUM	WT/SW	80	LNB	R				770/200		74	3
KERR-MCGEE CHEM CORP, CA	BITUM	WT/TANG		LNB	R	100	NA/3.6		290-365/269	NA/12	18	4
NEIL SIMPSON UNIT 5, WY	SUBBITUM	WT/SW	275	LNB	R		2.3-3.4/2.3-3.5		630-725/190-255	20-27/13-420	67	5
PUBLIC SVC INDIANA WABASH #5	BITUM	WT/WALL	1,000	LNB	R				730/370		49	6
UNNAMED	BITUM	WT/SW	150	LNB	R				630/220		65	1

UNITS WITH STAGED COMBUSTION AIR (SCA)

ALMA #3	BITUM	WT/SW	230	SCA (BOOS)	R	57			340/250		27	7
KERR-MCGEE CHEM CORP, CA	BITUM	WT/TANG		SCA (OFA)	R	100			290-365/211-280	NA/30-98	25	4
SITE #31-7	BITUM	WT/SW	260	SCA (BOOS)		25			1065/651		39	7
UNNAMED SITE 3	BITUM	WT	325	SCA (OFA)		70			815/691**		15	8

UNITS WITH COMBINED LNB AND SCA

ALBRIGHT #1, ALLEGHANY POWER, PA	BITUM	WT/WALL	875	LNB & SCA (OFA)					695/275		60	6
BHK	BITUM	WT	200	LNB & SCA	R				330-600/180-360		42	9
GALLAGHER #2 PUBLIC SVC, INDIANA	BITUM	WT/WALL	1,250	LNB & SCA (OFA)					720/275		62	6
HOWARD DOWN #10 VINELAND, NJ	BITUM	WT/WALL	365	LNB & SCA (OFA)					785/275		65	6

NOx EMISSIONS DATA - PULVERIZED COAL FIRED ICI BOILERS WITH COMBUSTION MODIFICATION NOx CONTROLS

BOILER ID	FUEL TYPE	BOILER TYPE	HEAT INPUT (MMBTU/HR)	CONTROL TYPE	NEW (M) OR RETROFIT (R)	AVERAGE LOAD (%)	STACK O2		AVERAGE NOx REDUCTION (%)	REF. NO.
							UNCONTROLLED (%)	CONTROLLED (%)		
FOSTER WHEELER CETF (CF/SF LNB) PILOT	BITUM	WT/SW	80	LNB & SCA	R		700/110	NA/330	84	2
KERR-MCGEE CHEM CORP., CA	BITUM	WT/TANG		LNB & SCA	R	100	NA/3.6	290-365/148	NA/34	4
UNNAMED PAPER CO	BITUM	WT/OW	470	LNB & SCA	R		NA/220-370	NA/5-30		10
WABASH #2 PUBLIC SVC INDIANA	BITUM	WT/WALL	875	LNB & SCA (OFA)			590/330		44	6
WIPCO PEARL STATION, IL	BITUM	WT/SW	250	LNB & SCA	R	100	690-725/220-264	35/60-166	66	11

UNITS WITH REBURN

EPRI/6RI/BBW PILOT TEST	BITUM	CYCLONE	6	N. GAS REBURN		100	3/3	925/235-420	30/30	65	12
				OIL REBURN		100	3/3	925/250-537		57	
				COAL REBURN		100	3/3	925/300-555		54	
PLANT "A", JAPAN	BITUM	WT/SW	190	COAL REBURN		100	NA/215-385				13
PLANT "B", JAPAN	BITUM	WT/OW	375	COAL REBURN		100	NA/170-250				13
TAIYO PAPER, JAPAN	BITUM	WT/TANG	825	OIL REBURN		100	240/167			30	14

WT: watertube; SW: single wall-fired; OW: opposed wall-fired; TANG: tangential fired

NA: no data available

\* To convert NOx to lb/MMBtu divide by 740.

\*\* Long term test data. All others are short term



NOx EMISSIONS DATA - COAL FIRED STOKER BOILERS WITH COMBUSTION MODIFICATION NOx CONTROLS

BOTLER ID	FUEL TYPE	BOILER TYPE	HEAT INPUT CAPACITY (MMBTU/HR)	CONTROL TYPE	AVERAGE LOAD (%)	STACK O2 UNCONTROLLED/CONTROLLED (%)	UNCONTROLLED/CONTROLLED EMISSIONS			AVERAGE NOx REDUCTION (%)	
							FGR (%)	NOx (ppm@3XO2)*	CO (ppm@3XO2)		UNC (ppm@3XO2)
UNITS WITH STAGED COMBUSTION AIR (SCA)											
SITE "A"	LOW S COAL	SS	375	SCA (OFA)	79	6/5.9	394/353	313/300	97/NA	10	15
SITE "C"	BITUM	SS	250	SCA (OFA)	92	NA/8.6-8.9	NA/230-387	NA/53-103			16
SITE "D"	BITUM	OFS	102	SCA (OFA)	89	NA/7.4-7.8	NA/172-202	NA/73-2345			17
SITE "F"	BITUM	SS	98	SCA (OFA)	99	8.2/5.5	348-413/263	231-252/429	9/5	31	18
SITE 14	COAL	SS	200	SCA (OFA)	75	NA/11	568/369			35	7
SITE 30	COAL	SS	125	SCA (OFA)	66	6.2/6.1	320/237	0/49		26	19
SITE 35	COAL	OFS	215	SCA (OFA)	47	9.5/9.0	164/166	25/15	25/35	-1	19
WILMAR 3	COAL	SS	160	SCA (OFA)	66	NA/9.0	372/350			6	20

B5

UNITS WITH COMBINED FLUE GAS RECIRCULATION (FGR) AND SCA

UNNAMED	BITUM	SS	125	FGR & SCA	80	8/3.5	MA	350/140		60	21
SITE 1	BITUM	SS	134	FGR & SCA	95	8/5	MA	400/350		13	22
SITE 2	BITUM	SS	270	FGR & SCA	75	4/4	MA	280-340/		0	22

SS: spreader stoker; OFS: overfeed stoker  
 FGR: flue gas recirculation; SCA: staged combustion air; OFA: overfire air; RAP: reduced air preheat  
 NA: no data available  
 \* To convert NOx to lb/MMBtu divide by 740.  
 Note: all are short term test data

UNITS WITH NATURAL GAS COFIRE

VANDERBILT UNIVERSITY	COAL	SS	90	GAS COFIRE	100	5.6/3.5		290-250/200		20-25	92
-----------------------	------	----	----	------------	-----	---------	--	-------------	--	-------	----

NOx EMISSIONS DATA - COAL FIRED FBC BOILERS WITH COMBUSTION MODIFICATION NOx CONTROLS

BOILER ID	FUEL TYPE	BOILER TYPE	HEAT INPUT CAPACITY (MMBTU/HR)	CONTROL TYPE	AVERAGE LOAD (%)	STACK O2		UNCONTROLLED/CONTROLLED EMISSIONS			AVERAGE NOx REDUCTION (%)	REF. NO.
						UNCONTROLLED (%)	CONTROLLED (%)	NOx (ppm@3XO2)*	CO (ppm@3XO2)	UHC (ppm@3XO2)		
AHLSTROM CORP, FINLAND	BITUM	CFBC	222	SCA (OFA)				NA/51-335				23
AHLSTROM CORP	BROWN COAL	CFBC	222	SCA (OFA)				NA/103-155				23
BF GOODRICH	BITUM	CFBC	140	SCA (OFA)				NA/280	NA/33	NA/2		24
CHALMERS UNIV, SWEDEN	BITUM	BFBC	16 MWe	SCA (OFA)		23/22**		125/75			40	25
CONOCO, TX	COAL/COKE	CFBC	50	SCA (OFA)				NA/100				26
IOWA BEEF	BITUM/SUB	DBFBC	88	SCA (OFA)				NA/100	NA/100	NA/22		27
KERAVA ENERGY, FINLAND	COAL	CFBC	102	SCA (OFA)				NA/39-245				23
TNO AFBB RESEARCH FACILITY, SWEDEN	BITUM	BFBC	14	SCA (OFA)				270-337/67-135	387-500/550-1100		67	28
UNNAMED	COAL	CFBC	222	SCA & FGR				NA/90-116				23
UNNAMED	COAL	CFBC	102	SCA & FGR				NA/100-115				23
YOSHITAWA #1, JAPAN	COAL, PAPER	BFBC	125	ASH REINJECT	100			90/30			67	29

CFBC: circulating fluidized bed combustor (FBC); BFBC: bubbling bed FBC; DBFBC: dual bed FBC

SCA: staged combustion air; OFA: overfire air; FGR: flue gas recirculation

NA: no data available

\* To convert NOx to lb/MMBtu divide by 740.

\*\* Total excess air

Note: all are short term test data

NOx EMISSIONS DATA - NATURAL GAS FIRED ICI BOILERS WITH COMBUSTION MODIFICATION NOx CONTROLS

BOILER ID	FUEL TYPE	BOILER TYPE	HEAT INPUT CAPACITY (MMBTU/HR)	CONTROL TYPE	NEW (M) OR RETROFIT (R)	LOAD (%)	STACK O2		UNCONTROLLED/CONTROLLED EMISSIONS		AVERAGE NOx REDUCTION (%)	REF NO.
							UNCONTROLLED (%)	CONTROLLED (%)	NOx (ppm@3XO2)*	CO (ppm@3XO2)		
WITH FLUE GAS RECIRCULATION (FGR)												
ADVANCED CARDIO-VASCULAR SYSTEMS, CA	NG	WT/PKG	6	FGR	R		NA	NA	84/22	205/62	74	30
ALLIED SIGNAL, CA	NG	FT/PKG	12.5	FGR		100	NA	NA	NA/29	NA/30		31
ALLIED SIGNAL, CA	NG	FT/PKG	6.3	FGR		100	NA	NA	NA/25	NA/32		31
ANAHEIM MILLS, CA	NG	FT/PKG	10.5	FGR	R	100	NA	NA	NA/27	NA/6		31
ARATEX, CA	NG	FT/PKG	21	FGR	N	100	NA	NA	NA/21	NA/0.5		31
BAXTER HIGHLAND, CA	NG	FT/PKG	17	FGR	N	100	NA	NA	NA/28	NA/51		31
BAXTER HIGHLAND, CA	NG	FT/PKG	10.5	FGR	N	100	NA	NA	NA/20			31
BEV HILLS HILTON	NG	FT/PKG	8.5	FGR	R	73	NA/4	20	NA/21	NA/5		32
				FGR	R	100	NA/4	20	NA/28	NA/10		
CA DEPT OF CORRECTIONS	NG	FT/PKG	25	FGR	N	95	NA/3.7	NA	NA/25	NA/26		33
CA MILK PROD	NG	WT/PKG	60	FGR	N		NA	NA	NA/33			34
CAL COMPACT, CA	NG	FT/PKG	10.5	FGR	R	100	NA	NA	NA/29	NA/21		31
CLAYTON INDUSTRIES TEST	NG	WT		FGR			3.6/3.6	10-20	70-100/25-35		65	35
CLEAVER BROOKS TEST	NG	FT/PKG	8.5	FGR		100	5	10	60/50		17	36
				FGR		100	10	15	60/38		37	
				FGR		100	15	20	60/27		55	
				FGR		100	20		60/20		67	
CLEAVER BROOKS TEST	NG	FT/PKG	15	FGR		100	5	10	88/79		10	37
				FGR		100	10	15	88/61		31	
				FGR		100	15	20	88/40		55	
				FGR		100	20		88/28		68	
CLOUGHERTY PACKING, CA	NG	WT/PKG	18	FGR	R	100	NA	NA	NA/28	NA/52		33
CLOUGHERTY PACKING, CA	NG	WT/PKG	36	FGR	R	100	NA	NA	NA/30	NA/48		33
COMMUNITY LINEN, CA	NG	FT/PKG	15	FGR	R	100	NA	NA	NA/29	NA/33		31
COMMUNITY LINEN, CA	NG	FT/PKG	8.4	FGR	R	100	NA	NA	NA/23	NA/0		31
DISNEY STUDIOS, CA	NG	FT/PKG	12.6	FGR	R		NA	NA	84/23	205/77	73	30

NOx EMISSIONS DATA - NATURAL GAS FIRED ICI BOILERS WITH COMBUSTION MODIFICATION NOx CONTROLS

BOILER ID	FUEL TYPE	BOILER TYPE	HEAT INPUT CAPACITY (MMBTU/HR)	CONTROL TYPE	NEW (N) OR RETROFIT (R)	LOAD (%)	STACK D2 UNCONTROLLED/CONTROLLED		UNCONTROLLED/CONTROLLED EMISSIONS			AVERAGE NOx REDUCTION (%)	REF. NO.
							(%)	(%)	NOx (ppm@3XO2)*	CO (ppm@3XO2)	UHC (ppm@3XO2)		
ECCC	NG	FT/PKG	12	FGR		50	4/4	30	79/25			68	7
ECCC	NG	WT/PKG	31	FGR		39	3.1/2.6	22	47/18	20/20		62	38
						30	3.5/1.2	26	58/13	10/55		78	
FOLSOM PRISON	NG	WT/PKG	48	FGR	N			NA	NA/42				34
FOUR SEASONS HOTEL, CA	NG	FT/PKG	10.5	FGR	R	100		NA	NA/16	NA/41			31
FRIENDLY HILLS MED CENTER, CA	NG	FT/PKG	21	FGR	R	100		NA	NA/35	NA/194			31
FRITO LAY, CA	NG	WT/PKG	78	FGR	N			NA	NA/42				34
FRITO LAY, CA	NG	FT/PKG	12.6	FGR	R	100		NA	NA/24	NA/33			31
FRITO LAY, CA	NG	FT/PKG	12.6	FGR	R	100		NA	NA/27	NA/32			31
GAF BUILDING MATERIALS, CA	NG	WT/PKG	16.7	FGR	R	100		NA	NA/23	NA/124			31
GREEN FOODS CORP, CA	NG	FT/PKG	10	FGR	N	100	NA/11.7	12.7	NA/27	NA/0.9			33
HILL PET FOODS, CA	NG	FT/PKG	4.2	FGR	N	100		NA	NA/27	NA/13			31
HUGHES AIRCRAFT 1 CA	NG	FT/PKG	8	FGR	R	100		NA	NA/30				33
HUGHES AIRCRAFT 2 CA	NG	FT/PKG	8	FGR	R	100		NA	NA/30				33
HUGHES AIRCRAFT, CA	NG	FT/PKG	8.4	FGR	R	100		NA	NA/30	NA/34			31
INTEGRATED PROTEIN	NG	WT/PKG	37	FGR	N			NA	NA/33				34
KAISER HOSP, CA	NG	FT/PKG	8	FGR	N	100	4/4.7	12.5	80/33	16/13		59	89
KAISER HOSPITAL, CA	NG	FT/PKG	14.6	FGR	R	100		NA	NA/30	NA/46			31
KIRKHILL RUBBER, CA	NG	FT/PKG	16.8	FGR	N	95		NA	NA/22	NA/9			31
KNOTT'S BERRY FARM, CA	NG	FT/PKG	14	FGR	R	100		NA	NA/27	NA/0			31
LIBERTY VEG OIL, CA	NG	FT/PKG	9.4	FGR	R	100		NA	NA/27	NA/26			31
L.A. DYE & PRINT, CA	NG	FT/PKG	14.6	FGR	R	100		NA	NA/19				31
L.A. HILTON	NG	FT/PKG	6	FGR	N			NA	NA/33				34
L.A. PAPER BOX, CA	NG	WT/PKG		FGR	R	100		NA	NA/27	NA/11			31
LOCKHEED, CA	NG	FT/PKG	16.7	FGR	N			NA	84/24	205/192		71	30

NOx EMISSIONS DATA - NATURAL GAS FIRED ICI BOILERS WITH COMBUSTION MODIFICATION NOx CONTROLS

BOILER ID	FUEL TYPE	BOILER TYPE	HEAT INPUT CAPACITY (MMBtu/HR)	CONTROL TYPE	NEW (N) OR RETROFIT (R)	LOAD (%)	STACK O2 UNCONTROLLED/CONTROLLED (%)	UNCONTROLLED/CONTROLLED EMISSIONS			AVERAGE NOx REDUCTION (%)	REF. NO.
								NOx (ppm@3%O2)*	CO (ppm@3%O2)	UNC (ppm@3%O2)		
MARTIN MARIETTA, CA	NG	WT/PKG	62	FGR	N			NA	84/39	205/205	53	30
MATCHMASTERS, CA	NG	FT/PKG	21	FGR		100		NA	NA/21	NA/32		31
MCCLELLAN AFB	NG	WT/PKG	58	FGR	N			NA	NA/42			34
NORTHROP CORP	NG	WT/PKG	22	FGR	N			NA	NA/42			34
NUMAY LINEN, CA	NG	FT/PKG	18.8	FGR		100		NA	NA/28	NA/21		31
OHIO UNIVERSITY	NG	FT/PKG	8.4	FGR	N			NA	84/30	205/103	64	30
PACIFIC COAST DYING & FINISHING, CA	NG	FT/PKG	25	FGR	N			NA	NA/23	NA/12		33
PACIFIC DYE, CA	NG	FT/PKG	16.7	FGR	R			NA	NA/21	NA/37		31
REINHOLD IND., CA	NG	FT/PKG	14.6	FGR	R			NA	NA/28	NA/76		31
ROCKWELL INTNL, CA	NG	FT/PKG	9	FGR	N		NA/9.4	NA	NA/24	NA/140		33
ROCKWELL INTNL, CA	NG	FT/PKG	14.6	FGR	R			NA	NA/25	NA/8		31
ROYALTY CARPET, CA	NG	FT/PKG	29	FGR	N			NA	84/22	205/84	74	30
ST. FRANCIS HOSP, CA	NG	FT/PKG	14.6	FGR		100	3.7/3.7	20	87/29	23/3	67	89
ST. FRANCIS HOSP, CA	NG	FT/PKG	21	FGR		100	3.9/3.9	20	70/19	105/7	73	89
ST. JOHN'S REGIONAL MEDICAL CENTER, CA	NG	FT/PKG	10.5	FGR	R			NA	NA/37	NA/42		31
ST. JOSEPH MEDICAL CENTER, CA	NG	FT/PKG	21	FGR	N			NA	84/20	205/67	76	30
ST. JUDE MEDICAL CENTER, CA	NG	WT/PKG	10.5	FGR		100		NA	NA/24	NA/33		31
SANTEE DAIRIES, CA	NG	FT/PKG	17.4	FGR	R			NA	NA/25	NA/44		31
SCHOOL FOR DEAF, CA	NG	FT/PKG	10.5	FGR	R			NA	NA/25	NA/75		31
SHARP HOSPITAL, CA	NG	FT/PKG	25	FGR	R			NA	84/26	205/49	89	30
SHERATON UNIVERSAL HOTEL, CA	NG	FT/PKG	12.5	FGR	R			NA	NA/27	NA/2		33
STANTISLAUS FOODS	NG	WT/PKG	162	FGR	N			NA	NA/50			34
TRI VALLEY GROWER, CA	NG	WT/PKG	175	FGR	N			NA	NA/50			34
UNIVERSAL HILTON, CA	NG	FT/PKG	10.5	FGR		100		NA	NA/37	NA/38		31

NOx EMISSIONS DATA - NATURAL GAS FIRED ICI BOILERS WITH COMBUSTION MODIFICATION NOx CONTROLS

BOILER ID	FUEL TYPE	BOILER TYPE	HEAT INPUT CAPACITY (MMBtu/HR)	CONTROL TYPE	NEW (N) OR RETROFIT (R)	LOAD (%)	STACK O2 UNCONTROLLED/CONTROLLED (%)	UNCONTROLLED/CONTROLLED EMISSIONS		AVERAGE NOx REDUCTION (%)	REF. NO.
								NOx (ppm@3XO2)*	CO (ppm@3XO2)		
UNNAMED #1	NG	WT/PKG	5	FGR		100	NA	73/20	14/22	73	39
UNNAMED #2	NG	WT/PKG	64	FGR		100	NA	84/37	132/77	56	39
UNNAMED #3	NG	FT/PKG	12.6	FGR		100	NA	NA/24	NA/25		39
UNNAMED #4	NG	FT/PKG	25	FGR		100	NA	NA/24	NA/49		39
UNNAMED #5	NG	FT/PKG	33.5	FGR		100	NA	80/22	51/12	73	39
UNNAMED #6	NG	WT/PKG	23	FGR	N		NA	NA/67			34
VENTURA COASTAL, CA	NG	FT/PKG	30	FGR	N	100	NA/3.9	NA/32	NA/103		33
VERDUGO HILLS HOSPITAL, CA	NG	FT/PKG	10.5	FGR	R	100	NA	NA/33	NA/2		31
VITA-PAKT, CA	NG	FT/PKG	10.5	FGR	R	100	NA	NA/29	NA/27		31
VITA-PAKT, CA	NG	FT/PKG	6.3	FGR	R	100	NA	NA/32	NA/31		31
WILSON SPORTING GOODS, CA	NG	FT/PKG	3	FGR	N	100	NA/3.3	NA/22	NA/8	NA/22	33
20TH CENT FOX, CA	NG	FT/PKG	4.2	FGR		100	NA	NA/26	NA/40		31

WITH LOW NOx BURNER (LNB)

ALZETA TEST	NG	FT/PKG	0.84	RADIANT LNB			16/10**	49/9	9/9	0/17	82	40
ARMSTRONG IND., CA	NG	WT/PKG	12	LNB	R	100		NA/30	NA/0			41
B&W XCL-FM TEST	NG	WT/PKG	50	LNB		100		NA/60-70	<50			42
CA FATS & OILS	NG	WT/PKG	63	LNB	N			NA/75				34
CA VEG COMPANY	NG	FT/PKG	9.5	LNB	N	100	NA/4.5	NA/23	NA/1			33
COMMUNITY MEM HOSPITAL, CA	NG	FT/PKG	8	RADIANT LNB	R		17/12**	51/24	28/9		53	43
ERL, TAIWAN	NG	WT/PKG	10	LNB		100	NA/10-18**	NA/25-33				44
FT. KNOX	NG	FT/PKG	8.5	LNB	R	95	2/13	100/68	39/8		32	45
HALL CHEMICAL	NG	FT/PKG	3.3	RADIANT LNB	R		7/13**	68/15	856/30		78	40
HARVARD COGEN	NG	WT/PKG	225	LNB				NA/92				6

NOx EMISSIONS DATA - NATURAL GAS FIRED ICI BOILERS WITH COMBUSTION MODIFICATION NOx CONTROLS

BOILER ID	FUEL TYPE	BOILER TYPE	HEAT INPUT CAPACITY (MMBTU/HR)	CONTROL TYPE	NEW (N) OR RETROFIT (R)	LOAD (%)	UNCONTROLLED/CONTROLLED (%)	UNCONTROLLED/CONTROLLED EMISSIONS		AVERAGE NOx REDUCTION (%)	REF. NO.
								NOx (ppm@3XO2)*	CO (ppm@3XO2)		
IBM #3	NG	WT/PKG	45	113	R	93	NA/2.1	NA/84	NA/0	46	46
IBM #6	NG	WT/PKG	45	LNB	R	100		120/65		46	47
LUZ-SEGS II, CA	NG	WT/FE	380	LNB	R			NA/80			48
METRO STATE HOSPITAL, CA	NG	WT/PKG		LNB		20-80	NA/2-3	NA/40			49
MABISCO FOODS, CA	NG	FT/PKG	12.5	LNB	R	100	NA/3.0	NA/29	NA/3	NA/1.6	33
MABISCO FOODS, CA	NG	FT/PKG	10.6	LNB	R	100	NA/3.0	NA/30	NA/1	NA/2.2	33
O. L. S. ENERGY, CA	NG	WT/PKG	31	LNB	N	100	NA/3.5-4.9	NA/31-36	NA/64-117	NA/2.9-29	33
O. L. S. ENERGY, CA	NG	WT/PKG	31	LNB	N	100	NA/4.0	NA/30	NA/204	NA/22	33
PETER PAUL CADBURY	NG	FT/PKG	2	RADIANT LNB	R		20/7**	NA/17	342/30		40
PROCTOR & GAMBLE, WI	NG	WT/FE	365	LNB	N		NA/3.5	NA/142	NA/166		90****
ROCKWELL INTNL, CA	NG	FT/PKG	5	LNB	N	100	NA/7.9	NA/28	NA/15	NA/2.8	33
SUNKIST, CA	NG	WT/PKG	51	LNB	R			135/58			34
SAN JOAQUIN, CA	NG	WT/PKG	75	LNB	R			NA/58			34
UNNAMED #7	NG	WT/PKG	75	LNB		86	NA/4.3	NA/58	NA/744		38
UNNAMED #8	NG	WT/PKG	100	LNB	R	38		221/65 ***			8
VANDEBURG AFB	NG	FT/PKG	1.34	RADIANT LNB	N		55/10**		205/0		40
VA HOSPITAL, CA	NG	WT/PKG	55	LNB	R	100	NA/3.6	NA/108	NA/39		50
YORK SHIPLEY TEST	NG	FT/PKG	2	RADIANT LNB			15/10**		9/9		43
DEUTSCHE-BABCOCK	NG	WT/FE	100	LNB #1				230/140			56
DEUTSCHE-BABCOCK	NG	WT/FE	100	LNB #2				230/112			56

COMBINED LNB & FGR

AMERICAN COGEN, CA	NG	WT/PKG	136	LNB & FGR	R			NA/29			51
BMW XCL-FM TEST	NG	WT/PKG	50	LNB & FGR		100		NA/30			42
BOISE CASCADE, AL	NG	WT/PKG	205	LNB & FGR	N		NA/3.1	NA/33	NA/50		90****
CONTADINA FOODS, CA	NG	WT/PKG	150	LNB & FGR	N		NA/3.5	NA/32	NA/3		90****

NOx EMISSIONS DATA - NATURAL GAS FIRED ICI BOILERS WITH COMBUSTION MODIFICATION NOx CONTROLS

BOILER ID	FUEL TYPE	BOILER TYPE	HEAT INPUT CAPACITY (MMBtu/HR)	CONTROL TYPE	NEW (N) OR RETROFIT (R)	LOAD (%)	STACK O2		UNCONTROLLED/CONTROLLED EMISSIONS		AVERAGE NOx REDUCTION (%)	REF. NO.
							UNCONTROLLED (%)	CONTROLLED (%)	NOx (ppm@3XO2)*	CO (ppm@3XO2)		
ERL, TAIWAN	NG	WT/PKG	10	LNB & FGR		100	NA/4-8	5	NA/15-19		44	
				LNB & FGR		100	NA/5-9	10	NA/13-17			
GANGI BROS. CA	NG	WT/PKG	75	LNB & FGR	N		NA/2.0	27	NA/20	NA/40		90****
GANGI BROS. CA	NG	WT/PKG	150	LNB & FGR	N		NA/3.5	17	NA/24	NA/40		90****
GEN ELECTRIC, IN	NG	WT/PKG	200	LNB & FGR	N		NA/3.5	7	NA/75	NA/30		90****
HANFORD COGEN, CA	NG	WT/PKG	70	LNB & FGR	N		NA/2.8	20	NA/24	NA/6		90****
HENKEL CORP, CA	NG	WT/PKG	40	LNB & FGR	N		NA/3.3	17	NA/22	NA/15		90****
HUNTINGTON HOSP, CA	NG	WT/PKG	30	LNB & FGR	N		NA/2.8	NA	NA/35	NA/21		90****
IBM #3	NG	WT/PKG	45	LNB & FGR	R	80-95	NA/2.1	11.6-13	NA/30-36	NA/0-76		46
IBM #6	NG	WT/PKG	45	LNB & FGR	R	100		12.9-14	120/22-27			79
KWIKSET CORP, CA	NG	FT/PKG	17.6	LNB & FGR	N	100		NA	NA/29			33
HILLER BREWERY	NG	WT/PKG	60	LNB & FGR	R	100		NA	50-60/25	60-125/2		52
MISSION L'INEN, CA	NG	FT/PKG	10	LNB & FGR	N	100	NA/6.6	NA	NA/20	NA/89		33
ORANGE COUNTY #1	NG	WT/PKG	55	LNB & FGR	R	100		19.5	150/24	NA/50		53
ORANGE COUNTY #2	NG	WT/PKG	55	LNB & FGR	R	100		18	150/33	NA/5		53
ORANGE COUNTY #3	NG	WT/PKG	100	LNB & FGR	R	88		18	150/27	NA/97		53
QUALITY ASSURED PACKING, CA	NG	WT/PKG	40	LNB & FGR	R			4	NA/35			51
RAGU FOODS, CA	NG	WT/PKG	190	LNB & FGR	R			12	NA/35			51
RICHARD SHAW FOODS, CA	NG	FT/PKG	8.7	LNB & FGR	N	100	NA/4.1	NA	NA/28	NA/125	NA/22	33
SWEDLOW INC., CA	NG	FT/PKG	13.2	LNB & FGR		100		NA	NA/22	NA/11		33
UNNAMED, CIBO CASE D	NG	WT/PKG	90	LNB & FGR	R			NA	NA/28			54
US NAVY NCBC, CA	NG	FT/PKG	27.7	LNB & FGR	N	100		NA	NA/37	NA/135		33
VA HOSPITAL, CA	NG	WT/PKG	55	LNB & FGR	R	100	NA/3.5	13.3-13	NA/39	NA/33		50



NOx EMISSIONS DATA - NATURAL GAS FIRED ICI BOILERS WITH COMBUSTION MODIFICATION NOx CONTROLS

BOILER ID	FUEL TYPE	BOILER TYPE	HEAT INPUT CAPACITY (MMBtu/HR)	CONTROL TYPE	NEW (N) OR RETROFIT (R)	LOAD (%)	STACK O2 UNCONTROLLED/CONTROLLED (%)	UNCONTROLLED/CONTROLLED EMISSIONS		AVERAGE NOx REDUCTION (%)
								NOx (ppm@3XO2)*	CO (ppm@3XO2)	
STAGED COMBUSTION AIR (SCA)										
ECCC	NG	FT/PKG	12	SCA		71	1.9/2.9	70/67		5
KVB SITE 19	NG	WT/PKG	22	SCA	R	83	3.2/2.5	92/50		46
KVB SITE 38	NG	WT/PKG	56	SCA	R	89	2.5/2.4	170/116		32
#9-8C-1	NG	WT	60	SCA (BOOS)		77	3/3	240/200		17
#28-1	NG	WT	70	SCA (BOOS)		41	5.5/5.5	210/117		44
#32-1	NG	WT	120	SCA (BOOS)		50	4.4/4.4	205/150		27
DEUTSCHE-BARCOCK	NG	WT/FE	100	SCA (OFA)				230/119		37

OTHER COMBUSTION MOD COMBINATIONS

KVB SITE 19	NG	WT/PKG	22	SCA & FGR	R	83	3.2/2.5	92/22		76
DEUTSCHE-BARCOCK	NG	WT/FE	100	LNB #1 & SCA				230/100		56
DEUTSCHE-BARCOCK	NG	WT/FE	100	LNB #2 & SCA				230/82		64
GALLO, CA	NG	WT	140	LNB & SCA	N			NA/64	NA/100	48
TEMPLE INLAND FOREST PRODUCTS	NG	WT/FE	220	LNB, FGR & SCA LNB, FGR & SCA				NA	NA/117	6

WT: watertube; FT: firetube; PKG: packaged; FE: field erected  
 NA: no data available  
 \* To convert NOx to lb/MMBtu divide by 835.  
 \*\* total excess combustion air  
 \*\*\* Long term test data. All others are short term  
 \*\*\*\*Also tabulated in Coen Co. Installation List, Appendix C.

NOx EMISSIONS DATA - OIL FIRED ICI BOILERS WITH COMBUSTION MODIFICATION NOx CONTROLS											
BOILER ID	FUEL TYPE	BOILER TYPE	HEAT INPUT CAPACITY (MMBTU/HR)	CONTROL TYPE	NEW (N) OR RETROFIT (R)	LOAD (%)	STACK 02		UNCONTROLLED/CONTROLLED EMISSIONS AVERAGE		
							UNCONTROLLED/CONTROLLED (%)	FGR (%)	NOx (ppm@3xO2)*	CO (ppm@3xO2)	UHC (ppm@3xO2)
DISTILLATE-FIRED UNITS WITH FGR											
ALLIED SIGNAL, CA	DISTILLATE	FT/PKG	12.5	FGR		100	NA	NA/30	NA/74		31
ALLIED SIGNAL, CA	DISTILLATE	FT/PKG	6.3	FGR		100	NA	NA/33	NA/39		31
CA MILK PROD.	DISTILLATE	WT/PKG	60	FGR	N		NA	NA/119			34
FRIENDLY HILLS MEDICAL CENTER, CA	DISTILLATE	FT/PKG	21	FGR	R	100	NA	NA/28	NA/60		31
GAF BUILDING MATLS	DISTILLATE	WT/PKG	16.7	FGR		100	NA	NA/28	NA/186		31
HUGHES AIRCRAFT, CA	DISTILLATE	FT/PKG	8.4	FGR	R	100	NA	NA/34	NA/107		31
KAISER HOSPITAL	DISTILLATE	FT/PKG	14.6	FGR	R	100	NA	NA/36	NA/68		31
KAISER HOSPITAL	DISTILLATE	FT/PKG	8	FGR	N		NA	NA/126			34
KVB SITE 19	DISTILLATE	WT/PKG	22	FGR		83	3 2/3.1	28	110/35	4/46	68
LIBERTY VEG OIL, CA	DISTILLATE	FT/PKG	9.4	FGR		100	NA	NA/36	NA/49		31
L.A. DYE AND PRINT	DISTILLATE	FT/PKG	14.6	FGR		100	NA	NA/30			31
L.A. PAPER BOX	DISTILLATE	WT/PKG		FGR	R	100	NA	NA/37	NA/30		31
ST. JUDE MED CTR, CA	DISTILLATE	WT/PKG	10.5	FGR		100	NA	NA/37	NA/51		31
SCHOOL FOR DEAF, CA	DISTILLATE	FT/PKG	10.5	FGR	R	100	NA	NA/41	NA/69		31
UNIVERSAL HILTON, CA	DISTILLATE	FT/PKG	10.5	FGR		100	NA	NA/38	NA/149		31
VERDUGO HILLS HOSPITAL, CA	DISTILLATE	FT/PKG	10.5	FGR	R	100	NA	NA/34	NA/13		31
UNNAMED #5	DISTILLATE	WT/PKG	56	FGR		100	3.5/3.4	10	150/120	20/24	20
DISTILLATE-FIRED UNITS WITH LNB											
BBW XCL-FM TEST	DISTILLATE	WT/PKG	50	LNB		100			NA/60-65		42
CA FATS & OILS	DISTILLATE	WT/PKG	63	LNB	N				NA/119		34
FT KNOX	DISTILLATE	FT/PKG	8.5	LNB	R	100	3 9/3.7		142/120	6/13	15
IBM #3	DISTILLATE	WT/PKG	45	LNB	R				NA/99		46
IBM #6	DISTILLATE	WT/PKG	45	LNB	R				NA/85-102		47

NOx EMISSIONS DATA - OIL FIRED ICI BOILERS WITH COMBUSTION MODIFICATION NOx CONTROLS													
BOILER ID	FUEL TYPE	BOILER TYPE	HEAT INPUT CAPACITY (MMBTU/HR)	CONTROL TYPE	NEW (N) OR RETROFIT (R)	LOAD (%)	STACK O2		UNCONTROLLED/CONTROLLED EMISSIONS AVERAGE				
							UNCONTROLLED (%)	CONTROLLED (%)	NOx (ppm@3XO2)*	CO (ppm@3XO2)	UHC (ppm@3XO2)	NOx REDUCTION (%)	REF. NO.
-----													
SAN JOAQUIN COUNTY	DISTILLATE	WT/PKG	75	LNB	R					NA/87	NA/87	NA/87	34
UNNAMED #3	DISTILLATE	WT/PKG	75	LNB		84	NA/1.9	NA/87	NA/91	NA/87	NA/91	NA/87	38
VA HOSPITAL, CA	DISTILLATE	WT/PKG	55	LNB	R	100	NA/3.6	NA/100	NA/35	NA/100	NA/35	NA/100	50
-----													
DISTILLATE-FIRED UNITS WITH LNB & FGR													
BBW XCL-FM TEST	DISTILLATE	WT/PKG	50	LNB & FGR		100				NA/45	NA/45	NA/45	42
HENKEL CORP, CA	DISTILLATE	WT/PKG	40	LNB & FGR	N		NA/4.3	NA/20	NA/30	NA/20	NA/30	NA/20	90***
HUNTINGTON HOSP, CA	DISTILLATE	WT/PKG	30	LNB & FGR	N		NA/2.6	NA/35	NA/37	NA/35	NA/37	NA/35	90***
IBM #3	DISTILLATE	WT/PKG	45	LNB & FGR	R			14-21	NA/72-76	NA/72-76	NA/72-76	NA/72-76	46
IBM #6	DISTILLATE	WT/PKG	45	LNB & FGR	R			25-40	NA/43-50	NA/43-50	NA/43-50	NA/43-50	47
NORTHROP CORP	DISTILLATE	WT/PKG	22	LNB & FGR	N			NA	NA/103	NA/103	NA/103	NA/103	34
ORANGE COUNTY #1	DISTILLATE	WT/PKG	55	LNB & FGR	R	83		20.6	NA/31	NA/6.4	NA/6.4	NA/31	53
ORANGE COUNTY #2	DISTILLATE	WT/PKG	55	LNB & FGR	R	100		18	NA/35	NA/8	NA/8	NA/35	53
ORANGE COUNTY #3	DISTILLATE	WT/PKG	100	LNB & FGR	R	63		18	NA/36	NA/175	NA/175	NA/36	53
VA HOSPITAL, CA	DISTILLATE	WT/PKG	55	LNB & FGR	R	100	NA/3.5	13-15.6	NA/76-78	NA/31-33	NA/31-33	NA/76-78	50
-----													
DISTILLATE-FIRED UNITS WITH SCA													
KVB SITE 19	DISTILLATE	WT/PKG	22	SCA (OFA) FGR & SCA		83	3.2/3.1	110/77	30	110/77	110/77	110/77	55
-----													
RESIDUAL-FIRED UNITS WITH FGR													
ECCC	RESIDUAL	WT/PKG	31	FGR		67	4.4/4.5	7	130/125	20/20	20/20	130/125	4
	RESIDUAL	WT/PKG	22	FGR		67	4.4/2.0	19	130/91	10/145	10/145	130/91	30
KVB SITE 19	RESIDUAL	WT/PKG	22	FGR		83	3.2/3.1	NA	221/197	11	221/197	221/197	55

NOx EMISSIONS DATA - OIL FIRED ICI BOILERS WITH COMBUSTION MODIFICATION NOx CONTROLS

BOILER ID	FUEL TYPE	BOILER TYPE	HEAT INPUT (MMBTU/HR)	CONTROL TYPE	NEW (N) OR RETROFIT (R)	LOAD (%)	STACK O2		UNCONTROLLED/CONTROLLED EMISSIONS AVERAGE			
							UNCONTROLLED (%)	CONTROLLED (%)	NOx (ppm@3%O2)*	CO (ppm@3%O2)	UHC (ppm@3%O2)	NOx REDUCTION (%)
RESIDUAL-FIRED UNITS WITH LNB												
BMW XCL-FM TEST	RESIDUAL	WT/PKG	50	LNB	R	100			NA/200			42
KOBE STEEL (17 UNITS)	RESIDUAL	FT, WT	5-40	LNB	R				138-286/69-185			40 (30-60)
RESIDUAL-FIRED UNITS WITH SCA												
ECCC	RESIDUAL	FT/PKG	12	SCA (OFA)		50	NA/4.4		177/90			49 7
KVB SITE 19	RESIDUAL	WT/PKG	22	SCA (OFA)		83	3.2/3.1		221/157			29 55
KVB SITE 38	RESIDUAL	WT/PKG	56	SCA (OFA)		89	2.9/2.3		270/157			42 55
UNNAMED SITE 2	RESIDUAL	WT	110	SCA (BOOS)		67			235/181 **			23 8
#2-2	RESIDUAL	WT	59	SCA (BOOS)		80			668/568			12 7
#2-4	RESIDUAL	WT	65	SCA (BOOS)		78			505/455			10 7
#7-3	RESIDUAL	WT	85	SCA (BOOS)		58			350/270			24 7
#18-2	RESIDUAL	WT	90	SCA (BOOS)		67	7.4/8.2		254/180			29 7
#18-3	RESIDUAL	WT	105	SCA (BOOS)		72			245/234			5 7
#18-4	RESIDUAL	WT	160	SCA (BOOS)		74			244/173			29 7
#28-1	RESIDUAL	WT	70	SCA (BOOS)		41			205/188	0/100		8 19
#29-5	RESIDUAL	WT	150	SCA (BOOS)		47			294/177	0/20	35/35	40 19

RESIDUAL-FIRED UNITS WITH COMBINED COMBUSTION MODS

BMW XCL-FM TEST	RESIDUAL	WT/PKG	50	LNB & FGR		100			NA/180			42
KVB SITE 19	RESIDUAL	WT/PKG	22	FGR & SCA		83	3.2/3.1	NA	221/104			53 55
NY HOSPITAL, NY	RESIDUAL	WT/PKG	150	LNB & SCA	R				NA/175			51

WT: watertube; FT: firetube; PKG: packaged  
 LNB: low NOx burner; FGR: flue gas recirculation; SCA: staged combustion air  
 NA: no data available  
 \* To convert NOx to lb/MMBtu divide by 790.  
 \*\* Long term test data. All others are short term  
 \*\*\* Also tabulated in Coen Co. Installation List, Appendix C.

NOx EMISSION DATA - GAS/OIL FIRED TEOR STEAM GENERATORS

BOILER ID	FUEL TYPE	BOILER TYPE	HEAT INPUT CAPACITY (MMBTU/HR)	CONTROL TYPE	NEW (N) OR RETROFIT (R)	FGR (%)	UNCONTROLLED/CONTROLLED EMISSIONS			AVERAGE NOx REDUCTION (%)	REF. NO.
							NOx (ppm@3XO2)*	CO (ppm@3XO2)	UHC (ppm@3XO2)		
EPA TEST	CRUDE OIL	TEOR	62.5	LNB (R)			300/110			63	58
GETTY OIL UNIT HSG172	CRUDE OIL	TEOR	62.5	SCA (R) SNCR (R)			300/155 300/86 300/60		NA/12-24	48 71 80	59
STANDARD OIL UNIT 50-1	CRUDE OIL	TEOR	62.5	LNB			368/359		4 2/5 2	2	60, 61
GRACE PETROLEUM	N. GAS	TEOR	25	FGR (R)	NA	NA	35-40/20-25			40	62
MOBIL OIL	N. GAS	TEOR	62.5	LNB (R) LNB & FGR (R)	10-12		100/70-75 100/30-35	NA/0.3 NA/0.3	NA/3 NA/3	28 68	48
MOBIL OIL	N. GAS/ REF. GAS	TEOR	62.5	LNB (R) LNB & FGR (R) LNB & FGR (R)	3 8		NA/42 NA/35 NA/25	NA/0.3 NA/0.3 NA/0.3	NA/1 NA/1 NA/1		63
UNNAMED	N. GAS	TEOR	62.5	LNB LNB & FGR	NA		60/55 60/30			8 50	64

TEOR: thermally enhanced oil recovery  
 SCA: staged combustion air; SNCR: selective non-catalytic reduction; LNB: low NOx burner; FGR: flue gas recirculation  
 NA: no data available  
 \* To convert NOx to lb/MMBtu, divide by 835 for natural gas fuel, 790 for oil fuel.  
 Note: all are short term test data.

KERN COUNTY, CA APCD DATA (REF. NO. 65) - CRUDE OIL FIRED TEOR STEAM GENERATORS

NOx CONTROL TYPE	UNITS < 35 MMBTU/HR INPUT:		UNITS 35 - 62.5 MMBTU/HR INPUT:	
	NUMBER OF TESTS	MEAN NOx EMISSIONS (ppm@3XO2)*	NUMBER OF TESTS	MEAN NOx EMISSIONS (ppm@3XO2)*
02 TRIM	71	280	326	250
FGR, 02 TRIM	39	60	245	23
LNB (SCA), 02 TRIM	4	188	32	125
SNCR, 02 TRIM	1	23	26	44
	0		134	122
	0		113	25
	0		38	105
	0		37	37

FGR: flue gas recirculation; LNB: low NOx burner; SCA: staged combustion air  
 SNCR: selective non-catalytic reduction  
 \* To convert NOx to lb/MMBtu divide by 790.

NOX EMISSIONS DATA - NONFOSSIL FUEL FIRED ICI BOILERS WITH COMBUSTION MODIFICATION NOX CONTROL

BOILER ID	FUEL TYPE	BOILER TYPE	HEAT INPUT CAPACITY (MMBTU/HR)	CONTROL TYPE	NEW (N) OR RETROFIT (R)	AVERAGE LOAD (%)	STACK O2 UNCONTROLLED/CONTROLLED (%)	UNCONTROLLED/CONTROLLED EMISSIONS			AVERAGE NOx REDUCTION (%)	REF. NO.
								NOx (ppm@3%O2)*	CO (ppm@3%O2)	UHC (ppm@3%O2)		
KWB SITE 10/1	WOOD/N. GAS	OFS	250	SCA-BOOS (R)***				229/183			20	55
MSW FACILITY, OLMSTEAD COUNTY, NH	MSW	WT/OFS	45	FGR ONLY			76/54**	234/140	92/94		40	66
				FGR WITH N. GAS REBURN		100	76/41**	234/96	92/42		59	
RILEY/TAKUMA MASS BURN PILOT	MSW	OFS	3	FGR WITH N. GAS REBURN		80	70/31**	284/146	54/52	0/2	49	67, 68

OFS: overfeed stoker; WT: wastetube; WF: wall fired  
 SCA: staged combustion air; FGR: flue gas recirculation  
 MSW: municipal solid waste  
 \* To convert NOx to lb/MMBtu divide by 710 for wood fuel, 705 for MSW  
 \*\* Total excess combustion air  
 \*\*\* Combustion modifications to auxiliary gas burners only.  
 Note: all are short term test data.

NOx EMISSIONS DATA - ICI BOILERS WITH FLUE GAS TREATMENT NOx CONTROLS: SNCR											
BOILER ID	FUEL TYPE	BOILER TYPE	HEAT INPUT CAPACITY (MMBTU/HR)	CONTROL TYPE	UNCONTROLLED/CONTROLLED NOx (ppm@3%O2)*	AVERAGE NOx REDUCTION (%)	AMMONIA SLIP (ppm@3%O2)	REF. NO.	CONTROL TYPE		
									NEW (N) OR RETROFIT (R)	NOx (ppm@3%O2)	CO (ppm@3%O2)
<b>OIL/GAS-FIRED UNITS:</b>											
ESSO A.G. #5, GERMANY	NG	WALL	87 MWe	SNCR AMMONIA (R)	394/160	60	69	69			
EXXON, CA	NG	VERT CYL FURNACE	200	LNB & SNCR AMMONIA (N)	90/25	72	70	70			
INDUSTRIAL UNIT, JAPAN	OIL		90	SNCR UREA (R)	120-140/60-70	50	71	71			
<b>COAL-FIRED UNITS:</b>											
WEPCO VALLEY #4	COAL	WT/WALL	800	SNCR UREA	984/300	69	77	77			
UNNAMED	BITUM	WT/SW	50 (MWe)	SNCR UREA	650/110	83	76	76			
N. AMERICAN CHEM CORP TRONA, CA	BITUM	TANG	2x75 MWe	SNCR UREA	200/140	30***	74	74			
FORMOSA PLASTICS	COAL	WT/WALL	331	SNCR UREA	200/80	60	91	91			
ULTRASYSTEMS, VA	COAL	STKR	2x383	SNCR AMMONIA (N)	296/110	50-65	89	89			
ULTRASYSTEMS, VA	COAL	STKR	2x380	SNCR AMMONIA (N)	300/132	54-66	89	89			
COGENERIX, VA	COAL	STKR	8x28MWe	SNCR UREA	350/200	40	91	91			
TEKWISKAVERKEN	COAL	STKR	275	SNCR UREA	300-350/100-125	65	91	91			
UNNAMED	COAL	CFBC	1.4	SNCR UREA	90-135/39	65	76	76			
MICHIGAN ST UNIV	COAL	CFBC	460	SNCR UREA	247/106	57***	74	74			
CORN PRODUCTS, CA	BITUM	CFBC	580	SNCR AMMONIA (N)	300/65	78	72	72			
UNNAMED	BITUM	CFBC	12 (MWe)	SNCR UREA	175/21	88	76	76			
JASMIN, CA	COAL	CFBC	500	SNCR AMMONIA (N)	150/30	80	73	73			
POSO	BITUM	CFBC	500	SNCR AMMONIA (N)	150/30	80	73	73			
RIO BRAVO, CA	COAL	CFBC	394	SNCR AMMONIA (N)	220/53	76	75	75			
UNNAMED	BITUM	CFBC	2.6	SNCR UREA	150/50	67	76	76			

NOx EMISSIONS DATA - ICI BOILERS WITH FLUE GAS TREATMENT NOx CONTROLS: SNCR

BOILER ID	FUEL TYPE	BOILER TYPE	HEAT INPUT CAPACITY (MMBTU/HR)	CONTROL TYPE	UNCONTROLLED/CONTROLLED		AVERAGE NOx REDUCTION (%)	AMMONIA SLIP (ppm@3X02)	REF. NO.
					NOx (ppm@3X02)*	CO (ppm@3X02)			
WOOD/BIO MASS-FIRED UNITS:									
ALTERNATIVE ENERGY, MI	WOOD	STKR	500	SNCR UREA	128/64		50***	<40	74
BLACK & VEATCH, MI	WOOD WASTE	STKR	440	SNCR UREA	150/60		60***	<27	74
BOISE CASCADE, NH	BARK/N. GAS	STKR	395	SNCR UREA	85-125/80		25***	<20	74
BRAWLEY	WOOD	STKR	315	SNCR AMMONIA (N)	400/160		60		73
BURNEY	WOOD	STKR	300	SNCR AMMONIA (N)	116/56		52		73
CHINESE STATION, CA	WOOD	BFBC	250	SNCR AMMONIA (N)	250/140 250/50-90	<--NH3/NO=2.1 <--NH3/NO=4.0	44 72		78
CHINESE STATION, CA	WOOD	STKR	390	SNCR AMMONIA (N)	125/25		80		73
FRESNO, CA	WOOD	CFBC	440	SNCR AMMONIA (N)	120/29		76		73
GARDEN STATE PAPER	PAPER	PKG WT	72	SNCR UREA	355/178		50***	<10	74
GARDEN STATE PAPER	FIBER WASTE	PKG WT	172	SNCR UREA	374/167		50***	<10	74
KENETECH ENERGY, MA	WOOD	STKR	225	SNCR UREA	210/111		47***	<10	74
LFC, MI	WOOD	STKR	190	SNCR UREA	170/110		35***	<20	74
LONG BEACH, CA	WOOD	STKR	270	SNCR AMMONIA (N)	325/130		60		73
MALAGA COGEN, CA	WOOD WASTE	CFBC	380	SNCR AMMONIA	126/43	10/10	66		75
MENDOTA, CA	WOOD	CFBC	435	SNCR AMMONIA (N)	120/24		80		73
RYEGATE POWER, VT	WOOD	STKR	300	SNCR UREA	210/105		50***	<40	74
S.D. WARREN, ME	OIL/BIO MASS	STKR	900	SNCR UREA	235/118		50***	<20	74
SACRAMENTO, CA	WOOD	STKR	220	SNCR AMMONIA (N)	220/90		59		73
SHASTA, CA	WOOD	STKR	375	SNCR AMMONIA (R)	90/45		50		73
SERRA PACIFIC, CA	WOOD WASTE	CELL	2x 130	SNCR UREA	200/96		52***	<20	74
SUSANVILLE, CA	WOOD	STKR	480	SNCR UREA	140/67		52***	<30	74
SUSANVILLE, CA	WOOD	STKR	625	SNCR AMMONIA (N)	130/55		58		73
TERRA BELLA, CA	WOOD	STKR	210	SNCR AMMONIA (R)	100/50		50		73
TRACY, CA	WOOD	STKR	350	SNCR AMMONIA (N)	310/78		75		73
ULTRA SYSTEMS, CA	WOOD	CFBC	280	SNCR UREA	150/45		70***	<10	74



NOx EMISSIONS DATA - ICI BOILERS WITH FLUE GAS TREATMENT NOx CONTROLS: SNCR											
BOILER ID	FUEL TYPE	BOILER TYPE	HEAT INPUT CAPACITY (MMBTU/HR)	CONTROL TYPE	NEW (N) OR RETROFIT (R)	UNCONTROLLED/CONTROLLED		AVERAGE NOx REDUCTION (%)	AMMONIA SLIP (ppm@3%O2)	REF. NO.	
						NOx (ppm@3%O2)*	CO (ppm@3%O2)				
UNNAMED	WOOD	CFBC	3.4	SNCR UREA		125/50		60		76	
WOODLAND	WOOD	CFBC	415	SNCR AMMONIA (N)		120/29		76		73	
MSW-FIRED UNITS:											
BASEL, SWITZERLAND	MSW	MB	125	STAGED SNCR UREA (R)		290/58-142	9-18 ABOVE BASELINE	66		79	
BERLIN (7 UNITS), GERMANY	MSW	STKR		SNCR UREA		160/50		69***	<25	74	
BREMERHAVEN, GERMANY	MSW	MB		SNCR AMMONIA (R)		225/48		79		80	
COMMERCE, CA	MSW	MB/OFS	190	SNCR AMMONIA (N)		225/116	NA/20	48		81	
EMMENSPIITZ, SWITZERLAND	MSW	STKR	121	SNCR UREA		200/64		68***	<10	74	
FOSTER WHEELER, SC	MSW	STKR	138	SNCR UREA		110/44		60***	<10	74	
FRANKFURT, GERMANY	MSW	MB/OFS	115	SNCR UREA (R)		362/90	9 ABOVE BASE	75	22****	82	
FRANKFURT (4 UNITS), GERMANY	MSW	STKR	660	SNCR UREA		170/51		70***	17	74	
HAM (4 UNITS), GERMANY	MSW	STKR	528	SNCR UREA		170/100		41***	<5	74	
HERTEN (2 UNITS), GERMANY	MSW	STKR	242	SNCR UREA		185/74		60***	<7	74	
LONG BEACH, CA	MSW	MB		SNCR AMMONIA, FGR (W)		NA/120				80	
MILLBURY, MA	MSW	MB/OFS	325	SNCR UREA (R)		310/125	12 ABOVE BASE	60	12	82	
NEW HANOVER COUNTY, NC	MSW	MB	108	SNCR UREA		300/120		60***	<15	74	
SEMASS, MA	MSW	STKR	375	SNCR UREA		220/110		50***	<20	74	
STANISLAUS, CA #1	MSW			SNCR AMMONIA (N)		380/120		68		80	
STANISLAUS, CA #2	MSW			SNCR AMMONIA (N)		390/145		63		80	
SWITZERLAND	MSW	OFS	80	SNCR UREA (R)		500/210	9 ABOVE BASE	58	22****	82	
UNNAMED	MSW	OFS	15 (MWe)	SNCR UREA		200/64		68		76	

NOx EMISSIONS DATA - ICI BOILERS WITH FLUE GAS TREATMENT NOx CONTROLS: SNCR

BOILER ID	FUEL TYPE	BOILER TYPE	HEAT INPUT CAPACITY (MMBTU/HR)	CONTROL TYPE		UNCONTROLLED/CONTROLLED		AVERAGE NOx REDUCTION (%)	AMMONIA SLIP (ppm@3%O2)	REF. NO.
				NEW (N)	OR RETROFIT (R)	NOx (ppm@3%O2)*	CO (ppm@3%O2)			

WT: watertube; PKG: packaged; SW: single wall-fired; CFBC: circulating FBC; BFBC: bubbling FBC; STKR: stoker; MB: mass burn; OFS: overfeed stoker  
 SNCR: selective non-catalytic reduction (ammonia based unless noted as urea); LNB: low NOx burner; SCA: staged combustion air; FGR: flue gas recirculation  
 NA: no data available  
 \* To convert NOx to lb/MMBtu divide by the following: coal-740, gas-835, oil-740; wood-710; MSW-705.  
 \*\* Total excess combustion air  
 \*\*\* According to vendor, reduction to meet unit's permitted emission level, not necessarily lowest achievable  
 \*\*\*\* Chemical enhancers used to reduce ammonia slip to levels indicated  
 Note: All are short term test data.

NOx EMISSIONS DATA - ICI BOILERS WITH FLUE GAS TREATMENT NOx CONTROLS: SCR

BOILER ID	FUEL TYPE	BOILER TYPE	HEAT INPUT CAPACITY (MMBTU/HR)	CONTROL TYPE		UNCONTROLLED/CONTROLLED NOx (ppm@3%O2)*	AVERAGE NOx REDUCTION (%)	REF. NO.
				NEW (N) OR RETROFIT (R)	NOx CO			
CHEMICAL CO**	OIL		750	SCR (R)		250/25	90	83
CHEMICAL CO**	OIL		240	SCR (R)		167/17	90	83
PETROLEUM CO**	OIL		125	SCR (R)		160/24	85	83
PETROLEUM CO**	OIL		240	SCR (R)		188/18.8	90	83
PETROLEUM CO**	OIL		240	SCR (R)		188/18.8	90	83
PETROLEUM CO**	OIL		300	SCR (R)		188/18.8	90	83
AICHI REFINERY, JAPAN	PULV COAL		270	SCR (N)		265/110	58	84
WAKAMATSU DEMO PLANT, JAPAN	COAL "A" COAL "B" COAL "C" COAL "D"	BFBC	300	SCR		206/96 210/80 194/72 167/73	53 62 63 56	85
TOSCO REFINERY, CA	NG	VERT CYL FURNACE	160	SCR (N)		85/40	53	70
WESTINGHOUSE, CA	NG	WT/PKG	330	SCA, FGR, O2		NA/40	NA/67	86
				SCA, FGR, O2 W/SCR (N)		NA/10		87
WILLAMETTE IND., CA	NG	WT	75	SCR (N)		228/46	80	83
CHEMICAL CO**	REF. GAS		75	SCR (R)		70/10	86	83
CHEVRON EL SEGUNDO	REF. GAS		310	SCR (N)		100/9	91	88
IWATSUKI, JAPAN	H2W			SCR (N)		77/36	53	80

BFBC: Bubbling Fluidized bed combustor; WT: watertube; PKG: packaged  
 SCR: selective catalytic reduction; SCA: staged combustion air; FGR: flue gas recirculation; O2: O2 trim  
 NA: no data available  
 \* To convert NOx to lb/MMBtu divide by the following factors: coal-740; gas-835; oil-790.  
 \*\* Not located in the U.S.  
 Note: all are short term test data.

## REFERENCES FOR APPENDIX B

1. Vatsky, J. (Foster Wheeler Energy Corporation). NO<sub>x</sub> Control: The Foster Wheeler Approach. Proceedings: 1989 Symposium on Stationary Combustion NO<sub>x</sub> Control. Publication No. EPRI GS-6423. U.S. Environmental Protection Agency/ Electric Power Research Institute. Palo Alto, CA. July 1989.
2. Vatsky, J., and E. S. Schindler (Foster Wheeler Energy Corporation). Industrial and Utility Boiler Low NO<sub>x</sub> Control Update. Proceedings: 1987 Symposium on Stationary Combustion NO<sub>x</sub> Control. Publication No. EPRI CS-5361. U.S. Environmental Protection Agency/Electric Power Research Institute. Palo Alto, CA. August 1987.
3. Vatsky, J., and T. W. Sweeney. Development of an Ultra-Low NO<sub>x</sub> Pulverized Coal Burner. Foster Wheeler Energy Corporation. Clinton, NJ. Presented at the 1991 Joint Symposium on Stationary Combustion NO<sub>x</sub> Control—EPA/EPRI. Washington, D.C. March 25-28, 1991.
4. Buchs, R.A., et al. (Kerr-McGee Chemical Corporation). Results From a Commercial Installation of Low NO<sub>x</sub> Concentric Firing System (LNCFS). ABB Combustion Engineering Services, Inc. Windsor, CT. 1991.
5. Schild, V., et al. (Black Hills Power and Light Co.). Western Coal-Fired Boiler Retrofit for Emissions Control and Efficiency Improvement. Technical Paper No. 91-JPGC-FACT-7. American Society of Mechanical Engineers. New York, NY. 1991.
6. Letter for Leblanc, B., Riley Stoker Corp., to Sanderford, E., MRI. NO<sub>x</sub> Emissions from Utility and Industrial Boilers. April 15, 1992.
7. Lim, K. J., et al. (Acurex Corp.) Industrial Boiler Combustion Modification NO<sub>x</sub> Controls—Volume I, Environmental Assessment. Publication No. EPA-600/7-81-126a. U.S. Environmental Protection Agency. Research Triangle Park, NC. July 1981.
8. Carter, W. A. Thirty Day Field Tests of Industrial Boiler Combustion Modifications. KVB Inc. Irvine, CA. Proceedings of the Joint Symposium on Stationary Combustion NO<sub>x</sub> Control. Publication No. IERL-RTP-1085. U.S. Environmental Protection Agency. Research Triangle Park, NC. October 1980.
9. Narita, T., et al. (Babcock Hitachi K.K.). Development of the Low NO<sub>x</sub> Burner For the Pulverized Coal Fired In-Furnace NO<sub>x</sub> Reduction System. Proceedings: 1985 Symposium on Stationary Combustion NO<sub>x</sub> Control. Publication No. EPRI CS-4360. U.S. Environmental Protection Agency/Electric Power Research Institute. Palo Alto, CA. January 1986.
10. Penterson, C.A. (Riley Stoker Corp.) Controlling NO<sub>x</sub> Emissions to Meet the 1990 Clean Air Act. Technical Paper No. 91-JPGC-FACT-11. American Society of Mechanical Engineers. New York, NY. 1991.

11. Folsom, B., et al. (Energy and Environmental Research Corporation). Field Evaluation of the Distributed Mixing Burner. Proceedings: 1985 Symposium on Stationary Combustion NO<sub>x</sub> Control. Publication No. EPRI CS-4360. U.S. Environmental Protection Agency/Electric Power Research Institute. Palo Alto, CA. January 1986.
12. Farzan, H., et al. (Babcock & Wilcox Company). Pilot Evaluation of Reburning for Cyclone Boiler NO<sub>x</sub> Control. Proceedings: 1989 Symposium on Stationary Combustion NO<sub>x</sub> Control. Publication No. EPRI GS-6423. U.S. Environmental Protection Agency/ Electric Power Research Institute. Palo Alto, CA. July 1989.
13. Okigami, N., et al. (Hitachi Zosen Corporation). Three-Stage Pulverized Coal Combustion System for In-Furnace NO<sub>x</sub> Reduction. Proceedings: 1985 Symposium on Stationary Combustion NO<sub>x</sub> Control. Publication No. EPRI CS-4360. U.S. Environmental Protection Agency/Electric Power Research Institute. Palo Alto, CA. January 1986.
14. Araoka, M., et al. (Mitsubishi Heavy Industries, Inc.). Application of Mitsubishi "Advanced MACT" In-Furnace NO<sub>x</sub> Removal Process at Taio Paper Co., Ltd. Mishima Mill No. 118 Boiler. Proceedings: 1987 Symposium on Stationary Combustion NO<sub>x</sub> Control. Publication No. EPRI CS-5361. U.S. Environmental Protection Agency/Electric Power Research Institute. Palo Alto, CA. August 1987.
15. Goldberg, P. M., and E. B. Higginbotham. Field Testing of an Industrial Stoker Coal-Fired Boiler—Effects of Combustion Modification NO<sub>x</sub> Control on Emissions—Site A. Report No. TR-79-25/EE. Acurex Corporation. Mountain View, CA. August 1979.
16. Langsjoen, P. L., et al. (KVB, Inc.). Field Tests of Industrial Stoker Coal-Fired Boilers for Emissions Control and Efficiency Improvement—Site C. Publication No. EPA-600/ 7-79-130a. Prepared for the U.S. Environmental Protection Agency, U.S. Department of Energy, and the American Boiler Manufacturers Association. Washington, D.C. May 1979.
17. Gabrielson, J. E., et al. (KVB, Inc.). Field Tests of Industrial Stoker Coal-Fired Boilers for Emissions Control and Efficiency Improvement—Site D. Publication No. EPA-600/ 7-79-237a. Prepared for the U.S. Environmental Protection Agency, U.S. Department of Energy, and the American Boiler Manufacturers Association. Washington, D.C. November 1979.
18. Langsjoen, P. L., et al. (KVB, Inc.). Field Tests of Industrial Stoker Coal-Fired Boilers for Emissions Control and Efficiency Improvement—Site F. Publication No. EPA-600/ 7-80-065a. Prepared for the U.S. Environmental Protection Agency, U.S. Department of Energy, and the American Boiler Manufacturers Association. Washington, D.C. March 1980.
19. Cato, G. A., et al. (KVB Inc). Field Testing: Application of Combustion Modifications to Control Pollutant Emissions from Industrial Boilers—Phase II. Publication No. EPA-600/2-72-086a. Prepared for the U.S. Environmental Protection Agency. Research Triangle Park, NC. April 1976.

20. Maloney, K. L., et al (KVB, Inc.). Low-sulfur Western Coal Use in Existing Small and Intermediate Size Boilers. Publication No. EPA-600/7-78-153a. Prepared for the U.S. Environmental Protection Agency. Research Triangle Park, NC. July 1978.
21. Maloney, K. L. (KVB, Inc.). Combustion Modifications for Coal-Fired Stoker Boilers. Proceedings of the 1982 Joint Symposium on Stationary Combustion NO<sub>x</sub> Control. Publication No. EPRI CS-3182. U.S. Environmental Protection Agency/Electric Power Research Institute. Palo Alto, CA. July 1983.
22. Quartucy, G. C., et al. (KVB, Inc.). Combustion Modification Techniques for Coal-Fired Stoker Boilers. Proceedings: 1985 Symposium on Stationary Combustion NO<sub>x</sub> Control. Publication No. EPRI CS-4360. U.S. Environmental Protection Agency/Electric Power Research Institute. Palo Alto, CA. January 1986.
23. Hiltunen, M., and J. T. Tang. NO<sub>x</sub> Abatement in Ahlstrom Pyroflow Circulating Fluidized Bed Boilers. Ahlstrom Pyropower Corp. Finland.
24. Linneman, R. C. (B. F. Goodrich Chemical). B. F. Goodrich's FBC experience. Proceedings: 1988 Seminar on Fluidized Bed Combustion Technology for Utility Opns. Publication No. EPRI GS-6118. Electric Power Research Institute. Palo Alto, CA. February 1989.
25. Leckner, B., and L. E. Anand (Chalmers University, Sweden). Emissions from a Circulating and Stationary Fluidized Bed Boiler: A Comparison. Proceedings of the 1987 International Conference on Fluidized Bed Combustion. The American Society of Mechanical Engineers/Electric Power Research Institute/Tennessee Valley Authority. New York, NY. 1987.
26. Jones, O. Initial Operation of Conoco's South Texas Fluidized Bed Combustor. Conoco, Inc. Houston, TX. Presented at the 10th Energy Technology Conference.
27. Sadowski, R. S., and A. F. Wormser (Wormser Engineering, Inc.). Operating Experience with a Coal-Fired Two-Stage Fluidized Bed Combustor in an Industrial Plant Setting. Proceedings of the American Power Conference. Volume 45. 1983.
28. Bijvoet, U. H. C., et al. (TNO Organization for Applied Scientific Research). The Characterization of Coal and Staged Combustion in the TNO 4-MWth AFBB Research Facility. Proceedings of the 1989 International Conference on Fluidized Bed Combustion. The American Society of Mechanical Engineers/Electric Power Research Institute/Tennessee Valley Authority. New York, NY. 1989.
29. Hasegawa, T., et al. (Mitsubishi Heavy Industries, Ltd.). Application of AFBC to Very Low NO<sub>x</sub> Coal Fired Industrial Boiler. Proceedings of the 1989 International Conference on Fluidized Bed Combustion. The American Society of Mechanical Engineers/Electric Power Research Institute/Tennessee Valley Authority. New York, NY. 1989.

30. Letter from Coffey, A., Cleaver Brooks, to Herbert, E. L., Herbert & Conway, Inc. Cleaver Brooks FGR Experience. September 14, 1992.
31. Memorandum from Sanderford E., MRI, to Neuffer, W.; U.S. EPA. Data for Southern California Low-NO<sub>x</sub> Applications. Attachment 4. February 18, 1992.
32. Memorandum from Votlucka, P., South Coast Air Quality Management District, to File/Rule 1146. Proposed Rule 1146—Trip to Beverly Hills Hilton to Inspect the Boiler Room. February 1987.
33. Memorandum from Sanderford E., MRI to Neuffer, W., U.S. EPA. Data for Southern California Low-NO<sub>x</sub> Applications. Attachment 6. February 18, 1992.
34. Statewide Technical Review Group. Technical Support Document for Suggested Control Measure for the Control of Emissions of Oxides of Nitrogen from Industrial, Institutional, and Commercial Boilers, Steam Generators, and Process Heaters. California Air Resources Board and the South Coast Air Quality Management District. Sacramento, CA. April 29, 1987.
35. Letter from Cluer, A. L., Clayton Industries, to Votlucka, P., South Coast Air Quality Management District. Results from Boiler Manufacturer's Test of a Gas-Fired Boiler With and Without FGR. October 14, 1987.
36. Cleaver Brooks Division. NO<sub>x</sub> versus Recirculation Rate—200 hp Gas Firing—R&D Lab Tests. December 1987.
37. Cleaver Brooks Division. NO<sub>x</sub> versus Recirculation Rate—350 hp Gas Firing—R&D Lab Tests. December 1987.
38. Office of Air Quality Planning and Standards. Overview of the Regulatory Baseline, Technical Basis, and Alternative Control Levels for Nitrogen Oxides (NO<sub>x</sub>) Emissions Standards for Small Steam Generating Units. Publication No. EPA-450/3-89-13. U.S. Environmental Protection Agency. Research Triangle Park, NC. May 1989.
39. Letter and attachments from Stoll, F. R., Hugh Dean & Co., Inc., to Briggs, A., Acurex Environmental. Cleaver-Brooks FGR. April 5, 1993.
40. Kesselring, J. P., and W. V. Krill (Alzeta Corporation). A Low-NO<sub>x</sub> Burner for Gas-Fired Firetube Boilers. Proceedings: 1985 Symposium on Stationary Combustion NO<sub>x</sub> Control. Publication No. EPRI CS-4360. U.S. Environmental Protection Agency/Electric Power Research Institute. Palo Alto, CA. January 1986.
41. Roman, V. (KVB, Inc.). Compliance Test Report: Oxides of Nitrogen and Carbon Monoxide Emissions from Primary Boiler—Source Location: Armstrong World Industries South Gate, CA. Submitted to the South Coast Air Quality Management District, El Monte, CA. September 28, 1990.

42. LaRue, A. (Babcock & Wilcox). The XCL Burner—Latest Developments and Operating Experience. Proceedings: 1989 Symposium on Stationary Combustion NO<sub>x</sub> Control. Publication No. EPRI GS-6423. U.S. Environmental Protection Agency/Electric Power Research Institute. Palo Alto, CA. July 1989.
43. Field Test Update: Ceramic Fiber Burner for Firetube Boilers. Gas Research Institute. Chicago, IL. August 1987.
44. Yang, S. C., et al. Development of Low NO<sub>x</sub> Gas Burners. Energy and Resources Laboratories (ERL), Industrial Technology Research Institute. Taiwan. Presented at the 1991 Joint Symposium on Stationary Combustion NO<sub>x</sub> Control—EPA/EPRI. Washington, D.C. March 25-28, 1991.
45. Potts, N. L., and M. J. Savoie (U.S. Army Construction Engineering Research Laboratory). Low NO<sub>x</sub> Burner Retrofits: Case Studies. Technical Paper No. 91-10.22. Air and Waste Management Association. Pittsburgh, PA. June 1991.
46. Buening, H. J. (KVB, Inc.). Testing of Low-NO<sub>x</sub> Combustion Retrofit—Boiler No. 3. Report No. KVB71-60451-2008. Prepared for IBM, Inc., San Jose, CA. January 1985.
47. Larsen, L. L., and W. A. Carter (KVB, Inc.). Testing of Low-NO<sub>x</sub> Combustion Retrofit—Boiler No. 6. Report No. KVB71-60412-2067. Prepared for IBM, Inc., San Jose, CA. August 1983.
48. Londerville, S. B., and J. H. White (Coen Company). Coen Company Overview and Burner Design developments for NO<sub>x</sub> Control. Proceedings: Third Annual NO<sub>x</sub> Control Conference. Council of Industrial Boiler Owners. Burke, VA. February 1990.
49. Technical memorandum from Woodward, R., Hague International. Results of Emissions Testing of Low-NO<sub>x</sub> Burner Installed in Hospital Boiler. January 1988.
50. Buening, H. J. (KVB, Inc.). Testing of Low-NO<sub>x</sub> Combustion Retrofit—VA Hospital—Los Angeles Boiler No. 4. Report No. KVB71-72760-2130. Prepared for Keeler-Dorr-Oliver. Williamsport, PA. May 1987.
51. Letter and attachments from DeHaan, T., Coen Co., Inc., to Seu, S., Acurex Environmental Corp., Low-NO<sub>x</sub> Retrofits. February 6, 1992.
52. Roman, V. (KVB, Inc.). Compliance Test Report: Oxides of Nitrogen and Carbon Monoxide Emissions from Primary Boiler—Source Location: Miller Brewing Company, Irwindale, CA. Submitted to the South Coast Air Quality Management District, El Monte, CA. August 13, 1990.
53. County of Orange Central Utility Facility NO<sub>x</sub> and CO Emission Results. Coen Company. Distributed at the Fifth Annual CIBO NO<sub>x</sub> Control Conference. Long Beach, CA. February 10, 1992.



54. Letter and attachments for Marx, W., CIBO, to Seu, S., Acurex Environmental Corporation. NO<sub>x</sub> Control Technology Survey. June 12, 1992.
55. Hunter, S. C., et al. Application of Combustion Modifications to Industrial Combustion Equipment. KVB, Inc., Irvine, CA. 1977.
56. Oppenberg, R. Primary Measures Reducing NO<sub>x</sub> Levels in Oil- and Gas-Fired Water Tube Boilers. Report No. 176. Deutsche-Babcock. Germany. September 1986.
57. Suzuki, T., et al. (Kobe Steel). Development of Low-NO<sub>x</sub> Combustion for Industrial Application. Proceedings: 1985 Symposium on Stationary Combustion NO<sub>x</sub> Control. Publication No. EPRI CS-4360. U.S. Environmental Protection Agency/Electric Power Research Institute. Palo Alto, CA. January 1986.
58. Castaldini, C., et al. (Acurex Corp.). Environmental Assessment of an Enhanced Oil Recovery Steam Generator Equipped with a Low NO<sub>x</sub> Burner. Acurex Report No. TR-84-161/EE. Prepared for the U.S. Environmental Protection Agency. Research Triangle Park, NC. January 1985.
59. McDannel, M. D., and T. D. Guth (KVB, Inc.). NO<sub>x</sub> Control Technology Applicable to Oil Field Steam Generators. Report No. KVB71 42000-1694. Prepared for Getty Oil Company. Bakersfield, CA. March 1983.
60. Steiner, J., et al. Oil Field Steam Generator Emission Testing, Taft, California—Baseline Tests: Section 26-C, Unit 50-1. Report No. TR-79-175. Acurex Corporation. Mountain View, CA. May 1979.
61. Steiner, J., and R. Pape. Oil Field Steam Generator Emission Testing, Taft, California—Prototype Low NO<sub>x</sub> Burner Tests: Section 26-C, Unit 50-1. Report No. TR-79-26/EE. Acurex Corporation. Mountain View, CA. September 1979.
62. Anderson, D. F., and T. Szytel (Grace Petroleum Corp.). NO<sub>x</sub> Reduction Methods for California Steam Generators by Applied Technology. Paper No. SPE 12772. Society of Petroleum Engineers. Dallas, TX. April 1984.
63. Brinkmann, P. E., and M. K. Poe (Mobil Exploration and Producing U.S., Inc.). NO<sub>x</sub> Emission Reduction from Gas Fired Steam Generators. Technical Paper No. 89-19.6. Air and Waste Management Association. Pittsburgh, PA. June 1989.
64. Natcher, P. High Temperature Low NO<sub>x</sub> Burner Systems for Fired Heaters and Steam Generator. Process Combustion Corp. Presented at the Pacific Coast Oil Show and Conference. Los Angeles, CA. November 1982.
65. 1986 Pollutant Survey (TEOR steam generators). Kern County Air Pollution Control District. November 1986.

66. Abbasi, H., et al. Use of Natural Gas for NO<sub>x</sub> Control in Municipal Waste Combustion. Institute of Gas Technology. Chicago, IL. Presented at the 1991 Joint Symposium on Stationary Combustion NO<sub>x</sub> Control—EPA/EPRI. Washington, D.C. March 25-28, 1991.
67. Penterson, C.A., et al. (Riley Stoker Corporation). Reduction of NO<sub>x</sub> Emissions From MSW Combustion Using Gas Reburning. Proceedings: 1989 Symposium on Stationary Combustion NO<sub>x</sub> Control. Publication No. EPRI GS-6423. U.S. Environmental Protection Agency/Electric Power Research Institute. Palo Alto, CA. July 1989.
68. Lisauskas, R. A., et al. (Riley Stoker Corporation). Status of NO<sub>x</sub> Control Technology at Riley Stoker. Proceedings: 1989 Symposium on Stationary Combustion NO<sub>x</sub> Control. Publication No. EPRI GS-6423. U.S. Environmental Protection Agency/Electric Power Research Institute. Palo Alto, CA. July 1989.
69. Letter and attachments from Haas, G. A., Exxon Research and Engineering Co., to Jordan, B. C., U.S. EPA. NO<sub>x</sub> Control Technologies Questionnaire. February 18, 1993.
70. Karas, J., and D. Goalwin (Bay Area Air Quality Management District). NO<sub>x</sub> Emissions from Refinery and Industrial Boilers and Heaters. Technical Paper No. 84-42.6. Air and Waste Management Association. Pittsburgh, PA. June 1984.
71. Hofmann, J. E. (Nalco Fuel Tech). The NOxOUT Process for Control of Nitrogen Oxides. Proceedings: Third Annual NO<sub>x</sub> Control Conference. Council of Industrial Boiler Owners. Burke, VA. February 1990.
72. Tang, J. T. (Pyropower Corporation). NO<sub>x</sub> Control in Ahlstrom Pyroflow Boiler. Proceedings: Second Annual NO<sub>x</sub> Control Conference. Council of Industrial Boiler Owners. Burke, VA. February 1989.
73. Letter and attachments from Haas, G., Exxon Research and Engineering Company, to Seu, S., Acurex Environmental Corporation. Thermal DeNO<sub>x</sub> Operating Experience Information. March 1992.
74. Letter and attachments from Pickens, R. D., Nalco Fuel Tech, to Castaldini, C., Acurex Environmental Corporation. NOxOUT Urea-Based SNCR Performance. June 9, 1992.
75. Bodylski, J. A., and Haas, G. A. The Selective Noncatalytic Reduction Process: Experience with the Exxon Thermal DeNO<sub>x</sub> Process at Two Circulating Fluidized Bed Boiler Commercial Applications. Presented at the American Flame Research Committee's 1992 Fall International Symposium on Emissions Reductions and Energy Conservation. Cambridge, MA. October 1992. pp. 3-5.
76. Letter and attachments from Valentine, J., Fuel Tech Inc., to Torbov, S., Acurex Corporation. Summary of Urea NOxOUT Demonstration. January 1989.
77. SNCR NO<sub>x</sub> Control Demonstration. Wisconsin Electric Power Company, Valley Power Plant Unit #4. March 1992.

78. Hurst, B. E., et al. Exxon Thermal DeNO<sub>x</sub> Effectiveness Demonstrated in a Wood-Fired Boiler. Exxon Research and Engineering Company. Florham Park, NJ. Presented at the 13th National Waste Processing Conference and Exhibit. May 1-4, 1988.
79. Jones, D. G., et al. (Emcotek Corporation). Two-Stage DeNO<sub>x</sub> Process Test Data for 300 TPD MSW Incineration Plant. Technical Paper No. 89-23B.7. Air and Waste Management Association. Pittsburgh, PA. June 1989.
80. Clarke, M. (Environmental Research and Education). Technologies for Minimizing the Emission of NO<sub>x</sub> From MSW Incineration. Technical Paper No. 89-167.4. Air and Waste Management Association. Pittsburgh, PA. June 1989.
81. City of Commerce MSW Plant. Proceedings: Second Annual NO<sub>x</sub> Control Conference. Council of Industrial Boiler Owners. Burke, VA. February 1989.
82. Hofmann, J. E., et al. (Nalco Fuel Tech). NO<sub>x</sub> Control for Municipal Solid Waste Combustors. Technical Paper No. 90-25.2. Air and Waste Management Association. Pittsburgh, PA. June 1990.
83. Letter and attachments from confidential company to Votlucka, P., South Coast Air Quality Management District. Industrial SCR Experience. October 1988.
84. Behrens, E. S., et al. SCR Operating Experience on Coal Fired Boilers and Recent Progress. Joy Environmental Equipment Company. Monrovia, CA. Presented at the 1991 Joint Symposium on Stationary Combustion NO<sub>x</sub> Control—EPA/EPRI. Washington, D.C. March 25-28, 1991.
85. Furuya, K. (Electric Power Development Company). EPDC's Fluidized Bed Combustion RD&D: a Progress Report on Wakamatsu 50 MW Demonstration Test and the World's Largest FBC Retrofit Project. Proceedings of the 1989 International Conference on Fluidized Bed Combustion. The American Society of Mechanical Engineers/Electric Power Research Institute/Tennessee Valley Authority. New York, NY. 1989.
86. Christian, A. W. (M. C. Patten & Company). State of the Art NO<sub>x</sub> Control in Package Boilers. Proceedings: Fourth Annual NO<sub>x</sub> Control Conference. Council of Industrial Boiler Owners. Burke, VA. February 1991.
87. Kuroda, H., et al. (Kure Works of Babcock-Hitachi K.K.). Recent Developments in the SCR System and its Operational Experiences. Proceedings of the 1989 International Conference on Fluidized Bed Combustion. The American Society of Mechanical Engineers/Electric Power Research Institute/Tennessee Valley Authority. New York, NY. 1989.
88. Donais, R. E., et al. (Combustion Engineering, Inc.). 1989 Update on NO<sub>x</sub> Emission Control Technologies at Combustion Engineering. Proceedings: 1989 Symposium on Stationary Combustion NO<sub>x</sub> Control. Publication No. EPRI GS-6423. U.S. Environmental Protection Agency/Electric Power Research Institute. Palo Alto, CA. July 1989.

89. Letter and attachments from Shaneberger, D. E.; Exxon Research and Engineering Co. NO<sub>x</sub> Emissions Data: ICI Boilers with Flue Gas Treatment NO<sub>x</sub> Controls — SNCR. September 1993.
90. Letter and attachments from Wax, M. J., Institute of Clean Air Companies. NC-300 Catalyst Installations. September 16, 1993.
91. Letter and attachments from Pickens, R., Nalco Fuel Tech. Inc. NO<sub>x</sub>OUT Process Experience List. October 27, 1993.
92. Energy Systems Associates. Characterization of Gas Cofiring in a Stoker-Fired Boiler. Publication No. GRI-93/0385. Gas Research Institute. Chicago, IL. November 1993. p. 6.

**APPENDIX C. LOW-NO<sub>x</sub> INSTALLATION LISTS,  
COEN COMPANY AND TAMPELLA POWER CORP.**

(Note: NO<sub>x</sub> levels reported in the Coen list are not necessarily those achieved with the Coen low-NO<sub>x</sub> burner, but often represent NO<sub>x</sub> guarantees. Actual levels may be lower.)

<u>JOB NO.</u>	<u>INSTALLATION</u>	<u>TYPE OF BOILER</u>	<u>(NO. OF UNITS) CAPACITY</u>	<u>FUEL TYPE</u>	<u>GUARANTEED AND/OR ACTUAL NOx LEVELS</u>	<u>NO. OF BURNERS/ BOILER</u>	<u>COEN METHOD OF NOx REDUCTION</u>
D-2023-1	Bergan Mercy Med. Omaha, NE	NBC NS-C-53	(1) 40,000 PPH	Natural Gas No. 2 oil No. 6 oil	40 PPM 56 PPM 271 PPM	1	DAF-22 W/FGR
D-2019-1 D-2019-2 D-2019-3	Rancho Los Amigos Downey, CA	Nebraska NS-B-38-ECON	(3) 24,000 PPH	Natural Gas Low Nit. Oil	25 PPM 40 PPM	1	SDAF-17 W/FGR
D-2009-1	Stillwater Util. Stillwater, OK	Erie	(1) 150,000 PPH	Natural Gas No. 2 oil	0.1 LBS/MMBTU	4	DAF-28 W/FGR
D-2008-1	Wright Patterson AFB Dayton, OH	IBW D-Type	(2) 80,000 PPH	Natural Gas No. 1 oil	.10 LBS/MMBTU .12 LBS/MMBTU	1	DAF-28 W/FGR
D-2007-1	Neenah Paper Neenah, WI	Nebraska NS-G-80-ECON	(1) 120,000 PPH	Natural Gas No. 2 oil	.16 LBS/MMBTU .20 LBS/MMBTU	1	DAF-34
D-2005-1	Smurfit Venezuela	B&W FM117-97	(1) 150,000 PPH	Natural Gas No. 6 oil	.20 LBS/MMBTU .52 LBS/MMBTU	1	DAF-36 -
D-2003-1	Merck & Co. West Point, PA	B&W FM120-97	(1) 140,000 PPH	Natural Gas No. 2 oil	.05 LBS/MMBTU .52 LBS/MMBTU	1	DAF-39
D-1999-1 D-1999-2 D-1999-3	James River Berlin, NH	C.E. VU	(8) 100,000 PPH	No. 6 oil	.28 LBS/MMBTU	1	DAF-30 W/FGR
D-1995-1	Champion Int'l Cantonment, FL	CE 34VP18/60	(1) 350,000 PPH (1) 385,000 PPH	Natural Gas	.048 LBS/MMBTU	2	DAF-45 W/FGR
D-1996-1	Sithe Energies Scriba, NY	C.E. 38A14/48	(1) 200,000 PPH (1) 210,000 PPH	Natural Gas No. 2 oil	.20 LBS/MMBTU	2	DAF-42 W/FGR
D-1987-1 D-1987-2	Nationwide Fremont, CA	B&W FM 227-97	(2) 150,000 PPH	Natural Gas No. 2 oil No. 6 oil	30 PPM	1	DAF-36 W/FGR
D-1982-1	Marion Merrell Cincinnati, OH	Nebraska N2S-4A-67	(1) 60,000 PPH	Natural Gas No. 2 oil	.012 LBS/MMBTU .17 LBS/MMBTU	1	DAF-28
D-1967-1	Contadina Foods Hanford, CA	Nebraska NS-F-84-ECON	(2) 100,000 PPH	Natural Gas No. 2 oil	30 PPM	1	DAF-32 W/FGR
D-1966-1	CITGO Lake Charles, LA	Zurn Keystone	(2) 250,000 PPH	Refinery Gas	.06 LBS/MMBTU	1	DAF-36 W/FGR
D-1960-2	Cargill Lake Charles, LA	B&W FM 120-97	(1) 165,000 PPH	Natural Gas	.10 LBS/MMBTU	1	DAF-39 W/FGR
D-1960-1	Cargill Eddyville, IA	B&W FM 120-97	(1) 150,000 PPH	Natural Gas	.07 LBS/MMBTU	1	DAF-36 W/FGR
D-1954-1	Heublin Wines Madera, CA	Nebraska NS-F-81-ECON	(2) 100,000 PPH	Natural Gas Propane/Air	30 PPM	1	DAF-32 W/FGR
D-1945-1 D-1945-2	Chevron USA Perth Amboy, NJ	Nebraska NS-E-67	(1) 82,300 PPH (1) 68,500 PPH	Natural Gas Refinery Gas	.05 LBS/MMBTU .05 LBS/MMBTU	1	DAF-30 W/FGR
D-1942-1	So. Peru Copper Ilo, Peru	CE 39VP22/54"	(2) 400,000 PPH	No. 6 oil	.50 LBS/MMBTU	1	DAF-45
D-1937-1	Wabash Wheeling, IL	Nebraska N2S-B/S-116SH	(1) 250,000 PPH	No. 2 oil No. 6 oil	.20 LBS/MMBTU .40 LBS/MMBTU	1	DAF-48 W/FGR

<u>JOB NO.</u>	<u>INSTALLATION</u>	<u>TYPE OF BOILER</u>	<u>(NO. OF UNITS) CAPACITY</u>	<u>FUEL TYPE</u>	<u>GUARANTEED AND/OR ACTUAL NOx LEVELS</u>	<u>NO. OF BURNERS/ BOILER</u>	<u>COEN METHOD OF NOx REDUCTION</u>
D-1930-1	Miami University Oxford, OH	Nebraska N2S-7-93-ECON	(1) 100,000 PPH	Natural Gas No. 2 oil	.1 LBS/MMBTU	1	DAF-34 W/FGR
D-1923-1	Henkel Corp. Los Angeles, CA	B&W FM10-79B	(1) 60,000 PPH	Natural Gas No. 2 oil	30 PPM	1	DAF-28 W/FGR
D-1919-1	Appleton Paper Combined Locks, WI	CE 40A16/48	(1) 200,000 PPH	Natural Gas No. 2 oil	.05 LBS/MMBTU .10 LBS/MMBTU	1	DAF-45 W/FGR
D-1915-1	Central Soya Bellevue, OH	Boiler Eng DS35-112R	(1) 112,000 PPH	Natural Gas Waste oil	.18 LBS/MMBTU	1	DAF-30
D-1891-1	City of Virginia Virginia, NM	Zurn Keystone	(1) 200,000 PPH	Natural Gas	.10 LBS/MMBTU	1	DAF-45 W/FGR
D-1889-1	Indeck Wheeling, IL	Zurn 16M	(1) 100,000 PPH	No. 2 oil Natural Gas	.12 LBS/MMBTU .055 LBS/MMBTU	1	DAF-32 W/FGR
D-1886-1	Indeck Wheeling, IL	Zurn Keystone 250S	(1) 250,000 PPH	Natural Gas No. 2 oil No. 6 oil	.15 LBS/MMBTU	1	DAF-45 W/FGR
D-1867-1	Chief Ethanol Fuels Hastings, NE	Foster Wheeler AG-5175B	(1) 200,000 PPH	Natural Gas No. 2 oil	.20 LBS/MMBTU	1	DAF-42
D-1854-1	Occidental Chem. Pasadena, TX	Nebraska N2S-8/S-103SH	(1) 150,000 PPH	Natural Gas	.05 LBS/MMBTU	1	DAF-39 W/FGR
.51-1	Meyerhaeuser Co. Eugene, OR	Zurn Keystone	(1) 250,000 PPH	Natural Gas No. 6 oil	.146 LBS/MMBTU .35 LBS/MMBTU	1	DAF-45 W/FGR
D-1830-1	General Motors Ft Wayne, IN	Riley MH	(1) 200,000 PPH	Natural Gas No. 2 oil	.098 LBS/MMBTU .13 LBS/MMBTU	1	DAF-42 W/FGR
D-1823-1	Passaic Valley Sever Newark, NJ	B&W FM 10-70	(4) 50,000 PPH	Natural Gas	.05 LBS/MMBTU	1	DAF-26 W/FGR
D-1815-2	Kansas City Power Kansas City, KS	ABCO D-Type	(1) 184,000 PPH	No. 2 oil	.20 LBS/MMBTU	1	DAF-42 W/FGR
D-1815-1	Kansas City Power Kansas City, KS	ABCO D-Type	(2) 208,000 PPH	No. 2 oil	.20 LBS/MMBTU	1	DAF-42 W/FGR
D-1812-1	Ultra Systems Weldon, NC	Volcano D-Type	(1) 20,000 PPH	No. 2 oil	.10 LBS/MMBTU	1	DAF-18 W/FGR
D-1803-1	Texaco Inc. Montebello, CA	B&W FM-D-9-34	(1) 16,000 PPH	Natural Gas Syn Gas	30 PPM	1	DAF-16.5 W/FGR
D-1796-1	ALCOA Lafayette, IN	Nebraska NS-E-63	(1) 70,000 PPH	Natural Gas	.13 LBS/MMBTU	1	DAF-28 W/FGR
D-1778-1	Nationwide Boiler Fremont, CA	B&W FM 117-88C	(2) 120,000 PPH	Natural Gas No. 2 oil No. 6 oil	30 PPM	1	DAF-34 W/FGR
D-1777-1	Hercules Aerospace Haggna, UT	Nebraska NS-C-48-ECON	(1) 35,000 PPH	Natural Gas No. 2 oil	.048 LBS/MMBTU .075 LBS/MMBTU	1	DAF-22 W/FGR
D-1773-1	Ross Labs Columbus, OH	Nebraska NS-F-65-ECON	(1) 80,000 PPH	Natural Gas No. 2 oil	.10 LBS/MMBTU .165 LBS/MMBTU	1	DAF-28
62-1	Toray Industries No. Kingstown, RI	Nebraska NS-C-46-ECON	(1) 33,000 PPH	Natural Gas No. 2 oil	.08 LBS/MMBTU .11 LBS/MMBTU	1	DAF-20

<u>JOB NO.</u>	<u>INSTALLATION</u>	<u>TYPE OF BOILER</u>	<u>(NO. OF UNITS) CAPACITY</u>	<u>FUEL TYPE</u>	<u>GUARANTEED AND/OR ACTUAL NOX LEVELS</u>	<u>NO. OF BURNERS/ BOILER</u>	<u>COEN METHOD OF NOX REDUCTION</u>
D-1757-2	Boise Cascade Rumford, ME	Zurn 2-Drum	(1) 200,000 PPH	No. 6 oil	.34 LBS/MMBTU	3	DAF-30 W/FGR
D-1755-1	Morton Salt	Zurn	(1) 70,000 PPH	Natural Gas	.10 LBS/MMBTU	1	DAF-30
D-1755-2	Hutchinson, KS	Keystone		No. 2 oil No. 6 oil	.20 LBS/MMBTU .34 LBS/MMBTU		
D-1754-5	Kalamazoo Psy.	Wicks 2-Drum	(1) 125,000 PPH	Natural Gas	.14 LBS/MMBTU	1	DAF-26
D-1754-4	Kalamazoo Psy.	Erle City 2-Drum	(1) 125,000 PPH	Natural Gas	.14 LBS/MMBTU	1	DAF-26
D-1754-3	Kalamazoo Psy.	Wicks 3-Drum	(1) 50,000 PPH	Natural Gas	.14 LBS/MMBTU	1	DAF-26
D-1754-2	Kalamazoo Psy.	Wicks 3-Drum	(1) 50,000 PPH	Natural Gas	.14 LBS/MMBTU	1	DAF-26
D-1754-1	Kalamazoo Psy.	Wicks 3-Drum	(1) 50,000 PPH	Natural Gas	.14 LBS/MMBTU	1	DAF-26
D-1746-1	Barrick Goldstrike Carlin, NV	Foster Wheeler AG-5110B	(1) 100,000 PPH	Propane Gas	.134 LBS/MMBTU	1	DAF-34 W/FGR
D-1740-1	U.S. Paper Menasha, WI	B&W FM120-97	(1) 165,000 PPH	Natural Gas Prop.-Air/Gas	.12 LBS/MMBTU .20 LBS/MMBTU	1	DAF-39 W/FGR
.739-1	U.S. Borax Willmington, CA	Nebraska NS-B-35-ECON	(1) 21,500 PPH	Natural Gas	30 PPH	1	DAF-18 W/FGR
D-1729-1	Douglas Energy Placentia, CA	Zurn	(1) 69,000 PPH	Landfill Gas Natural Gas	18 PPH 30 PPH	1	DAF-30 W/FGR
D-1726-1	Miles Research West Haven, CT	B&W FM10-79	(1) 60,000 PPH	Natural Gas No. 2 oil No. 6 oil	.046 LBS/MMBTU .078 LBS/MMBTU .38 LBS/MMBTU	1	DAF-28 W/FGR
D-1721-1	Grain Processing Eddyville, IA	ABB C.E. 12F40A16	(2) 300,000 PPH	Natural Gas	0.187 LBS/MMBTU	2	DAF-36
D-1719-2	ARCO Alaska	Econotherm 1077B	(1) 65 MMBTU	Spec. Gas	.08 LBS/MMBTU	1	DAF-24
D-1719-1	ARCO Alaska	Econotherm 1077B	(1) 80 MMBTU	Spec. Gas	.08 LBS/MMBTU	1	DAF-26
D-1715-1	Indeck	Zurn 14H	(1) 65,000 PPH	Natural Gas	30 PPH	1	DAF-30 W/FGR
D-1712-1	CF Industries Donaldsonville, LA	ABCO D-Type	(1) 75,000	Natural Gas	.090 LBS/MMBTU	1	DAF-30 W/FGR
D-1708-1	Central Heating Plt Washington, DC	Vogt	(2) 90,000	Natural Gas	.07 LBS/MMBTU	2	DAF-30
D-1704-1	Minnesota Corn Proc. Marshall, MN	NBC NS-F-86	(1) 120,000	Natural Gas No. 6 oil	0.1 LBS/MMBTU .4 LBS/MMBTU	1	DAF-34 W/FGR
D-1703-1	Latter Day Saints Hos Salt Lake City, Utah	NBC NS-C-59	(2) 38,000 PPH	Natural Gas No. 2 oil	.10 LBS/MMBTU .20 LBS/MMBTU	1	DAF-22



<u>JOB NO.</u>	<u>INSTALLATION</u>	<u>TYPE OF BOILER</u>	<u>(NO. OF UNITS) CAPACITY</u>	<u>FUEL TYPE</u>	<u>GUARANTEED AND/OR ACTUAL NOx LEVELS</u>	<u>NO. OF BURNERS/ BOILER</u>	<u>COEN METHOD OF NOx REDUCTION</u>
D-1702-1	United Distillers Louisville, KY	NBC NS-F-77	(1) 100,000 PPH	Natural Gas No. 2 oil No. 6 oil	.15 LBS/MMBTU .20 LBS/MMBTU .37 LBS/MMBTU	1	DAF-32
D-1701-1	Ford Motor Co. Sterling Heights, MI	Wicks ROP	(1) 120,000 PPH	Natural Gas No. 2 oil	.14 LBS/MMBTU .14 LBS/MMBTU	1	DAF-28 W/FGR
D-1694-1	Ross Labs Chicago, IL	NBC NS-F-65	(1) 80,000 PPH	Natural Gas No. 2 oil	.10 LBS/MMBTU .165 LBS/MMBTU	1	DAF-28
D-1680-1	3M Company Middleway, WV	Nebraska NS-C-54	(2) 40,000 PPH	Natural Gas No. 2 oil	77 PPM 92 PPM	1	DAF-22 W/FGR
D-1679-1	General Mills Cedar Rapids, IA	Nebraska NS-C-53	(1) 40,000 PPH	Natural Gas No. 2 oil		1	DAF-22
D-1675-1	Chambers Works Carneys Point, NJ	Volcano WM-700	(1) 72,000 PPH	No. 2 oil	.17LBS/MMBTU	1	DAF-30 W/FGR
D-1674-1	Monitor Sugar Eay City, MI	Nebraska NS-G-96-ECON	(2) 150,000 PPH	Natural Gas No. 2 oil	0.10 LBS/MMBTU .155 LBS/MMBTU	1	DAF-36 W/FGR
D-1670-1	General Mills So. Chicago, IL	Nebraska NS-E-57	(1) 60,000 PPH	Natural Gas No. 2 oil No. 6 oil	0.10 LBS/MMBTU 0.155 LBS/MMBTU 0.41 LBS/MMBTU	1	DAF-26 W/FGR
D-1663-1	Shintech Freeport, TX	Nebraska NS-E-57-ECON	(2) 60,000 PPH	Natural Gas No. 2 oil	0.06 LBS/MMBTU .13 LBS/MMBTU	1	DAF-26 W/FGR
D-1661-3	Univ of Calif. Irvine, CA	Trane MCF2-38	(1) 30,300 PPH	Natural Gas Propane-Air	40 PPM	1	DAF-20 W/FGR
D-1661-2	Univ of Calif. Irvine, CA	Nebraska NS-C-51	(1) 28,100 PPH	Natural Gas Propane-Air	40 PPM	1	DAF-20
D-1661-1	Univ of Calif. Irvine, CA	B&W FM-9-57	(2) 26,500 PPH	Natural Gas Propane-Air	40 PPM	1	DAF-18 W/FGR
D-1660-1	Ohio State Univ. Athens, Ohio	Keeler	(1) 70,000 PPH	Natural Gas		1	DAF-28
D-1659-1	Gangl Brothers Riverbank, CA	Nebraska N2S-7-95-ECON	(1) 150,000 PPH	Natural Gas Propane-Air	.072 LBS/MMBTU	1	DAF-39 W/FGR
D-1632-2	Wayside Honor Rancho Saugus, CA	Keeler DS-10-13	(1) 50,000 PPH	Natural Gas No. 2 oil	30 PPM	1	DAF-26 W/FGR
D-1632-1	Wayside Honor Rancho Saugus, CA	Keeler DS-10-13	(1) 50,000 PPH	Natural Gas No. 2 oil	30 PPM	1	DAF-26 W/FGR
D-1631-1	LA County Mens Jail Los Angeles, CA	Murray MCF1-59	(1) 30,600 PPH	Natural Gas No. 2 oil	40 PPM	1	DAF-20 W/FGR
D-1630-2	LA County Mens Jail Los Angeles, CA	Murray C-18	(1) 27,500 PPH	Natural Gas No. 2 oil	40 PPM	1	DAF-20 W/FGR
D-1630-1	LA County Mens Jail Los Angeles, CA	Murray C-18	(1) 27,500 PPH	Natural Gas No. 2 oil	40 PPM	1	DAF-20 W/FGR
D-1623-1	Marathon Petroleum Garyville, LA	Zurn Special Keystone	(1) 250,000 PPH	Natural Gas Refinery Gas	.123 LBS/MMBTU	2	DAF-36 W/FGR
19-1	Dupont Corpus Christi, TX	Erie City Keystone 20H	(1) 130,000 PPH	Natural Gas	0.06 LBS/MMBTU	1	DAF-36 W/FGR

<u>JOB NO.</u>	<u>INSTALLATION</u>	<u>TYPE OF BOILER</u>	<u>(NO. OF UNITS) CAPACITY</u>	<u>FUEL TYPE</u>	<u>GUARANTEED AND/OR ACTUAL NOx LEVELS</u>	<u>NO. OF BURNERS/ BOILER</u>	<u>COEN METHOD OF NOx REDUCTION</u>
D-1615-1	BASF Greenville, OH	B&W FM 10-66	(1) 50,000 PPH	Natural Gas/ No. 2 oil or Waste Gas/ No. 6 oil	0.10 LBS/MMBTU 0.10 LBS/MMBTU	1	DAF-24 W/FGR
D-1614-1	Univ. of North Dakota Grand Forks, ND	Nebraska NS-E-57	(2) 60,000 PPH	Natural Gas No. 2 oil	0.12 LBS/MMBTU 0.16 LBS/MMBTU	1	DAF-26
D-1613-1	Indeck Wheeling, IL	Zurn NS-7-95	(1) 150,000 PPH	Natural Gas No. 2 oil	0.1 LBS/MMBTU	1	DAF-36 W/FGR
D-1612-1	Indeck Wheeling, IL	Zurn Keystone 23M	(1) 140,000 PPH	Natural Gas Hydrogen	0.10 LBS/MMBTU	1	DAF-36 W/FGR
D-1611-1	Indeck Wheeling, IL	Zurn Keystone 22M	(1) 150,000 PPH	Natural Gas No. 2 oil	0.1 LBS/MMBTU	1	DAF-36 W/FGR
D-1610-1	Indeck Wheeling, IL	Zurn Keystone 16M	(1) 95,000 PPH	Natural Gas No. 2 oil No. 6 oil	0.1 LBS/MMBTU 0.16 LBS/MMBTU	1	DAF-32 W/FGR
D-1609-1	Indeck Wheeling, IL	Zurn Keystone 16M	(1) 95,000 PPH	Natural Gas No. 2 oil No. 6 oil	0.1 LBS/MMBTU 0.16 LBS/MMBTU	1	DAF-32 W/FGR
D-1608-1	Indeck Wheeling, IL	Zurn Keystone 16M	(1) 95,000 PPH	Natural Gas No. 2 oil No. 6 oil	0.1 LBS/MMBTU 0.16 LBS/MMBTU	1	DAF-32 W/FGR
D-1607-1	Indeck Wheeling, IL	Zurn Keystone 16	(1) 95,000 PPH	Natural Gas No. 2 oil	0.1 LBS/MMBTU 0.147 LB/MMBTU	1	DAF-32 W/FGR
D-1598-1	Campbell Soup Co. Maxton, NC	Keeler DS10-22	(1) 100,000 PPH	Natural Gas No. 6 oil	0.30 LBS/MMBTU 0.10 LBS/MMBTU	1	DAF-32
D-1586-1	Lockheed Palmdale, CA	Nebraska NS-E-65-ECON	(1) 75,000 PPH	Natural Gas No. 2 oil	.048 LBS/MMBTU .076 LBS/MMBTU	1	DAF-32 W/FGR
D-1585-1	Marine Corp. Logistics Base Barstow, CA	IBW TJW-C-25	(3) 25,000 PPH	Natural Gas No. 2 oil	40 PPH 200 PPH	1	DAF-20 W/FGR
D-1584-1	Contadina Foods Woodland, CA	Nebraska NS2-7-95-ECON	(1) 150,000 PPH	Natural Gas Propane-Air Butane-Air	40 PPH 55 PPH	1	DAF-39 W/FGR
D-1578-1	Patton State Hospital San Bernardino, CA	Nebraska NSC 42	(1) 30,000 PPH	Natural Gas	39.4 PPH	1	DAF-20 W/FGR
D-1577-1	Boise Cascade International Falls, MN	C.E. 12F48A16	(2) 250,000 PPH	Natural Gas	0.05 LBS/MMBTU	2	DAF-36 W/FGR
D-1571-1	GWF Hanford Cogen Hanford, CA	Nebraska NS-E-65-ECON	(1) 68,000 PPH	Natural Gas	30 PPH	1	DAF-38 W/FGR
D-1563-1	Indeck Power Wheeling, IL	Zurn 24M	(1) 250,000 PPH	Natural Gas No. 2 oil No. 6 oil	0.10 LBS/MMBTU 0.28 LBS/MMBTU 0.40 LBS/MMBTU	1	DAF-45 W/FGR
D-1562-1	Indeck Power Wheeling, IL	Zurn 24M	(1) 250,000 PPH	Natural Gas No. 2 oil No. 6 oil	0.10 LBS/MMBTU 0.28 LBS/MMBTU 0.40 LBS/MMBTU	1	DAF-45 W/FGR

<u>JOB NO.</u>	<u>INSTALLATION</u>	<u>TYPE OF BOILER</u>	<u>(NO. OF UNITS) CAPACITY</u>	<u>FUEL TYPE</u>	<u>GUARANTEED AND/OR ACTUAL NOx LEVELS</u>	<u>NO. OF BURNERS/ BOILER</u>	<u>COEN METHOD OF NOx REDUCTION</u>
D-1559-1	3M St. Paul, MN	Nebraska N2S-B/S-93-ECON	(1) 180,000 PPH	Natural Gas No. 2 oil (.017% FEN)	0.05 LBS/MMBTU 0.11 LBS/MMBTU	1	DAF-42 W/FGR SCROLL
D-1545-1	BYU Provo, UT	Volcano TJU-C-150	(2) 150,000 MKB	Natural Gas No. 2 oil (0.02% FEN)	0.11 LBS/MMBTU 0.20 LBS/MMBTU	1	DAF-39
D-1545-2	BYU Provo, UT	Volcano TJU-C-50	(1) 50,000 MKB	Natural Gas No. 2 oil (0.02% FEN)	0.09 LBS/MMBTU 0.16 LBS/MMBTU	1	DAF-24
D-1544-1	Newark Bay Cogen Newark, NJ	B&W	(1) 140,000 PPH	Natural Gas No. 2 oil	45 PPM	1	DAF-39 W/FGR
D-1540-1	Spreckles Sugar Manteca, CA	UIW MH	(1) 120,000 PPH	Natural Gas No. 2 oil No. 6 oil	.0829 LBS/MMBTU 0.30 LBS/MMBTU 0.75 LBS/MMBTU	1	DAF-42 W/FGR
D-1540-2	Spreckles Sugar Manteca, CA	CE 25VP12	(1) 100,000 PPH	Natural Gas No. 2 oil No. 6 oil	.082 LBS/MMBTU 0.30 LBS/MMBTU 0.75 LBS/MMBTU	1	DAF-39 W/FGR
D-1539-1	A&P Tea Company Columbus, OH	Wicks RB	(1) 65,000 PPH	Natural Gas Landfield Gas	.11 LBS/MMBTU	1	DAF-26
D-1538-1	Union Co. Court House Elizabeth, NJ	B&W FM9-43	(1) 30,000 PPH	Natural Gas No. 6 oil		1	DAF-18
D-1538-2	Union Co. Court House Elizabeth, NJ	B&W FM9-39	(1) 26,000 PPH	Natural Gas No. 6 oil		1	DAF-18
D-1527-1	E.I. Dupont Sabine, TX	CE VU60	(1) 360,000 PPH	Natural Gas	0.23 LBS/MMBTU	4	DAF-32
D-1525-1	UCLA Westwood, CA	Zurn Keystone	(1) 160,000 PPH	Natural Gas No. 2 oil (.00001% FEN)	0.055 LBS/MMBTU 0.084 LBS/MMBTU	1	DAF-45 W/FGR
D-1522-1	Washington Univ. St. Louis, MO	Zurn Keystone	(1) 70,000 PPH	Natural Gas No. 2 oil	0.15 LBS/MMBTU 0.2 LBS/MMBTU	1	DAF-28
D-1520-1	Okeelanta Sugar South Bay, FL	B&W FM128-97	(1) 150,000 PPH/ 100,000 PPH	No. 2 Oil (0.1% FEN)	0.21 LBS/MMBTU	1	DAF-42 W/FGR
D-1508-1	Savannah Electric Power Co. Savannah, GA	ABB Combustion 40AF16/42	(2) 200,000 PPH	Natural Gas	0.07 LBS/MMBTU	1	DAF-45 W/FGR
D-1498-1	Cedar Sinai Medical Ctr Los Angeles, CA	MIW MCF 4-49	(3) 50,000 PPH	Natural Gas No. 2 Oil (0.001% FEN)	40 PPM 400 PPM	1	DAF-26 W/FGR
D-1496-1	Lunday-Thagard Co. South Gate, CA	B&W FM1061B	(1) 48,000 PPH	Natural Gas No. 2 Oil Propane/Air (0.003% FEN)	39.9 PPM 30 PPM 33 PPM	1	DAF-22 W/FGR
D-1478-1	Henkel Corporation Los Angeles, CA	B&W FM 1061A	(1) 40,000 PPH	Natural Gas No. 2 Oil (0.001% FEN)	30 PPM 400 PPM	1	DAF-24 W/FGR

<u>JOB NO.</u>	<u>INSTALLATION</u>	<u>TYPE OF BOILER</u>	<u>(NO. OF UNITS) CAPACITY</u>	<u>FUEL TYPE</u>	<u>GUARANTEED AND/OR ACTUAL NOx LEVELS</u>	<u>NO. OF BURNERS/ BOILER</u>	<u>COEN METHOD OF NOx REDUCTION</u>
)-1469-1	Santa Monica Hospital Santa Monica, CA	Murray MCF-2-42	(2) 30,000 PPH	Natural Gas No. 2 Oil (0.001% FBN)	40 PPM 40 PPM	1	DAF-22 W/FGR
)-1463-1	Campbell Soup Company Maxton, NC	Union Boiler "A" MH	(1) 100,000 PPH	Natural Gas No. 6 Oil		1	DAF-32
)-1452-1	Shell Western N. Teerebone, LA	Holman MH	(1) 85,000 PPH	Natural Gas	83.5 PPM	1	DAF-34 W/FGR
)-1437-1	BP Oil Lima, OH	CE 12F40A16/54	(1) 225,000 PPH	Refinery Gas Future Oil	.1 LBS/MMBTU	2	DAF-36 W/FGR
)-1436-1	Metrohealth Med Center Cleveland, OH	Nebraska NS-E-51-ECON	(1) 50,000 PPH	Natural Gas No. 2 Oil	0.1 LBS/MMBTU 0.2 LBS/MMBTU	1	DAF-24
)-1434-1	Huntington Mem. Hosp. Pasadena, CA	Bros W3-35	(3) 28,000 PPH	Natural Gas No. 2 Oil (0.001% FBN)	40 PPM	1	DAF-20 W/FGR
)-1425-1	Univ. of Cincinnati Cincinnati, OH	NBC N25-7-107 ECON	(2) 150,000 PPH	Natural Gas No. 2 Oil	0.20 LBS/MMBTU (.02% FBN)	1	DAF-36
)-1420-1	Wabash Power Equip. Rental Unit	CE 35-A-14	(4) 150,000 PPH (3)	Natural Gas No. 2 Oil (0% FBN)	0.19 LBS/MMBTU 0.20 LBS/MMBTU	1	DAF-42
)-1399-1				No. 6 Oil	0.39 LBS/MMBTU		
)-1398-1				(.25% FBN)			
)-1403-1	Wabash Power Equip. Rental Unit	NBC N25-7-89	(2) 150,000 PPH	Natural Gas No. 2 Oil (0% FBN)	0.19 LBS/MMBTU 0.20 LBS/MMBTU	1	DAF-42
)-1402-1				No. 6 Oil (.25% FBN)	0.39 LBS/MMBTU		
)-1384-1	Old Dominion Electric Clover, VA	CE 34A13	(1) 140,000 PPH	No. 2 Oil	0.23 LB/MMBTU	1	DAF-42
)-1376-1	McDonnell Douglas Long Beach, CA	IBW LFU-20	(2) 32,000 PPH	Natural Gas	0.048 LB/MMBTU	1	DAF-22 W/FGR
)-1373-1	Hoechst Celanese Carlsale, CA	NBC NS-E-57	(1) 60,000 PPH	Natural Gas No. 6 Oil	0.10 LB/MMBTU 0.35 LB/MMBTU (0.28 WT % FBN)	1	DAF-26
)-1372-1	Global Octane Deer Park, TX	Abco D Type	(1) 25,000 PPH	Natural Gas	0.08 LB/MMBTU	1	DAF-20 W/FGR
)-1365-1	Holman Boiler Works Rental Unit	Zurn Keystone	(1) 200,000 PPH	Natural Gas No. 2 Oil (0% FBN)	0.19 LBS/MMBTU 0.20 LBS/MMBTU	1	DAF-45 W/FGR
)-1361-1				No. 6 Oil (.25% FBN)	0.39 LBS/MMBTU		
)-1366-1	Holman Boiler Works Rental Unit	CE 33A14	(5) 155,000 PPH	Natural Gas No. 2 Oil (0% FBN)	0.19 LBS/MMBTU 0.20 LBS/MMBTU	1	DAF-39 W/FGR
)-1364-1				No. 6 Oil (.25% FBN)	0.39 LBS/MMBTU		
)-1363-1							
)-1362-1							
)-1361-1							
)-1354-1	Canners Steam Company Terminal Island, CA	UIV Type H	(2) 100,000 PPH	Natural Gas No. 6 Oil	0.048 LB/MMBTU (Up to 80,000 PPH)	4	DAF-20

<u>JOB NO.</u>	<u>INSTALLATION</u>	<u>TYPE OF BOILER</u>	<u>(NO. OF UNITS) CAPACITY</u>	<u>FUEL TYPE</u>	<u>GUARANTEED AND/OR ACTUAL NOX LEVELS</u>	<u>NO. OF BURNERS/ BOILER</u>	<u>COEN METHOD OF NOX REDUCTION</u>
D-1351-1	Procter & Gamble Oxnard, CA	B&W FMD-103-88	(1) 80,000 PPH	Natural Gas No. 2 Oil	0.05 LB/MMBTU	1	DAF-32 W/FGR
D-1350-1	Monsanto Company Long Beach, CA	B&W FM9-52	(1) 25,000 PPH	Natural Gas No. 2 Oil	0.048 LB/MMBTU	1	DAF-28 W/FGR
D-1344-1	St. Mary's Hospital Rochester, MN	NBC NS-F-86	(3) 80,000 PPH	Natural Gas No. 2 Oil	0.10 LB/MMBTU (0.01% FBN)	1	DAF-32 W/FGR
D-1343-1 D-1343-2	Mobile Refinery Saraland, AL	Cleaver Brooks DL-52	(2) 40,000 PPH	Refinery Gas	0.15 LB/MMBTU	1	DAF-24
D-1338-1	Anitec Cogeneration Binghamton, NY	Abco D Type	(1) 104,000 PPH	Natural Gas No. 2 Oil	0.05 LB/MMBTU 0.14 LB/MMBTU (0.048% FBN)	1	DAF-34 W/FGR
D-1336-1	Dixie Chemicals Pasadena, TX	NBC NS-E-57	(1) 60,000 PPH	Natural Gas	0.06 LB/MMBTU	1	DAF-26 W/FGR
D-1333-1	General Electric Waterford, NY	Zurn Keystone	(1) 250,000 PPH	Natural Gas No. 2 Oil No. 6 Oil	0.10 LB/MMBTU 0.15 LB/MMBTU 0.30 LB/MMBTU	1	DAF-45 W/FGR
D-1332-2	Orange County Santa Ana, CA	Keeler DS-10-10	(1) 38,000 PPH	Natural Gas No. 2 Oil (0.001% FBN)	0.04 LB/MMBTU 0.05 LB/MMBTU	1	DAF-22 W/FGR
332-1	Orange County Santa Ana, CA	NBC NS-G-70	(1) 70,000 PPH	Natural Gas No. 2 Oil	0.04 LB/MMBTU 0.05 LB/MMBTU (0.001% FBN)	1	DAF-30 W/FGR
D-1331-1	E.I. DuPont Newark, DE	NBC NTC-61	(1) 40,000 PPH	Natural Gas	0.10 LB/MMBTU	1	DAF-24
D-1325-1	Cape Industries Wilmington, NC	B&W FM 220	(1) 205,000 PPH	Natural Gas No. 6 Oil	0.20 LB/MMBTU	2	DAF-32
D-1320-1	Witco Chemical Oildale, CA	Zurn 15M	(1) 80,000 PPH	Natural Gas Propane/Air	0.10 LB/MMBTU 0.28 LB/MMBTU	1	DAF-30
D-1316-1	Rohm & Haas Louisville, KY	C.E. 35A14	(2) 180,000 PPH	Natural Gas #2 Oil Waste Oil	0.20 LB/MMBTU 0.20 LB/MMBTU	1	DAF-42 W/FGR
D-1310-1	Luz Engineering Boron, CA	G.C. Broach Heater	(12) 53.00 MMBTUH	Natural Gas	0.03 LB/MMBTU	1	DAF-30 W/FGR
D-1305-1	Geneva Steel Orem, UT	Zurn 21M	(2) 100,000 PPH	Natural Gas No. 6 Oil Coke Oven Gas	0.1 LB/MMBTU 0.43 LB/MMBTU 0.50 LB/MMBTU	1	DAF-32
D-1303-1	Mohawk Rubber Salem, VA	ABCO D Type	(1) 65,000 PPH	Natural Gas No. 2 Oil	0.20 LB/MMBTU 0.30 LB/MMBTU	1	DAF-26
D-1295-1 D-1294-1 D-1293-1	Indeck Power Rental	ZURN 24 M	(3) 250,000 PPH	Natural Gas	0.15 LB/MMBTU	1	DAF-45
D-1288-1	Ford Motor Company Livonia, MI	NBC NS-C-43	(1) 30,000 PPH	Natural Gas	0.08 LB/MMBTU	1	DAF-20
1286-1 286-2	Rancho Los Amigos H.C. Downey, CA	Murray M-64E275	(2) 30,000 PPH	Natural Gas No. 2 Oil	0.05 LB/MMBTU 0.05 LB/MMBTU (0.001% FBN)	1	DAF-22 W/FGR

<u>JOB NO.</u>	<u>INSTALLATION</u>	<u>TYPE OF BOILER</u>	<u>(NO. OF UNITS) CAPACITY</u>	<u>FUEL TYPE</u>	<u>GUARANTEED AND/OR ACTUAL NOx LEVELS</u>	<u>NO. OF BURNERS/ BOILER</u>	<u>COEN METHOD OF NOx REDUCTION</u>
D-1284-1	University of Iowa Iowa City, IA	Riley MMW	(2) 150,000 PPH	Natural Gas No. 2 Oil	0.10 LB/MMBTU 0.20 LB/MMBTU (.02% FBN)	1	DAF-42
D-1265-2	Ashland Oil Catlettsburg, KY	BBW FM-117-88	(1) 100,000 PPH	Refinery Gas	0.14 LB/MMBTU	1	DAF-34
D-1265-1	Ashland Oil Catlettsburg, KY	BBW FM-26	(1) 200,000 PPH	Refinery Gas	0.14 LB/MMBTU	4	DAF-26
D-1255-1	Ashland Oil St. Paul, MN	Petrochem 5-37-B1 Heater	(1) 54 MMBTU	Refinery Gas	0.14 LB/MMBTU	1	DAF-22
D-1254-1	Ashland Oil Catlettsburg, KY	Petrochem 2-121-B3	(1) 110 MMBTU	Refinery Gas	0.14 LB/MMBTU	1	DAF-28
D-1253-1	Ashland Oil St. Paul, MN	Petrochem 5-37-B2	(1) 31 MMBTU	Refinery Gas	0.14 LB/MMBTU	1	DAF-16.5
D-1252-1	Ashland Oil Catlettsburg, KY	Petrochem 2-121-B2 Heater	(2) 54 MMBTU	Refinery Gas	0.14 LB/MMBTU	1	DAF-22
D-1251-1	Amoco Performance Augusta, GA	NBC NS-E-57ECON	(1) 60,000 PPH	Natural Gas No. 2 Oil	0.10 LB/MMBTU 0.20 LB/MMBTU	1	DAF-24
D-1227-1	Wabash Mobile Unit	NBC	(3) 60,000 PPH	Natural Gas	0.10 LB/MMBTU	1	DAF-26
D-1226-1		NOS-2A-58		No. 2 Oil	0.20 LB/MMBTU		
D-1225-1				No. 6 Oil			
D-1211-1	Morgantown Energy	Zurn	(2) 101,000 PPH	Natural Gas	0.10 LB/MMBTU	1	DAF-32
D-1211-2	Morgantown, WV	20M					
D-1210-1	Sterling Power Oneida, NY	Zurn 17M	(1) 98,500 PPH	Natural Gas No. 2 Oil	0.09 LB/MMBTU 0.20 LB/MMBTU	1	DAF-32 W/FGR
D-1200-1	Tennessee Eastman Kingsport, TN	CE 35A14	(1) 150,000 PPH	Natural Gas Methanol	0.10 LB/MMBTU 0.23 LB/MMBTU	1	DAF-39
D-1197-1	Franklin Heating Rochester, MN	Riley	(1) 93,000 PPH	Natural Gas No. 2 Oil	0.13 LB/MMBTU 0.33 LB/MMBTU	1	DAF-36
D-1194-1	N.E. Missouri State University Kirksville, MO	NBC NS-C-53ECON	(2) 40,000 PPH	Natural Gas No. 2 Oil	0.20 LB/MMBTU 0.30 LB/MMBTU	1	DAF-20
D-1183-1	Tennessee Eastman	CE	(2) 150,000 PPH	Natural Gas	0.10 LB/MMBTU	1	DAF-39
D-1183-2	Kingsport, TN	35A14		Methanol	0.23 LB/MMBTU		
D-1179-1	Ultra Systems Hopewell, VA	NBC NS-E-56	(1) 65,000 PPH	Natural Gas No. 2 Oil	0.07 LB/MMBTU 0.10 LB/MMBTU (.02% FBN)	1	DAF-26 W/FGR
D-1178-1	Ultra Systems Buena Vista, VA	NBC NS-E-50	(1) 55,000 PPH	Natural Gas No. 2 Oil (.02% FBN)	.065 LB/MMBTU 0.10 LB/MMBTU	1	DAF-24 W/FGR
D-1173-1	Indeck Power	Zurn	(6) 70,000 PPH	Natural Gas	0.10 LB/MMBTU	1	DAF-28
D-1172-1	(Mobile Unit)	13MS		No. 2 Oil	0.20 LB/MMBTU		
D-1171-1					0.01% FBN		
D-1170-1							
D-1169-1							
D-1168-1							

<u>JOB NO.</u>	<u>INSTALLATION</u>	<u>TYPE OF BOILER</u>	<u>(NO. OF UNITS) CAPACITY</u>	<u>FUEL TYPE</u>	<u>GUARANTEED AND/OR ACTUAL NOX LEVELS</u>	<u>NO. OF BURNERS/ BOILER</u>	<u>COEN METHOD OF NOX REDUCTION</u>
9-1143-1 9-1142-1 9-1141-1 9-1140-1	Indeck Power (Mobile Unit)	NBC NOS-2-52(S)	(4) 75,000 PPH	Natural Gas No. 2 Oil	0.10 LB/MMBTU 0.20 LB/MMBTU (0.01% FBN)	1	DAF-28
9-1139-1	Nabisco Foods Oxnard, CA	B&W FM 10-79	(1) 50,000 PPH	Natural Gas No. 2 Oil No. 6 Oil	0.05 LB/MMBTU	1	DAF-26 W/FGR
9-1131-1	I/N Kote New Carlisle, IN	NBC NS-E-57	(1) 58,400 PPH	Natural Gas	0.046 LB/MMBTU	1	DAF-28 W/FGR
9-1121-1	Univ. of Minnesota St. Paul MH	NBC NS-F-77	(1) 79,000 PPH	Natural Gas No. 2 Oil	0.075 LB/MMBTU 0.14 LB/MMBTU (0.01%)	1	DAF-28
9-1113-1	San Francisco Int'l Airport San Francisco, CA	IBW TJW-C-50	(1) 50 MMBTUH	Natural Gas No. 2 Oil	0.05 LB/MMBTU	1	DAF-24 W/FGR
9-1112-1	Ultra Systems Alta Vista, VA	NBC NS-G-88	(1) 122,000 PPH	Natural Gas No. 2 Oil	0.065 LB/MMBTU 0.20 LB/MMBTU	1	DAF-34 W/FGR
9-1111-1	Ultra Systems Southampton, VA	NBC NS-E-59	(1) 72,000 PPH	Tall Oil No. 2 Oil	0.65 LB/MMBTU 0.10 LB/MMBTU (0.4% FBN)	1	DAF-30 W/FGR
9-1109-1	Ashland Oil Carlettsburg, KY	NBC NS-G-85-ECON	(1) 150,000 PPH	Refinery Gas	0.14 LB/MMBTU	1	DAF-36
9-1107-1	Ross Laboratories Columbus, OH	NBC NS-F-85-ECON	(1) 80,000 PPH	Natural Gas No. 2 Oil	0.10 LB/MMBTU 0.165 LB/MMBTU (0.01% FBN)	1	DAF-28
9-1100-1	Fulton Cogen Fulton, NY	Zurn 13M	(2) 62,000 PPH	Natural Gas No. 2 Oil	0.168 LB/MMBTU 0.183 LB/MMBTU	1	DAF-26 W/FGR
9-1099-1	Rockwell Int'l Rocketdyne Division Canoga Park, CA	Keeler DS-20	(1) 20,000 PPH	Natural Gas No. 2 Oil	0.05 LB/MMBTU 0.05 LB/MMBTU (0.001% FBN)	1	DAF-16.5 W/FGR
9-1090-1	NL Chemicals Lake Charles, LA	ABCO D Type	( ) 75,000 PPH	Natural Gas	0.10 LB/MMBTU	1	DAF-30
9-1085-4	Bunker Hill Los Angeles, CA	IBW HTWG	(1) 30 MMBTUH	Natural Gas No. 2 Oil	0.05 LB/MMBTU 0.05 LB/MMBTU (0.001% FBN)	1	DAF-20 W/FGR
9-1085-3	McDonnell Douglas Huntington Beach, CA	MIW D Type	(1) 25,000 PPH	Natural Gas No. 2 Oil	0.05 LB/MMBTU 0.05 LB/MMBTU (0.001% FBN)	1	DAF-22 W/FGR
9-1085-2	Century City Los Angeles, CA	MIW D Type	(1) 112,000 PPH	Natural Gas No. 2 Oil	0.04 LB/MMBTU 0.04 LB/MMBTU (0.001% FBN)	1	DAF-36 W/FGR
9-1085-1	Bunker Hill Los Angeles, CA	IBW HTWG	(1) 30 MMBTU/HR	Natural Gas No. 2 Oil	0.05 LB/MMBTU 0.05 LB/MMBTU (0.001% FBN)	1	DAF-18 W/FGR
83-1	Boeing Company Auburn, WA	Union Riley A Type	(1) 140,000 PPH	Natural Gas	0.10 LB/MMBTU	1	DAF-36

JOB NO.	INSTALLATION	TYPE OF BOILER	(NO. OF UNITS) CAPACITY	FUEL TYPE	GUARANTEED AND/OR ACTUAL NOx LEVELS	NO. OF BURNERS/ BOILER	COEN METHOD OF NOx REDUCTION
D-1072-1 D-1072-2 D-1072-3	Metropolitan Airport Minneapolis, MN	BROS P2-60	(3) 40,000 PPH	Natural Gas No. 6 Oil	0.08 LB/MMBTU 0.60 LB/MMBTU	1	DAF-22
D-1069-1	Chevron St. James, LA	CE 25A15	(3) 150,000 PPH	Natural Gas Waste Oil	0.06 LB/MMBTU 0.10 LB/MMBTU	1	DAF-39 W/FGR
D-1064-1	NASA Johnson Center Houston, Texas	NBC NS-E-68	(1) 80,000 PPH	Natural Gas	0.10 LB/MMBTU	1	DAF-28
D-1059-1	Monitor Sugar Bay City, MI	NBC NS-F-88	(1) 120,000 PPH	Natural Gas No. 2 Oil	0.10 LB/MMBTU 0.20 LB/MMBTU (.028X FBN)	1	DAF-34
D-1057-1	General Tire & Rubber Mayfield, KY	Murray MCF6X-94	(1) 125,000 PPH	Natural Gas No. 2 Oil (0.01X FBN)	0.10 LB/MMBTU 0.24 LB/MMBTU	1	DAF-36
D-1055-1	Ciba Geigy Corp. McIntosh, AL	NBC NS-E-63 ECON	(1) 70,000 PPH	Natural Gas No. 2 Oil	0.10 LB/MMBTU 0.17 LB/MMBTU (.01X FBN)	1	DAF-28
D-1054-1	Indeck Power (Rental Unit)	Zurn 17M	(1) 90,000 PPH	Natural Gas	40 PPH	1	DAF-30
D-1019-1 D-1019-2	Shell Offshore Inc. Mon Louis, AL	NBC NS-C-53	(2) 40,000 PPH	Natural Gas	0.10 LB/MMBTU	1	DAF-22
08-1	Chrysler Corporation No. Jefferson, MI	IBW TJU-C-75	(3) 87,500 PPH	Natural Gas No. 2 Oil	40 PPH	1	DAF-28 W/FGR
D-1007-1	Wellesley College Wellesley, MA	NBC NS-C-56	(1) 45,000 PPH	Natural Gas No. 6 Oil	0.10 LB/MMBTU	1	DAF-24 W/NOx Ports
D-1006-1	Norenco Corporation Minneapolis, MN	NBC NOS-1A-53S	(1) 36,000 PPH	Natural Gas	0.10 LB/MMBTU	1	DAF-20
D-1005-1	Norenco Corporation Minneapolis, MN	MIW MCF-5-85	(1) 115,000 PPH	Natural Gas	0.10 LB/MMBTU	1	DAF-34
D-1000-1	J.M. Huber Etowah, TN	NBC NS-F-69	(1) 88,000 PPH	Natural Gas No. 2 Oil	0.20 LB/MMBTU	1	DAF-28
D-0998-1 D-0997-1 D-0996-1 D-0995-1 D-0994-1 D-0993-1	Indeck Power (Mobile Units)	Zurn 23M	(6) 150,000 PPH	Natural Gas No. 6 Oil	0.10 LB/MMBTU	1	DAF-36
D-0991-1	Occidental Chemical Corpus Christi, TX	Zurn	(1) 190,000 PPH	Natural Gas Hydrogen & NG	0.12 LB/MMBTU 0.12 LB/MMBTU	1	DAF-45 W/FGR
D-0987-1	Certainteed Corp. Riverside, CA	Wicks A Type	(1) 35,000 PPH	Natural Gas Methanol	0.05 MMBTU 40 PPH @ 30 MMBTU	1	DAF-22 W/FGR
D-0985-1	General Electric Mt. Vernon, IN	Riley Stoker MH	(1) 150,000 PPH	Natural Gas No. 6 Oil	0.10 LB/MMBTU 0.39 LB/MMBTU (.15X FBN)	1	DAF-39
D-0984-2	Glendale Adventist Medical Center Glendale, CA	BBW FMG-39	(1) 23,500 PPH	Natural Gas No. 2 Oil	0.05 MMBTU	1	DAF-18 W/FGR



<u>JOB NO.</u>	<u>INSTALLATION</u>	<u>TYPE OF BOILER</u>	<u>(NO. OF UNITS) CAPACITY</u>	<u>FUEL TYPE</u>	<u>GUARANTEED AND/OR ACTUAL NOx LEVELS</u>	<u>NO. OF BURNERS/ BOILER</u>	<u>COEN METHOD OF NOx REDUCTION</u>
D-0980-1	Quality Assured Packing Stockton, CA	NBC NSE-65	(1) 75,000 PPH	Natural Gas	40 PPH	1	DAF-28
D-0979-1	Kal Kan Columbus, OH	CB DL-68E	(1) 50,000 PPH	Natural Gas	0.065 LB/MMBTU	1	DAF-24
D-0978-1	Takada Chemical Wilmington, NC	CB D-34	(1) 13,500 PPH	#2 Oil #6 Oil	85 Tons/Year (.35% FBN)	1	DAF-15 W/NOx Ports
D-0970-1 D-0969-1 D-0968-1	Shintech Freeport, TX	NBC NS-E-57	(3) 60,000 PPH	Natural Gas	0.09 LB/MMBTU	1	DAF-26
D-0963-1	Great Lakes Steel Zug Island, MI	Zurn 23M	(1) 135,000 PPH	Natural Gas	0.10 LB/MMBTU	1	DAF-36
D-0962-1	Great Lakes Steel Zug Island, MI	Zurn 21M	(1) 115,000 PPH	Natural Gas	0.10 LB/MMBTU	1	DAF-34
D-0960-1 D-0959-1 D-0958-1 D-0957-1 D-0956-1 D-0955-1	Indeck Power (Rental Units)	Zurn Keystone	(6) 150,000 PPH	Natural Gas	0.10 LB/MMBTU	1	DAF-36
D-0950-1	Consolidated Paper Biron, WI	B&W Stirling	(3) 60,000 PPH	Natural Gas	0.10 LB/MMBTU	1	DAF-28
D-0948-3 D-0948-4	E.R. Squibb Lawrenceville, NJ	B&W FM 103-70	(2) 70,000 PPH	Kerosene Natural Gas	0.11 LB/MMBTU 0.068 LB/MMBTU	1	DAF-28
D-0941-1	Bridgestone Tire La Vergne, TN	B&W FM-10-57	(1) 65,000 PPH	Natural Gas No. 2 Oil	0.10 LB/MMBTU	1	DAF-26
D-0940-1	SCH Chemicals Ashtabula, OH	NBC NS-F-77	(1) 100,000 PPH	Natural Gas No. 2 Oil	0.03 LB/MMBTU 0.25 LB/MMBTU (.03% FBN)	1	DAF-34 W/FGR
D-0931-1	Pacific Coast Pro. Lodi, CA	B&W FM106-88	(1) 120,000 PPH	Natural Gas No. 6 Oil	0.05 LB/MMBTU 0.29 LB/MMBTU (.15% FBN)	1	DAF-36 W/FGR
D-0926-1	Gaylord Container Bogalusa, LA	B&W FM 130-97	(1) 165,000 PPH	Natural Gas	0.12 LB/MMBTU	1	DAF-39
D-0924-1	IBM Manassas, VA	IBW TJU-C-62.5	(1) 62.5 MMBTU	Natural Gas	BACT	1	DAF-26
D-0918-1	Riley Stoker Stock Unit	Riley MHU	(1) 200,000 MMBTU	Natural Gas No. 2 Oil	0.20 LB/MMBTU	1	DAF-42
D-0916-1	Simpson Paper Tacoma, WA	Riley 2 Drum; Field Erected	(2) 300 MMBTU Gas 290 MMBTU Oil	No. 6 Oil	0.10 LB/MMBTU	2	DAF-39
D-0902-1 D-0901-1	Wabash Power Equip. Rental Unit	CE 35A14	(2) 150,000 PPH	Natural Gas No. 2 Oil (0% FBN) No. 6 Oil (.25% FBN)	0.19 LBS/MMBTU 0.20 LBS/MMBTU 0.39 LBS/MMBTU	1	DAF-42

<u>JOB NO.</u>	<u>INSTALLATION</u>	<u>TYPE OF BOILER</u>	<u>(NO. OF UNITS) CAPACITY</u>	<u>FUEL TYPE</u>	<u>GUARANTEED AND/OR ACTUAL NOx LEVELS</u>	<u>NO. OF BURNERS/ BOILER</u>	<u>COEN METHOD OF NOx REDUCTION</u>
D-0900-1	Desert Hospital Palm Springs, CA	Trane/Murray D-Type	(1) 30,000 PPH	Natural Gas Oil	40 PPH	1	DAF-20 W/FGR
D-0892-1	E.R. Squibb & Sons New Brunswick, NJ	NBC NS F 13-ECON	(2) 95,000 PPH	Natural Gas No. 2 Oil No. 6 Oil	0.10 LB/MMBTU 0.30 LB/MMBTU (.1% FBN)	1	DAF-30
D-0886-1	Minnesota Power Corp.	CE 12F40A16	(2) 250,000 PPH	Natural Gas	0.05 LB/MMBTU	2	DAF-36
D-0874-1	Louisiana State Univ. Baton Rouge, LA	NBC NS-F-77-ECON	(1) 100,000 PPH	Natural Gas	0.12 LB/MMBTU	1	DAF-32
D-0867-1	Gangi Bros. Riverbank, CA	NBC NSE-65	(2) 75,000 PPH	Natural Gas	30 PPH	1	DAF-28 W/FGR
D-0866-1 D-0865-1	Holman Boiler Works Rental Unit	CE 35A14	(2) 150,000 PPH	Natural Gas No. 2 Oil No. 6 Oil	0.20 LB/MMBTU 0.20 LB/MMBTU (0.01% FBN) 0.40 LB/MMBTU (0.25% FBN)	1	DAF-39
D-0862-1	Frito Lay Modesto, CA	NBC NSB-41	(1) 25,000 PPH	Natural Gas	40 PPH	1	DAF-18
D-0857-1	Hekoosa Paper Ashdown, AR	CE #3 Bark/Gas Power Boiler	(1) 520,000 PPH	Natural Gas	0.10 LB/MMBTU	4	DAF-36
D-0849-1	Spreckels Sugar Mendota, CA	CE VU60	(1) 250,000 PPH	Gas No. 2 Oil No. 6 Oil	0.085 LB/MMBTU 0.25 LB/MMBTU 0.55 LB/MMBTU	4	DAF-30 W/FGR
D-0846-1 D-0841-1	Wabash Power Rental Unit	NBC N2S-7-89	(1) 150,000 PPH	Natural Gas No. 2 Oil No. 6 Oil	0.20 LBS/MMBTU 0.20 LBS/MMBTU (0.01% FBN) 0.4 LBS/MMBTU (0.2% FBN)	1	DAF-42
D-0840-1 D-0839-1 D-0838-1 D-0837-1	Indeck Power Rental Unit	NBC NOS-1A-53S	(4) 40,000 PPH	Natural Gas No. 2 Oil No. 6 Oil	0.10 LBS/MMBTU 0.20 LBS/MMBTU (0.01% FBN) 0.40 LBS/MMBTU (0.20% FBN)	1	DAF-22
D-0836-1 D-0832-1 D-0831-1	Indeck Power Rental Unit	Zurn Keystone	(3) 150,000 PPH Derated	Natural Gas No. 6 Oil	0.05 LB/MMBTU	1	DAF-36 W/FGR
D-0829-1	Columbia Nitrogen Augusta, GA	Zurn Keystone 23M	(1) 150,000 PPH	Natural Gas No. 6 Oil		1	DAF-36
D-0825-1	Holman Boiler Rental Unit	NBC N2S-7-95	(1) 150,000 PPH	Natural Gas No. 2 Oil No. 6 Oil	0.20 LB/MMBTU 0.20 LB/MMBTU 0.30 LB/MMBTU (0.2% FBN)	1	DAF-39 Front Wall Nox Ports
D-0820-1	Soltex Polymers Deer Park, TX	NBC NS-F-77	(1) 100,000 PPH	Natural Gas	0.10 LBS/MMBTU	1	DAF-32

JOB NO.	INSTALLATION	TYPE OF BOILER	(NO. OF UNITS) CAPACITY	FUEL TYPE	GUARANTEED AND/OR ACTUAL NOX LEVELS	NO. OF BURNERS/ BOILER	COEN METHOD OF NOX REDUCTION
D-0804-1	Cambria Cogen. Fac. Ebensburg, PA	NBC NSE-65	(1) 78,000 PPH	Natural Gas	0.10 LB/MMBTU	1	DAF-28
D-0799-1	San Diego Gas & Elect. San Diego, CA	B&W FN10-70B	(2) 50,000 PPH	Natural Gas No. 2 Oil	0.10 LBS/MMBTU	1	DAF-24
D-0791-1	Arco Alaska, Inc. Prudhoe Bay, AK	Broach Heater	(1) 35,000 MMBTU	Gas	0.08 LB/MMBTU	1	DAF-22
D-0785-1	A.E. Staley Decatur, IL	Riley RX	(1) 125,000 PPH	Natural Gas	0.10 LBS/MMBTU	1	DAF-32
D-0779-1	3M Company Hutchinson, MN	NBC NS-E-68	(1) 80,000 PPH	Natural Gas No. 6 Oil	0.20 LB/MMBTU 0.40 LB/MMBTU (.3X FBN)	1	DAF-30
D-0768-2	Ogden Martin Systems Lawrence, MA	B&W F22 SPLAH15	(1) 100,000 PPH	Natural Gas No. 6 Oil	BACT	1	DAF-36
D-0768-1	Ogden Martin Systems Lawrence, MA	CE 30VP-12	(1) 115,000 PPH	Natural Gas No. 6 Oil	BACT	1	DAF-36
D-0766-1 D-0765-1 D-0764-1	Holman Boiler	CE 35A14	(3) 150,000 PPH	Natural Gas No. 2 Oil No. 6 Oil	0.20 LBS/MMBTU 0.20 LBS/MMBTU (0.01X FBN) 0.30 LBS/MMBTU (0.2X FBN)	1	DAF-39
D-0752-1 D-0751-1	Indeck Power	Zurn 24M	(2) 250,000 PPH	Natural Gas No. 2 Oil No. 6 Oil	0.10 LBS/MMBTU 0.28 LBS/MMBTU (0.01X FBN) 0.40 LBS/MMBTU (0.14X FBN)	1	DAF-45S
D-0748-1	E.I. Dupont New Johnsonville, TN	B&W FN120-97	(1) 150,000 PPH	Natural Gas No. 2 Oil	0.08 LB/MMBTU 0.20 LB/MMBTU (.01X FBN)	1	DAF-39
D-0747-1	O'Brien Energy Systems Parlin, NJ	ABCO Special	(1) 177,000 PPH	Natural Gas No. 2 Oil	0.20 LBS/MMBTU 0.20 LBS/MMBTU (0.01X FBN)	1	DAF-39
D-0745-1	Amoco Chemical Clute, TX	OPF Cabin Heater	(1) 30.4MM BTU/HR	Natural Gas	0.08 LB/MMBTU	1	DAF-18
D-0721-1	Indeck Power	Zurn 23M	(1) 150,000 PPH	Natural Gas No. 2 Oil No. 6 Oil	0.10 LB/MMBTU 0.20 LB/MMBTU (0.01X FBN) 0.40 LB/MMBTU (0.30X FBN)	1	DAF-36
D-0715-1	Boise Cascade Corp. Int. Falls, MN	Zurn Keystone	(2) 180,000 PPH	Natural Gas	0.05 LBS/MMBTU	1	DAF-42 W/FGR
D-0700-1	Union Texas Petroleum	Vogt DT-113-105	(1) 100,000 PPH	Natural Gas Off Gas Mixture	0.08 LBS/MMBTU 0.12 LB/MMBTU 0.10 LBS/MMBTU	1	DAF-34
D-0700-2	Union Texas Petroleum	CE 27VP14	(1) 150,000 PPH	Natural Gas Off Gas Mixture	0.08 LBS/MMBTU 0.12 LB/MMBTU 0.10 LBS/MMBTU	1	DAF-39

<u>JOB NO.</u>	<u>INSTALLATION</u>	<u>TYPE OF BOILER</u>	<u>(NO. OF UNITS) CAPACITY</u>	<u>FUEL TYPE</u>	<u>GUARANTEED AND/OR ACTUAL NOx LEVELS</u>	<u>NO. OF BURNERS/ BOILER</u>	<u>COEN METHOD OF NOx REDUCTION</u>
D-0698-1	Boeing - Plant II Seattle, WA	CB DL094E	(2) 80,000 PPH	Natural Gas No. 6 Oil	0.10 LB/MMBTU 0.30 LB/MMBTU (0.15% FBN)	1	DAF-30
D-0688-1	Kal Kan Vernon, CA	B&W FM101-88	(1) 75,000 PPH	Natural Gas Propane Gas	0.05 LBS/MMBTU 0.07 LBS/MMBTU	1	DAF-26 W/FGR
D-0687-1	Vicksburg Chemical Vicksburg, MS	FW AG5150B	(1) 150,000 PPH	Natural Gas	0.20 LBS/MMBTU	1	DAF-42
D-0681-1	Indeck Power	Nebraska NOS-2-67	(1) 75,000 PPH	Natural Gas No. 2 Oil	0.10 LBS/MMBTU 0.20 LBS/MMBTU (0.01% FBN)	1	DAF-28
D-0679-1	Whiteman AFB Knob Noster, MO	NBC NS-E-58	(1) 60,000 PPH	No. 2 Oil Natural Gas	0.12 LBS/MMBTU (0.01% FBN) 0.14 LBS/MMBTU	1	DAF-26
D-0674-1 D-0673-1 D-0672-1 D-0671-1	Indeck Power	Nebraska NOS-2-67	(4) 75,000 PPH	Natural Gas No. 2 Oil	0.10 LBS/MMBTU 0.20 LBS/MMBTU (0.01% FBN)	1	DAF-28
D-0668-1	Union Texas Petroleum Geismar, LA	Zurn Keystone	(1) 200,000 PPH	Natural Gas Off Gas	0.10 LB/MMBTU 0.10 LB/MMBTU	1	DAF-45
D-0661-1	Willamette Industries Bennettsville, SC	CE 12F33A/B	(1) 223,500 PPH	Natural Gas	0.20 LB/MMBTU	2	DAF-34
D-0658-1	Salinas Supply Corp. Salinas, CA	NBC NS-E-68-SH	(1) 65,000 PPH	Natural Gas	0.065 LB/MMBTU	1	DAF-28
D-0657-1	Folgers Coffee Co. Sherman, TX	CE 25-A-12	(1) 75,000 PPH	Natural Gas	0.10 LBS/MMBTU	1	DAF-28
D-0639-1 D-0638-1	Wabash	CE 35A14	(2) 150,000 PPH	Natural Gas No. 2 Oil No. 6 Oil	0.19 LBS/MMBTU 0.20 LBS/MMBTU (0.01% FBN) 0.40 LBS/MMBTU (0.25% FBN)	1	DAF-42
D-0637-1 D-0636-1 D-0635-1	Indeck Power	Nebraska NOS-2-52(S)	(3) 75,000 PPH	Natural Gas No. 2 Oil	0.10 LBS/MMBTU 0.20 LBS/MMBTU (0.01% FBN)	1	DAF-28
D-0634-1	Darling Delaware Vernon, Calif.	Nebraska N25-6-69	(1) 80,000 PPH	Natural Gas	40 PPH	1	DAF-30
D-0631-1	Shell Sarnia Ontario, Canada	CE 35A14	(1) 150,000 PPH	Natural Gas No. 2 Oil No. 6 Oil	0.20 LBS/MMBTU 0.20 LBS/MMBTU (0.01% FBN) 0.40 LBS/MMBTU (0.25% FBN)	1	DAF-42
D-0630-1	Indeck Power	Nebraska NOS-2-52(S)	(1) 75,000 PPH	Natural Gas No. 2 Oil	0.10 LBS/MMBTU 0.20 LBS/MMBTU (0.01% FBN)	1	DAF-28
D-0627-1	Chevron St. James, LA	CE 12F35A16/42*	(1) 250,000 PPH	Natural Gas Process Gas	0.099 LB/MMBTU	2	DAF-36 W/FGR
D-0626-1	Monsanto Envir. Chem Bradenton, FL	B&W FM117-88	(1) 120,000 PPH	Natural Gas No. 2 Oil	0.05 LBS/MMBTU 0.10 LBS/MMBTU (.05% FBN)	1	DAF-39

<u>JOB NO.</u>	<u>INSTALLATION</u>	<u>TYPE OF BOILER</u>	<u>(NO. OF UNITS) CAPACITY</u>	<u>FUEL TYPE</u>	<u>GUARANTEED AND/OR ACTUAL NOX LEVELS</u>	<u>NO. OF BURNERS/ BOILER</u>	<u>COEN METHOD OF NOX REDUCTION</u>
D-0620-1	E.I. Dupont Delisle, MS	B&W FM 120-97	(1) 180,000 PPH	Natural Gas No. 2 Oil	0.086 LB/MMBTU 0.20 LB/MMBTU (.005% FBN)	1	DAF-42
D-0615-1	Arizona Chemical Co. Panama City, FL	CE 35A14	(1) 125,000 PPH	Natural Gas Pitch Tarcores		1	DAF-36
D-0603-1	Dow Chemical Midland, MI	NBC NS-E-58	(2) 60,000 PPH	Natural Gas	0.07 LB/MMBTU	1	DAF-24
D-0599-1	Peru Municipal Util. Peru, IL	Zurn FIELD ERECTED	(1) 105,000 PPH	Natural Gas No. 2 Oil	0.10 LB/MMBTU 0.20 LB/MMBTU	2	DAF-26
D-0595-1	Royal Tallow San Francisco, CA	NBC NS-E-52	(1) 50,000 PPH	Natural Gas No. 2 Oil	40 PPM	1	DAF-26 W/FGR
D-0591-1	Ashland Petroleum St. Paul, MN	Vertical Heater	(1) 120 MMBTU	H2 Waste Light/heav. Oil	Various	1	DAF-32
D-0589-1	City of Huntsville Huntsville, AL	NBC NSF-B4SH	(2) 100,000 PPH	Natural Gas No. 2 Oil	0.10 LB/MMBTU 0.10 LB/MMBTU (0.01% FBN)	1	DAF-36 W/FGR
D-0589-2	City of Huntsville Huntsville, AL	NBC NS-F-B4SH	(2) 100,000 PPH	Natural Gas Landfill Gas No. 2 Oil	0.10 LB/MMBTU 0.10 LB/MMBTU 0.10 LB/MMBTU (0.01% FBN)	1	DAF-36 W/FGR
D-0588-1	Hopevell Cogeneration Hopevell, VA	B&W Special FM	(2) 180,000 PPH	Natural Gas No. 2 Oil	0.10 LB/MMBTU 0.10 LB/MMBTU (0.02% FBN)	1	DAF-42 W/FGR
D-0585-1	New England Submarine Base Groton, CT	IBW VSG 36.5	(1) 84,150 PPH	No. 5 Oil	0.20 LB/MMBTU (0.3% FBN)	2	DAF-22 W/Front Wall NOx Ports
D-0581-1	S.D. Warren Hinkley, ME	B&W FM 10-79	(1) 60,000 PPH	No. 2 Oil	0.148 LB/MMBTU (.04% FBN)	1	DAF-24
D-0577-1	Consolidated Paper Stevens Point, WI	CE 33A13/48"	(1) 140,000 PPH	Natural Gas	0.10 LB/MMBTU	1	DAF-36
D-0573-1	McClellan AFB Sacramento, CA	NBC NS-B-44	(3) 25,000 PPH	Natural Gas No. 2 Oil No. 5 Oil	40 PPM 115 PPM (0.10% FBN)	1	DAF-18 W/FGR
D-0571-1	Harter Packing Yuba City, CA	NBC NSE 68	(1) 80,000 PPH	Natural Gas No. 6 Oil	40 PPM	1	DAF-30 W/FGR
D-0569-1	McDonnell Douglas Ontario, Canada	NBC N2S-7-89	(1) 150,000 PPH	Natural Gas No. 2 Oil	0.20 LB/MMBTU 0.20 LB/MMBTU (0.01% FBN)	1	DAF-42
D-0566-1	Quantum Ethylene Deerpark, TX	CE 34VP14/48"	(2) 160,000 PPH	Natural Gas	0.10 LB/MMBTU	1	DAF-45
D-0564-1	U.S. Army Military Academy	Keeler	(2) 200,000 PPH	No. 6 Oil	0.30 LB/MMBTU (0.35% FBN)	4	DAF-25 W/ Floor NOx Ports
D-0564-2	West Point, NY						
D-62-1	Occidental Chemical Lake Charles, LA	Zurn	(1) 245 MMBTU	Natural Gas Tail gas	0.10 LB/MMBTU 0.10 LB/MMBTU	1	DAF-45 W/FGR

<u>JOB NO.</u>	<u>INSTALLATION</u>	<u>TYPE OF BOILER</u>	<u>(NO. OF UNITS) CAPACITY</u>	<u>FUEL TYPE</u>	<u>GUARANTEED AND/OR ACTUAL NOx LEVELS</u>	<u>NO. OF BURNERS/ BOILER</u>	<u>COEN METHOD OF NOx REDUCTION</u>
0-0560-1	Stauffer Chemical Dominguez, CA	Zurn	(1) 40 PPH	Natural Gas	70 PPM	1	DAF-24
0-0557-1	Ragu Foods Stockton, CA	NBC N2S-7-89-ECON	(1) 150,000 PPH	Natural Gas	40 PPM	1	DAF-36 W/FGR
0-0550-1	Canners Steam Company Terminal Island, CA	Union Iron Works	(1) 100 K PPH	Natural Gas No. 6 Oil	40 PPM	4	DAF-20 W/ FGR
0-0530-1	Standard Rendering Houston, TX	NBC NS-0-54	(1) 50,000 PPH	Natural Gas No. 2 Oil	0.12 LB/MMBTU 0.16 LB/MMBTU (0.01% FBN)	1	DAF-25
0-0521-1	General Electric Mt. Vernon, IN	NBC N2S-S-114	(1) 200,000 PPH	Natural Gas	0.20 LB/MMBTU	1	DAF-42
0-0513-1	L.A. County Landfill SPADRA Project	Zurn Keystone	(1) 110 MMBTU	Landfill Gas	24 PPM	1	DAF-36 W/FGR
0-0478-1 0-0478-2	Simpson Paper Pasadena, TX	Zurn 23M	(2) 150,000 PPH	Natural Gas	0.10 LB/MMBTU	1	DAF-36
0-0475-1	James River Paper Milford, NJ	NBC N2S-7-97SH	(1) 120,000 PPH	Natural Gas No. 2 Oil	33.3 PPM 31.9 PPM (0.04% FBN)	1	DAF-36
0-0437-1	Arco Crane, TX	Wickes 90-3K-8	(2) 100,000 PPH	Natural Gas	0.20 LB/MMBTU	1	DAF-36
0-423-1	Luz-SEGS II Daggett, CA	CE/Mitsubishi	(1) 190 MMBTU Per Burner	Natural Gas Waste Oil (0.03% FBN)	80 PPM	2	DAF-39
0-0397-1	San Joaquin Milk Prod. Turlock, CA	NBC NSC-61 ECON	(2) 50,000 PPH	Natural Gas No. 2 Oil No. 5 Oil	70 PPM 84 PPM (0.045% FBN)	1	DAF-24
0-0389-1	Mobil Oil Corp. McKittrick, CA	Struthers Thermaflood Htr.	(1) 62.5 MMBTU	Natural Gas		1	DAF-24 W/FGR
0-0384-1	Indiana University Bloomington, IN	UIV Field Erected	(1) 75,000 PPH	Natural Gas No. 2 Oil	0.10 LB/MMBTU 0.10 LB/MMBTU (.05% FBN)	2	DAF-28
0-0376-1 0-0375-1 0-0374-1	Columbia University New York, NY	B&W FM103-88	(3) 88,000 PPH	Natural Gas No. 6 Oil	0.10 LB/MMBTU 0.30 LB/MMBTU (0.3% FBN)	1	DAF-26 W/Front Wall NOx Ports
0-0367-2	Inland Steel New Carlisle, IN	ERI/NBC Waste Heat Blr.	(1) 124.3 MMBTU	Natural Gas	0.05 LB/MMBTU	1	DAF-32
0-0367-1	Inland Steel New Carlisle, IN	NBC NSE-57	(1) 58,400 PPH	Natural Gas	40 PPM	1	DAF-28
0-0358-2	Harrison Radiator Dayton, OH	C.E. "A" Type 33-7KT-10	(1) 200,000 PPH	Natural Gas No. 2 Oil	0.20 LB/MMBTU 0.30 LB/MMBTU (0.05% FBN)	1	DAF-39
0-0358-1	Harrison Radiator Dayton, OH	C.E. "A" Type 96-4KT-5	(2) 120,000 PPH	Natural Gas No. 2 Oil	0.20 LB/MMBTU 0.30 LB/MMBTU (0.05% FBN)	1	DAF-36
0-46-1	General Electric Burkville, AL	Nebraska N2S-109	(1) 200,000 PPH	Natural Gas	0.20 LB/MMBTU	1	DAF-42

MARCH 26, 1993

COEN COMPANY INCORPORATED  
LOW NOX INSTALLATION LIST

Page 18

<u>JOB NO.</u>	<u>INSTALLATION</u>	<u>TYPE OF BOILER</u>	<u>(NO. OF UNITS) CAPACITY</u>	<u>FUEL TYPE</u>	<u>GUARANTEED AND/OR ACTUAL NOX LEVELS</u>	<u>NO. OF BURNERS/ BOILER</u>	<u>COEN METHOD OF NOX REDUCTION</u>
D-0345-1	General Electric Burkville, AL	Nebraska NS-E-68	(1) 85,500 PPH	Natural Gas No. 2 Oil	0.20 LB/MMBTU 0.20 LB/MMBTU (0.01% FBN)	1	DAF-30
D-0342-1	Westinghouse Electric Sunnyvale, CA	Zurn Field Erected Boiler	(1) 300,000 PPH	Natural Gas	40 PPH	2	DAF-39 W/FR
D-0332-1	E & J Gallo Winery Modesto, CA	Nebraska NSF-84	(1) 115,000 PPH	Natural Gas No. 6 Oil	0.10 LB/MMBTU 0.20 LB/MMBTU (0.2% FBN)	1	DAF-30 W/Front Wall NOx Ports
D-0324-4	Sun Oil Company Yabucoa, Puerto Rico	Zurn 20M	(1) 115,000 PPH	Refinery Gas Pitch	- 0.43 LB/MMBTU (1.08% FBN)	1	DAF-34 W/Front Wall NOx Ports
D-0324-3	Sun Oil Company Yabucoa, Puerto Rico	B&W FM 117-97	(1) 150,000 PPH	Refinery Gas Pitch	- 0.43 LB/MMBTU (1.08% FBN)	1	DAF-36 W/Front Wall NOx Ports
D-0324-2	Sun Oil Company Yabucoa, Puerto Rico	B&W FM 106-79	(1) 100,000 PPH	Refinery Gas Pitch	- 0.43 LB/MMBTU (1.08% FBN)	1	DAF-30 W/Front Wall NOx Ports
D-0324-1	Sun Oil Company Yabucoa, Puerto Rico	Nebraska NSF-82	(1) 100,000 PPH	Refinery Gas Pitch	- 0.43 LB/MMBTU (1.08% FBN)	1	DAF-30 W/Front Wall NOx Ports
194-1	SOHIO Oil Company Toledo, OH	B&W CO Boiler	(1) 450,000 PPH 180°F Air	Refinery Gas Refinery Gas/ No. 6 Oil	0.10 LB/MMBTU 0.157 LB/MMBTU (0.35% FBN)	6	DAF-30
D-0286-2	Mobil Oil Co. Torrance, CA	ECIW	(1) 200,000 PPH 565°F Air	Natural/ Refinery Gas	0.095 LB/MMBTU	4	DAF-28
D-0286-1	Mobil Oil Co. Torrance, CA	B&W PFI-3161	(1) 220,000 PPH 460°F Air	Natural/ Refinery Gas	0.12 LB/MMBTU	3	DAF-26
D-0284-1	Holman Boiler Works Dallas, TX (Rental)	Zurn 19M	(1) 100,000 PPH	Natural Gas No. 2 Oil No. 6 Oil	0.20 LB/MMBTU 0.20 LB/MMBTU 0.30 LB/MMBTU (0.2% FBN)	1	DAF-32 W/Front Wall NOx Ports
D-0283-1	Holman Boiler Works (Rental)	UIW "A"	(1) 100,000 PPH	Natural Gas No. 2 Oil No. 6 Oil	0.20 LB/MMBTU 0.20 LB/MMBTU 0.30 LB/MMBTU (0.2% FBN)	1	DAF-36 W/Front Wall NOx Ports
D-0282-1	Holman Boiler Works (Rental)	Nebraska N2S-7-113SH	(1) 150,000 PPH	Natural Gas No. 2 Oil No. 6 Oil	0.20 LB/MMBTU 0.20 LB/MMBTU 0.30 LB/MMBTU (0.2% FBN)	1	DAF-39 W/Front Wall NOx Ports
D-0281-1 D-0280-1	Holman Boiler Works (Rental)	Nebraska N2S-7-95	(2) 150,000 PPH	Natural Gas No. 2 Oil No. 6 Oil	0.20 LB/MMBTU 0.20 LB/MMBTU 0.30 LB/MMBTU (0.2% FBN)	1	DAF-39 W/Front Wall NOx Ports
D-0274-1	Ponderay Newsprint Usk, WA	Nebraska N2S-7-112	(1) 180,000 PPH	Propane	0.20 LBS/MMBTU	1	DAF-36

MARCH 26, 1993

COEN COMPANY INCORPORATED  
LOW NOX INSTALLATION LIST

Page 19

<u>JOB NO.</u>	<u>INSTALLATION</u>	<u>TYPE OF BOILER</u>	<u>(NO. OF UNITS) CAPACITY</u>	<u>FUEL TYPE</u>	<u>GUARANTEED AND/OR ACTUAL NOX LEVELS</u>	<u>NO. OF BURNERS/ BOILER</u>	<u>COEN METHOD OF NOX REDUCTION</u>
D-0268-1	Quality Assured Packing Stockton, CA	B&W FM 10-52A	(1) 30,000 PPH	Natural Gas No. 2 Oil	40 PPH 70 PPH (0.01% FBN)	1	DAF-20
D-0267-2	Hoffman La Roche Belvidere, NJ	B&W FM 117-976	(1) 142,000 PPH 600°F Air	Natural Gas Oil	0.68 LB/MMBTU 0.90 LB/MMBTU (0.3% FBN)	1	DAF-36
D-0267-1	Hoffman La Roche Belvidere, NJ	CE A Type	(1) 70,000 PPH 350°F Air	Natural Gas No. 6 Oil	0.28 LB/MMBTU 0.52 LB/MMBTU (0.3% FBN)	1	DAF-28
D-0243-2	Newsprint South Grenada, MS	B&W FM-117-88	(1) 135,000 PPH	Natural Gas	0.20 LB/MMBTU	1	DAF-36
D-0243-1	Newsprint South Grenada, MS	Keele MMBTU Steam Generator	(1) 200,000 PPH	Natural Gas	0.20 LBS/MMBTU at 135,000 PPH	2	DAF-36
D-0226-1	Takeda Chemical Co. Wilmington, NC	Nebraska NS-B-25	(1) 13,500 PPH	No. 6 Oil	85 Tons/Year based upon average load of 85 MMBTU/HR, both boilers operating continuously	1	DAF-15
D-0225-1	Takeda Chemical Co. Wilmington, NC	Nebraska NS-F-67	(1) 90,000 PPH	No. 6 Oil	85 Tons/Year based upon average load of 85 MMBTU/HR, both boilers operating continuously	1	DAF-26 W/Front Wall NOx Ports
D-0207-1	Holman Boiler Works Dallas, TX	Zurn 23-M	(1) 150,000 PPH	Natural Gas #2/#6 Oil	0.20 LB/MMBTU 0.40 LB/MMBTU (0.25% FBN)	1	DAF-42
D-0161-1	Georgia Pacific Port Hudson, LA	C.E. 35A14	(1) 150,000 PPH	Natural Gas	0.10 LBS/MMBTU	1	DAF-39 W/FGR
D-0123-1	Amer. 1 Co-Gen Project King City, CA	Nebraska NSF-87	(2) 136.5 MMBTU 132.2 MMBTU	Natural Gas No. 2 Oil	40 PPH 69 PPH	1	DAF-34 W/FGR
D-0121-1	Campbell Soup Company Maxton, NC	Nebraska	(1) 150,000 PPH	Natural Gas No. 2 Oil No. 6 Oil	0.20 LB/MMBTU 0.20 LB/MMBTU 0.40 LB/MMBTU	1	DAF-34 W/Stone Wall NOx Ports
D-0064-1	Reynolds Metals Gregory, TX	FW	(1) 360,000 PPH	T.E.G.	0.06 LBS/MMBTU (50 PPH)	6	DAF-31
D-0036-1	Union Oil Company Wilmington, CA	Zurn	(1) 150,000 PPH	Refinery Gas	0.10 LBS/MMBTU	1	FGR
D-9995-1	Detroit Edison Detroit, MI	B&W FM 120-97L	(1) 150,000 PPH	Natural Gas	0.10 LBS/MMBTU	1	DAF-42
D-9961-2	Pantex Power Plant Amarillo, TX	B&W FM 9-39	(2) 25,000 PPH	Gas and No. 2 Oil	0.12 LBS/MMBTU	1	DAF-18
D-9961-1	Pantex Power Plant Amarillo, TX	B&W FM 10-66	(2) 50,000 PPH	Gas and No. 2 Oil	0.12 LBS/MMBTU	1	DAF-24



<u>JOB NO.</u>	<u>INSTALLATION</u>	<u>TYPE OF BOILER</u>	<u>(NO. OF UNITS) CAPACITY</u>	<u>FUEL TYPE</u>	<u>GUARANTEED AND/OR ACTUAL NOX LEVELS</u>	<u>NO. OF BURNERS/ BOILER</u>	<u>COEN METHOD OF NOX REDUCTION</u>
D-9958-1	New York Hospital New York, NY	B&W FM 117-97B	(1) 125,000 PPH	No. 6 Oil	0.40 LBS/MMBTU (0.5% FBN)	1	DAF-30 W/Side Wall NOx Ports
D-9915-1 D-9915-2	Camarillo Hospital Camarillo, CA	B&W FM10-52	(2) 25,000 PPH	Natural Gas No. 2 Oil	40 PPM 115 PPM (0.06% FBN)	1	DAF-18
D-9912-1 D-9912-2	Chino Cogeneration Chino, CA	B&W FM10-52	(2) 25,000 PPH	Natural Gas No. 2 Oil	40 PPM 115 PPM (0.06% FBN)	1	DAF-18
D-9911-1	V.A. Hospital Kansas City, MO	C.E. 6 (WU10)16A	(2) 19,500 PPH	Natural Gas No. 2 Oil	0.10 LBS/MMBTU 0.30 LBS/MMBTU	1	FGR
D-9879-1	Union Oil Company Of California Wilmington, CA	C.E. 35A15	(1) 200,000 PPH	Refinery Gas No. 6 Oil	0.12 LBS/MMBTU 0.35 LBS/MMBTU (0.25% FBN)	1	FGR
D-9851-1	V.A. Medical Center Cincinnati, OH	Titusville 3 Drum	(3) 24,000 PPH	Natural Gas No. 2 Oil	0.10 LBS/MMBTU 0.3 LBS/MMBTU	1	FGR
D-9834-1	Minnesota Power and Light Company Duluth, MN	Zurn Field Erected	(1) 120 MMBTU	Gas	0.20 LBS/MMBTU	4	DAF-34
D-9821-1	Chevron U.S.A. El Segundo, CA	C.E. 12F40A16	(1) 381.2 MMBTU	Natural Gas Refinery Gas	0.10 LBS/MMBTU	2	FGR
.798-1	Tinker Air Force Base Oklahoma City, OK	Nebraska N2T-7-93	(1) 114,000 PPH	Gas and No. 2 Oil	0.10 LBS/MMBTU	1	FGR
D-9792-1	Coyote Canyon LFG Project Orange County, CA	Zurn	(1) 255.86 MMBTU	Landfill Gas	48 PPM (Vol. Dry Ref. 3% O2)	2	FGR
D-9728-1	Shell Western Sheradon, TX	Zurn 23M Keystone	(1) 150,000 PPH	Natural Gas	0.10 LBS/MMBTU	1	FGR
D-9716-1	Newport Naval Newport, RI	Nebraska NS-F-87-SH(S)	(1) 90,000 PPH	Gas and No. 5 Oil	0.10 LBS/MMBTU 0.30 LBS/MMBTU (0.23% FBN)	1	FGR
D-9706-1	Gilroy Foods Gilroy, CA	Nebraska NSE-68	(2) 86,890 PPH	Natural Gas No. 2 Oil	40 PPM (Vol. Dry Ref. 3% O2)	1	FGR
D-9697-1	L.A. County Sanitation District Carson, CA	B&W FM-10-57	(1) 44,000 PPH	Gas (Oil Backup)	45 PPM (Vol. Dry Ref. 3% O2)	1	FGR
D-9645-3	U.C. Berkeley Berkeley, CA	Union Iron Works	65 MMBTU/ (1) Per Burner	Gas and Oil	BACT	2	DAF-26
D-9645-2 D-9645-1	U.C. Berkeley Berkeley, CA	Zurn	(1) 43.3 MMBTU/ Per Burner	Gas and Oil	BACT	3	DAF-22
D-9591-2	Shepard Oil Jennings, LA	Nebraska Boiler N25789	(1) 150,000 PPH	No. 6 Oil No. 2 Oil	0.10 LBS/MMBTU No Requirements	1	DAF-36 W/FGR
D-9570-1	Commonwealth Edison Chicago, IL	Nebraska Boiler NS-F-82	(1) 110,000 PPH	Natural Gas	79 PPM (Vol. Dry Ref. 3% O2)	1	FGR
61-1	Boise Cascade Deridder, LA	Babcock & Wilcox FM-120-97	(2) 165,000 PPH	Natural Gas	83 PPM (Vol. Dry Ref. 3% O2)	1	FGR

JOB NO.	INSTALLATION	TYPE OF BOILER	(NO. OF UNITS) CAPACITY	FUEL TYPE	GUARANTEED AND/OR ACTUAL NOx LEVELS	NO. OF BURNERS/ BOILER	COEN METHOD OF NOx REDUCTION
D-9425-1	Los Angeles Sanitation District	Zurn Keystone Type 'O'	(2) 264,000 PPH (330 MMBTU)	Land Fill Gas (420BTU/FT <sup>3</sup> )	60 PPM (Vol. Dry Reference)	2 3% O <sub>2</sub>	FGR To 220 MKBTU
D-9351-1	Occidental Petroleum Lake Charles, LA	C.E. 33-A-16	(2) 180,000 PPH (268 MMBTU)	Natural Gas	75 PPM (Vol. Dry Ref. 3% O <sub>2</sub> )	2	FGR
D-9293-1	Integrated Protein Corona, CA	Nebraska NS-C-42	(2) 30,000 PPH (36 MMBTU)	Natural Gas No. 2 Oil	30 PPM (Vol. Dry Ref. 3% O <sub>2</sub> )	1	FGR
D-9279-1	Palmdale A.F.B. Palmdale, CA	ISW TJW (HTHW)	(2) 23 MMBTU (Input)	Natural Gas No. 2 Oil	65 PPM (Vol. Dry Ref. 3% O <sub>2</sub> )	1	FGR
D-9252-1	Frito Lay Bakersfield, CA	Eabcock & Wilcox FM-10-79	(1) 62,000 PPH (78 MMBTU)	Natural Gas Future #2 Oil	40 PPM (Vol. Dry Ref. 3% O <sub>2</sub> )	1	FGR
D-9203-1	ISM San Jose, CA	Cleaver Brooks D-60	(1) 36,000 PPH (45 MMBTU)	Natural Gas No. 2 Oil	40 PPM (Vol. Dry Ref. 3% O <sub>2</sub> )	1	FGR
D-9140-1	Stamislau's Foods Modesto, CA	Nebraska NS-G-101	(1) 100,000 PPH (162 MMBTU)	Natural Gas No. 6 Oil	65 PPM (Vol. Dry Ref. 3% O <sub>2</sub> )	1 Gas Only	FGR
D-9002-1	Union Oil Santa Maria, CA	Nebraska NSF-91	(1) 100,000 PPH (127 MMBTU)	Natural Gas No. 2 Oil	0.12 LBS/MMBTU 0.12 LBS/MMBTU	1	Side Wall NOx Ports
D-8943	Pfizer Groton, CT	Eabcock & Wilcox FM-140-97	(1) 195,000 PPH (250 MMBTU)	No. 6 Oil	0.30 LBS/MMBTU	2	Side Wall NOx Ports
D-8879	Lectromelt Longview, TX	Nebraska NS-C-49	(1) 30,000 PPH (39 MMBTU)	Natural Gas No. 2 Oil	0.12 LB/MMBTU 0.12 LBS/MMBTU	1	Side Wall NOx Ports
D-8811	City of Hope Durante, CA	Nebraska NS-E-75SH	(1) 55,000 PPH (70 MMBTU)	Natural Gas No. 2 Oil	0.09 LBS/MMBTU 0.09 LBS/MMBTU	1	Front Wall NOx Ports
D-8795	Murphy Oil Heraux, LA	Nebraska NS-E-84	(1) 80,000 PPH (100 MMBTU)	Refinery Gas Natural Gas	0.15 LBS/MMBTU 0.15 LBS/MMBTU	1	Side Wall NOx Ports
D-8523	Mobil Oil Joliet, IL	C.E. VU-60 Watertube	(1) 400,000 PPH (576 MMBTU)	Refinery Gas No. 6 Oil	0.20 LBS/MMBTU 0.20 LBS/MMBTU	4	Side Wall NOx Ports
D-8439	Arco North Slope, AK	G.C. Broach (Glycol Heater)	(2) 73.7 MMBTU	Natural Gas	0.08 LBS/MMBTU	1	Front Wall NOx Ports
D-8365	Willamette Industries Port Huene, CA	Nebraska NS-E-955H	(1) 68,200 PPH (99 MMBTU)	Natural Gas No. 2 Oil	75 PPM (Vol. Dry Ref. 3% O <sub>2</sub> )	1	Front Wall NOx Ports
D-8327	Ind. Valley Energy Co. Bakersfield, CA	Eabcock & Wilcox FM-9-57B	(1) 20,000 PPH (26 MMBTU)	Refinery Gas Natural Gas	70 PPM (Vol. Dry Ref. 3% O <sub>2</sub> )	1	Front Wall NOx Ports
D-8233	Shell Oil Woodriver, IL	Riley Stoker Field Erected Watertube	(1) 250,000 PPH (384 MMBTU)	Refinery Gas No. 6 Oil Ref. P-1000	0.14 LBS/MMBTU 0.23 LBS/MMBTU 0.28 LBS/MMBTU	4	Side Wall NOx Ports
D-7829	University of Wyoming Laramie, WY	ISW Cross Drum Watertube	(3) Natural Gas (77 MMBTU)	Oil	0.20 LBS/MMBTU 0.30 LBS/MMBTU	2	Front Wall NOx Ports
D-6348	Texas A and M College Station, TX	Vogt CL-VS-P Watertube	(1) 300,000 PPH (425 MMBTU)	Refinery Gas No. 2 Oil	0.20 LBS/MMBTU 0.30 LBS/MMBTU	4	Biased Firing
D-4935	Phillips Petroleum Kansas City, KS	Vogt CL-VS-P Watertube	(1) 300,000 PPH (425 MMBTU)	Refinery Gas Ref. P-1000	0.20 LBS/MMBTU 0.30 LBS/MMBTU	4	Biased Firing
EXPORT	Electricite De France Paris, France (Gennevillier Station)	Eabcock & Wilcox Watertube	(1) 528,000 PPH	No. 6 Oil		12	FGR

TOTAL AMOUNT OF JOBS: 444

**FABER BURNER — LOW-NO<sub>x</sub> BURNER PROJECTS**

**40 ppm OR LESS — FIRING NATURAL GAS**

	<u>Quantity</u>	<u>Boiler capacity</u>	<u>Boiler manufacturer</u>
Tampella Power Williamsport, PA	1	17,500 pph	TP — Package
International Business Machines San Jose, CA	1	36,000 pph	TP — Package
Formosa Plastics Co. Point Comfort, TX	2 3	35,000 pph 55,000 pph	TP — Package
Miller Brewing Co. Irwindale, CA	4	50,000 pph	TP — Package
Veterans Administration Medical Center Sheridan, WY	1	12,500 pph	TP — CP
Veterans Administration Medical Center Los Angeles, CA	1	45,000 pph	B&W — Package
Veterans Administration Medical Center Des Moines, IA	1 2	20,000 pph 15,000 pph	B&W — Package
General Motors Proving Grounds Milford, MI	2	50,000 pph	(1) B&W — Package (1) TP — Package
Armstrong World Industries South Gate, CA	1	9,000 pph	TP — CP
Nationwide Boiler Co. Fremont, CA	2	75,000 pph	Nebraska — Package
Canadian Forces Base Halifax, Nova Scotia	1	60,000 pph (No. 6 oil)	TP — Package
Hershey Chocolate Hershey, PA	3	40,000 pph	TP — Package
Kimberly Clark Fullerton, CA	1	40,000 pph	B&W — Package
Farmer John Vernon, CA	3	23,000 pph 12,000 pph	(1) CE — Marine (2) B&W — Package
3M Corporation Camarillo, CA	2	30,000 pph 22,000 pph	Nebraska — Package Trane — Package
Georgia Pacific Buena Park, CA	1	30,000 pph	TP — Package
Medical Center Co. Cleveland, OH	1	100,000 pph	Nebraska — Package
Sunkist Growers Ontario, CA	1	40,000 pph	B&W — Package
Luzerne County Wilkes-Barre, PA	3	17,500 pph	TP — Package

## APPENDIX D. SCALED COST EFFECTIVENESS VALUES

The following tables present cost effectiveness figures for the cost cases analyzed in Chapter 6 and listed in Table 6-4. These costs are based on the annual costs calculated in Appendices E, F, and G for 46 different boiler, fuel, and NO<sub>x</sub> control combinations. To estimate cost effectiveness for the boiler capacities listed in this appendix, which in most cases differ from the actual capacities of the 42 boilers cases, the logarithmic relationship known as the "six-tenths" power rule was used (Reference 5 of Chapter 6). Cost estimates for distillate- and residual oil-firing were based on the annual costs of natural gas-fired boilers calculated in Appendix E, using appropriate baseline NO<sub>x</sub> emission values and fuel prices.

This appendix contains the following tables:

<u>Cost Case</u>	<u>Page</u>
<b>Natural-gas-fired:</b>	
Packaged watertube, 45 MMBtu/hr, with WI and O <sub>2</sub> trim	D-3
Packaged firetube, 10.5 MMBtu/hr, with WI and O <sub>2</sub> trim	D-3
Packaged watertube, 51, 75, and 265 MMBtu/hr, with LNB	D-4
Packaged watertube, 265 MMBtu/hr, with LNB and CEM	D-5
Packaged watertube, 17.7 and 41.3 MMBtu/hr, with LNB and FGR	D-5
Packaged watertube, 45, 55, and 265 MMBtu/hr, with LNB and FGR	D-6
Packaged watertube, 81.3, 91, and 265 MMBtu/hr, with LNB, FGR, and CEM	D-7
Packaged firetube, 2.9-33.5 MMBtu/hr, with FGR and O <sub>2</sub> trim	D-8
Packaged watertube, 50-250 and 100 MMBtu/hr, with SCR	D-9
Field-erected wall-fired, 75 MMBtu/hr, with BOOS and O <sub>2</sub> trim	D-10
Field-erected wall-fired, 75 MMBtu/hr, with BOOS, WI, and O <sub>2</sub> trim	D-10
Field-erected wall-fired, 590 and 1,300 MMBtu/hr, with LNB	D-11
<b>Distillate-oil-fired:</b>	
Packaged watertube, 51, 75, and 265 MMBtu/hr, with LNB	D-12
Packaged watertube, 265 MMBtu/hr, with LNB and CEM	D-13
Packaged watertube, 17.7 and 41.3 MMBtu/hr, with LNB and FGR	D-13
Packaged watertube, 45, 55, and 265 MMBtu/hr, with LNB and FGR	D-14
Packaged watertube, 81.3, 91, and 265 MMBtu/hr, with LNB, FGR, and CEM	D-15
Packaged watertube, 50-250 and 100 MMBtu/hr, with SCR	D-16
Packaged firetube, 2.9-33.5 MMBtu/hr, with FGR and O <sub>2</sub> trim	D-17
Field-erected wall-fired, 590 and 1,300 MMBtu/hr, with LNB	D-17

<u>Cost Case</u>	<u>Page</u>
<b>Residual-oil-fired:</b>	
Packaged watertube, 51, 75, and 265 MMBtu/hr, with LNB	D-18
Packaged watertube, 265 MMBtu/hr, with LNB and CEM	D-19
Packaged watertube, 17.7 and 41.3 MMBtu/hr, with LNB and FGR	D-19
Packaged watertube, 45, 55, and 265 MMBtu/hr, with LNB and FGR	D-20
Packaged watertube, 81.3, 91, and 265 MMBtu/hr, with LNB, FGR, and CEM	D-21
Packaged watertube, 50-250 and 100 MMBtu/hr, with SCR	D-22
Packaged firetube, 2.9-33.5 MMBtu/hr, with FGR and O <sub>2</sub> trim	D-23
Field-erected wall-fired, 590 and 1,300 MMBtu/hr, with LNB	D-23
<b>Coal-fired:</b>	
Field-erected wall-fired, 766 MMBtu/hr, with LNB	D-24
Circulating FBC, 460 MMBtu/hr, with urea-based SNCR	D-24
Tangentially-fired, with SCR	D-25
Field-erected wall-fired, 800 MMBtu/hr, with ammonia-based SNCR	D-25
Wall-fired, 400 MMBtu/hr, with SNCR	D-26
Spreader stoker, 303 MMBtu/hr, with urea-based SNCR	D-26
<b>Wood-fired:</b>	
Stoker, 190, 225, and 300 MMBtu/hr, with urea-based SNCR	D-27
Stoker, 395 and 500 MMBtu/hr, with urea-based SNCR	D-28
Bubbling FBC, 250 MMBtu/hr, with ammonia-based SNCR	D-28
<b>Paper-fired:</b>	
Packaged watertube, 72 and 172 MMBtu/hr, with urea-based SNCR	D-29
<b>MSW-fired:</b>	
Stoker, 108, 121, and 325 MMBtu/hr, with urea-based SNCR	D-30

SCALED COST EFFECTIVENESS, \$/TON NO <sub>x</sub> REMOVED				
FUEL: natural gas		BOILER: packaged watertube(single burner)		
NO <sub>x</sub> CONTROL: WATER INJECTION WITH OXYGEN TRIM				
REFERENCE COST BASE:		COLANNINO, 1993; 45 MMBtu/hr		
BOILER CAPACITY MMBtu/hr	CAPACITY FACTOR			
	0.8	0.66	0.5	0.33
10	\$855	\$963	\$1,161	\$1,581
25	\$718	\$797	\$941	\$1,247
50	\$642	\$705	\$820	\$1,064
100	\$520	\$565	\$648	\$823
150	\$496	\$536	\$610	\$765
250	\$354	\$380	\$427	\$529

SCALED COST EFFECTIVENESS, \$/TON NO <sub>x</sub> REMOVED				
FUEL: natural gas		BOILER: packaged firetube		
NO <sub>x</sub> CONTROL: WATER INJECTION WITH OXYGEN TRIM				
REFERENCE COST BASE:		COLANNINO, 1993; 10.5MMBtu/hr		
BOILER CAPACITY MMBtu/hr	CAPACITY FACTOR			
	0.8	0.66	0.5	0.33
2.9	\$3,620	\$4,192	\$5,238	\$7,461
5.2	\$3,130	\$3,598	\$4,454	\$6,274
10.5	\$2,674	\$3,045	\$3,724	\$5,168
20.9	\$2,335	\$2,635	\$3,183	\$4,348
33.5	\$2,152	\$2,413	\$2,889	\$3,903

SCALED COST EFFECTIVENESS, \$/TON NOx REMOVED				
FUEL: natural gas		BOILER: packaged watertube		
NOx CONTROL: LNB				
REFERENCE COST BASE:		California ARB, 1987; 51 MMBtu/hr		
BOILER CAPACITY MMBtu/hr	CAPACITY FACTOR			
	0.8	0.66	0.5	0.33
10	\$816	\$989	\$1,306	\$1,978
25	\$594	\$720	\$950	\$1,440
50	\$473	\$573	\$756	\$1,146
100	\$338	\$410	\$541	\$820
150	\$300	\$364	\$480	\$727
250	\$195	\$236	\$312	\$472

SCALED COST EFFECTIVENESS, \$/TON NOx REMOVED				
FUEL: natural gas		BOILER: packaged watertube		
NOx CONTROL: LNB				
REFERENCE COST BASE:		California ARB, 1987; 75 MMBtu/hr		
BOILER CAPACITY MMBtu/hr	CAPACITY FACTOR			
	0.8	0.66	0.5	0.33
10	\$2,126	\$2,577	\$3,402	\$5,154
25	\$1,538	\$1,865	\$2,461	\$3,729
50	\$1,217	\$1,475	\$1,947	\$2,950
100	\$865	\$1,048	\$1,384	\$2,097
150	\$763	\$925	\$1,221	\$1,851
250	\$493	\$597	\$788	\$1,194

SCALED COST EFFECTIVENESS, \$/TON NOx REMOVED				
FUEL: natural gas		BOILER: packaged watertube		
NOx CONTROL: LNB				
REFERENCE COST BASE:		CIBO, 1992; 265 MMBtu/hr		
BOILER CAPACITY MMBtu/hr	CAPACITY FACTOR			
	0.8	0.66	0.5	0.33
10	\$2,690	\$3,261	\$4,304	\$6,522
25	\$1,916	\$2,322	\$3,066	\$4,645
50	\$1,493	\$1,809	\$2,388	\$3,618
100	\$1,041	\$1,262	\$1,666	\$2,525
150	\$908	\$1,100	\$1,452	\$2,201
250	\$576	\$698	\$921	\$1,395

SCALED COST EFFECTIVENESS, \$/TON NOx REMOVED				
FUEL: natural gas		BOILER: packaged watertube		
NOx CONTROL: LNB with CEM system				
REFERENCE COST BASE: CIBO, 1992; 265 MMBtu/hr				
BOILER CAPACITY MMBtu/hr	CAPACITY FACTOR			
	0.8	0.66	0.5	0.33
10	\$4,462	\$5,408	\$7,139	\$10,816
25	\$3,178	\$3,852	\$5,084	\$7,703
50	\$2,475	\$3,000	\$3,961	\$6,001
100	\$1,727	\$2,094	\$2,764	\$4,187
150	\$1,506	\$1,825	\$2,409	\$3,650
250	\$955	\$1,157	\$1,527	\$2,314

SCALED COST EFFECTIVENESS, \$/TON NOx REMOVED				
FUEL: natural gas		BOILER: packaged watertube		
NOx CONTROL: LNB and FGR				
REFERENCE COST BASE: CIBO, 1992; 17.7 MMBtu/hr				
BOILER CAPACITY MMBtu/hr	CAPACITY FACTOR			
	0.8	0.66	0.5	0.33
10	\$2,101	\$2,625	\$3,582	\$5,617
25	\$1,523	\$1,925	\$2,658	\$4,217
50	\$1,208	\$1,542	\$2,153	\$3,451
100	\$861	\$1,112	\$1,573	\$2,552
150	\$761	\$992	\$1,413	\$2,310
250	\$492	\$649	\$934	\$1,542

SCALED COST EFFECTIVENESS, \$/TON NOx REMOVED				
FUEL: natural gas		BOILER: packaged watertube		
NOx CONTROL: LNB and FGR				
REFERENCE COST BASE: Impell Corp., 1989; 41.3 MMBtu/hr				
BOILER CAPACITY MMBtu/hr	CAPACITY FACTOR			
	0.8	0.66	0.5	0.33
10	\$4,624	\$5,686	\$7,627	\$11,752
25	\$3,302	\$4,083	\$5,511	\$8,546
50	\$2,575	\$3,206	\$4,354	\$6,792
100	\$1,805	\$2,259	\$3,090	\$4,856
150	\$1,576	\$1,982	\$2,725	\$4,302
250	\$1,002	\$1,269	\$1,756	\$2,791



SCALED COST EFFECTIVENESS, \$/TON NOx REMOVED				
FUEL: natural gas		BOILER: packaged watertube		
NOx CONTROL: LNB and FGR				
REFERENCE COST BASE:		California ARB, 1987; 45 MMBtu/hr		
BOILER CAPACITY MMBtu/hr	CAPACITY FACTOR			
	0.8	0.66	0.5	0.33
10	\$2,895	\$3,586	\$4,852	\$7,541
25	\$2,041	\$2,552	\$3,486	\$5,471
50	\$1,574	\$1,986	\$2,739	\$4,339
100	\$1,085	\$1,384	\$1,931	\$3,095
150	\$937	\$1,205	\$1,696	\$2,737
250	\$587	\$763	\$1,086	\$1,772

SCALED COST EFFECTIVENESS, \$/TON NOx REMOVED				
FUEL: natural gas		BOILER: packaged watertube		
NOx CONTROL: LNB and FGR				
REFERENCE COST BASE:		California ARB, 1987; 55 MMBtu/hr		
BOILER CAPACITY MMBtu/hr	CAPACITY FACTOR			
	0.8	0.66	0.5	0.33
10	\$4,560	\$5,605	\$7,516	\$11,577
25	\$3,238	\$4,003	\$5,402	\$8,374
50	\$2,516	\$3,127	\$4,246	\$6,622
100	\$1,749	\$2,190	\$2,995	\$4,706
150	\$1,521	\$1,913	\$2,630	\$4,153
250	\$961	\$1,217	\$1,685	\$2,680

SCALED COST EFFECTIVENESS, \$/TON NOx REMOVED				
FUEL: natural gas		BOILER: packaged watertube		
NOx CONTROL: LNB and FGR				
REFERENCE COST BASE:		CIBO, 1992; 265 MMBtu/hr		
BOILER CAPACITY MMBtu/hr	CAPACITY FACTOR			
	0.8	0.66	0.5	0.33
10	\$2,985	\$3,696	\$4,996	\$7,759
25	\$2,024	\$2,531	\$3,459	\$5,431
50	\$1,499	\$1,895	\$2,619	\$4,157
100	\$978	\$1,255	\$1,761	\$2,837
150	\$812	\$1,054	\$1,496	\$2,435
250	\$479	\$632	\$913	\$1,510

SCALED COST EFFECTIVENESS, \$/TON NOx REMOVED				
FUEL: natural gas		BOILER: packaged watertube		
NOx CONTROL: LNB and FGR with CEM system				
REFERENCE COST BASE: Impell Corp., 1989; 81.3 MMBtu/hr				
BOILER CAPACITY MMBtu/hr	CAPACITY FACTOR			
	0.8	0.66	0.5	0.33
10	\$5,455	\$6,692	\$8,953	\$13,758
25	\$3,852	\$4,748	\$6,387	\$9,870
50	\$2,975	\$3,685	\$4,984	\$7,743
100	\$2,053	\$2,559	\$3,484	\$5,451
150	\$1,776	\$2,223	\$3,041	\$4,779
250	\$1,114	\$1,403	\$1,932	\$3,056

SCALED COST EFFECTIVENESS, \$/TON NOx REMOVED				
FUEL: natural gas		BOILER: packaged watertube		
NOx CONTROL: LNB and FGR with CEM system				
REFERENCE COST BASE: CIBO, 1992; 91 MMBtu/hr				
BOILER CAPACITY MMBtu/hr	CAPACITY FACTOR			
	0.8	0.66	0.5	0.33
10	\$11,804	\$14,386	\$19,107	\$29,139
25	\$8,515	\$10,400	\$13,845	\$21,167
50	\$6,717	\$8,219	\$10,967	\$16,807
100	\$4,759	\$5,837	\$7,810	\$12,002
150	\$4,191	\$5,140	\$6,902	\$10,625
250	\$2,696	\$3,320	\$4,461	\$6,886

SCALED COST EFFECTIVENESS, \$/TON NOx REMOVED				
FUEL: natural gas		BOILER: packaged watertube		
NOx CONTROL: LNB and FGR with CEM system				
REFERENCE COST BASE: CIBO, 1992; 265 MMBtu/hr				
BOILER CAPACITY MMBtu/hr	CAPACITY FACTOR			
	0.8	0.66	0.5	0.33
10	\$4,459	\$5,483	\$7,355	\$11,334
25	\$3,074	\$3,804	\$5,140	\$7,977
50	\$2,317	\$2,886	\$3,928	\$6,140
100	\$1,549	\$1,947	\$2,675	\$4,221
150	\$1,310	\$1,657	\$2,292	\$3,641
250	\$794	\$1,015	\$1,418	\$2,275

SCALED COST EFFECTIVENESS, \$/TON NOx REMOVED				
FUEL: natural gas		BOILER: packaged firetube		
NOx CONTROL: FGR with oxygen trim		REFERENCE COST BASE: Hugh Dean, 1988; 2.9-33.5 MMBtu/hr		
BOILER CAPACITY MMBtu/hr	CAPACITY FACTOR			
	0.8	0.66	0.5	0.33
2.9	\$21,741	\$26,572	\$35,406	\$54,179
5.2	\$12,304	\$15,159	\$20,380	\$31,475
10.5	\$6,410	\$7,974	\$10,834	\$16,912
20.9	\$3,651	\$4,518	\$6,103	\$9,471
33.5	\$2,404	\$2,998	\$4,083	\$6,390

SCALED COST EFFECTIVENESS, \$/TON NOx REMOVED				
FUEL: natural gas		BOILER: packaged watertube		
NOx CONTROL: SCR				
REFERENCE COST BASE:		Peerless, 1992; 50-250 MMBtu/hr		
BOILER CAPACITY MMBtu/hr	CAPACITY FACTOR			
	0.8	0.66	0.5	0.33
10	\$6,112	\$7,396	\$9,744	\$14,734
25	\$4,741	\$5,734	\$7,551	\$11,410
50	\$3,991	\$4,825	\$6,351	\$9,592
100	\$2,516	\$3,040	\$3,999	\$6,037
150	\$2,223	\$2,686	\$3,531	\$5,329
200	\$1,563	\$1,888	\$2,483	\$3,746
250	\$1,498	\$1,810	\$2,380	\$3,590

SCALED COST EFFECTIVENESS, \$/TON NOx REMOVED				
FUEL: natural gas		BOILER: packaged watertube		
NOx CONTROL: SCR				
REFERENCE COST BASE:		Damon, 1987; 100 MMBtu/hr		
BOILER CAPACITY MMBtu/hr	CAPACITY FACTOR			
	0.8	0.66	0.5	0.33
10	\$6,303	\$7,640	\$10,085	\$15,280
25	\$5,007	\$6,070	\$8,012	\$12,139
50	\$4,299	\$5,210	\$6,878	\$10,421
100	\$3,344	\$4,053	\$5,350	\$8,105
150	\$3,120	\$3,782	\$4,992	\$7,563
250	\$2,164	\$2,623	\$3,462	\$5,245

SCALED COST EFFECTIVENESS, \$/TON NOx REMOVED				
FUEL: natural gas		BOILER: field erected wall fired		
NOx CONTROL: BOOS WITH OXYGEN TRIM				
REFERENCE COST BASE:		COLANNINO, 1993; 75 MMBtu/hr		
BOILER CAPACITY MMBtu/hr	CAPACITY FACTOR			
	0.8	0.66	0.5	0.33
100	\$394	\$435	\$510	\$670
250	\$260	\$284	\$327	\$418
400	\$197	\$214	\$244	\$308
500	\$193	\$209	\$237	\$297
750	\$139	\$150	\$169	\$210

SCALED COST EFFECTIVENESS, \$/TON NOx REMOVED				
FUEL: natural gas		BOILER: field erected wall fired		
NOx CONTROL: BOOS AND WATER INJECTION WITH OXYGEN TRIM				
REFERENCE COST BASE:		COLANNINO, 1993; 75 MMBtu/hr		
BOILER CAPACITY MMBtu/hr	CAPACITY FACTOR			
	0.8	0.66	0.5	0.33
100	\$714	\$753	\$823	\$972
250	\$503	\$525	\$565	\$650
400	\$392	\$408	\$436	\$495
500	\$388	\$403	\$429	\$485
750	\$286	\$296	\$314	\$352

SCALED COST EFFECTIVENESS, \$/TON NO <sub>x</sub> REMOVED				
FUEL: natural gas		BOILER: field erected wall fired		
NO <sub>x</sub> CONTROL: LNB				
REFERENCE COST BASE:		CIBO, 1992; 590 MMBtu/hr		
BOILER CAPACITY MMBtu/hr	CAPACITY FACTOR			
	0.8	0.66	0.5	0.33
250	\$2,498	\$3,028	\$3,996	\$6,055
400	\$1,707	\$2,069	\$2,730	\$4,137
500	\$1,586	\$1,923	\$2,538	\$3,845
750	\$1,393	\$1,689	\$2,229	\$3,377

SCALED COST EFFECTIVENESS, \$/TON NO <sub>x</sub> REMOVED				
FUEL: natural gas		BOILER: field erected wall fired		
NO <sub>x</sub> CONTROL: LNB				
REFERENCE COST BASE:		CIBO, 1992; 1300 MMBtu/hr		
BOILER CAPACITY MMBtu/hr	CAPACITY FACTOR			
	0.8	0.66	0.5	0.33
250	\$3,880	\$4,703	\$6,208	\$9,406
400	\$2,632	\$3,190	\$4,211	\$6,381
500	\$2,437	\$2,954	\$3,899	\$5,908
750	\$2,125	\$2,575	\$3,399	\$5,151

SCALED COST EFFECTIVENESS, \$/TON NOx REMOVED				
FUEL: distillate oil		BOILER: packaged watertube		
NOx CONTROL: LNB				
REFERENCE COST BASE:		California ARB, 1987; 51 MMBtu/hr		
BOILER CAPACITY MMBtu/hr	CAPACITY FACTOR			
	0.8	0.66	0.5	0.33
10	\$653	\$791	\$1,044	\$1,582
25	\$475	\$576	\$760	\$1,152
50	\$378	\$458	\$605	\$917
100	\$304	\$369	\$457	\$738
150	\$270	\$327	\$432	\$655
250	\$234	\$283	\$374	\$567

SCALED COST EFFECTIVENESS, \$/TON NOx REMOVED				
FUEL: distillate oil		BOILER: packaged watertube		
NOx CONTROL: LNB				
REFERENCE COST BASE:		California ARB, 1987; 75 MMBtu/hr		
BOILER CAPACITY MMBtu/hr	CAPACITY FACTOR			
	0.8	0.66	0.5	0.33
10	\$1,701	\$2,062	\$2,721	\$4,123
25	\$1,231	\$1,492	\$1,969	\$2,983
50	\$973	\$1,180	\$1,557	\$2,360
100	\$778	\$944	\$1,245	\$1,887
150	\$687	\$833	\$1,099	\$1,666
250	\$591	\$717	\$946	\$1,433

SCALED COST EFFECTIVENESS, \$/TON NOx REMOVED				
FUEL: distillate oil		BOILER: packaged watertube		
NOx CONTROL: LNB				
REFERENCE COST BASE:		CIBO, 1992; 265 MMBtu/hr		
BOILER CAPACITY MMBtu/hr	CAPACITY FACTOR			
	0.8	0.66	0.5	0.33
10	\$2,152	\$2,609	\$3,443	\$5,217
25	\$1,533	\$1,858	\$2,452	\$3,716
50	\$1,194	\$1,447	\$1,910	\$2,895
100	\$937	\$1,136	\$1,500	\$2,272
150	\$817	\$990	\$1,307	\$1,981
250	\$691	\$837	\$1,105	\$1,674

SCALED COST EFFECTIVENESS, \$/TON NO <sub>x</sub> REMOVED				
FUEL: distillate oil		BOILER: packaged watertube		
NO <sub>x</sub> CONTROL: LNB with CEM system				
REFERENCE COST BASE: CIBO, 1992; 265 MMBtu/hr				
BOILER CAPACITY MMBtu/hr	CAPACITY FACTOR			
	0.8	0.66	0.5	0.33
10	\$3,569	\$4,326	\$5,711	\$8,653
25	\$2,542	\$3,081	\$4,067	\$6,163
50	\$1,980	\$2,400	\$3,168	\$4,801
100	\$1,554	\$1,884	\$2,487	\$3,768
150	\$1,355	\$1,642	\$2,168	\$3,285
250	\$1,146	\$1,389	\$1,833	\$2,777

SCALED COST EFFECTIVENESS, \$/TON NO <sub>x</sub> REMOVED				
FUEL: distillate oil		BOILER: packaged watertube		
NO <sub>x</sub> CONTROL: LNB and FGR				
REFERENCE COST BASE: CIBO, 1992; 17.7 MMBtu/hr				
BOILER CAPACITY MMBtu/hr	CAPACITY FACTOR			
	0.8	0.66	0.5	0.33
10	\$1,481	\$1,900	\$2,666	\$4,294
25	\$1,019	\$1,340	\$1,927	\$3,174
50	\$766	\$1,033	\$1,522	\$2,561
100	\$574	\$801	\$1,216	\$2,097
150	\$485	\$692	\$1,072	\$1,879
250	\$391	\$578	\$921	\$1,651

SCALED COST EFFECTIVENESS, \$/TON NO <sub>x</sub> REMOVED				
FUEL: distillate oil				
NO <sub>x</sub> CONTROL: LNB and FGR				
REFERENCE COST BASE: Impell Corp, 1989; 41.3 MMBtu/hr				
BOILER CAPACITY MMBtu/hr	CAPACITY FACTOR			
	0.8	0.66	0.5	0.33
10	\$3,500	\$4,349	\$5,902	\$9,202
25	\$2,442	\$3,066	\$4,209	\$6,637
50	\$1,863	\$2,365	\$3,283	\$5,234
100	\$1,424	\$1,833	\$2,581	\$4,170
150	\$1,219	\$1,584	\$2,252	\$3,672
250	\$1,003	\$1,323	\$1,907	\$3,149



SCALED COST EFFECTIVENESS, \$/TON NOx REMOVED				
FUEL: distillate oil		BOILER: packaged watertube		
NOx CONTROL: LNB and FGR				
REFERENCE COST BASE:		California ARB, 1987; 45 MMBtu/hr		
BOILER CAPACITY MMBtu/hr	CAPACITY FACTOR			
	0.8	0.66	0.5	0.33
10	\$2,116	\$2,669	\$3,681	\$5,833
25	\$1,433	\$1,841	\$2,589	\$4,177
50	\$1,059	\$1,389	\$1,991	\$3,272
100	\$776	\$1,046	\$1,538	\$2,585
150	\$643	\$885	\$1,326	\$2,264
250	\$504	\$716	\$1,103	\$1,926

SCALED COST EFFECTIVENESS, \$/TON NOx REMOVED				
FUEL: distillate oil		BOILER: packaged watertube		
NOx CONTROL: LNB and FGR				
REFERENCE COST BASE:		California ARB, 1987; 55 MMBtu/hr		
BOILER CAPACITY MMBtu/hr	CAPACITY FACTOR			
	0.8	0.66	0.5	0.33
10	\$3,448	\$4,284	\$5,813	\$9,062
25	\$2,391	\$3,003	\$4,122	\$6,499
50	\$1,813	\$2,302	\$3,197	\$5,098
100	\$1,374	\$1,771	\$2,496	\$4,036
150	\$1,169	\$1,522	\$2,157	\$3,538
250	\$954	\$1,261	\$1,822	\$3,016

SCALED COST EFFECTIVENESS, \$/TON NOx REMOVED				
FUEL: distillate oil		BOILER: packaged watertube		
NOx CONTROL: LNB and FGR				
REFERENCE COST BASE:		CIBO, 1992; 265 MMBtu/hr		
BOILER CAPACITY MMBtu/hr	CAPACITY FACTOR			
	0.8	0.66	0.5	0.33
10	\$2,188	\$2,757	\$3,797	\$6,007
25	\$1,419	\$1,825	\$2,567	\$4,144
50	\$999	\$1,316	\$1,895	\$3,126
100	\$680	\$930	\$1,385	\$2,353
150	\$531	\$749	\$1,146	\$1,991
250	\$374	\$559	\$896	\$1,612

SCALED COST EFFECTIVENESS, \$/TON NOx REMOVED				
FUEL: distillate oil		BOILER: packaged watertube		
NOx CONTROL: LNB and FGR with CEM system				
REFERENCE COST BASE: Impell Corp., 1989; 81.3 MMBtu/hr				
BOILER CAPACITY MMBtu/hr	CAPACITY FACTOR			
	0.8	0.66	0.5	0.33
10	\$4,164	\$5,154	\$6,962	\$10,806
25	\$2,881	\$3,598	\$4,910	\$7,696
50	\$2,180	\$2,748	\$3,787	\$5,995
100	\$1,648	\$2,103	\$2,936	\$4,706
150	\$1,399	\$1,801	\$2,537	\$4,101
250	\$1,137	\$1,484	\$2,119	\$3,467

SCALED COST EFFECTIVENESS, \$/TON NOx REMOVED				
FUEL: distillate oil		BOILER: packaged watertube		
NOx CONTROL: LNB and FGR with CEM system				
REFERENCE COST BASE: CIBO, 1992; 91 MMBtu/hr				
BOILER CAPACITY MMBtu/hr	CAPACITY FACTOR			
	0.8	0.66	0.5	0.33
10	\$9,243	\$11,309	\$15,086	\$23,111
25	\$6,612	\$8,120	\$10,876	\$16,734
50	\$5,173	\$6,376	\$8,574	\$13,245
100	\$4,083	\$5,054	\$6,829	\$10,602
150	\$3,572	\$4,434	\$6,011	\$9,363
250	\$3,036	\$3,784	\$5,153	\$8,063

SCALED COST EFFECTIVENESS, \$/TON NOx REMOVED				
FUEL: distillate oil		BOILER: packaged watertube		
NOx CONTROL: LNB and FGR with CEM system				
REFERENCE COST BASE: CIBO, 1992; 265 MMBtu/hr				
BOILER CAPACITY MMBtu/hr	CAPACITY FACTOR			
	0.8	0.66	0.5	0.33
10	\$3,367	\$4,187	\$5,684	\$8,867
25	\$2,259	\$2,844	\$3,912	\$6,181
50	\$1,653	\$2,109	\$2,942	\$4,712
100	\$1,194	\$1,552	\$2,207	\$3,599
150	\$979	\$1,291	\$1,863	\$3,077
250	\$753	\$1,018	\$1,501	\$2,530

SCALED COST EFFECTIVENESS, \$/TON NOx REMOVED				
FUEL: distillate oil		BOILER: packaged watertube		
NOx CONTROL: SCR				
REFERENCE COST BASE:		Peerless, 1992; 50-250 MMBtu/hr		
BOILER CAPACITY MMBtu/hr	CAPACITY FACTOR			
	0.8	0.66	0.5	0.33
10	\$4,890	\$5,917	\$7,795	\$11,787
25	\$3,793	\$4,588	\$6,041	\$9,128
50	\$3,193	\$3,860	\$5,081	\$7,674
100	\$2,265	\$2,736	\$3,599	\$5,433
150	\$2,001	\$2,417	\$3,178	\$4,796
200	\$1,876	\$2,266	\$2,979	\$4,495
250	\$1,798	\$2,172	\$2,855	\$4,308

SCALED COST EFFECTIVENESS, \$/TON NOx REMOVED				
FUEL: distillate oil		BOILER: packaged watertube		
NOx CONTROL: SCR				
REFERENCE COST BASE:		Damon, 1987; 100 MMBtu/hr		
BOILER CAPACITY MMBtu/hr	CAPACITY FACTOR			
	0.8	0.66	0.5	0.33
10	\$5,043	\$6,112	\$8,068	\$12,224
25	\$4,006	\$4,856	\$6,409	\$9,711
50	\$3,439	\$4,168	\$5,502	\$8,337
100	\$3,009	\$3,647	\$4,815	\$7,295
150	\$2,808	\$3,403	\$4,492	\$6,807
250	\$2,596	\$3,147	\$4,154	\$6,294

SCALED COST EFFECTIVENESS, \$/TON NOx REMOVED				
FUEL: distillate oil		BOILER: packaged firetube		
NOx CONTROL: FGR with oxygen trim				
REFERENCE COST BASE:		Hugh Dean, 1988; 2.9-33.5 MMBtu/hr		
BOILER CAPACITY MMBtu/hr	CAPACITY FACTOR			
	0.8	0.66	0.5	0.33
2.9	\$12,744	\$15,643	\$20,944	\$32,207
5.2	\$7,083	\$8,796	\$11,928	\$18,585
10.5	\$3,546	\$4,485	\$6,201	\$9,847
20.9	\$1,891	\$2,411	\$3,362	\$5,383
33.5	\$1,143	\$1,499	\$2,150	\$3,534

SCALED COST EFFECTIVENESS, \$/TON NOx REMOVED				
FUEL: distillate oil		BOILER: field erected wall fired		
NOx CONTROL: LNB				
REFERENCE COST BASE:		CIBO, 1992; 590 MMBtu/hr		
BOILER CAPACITY MMBtu/hr	CAPACITY FACTOR			
	0.8	0.66	0.5	0.33
250	\$2,997	\$3,633	\$4,796	\$7,266
400	\$2,560	\$3,103	\$4,096	\$6,206
500	\$2,379	\$2,884	\$3,807	\$5,768
750	\$2,090	\$2,533	\$3,343	\$5,066

SCALED COST EFFECTIVENESS, \$/TON NOx REMOVED				
FUEL: distillate oil		BOILER: field erected wall fired		
NOx CONTROL: LNB				
REFERENCE COST BASE:		CIBO, 1992; 1300 MMBtu/hr		
BOILER CAPACITY MMBtu/hr	CAPACITY FACTOR			
	0.8	0.66	0.5	0.33
250	\$4,656	\$5,644	\$7,450	\$11,287
400	\$3,948	\$4,785	\$6,317	\$9,571
500	\$3,656	\$4,431	\$5,849	\$8,862
750	\$3,187	\$3,863	\$5,099	\$7,726

SCALED COST EFFECTIVENESS, \$/TON NOx REMOVED				
FUEL: residual oil		BOILER: packaged watertube		
NOx CONTROL: LNB				
REFERENCE COST BASE:		California ARB, 1987; 51 MMBtu/hr		
BOILER CAPACITY MMBtu/hr	CAPACITY FACTOR			
	0.8	0.66	0.5	0.33
10	\$344	\$416	\$550	\$833
25	\$250	\$303	\$400	\$606
50	\$199	\$241	\$318	\$482
100	\$160	\$194	\$256	\$388
150	\$142	\$172	\$227	\$344
250	\$123	\$149	\$197	\$298

SCALED COST EFFECTIVENESS, \$/TON NOx REMOVED				
FUEL: residual oil		BOILER: packaged watertube		
NOx CONTROL: LNB				
REFERENCE COST BASE:		California ARB, 1987; 75 MMBtu/hr		
BOILER CAPACITY MMBtu/hr	CAPACITY FACTOR			
	0.8	0.66	0.5	0.33
10	\$895	\$1,085	\$1,432	\$2,170
25	\$648	\$785	\$1,036	\$1,570
50	\$512	\$621	\$820	\$1,242
100	\$410	\$497	\$656	\$993
150	\$362	\$438	\$579	\$877
250	\$311	\$377	\$498	\$754

SCALED COST EFFECTIVENESS, \$/TON NOx REMOVED				
FUEL: residual oil		BOILER: packaged watertube		
NOx CONTROL: LNB				
REFERENCE COST BASE:		CIBO, 1992; 265 MMBtu/hr		
BOILER CAPACITY MMBtu/hr	CAPACITY FACTOR			
	0.8	0.66	0.5	0.33
10	\$1,133	\$1,373	\$1,812	\$2,746
25	\$807	\$978	\$1,291	\$1,956
50	\$628	\$762	\$1,005	\$1,523
100	\$493	\$598	\$789	\$1,196
150	\$430	\$521	\$688	\$1,042
250	\$364	\$441	\$582	\$881

SCALED COST EFFECTIVENESS, \$/TON NOx REMOVED				
FUEL: residual oil		BOILER: packaged watertube		
NOx CONTROL: LNB with CEM system				
REFERENCE COST BASE: CIBO, 1992; 265 MMBtu/hr				
BOILER CAPACITY MMBtu/hr	CAPACITY FACTOR			
	0.8	0.66	0.5	0.33
10	\$1,879	\$2,277	\$3,006	\$4,554
25	\$1,338	\$1,622	\$2,141	\$3,244
50	\$1,042	\$1,263	\$1,668	\$2,527
100	\$818	\$992	\$1,309	\$1,983
150	\$713	\$864	\$1,141	\$1,729
250	\$603	\$731	\$965	\$1,462

SCALED COST EFFECTIVENESS, \$/TON NOx REMOVED				
FUEL: residual oil		BOILER: packaged watertube		
NOx CONTROL: LNB and FGR				
REFERENCE COST BASE: CIBO, 1992; 17.7 MMBtu/hr				
BOILER CAPACITY MMBtu/hr	CAPACITY FACTOR			
	0.8	0.66	0.5	0.33
10	\$997	\$1,217	\$1,621	\$2,477
25	\$754	\$923	\$1,231	\$1,888
50	\$621	\$761	\$1,019	\$1,565
100	\$520	\$639	\$857	\$1,321
150	\$473	\$582	\$782	\$1,206
250	\$423	\$522	\$702	\$1,086

SCALED COST EFFECTIVENESS, \$/TON NOx REMOVED				
FUEL: residual oil		BOILER: packaged watertube		
NOx CONTROL: LNB and FGR				
REFERENCE COST BASE: Impell Corp., 1989; 41.3 MMBtu/hr				
BOILER CAPACITY MMBtu/hr	CAPACITY FACTOR			
	0.8	0.66	0.5	0.33
10	\$2,059	\$2,506	\$3,324	\$5,060
25	\$1,503	\$1,831	\$2,433	\$3,710
50	\$1,198	\$1,462	\$1,945	\$2,972
100	\$967	\$1,182	\$1,576	\$2,412
150	\$859	\$1,051	\$1,403	\$2,150
250	\$745	\$914	\$1,221	\$1,875

SCALED COST EFFECTIVENESS, \$/TON NO <sub>x</sub> REMOVED				
FUEL: residual oil		BOILER: packaged watertube		
NO <sub>x</sub> CONTROL: LNB and FGR				
REFERENCE COST BASE:		California ARB, 1987; 45 MMBtu/hr		
BOILER CAPACITY MMBtu/hr	CAPACITY FACTOR			
	0.8	0.66	0.5	0.33
10	\$1,331	\$1,622	\$2,155	\$3,287
25	\$972	\$1,187	\$1,580	\$2,416
50	\$775	\$948	\$1,266	\$1,939
100	\$626	\$768	\$1,027	\$1,578
150	\$556	\$683	\$915	\$1,409
250	\$483	\$594	\$798	\$1,231

SCALED COST EFFECTIVENESS, \$/TON NO <sub>x</sub> REMOVED				
FUEL: residual oil		BOILER: packaged watertube		
NO <sub>x</sub> CONTROL: LNB and FGR				
REFERENCE COST BASE:		California ARB, 1987; 55 MMBtu/hr		
BOILER CAPACITY MMBtu/hr	CAPACITY FACTOR			
	0.8	0.66	0.5	0.33
10	\$2,032	\$2,472	\$3,277	\$4,987
25	\$1,476	\$1,798	\$2,387	\$3,638
50	\$1,172	\$1,429	\$1,900	\$2,901
100	\$941	\$1,150	\$1,531	\$2,342
150	\$833	\$1,019	\$1,358	\$2,080
250	\$719	\$881	\$1,177	\$1,805

SCALED COST EFFECTIVENESS, \$/TON NO <sub>x</sub> REMOVED				
FUEL: residual oil		BOILER: packaged watertube		
NO <sub>x</sub> CONTROL: LNB and FGR				
REFERENCE COST BASE:		CIBO, 1992; 265 MMBtu/hr		
BOILER CAPACITY MMBtu/hr	CAPACITY FACTOR			
	0.8	0.66	0.5	0.33
10	\$1,369	\$1,668	\$2,216	\$3,379
25	\$965	\$1,178	\$1,569	\$2,399
50	\$743	\$910	\$1,215	\$1,863
100	\$576	\$707	\$947	\$1,456
150	\$497	\$612	\$821	\$1,266
250	\$415	\$512	\$689	\$1,066

SCALED COST EFFECTIVENESS, \$/TON NOx REMOVED				
FUEL: residual oil		BOILER: packaged watertube		
NOx CONTROL: LNB and FGR with CEM system				
REFERENCE COST BASE: Impell Corp., 1989; 81.3 MMBtu/hr				
BOILER CAPACITY MMBtu/hr	CAPACITY FACTOR			
	0.8	0.66	0.5	0.33
10	\$2,409	\$2,930	\$3,882	\$5,905
25	\$1,734	\$2,111	\$2,802	\$4,268
50	\$1,365	\$1,664	\$2,211	\$3,373
100	\$1,085	\$1,324	\$1,763	\$2,694
150	\$954	\$1,166	\$1,553	\$2,376
250	\$816	\$999	\$1,333	\$2,042

SCALED COST EFFECTIVENESS, \$/TON NOx REMOVED				
FUEL: residual oil		BOILER: packaged watertube		
NOx CONTROL: LNB and FGR with CEM system				
REFERENCE COST BASE: CIBO, 1992; 91 MMBtu/hr				
BOILER CAPACITY MMBtu/hr	CAPACITY FACTOR			
	0.8	0.66	0.5	0.33
10	\$5,082	\$6,169	\$8,157	\$12,381
25	\$3,698	\$4,491	\$5,942	\$9,025
50	\$2,940	\$3,573	\$4,730	\$7,189
100	\$2,366	\$2,877	\$3,812	\$5,797
150	\$2,097	\$2,551	\$3,381	\$5,145
250	\$1,815	\$2,209	\$2,930	\$4,461

SCALED COST EFFECTIVENESS, \$/TON NOx REMOVED				
FUEL: residual oil		BOILER: packaged watertube		
NOx CONTROL: LNB and FGR with CEM system				
REFERENCE COST BASE: CIBO, 1992; 265 MMBtu/hr				
BOILER CAPACITY MMBtu/hr	CAPACITY FACTOR			
	0.8	0.66	0.5	0.33
10	\$1,990	\$2,421	\$3,209	\$4,885
25	\$1,407	\$1,714	\$2,276	\$3,471
50	\$1,088	\$1,328	\$1,766	\$2,698
100	\$846	\$1,035	\$1,379	\$2,112
150	\$733	\$897	\$1,198	\$1,837
250	\$614	\$753	\$1,008	\$1,549



SCALED COST EFFECTIVENESS, \$/TON NOx REMOVED				
FUEL: residual oil		BOILER: packaged watertube		
NOx CONTROL: SCR				
REFERENCE COST BASE:		Peerless, 1992; 50-250 MMBtu/hr		
BOILER CAPACITY MMBtu/hr	CAPACITY FACTOR			
	0.8	0.66	0.5	0.33
10	\$2,574	\$3,114	\$4,103	\$6,204
25	\$1,996	\$2,415	\$3,179	\$4,804
50	\$1,681	\$2,032	\$2,674	\$4,039
100	\$1,192	\$1,440	\$1,894	\$2,860
150	\$1,053	\$1,272	\$1,673	\$2,524
200	\$987	\$1,193	\$1,568	\$2,366
250	\$946	\$1,143	\$1,503	\$2,267

SCALED COST EFFECTIVENESS, \$/TON NOx REMOVED				
FUEL: residual oil		BOILER: packaged watertube		
NOx CONTROL: SCR				
REFERENCE COST BASE:		Damon, 1987; 100 MMBtu/hr		
BOILER CAPACITY MMBtu/hr	CAPACITY FACTOR			
	0.8	0.66	0.5	0.33
10	\$2,654	\$3,217	\$4,246	\$6,434
25	\$2,108	\$2,556	\$3,373	\$5,111
50	\$1,810	\$2,194	\$2,896	\$4,388
100	\$1,584	\$1,920	\$2,534	\$3,839
150	\$1,478	\$1,791	\$2,364	\$3,583
250	\$1,367	\$1,656	\$2,186	\$3,313

SCALED COST EFFECTIVENESS, \$/TON NO <sub>x</sub> REMOVED				
FUEL: residual oil		BOILER: packaged firetube		
NO <sub>x</sub> CONTROL: FGR with oxygen trim				
REFERENCE COST BASE:		Hugh Dean, 1988; 2.9-33.5 MMBtu/hr		
BOILER CAPACITY MMBtu/hr	CAPACITY FACTOR			
	0.8	0.66	0.5	0.33
2.9	\$7,034	\$8,560	\$11,349	\$17,277
5.2	\$4,054	\$4,956	\$6,604	\$10,108
10.5	\$2,193	\$2,687	\$3,590	\$5,509
20.9	\$1,321	\$1,595	\$2,096	\$3,159
33.5	\$928	\$1,115	\$1,458	\$2,186

SCALED COST EFFECTIVENESS, \$/TON NO <sub>x</sub> REMOVED				
FUEL: residual oil		BOILER: field erected wall fired		
NO <sub>x</sub> CONTROL: LNB				
REFERENCE COST BASE:		CIBO, 1992; 590 MMBtu/hr		
BOILER CAPACITY MMBtu/hr	CAPACITY FACTOR			
	0.8	0.66	0.5	0.33
250	\$1,578	\$1,912	\$2,524	\$3,824
400	\$1,347	\$1,633	\$2,156	\$3,266
500	\$1,252	\$1,518	\$2,004	\$3,036
750	\$1,100	\$1,333	\$1,760	\$2,666

SCALED COST EFFECTIVENESS, \$/TON NO <sub>x</sub> REMOVED				
FUEL: residual oil		BOILER: field erected wall fired		
NO <sub>x</sub> CONTROL: LNB				
REFERENCE COST BASE:		CIBO, 1992; 1300 MMBtu/hr		
BOILER CAPACITY MMBtu/hr	CAPACITY FACTOR			
	0.8	0.66	0.5	0.33
250	\$2,451	\$2,970	\$3,921	\$5,941
400	\$2,078	\$2,519	\$3,325	\$5,037
500	\$1,924	\$2,332	\$3,079	\$4,664
750	\$1,677	\$2,033	\$2,684	\$4,066

SCALED COST EFFECTIVENESS, \$/TON NOx REMOVED				
FUEL: coal		BOILER: field erected wall fired		
NOx CONTROL: LNB				
REFERENCE COST BASE:		CIBO, 1992; 766 MMBtu/hr		
BOILER CAPACITY MMBtu/hr	CAPACITY FACTOR			
	0.8	0.66	0.5	0.33
250	\$1,112	\$1,340	\$1,758	\$2,645
400	\$968	\$1,165	\$1,527	\$2,295
500	\$908	\$1,093	\$1,432	\$2,151
750	\$813	\$977	\$1,279	\$1,919

SCALED COST EFFECTIVENESS, \$/TON NOx REMOVED				
FUEL: coal		BOILER: circulating FBC		
NOx CONTROL: SNCR - urea based				
REFERENCE COST BASE:		Nalco Fuel Tech, 1992; 460 MMBtu/hr		
BOILER CAPACITY MMBtu/hr	CAPACITY FACTOR			
	0.8	0.66	0.5	0.33
250	\$875	\$964	\$1,125	\$1,468
400	\$813	\$888	\$1,025	\$1,316
500	\$787	\$856	\$984	\$1,254
750	\$745	\$806	\$917	\$1,153

SCALED COST EFFECTIVENESS, \$/TON NOx REMOVED				
FUEL: Pulverized coal		BOILER: Tangentially-fired		
NOx CONTROL: SCR				
REFERENCE COST BASE: Utility Boiler ACT (EPA-453/R-94-023)				
BOILER CAPACITY MMBtu/hr	CAPACITY FACTOR			
	0.8	0.66	0.50	0.33
250	\$3,304	\$3,923	\$4,772	\$6,789
400	\$2,968	\$3,415	\$4,233	\$5,972
500	\$2,828	\$3,246	\$4,011	\$5,635
750	\$2,605	\$2,976	\$3,654	\$5,094

SCALED COST EFFECTIVENESS, \$/TON NOx REMOVED				
FUEL: Coal		BOILER: Field Erected Wall Fired		
NOx CONTROL: SNCR - ammonia				
REFERENCE COST BASE: EXXON, 1990; 800 MMBtu/hr boiler				
BOILER CAPACITY MMBtu/hr	CAPACITY FACTOR			
	0.8	0.66	0.50	0.33
250	\$1,306	\$1,358	\$1,453	\$1,655
400	\$1,270	\$1,314	\$1,395	\$1,567
500	\$1,255	\$1,296	\$1,371	\$1,531
750	\$1,231	\$1,267	\$1,332	\$1,472

SCALED COST EFFECTIVENESS, \$/TON NOx REMOVED				
FUEL: Pulverized coal		BOILER: wall-fired		
NOx CONTROL: SNCR				
REFERENCE COST BASE: Nalco Fuel Tech, 1994; 400 MMBtu/hr				
BOILER CAPACITY MMBtu/hr	CAPACITY FACTOR			
	0.8	0.66	0.50	0.33
250	\$1,100	\$1,121	\$1,337	\$1,662
400	\$1,036	\$1,044	\$1,235	\$1,508
500	\$1,010	\$1,012	\$1,193	\$1,444
750	\$968	\$961	\$1,126	\$1,342

SCALED COST EFFECTIVENESS, \$/TON NOx REMOVED				
FUEL: Coal		BOILER: Spreader Stoker		
NOx CONTROL: SNCR - urea based				
REFERENCE COST BASE: Nalco Fuel Tech; 1992; 303 MMBtu/hr				
BOILER CAPACITY MMBtu/hr	CAPACITY FACTOR			
	0.8	0.66	0.50	0.33
250	\$1,318	\$1,359	\$1,435	\$1,595
400	\$1,285	\$1,319	\$1,382	\$1,514
500	\$1,271	\$1,302	\$1,360	\$1,481
750	\$1,249	\$1,276	\$1,324	\$1,427

SCALED COST EFFECTIVENESS, \$/TON NOx REMOVED				
FUEL: wood		BOILER: stoker		
NOx CONTROL: SNCR - urea based				
REFERENCE COST BASE: Nalco Fuel Tech, 1992; 190 MMBtu/hr				
BOILER CAPACITY MMBtu/hr	CAPACITY FACTOR			
	0.8	0.66	0.5	0.33
50	\$2,144	\$2,445	\$2,996	\$4,166
150	\$1,687	\$1,891	\$2,264	\$3,057
250	\$1,533	\$1,705	\$2,019	\$2,686
350	\$1,448	\$1,602	\$1,883	\$2,480
500	\$1,370	\$1,507	\$1,757	\$2,289

SCALED COST EFFECTIVENESS, \$/TON NOx REMOVED				
FUEL: wood		BOILER: stoker		
NOx CONTROL: SNCR - urea based				
REFERENCE COST BASE: Nalco Fuel Tech, 1992; 225 MMBtu/hr				
BOILER CAPACITY MMBtu/hr	CAPACITY FACTOR			
	0.8	0.66	0.5	0.33
50	\$2,266	\$2,571	\$3,128	\$4,312
150	\$1,800	\$2,006	\$2,383	\$3,183
250	\$1,644	\$1,817	\$2,133	\$2,805
350	\$1,558	\$1,712	\$1,995	\$2,595
500	\$1,478	\$1,615	\$1,867	\$2,401

SCALED COST EFFECTIVENESS, \$/TON NOx REMOVED				
FUEL: wood		BOILER: stoker		
NOx CONTROL: SNCR - urea based				
REFERENCE COST BASE: Nalco Fuel Tech, 1992; 300 MMBtu/hr				
BOILER CAPACITY MMBtu/hr	CAPACITY FACTOR			
	0.8	0.66	0.5	0.33
50	\$2,119	\$2,435	\$3,014	\$4,243
150	\$1,630	\$1,843	\$2,233	\$3,060
250	\$1,467	\$1,645	\$1,971	\$2,663
350	\$1,376	\$1,535	\$1,826	\$2,443
500	\$1,292	\$1,434	\$1,692	\$2,240

SCALED COST EFFECTIVENESS, \$/TON NOx REMOVED				
FUEL: wood		BOILER: stoker		
NOx CONTROL: SNCR - urea based				
REFERENCE COST BASE:		Nalco Fuel Tech, 1992; 395 MMBtu/hr		
BOILER CAPACITY MMBtu/hr	CAPACITY FACTOR			
	0.8	0.66	0.5	0.33
50	\$1,519	\$1,806	\$2,330	\$3,444
150	\$1,073	\$1,265	\$1,616	\$2,363
250	\$923	\$1,084	\$1,377	\$2,000
350	\$840	\$983	\$1,244	\$1,799
500	\$764	\$890	\$1,122	\$1,614

SCALED COST EFFECTIVENESS, \$/TON NOx REMOVED				
FUEL: wood		BOILER: stoker		
NOx CONTROL: SNCR - urea based				
REFERENCE COST BASE:		Nalco Fuel Tech, 1992; 500 MMBtu/hr		
BOILER CAPACITY MMBtu/hr	CAPACITY FACTOR			
	0.8	0.66	0.5	0.33
50	\$1,661	\$1,912	\$2,370	\$3,343
150	\$1,269	\$1,436	\$1,742	\$2,392
250	\$1,138	\$1,277	\$1,532	\$2,074
350	\$1,065	\$1,189	\$1,415	\$1,897
500	\$997	\$1,107	\$1,308	\$1,734

SCALED COST EFFECTIVENESS, \$/TON NOx REMOVED				
FUEL: wood		BOILER: bubbling FBC		
NOx CONTROL: SNCR - ammonia based				
REFERENCE COST BASE:		Hurst, 1988; 250 MMBtu/hr		
BOILER CAPACITY MMBtu/hr	CAPACITY FACTOR			
	0.8	0.66	0.5	0.33
50	\$1,459	\$1,563	\$1,754	\$2,158
150	\$1,392	\$1,481	\$1,646	\$1,994
250	\$1,364	\$1,448	\$1,601	\$1,927
350	\$1,319	\$1,394	\$1,530	\$1,818
500	\$997	\$1,107	\$1,308	\$1,734

SCALED COST EFFECTIVENESS, \$/TON NO <sub>x</sub> REMOVED				
FUEL: paper		BOILER: packaged watertube		
NO <sub>x</sub> CONTROL: SNCR - urea based				
REFERENCE COST BASE:		Nalco Fuel Tech, 1992; 72 MMBtu/hr		
BOILER CAPACITY MMBtu/hr	CAPACITY FACTOR			
	0.8	0.66	0.5	0.33
10	\$1,949	\$2,216	\$2,705	\$3,744
25	\$1,591	\$1,782	\$2,132	\$2,876
50	\$1,395	\$1,545	\$1,819	\$2,401
100	\$1,247	\$1,365	\$1,582	\$2,042
150	\$1,177	\$1,281	\$1,470	\$1,873
250	\$1,104	\$1,192	\$1,354	\$1,696

SCALED COST EFFECTIVENESS, \$/TON NO <sub>x</sub> REMOVED				
FUEL: paper		BOILER: packaged watertube		
NO <sub>x</sub> CONTROL: SNCR - urea based				
REFERENCE COST BASE:		Nalco Fuel Tech, 1992; 172 MMBtu/hr		
BOILER CAPACITY MMBtu/hr	CAPACITY FACTOR			
	0.8	0.66	0.5	0.33
10	\$2,474	\$2,844	\$3,520	\$4,958
25	\$1,967	\$2,230	\$2,710	\$3,730
50	\$1,690	\$1,894	\$2,266	\$3,059
100	\$1,480	\$1,639	\$1,930	\$2,549
150	\$1,382	\$1,520	\$1,773	\$2,311
250	\$1,278	\$1,395	\$1,608	\$2,061



SCALED COST EFFECTIVENESS, \$/TON NOx REMOVED				
FUEL: MSW		BOILER: stoker		
NOx CONTROL: SNCR - urea based				
REFERENCE COST BASE:		Nalco Fuel Tech, 1992; 108 MMBtu/hr		
BOILER CAPACITY MMBtu/hr	CAPACITY FACTOR			
	0.8	0.66	0.5	0.33
50	\$2,123	\$2,394	\$2,889	\$3,942
150	\$1,721	\$1,907	\$2,246	\$2,968
250	\$1,587	\$1,744	\$2,031	\$2,642
350	\$1,512	\$1,653	\$1,912	\$2,461
500	\$1,443	\$1,570	\$1,801	\$2,293

SCALED COST EFFECTIVENESS, \$/TON NOx REMOVED				
FUEL: MSW		BOILER: stoker		
NOx CONTROL: SNCR - urea based				
REFERENCE COST BASE:		Nalco Fuel Tech, 1992; 121 MMBtu/hr		
BOILER CAPACITY MMBtu/hr	CAPACITY FACTOR			
	0.8	0.66	0.5	0.33
50	\$2,603	\$3,025	\$3,796	\$5,434
150	\$1,975	\$2,263	\$2,790	\$3,910
250	\$1,764	\$2,008	\$2,453	\$3,400
350	\$1,647	\$1,866	\$2,266	\$3,117
500	\$1,539	\$1,735	\$2,093	\$2,855

SCALED COST EFFECTIVENESS, \$/TON NOx REMOVED				
FUEL: MSW		BOILER: stoker		
NOx CONTROL: SNCR - urea based				
REFERENCE COST BASE:		Nalco Fuel Tech, 1992; 325 MMBtu/hr		
BOILER CAPACITY MMBtu/hr	CAPACITY FACTOR			
	0.8	0.66	0.5	0.33
50	\$2,167	\$2,486	\$3,070	\$4,312
150	\$1,672	\$1,887	\$2,280	\$3,114
250	\$1,507	\$1,686	\$2,015	\$2,713
350	\$1,415	\$1,575	\$1,868	\$2,490
500	\$1,330	\$1,472	\$1,732	\$2,284

**APPENDIX E. ANNUAL COSTS OF RETROFIT NO<sub>x</sub> CONTROLS:  
NATURAL-GAS-FIRED ICI BOILERS**

This appendix contains cost spreadsheets for natural-gas-fired boilers retrofitted with various NO<sub>x</sub> controls. The spreadsheets are based on data from actual boiler retrofit experiences or studies. Capital annualization for all analyses are based on a 10-year amortization period and a 10-percent interest rate. All costs presented are in 1992 dollars. For further information on the methodology and assumptions made in these cost analyses, see Chapter 6.

This appendix contains cost spreadsheets for the following boilers:

<u>Boiler and NO<sub>x</sub> Control</u>	<u>Page</u>
Packaged watertube, 45 MMBtu/hr, with WI and O <sub>2</sub> trim	E-3
Packaged firetube, 10.5 MMBtu/hr, with WI and O <sub>2</sub> trim	E-5
Field-erected watertube, 75 MMBtu/hr, with BOOS and O <sub>2</sub> trim	E-7
Field-erected watertube, 75 MMBtu/hr, with BOOS, WI, and O <sub>2</sub> trim	E-9
Packaged watertube, 51, 75, and 265 MMBtu/hr, with LNB	E-11
Field-erected watertube, 590 and 1,300 MMBtu/hr, with LNB	E-17
Packaged watertube, 265 MMBtu/hr, with LNB and CEM	E-21
Packaged watertube, 17.7, 41.3, 45, 55, and 265 MMBtu/hr, with LNB and FGR	E-23
Packaged watertube, 81.3, 91, and 265 MMBtu/hr, with LNB, FGR, and CEM	E-33
Packaged firetube, 2.9, 5.23, 10.46, 20.9, and 33.5 MMBtu/hr, with FGR and O <sub>2</sub> trim	E-39
Packaged watertube, 50, 100, 150, 200, and 250 MMBtu/hr, with SCR	E-49
Field-erected watertube, 250 MMBtu/hr, with SCR	E-59
Packaged watertube, 50 and 150 MMBtu/hr, with SCR (variable catalyst life)	E-61
Field-erected watertube, 250 MMBtu/hr, with SCR (variable catalyst life)	E-69

COST EFFECTIVENESS OF RETROFIT NO <sub>x</sub> CONTROLS					
BOILER TYPE:	PACKAGED WATERTUBE	CHAP. 6 REFERENCES	COST BASE		
BOILER CAPACITY (MMBtu/hr):	45	COLANNINO, 1993	1992 DOLLARS		
FUEL TYPE:	NATURAL GAS				
CONTROL METHOD:	WATER INJECTION WITH OXYGEN TRIM				
TOTAL CAPITAL INVESTMENT COST (TCIC)					
		BOILER CAPACITY FACTOR			
		0.8	0.66	0.5	0.33
A. DIRECT CAPITAL COST (DCC)					
1. PURCHASED EQUIPMENT COST (PEC)					
PRIMARY AND AUXILIARY EQUIPMENT (EQP)	EQP				
CEM SYSTEM					
INSTRUMENTATION					
SALES TAX					
FREIGHT					
*** TOTAL PURCHASED EQUIPMENT COST ***	PEC	\$0	\$0	\$0	\$0
2. DIRECT INSTALLATION COST (DIC)					
*** TOTAL DIRECT INSTALLATION COST ***	DIC				
3. SITE PREP, SP (as required)	SP				
4. BUILDINGS, BLDG (as required)	BLDG				
*** TOTAL DIRECT CAPITAL COST ***	DCC	\$0	\$0	\$0	\$0
(PEC+DIC+SP+BLDG)					
B. INDIRECT CAPITAL COST (ICC)					
1. ENGINEERING					
2. CONSTRUCTION AND FIELD EXPENSES					
3. CONSTRUCTION FEE					
4. STARTUP					
5. PERFORMANCE TEST					
*** TOTAL INDIRECT CAPITAL COST ***	ICC	\$0	\$0	\$0	\$0
C. CONTINGENCY	CONT				
*** TOTAL CAPITAL INVESTMENT COST ***	TCIC	\$24,786	\$24,786	\$24,786	\$24,786
(DCC+ICC+CONT)					

CONTINUED ON NEXT PAGE

COST EFFECTIVENESS OF RETROFIT NOx CONTROLS						
BOILER TYPE: PACKAGED WATERTUBE		CHAP. 6 REFERENCES		COST BASE		
BOILER CAPACITY (MMBtu/hr): 45		COLANNINO, 1993		1992 DOLLARS		
FUEL TYPE: NATURAL GAS						
CONTROL METHOD: WATER INJECTION WITH OXYGEN TRIM						
ANNUAL OPERATING AND MAINTENANCE COSTS (O&M)						
		CAPACITY FACTOR	0.8	0.66	0.5	0.33
<b>A. DIRECT ANNUAL COSTS (DAC)</b>						
1.	OPERATING LABOR					
2.	MAINTENANCE LABOR					
3.	MAINTENANCE MATERIALS					
4.	REPLACEMENT MATERIALS					
5.	ELECTRICITY @ \$0.05/kw-hr					
6.	STEAM					
7.	FUEL					
8.	WASTE DISPOSAL					
9.	CHEMICALS					
10.	OTHER: 1% NET EFFICIENCY LOSS, N.GAS @ \$3.63/MMBTU		\$5,675	\$4,682	\$3,547	\$2,341
***	TOTAL DIRECT ANNUAL COSTS ***	DAC	\$5,675	\$4,682	\$3,547	\$2,341
<b>B. INDIRECT ANNUAL COSTS (IAC)</b>						
1.	OVERHEAD (60% OF SUM OF ALL LABOR AND MAINTENANCE MATERIALS)		\$0	\$0	\$0	\$0
2.	ADMINISTRATIVE (0.02*TCIC)		\$496	\$496	\$496	\$496
3.	PROPERTY TAX (0.01*TCIC)		\$248	\$248	\$248	\$248
4.	INSURANCE (0.01*TCIC)		\$248	\$248	\$248	\$248
***	TOTAL INDIRECT ANNUAL COSTS ***	IAC	\$991	\$991	\$991	\$991
***	TOTAL ANNUAL OPERATING AND MAINTENANCE COSTS *** (DAC+IAC)	O&M	\$6,666	\$5,673	\$4,538	\$3,332
COST EFFECTIVENESS						
<b>A. TOTAL ANNUALIZED COST (incl. capital and O&amp;M)</b>						
1.	ANNUALIZED CAPITAL INVESTMENT COST (ACIC)					
	EXPECTED LIFETIME OF EQUIPMENT, YEARS		10	10	10	10
	INTEREST RATE		0.1	0.1	0.1	0.1
	CAPITAL RECOVERY FACTOR		0.1627	0.1627	0.1627	0.1627
	TOTAL CAPITAL INVESTMENT COSTS (TCIC, above)		\$24,786	\$24,786	\$24,786	\$24,786
***	ANNUALIZED CAPITAL INVESTMENT COST ***	ACIC	\$4,034	\$4,034	\$4,034	\$4,034
2.	ANNUAL O&M COSTS (O&M, above)	O&M	\$6,666	\$5,673	\$4,538	\$3,332
***	TOTAL ANNUALIZED COST ***	ACIC+O&M	\$10,700	\$9,707	\$8,572	\$7,366
<b>B. NOx REMOVAL PER YEAR</b>						
1.	BASELINE NOx LEVEL (lb/MMBtu)	(NOx)1	0.16	0.16	0.16	0.16
2.	CONTROLLED NOx LEVEL (lb/MMBtu)	(NOx)2	0.056	0.056	0.056	0.056
3.	NOx REMOVAL EFFICIENCY (%)		65	65	65	65
4.	CAPACITY FACTOR	CF	0.8	0.66	0.5	0.33
5.	BOILER HEAT INPUT CAPACITY (MMBtu/hr)	CAP	45	45	45	45
***	NOx REMOVED PER YEAR (TONS/YR) ***					
	[CAP*CF*(24 hr/day)*(365 days/yr)]*[(NOx)1-(NOx)2]/2000		16.4	13.5	10.2	6.8
***	COST EFFECTIVENESS (\$/TON NOx REMOVED, 1992 DOLLARS) ***		\$652	\$717	\$836	\$1,089

COST EFFECTIVENESS OF RETROFIT NOx CONTROLS					
BOILER TYPE:	PACKAGED FIRETUBE	CHAP. 6 REFERENCES	COST BASE		
BOILER CAPACITY (MMBtu/hr):	10.5	COLANNINO, 1993	1992 DOLLARS		
FUEL TYPE:	NATURAL GAS				
CONTROL METHOD:	WATER INJECTION WITH OXYGEN TRIM				
TOTAL CAPITAL INVESTMENT COST (TCIC)					
		BOILER CAPACITY FACTOR			
		0.8	0.66	0.5	0.33
<b>A. DIRECT CAPITAL COST (DCC)</b>					
1. PURCHASED EQUIPMENT COST (PEC)					
PRIMARY AND AUXILIARY EQUIPMENT (EQP)	EQP				
CEM SYSTEM					
INSTRUMENTATION					
SALES TAX					
FREIGHT					
*** TOTAL PURCHASED EQUIPMENT COST ***	PEC	\$0	\$0	\$0	\$0
2. DIRECT INSTALLATION COST (DIC)					
*** TOTAL DIRECT INSTALLATION COST ***	DIC				
3. SITE PREP, SP (as required)	SP				
4. BUILDINGS, BLDG (as required)	BLDG				
*** TOTAL DIRECT CAPITAL COST ***	DCC	\$0	\$0	\$0	\$0
(PEC+DIC+SP+BLDG)					
<b>B. INDIRECT CAPITAL COST (ICC)</b>					
1. ENGINEERING					
2. CONSTRUCTION AND FIELD EXPENSES					
3. CONSTRUCTION FEE					
4. STARTUP					
5. PERFORMANCE TEST					
*** TOTAL INDIRECT CAPITAL COST ***	ICC	\$0	\$0	\$0	\$0
<b>C. CONTINGENCY</b>					
*** TOTAL CAPITAL INVESTMENT COST ***	TCIC	\$24,786	\$24,786	\$24,786	\$24,786
(DCC+ICC+CONT)					

CONTINUED ON NEXT PAGE

COST EFFECTIVENESS OF RETROFIT NOx CONTROLS					
BOILER TYPE: PACKAGED FIRETUBE	CHAP. 6 REFERENCES	COST BASE			
BOILER CAPACITY (MMBtu/hr): 10.5	COLANNINO, 1993	1992 DOLLARS			
FUEL TYPE: NATURAL GAS					
CONTROL METHOD: WATER INJECTION WITH OXYGEN TRIM					
ANNUAL OPERATING AND MAINTENANCE COSTS (O&M)					
	CAPACITY FACTOR	0.8	0.66	0.5	0.33
<b>A. DIRECT ANNUAL COSTS (DAC)</b>					
1. OPERATING LABOR					
2. MAINTENANCE LABOR					
3. MAINTENANCE MATERIALS					
4. REPLACEMENT MATERIALS					
5. ELECTRICITY @ \$0.05/kw-hr					
6. STEAM					
7. FUEL					
8. WASTE DISPOSAL					
9. CHEMICALS					
10. OTHER: 1% NET EFFICIENCY LOSS, N.GAS @ \$3.63/MMBTU		\$2,648	\$2,185	\$1,655	\$1,092
<b>*** TOTAL DIRECT ANNUAL COSTS ***</b>	DAC	\$2,648	\$2,185	\$1,655	\$1,092
<b>B. INDIRECT ANNUAL COSTS (IAC)</b>					
1. OVERHEAD (60% OF SUM OF ALL LABOR AND MAINTENANCE MATERIALS)		\$0	\$0	\$0	\$0
2. ADMINISTRATIVE (0.02*TCIC)		\$496	\$496	\$496	\$496
3. PROPERTY TAX (0.01*TCIC)		\$248	\$248	\$248	\$248
4. INSURANCE (0.01*TCIC)		\$248	\$248	\$248	\$248
<b>*** TOTAL INDIRECT ANNUAL COSTS ***</b>	IAC	\$991	\$991	\$991	\$991
<b>*** TOTAL ANNUAL OPERATING AND MAINTENANCE COSTS ***</b> (DAC+IAC)	O&M	\$3,640	\$3,176	\$2,646	\$2,084
COST EFFECTIVENESS					
<b>A. TOTAL ANNUALIZED COST (incl. capital and O&amp;M)</b>					
1. ANNUALIZED CAPITAL INVESTMENT COST (ACIC)					
EXPECTED LIFETIME OF EQUIPMENT, YEARS		10	10	10	10
INTEREST RATE		0.1	0.1	0.1	0.1
CAPITAL RECOVERY FACTOR		0.1627	0.1627	0.1627	0.1627
TOTAL CAPITAL INVESTMENT COSTS (TCIC, above)		\$24,786	\$24,786	\$24,786	\$24,786
<b>*** ANNUALIZED CAPITAL INVESTMENT COST ***</b>	ACIC	\$4,034	\$4,034	\$4,034	\$4,034
2. ANNUAL O&M COSTS (O&M, above)	O&M	\$3,640	\$3,176	\$2,646	\$2,084
<b>*** TOTAL ANNUALIZED COST ***</b>	ACIC+O&M	\$7,673	\$7,210	\$6,680	\$6,117
<b>B. NOx REMOVAL PER YEAR</b>					
1. BASELINE NOx LEVEL (lb/MMBtu)	(NOx)1	0.12	0.12	0.12	0.12
2. CONTROLLED NOx LEVEL (lb/MMBtu)	(NOx)2	0.042	0.042	0.042	0.042
3. NOx REMOVAL EFFICIENCY (%)		65	65	65	65
4. CAPACITY FACTOR	CF	0.8	0.66	0.5	0.33
5. BOILER HEAT INPUT CAPACITY (MMBtu/hr)	CAP	10.5	10.5	10.5	10.5
<b>*** NOx REMOVED PER YEAR (TONS/YR) ***</b> [CAP*CF*(24 hr/day)*(365 days/yr)]*[(NOx)1-(NOx)2]/2000		2.9	2.4	1.8	1.2
<b>*** COST EFFECTIVENESS (\$/TON NOx REMOVED, 1992 DOLLARS) ***</b>		\$2,674	\$3,045	\$3,724	\$5,168

COST EFFECTIVENESS OF RETROFIT NOx CONTROLS					
BOILER TYPE: FIELD ERECTED WATERTUBE		CHAP. 6 REFERENCES		COST BASE	
BOILER CAPACITY (MMBtu/hr): 75		COLANNINO, 1993		1992 DOLLARS	
FUEL TYPE: NATURAL GAS					
CONTROL METHOD: BOOS WITH OXYGEN TRIM					
TOTAL CAPITAL INVESTMENT COST (TCIC)					
		BOILER CAPACITY FACTOR			
		0.8	0.66	0.5	0.33
<b>A. DIRECT CAPITAL COST (DCC)</b>					
1. PURCHASED EQUIPMENT COST (PEC)					
PRIMARY AND AUXILIARY EQUIPMENT (EQP)		EQP			
CEM SYSTEM					
INSTRUMENTATION					
SALES TAX					
FREIGHT					
*** TOTAL PURCHASED EQUIPMENT COST ***		PEC	\$0	\$0	\$0
2. DIRECT INSTALLATION COST (DIC)					
*** TOTAL DIRECT INSTALLATION COST ***		DIC			
3. SITE PREP, SP (as required)		SP			
4. BUILDINGS, BLDG (as required)		BLDG			
*** TOTAL DIRECT CAPITAL COST ***		DCC	\$0	\$0	\$0
(PEC+DIC+SP+BLDG)					
<b>B. INDIRECT CAPITAL COST (ICC)</b>					
1. ENGINEERING					
2. CONSTRUCTION AND FIELD EXPENSES					
3. CONSTRUCTION FEE					
4. STARTUP					
5. PERFORMANCE TEST					
*** TOTAL INDIRECT CAPITAL COST ***		ICC	\$0	\$0	\$0
<b>C. CONTINGENCY</b>		CONT			
*** TOTAL CAPITAL INVESTMENT COST ***		TCIC	\$24,786	\$24,786	\$24,786
(DCC+ICC+CONT)					

CONTINUED ON NEXT PAGE

COST EFFECTIVENESS OF RETROFIT NOx CONTROLS						
BOILER TYPE: FIELD ERECTED WATERTUBE		CHAP. 6 REFERENCES		COST BASE		
BOILER CAPACITY (MMBtu/hr): 75		COLANNINO, 1993		1992 DOLLARS		
FUEL TYPE: NATURAL GAS						
CONTROL METHOD: BOOS WITH OXYGEN TRIM						
ANNUAL OPERATING AND MAINTENANCE COSTS (O&M)						
		CAPACITY FACTOR	0.8	0.66	0.5	0.33
<b>A. DIRECT ANNUAL COSTS (DAC)</b>						
1. OPERATING LABOR						
2. MAINTENANCE LABOR						
3. MAINTENANCE MATERIALS						
4. REPLACEMENT MATERIALS						
5. ELECTRICITY @ \$0.05/kw-hr						
6. STEAM						
7. FUEL						
8. WASTE DISPOSAL						
9. CHEMICALS						
10. OTHER: 1% NET EFFICIENCY LOSS, N.GAS @ \$3.63/MMBTU			\$4,729	\$3,901	\$2,956	\$1,951
<b>*** TOTAL DIRECT ANNUAL COSTS ***</b>		DAC	\$4,729	\$3,901	\$2,956	\$1,951
<b>B. INDIRECT ANNUAL COSTS (IAC)</b>						
1. OVERHEAD (60% OF SUM OF ALL LABOR AND MAINTENANCE MATERIALS)			\$0	\$0	\$0	\$0
2. ADMINISTRATIVE (0.02*TCIC)			\$496	\$496	\$496	\$496
3. PROPERTY TAX (0.01*TCIC)			\$248	\$248	\$248	\$248
4. INSURANCE (0.01*TCIC)			\$248	\$248	\$248	\$248
<b>*** TOTAL INDIRECT ANNUAL COSTS ***</b>		IAC	\$991	\$991	\$991	\$991
<b>*** TOTAL ANNUAL OPERATING AND MAINTENANCE COSTS *** (DAC+IAC)</b>		O&M	\$5,720	\$4,893	\$3,947	\$2,942
COST EFFECTIVENESS						
<b>A. TOTAL ANNUALIZED COST (incl. capital and O&amp;M)</b>						
1. ANNUALIZED CAPITAL INVESTMENT COST (ACIC)						
EXPECTED LIFETIME OF EQUIPMENT, YEARS			10	10	10	10
INTEREST RATE			0.1	0.1	0.1	0.1
CAPITAL RECOVERY FACTOR			0.1627	0.1627	0.1627	0.1627
TOTAL CAPITAL INVESTMENT COSTS (TCIC, above)			\$24,786	\$24,786	\$24,786	\$24,786
<b>*** ANNUALIZED CAPITAL INVESTMENT COST ***</b>		ACIC	\$4,034	\$4,034	\$4,034	\$4,034
2. ANNUAL O&M COSTS (O&M, above)		O&M	\$5,720	\$4,893	\$3,947	\$2,942
<b>*** TOTAL ANNUALIZED COST ***</b>		ACIC+O&M	\$9,754	\$8,927	\$7,981	\$6,976
<b>B. NOx REMOVAL PER YEAR</b>						
1. BASELINE NOx LEVEL (lb/MMBtu)		(NOx)1	0.18	0.18	0.18	0.18
2. CONTROLLED NOx LEVEL (lb/MMBtu)		(NOx)2	0.09	0.09	0.09	0.09
3. NOx REMOVAL EFFICIENCY (%)			50	50	50	50
4. CAPACITY FACTOR		CF	0.8	0.66	0.5	0.33
5. BOILER HEAT INPUT CAPACITY (MMBtu/hr)		CAP	75	75	75	75
<b>*** NOx REMOVED PER YEAR (TONS/YR) ***</b>						
[CAP*CF*(24 hr/day)*(365 days/yr)]*[(NOx)1-(NOx)2]/2000			23.7	19.5	14.8	9.8
<b>*** COST EFFECTIVENESS (\$/TON NOx REMOVED, 1992 DOLLARS). ***</b>			\$412	\$457	\$540	\$715



COST EFFECTIVENESS OF RETROFIT NOx CONTROLS					
BOILER TYPE: FIELD ERECTED WATERTUBE		CHAP. 6 REFERENCES		COST BASE	
BOILER CAPACITY (MMBtu/hr): 75		COLANNINO, 1993		1992 DOLLARS	
FUEL TYPE: NATURAL GAS					
CONTROL METHOD: BOOS & WATER INJEC WITH OXYGEN TRIM					
TOTAL CAPITAL INVESTMENT COST (TCIC)					
		BOILER CAPACITY FACTOR			
		0.8	0.66	0.5	0.33
A. DIRECT CAPITAL COST (DCC)					
1. PURCHASED EQUIPMENT COST (PEC)					
PRIMARY AND AUXILIARY EQUIPMENT (EQP)					
CEM SYSTEM					
INSTRUMENTATION					
SALES TAX					
FREIGHT					
*** TOTAL PURCHASED EQUIPMENT COST ***		\$0	\$0	\$0	\$0
2. DIRECT INSTALLATION COST (DIC)					
*** TOTAL DIRECT INSTALLATION COST ***					
3. SITE PREP, SP (as required)					
4. BUILDINGS, BLDG (as required)					
*** TOTAL DIRECT CAPITAL COST *** (PEC+DIC+SP+BLDG)		\$0	\$0	\$0	\$0
B. INDIRECT CAPITAL COST (ICC)					
1. ENGINEERING					
2. CONSTRUCTION AND FIELD EXPENSES					
3. CONSTRUCTION FEE					
4. STARTUP					
5. PERFORMANCE TEST					
*** TOTAL INDIRECT CAPITAL COST ***		\$0	\$0	\$0	\$0
C. CONTINGENCY					
*** TOTAL CAPITAL INVESTMENT COST *** (DCC+ICC+CONT)		\$34,700	\$34,700	\$34,700	\$34,700

CONTINUED ON NEXT PAGE

COST EFFECTIVENESS OF RETROFIT NO <sub>x</sub> CONTROLS						
BOILER TYPE:	FIELD ERECTED WATERTUBE	CHAP. 6 REFERENCES	COST BASE			
BOILER CAPACITY (MMBtu/hr):	75	COLANNINO, 1993	1992 DOLLARS			
FUEL TYPE:	NATURAL GAS					
CONTROL METHOD:	BOOS & WATER INJEC WITH OXYGEN TRIM					
ANNUAL OPERATING AND MAINTENANCE COSTS (O&M)						
	CAPACITY FACTOR	0.8	0.66	0.5	0.33	
<b>A. DIRECT ANNUAL COSTS (DAC)</b>						
1.	OPERATING LABOR					
2.	MAINTENANCE LABOR					
3.	MAINTENANCE MATERIALS					
4.	REPLACEMENT MATERIALS					
5.	ELECTRICITY @ \$0.05/kW-hr					
6.	STEAM					
7.	FUEL					
8.	WASTE DISPOSAL					
9.	CHEMICALS					
10.	OTHER: 1% NET EFFICIENCY LOSS, N.GAS @ \$3.63/MMBTU	\$18,915	\$15,605	\$11,822	\$7,803	
***	TOTAL DIRECT ANNUAL COSTS ***	DAC	\$18,915	\$15,605	\$11,822	\$7,803
<b>B. INDIRECT ANNUAL COSTS (IAC)</b>						
1.	OVERHEAD (60% OF SUM OF ALL LABOR AND MAINTENANCE MATERIALS)	\$0	\$0	\$0	\$0	
2.	ADMINISTRATIVE (0.02*TCIC)	\$694	\$694	\$694	\$694	
3.	PROPERTY TAX (0.01*TCIC)	\$347	\$347	\$347	\$347	
4.	INSURANCE (0.01*TCIC)	\$347	\$347	\$347	\$347	
***	TOTAL INDIRECT ANNUAL COSTS ***	IAC	\$1,388	\$1,388	\$1,388	\$1,388
***	TOTAL ANNUAL OPERATING AND MAINTENANCE COSTS ***	O&M	\$20,303	\$16,993	\$13,210	\$9,191
(DAC+IAC)						
COST EFFECTIVENESS						
<b>A. TOTAL ANNUALIZED COST (incl. capital and O&amp;M)</b>						
1.	ANNUALIZED CAPITAL INVESTMENT COST (ACIC)					
	EXPECTED LIFETIME OF EQUIPMENT, YEARS	10	10	10	10	
	INTEREST RATE	0.1	0.1	0.1	0.1	
	CAPITAL RECOVERY FACTOR	0.1627	0.1627	0.1627	0.1627	
	TOTAL CAPITAL INVESTMENT COSTS (TCIC, above)	\$34,700	\$34,700	\$34,700	\$34,700	
***	ANNUALIZED CAPITAL INVESTMENT COST ***	ACIC	\$5,647	\$5,647	\$5,647	\$5,647
2.	ANNUAL O&M COSTS (O&M, above)	O&M	\$20,303	\$16,993	\$13,210	\$9,191
***	TOTAL ANNUALIZED COST ***	ACIC+O&M	\$25,951	\$22,640	\$18,857	\$14,838
<b>B. NO<sub>x</sub> REMOVAL PER YEAR</b>						
1.	BASELINE NO <sub>x</sub> LEVEL (lb/MMBtu)	(NO <sub>x</sub> )1	0.18	0.18	0.18	0.18
2.	CONTROLLED NO <sub>x</sub> LEVEL (lb/MMBtu)	(NO <sub>x</sub> )2	0.045	0.045	0.045	0.045
3.	NO <sub>x</sub> REMOVAL EFFICIENCY (%)		75	75	75	75
4.	CAPACITY FACTOR	CF	0.8	0.66	0.5	0.33
5.	BOILER HEAT INPUT CAPACITY (MMBtu/hr)	CAP	75	75	75	75
***	NO <sub>x</sub> REMOVED PER YEAR (TONS/YR) ***					
	[CAP*CF*(24 hr/day)*(365 days/yr)]*[(NO <sub>x</sub> )1-(NO <sub>x</sub> )2]/2000		35.5	29.3	22.2	14.6
***	COST EFFECTIVENESS (\$/TON NO <sub>x</sub> REMOVED, 1992 DOLLARS) ***		\$731	\$774	\$850	\$1,014

COST EFFECTIVENESS OF RETROFIT NO <sub>x</sub> CONTROLS					
BOILER TYPE:	PACKAGED WATERTUBE	CHAP. 6 REFERENCES	COST BASE		
BOILER CAPACITY (MMBtu/hr):	51	CAL ARB, 1987	1992 DOLLARS		
FUEL TYPE:	NATURAL GAS				
CONTROL METHOD:	LOW NO <sub>x</sub> BURNER				
TOTAL CAPITAL INVESTMENT COST (TCIC)					
		BOILER CAPACITY FACTOR			
		0.8	0.66	0.5	0.33
<b>A. DIRECT CAPITAL COST (DCC)</b>					
1. PURCHASED EQUIPMENT COST (PEC)					
PRIMARY AND AUXILIARY EQUIPMENT (EQP)	EQP	\$19,828	\$19,828	\$19,828	\$19,828
CEM SYSTEM					
INSTRUMENTATION					
SALES TAX					
FREIGHT					
*** TOTAL PURCHASED EQUIPMENT COST ***	PEC	\$19,828	\$19,828	\$19,828	\$19,828
2. DIRECT INSTALLATION COST (DIC)					
*** TOTAL DIRECT INSTALLATION COST ***	DIC	\$13,285	\$13,285	\$13,285	\$13,285
3. SITE PREP, SP (as required)					
	SP				
4. BUILDINGS, BLDG (as required)					
	BLDG				
*** TOTAL DIRECT CAPITAL COST *** (PEC+DIC+SP+BLDG)	DCC	\$33,113	\$33,113	\$33,113	\$33,113
<b>B. INDIRECT CAPITAL COST (ICC)</b>					
1. ENGINEERING					
2. CONSTRUCTION AND FIELD EXPENSES					
3. CONSTRUCTION FEE					
4. STARTUP					
5. PERFORMANCE TEST					
*** TOTAL INDIRECT CAPITAL COST ***	ICC	\$0	\$0	\$0	\$0
<b>C. CONTINGENCY</b>					
	CONT				
*** TOTAL CAPITAL INVESTMENT COST *** (DCC+ICC+CONT)	TCIC	\$33,113	\$33,113	\$33,113	\$33,113

CONTINUED ON NEXT PAGE

COST EFFECTIVENESS OF RETROFIT NO <sub>x</sub> CONTROLS						
BOILER TYPE: PACKAGED WATERTUBE		CHAP. 6 REFERENCES		COST BASE		
BOILER CAPACITY (MMBtu/hr): 51		CAL ARB, 1987		1992 DOLLARS		
FUEL TYPE: NATURAL GAS						
CONTROL METHOD: LOW NO <sub>x</sub> BURNER						
ANNUAL OPERATING AND MAINTENANCE COSTS (O&M)						
		CAPACITY FACTOR	0.8	0.66	0.5	0.33
A. DIRECT ANNUAL COSTS (DAC)						
1. OPERATING LABOR						
2. MAINTENANCE LABOR						
3. MAINTENANCE MATERIALS						
4. REPLACEMENT MATERIALS						
5. ELECTRICITY @ \$0.05/kW-hr						
6. STEAM						
7. FUEL						
8. WASTE DISPOSAL						
9. CHEMICALS						
10. OTHER						
*** TOTAL DIRECT ANNUAL COSTS ***		DAC	\$0	\$0	\$0	\$0
B. INDIRECT ANNUAL COSTS (IAC)						
1. OVERHEAD (60% OF SUM OF ALL LABOR AND MAINTENANCE MATERIALS)			\$0	\$0	\$0	\$0
2. ADMINISTRATIVE (0.02*TCIC)			\$662	\$662	\$662	\$662
3. PROPERTY TAX (0.01*TCIC)			\$331	\$331	\$331	\$331
4. INSURANCE (0.01*TCIC)			\$331	\$331	\$331	\$331
*** TOTAL INDIRECT ANNUAL COSTS ***		IAC	\$1,325	\$1,325	\$1,325	\$1,325
*** TOTAL ANNUAL OPERATING AND MAINTENANCE COSTS *** (DAC+IAC)		O&M	\$1,325	\$1,325	\$1,325	\$1,325
COST EFFECTIVENESS						
A. TOTAL ANNUALIZED COST (incl. capital and O&M)						
1. ANNUALIZED CAPITAL INVESTMENT COST (ACIC)						
EXPECTED LIFETIME OF EQUIPMENT, YEARS			10	10	10	10
INTEREST RATE			0.1	0.1	0.1	0.1
CAPITAL RECOVERY FACTOR			0.1627	0.1627	0.1627	0.1627
TOTAL CAPITAL INVESTMENT COSTS (TCIC, above)			\$33,113	\$33,113	\$33,113	\$33,113
*** ANNUALIZED CAPITAL INVESTMENT COST ***		ACIC	\$5,389	\$5,389	\$5,389	\$5,389
2. ANNUAL O&M COSTS (O&M, above)		O&M	\$1,325	\$1,325	\$1,325	\$1,325
*** TOTAL ANNUALIZED COST ***		ACIC+O&M	\$6,714	\$6,714	\$6,714	\$6,714
B. NO <sub>x</sub> REMOVAL PER YEAR						
1. BASELINE NO <sub>x</sub> LEVEL (lb/MMBtu)		{NO <sub>x</sub> }1	0.16	0.16	0.16	0.16
2. CONTROLLED NO <sub>x</sub> LEVEL (lb/MMBtu)		{NO <sub>x</sub> }2	0.08	0.08	0.08	0.08
3. NO <sub>x</sub> REMOVAL EFFICIENCY (%)			50	50	50	50
4. CAPACITY FACTOR		CF	0.8	0.66	0.5	0.33
5. BOILER HEAT INPUT CAPACITY (MMBtu/hr)		CAP	51	51	51	51
*** NO <sub>x</sub> REMOVED PER YEAR (TONS/YR) ***						
[CAP*CF*(24 hr/day)*(365 days/yr)]*[(NO <sub>x</sub> }1)-(NO <sub>x</sub> }2)/2000			14.3	11.8	8.9	5.9
*** COST EFFECTIVENESS (\$/TON NO <sub>x</sub> REMOVED, 1992 DOLLARS) ***			\$470	\$569	\$751	\$1,138

COST EFFECTIVENESS OF RETROFIT NOx CONTROLS					
BOILER TYPE:	PACKAGED WATERTUBE	CHAP. 6 REFERENCES	COST BASE		
BOILER CAPACITY (MMBtu/hr):	75	CAL ARB, 1987	1992 DOLLARS		
FUEL TYPE:	NATURAL GAS				
CONTROL METHOD:	LOW NOx BURNER				
TOTAL CAPITAL INVESTMENT COST (TCIC)					
		BOILER CAPACITY FACTOR			
		0.8	0.66	0.5	0.33
<b>A. DIRECT CAPITAL COST (DCC)</b>					
1. PURCHASED EQUIPMENT COST (PEC)					
PRIMARY AND AUXILIARY EQUIPMENT (EQP)	EQP	\$65,235	\$65,235	\$65,235	\$65,235
CEM SYSTEM					
INSTRUMENTATION					
SALES TAX					
FREIGHT					
*** TOTAL PURCHASED EQUIPMENT COST ***	PEC	\$65,235	\$65,235	\$65,235	\$65,235
2. DIRECT INSTALLATION COST (DIC)					
*** TOTAL DIRECT INSTALLATION COST ***	DIC	\$15,466	\$15,466	\$15,466	\$15,466
3. SITE PREP, SP (as required)	SP				
4. BUILDINGS, BLDG (as required)	BLDG				
*** TOTAL DIRECT CAPITAL COST *** (PEC+DIC+SP+BLDG)	DCC	\$80,702	\$80,702	\$80,702	\$80,702
<b>B. INDIRECT CAPITAL COST (ICC)</b>					
1. ENGINEERING					
2. CONSTRUCTION AND FIELD EXPENSES					
3. CONSTRUCTION FEE					
4. STARTUP					
5. PERFORMANCE TEST					
*** TOTAL INDIRECT CAPITAL COST ***	ICC	\$29,842	\$29,842	\$29,842	\$29,842
<b>C. CONTINGENCY</b>					
CONT					
*** TOTAL CAPITAL INVESTMENT COST *** (DCC+ICC+CONT)	TCIC	\$110,543	\$110,543	\$110,543	\$110,543

CONTINUED ON NEXT PAGE

COST EFFECTIVENESS OF RETROFIT NO <sub>x</sub> CONTROLS					
BOILER TYPE: PACKAGED WATERTUBE	CHAP. 6 REFERENCES	COST BASE			
BOILER CAPACITY (MMBtu/hr): 75	CAL ARB, 1987	1992 DOLLARS			
FUEL TYPE: NATURAL GAS					
CONTROL METHOD: LOW NO <sub>x</sub> BURNER					
<b>ANNUAL OPERATING AND MAINTENANCE COSTS (O&amp;M)</b>					
	CAPACITY FACTOR	0.8	0.66	0.5	0.33
<b>A. DIRECT ANNUAL COSTS (DAC)</b>					
1. OPERATING LABOR					
2. MAINTENANCE LABOR					
3. MAINTENANCE MATERIALS					
4. REPLACEMENT MATERIALS					
5. ELECTRICITY @ \$0.05/kW-hr					
6. STEAM					
7. FUEL					
8. WASTE DISPOSAL					
9. CHEMICALS					
10. OTHER					
*** TOTAL DIRECT ANNUAL COSTS ***	DAC	\$0	\$0	\$0	\$0
<b>B. INDIRECT ANNUAL COSTS (IAC)</b>					
1. OVERHEAD (60% OF SUM OF ALL LABOR AND MAINTENANCE MATERIALS)		\$0	\$0	\$0	\$0
2. ADMINISTRATIVE (0.02*TCIC)		\$2,211	\$2,211	\$2,211	\$2,211
3. PROPERTY TAX (0.01*TCIC)		\$1,105	\$1,105	\$1,105	\$1,105
4. INSURANCE (0.01*TCIC)		\$1,105	\$1,105	\$1,105	\$1,105
*** TOTAL INDIRECT ANNUAL COSTS ***	IAC	\$4,422	\$4,422	\$4,422	\$4,422
*** TOTAL ANNUAL OPERATING AND MAINTENANCE COSTS *** (DAC+IAC)	O&M	\$4,422	\$4,422	\$4,422	\$4,422
<b>COST EFFECTIVENESS</b>					
<b>A. TOTAL ANNUALIZED COST (incl. capital and O&amp;M)</b>					
1. ANNUALIZED CAPITAL INVESTMENT COST (ACIC)					
EXPECTED LIFETIME OF EQUIPMENT, YEARS		10	10	10	10
INTEREST RATE		0.1	0.1	0.1	0.1
CAPITAL RECOVERY FACTOR		0.1627	0.1627	0.1627	0.1627
TOTAL CAPITAL INVESTMENT COSTS (TCIC, above)		\$110,543	\$110,543	\$110,543	\$110,543
*** ANNUALIZED CAPITAL INVESTMENT COST ***	ACIC	\$17,990	\$17,990	\$17,990	\$17,990
2. ANNUAL O&M COSTS (O&M, above)	O&M	\$4,422	\$4,422	\$4,422	\$4,422
*** TOTAL ANNUALIZED COST ***	ACIC+O&M	\$22,412	\$22,412	\$22,412	\$22,412
<b>B. NO<sub>x</sub> REMOVAL PER YEAR</b>					
1. BASELINE NO <sub>x</sub> LEVEL (1b/MMBtu)	(NO <sub>x</sub> )1	0.18	0.18	0.18	0.18
2. CONTROLLED NO <sub>x</sub> LEVEL (1b/MMBtu)	(NO <sub>x</sub> )2	0.09	0.09	0.09	0.09
3. NO <sub>x</sub> REMOVAL EFFICIENCY (%)		50	50	50	50
4. CAPACITY FACTOR	CF	0.8	0.66	0.5	0.33
5. BOILER HEAT INPUT CAPACITY (MMBtu/hr)	CAP	75	75	75	75
*** NO <sub>x</sub> REMOVED PER YEAR (TONS/YR) ***					
[CAP*CF*(24 hr/day)*(365 days/yr)]*[(NO <sub>x</sub> )1-(NO <sub>x</sub> )2]/2000		23.7	19.5	14.8	9.8
*** COST EFFECTIVENESS (\$/TON NO <sub>x</sub> REMOVED, 1992 DOLLARS) ***		\$948	\$1,149	\$1,516	\$2,297

COST EFFECTIVENESS OF RETROFIT NOx CONTROLS

BOILER TYPE: PACKAGED WATERTUBE	CHAP. 6 REFERENCES	COST BASE
BOILER CAPACITY (MMBtu/hr): 265	CIBO, 1992	1992 DOLLARS
FUEL TYPE: NATURAL GAS		
CONTROL METHOD: LOW NOx BURNER		

TOTAL CAPITAL INVESTMENT COST (TCIC)

		BOILER CAPACITY FACTOR			
		0.8	0.66	0.5	0.33
<b>A. DIRECT CAPITAL COST (DCC)</b>					
<b>1. PURCHASED EQUIPMENT COST (PEC)</b>					
PRIMARY AND AUXILIARY EQUIPMENT (EQP)	EQP				
CEN SYSTEM					
INSTRUMENTATION					
SALES TAX					
FREIGHT	320000				
*** TOTAL PURCHASED EQUIPMENT COST ***	PEC	\$158,723	\$158,723	\$158,723	\$158,723
<b>2. DIRECT INSTALLATION COST (DIC)</b>					
*** TOTAL DIRECT INSTALLATION COST ***	DIC	\$47,617	\$47,617	\$47,617	\$47,617
(30 percent of purchased equipment)					
3. SITE PREP, SP (as required)	SP				
4. BUILDINGS, BLDG (as required)	BLDG				
*** TOTAL DIRECT CAPITAL COST ***	DCC	\$206,340	\$206,340	\$206,340	\$206,340
(PEC+DIC+SP+BLDG)					
<b>B. INDIRECT CAPITAL COST (ICC)</b>					
1. ENGINEERING (0.10PEC)		\$15,872	\$15,872	\$15,872	\$15,872
2. CONSTRUCTION AND FIELD EXPENSES (0.10PEC)		\$15,872	\$15,872	\$15,872	\$15,872
3. CONSTRUCTION FEE (0.10PEC)		\$15,872	\$15,872	\$15,872	\$15,872
4. STARTUP (0.02PEC)		\$3,174	\$3,174	\$3,174	\$3,174
5. PERFORMANCE TEST (0.01PEC)		\$1,587	\$1,587	\$1,587	\$1,587
*** TOTAL INDIRECT CAPITAL COST ***	ICC	\$52,379	\$52,379	\$52,379	\$52,379
<b>C. CONTINGENCY (20 percent of direct and indirect)</b>					
	CONT	\$51,744	\$51,744	\$51,744	\$51,744
*** TOTAL CAPITAL INVESTMENT COST ***	TCIC	\$310,463	\$310,463	\$310,463	\$310,463
(DCC+ICC+CONT)					

CONTINUED ON NEXT PAGE

COST EFFECTIVENESS OF RETROFIT NO <sub>x</sub> CONTROLS						
BOILER TYPE: PACKAGED WATERTUBE		CHAP. 6 REFERENCES		COST BASE		
BOILER CAPACITY (MMBtu/hr): 265		CIBO, 1992		1992 DOLLARS		
FUEL TYPE: NATURAL GAS						
CONTROL METHOD: LOW NO <sub>x</sub> BURNER						
ANNUAL OPERATING AND MAINTENANCE COSTS (O&M)						
		CAPACITY FACTOR	0.8	0.66	0.5	0.33
<b>A. DIRECT ANNUAL COSTS (DAC)</b>						
1. OPERATING LABOR						
2. MAINTENANCE LABOR						
3. MAINTENANCE MATERIALS						
4. REPLACEMENT MATERIALS						
5. ELECTRICITY @ \$0.05/kW-hr						
6. STEAM						
7. FUEL						
8. WASTE DISPOSAL						
9. CHEMICALS						
10. OTHER						
*** TOTAL DIRECT ANNUAL COSTS ***		DAC	\$0	\$0	\$0	\$0
<b>B. INDIRECT ANNUAL COSTS (IAC)</b>						
1. OVERHEAD (60% OF SUM OF ALL LABOR AND MAINTENANCE MATERIALS)						
2. ADMINISTRATIVE (0.02*TCIC)						
3. PROPERTY TAX (0.01*TCIC)						
4. INSURANCE (0.01*TCIC)						
*** TOTAL INDIRECT ANNUAL COSTS ***		IAC	\$12,419	\$12,419	\$12,419	\$12,419
*** TOTAL ANNUAL OPERATING AND MAINTENANCE COSTS *** (DAC+IAC)		O&M	\$12,419	\$12,419	\$12,419	\$12,419
COST EFFECTIVENESS						
<b>A. TOTAL ANNUALIZED COST (incl. capital and O&amp;M)</b>						
1. ANNUALIZED CAPITAL INVESTMENT COST (ACIC)						
EXPECTED LIFETIME OF EQUIPMENT, YEARS						
INTEREST RATE						
CAPITAL RECOVERY FACTOR						
TOTAL CAPITAL INVESTMENT COSTS (TCIC, above)						
*** ANNUALIZED CAPITAL INVESTMENT COST ***		ACIC	\$50,526	\$50,526	\$50,526	\$50,526
2. ANNUAL O&M COSTS (O&M, above)		O&M	\$12,419	\$12,419	\$12,419	\$12,419
*** TOTAL ANNUALIZED COST ***		ACIC+O&M	\$62,945	\$62,945	\$62,945	\$62,945
<b>B. NO<sub>x</sub> REMOVAL PER YEAR</b>						
1. BASELINE NO <sub>x</sub> LEVEL (lb/MMBtu) (NO <sub>x</sub> )1						
2. CONTROLLED NO <sub>x</sub> LEVEL (lb/MMBtu) (NO <sub>x</sub> )2						
3. NO <sub>x</sub> REMOVAL EFFICIENCY (%)						
4. CAPACITY FACTOR CF						
5. BOILER HEAT INPUT CAPACITY (MMBtu/hr) CAP						
*** NO <sub>x</sub> REMOVED PER YEAR (TONS/YR) *** [CAP*CF*(24 hr/day)*(365 days/yr)]*[(NO <sub>x</sub> )1-(NO <sub>x</sub> )2]/2000			111.4	91.9	69.6	46.0
*** COST EFFECTIVENESS (\$/TON NO <sub>x</sub> REMOVED, 1992 DOLLARS) ***			\$565	\$685	\$904	\$1,369



COST EFFECTIVENESS OF RETROFIT NO <sub>x</sub> CONTROLS					
BOILER TYPE:	FIELD ERECTED WATERTUBE	CHAP. 6 REFERENCES	COST BASE		
BOILER CAPACITY (MMBtu/hr):	590	CIBO, 1992	1992 DOLLARS		
FUEL TYPE:	NATURAL GAS				
CONTROL METHOD:	LOW NO <sub>x</sub> BURNER				
TOTAL CAPITAL INVESTMENT COST (TCIC)					
		BOILER CAPACITY FACTOR			
		0.8	0.66	0.5	0.33
<b>A. DIRECT CAPITAL COST (DCC)</b>					
1. PURCHASED EQUIPMENT COST (PEC)					
PRIMARY AND AUXILIARY EQUIPMENT (EQP)	EQP				
CEM SYSTEM					
INSTRUMENTATION					
SALES TAX					
FREIGHT					
*** TOTAL PURCHASED EQUIPMENT COST ***	PEC	\$1,175,725	\$1,175,725	\$1,175,725	\$1,175,725
2. DIRECT INSTALLATION COST (DIC)					
*** TOTAL DIRECT INSTALLATION COST ***	DIC	\$352,717	\$352,717	\$352,717	\$352,717
(30 percent of purchased equipment)					
3. SITE PREP, SP (as required)	SP				
4. BUILDINGS, BLDG (as required)	BLDG				
*** TOTAL DIRECT CAPITAL COST ***	DCC	\$1,528,442	\$1,528,442	\$1,528,442	\$1,528,442
(PEC+DIC+SP+BLDG)					
<b>B. INDIRECT CAPITAL COST (ICC)</b>					
1. ENGINEERING (0.10PEC)		\$117,572	\$117,572	\$117,572	\$117,572
2. CONSTRUCTION AND FIELD EXPENSES (0.10PEC)		\$117,572	\$117,572	\$117,572	\$117,572
3. CONSTRUCTION FEE (0.10PEC)		\$117,572	\$117,572	\$117,572	\$117,572
4. STARTUP (0.02PEC)		\$23,514	\$23,514	\$23,514	\$23,514
5. PERFORMANCE TEST (0.01PEC)		\$11,757	\$11,757	\$11,757	\$11,757
*** TOTAL INDIRECT CAPITAL COST ***	ICC	\$387,989	\$387,989	\$387,989	\$387,989
<b>C. CONTINGENCY (20 PERCENT OF DIRECT AND INDIRECT)</b>					
	CONT	\$383,286	\$383,286	\$383,286	\$383,286
*** TOTAL CAPITAL INVESTMENT COST ***	TCIC	\$2,299,718	\$2,299,718	\$2,299,718	\$2,299,718
(DCC+ICC+CONT)					

CONTINUED ON NEXT PAGE

COST EFFECTIVENESS OF RETROFIT NOx CONTROLS					
BOILER TYPE: FIELD ERECTED WATERTUBE	CHAP. 6 REFERENCES	COST BASE			
BOILER CAPACITY (MMBtu/hr): 590	CIBO, 1992	1992 DOLLARS			
FUEL TYPE: NATURAL GAS					
CONTROL METHOD: LOW NOx BURNER					
ANNUAL OPERATING AND MAINTENANCE COSTS (O&M)					
	CAPACITY FACTOR	0.8	0.66	0.5	0.33
<b>A. DIRECT ANNUAL COSTS (DAC)</b>					
1. OPERATING LABOR					
2. MAINTENANCE LABOR					
3. MAINTENANCE MATERIALS					
4. REPLACEMENT MATERIALS					
5. ELECTRICITY @ \$0.05/kw-hr					
6. STEAM					
7. FUEL					
8. WASTE DISPOSAL					
9. CHEMICALS					
10. OTHER					
<b>*** TOTAL DIRECT ANNUAL COSTS ***</b>	DAC	\$0	\$0	\$0	\$0
<b>B. INDIRECT ANNUAL COSTS (IAC)</b>					
1. OVERHEAD (60% OF SUM OF ALL LABOR AND MAINTENANCE MATERIALS)		\$0	\$0	\$0	\$0
2. ADMINISTRATIVE (0.02*TCIC)		\$45,994	\$45,994	\$45,994	\$45,994
3. PROPERTY TAX (0.01*TCIC)		\$22,997	\$22,997	\$22,997	\$22,997
4. INSURANCE (0.01*TCIC)		\$22,997	\$22,997	\$22,997	\$22,997
<b>*** TOTAL INDIRECT ANNUAL COSTS ***</b>	IAC	\$91,989	\$91,989	\$91,989	\$91,989
<b>*** TOTAL ANNUAL OPERATING AND MAINTENANCE COSTS ***</b> (DAC+IAC)	O&M	\$91,989	\$91,989	\$91,989	\$91,989
COST EFFECTIVENESS					
<b>A. TOTAL ANNUALIZED COST (incl. capital and O&amp;M)</b>					
1. ANNUALIZED CAPITAL INVESTMENT COST (ACIC)					
EXPECTED LIFETIME OF EQUIPMENT, YEARS		10	10	10	10
INTEREST RATE		0.1	0.1	0.1	0.1
CAPITAL RECOVERY FACTOR		0.16274539	0.16274539	0.16274539	0.16274539
TOTAL CAPITAL INVESTMENT COSTS (TCIC, above)		\$2,299,718	\$2,299,718	\$2,299,718	\$2,299,718
<b>*** ANNUALIZED CAPITAL INVESTMENT COST ***</b>	ACIC	\$374,269	\$374,269	\$374,269	\$374,269
2. ANNUAL O&M COSTS (O&M, above)	O&M	\$91,989	\$91,989	\$91,989	\$91,989
<b>*** TOTAL ANNUALIZED COST ***</b>	ACIC+O&M	\$466,257	\$466,257	\$466,257	\$466,257
<b>B. NOx REMOVAL PER YEAR</b>					
1. BASELINE NOx LEVEL (lb/MMBtu)	(NOx)1	0.3	0.3	0.3	0.3
2. CONTROLLED NOx LEVEL (lb/MMBtu)	(NOx)2	0.15	0.15	0.15	0.15
3. NOx REMOVAL EFFICIENCY (%)		50	50	50	50
4. CAPACITY FACTOR	CF	0.8	0.66	0.5	0.33
5. BOILER HEAT INPUT CAPACITY (MMBtu/hr)	CAP	590	590	590	590
<b>*** NOx REMOVED PER YEAR (TONS/YR) ***</b> [CAP*CF*(24 hr/day)*(365 days/yr)]*[(NOx)1-(NOx)2]/2000		310.1	255.8	193.8	127.9
<b>*** COST EFFECTIVENESS (\$/TON NOx REMOVED, 1992 DOLLARS) ***</b>		\$1,504	\$1,822	\$2,406	\$3,645

COST EFFECTIVENESS OF RETROFIT NOx CONTROLS					
BOILER TYPE: FIELD ERECTED WATERTUBE		CHAP. 6 REFERENCES		COST BASE	
BOILER CAPACITY (MMBtu/hr): 1300		CIBO, 1992		1992 DOLLARS	
FUEL TYPE: NATURAL GAS					
CONTROL METHOD: LOW NOx BURNER					
TOTAL CAPITAL INVESTMENT COST (TCIC)					
		BOILER CAPACITY FACTOR			
		0.8	0.66	0.5	0.33
<b>A. DIRECT CAPITAL COST (DCC)</b>					
1. PURCHASED EQUIPMENT COST (PEC)					
PRIMARY AND AUXILIARY EQUIPMENT (EQP)	EQP				
CEM SYSTEM					
INSTRUMENTATION					
SALES TAX					
FREIGHT					
*** TOTAL PURCHASED EQUIPMENT COST ***	PEC	\$3,056,885	\$3,056,885	\$3,056,885	\$3,056,885
2. DIRECT INSTALLATION COST (DIC)					
*** TOTAL DIRECT INSTALLATION COST ***	DIC	\$917,065	\$917,065	\$917,065	\$917,065
(30 percent of purchased equipment)					
3. SITE PREP, SP (as required)	SP				
4. BUILDINGS, BLDG (as required)	BLDG				
*** TOTAL DIRECT CAPITAL COST ***	DCC	\$3,973,950	\$3,973,950	\$3,973,950	\$3,973,950
(PEC+DIC+SP+BLDG)					
<b>B. INDIRECT CAPITAL COST (ICC)</b>					
1. ENGINEERING (0.10PEC)		\$305,688	\$305,688	\$305,688	\$305,688
2. CONSTRUCTION AND FIELD EXPENSES (0.10PEC)		\$305,688	\$305,688	\$305,688	\$305,688
3. CONSTRUCTION FEE (0.10PEC)		\$305,688	\$305,688	\$305,688	\$305,688
4. STARTUP (0.02PEC)		\$61,138	\$61,138	\$61,138	\$61,138
5. PERFORMANCE TEST (0.01PEC)		\$30,569	\$30,569	\$30,569	\$30,569
*** TOTAL INDIRECT CAPITAL COST ***	ICC	\$1,008,772	\$1,008,772	\$1,008,772	\$1,008,772
<b>C. CONTINGENCY (20 percent of direct and indirect)</b>					
	CONT	\$996,544	\$996,544	\$996,544	\$996,544
*** TOTAL CAPITAL INVESTMENT COST ***	TCIC	\$5,979,267	\$5,979,267	\$5,979,267	\$5,979,267
(DCC+ICC+CONT)					

CONTINUED ON NEXT PAGE

COST EFFECTIVENESS OF RETROFIT NO <sub>x</sub> CONTROLS						
BOILER TYPE: FIELD ERECTED WATERTUBE		CHAP. 6 REFERENCES		COST BASE		
BOILER CAPACITY (MMBtu/hr): 1300		CIBO, 1992		1992 DOLLARS		
FUEL TYPE: NATURAL GAS						
CONTROL METHOD: LOW NO <sub>x</sub> BURNER						
ANNUAL OPERATING AND MAINTENANCE COSTS (O&M)						
		CAPACITY FACTOR	0.8	0.66	0.5	0.33
A. DIRECT ANNUAL COSTS (DAC)						
1. OPERATING LABOR						
2. MAINTENANCE LABOR						
3. MAINTENANCE MATERIALS						
4. REPLACEMENT MATERIALS						
5. ELECTRICITY @ \$0.05/kW-hr						
6. STEAM						
7. FUEL						
8. WASTE DISPOSAL						
9. CHEMICALS						
10. OTHER						
*** TOTAL DIRECT ANNUAL COSTS ***		DAC	\$0	\$0	\$0	\$0
B. INDIRECT ANNUAL COSTS (IAC)						
1. OVERHEAD (60% OF SUM OF ALL LABOR AND MAINTENANCE MATERIALS)						
			\$0	\$0	\$0	\$0
2. ADMINISTRATIVE (0.02*TCIC)						
			\$119,585	\$119,585	\$119,585	\$119,585
3. PROPERTY TAX (0.01*TCIC)						
			\$59,793	\$59,793	\$59,793	\$59,793
4. INSURANCE (0.01*TCIC)						
			\$59,793	\$59,793	\$59,793	\$59,793
*** TOTAL INDIRECT ANNUAL COSTS ***		IAC	\$239,171	\$239,171	\$239,171	\$239,171
*** TOTAL ANNUAL OPERATING AND MAINTENANCE COSTS *** (DAC+IAC)		O&M	\$239,171	\$239,171	\$239,171	\$239,171
COST EFFECTIVENESS						
A. TOTAL ANNUALIZED COST (incl. capital and O&M)						
1. ANNUALIZED CAPITAL INVESTMENT COST (ACIC)						
EXPECTED LIFETIME OF EQUIPMENT, YEARS						
			10	10	10	10
INTEREST RATE						
			0.1	0.1	0.1	0.1
CAPITAL RECOVERY FACTOR						
			0.1627	0.1627	0.1627	0.1627
TOTAL CAPITAL INVESTMENT COSTS (TCIC, above)						
			\$5,979,267	\$5,979,267	\$5,979,267	\$5,979,267
*** ANNUALIZED CAPITAL INVESTMENT COST ***		ACIC	\$973,098	\$973,098	\$973,098	\$973,098
2. ANNUAL O&M COSTS (O&M, above)						
		O&M	\$239,171	\$239,171	\$239,171	\$239,171
*** TOTAL ANNUALIZED COST ***		ACIC+O&M	\$1,212,269	\$1,212,269	\$1,212,269	\$1,212,269
B. NO <sub>x</sub> REMOVAL PER YEAR						
1. BASELINE NO <sub>x</sub> LEVEL (lb/MMBtu)						
		(NO <sub>x</sub> )1	0.4	0.4	0.4	0.4
2. CONTROLLED NO <sub>x</sub> LEVEL (lb/MMBtu)						
		(NO <sub>x</sub> )2	0.2	0.2	0.2	0.2
3. NO <sub>x</sub> REMOVAL EFFICIENCY (%)						
			50	50	50	50
4. CAPACITY FACTOR						
		CF	0.8	0.66	0.5	0.33
5. BOILER HEAT INPUT CAPACITY (MMBtu/hr)						
		CAP	1300	1300	1300	1300
*** NO <sub>x</sub> REMOVED PER YEAR (TONS/YR) ***						
			911.0	751.6	569.4	375.8
			[CAP*CF*(24 hr/day)*(365 days/yr)]*[(NO <sub>x</sub> )1-(NO <sub>x</sub> )2]/2000			
*** COST EFFECTIVENESS (\$/TON NO <sub>x</sub> REMOVED, 1992 DOLLARS) ***			\$1,331	\$1,613	\$2,129	\$3,226

COST EFFECTIVENESS OF RETROFIT NOx CONTROLS					
BOILER TYPE: PACKAGED WATERTUBE		CHAP. 6 REFERENCES		COST BASE	
BOILER CAPACITY (MMBtu/hr): 265		CIBO, 1992		1992 DOLLARS	
FUEL TYPE: NATURAL GAS					
CONTROL METHOD: LOW NOx BURNER WITH CEM SYSTEM					
TOTAL CAPITAL INVESTMENT COST (TCIC)					
		BOILER CAPACITY FACTOR			
		0.8	0.66	0.5	0.33
<b>A. DIRECT CAPITAL COST (DCC)</b>					
1. PURCHASED EQUIPMENT COST (PEC)					
PRIMARY AND AUXILIARY EQUIPMENT (EQP)	EQP				
CEM SYSTEM					
INSTRUMENTATION					
SALES TAX					
FREIGHT					
*** TOTAL PURCHASED EQUIPMENT COST ***	PEC	\$263,245	\$263,245	\$263,245	\$263,245
2. DIRECT INSTALLATION COST (DIC)					
*** TOTAL DIRECT INSTALLATION COST ***	DIC	\$78,973	\$78,973	\$78,973	\$78,973
(30 percent of purchased equipment)					
3. SITE PREP, SP (as required)	SP				
4. BUILDINGS, BLDG (as required)	BLDG				
*** TOTAL DIRECT CAPITAL COST ***	DCC	\$342,218	\$342,218	\$342,218	\$342,218
(PEC+DIC+SP+BLDG)					
<b>B. INDIRECT CAPITAL COST (ICC)</b>					
1. ENGINEERING (0.10PEC)		\$26,324	\$26,324	\$26,324	\$26,324
2. CONSTRUCTION AND FIELD EXPENSES (0.10PEC)		\$26,324	\$26,324	\$26,324	\$26,324
3. CONSTRUCTION FEE (0.10PEC)		\$26,324	\$26,324	\$26,324	\$26,324
4. STARTUP (0.02PEC)		\$5,265	\$5,265	\$5,265	\$5,265
5. PERFORMANCE TEST (0.01PEC)		\$2,632	\$2,632	\$2,632	\$2,632
*** TOTAL INDIRECT CAPITAL COST ***	ICC	\$86,871	\$86,871	\$86,871	\$86,871
<b>C. CONTINGENCY (20 percent of direct and indirect)</b>					
	CONT	\$85,818	\$85,818	\$85,818	\$85,818
*** TOTAL CAPITAL INVESTMENT COST ***	TCIC	\$514,907	\$514,907	\$514,907	\$514,907
(DCC+ICC+CONT)					

CONTINUED ON NEXT PAGE

COST EFFECTIVENESS OF RETROFIT NOx CONTROLS					
BOILER TYPE: PACKAGED WATERTUBE	CHAP. 6 REFERENCES	COST BASE			
BOILER CAPACITY (MMBtu/hr): 265	CIBO, 1992	1992 DOLLARS			
FUEL TYPE: NATURAL GAS					
CONTROL METHOD: LOW NOx BURNER WITH CEM SYSTEM					
<b>ANNUAL OPERATING AND MAINTENANCE COSTS (O&amp;M)</b>					
	CAPACITY FACTOR	0.8	0.66	0.5	0.33
<b>A. DIRECT ANNUAL COSTS (DAC)</b>					
1. OPERATING LABOR					
2. MAINTENANCE LABOR					
3. MAINTENANCE MATERIALS					
4. REPLACEMENT MATERIALS					
5. ELECTRICITY @ \$0.05/kW-hr					
6. STEAM					
7. FUEL					
8. WASTE DISPOSAL					
9. CHEMICALS					
10. OTHER					
*** TOTAL DIRECT ANNUAL COSTS ***	DAC	\$0	\$0	\$0	\$0
<b>B. INDIRECT ANNUAL COSTS (IAC)</b>					
1. OVERHEAD (60% OF SUM OF ALL LABOR AND MAINTENANCE MATERIALS)		\$0	\$0	\$0	\$0
2. ADMINISTRATIVE (0.02*TCIC)		\$10,298	\$10,298	\$10,298	\$10,298
3. PROPERTY TAX (0.01*TCIC)		\$5,149	\$5,149	\$5,149	\$5,149
4. INSURANCE (0.01*TCIC)		\$5,149	\$5,149	\$5,149	\$5,149
*** TOTAL INDIRECT ANNUAL COSTS ***	IAC	\$20,596	\$20,596	\$20,596	\$20,596
*** TOTAL ANNUAL OPERATING AND MAINTENANCE COSTS *** (DAC+IAC)	O&M	\$20,596	\$20,596	\$20,596	\$20,596
<b>COST EFFECTIVENESS</b>					
<b>A. TOTAL ANNUALIZED COST (incl. capital and O&amp;M)</b>					
1. ANNUALIZED CAPITAL INVESTMENT COST (ACIC)					
EXPECTED LIFETIME OF EQUIPMENT, YEARS		10	10	10	10
INTEREST RATE		0.1	0.1	0.1	0.1
CAPITAL RECOVERY FACTOR		0.1627	0.1627	0.1627	0.1627
TOTAL CAPITAL INVESTMENT COSTS (TCIC, above)		\$514,907	\$514,907	\$514,907	\$514,907
*** ANNUALIZED CAPITAL INVESTMENT COST ***	ACIC	\$83,799	\$83,799	\$83,799	\$83,799
2. ANNUAL O&M COSTS (O&M, above)	O&M	\$20,596	\$20,596	\$20,596	\$20,596
*** TOTAL ANNUALIZED COST ***	ACIC+O&M	\$104,395	\$104,395	\$104,395	\$104,395
<b>B. NOx REMOVAL PER YEAR</b>					
1. BASELINE NOx LEVEL (lb/MMBtu)	(NOx)1	0.24	0.24	0.24	0.24
2. CONTROLLED NOx LEVEL (lb/MMBtu)	(NOx)2	0.12	0.12	0.12	0.12
3. NOx REMOVAL EFFICIENCY (%)		50	50	50	50
4. CAPACITY FACTOR	CF	0.8	0.66	0.5	0.33
5. BOILER HEAT INPUT CAPACITY (MMBtu/hr)	CAP	265	265	265	265
*** NOx REMOVED PER YEAR (TONS/YR) *** [CAP*CF*(24 hr/day)*(365 days/yr)]*[(NOx)1-(NOx)2]/2000		111.4	91.9	69.6	46.0
*** COST EFFECTIVENESS (\$/TON NOx REMOVED, 1992 DOLLARS) ***		\$937	\$1,136	\$1,499	\$2,271

COST EFFECTIVENESS OF RETROFIT NOx CONTROLS					
BOILER TYPE: PACKAGED WATERTUBE	CHAP. 6 REFERENCES	COST BASE			
BOILER CAPACITY (MMBtu/hr): 17.7	CIBO, 1992	1992 DOLLARS			
FUEL TYPE: NATURAL GAS					
CONTROL METHOD: LNB AND FGR					
TOTAL CAPITAL INVESTMENT COST (TCIC)					
		BOILER CAPACITY FACTOR			
		0.8	0.66	0.5	0.33
<b>A. DIRECT CAPITAL COST (DCC)</b>					
1. PURCHASED EQUIPMENT COST (PEC)					
PRIMARY AND AUXILIARY EQUIPMENT (EQP)	EQP				
CEM SYSTEM					
INSTRUMENTATION					
SALES TAX					
FREIGHT					
*** TOTAL PURCHASED EQUIPMENT COST ***	PEC	\$28,017	\$28,017	\$28,017	\$28,017
2. DIRECT INSTALLATION COST (DIC)					
*** TOTAL DIRECT INSTALLATION COST ***	DIC	\$8,405	\$8,405	\$8,405	\$8,405
(30 percent of purchased equipment)					
3. SITE PREP, SP (as required)	SP				
4. BUILDINGS, BLDG (as required)	BLDG				
*** TOTAL DIRECT CAPITAL COST ***	DCC	\$36,421	\$36,421	\$36,421	\$36,421
(PEC+DIC+SP+BLDG)					
<b>B. INDIRECT CAPITAL COST (ICC)</b>					
1. ENGINEERING (0.10PEC)		\$2,802	\$2,802	\$2,802	\$2,802
2. CONSTRUCTION AND FIELD EXPENSES (0.10PEC)		\$2,802	\$2,802	\$2,802	\$2,802
3. CONSTRUCTION FEE (0.10PEC)		\$2,802	\$2,802	\$2,802	\$2,802
4. STARTUP (0.02PEC)		\$560	\$560	\$560	\$560
5. PERFORMANCE TEST (0.01PEC)		\$280	\$280	\$280	\$280
*** TOTAL INDIRECT CAPITAL COST ***	ICC	\$9,245	\$9,245	\$9,245	\$9,245
<b>C. CONTINGENCY (20 percent of direct and indirect)</b>					
	CONT	\$9,133	\$9,133	\$9,133	\$9,133
*** TOTAL CAPITAL INVESTMENT COST ***	TCIC	\$54,800	\$54,800	\$54,800	\$54,800
(DCC+ICC+CONT)					

CONTINUED ON NEXT PAGE

COST EFFECTIVENESS OF RETROFIT NO <sub>x</sub> CONTROLS					
BOILER TYPE:	PACKAGED WATERTUBE	CHAP. 6 REFERENCES	COST BASE		
BOILER CAPACITY (MMBtu/hr):	17.7	CIBO, 1992	1992 DOLLARS		
FUEL TYPE:	NATURAL GAS				
CONTROL METHOD:	LNB AND FGR				
<b>ANNUAL OPERATING AND MAINTENANCE COSTS (O&amp;M)</b>					
	CAPACITY FACTOR	0.8	0.66	0.5	0.33
<b>A. DIRECT ANNUAL COSTS (DAC)</b>					
1. OPERATING LABOR					
2. MAINTENANCE LABOR					
3. MAINTENANCE MATERIALS		\$500	\$500	\$500	\$500
4. REPLACEMENT MATERIALS		\$500	\$500	\$500	\$500
5. ELECTRICITY @ \$0.05/kW-hr		\$2,313	\$1,909	\$1,446	\$954
6. STEAM					
7. FUEL					
8. WASTE DISPOSAL					
9. CHEMICALS					
10. OTHER: 1% FUEL SAVINGS, N. GAS @ \$3.63/MMBtu		(\$4,503)	(\$3,715)	(\$2,814)	(\$1,857)
*** TOTAL DIRECT ANNUAL COSTS ***	DAC	(\$1,189)	(\$806)	(\$368)	\$97
<b>B. INDIRECT ANNUAL COSTS (IAC)</b>					
1. OVERHEAD (60% OF SUM OF ALL LABOR AND MAINTENANCE MATERIALS)		\$300	\$300	\$300	\$300
2. ADMINISTRATIVE (0.02*TCIC)		\$1,096	\$1,096	\$1,096	\$1,096
3. PROPERTY TAX (0.01*TCIC)		\$548	\$548	\$548	\$548
4. INSURANCE (0.01*TCIC)		\$548	\$548	\$548	\$548
*** TOTAL INDIRECT ANNUAL COSTS ***	IAC	\$2,492	\$2,492	\$2,492	\$2,492
*** TOTAL ANNUAL OPERATING AND MAINTENANCE COSTS *** (DAC+IAC)	O&M	\$1,303	\$1,686	\$2,124	\$2,589
<b>COST EFFECTIVENESS</b>					
<b>A. TOTAL ANNUALIZED COST (incl. capital and O&amp;M)</b>					
1. ANNUALIZED CAPITAL INVESTMENT COST (ACIC)					
EXPECTED LIFETIME OF EQUIPMENT, YEARS		10	10	10	10
INTEREST RATE		0.1	0.1	0.1	0.1
CAPITAL RECOVERY FACTOR		0.1627	0.1627	0.1627	0.1627
TOTAL CAPITAL INVESTMENT COSTS (TCIC, above)		\$54,800	\$54,800	\$54,800	\$54,800
*** ANNUALIZED CAPITAL INVESTMENT COST ***	ACIC	\$8,919	\$8,919	\$8,919	\$8,919
2. ANNUAL O&M COSTS (O&M, above)	O&M	\$1,303	\$1,686	\$2,124	\$2,589
*** TOTAL ANNUALIZED COST ***	ACIC+O&M	\$10,221	\$10,604	\$11,042	\$11,507
<b>B. NO<sub>x</sub> REMOVAL PER YEAR</b>					
1. BASELINE NO <sub>x</sub> LEVEL (lb/MMBtu)	(NO <sub>x</sub> )1	0.16	0.16	0.16	0.16
2. CONTROLLED NO <sub>x</sub> LEVEL (lb/MMBtu)	(NO <sub>x</sub> )2	0.06	0.06	0.06	0.06
3. NO <sub>x</sub> REMOVAL EFFICIENCY (%)		60	60	60	60
4. CAPACITY FACTOR	CF	0.8	0.66	0.5	0.33
5. BOILER HEAT INPUT CAPACITY (MMBtu/hr)	CAP	17.7	17.7	17.7	17.7
*** NO <sub>x</sub> REMOVED PER YEAR (TONS/YR) ***					
[CAP*CF*(24 hr/day)*(365 days/yr)]*[(NO <sub>x</sub> )1-(NO <sub>x</sub> )2]/2000		6.0	4.9	3.7	2.5
*** COST EFFECTIVENESS (\$/TON NO <sub>x</sub> REMOVED, 1992 DOLLARS) ***		\$1,717	\$2,159	\$2,967	\$4,685



COST EFFECTIVENESS OF RETROFIT NOx CONTROLS					
BOILER TYPE: PACKAGED WATERTUBE		CHAP. 6 REFERENCES		COST BASE	
BOILER CAPACITY (MMBtu/hr): 41.3		IMPELL CORP., 1989		1992 DOLLARS	
FUEL TYPE: NATURAL GAS					
CONTROL METHOD: LNB AND FGR					
TOTAL CAPITAL INVESTMENT COST (TCIC)					
		BOILER CAPACITY FACTOR			
		0.8	0.66	0.5	0.33
A. DIRECT CAPITAL COST (DCC)					
1. PURCHASED EQUIPMENT COST (PEC)	EQP				
PRIMARY AND AUXILIARY EQUIPMENT (EQP)					
CEM SYSTEM					
INSTRUMENTATION					
SALES TAX					
FREIGHT					
*** TOTAL PURCHASED EQUIPMENT COST ***	PEC	\$95,751	\$95,751	\$95,751	\$95,751
2. DIRECT INSTALLATION COST (DIC)					
*** TOTAL DIRECT INSTALLATION COST ***	DIC	\$50,394	\$50,394	\$50,394	\$50,394
3. SITE PREP. SP (as required)	SP				
4. BUILDINGS, BLDG (as required)	BLDG				
*** TOTAL DIRECT CAPITAL COST *** (PEC+DIC+SP+BLDG)	DCC	\$146,145	\$146,145	\$146,145	\$146,145
B. INDIRECT CAPITAL COST (ICC)					
1. ENGINEERING					
2. CONSTRUCTION AND FIELD EXPENSES					
3. CONSTRUCTION FEE					
4. STARTUP					
5. PERFORMANCE TEST					
*** TOTAL INDIRECT CAPITAL COST ***	ICC	\$26,203	\$26,203	\$26,203	\$26,203
C. CONTINGENCY	CONT	\$36,286	\$36,286	\$36,286	\$36,286
*** TOTAL CAPITAL INVESTMENT COST *** (DCC+ICC+CONT)	TCIC	\$208,634	\$208,634	\$208,634	\$208,634

CONTINUED ON NEXT PAGE

COST EFFECTIVENESS OF RETROFIT NO <sub>x</sub> CONTROLS						
BOILER TYPE: PACKAGED WATERTUBE		CHAP. 6 REFERENCES		COST BASE		
BOILER CAPACITY (MMBtu/hr): 41.3		IMPELL CORP., 1989		1992 DOLLARS		
FUEL TYPE: NATURAL GAS						
CONTROL METHOD: LNB AND FGR						
ANNUAL OPERATING AND MAINTENANCE COSTS (O&M)						
		CAPACITY FACTOR	0.8	0.66	0.5	0.33
<b>A. DIRECT ANNUAL COSTS (DAC)</b>						
1.	OPERATING LABOR					
2.	MAINTENANCE LABOR					
3.	MAINTENANCE MATERIALS		\$500	\$500	\$500	\$500
4.	REPLACEMENT MATERIALS		\$500	\$500	\$500	\$500
5.	ELECTRICITY @ \$0.05/kW-hr		\$5,228	\$4,313	\$3,267	\$2,157
6.	STEAM					
7.	FUEL					
8.	WASTE DISPOSAL					
9.	CHEMICALS					
10.	OTHER: 1% FUEL SAVINGS, N. GAS @ \$3.63/MMBtu		(\$10,506)	(\$8,668)	(\$6,566)	(\$4,334)
*** TOTAL DIRECT ANNUAL COSTS ***		DAC	(\$4,278)	(\$3,355)	(\$2,299)	(\$1,177)
<b>B. INDIRECT ANNUAL COSTS (IAC)</b>						
1.	OVERHEAD (60% OF SUM OF ALL LABOR AND MAINTENANCE MATERIALS)		\$300	\$300	\$300	\$300
2.	ADMINISTRATIVE (0.02*TCIC)		\$4,173	\$4,173	\$4,173	\$4,173
3.	PROPERTY TAX (0.01*TCIC)		\$2,086	\$2,086	\$2,086	\$2,086
4.	INSURANCE (0.01*TCIC)		\$2,086	\$2,086	\$2,086	\$2,086
*** TOTAL INDIRECT ANNUAL COSTS ***		IAC	\$8,645	\$8,645	\$8,645	\$8,645
*** TOTAL ANNUAL OPERATING AND MAINTENANCE COSTS *** (DAC+IAC)		O&M	\$4,367	\$5,291	\$6,346	\$7,468
COST EFFECTIVENESS						
<b>A. TOTAL ANNUALIZED COST (incl. capital and O&amp;M)</b>						
1.	ANNUALIZED CAPITAL INVESTMENT COST (ACIC)					
EXPECTED LIFETIME OF EQUIPMENT, YEARS			10	10	10	10
INTEREST RATE			0.1	0.1	0.1	0.1
CAPITAL RECOVERY FACTOR			0.1627	0.1627	0.1627	0.1627
TOTAL CAPITAL INVESTMENT COSTS (TCIC, above)			\$208,634	\$208,634	\$208,634	\$208,634
*** ANNUALIZED CAPITAL INVESTMENT COST ***		ACIC	\$33,954	\$33,954	\$33,954	\$33,954
2.	ANNUAL O&M COSTS (O&M, above)	O&M	\$4,367	\$5,291	\$6,346	\$7,468
*** TOTAL ANNUALIZED COST ***		ACIC+O&M	\$38,321	\$39,245	\$40,301	\$41,422
<b>B. NO<sub>x</sub> REMOVAL PER YEAR</b>						
1.	BASELINE NO <sub>x</sub> LEVEL (lb/MMBtu)	(NO <sub>x</sub> )1	0.16	0.16	0.16	0.16
2.	CONTROLLED NO <sub>x</sub> LEVEL (lb/MMBtu)	(NO <sub>x</sub> )2	0.06	0.06	0.06	0.06
3.	NO <sub>x</sub> REMOVAL EFFICIENCY (%)		60	60	60	60
4.	CAPACITY FACTOR	CF	0.8	0.66	0.5	0.33
5.	BOILER HEAT INPUT CAPACITY (MMBtu/hr)	CAP	41.3	41.3	41.3	41.3
*** NO <sub>x</sub> REMOVED PER YEAR (TONS/YR) ***						
[CAP*CF*(24 hr/day)*(365 days/yr)]*[(NO <sub>x</sub> )1-(NO <sub>x</sub> )2]/2000			13.9	11.5	8.7	5.7
*** COST EFFECTIVENESS (\$/TON NO <sub>x</sub> REMOVED, 1992 DOLLARS) ***			\$2,758	\$3,424	\$4,641	\$7,228

**COST EFFECTIVENESS OF RETROFIT NOx CONTROLS**

BOILER TYPE: PACKAGED WATERTUBE	CHAP. 6 REFERENCES	COST BASE
BOILER CAPACITY (MMBtu/hr): 45	CAL ARB, 1987	1992 DOLLARS
FUEL TYPE: NATURAL GAS		
CONTROL METHOD: LNB AND FGR		

**TOTAL CAPITAL INVESTMENT COST (TCIC)**

		BOILER CAPACITY FACTOR			
		0.8	0.66	0.5	0.33
<b>A. DIRECT CAPITAL COST (DCC)</b>					
1. PURCHASED EQUIPMENT COST (PEC)					
PRIMARY AND AUXILIARY EQUIPMENT (EQP)	EQP				
CEM SYSTEM					
INSTRUMENTATION					
SALES TAX					
FREIGHT					
*** TOTAL PURCHASED EQUIPMENT COST ***	PEC	\$48,381	\$48,381	\$48,381	\$48,381
2. DIRECT INSTALLATION COST (DIC)					
*** TOTAL DIRECT INSTALLATION COST ***	DIC	\$57,403	\$57,403	\$57,403	\$57,403
3. SITE PREP, SP (as required)	SP				
4. BUILDINGS, BLDG (as required)	BLDG				
*** TOTAL DIRECT CAPITAL COST *** (PEC+DIC+SP+BLDG)	DCC	\$105,785	\$105,785	\$105,785	\$105,785
<b>B. INDIRECT CAPITAL COST (ICC)</b>					
1. ENGINEERING					
2. CONSTRUCTION AND FIELD EXPENSES					
3. CONSTRUCTION FEE					
4. STARTUP					
5. PERFORMANCE TEST					
*** TOTAL INDIRECT CAPITAL COST ***	ICC	\$35,989	\$35,989	\$35,989	\$35,989
<b>C. CONTINGENCY</b>					
*** TOTAL CAPITAL INVESTMENT COST *** (DCC+ICC+CONT)	TCIC	\$141,773	\$141,773	\$141,773	\$141,773

CONTINUED ON NEXT PAGE

COST EFFECTIVENESS OF RETROFIT NO <sub>x</sub> CONTROLS					
BOILER TYPE: PACKAGED WATERTUBE	CHAP. 6 REFERENCES	COST BASE			
BOILER CAPACITY (MMBtu/hr): 45	CAL ARB. 1987	1992 DOLLARS			
FUEL TYPE: NATURAL GAS					
CONTROL METHOD: LNB AND FGR					
<b>ANNUAL OPERATING AND MAINTENANCE COSTS (O&amp;M)</b>					
	CAPACITY FACTOR	0.8	0.66	0.5	0.33
<b>A. DIRECT ANNUAL COSTS (DAC)</b>					
1. OPERATING LABOR					
2. MAINTENANCE LABOR		\$500	\$500	\$500	\$500
3. MAINTENANCE MATERIALS		\$500	\$500	\$500	\$500
4. REPLACEMENT MATERIALS					
5. ELECTRICITY @ \$0.05/kw-hr		\$5,881	\$4,852	\$3,676	\$2,426
6. STEAM					
7. FUEL					
8. WASTE DISPOSAL					
9. CHEMICALS					
10. OTHER: 1% FUEL SAVINGS, N. GAS @ \$3.63/MMBtu		(\$11,448)	(\$9,444)	(\$7,155)	(\$4,722)
*** TOTAL DIRECT ANNUAL COSTS ***	DAC	(\$4,566)	(\$3,592)	(\$2,479)	(\$1,296)
<b>B. INDIRECT ANNUAL COSTS (IAC)</b>					
1. OVERHEAD (60% OF SUM OF ALL LABOR AND MAINTENANCE MATERIALS)		\$600	\$600	\$600	\$600
2. ADMINISTRATIVE (0.02*TCIC)		\$2,835	\$2,835	\$2,835	\$2,835
3. PROPERTY TAX (0.01*TCIC)		\$1,418	\$1,418	\$1,418	\$1,418
4. INSURANCE (0.01*TCIC)		\$1,418	\$1,418	\$1,418	\$1,418
*** TOTAL INDIRECT ANNUAL COSTS ***	IAC	\$6,271	\$6,271	\$6,271	\$6,271
*** TOTAL ANNUAL OPERATING AND MAINTENANCE COSTS *** (DAC+IAC)	O&M	\$1,705	\$2,679	\$3,792	\$4,975
<b>COST EFFECTIVENESS</b>					
<b>A. TOTAL ANNUALIZED COST (incl. capital and O&amp;M)</b>					
1. ANNUALIZED CAPITAL INVESTMENT COST (ACIC)					
EXPECTED LIFETIME OF EQUIPMENT, YEARS		10	10	10	10
INTEREST RATE		0.1	0.1	0.1	0.1
CAPITAL RECOVERY FACTOR		0.1627	0.1627	0.1627	0.1627
TOTAL CAPITAL INVESTMENT COSTS (TCIC, above)		\$141,773	\$141,773	\$141,773	\$141,773
*** ANNUALIZED CAPITAL INVESTMENT COST ***	ACIC	\$23,073	\$23,073	\$23,073	\$23,073
2. ANNUAL O&M COSTS (O&M, above)	O&M	\$1,705	\$2,679	\$3,792	\$4,975
*** TOTAL ANNUALIZED COST ***	ACIC+O&M	\$24,778	\$25,752	\$26,865	\$28,048
<b>B. NO<sub>x</sub> REMOVAL PER YEAR</b>					
1. BASELINE NO <sub>x</sub> LEVEL (lb/MMBtu)	(NO <sub>x</sub> )1	0.16	0.16	0.16	0.16
2. CONTROLLED NO <sub>x</sub> LEVEL (lb/MMBtu)	(NO <sub>x</sub> )2	0.06	0.06	0.06	0.06
3. NO <sub>x</sub> REMOVAL EFFICIENCY (%)		60	60	60	60
4. CAPACITY FACTOR	CF	0.8	0.66	0.5	0.33
5. BOILER HEAT INPUT CAPACITY (MMBtu/hr)	CAP	45	45	45	45
*** NO <sub>x</sub> REMOVED PER YEAR (TONS/YR) ***					
[CAP*CF*(24 hr/day)*(365 days/yr)]*[(NO <sub>x</sub> )1-(NO <sub>x</sub> )2]/2000		15.1	12.5	9.5	6.2
*** COST EFFECTIVENESS (\$/TON NO <sub>x</sub> REMOVED, 1992 DOLLARS) ***		\$1,637	\$2,062	\$2,840	\$4,492

COST EFFECTIVENESS OF RETROFIT NOx CONTROLS					
BOILER TYPE: PACKAGED WATERTUBE		CHAP. 6 REFERENCES		COST BASE	
BOILER CAPACITY (MMBtu/hr): 55		CAL ARB. 1987		1992 DOLLARS	
FUEL TYPE: NATURAL GAS					
CONTROL METHOD: LNB AND FGR					
TOTAL CAPITAL INVESTMENT COST (TCIC)					
		BOILER CAPACITY FACTOR			
		0.8	0.66	0.5	0.33
<b>A. DIRECT CAPITAL COST (DCC)</b>					
1. PURCHASED EQUIPMENT COST (PEC)					
PRIMARY AND AUXILIARY EQUIPMENT (EQP)		EQP			
CEM SYSTEM					
INSTRUMENTATION					
SALES TAX					
FREIGHT					
*** TOTAL PURCHASED EQUIPMENT COST ***		PEC	\$84,370	\$84,370	\$84,370
2. DIRECT INSTALLATION COST (DIC)					
*** TOTAL DIRECT INSTALLATION COST ***		DIC	\$122,639	\$122,639	\$122,639
3. SITE PREP, SP (as required)		SP			
4. BUILDINGS, BLDG (as required)		BLDG			
*** TOTAL DIRECT CAPITAL COST *** (PEC+DIC+SP+BLDG)		DCC	\$207,008	\$207,008	\$207,008
<b>B. INDIRECT CAPITAL COST (ICC)</b>					
1. ENGINEERING					
2. CONSTRUCTION AND FIELD EXPENSES					
3. CONSTRUCTION FEE					
4. STARTUP					
5. PERFORMANCE TEST					
*** TOTAL INDIRECT CAPITAL COST ***		ICC	\$40,500	\$40,500	\$40,500
<b>C. CONTINGENCY</b>		CONT			
*** TOTAL CAPITAL INVESTMENT COST *** (DCC+ICC+CONT)		TCIC	\$247,508	\$247,508	\$247,508

CONTINUED ON NEXT PAGE

COST EFFECTIVENESS OF RETROFIT NO <sub>x</sub> CONTROLS					
BOILER TYPE: PACKAGED WATERTUBE	CHAP. 6 REFERENCES	COST BASE			
BOILER CAPACITY (MMBtu/hr): 55	CAL ARB, 1987	1992 DOLLARS			
FUEL TYPE: NATURAL GAS					
CONTROL METHOD: LNB AND FGR					
ANNUAL OPERATING AND MAINTENANCE COSTS (O&M)					
	CAPACITY FACTOR	0.8	0.66	0.5	0.33
A. DIRECT ANNUAL COSTS (DAC)					
1. OPERATING LABOR					
2. MAINTENANCE LABOR		\$500	\$500	\$500	\$500
3. MAINTENANCE MATERIALS		\$500	\$500	\$500	\$500
4. REPLACEMENT MATERIALS					
5. ELECTRICITY @ \$0.05/kw-hr		\$7,188	\$5,930	\$4,493	\$2,965
6. STEAM					
7. FUEL					
8. WASTE DISPOSAL					
9. CHEMICALS					
10. OTHER: 1% FUEL SAVINGS, N. GAS @ \$3.63/MMBtu		(\$13,991)	(\$11,543)	(\$8,745)	(\$5,771)
*** TOTAL DIRECT ANNUAL COSTS ***	DAC	(\$5,803)	(\$4,612)	(\$3,252)	(\$1,806)
B. INDIRECT ANNUAL COSTS (IAC)					
1. OVERHEAD (60% OF SUM OF ALL LABOR AND MAINTENANCE MATERIALS)		\$600	\$600	\$600	\$600
2. ADMINISTRATIVE (0.02*TCIC)		\$4,950	\$4,950	\$4,950	\$4,950
3. PROPERTY TAX (0.01*TCIC)		\$2,475	\$2,475	\$2,475	\$2,475
4. INSURANCE (0.01*TCIC)		\$2,475	\$2,475	\$2,475	\$2,475
*** TOTAL INDIRECT ANNUAL COSTS ***	IAC	\$10,500	\$10,500	\$10,500	\$10,500
*** TOTAL ANNUAL OPERATING AND MAINTENANCE COSTS *** (DAC+IAC)	O&M	\$4,697	\$5,888	\$7,248	\$8,694
COST EFFECTIVENESS					
A. TOTAL ANNUALIZED COST (incl. capital and O&M)					
1. ANNUALIZED CAPITAL INVESTMENT COST (ACIC)					
EXPECTED LIFETIME OF EQUIPMENT, YEARS		10	10	10	10
INTEREST RATE		0.1	0.1	0.1	0.1
CAPITAL RECOVERY FACTOR		0.1627	0.1627	0.1627	0.1627
TOTAL CAPITAL INVESTMENT COSTS (TCIC, above)		\$247,508	\$247,508	\$247,508	\$247,508
*** ANNUALIZED CAPITAL INVESTMENT COST ***	ACIC	\$40,281	\$40,281	\$40,281	\$40,281
2. ANNUAL O&M COSTS (O&M, above)	O&M	\$4,697	\$5,888	\$7,248	\$8,694
*** TOTAL ANNUALIZED COST ***	ACIC+O&M	\$44,978	\$46,169	\$47,529	\$48,975
B. NO <sub>x</sub> REMOVAL PER YEAR					
1. BASELINE NO <sub>x</sub> LEVEL (lb/MMBtu)	(NO <sub>x</sub> )1	0.16	0.16	0.16	0.16
2. CONTROLLED NO <sub>x</sub> LEVEL (lb/MMBtu)	(NO <sub>x</sub> )2	0.06	0.06	0.06	0.06
3. NO <sub>x</sub> REMOVAL EFFICIENCY (%)		60	60	60	60
4. CAPACITY FACTOR	CF	0.8	0.66	0.5	0.33
5. BOILER HEAT INPUT CAPACITY (MMBtu/hr)	CAP	55	55	55	55
*** NO <sub>x</sub> REMOVED PER YEAR (TONS/YR) ***					
[CAP*CF*(24 hr/day)*(365 days/yr)]*[(NO <sub>x</sub> )1-(NO <sub>x</sub> )2]/2000		18.5	15.3	11.6	7.6
*** COST EFFECTIVENESS (\$/TON NO <sub>x</sub> REMOVED, 1992 DOLLARS) ***		\$2,431	\$3,025	\$4,110	\$6,417

COST EFFECTIVENESS OF RETROFIT NOx CONTROLS					
BOILER TYPE: PACKAGED WATERTUBE		CHAP. 6 REFERENCES		COST BASE	
BOILER CAPACITY (MMBtu/hr): 265		CIBO, 1992		1992 DOLLARS	
FUEL TYPE: NATURAL GAS					
CONTROL METHOD: LNB AND FGR					
TOTAL CAPITAL INVESTMENT COST (TCIC)					
		BOILER CAPACITY FACTOR			
		0.8	0.66	0.5	0.33
<b>A. DIRECT CAPITAL COST (DCC)</b>					
1. PURCHASED EQUIPMENT COST (PEC)					
PRIMARY AND AUXILIARY EQUIPMENT (EQP)		EQP			
CEM SYSTEM					
INSTRUMENTATION					
SALES TAX					
FREIGHT					
*** TOTAL PURCHASED EQUIPMENT COST ***		PEC	\$236,321	\$236,321	\$236,321
2. DIRECT INSTALLATION COST (DIC)					
*** TOTAL DIRECT INSTALLATION COST ***		DIC	\$70,896	\$70,896	\$70,896
(30 percent of purchased equipment)					
3. SITE PREP, SP (as required)		SP			
4. BUILDINGS, BLDG (as required)		BLDG			
*** TOTAL DIRECT CAPITAL COST ***		DCC	\$307,217	\$307,217	\$307,217
(PEC+DIC+SP+BLDG)					
<b>B. INDIRECT CAPITAL COST (ICC)</b>					
1. ENGINEERING (0.10PEC)			\$23,632	\$23,632	\$23,632
2. CONSTRUCTION AND FIELD EXPENSES (0.10PEC)			\$23,632	\$23,632	\$23,632
3. CONSTRUCTION FEE (0.10PEC)			\$23,632	\$23,632	\$23,632
4. STARTUP (0.02PEC)			\$4,726	\$4,726	\$4,726
5. PERFORMANCE TEST (0.01PEC)			\$2,363	\$2,363	\$2,363
*** TOTAL INDIRECT CAPITAL COST ***		ICC	\$77,986	\$77,986	\$77,986
<b>C. CONTINGENCY (20 percent of direct and indirect)</b>		CONT	\$77,041	\$77,041	\$77,041
*** TOTAL CAPITAL INVESTMENT COST ***		TCIC	\$462,244	\$462,244	\$462,244
(DCC+ICC+CONT)					

CONTINUED ON NEXT PAGE

COST EFFECTIVENESS OF RETROFIT NO <sub>x</sub> CONTROLS						
BOILER TYPE: PACKAGED WATERTUBE		CHAP. 6 REFERENCES		COST BASE		
BOILER CAPACITY (MMBtu/hr): 265		CIBO, 1992		1992 DOLLARS		
FUEL TYPE: NATURAL GAS						
CONTROL METHOD: LNB AND FGR						
ANNUAL OPERATING AND MAINTENANCE COSTS (O&M)						
	CAPACITY	0.8	0.66	0.5	0.33	
<b>A. DIRECT ANNUAL COSTS (DAC)</b>						
1.	OPERATING LABOR					
2.	MAINTENANCE LABOR					
3.	MAINTENANCE MATERIALS	\$500	\$500	\$500	\$500	
4.	REPLACEMENT MATERIALS	\$500	\$500	\$500	\$500	
5.	ELECTRICITY @ \$0.05/kW-hr	\$34,635	\$28,574	\$21,647	\$14,287	
6.	STEAM					
7.	FUEL					
8.	WASTE DISPOSAL					
9.	CHEMICALS					
10.	OTHER: 1% FUEL SAVINGS, N. GAS @ \$3.63/MMBtu	(\$67,413)	(\$55,616)	(\$42,133)	(\$27,808)	
***	TOTAL DIRECT ANNUAL COSTS ***	DAC	(\$31,778)	(\$26,042)	(\$19,486)	(\$12,521)
<b>B. INDIRECT ANNUAL COSTS (IAC)</b>						
1.	OVERHEAD (60% OF SUM OF ALL LABOR AND MAINTENANCE MATERIALS)	\$300	\$300	\$300	\$300	
2.	ADMINISTRATIVE (0.02*TCIC)	\$9,245	\$9,245	\$9,245	\$9,245	
3.	PROPERTY TAX (0.01*TCIC)	\$4,622	\$4,622	\$4,622	\$4,622	
4.	INSURANCE (0.01*TCIC)	\$4,622	\$4,622	\$4,622	\$4,622	
***	TOTAL INDIRECT ANNUAL COSTS ***	IAC	\$18,790	\$18,790	\$18,790	\$18,790
***	TOTAL ANNUAL OPERATING AND MAINTENANCE COSTS (DAC+IAC)	O&M	(\$12,988)	(\$7,252)	(\$697)	\$6,269
COST EFFECTIVENESS						
<b>A. TOTAL ANNUALIZED COST (incl. capital and O&amp;M)</b>						
1. ANNUALIZED CAPITAL INVESTMENT COST (ACIC)						
	EXPECTED LIFETIME OF EQUIPMENT, YEARS	10	10	10	10	
	INTEREST RATE	0.1	0.1	0.1	0.1	
	CAPITAL RECOVERY FACTOR	0.1627	0.1627	0.1627	0.1627	
	TOTAL CAPITAL INVESTMENT COSTS (TCIC, above)	\$462,244	\$462,244	\$462,244	\$462,244	
***	ANNUALIZED CAPITAL INVESTMENT COST ***	ACIC	\$75,228	\$75,228	\$75,228	\$75,228
2.	ANNUAL O&M COSTS (O&M, above)	O&M	(\$12,988)	(\$7,252)	(\$697)	\$6,269
***	TOTAL ANNUALIZED COST ***	ACIC+O&M	\$62,240	\$67,976	\$74,531	\$81,497
<b>B. NO<sub>x</sub> REMOVAL PER YEAR</b>						
1.	BASELINE NO <sub>x</sub> LEVEL (lb/MMBtu)	(NO <sub>x</sub> )1	0.24	0.24	0.24	0.24
2.	CONTROLLED NO <sub>x</sub> LEVEL (lb/MMBtu)	(NO <sub>x</sub> )2	0.10	0.10	0.10	0.10
3.	NO <sub>x</sub> REMOVAL EFFICIENCY (%)		60	60	60	60
4.	CAPACITY FACTOR	CF	0.8	0.66	0.5	0.33
5.	BOILER HEAT INPUT CAPACITY (MMBtu/hr)	CAP	265	265	265	265
***	NO <sub>x</sub> REMOVED PER YEAR (TONS/YR) ***		133.7	110.3	83.6	55.2
	[CAP*CF*(24 hr/day)*(365 days/yr)]*[(NO <sub>x</sub> )1-(NO <sub>x</sub> )2]/2000					
***	COST EFFECTIVENESS (\$/TON NO <sub>x</sub> REMOVED, 1992 DOLLARS) ***		\$465	\$616	\$892	\$1,478



COST EFFECTIVENESS OF RETROFIT NOx CONTROLS						
BOILER TYPE: PACKAGED WATERTUBE		CHAP. 6 REFERENCES		COST BASE		
BOILER CAPACITY (MMBtu/hr): 81.3		IMPELL CORP., 1989		1992 DOLLARS		
FUEL TYPE: NATURAL GAS						
CONTROL METHOD: LNB AND FGR WITH CEM SYSTEM						
TOTAL CAPITAL INVESTMENT COST (TCIC)						
		BOILER CAPACITY FACTOR				
		0.8	0.66	0.5	0.33	
A. DIRECT CAPITAL COST (DCC)						
1. PURCHASED EQUIPMENT COST (PEC)						
PRIMARY AND AUXILIARY EQUIPMENT (EQP)		EQP				
CEM SYSTEM						
INSTRUMENTATION						
SALES TAX						
FREIGHT						
*** TOTAL PURCHASED EQUIPMENT COST ***		PEC	\$215,634	\$215,634	\$215,634	\$215,634
2. DIRECT INSTALLATION COST (DIC)						
*** TOTAL DIRECT INSTALLATION COST ***		DIC	\$68,507	\$68,507	\$68,507	\$68,507
3. SITE PREP, SP (as required)		SP				
4. BUILDINGS, BLDG (as required)		BLDG				
*** TOTAL DIRECT CAPITAL COST *** (PEC+DIC+SP+BLDG)		DCC	\$284,141	\$284,141	\$284,141	\$284,141
B. INDIRECT CAPITAL COST (ICC)						
1. ENGINEERING						
2. CONSTRUCTION AND FIELD EXPENSES						
3. CONSTRUCTION FEE						
4. STARTUP						
5. PERFORMANCE TEST						
*** TOTAL INDIRECT CAPITAL COST ***		ICC	\$33,213	\$33,213	\$33,213	\$33,213
C. CONTINGENCY		CONT				
*** TOTAL CAPITAL INVESTMENT COST *** (DCC+ICC+CONT)		TCIC	\$379,813	\$379,813	\$379,813	\$379,813

CONTINUED ON NEXT PAGE

COST EFFECTIVENESS OF RETROFIT NO <sub>x</sub> CONTROLS						
BOILER TYPE: PACKAGED WATERTUBE		CHAP. 6 REFERENCES		COST BASE		
BOILER CAPACITY (MMBtu/hr): 81.3		IMPELL CORP., 1989		1992 DOLLARS		
FUEL TYPE: NATURAL GAS						
CONTROL METHOD: LNB AND FGR WITH CEM SYSTEM						
ANNUAL OPERATING AND MAINTENANCE COSTS (O&M)						
		CAPACITY FACTOR	0.8	0.66	0.5	0.33
<b>A. DIRECT ANNUAL COSTS (DAC)</b>						
1.	OPERATING LABOR					
2.	MAINTENANCE LABOR					
3.	MAINTENANCE MATERIALS		\$500	\$500	\$500	\$500
4.	REPLACEMENT MATERIALS		\$500	\$500	\$500	\$500
5.	ELECTRICITY @ \$0.05/kW-hr		\$10,456	\$8,626	\$6,535	\$4,313
6.	STEAM					
7.	FUEL					
8.	WASTE DISPOSAL					
9.	CHEMICALS					
10.	OTHER: 1% FUEL SAVINGS, N. GAS @ \$3.63/MMBtu D=4.83 R=2.35		(\$20,682)	(\$17,063)	(\$12,926)	(\$8,531)
***	TOTAL DIRECT ANNUAL COSTS ***	DAC	(\$9,226)	(\$7,436)	(\$5,391)	(\$3,218)
<b>B. INDIRECT ANNUAL COSTS (IAC)</b>						
1.	OVERHEAD (60% OF SUM OF ALL LABOR AND MAINTENANCE MATERIALS)		\$300	\$300	\$300	\$300
2.	ADMINISTRATIVE (0.02*TCIC)		\$7,596	\$7,596	\$7,596	\$7,596
3.	PROPERTY TAX (0.01*TCIC)		\$3,798	\$3,798	\$3,798	\$3,798
4.	INSURANCE (0.01*TCIC)		\$3,798	\$3,798	\$3,798	\$3,798
***	TOTAL INDIRECT ANNUAL COSTS ***	IAC	\$15,493	\$15,493	\$15,493	\$15,493
***	TOTAL ANNUAL OPERATING AND MAINTENANCE COSTS *** (DAC+IAC)	O&M	\$6,267	\$8,056	\$10,101	\$12,274
COST EFFECTIVENESS						
<b>A. TOTAL ANNUALIZED COST (incl. capital and O&amp;M)</b>						
1.	ANNUALIZED CAPITAL INVESTMENT COST (ACIC)					
EXPECTED LIFETIME OF EQUIPMENT, YEARS			10	10	10	10
INTEREST RATE			0.1	0.1	0.1	0.1
CAPITAL RECOVERY FACTOR			0.1627	0.1627	0.1627	0.1627
TOTAL CAPITAL INVESTMENT COSTS (TCIC, above)			\$379,813	\$379,813	\$379,813	\$379,813
***	ANNUALIZED CAPITAL INVESTMENT COST ***	ACIC	\$61,813	\$61,813	\$61,813	\$61,813
2.	ANNUAL O&M COSTS (O&M, above)	O&M	\$6,267	\$8,056	\$10,101	\$12,274
***	TOTAL ANNUALIZED COST ***	ACIC+O&M	\$68,079	\$69,869	\$71,914	\$74,087
<b>B. NO<sub>x</sub> REMOVAL PER YEAR</b>						
1.	BASELINE NO <sub>x</sub> LEVEL (lb/MMBtu)	(NO <sub>x</sub> )1	0.18	0.18	0.18	0.18
2.	CONTROLLED NO <sub>x</sub> LEVEL (lb/MMBtu)	(NO <sub>x</sub> )2	0.07	0.07	0.07	0.07
3.	NO <sub>x</sub> REMOVAL EFFICIENCY (%)		60	60	60	60
4.	CAPACITY FACTOR	CF	0.8	0.66	0.5	0.33
5.	BOILER HEAT INPUT CAPACITY (MMBtu/hr)	CAP	81.3	81.3	81.3	81.3
***	NO <sub>x</sub> REMOVED PER YEAR (TONS/YR) *** [CAP*CF*(24 hr/day)*(365 days/yr)]*[(NO <sub>x</sub> )1-(NO <sub>x</sub> )2]/2000		30.8	25.4	19.2	12.7
***	COST EFFECTIVENESS (\$/TON NO <sub>x</sub> REMOVED, 1992 DOLLARS) ***		\$2,213	\$2,753	\$3,740	\$5,838

COST EFFECTIVENESS OF RETROFIT NOx CONTROLS					
BOILER TYPE:	PACKAGED WATERTUBE	CHAP. 6 REFERENCES	COST BASE		
BOILER CAPACITY (MMBtu/hr):	91	CIBO, 1992	1992 DOLLARS		
FUEL TYPE:	NATURAL GAS				
CONTROL METHOD:	LOW NOx BURNER AND FGR WITH CEM SYSTEM				
TOTAL CAPITAL INVESTMENT COST (TCIC)					
		BOILER CAPACITY FACTOR			
		0.8	0.66	0.5	0.33
<b>A. DIRECT CAPITAL COST (DCC)</b>					
1. PURCHASED EQUIPMENT COST (PEC)					
PRIMARY AND AUXILIARY EQUIPMENT (EQP)	EQP				
CEM SYSTEM					
INSTRUMENTATION					
SALES TAX					
FREIGHT					
*** TOTAL PURCHASED EQUIPMENT COST ***	PEC	\$426,040	\$426,040	\$426,040	\$426,040
2. DIRECT INSTALLATION COST (DIC)					
*** TOTAL DIRECT INSTALLATION COST ***	DIC	\$127,812	\$127,812	\$127,812	\$127,812
(30 percent of purchased equipment)					
3. SITE PREP, SP (as required)	SP				
4. BUILDINGS, BLDG (as required)	BLDG				
*** TOTAL DIRECT CAPITAL COST ***	DCC	\$553,851	\$553,851	\$553,851	\$553,851
(PEC+DIC+SP+BLDG)					
<b>B. INDIRECT CAPITAL COST (ICC)</b>					
1. ENGINEERING (0.10PEC)		\$42,604	\$42,604	\$42,604	\$42,604
2. CONSTRUCTION AND FIELD EXPENSES (0.10PEC)		\$42,604	\$42,604	\$42,604	\$42,604
3. CONSTRUCTION FEE (0.10PEC)		\$42,604	\$42,604	\$42,604	\$42,604
4. STARTUP (0.02PEC)		\$8,521	\$8,521	\$8,521	\$8,521
5. PERFORMANCE TEST (0.01PEC)		\$4,260	\$4,260	\$4,260	\$4,260
*** TOTAL INDIRECT CAPITAL COST ***	ICC	\$140,593	\$140,593	\$140,593	\$140,593
<b>C. CONTINGENCY (20 percent of direct and indirect)</b>					
	CONT	\$138,889	\$138,889	\$138,889	\$138,889
*** TOTAL CAPITAL INVESTMENT COST ***	TCIC	\$833,333	\$833,333	\$833,333	\$833,333
(DCC+ICC+CONT)					

CONTINUED ON NEXT PAGE

COST EFFECTIVENESS OF RETROFIT NOx CONTROLS						
BOILER TYPE: PACKAGED WATERTUBE		CHAP. 6 REFERENCES		COST BASE		
BOILER CAPACITY (MMBtu/hr): 91		CIBO, 1992		1992 DOLLARS		
FUEL TYPE: NATURAL GAS						
CONTROL METHOD: LOW NOx BURNER AND FGR WITH CEM SYSTEM						
ANNUAL OPERATING AND MAINTENANCE COSTS (O&M)						
		CAPACITY FACTOR	0.8	0.66	0.5	0.33
<b>A. DIRECT ANNUAL COSTS (DAC)</b>						
1. OPERATING LABOR			\$7,000	\$7,000	\$7,000	\$7,000
2. MAINTENANCE LABOR						
3. MAINTENANCE MATERIALS						
4. REPLACEMENT MATERIALS						
5. ELECTRICITY @ \$0.05/kw-hr			\$11,894	\$9,812	\$7,434	\$4,906
6. STEAM						
7. FUEL						
8. WASTE DISPOSAL						
9. CHEMICALS						
10. OTHER: 1% FUEL SAVINGS, N. GAS @ \$3.63/MMBtu r & d			(\$23,150)	(\$19,098)	(\$14,468)	(\$9,549)
*** TOTAL DIRECT ANNUAL COSTS ***		DAC	(\$4,256)	(\$2,286)	(\$35)	\$2,357
<b>B. INDIRECT ANNUAL COSTS (IAC)</b>						
1. OVERHEAD (60% OF SUM OF ALL LABOR AND MAINTENANCE MATERIALS)			\$4,200	\$4,200	\$4,200	\$4,200
2. ADMINISTRATIVE (0.02*TCIC)			\$16,667	\$16,667	\$16,667	\$16,667
3. PROPERTY TAX (0.01*TCIC)			\$8,333	\$8,333	\$8,333	\$8,333
4. INSURANCE (0.01*TCIC)			\$8,333	\$8,333	\$8,333	\$8,333
*** TOTAL INDIRECT ANNUAL COSTS ***		IAC	\$37,533	\$37,533	\$37,533	\$37,533
*** TOTAL ANNUAL OPERATING AND MAINTENANCE COSTS *** (DAC+IAC)		O&M	\$33,277	\$35,247	\$37,498	\$39,890
COST EFFECTIVENESS						
<b>A. TOTAL ANNUALIZED COST (incl. capital and O&amp;M)</b>						
1. ANNUALIZED CAPITAL INVESTMENT COST (ACIC)						
EXPECTED LIFETIME OF EQUIPMENT, YEARS			10	10	10	10
INTEREST RATE			0.1	0.1	0.1	0.1
CAPITAL RECOVERY FACTOR			0.1627	0.1627	0.1627	0.1627
TOTAL CAPITAL INVESTMENT COSTS (TCIC, above)			\$833,333	\$833,333	\$833,333	\$833,333
*** ANNUALIZED CAPITAL INVESTMENT COST ***		ACIC	\$135,621	\$135,621	\$135,621	\$135,621
2. ANNUAL O&M COSTS (O&M, above)		O&M	\$33,277	\$35,247	\$37,498	\$39,890
*** TOTAL ANNUALIZED COST ***		ACIC+O&M	\$168,899	\$170,868	\$173,120	\$175,511
<b>B. NOx REMOVAL PER YEAR</b>						
1. BASELINE NOx LEVEL (lb/MMBtu)		(NOx)1	0.18	0.18	0.18	0.18
2. CONTROLLED NOx LEVEL (lb/MMBtu)		(NOx)2	0.07	0.07	0.07	0.07
3. NOx REMOVAL EFFICIENCY (%)			60	60	60	60
4. CAPACITY FACTOR		CF	0.8	0.66	0.5	0.33
5. BOILER HEAT INPUT CAPACITY (MMBtu/hr)		CAP	91	91	91	91
*** NOx REMOVED PER YEAR (TONS/YR) ***						
[CAP*CF*(24 hr/day)*(365 days/yr)]*[(NOx)1-(NOx)2]/2000			34.4	28.4	21.5	14.2
*** COST EFFECTIVENESS (\$/TON NOx REMOVED, 1992 DOLLARS) ***			\$4,905	\$6,014	\$8,043	\$12,355

COST EFFECTIVENESS OF RETROFIT NOx CONTROLS					
BOILER TYPE:	PACKAGED WATERTUBE	CHAP. 6 REFERENCES	COST BASE		
BOILER CAPACITY (MMBtu/hr):	265	CIBO, 1992	1992 DOLLARS		
FUEL TYPE:	NATURAL GAS				
CONTROL METHOD:	LNB AND FGR WITH CEM SYSTEM				
TOTAL CAPITAL INVESTMENT COST (TCIC)					
		BOILER CAPACITY FACTOR			
		0.8	0.66	0.5	0.33
<b>A. DIRECT CAPITAL COST (DCC)</b>					
1. PURCHASED EQUIPMENT COST (PEC)					
PRIMARY AND AUXILIARY EQUIPMENT (EQP)	EQP				
CEM SYSTEM					
INSTRUMENTATION					
SALES TAX					
FREIGHT					
*** TOTAL PURCHASED EQUIPMENT COST ***	PEC	\$340,725	\$340,725	\$340,725	\$340,725
2. DIRECT INSTALLATION COST (DIC)					
*** TOTAL DIRECT INSTALLATION COST ***	DIC	\$102,218	\$102,218	\$102,218	\$102,218
(30 percent of purchased equipment)					
3. SITE PREP. SP (as required)	SP				
4. BUILDINGS, BLDG (as required)	BLDG				
*** TOTAL DIRECT CAPITAL COST ***	DCC	\$442,943	\$442,943	\$442,943	\$442,943
(PEC+DIC+SP+BLDG)					
<b>B. INDIRECT CAPITAL COST (ICC)</b>					
1. ENGINEERING (0.10PEC)		\$34,073	\$34,073	\$34,073	\$34,073
2. CONSTRUCTION AND FIELD EXPENSES (0.10PEC)		\$34,073	\$34,073	\$34,073	\$34,073
3. CONSTRUCTION FEE (0.10PEC)		\$34,073	\$34,073	\$34,073	\$34,073
4. STARTUP (0.02PEC)		\$6,815	\$6,815	\$6,815	\$6,815
5. PERFORMANCE TEST (0.01PEC)		\$3,407	\$3,407	\$3,407	\$3,407
*** TOTAL INDIRECT CAPITAL COST ***	ICC	\$112,439	\$112,439	\$112,439	\$112,439
<b>C. CONTINGENCY (20 percent of direct and indirect)</b>					
	CONT	\$111,076	\$111,076	\$111,076	\$111,076
*** TOTAL CAPITAL INVESTMENT COST ***	TCIC	\$666,459	\$666,459	\$666,459	\$666,459
(DCC+ICC+CONT)					

CONTINUED ON NEXT PAGE

COST EFFECTIVENESS OF RETROFIT NO <sub>x</sub> CONTROLS					
BOILER TYPE:	PACKAGED WATERTUBE	CHAP. 6 REFERENCES	COST BASE		
BOILER CAPACITY (MMBtu/hr):	265	CIBO, 1992	1992 DOLLARS		
FUEL TYPE:	NATURAL GAS				
CONTROL METHOD:	LNB AND FGR WITH CEM SYSTEM				
<b>ANNUAL OPERATING AND MAINTENANCE COSTS (O&amp;M)</b>					
	CAPACITY FACTOR	0.8	0.66	0.5	0.33
<b>A. DIRECT ANNUAL COSTS (DAC)</b>					
1. OPERATING LABOR					
2. MAINTENANCE LABOR					
3. MAINTENANCE MATERIALS		\$500	\$500	\$500	\$500
4. REPLACEMENT MATERIALS		\$500	\$500	\$500	\$500
5. ELECTRICITY @ \$0.05/kW-hr		\$34,635	\$28,574	\$21,647	\$14,287
6. STEAM					
7. FUEL					
8. WASTE DISPOSAL					
9. CHEMICALS					
10. OTHER: 1% FUEL SAVINGS, N. GAS @ \$3.63/MMBtu		(\$67,413)	(\$55,616)	(\$42,133)	(\$27,808)
<b>*** TOTAL DIRECT ANNUAL COSTS ***</b>	DAC	<b>(\$31,778)</b>	<b>(\$26,042)</b>	<b>(\$19,486)</b>	<b>(\$12,521)</b>
<b>B. INDIRECT ANNUAL COSTS (IAC)</b>					
1. OVERHEAD (60% OF SUM OF ALL LABOR AND MAINTENANCE MATERIALS)		\$300	\$300	\$300	\$300
2. ADMINISTRATIVE (0.02*TCIC)		\$13,329	\$13,329	\$13,329	\$13,329
3. PROPERTY TAX (0.01*TCIC)		\$6,665	\$6,665	\$6,665	\$6,665
4. INSURANCE (0.01*TCIC)		\$6,665	\$6,665	\$6,665	\$6,665
<b>*** TOTAL INDIRECT ANNUAL COSTS ***</b>	IAC	<b>\$26,958</b>	<b>\$26,958</b>	<b>\$26,958</b>	<b>\$26,958</b>
<b>*** TOTAL ANNUAL OPERATING AND MAINTENANCE COSTS ***</b> (DAC+IAC)	O&M	<b>(\$4,820)</b>	<b>\$916</b>	<b>\$7,472</b>	<b>\$14,437</b>
<b>COST EFFECTIVENESS</b>					
<b>A. TOTAL ANNUALIZED COST (incl. capital and O&amp;M)</b>					
1. ANNUALIZED CAPITAL INVESTMENT COST (ACIC)					
EXPECTED LIFETIME OF EQUIPMENT, YEARS		10	10	10	10
INTEREST RATE		0.1	0.1	0.1	0.1
CAPITAL RECOVERY FACTOR		0.1627	0.1627	0.1627	0.1627
TOTAL CAPITAL INVESTMENT COSTS (TCIC, above)		\$666,459	\$666,459	\$666,459	\$666,459
<b>*** ANNUALIZED CAPITAL INVESTMENT COST ***</b>	ACIC	<b>\$108,463</b>	<b>\$108,463</b>	<b>\$108,463</b>	<b>\$108,463</b>
2. ANNUAL O&M COSTS (O&M, above)	O&M	<b>(\$4,820)</b>	<b>\$916</b>	<b>\$7,472</b>	<b>\$14,437</b>
<b>*** TOTAL ANNUALIZED COST ***</b>	ACIC+O&M	<b>\$103,643</b>	<b>\$109,379</b>	<b>\$115,935</b>	<b>\$122,900</b>
<b>B. NO<sub>x</sub> REMOVAL PER YEAR</b>					
1. BASELINE NO <sub>x</sub> LEVEL (lb/MMBtu)	(NO <sub>x</sub> )1	0.24	0.24	0.24	0.24
2. CONTROLLED NO <sub>x</sub> LEVEL (lb/MMBtu)	(NO <sub>x</sub> )2	0.10	0.10	0.10	0.10
3. NO <sub>x</sub> REMOVAL EFFICIENCY (%)		60	60	60	60
4. CAPACITY FACTOR	CF	0.8	0.66	0.5	0.33
5. BOILER HEAT INPUT CAPACITY (MMBtu/hr)	CAP	265	265	265	265
<b>*** NO<sub>x</sub> REMOVED PER YEAR (TONS/YR) ***</b> [CAP*CF*(24 hr/day)*(365 days/yr)]*[(NO <sub>x</sub> )1-(NO <sub>x</sub> )2]/2000		<b>133.7</b>	<b>110.3</b>	<b>83.6</b>	<b>55.2</b>
<b>*** COST EFFECTIVENESS (\$/TON NO<sub>x</sub> REMOVED, 1992 DOLLARS) ***</b>		<b>\$775</b>	<b>\$992</b>	<b>\$1,387</b>	<b>\$2,228</b>

COST EFFECTIVENESS OF RETROFIT NOx CONTROLS					
BOILER TYPE: PACKAGED FIRETUBE		CHAP. 6 REFERENCES		COST BASE	
BOILER CAPACITY (MMBtu/hr): 2.9		HUGH DEAN, 1988		1992 DOLLARS	
FUEL TYPE: NATURAL GAS					
CONTROL METHOD: FGR AND OXYGEN TRIM					
TOTAL CAPITAL INVESTMENT COST (TCIC)					
		BOILER CAPACITY FACTOR			
		0.8	0.66	0.5	0.33
<b>A. DIRECT CAPITAL COST (DCC)</b>					
1. PURCHASED EQUIPMENT COST (PEC)					
PRIMARY AND AUXILIARY EQUIPMENT (EQP)	EQP	\$23,546	\$23,546	\$23,546	\$23,546
CEM SYSTEM					
INSTRUMENTATION					
SALES TAX		\$1,531	\$1,531	\$1,531	\$1,531
FREIGHT		\$843	\$843	\$843	\$843
*** TOTAL PURCHASED EQUIPMENT COST ***	PEC	\$25,920	\$25,920	\$25,920	\$25,920
2. DIRECT INSTALLATION COST (DIC)					
*** TOTAL DIRECT INSTALLATION COST ***	DIC	\$8,764	\$8,764	\$8,764	\$8,764
3. SITE PREP, SP (as required)		SP			
4. BUILDINGS, BLDG (as required)		BLDG			
*** TOTAL DIRECT CAPITAL COST ***	DCC	\$34,684	\$34,684	\$34,684	\$34,684
(PEC+DIC+SP+BLDG)					
<b>B. INDIRECT CAPITAL COST (ICC)</b>					
1. ENGINEERING					
2. CONSTRUCTION AND FIELD EXPENSES					
3. CONSTRUCTION FEE					
4. STARTUP					
5. PERFORMANCE TEST					
*** TOTAL INDIRECT CAPITAL COST ***	ICC	\$4,873	\$4,873	\$4,873	\$4,873
<b>C. CONTINGENCY (20 percent of direct and indirect)</b>		CONT			
*** TOTAL CAPITAL INVESTMENT COST ***	TCIC	\$47,468	\$47,468	\$47,468	\$47,468
(DCC+ICC+CONT)					

CONTINUED ON NEXT PAGE

COST EFFECTIVENESS OF RETROFIT NOx CONTROLS						
BOILER TYPE: PACKAGED FIRETUBE		CHAP. 6 REFERENCES		COST BASE		
BOILER CAPACITY (MMBtu/hr): 2.9		HUGH DEAN, 1988		1992 DOLLARS		
FUEL TYPE: NATURAL GAS						
CONTROL METHOD: FGR AND OXYGEN TRIM						
ANNUAL OPERATING AND MAINTENANCE COSTS (O&M)						
		CAPACITY FACTOR	0.8	0.66	0.5	0.33
<b>A. DIRECT ANNUAL COSTS (DAC)</b>						
1.	OPERATING LABOR		\$500	\$500	\$500	\$500
2.	MAINTENANCE LABOR		\$500	\$500	\$500	\$500
3.	MAINTENANCE MATERIALS					
4.	REPLACEMENT MATERIALS					
5.	ELECTRICITY @ \$0.05/kW-hr		\$235	\$194	\$147	\$97
6.	STEAM					
7.	FUEL					
8.	WASTE DISPOSAL					
9.	CHEMICALS					
10.	OTHER: 1% FUEL SAVINGS, N. GAS @ \$3.63/MMBtu		(\$745)	(\$615)	(\$466)	(\$307)
<b>*** TOTAL DIRECT ANNUAL COSTS ***</b>		DAC	\$490	\$579	\$681	\$790
<b>B. INDIRECT ANNUAL COSTS (IAC)</b>						
1.	OVERHEAD (80% OF SUM OF ALL LABOR AND MAINTENANCE MATERIALS)		\$600	\$600	\$600	\$600
2.	ADMINISTRATIVE (0.02*TCIC)		\$949	\$949	\$949	\$949
3.	PROPERTY TAX (0.01*TCIC)		\$475	\$475	\$475	\$475
4.	INSURANCE (0.01*TCIC)		\$475	\$475	\$475	\$475
<b>*** TOTAL INDIRECT ANNUAL COSTS ***</b>		IAC	\$2,499	\$2,499	\$2,499	\$2,499
<b>*** TOTAL ANNUAL OPERATING AND MAINTENANCE COSTS ***</b>		O&M	\$2,989	\$3,078	\$3,180	\$3,288
COST EFFECTIVENESS						
<b>A. TOTAL ANNUALIZED COST (incl. capital and O&amp;M)</b>						
1.	ANNUALIZED CAPITAL INVESTMENT COST (ACIC)					
EXPECTED LIFETIME OF EQUIPMENT, YEARS			10	10	10	10
INTEREST RATE			0.1	0.1	0.1	0.1
CAPITAL RECOVERY FACTOR			0.1627	0.1627	0.1627	0.1627
TOTAL CAPITAL INVESTMENT COSTS (TCIC, above)			\$47,468	\$47,468	\$47,468	\$47,468
<b>*** ANNUALIZED CAPITAL INVESTMENT COST ***</b>		ACIC	\$7,725	\$7,725	\$7,725	\$7,725
2.	ANNUAL O&M COSTS (O&M, above)	O&M	\$2,989	\$3,078	\$3,180	\$3,288
<b>*** TOTAL ANNUALIZED COST ***</b>		ACIC+O&M	\$10,714	\$10,803	\$10,905	\$11,013
<b>B. NOx REMOVAL PER YEAR</b>						
1.	BASELINE NOx LEVEL (lb/MMBtu)	(NOx)1	0.12	0.12	0.12	0.12
2.	CONTROLLED NOx LEVEL (lb/MMBtu)	(NOx)2	0.07	0.07	0.07	0.07
3.	NOx REMOVAL EFFICIENCY (%)		40	40	40	40
4.	CAPACITY FACTOR	CF	0.8	0.66	0.5	0.33
5.	BOILER HEAT INPUT CAPACITY (MMBtu/hr)	CAP	2.9	2.9	2.9	2.9
<b>*** NOx REMOVED PER YEAR (TONS/YR) ***</b>						
[CAP*CF*(24 hr/day)*(365 days/yr)]*[(NOx)1-(NOx)2]/2000			0.5	0.4	0.3	0.2
<b>*** COST EFFECTIVENESS (\$/TON NOx REMOVED, 1992 DOLLARS) ***</b>			\$21,741	\$26,572	\$35,406	\$54,179



COST EFFECTIVENESS OF RETROFIT NO <sub>x</sub> CONTROLS					
BOILER TYPE: PACKAGED FIRETUBE		CHAP. 6 REFERENCES		COST BASE	
BOILER CAPACITY (MMBtu/hr): 5.23		HUGH DEAN, 1988		1992 DOLLARS	
FUEL TYPE: NATURAL GAS					
CONTROL METHOD: FGR AND OXYGEN TRIM					
TOTAL CAPITAL INVESTMENT COST (TCIC)					
		BOILER CAPACITY FACTOR			
		0.8	0.66	0.5	0.33
<b>A. DIRECT CAPITAL COST (DCC)</b>					
1. PURCHASED EQUIPMENT COST (PEC)					
PRIMARY AND AUXILIARY EQUIPMENT (EQP)	EQP	\$24,984	\$24,984	\$24,984	\$24,984
CEM SYSTEM					
INSTRUMENTATION					
SALES TAX		\$1,624	\$1,624	\$1,624	\$1,624
FREIGHT		\$892	\$892	\$892	\$892
*** TOTAL PURCHASED EQUIPMENT COST ***	PEC	\$27,500	\$27,500	\$27,500	\$27,500
2. DIRECT INSTALLATION COST (DIC)					
*** TOTAL DIRECT INSTALLATION COST ***	DIC	\$9,290	\$9,290	\$9,290	\$9,290
3. SITE PREP, SP (as required)					
	SP				
4. BUILDINGS, BLDG (as required)					
	BLDG				
*** TOTAL DIRECT CAPITAL COST ***	DCC	\$36,790	\$36,790	\$36,790	\$36,790
(PEC+DIC+SP+BLDG)					
<b>B. INDIRECT CAPITAL COST (ICC)</b>					
1. ENGINEERING					
2. CONSTRUCTION AND FIELD EXPENSES					
3. CONSTRUCTION FEE					
4. STARTUP					
5. PERFORMANCE TEST					
*** TOTAL INDIRECT CAPITAL COST ***	ICC	\$5,300	\$5,300	\$5,300	\$5,300
<b>C. CONTINGENCY (20 percent of direct and indirect)</b>					
	CONT	\$8,418	\$8,418	\$8,418	\$8,418
*** TOTAL CAPITAL INVESTMENT COST ***	TCIC	\$50,508	\$50,508	\$50,508	\$50,508
(DCC+ICC+CONT)					

CONTINUED ON NEXT PAGE

COST EFFECTIVENESS OF RETROFIT NO <sub>x</sub> CONTROLS						
BOILER TYPE: PACKAGED FIRETUBE		CHAP. 6 REFERENCES		COST BASE		
BOILER CAPACITY (MMBtu/hr): 5.23		HUGH DEAN, 1988		1992 DOLLARS		
FUEL TYPE: NATURAL GAS						
CONTROL METHOD: FGR AND OXYGEN TRIM						
ANNUAL OPERATING AND MAINTENANCE COSTS (O&M)						
		CAPACITY FACTOR	0.8	0.66	0.5	0.33
<b>A. DIRECT ANNUAL COSTS (DAC)</b>						
1.	OPERATING LABOR					
2.	MAINTENANCE LABOR		\$500	\$500	\$500	\$500
3.	MAINTENANCE MATERIALS		\$500	\$500	\$500	\$500
4.	REPLACEMENT MATERIALS					
5.	ELECTRICITY @ \$0.05/kw-hr		\$314	\$259	\$196	\$129
6.	STEAM					
7.	FUEL					
8.	WASTE DISPOSAL					
9.	CHEMICALS					
10.	OTHER: 1% FUEL SAVINGS, N. GAS @ \$3.63/MMBtu		(\$1,330)	(\$1,098)	(\$832)	(\$549)
<b>*** TOTAL DIRECT ANNUAL COSTS ***</b>		DAC	(\$17)	\$161	\$365	\$581
<b>B. INDIRECT ANNUAL COSTS (IAC)</b>						
1.	OVERHEAD (60% OF SUM OF ALL LABOR AND MAINTENANCE MATERIALS)		\$600	\$600	\$600	\$600
2.	ADMINISTRATIVE (0.02*TCIC)		\$1,010	\$1,010	\$1,010	\$1,010
3.	PROPERTY TAX (0.01*TCIC)		\$505	\$505	\$505	\$505
4.	INSURANCE (0.01*TCIC)		\$505	\$505	\$505	\$505
<b>*** TOTAL INDIRECT ANNUAL COSTS ***</b>		IAC	\$2,620	\$2,620	\$2,620	\$2,620
<b>*** TOTAL ANNUAL OPERATING AND MAINTENANCE COSTS ***</b> (DAC+IAC)		O&M	\$2,604	\$2,781	\$2,985	\$3,201
COST EFFECTIVENESS						
<b>A. TOTAL ANNUALIZED COST (incl. capital and O&amp;M)</b>						
<b>1. ANNUALIZED CAPITAL INVESTMENT COST (ACIC)</b>						
EXPECTED LIFETIME OF EQUIPMENT, YEARS			10	10	10	10
INTEREST RATE			0.1	0.1	0.1	0.1
CAPITAL RECOVERY FACTOR			0.1627	0.1627	0.1627	0.1627
TOTAL CAPITAL INVESTMENT COSTS (TCIC, above)			\$50,508	\$50,508	\$50,508	\$50,508
<b>*** ANNUALIZED CAPITAL INVESTMENT COST ***</b>		ACIC	\$8,220	\$8,220	\$8,220	\$8,220
<b>2. ANNUAL O&amp;M COSTS (O&amp;M, above)</b>		O&M	\$2,604	\$2,781	\$2,985	\$3,201
<b>*** TOTAL ANNUALIZED COST ***</b>		ACIC+O&M	\$10,823	\$11,001	\$11,205	\$11,421
<b>B. NO<sub>x</sub> REMOVAL PER YEAR</b>						
1.	BASELINE NO <sub>x</sub> LEVEL (lb/MMBtu)	(NO <sub>x</sub> )1	0.12	0.12	0.12	0.12
2.	CONTROLLED NO <sub>x</sub> LEVEL (lb/MMBtu)	(NO <sub>x</sub> )2	0.07	0.07	0.07	0.07
3.	NO <sub>x</sub> REMOVAL EFFICIENCY (%)		40	40	40	40
4.	CAPACITY FACTOR	CF	0.8	0.66	0.5	0.33
5.	BOILER HEAT INPUT CAPACITY (MMBtu/hr)	CAP	5.23	5.23	5.23	5.23
<b>*** NO<sub>x</sub> REMOVED PER YEAR (TONS/YR) ***</b> [CAP*CF*(24 hr/day)*(365 days/yr)]*[(NO <sub>x</sub> )1-(NO <sub>x</sub> )2]/2000			0.9	0.7	0.5	0.4
<b>*** COST EFFECTIVENESS (\$/TON NO<sub>x</sub> REMOVED, 1992 DOLLARS) ***</b>			\$12,304	\$15,159	\$20,380	\$31,475

COST EFFECTIVENESS OF RETROFIT NO <sub>x</sub> CONTROLS					
BOILER TYPE:	PACKAGED FIRETUBE	CHAP. 6 REFERENCES	COST BASE		
BOILER CAPACITY (MMBtu/hr):	10.46	HUGH DEAN, 1988	1992 DOLLARS		
FUEL TYPE:	NATURAL GAS				
CONTROL METHOD:	FGR AND OXYGEN TRIM				
TOTAL CAPITAL INVESTMENT COST (TCIC)					
		BOILER CAPACITY FACTOR			
		0.8	0.66	0.5	0.33
<b>A. DIRECT CAPITAL COST (DCC)</b>					
1. PURCHASED EQUIPMENT COST (PEC)					
PRIMARY AND AUXILIARY EQUIPMENT (EQP)	EQP	\$29,346	\$29,346	\$29,346	\$29,346
CEM SYSTEM					
INSTRUMENTATION					
SALES TAX		\$1,907	\$1,907	\$1,907	\$1,907
FREIGHT		\$942	\$942	\$942	\$942
*** TOTAL PURCHASED EQUIPMENT COST ***	PEC	\$32,195	\$32,195	\$32,195	\$32,195
2. DIRECT INSTALLATION COST (DIC)					
*** TOTAL DIRECT INSTALLATION COST ***	DIC	\$9,290	\$9,290	\$9,290	\$9,290
3. SITE PREP, SP (as required)	SP				
4. BUILDINGS, BLDG (as required)	BLDG				
*** TOTAL DIRECT CAPITAL COST ***	DCC	\$41,485	\$41,485	\$41,485	\$41,485
(PEC+DIC+SP+BLDG)					
<b>B. INDIRECT CAPITAL COST (ICC)</b>					
1. ENGINEERING					
2. CONSTRUCTION AND FIELD EXPENSES					
3. CONSTRUCTION FEE					
4. STARTUP					
5. PERFORMANCE TEST					
*** TOTAL INDIRECT CAPITAL COST ***	ICC	\$5,255	\$5,255	\$5,255	\$5,255
<b>C. CONTINGENCY (20 percent of direct and indirect)</b>					
*** TOTAL CAPITAL INVESTMENT COST ***	TCIC	\$56,087	\$56,087	\$56,087	\$56,087
(DCC+ICC+CONT)					

CONTINUED ON NEXT PAGE

COST EFFECTIVENESS OF RETROFIT NO <sub>x</sub> CONTROLS					
BOILER TYPE:	PACKAGED FIRETUBE	CHAP. 6 REFERENCES	COST BASE		
BOILER CAPACITY (MMBtu/hr):	10.46	HUGH DEAN, 1988	1992 DOLLARS		
FUEL TYPE:	NATURAL GAS				
CONTROL METHOD:	FGR AND OXYGEN TRIM				
ANNUAL OPERATING AND MAINTENANCE COSTS (O&M)					
	CAPACITY FACTOR	0.8	0.66	0.5	0.33
<b>A. DIRECT ANNUAL COSTS (DAC)</b>					
1. OPERATING LABOR					
2. MAINTENANCE LABOR		\$500	\$500	\$500	\$500
3. MAINTENANCE MATERIALS		\$500	\$500	\$500	\$500
4. REPLACEMENT MATERIALS					
5. ELECTRICITY @ \$0.05/kW-hr		\$967	\$798	\$604	\$399
6. STEAM					
7. FUEL					
8. WASTE DISPOSAL					
9. CHEMICALS					
10. OTHER: 1% FUEL SAVINGS, N. GAS @ \$3.63/MMBtu		(\$2,661)	(\$2,195)	(\$1,663)	(\$1,098)
<b>*** TOTAL DIRECT ANNUAL COSTS ***</b>	DAC	(\$694)	(\$397)	(\$59)	\$301
<b>B. INDIRECT ANNUAL COSTS (IAC)</b>					
1. OVERHEAD (60% OF SUM OF ALL LABOR AND MAINTENANCE MATERIALS)		\$600	\$600	\$600	\$600
2. ADMINISTRATIVE (0.02*TCIC)		\$1,122	\$1,122	\$1,122	\$1,122
3. PROPERTY TAX (0.01*TCIC)		\$561	\$561	\$561	\$561
4. INSURANCE (0.01*TCIC)		\$561	\$561	\$561	\$561
<b>*** TOTAL INDIRECT ANNUAL COSTS ***</b>	IAC	\$2,843	\$2,843	\$2,843	\$2,843
<b>*** TOTAL ANNUAL OPERATING AND MAINTENANCE COSTS ***</b>	O&M	\$2,150	\$2,446	\$2,785	\$3,145
<b>COST EFFECTIVENESS</b>					
<b>A. TOTAL ANNUALIZED COST (incl. capital and O&amp;M)</b>					
1. ANNUALIZED CAPITAL INVESTMENT COST (ACIC)					
EXPECTED LIFETIME OF EQUIPMENT, YEARS		10	10	10	10
INTEREST RATE		0.1	0.1	0.1	0.1
CAPITAL RECOVERY FACTOR		0.1627	0.1627	0.1627	0.1627
TOTAL CAPITAL INVESTMENT COSTS (TCIC, above)		\$56,087	\$56,087	\$56,087	\$56,087
<b>*** ANNUALIZED CAPITAL INVESTMENT COST ***</b>	ACIC	\$9,128	\$9,128	\$9,128	\$9,128
2. ANNUAL O&M COSTS (O&M, above)	O&M	\$2,150	\$2,446	\$2,785	\$3,145
<b>*** TOTAL ANNUALIZED COST ***</b>	ACIC+O&M	\$11,278	\$11,574	\$11,913	\$12,273
<b>B. NO<sub>x</sub> REMOVAL PER YEAR</b>					
1. BASELINE NO <sub>x</sub> LEVEL (lb/MMBtu)	(NO <sub>x</sub> )1	0.12	0.12	0.12	0.12
2. CONTROLLED NO <sub>x</sub> LEVEL (lb/MMBtu)	(NO <sub>x</sub> )2	0.07	0.07	0.07	0.07
3. NO <sub>x</sub> REMOVAL EFFICIENCY (%)		40	40	40	40
4. CAPACITY FACTOR	CF	0.8	0.66	0.5	0.33
5. BOILER HEAT INPUT CAPACITY (MMBtu/hr)	CAP	10.46	10.46	10.46	10.46
<b>*** NO<sub>x</sub> REMOVED PER YEAR (TONS/YR) ***</b>					
[CAP*CF*(24 hr/day)*(365 days/yr)]*[(NO <sub>x</sub> )1-(NO <sub>x</sub> )2]/2000		1.8	1.5	1.1	0.7
<b>*** COST EFFECTIVENESS (\$/TON NO<sub>x</sub> REMOVED, 1992 DOLLARS) ***</b>		\$6,410	\$7,974	\$10,834	\$16,912

COST EFFECTIVENESS OF RETROFIT NO <sub>x</sub> CONTROLS					
BOILER TYPE: PACKAGED FIRETUBE		CHAP. 6 REFERENCES		COST BASE	
BOILER CAPACITY (MMBtu/hr): 20.9		HUGH DEAN, 1988		1992 DOLLARS	
FUEL TYPE: NATURAL GAS					
CONTROL METHOD: FGR AND OXYGEN TRIM					
TOTAL CAPITAL INVESTMENT COST (TCIC)					
		BOILER CAPACITY FACTOR			
		0.8	0.66	0.5	0.33
<b>A. DIRECT CAPITAL COST (DCC)</b>					
1. PURCHASED EQUIPMENT COST (PEC)					
PRIMARY AND AUXILIARY EQUIPMENT (EQP)	EQP	\$34,204	\$34,204	\$34,204	\$34,204
CEM SYSTEM					
INSTRUMENTATION					
SALES TAX		\$2,224	\$2,224	\$2,224	\$2,224
FREIGHT		\$1,041	\$1,041	\$1,041	\$1,041
*** TOTAL PURCHASED EQUIPMENT COST ***	PEC	\$37,469	\$37,469	\$37,469	\$37,469
2. DIRECT INSTALLATION COST (DIC)					
*** TOTAL DIRECT INSTALLATION COST ***	DIC	\$9,815	\$9,815	\$9,815	\$9,815
3. SITE PREP, SP (as required)					
	SP				
4. BUILDINGS, BLDG (as required)					
	BLDG				
*** TOTAL DIRECT CAPITAL COST ***	DCC	\$47,284	\$47,284	\$47,284	\$47,284
(PEC+DIC+SP+BLDG)					
<b>B. INDIRECT CAPITAL COST (ICC)</b>					
1. ENGINEERING					
2. CONSTRUCTION AND FIELD EXPENSES					
3. CONSTRUCTION FEE					
4. STARTUP					
5. PERFORMANCE TEST					
*** TOTAL INDIRECT CAPITAL COST ***	ICC	\$5,255	\$5,255	\$5,255	\$5,255
<b>C. CONTINGENCY (20 percent of direct and indirect)</b>					
	CONT	\$10,508	\$10,508	\$10,508	\$10,508
*** TOTAL CAPITAL INVESTMENT COST ***	TCIC	\$63,046	\$63,046	\$63,046	\$63,046
(DCC+ICC+CONT)					

CONTINUED ON NEXT PAGE

COST EFFECTIVENESS OF RETROFIT NOx CONTROLS					
BOILER TYPE: PACKAGED FIRETUBE	CHAP. 6 REFERENCES	COST BASE			
BOILER CAPACITY (MMBtu/hr): 20.9	HUGH DEAN, 1988	1992 DOLLARS			
FUEL TYPE: NATURAL GAS					
CONTROL METHOD: FGR AND OXYGEN TRIM					
ANNUAL OPERATING AND MAINTENANCE COSTS (O&M)					
	CAPACITY FACTOR	0.8	0.66	0.5	0.33
<b>A. DIRECT ANNUAL COSTS (DAC)</b>					
1. OPERATING LABOR					
2. MAINTENANCE LABOR		\$500	\$500	\$500	\$500
3. MAINTENANCE MATERIALS		\$500	\$500	\$500	\$500
4. REPLACEMENT MATERIALS					
5. ELECTRICITY @ \$0.05/kw-hr		\$3,790	\$3,127	\$2,369	\$1,563
6. STEAM					
7. FUEL					
8. WASTE DISPOSAL					
9. CHEMICALS					
10. OTHER: 1% FUEL SAVINGS, N. GAS @ \$3.63/MMBtu		(\$5,323)	(\$4,392)	(\$3,327)	(\$2,196)
<b>*** TOTAL DIRECT ANNUAL COSTS ***</b>	<b>DAC</b>	<b>(\$533)</b>	<b>(\$265)</b>	<b>\$42</b>	<b>\$368</b>
<b>B. INDIRECT ANNUAL COSTS (IAC)</b>					
1. OVERHEAD (60% OF SUM OF ALL LABOR AND MAINTENANCE MATERIALS)		\$600	\$600	\$600	\$600
2. ADMINISTRATIVE (0.02*TCIC)		\$1,261	\$1,261	\$1,261	\$1,261
3. PROPERTY TAX (0.01*TCIC)		\$630	\$630	\$630	\$630
4. INSURANCE (0.01*TCIC)		\$630	\$630	\$630	\$630
<b>*** TOTAL INDIRECT ANNUAL COSTS ***</b>	<b>IAC</b>	<b>\$3,122</b>	<b>\$3,122</b>	<b>\$3,122</b>	<b>\$3,122</b>
<b>*** TOTAL ANNUAL OPERATING AND MAINTENANCE COSTS ***</b>	<b>O&amp;M</b>	<b>\$2,589</b>	<b>\$2,857</b>	<b>\$3,164</b>	<b>\$3,490</b>
COST EFFECTIVENESS					
<b>A. TOTAL ANNUALIZED COST (incl. capital and O&amp;M)</b>					
1. ANNUALIZED CAPITAL INVESTMENT COST (ACIC)					
EXPECTED LIFETIME OF EQUIPMENT, YEARS		10	10	10	10
INTEREST RATE		0.1	0.1	0.1	0.1
CAPITAL RECOVERY FACTOR		0.1627	0.1627	0.1627	0.1627
TOTAL CAPITAL INVESTMENT COSTS (TCIC, above)		\$63,046	\$63,046	\$63,046	\$63,046
<b>*** ANNUALIZED CAPITAL INVESTMENT COST ***</b>	<b>ACIC</b>	<b>\$10,260</b>	<b>\$10,260</b>	<b>\$10,260</b>	<b>\$10,260</b>
2. ANNUAL O&M COSTS (O&M, above)	<b>O&amp;M</b>	<b>\$2,589</b>	<b>\$2,857</b>	<b>\$3,164</b>	<b>\$3,490</b>
<b>*** TOTAL ANNUALIZED COST ***</b>	<b>ACIC+O&amp;M</b>	<b>\$12,849</b>	<b>\$13,118</b>	<b>\$13,424</b>	<b>\$13,750</b>
<b>B. NOx REMOVAL PER YEAR</b>					
1. BASELINE NOx LEVEL (lb/MMBtu)	(NOx)1	0.12	0.12	0.12	0.12
2. CONTROLLED NOx LEVEL (lb/MMBtu)	(NOx)2	0.07	0.07	0.07	0.07
3. NOx REMOVAL EFFICIENCY (%)		40	40	40	40
4. CAPACITY FACTOR	CF	0.8	0.66	0.5	0.33
5. BOILER HEAT INPUT CAPACITY (MMBtu/hr)	CAP	20.9	20.9	20.9	20.9
<b>*** NOx REMOVED PER YEAR (TONS/YR) ***</b>					
[CAP*CF*(24 hr/day)*(365 days/yr)]*[(NOx)1-(NOx)2]/2000		3.5	2.9	2.2	1.5
<b>*** COST EFFECTIVENESS (\$/TON NOx REMOVED, 1992 DOLLARS) ***</b>		<b>\$3,651</b>	<b>\$4,518</b>	<b>\$6,103</b>	<b>\$9,471</b>

COST EFFECTIVENESS OF RETROFIT NO <sub>x</sub> CONTROLS					
BOILER TYPE: PACKAGED FIRETUBE		CHAP. 6 REFERENCES		COST BASE	
BOILER CAPACITY (MMBtu/hr): 33.5		HUGH DEAN, 1988		1992 DOLLARS	
FUEL TYPE: NATURAL GAS					
CONTROL METHOD: FGR AND OXYGEN TRIM					
TOTAL CAPITAL INVESTMENT COST (TCIC)					
		BOILER CAPACITY FACTOR			
		0.8	0.66	0.5	0.33
A. DIRECT CAPITAL COST (DCC)					
1. PURCHASED EQUIPMENT COST (PEC)					
PRIMARY AND AUXILIARY EQUIPMENT (EQP)	EQP	\$37,971	\$37,971	\$37,971	\$37,971
CEM SYSTEM					
INSTRUMENTATION					
SALES TAX		\$2,469	\$2,469	\$2,469	\$2,469
FREIGHT		\$1,091	\$1,091	\$1,091	\$1,091
*** TOTAL PURCHASED EQUIPMENT COST ***	PEC	\$41,531	\$41,531	\$41,531	\$41,531
2. DIRECT INSTALLATION COST (DIC)					
*** TOTAL DIRECT INSTALLATION COST ***	DIC	\$11,401	\$11,401	\$11,401	\$11,401
3. SITE PREP, SP (as required)					
	SP				
4. BUILDINGS, BLDG (as required)					
	BLDG				
*** TOTAL DIRECT CAPITAL COST *** (PEC+DIC+SP+BLDG)	DCC	\$52,932	\$52,932	\$52,932	\$52,932
B. INDIRECT CAPITAL COST (ICC)					
1. ENGINEERING					
2. CONSTRUCTION AND FIELD EXPENSES					
3. CONSTRUCTION FEE					
4. STARTUP					
5. PERFORMANCE TEST					
*** TOTAL INDIRECT CAPITAL COST ***	ICC	\$5,255	\$5,255	\$5,255	\$5,255
C. CONTINGENCY (20 percent of direct and indirect)					
	CONT	\$11,637	\$11,637	\$11,637	\$11,637
*** TOTAL CAPITAL INVESTMENT COST *** (DCC+ICC+CONT)	TCIC	\$69,824	\$69,824	\$69,824	\$69,824

CONTINUED ON NEXT PAGE

COST EFFECTIVENESS OF RETROFIT NO <sub>x</sub> CONTROLS					
BOILER TYPE: PACKAGED FIRETUBE	CHAP. 6 REFERENCES		COST BASE		
BOILER CAPACITY (MMBtu/hr): 33.5	HUGH DEAN, 1988		1992 DOLLARS		
FUEL TYPE: NATURAL GAS					
CONTROL METHOD: FGR AND OXYGEN TRIM					
ANNUAL OPERATING AND MAINTENANCE COSTS (O&M)					
	CAPACITY FACTOR	0.8	0.66	0.5	0.33
<b>A. DIRECT ANNUAL COSTS (DAC)</b>					
1. OPERATING LABOR					
2. MAINTENANCE LABOR		\$500	\$500	\$500	\$500
3. MAINTENANCE MATERIALS		\$500	\$500	\$500	\$500
4. REPLACEMENT MATERIALS					
5. ELECTRICITY @ \$0.05/KW-hr		\$6,300	\$5,197	\$3,937	\$2,599
6. STEAM					
7. FUEL					
8. WASTE DISPOSAL					
9. CHEMICALS					
10. OTHER: 1% FUEL SAVINGS, N. GAS @ \$3.63/MMBtu		(\$8,517)	(\$7,027)	(\$5,323)	(\$3,513)
<b>*** TOTAL DIRECT ANNUAL COSTS ***</b>	DAC	<b>(\$1,217)</b>	<b>(\$829)</b>	<b>(\$386)</b>	<b>\$85</b>
<b>B. INDIRECT ANNUAL COSTS (IAC)</b>					
1. OVERHEAD (60% OF SUM OF ALL LABOR AND MAINTENANCE MATERIALS)		\$600	\$600	\$600	\$600
2. ADMINISTRATIVE (0.02*TCIC)		\$1,396	\$1,396	\$1,396	\$1,396
3. PROPERTY TAX (0.01*TCIC)		\$698	\$698	\$698	\$698
4. INSURANCE (0.01*TCIC)		\$698	\$698	\$698	\$698
<b>*** TOTAL INDIRECT ANNUAL COSTS ***</b>	IAC	<b>\$3,393</b>	<b>\$3,393</b>	<b>\$3,393</b>	<b>\$3,393</b>
<b>*** TOTAL ANNUAL OPERATING AND MAINTENANCE COSTS *** (DAC+IAC)</b>	O&M	<b>\$2,176</b>	<b>\$2,564</b>	<b>\$3,007</b>	<b>\$3,478</b>
COST EFFECTIVENESS					
<b>A. TOTAL ANNUALIZED COST (incl. capital and O&amp;M)</b>					
1. ANNUALIZED CAPITAL INVESTMENT COST (ACIC)					
EXPECTED LIFETIME OF EQUIPMENT, YEARS		10	10	10	10
INTEREST RATE		0.1	0.1	0.1	0.1
CAPITAL RECOVERY FACTOR		0.1627	0.1627	0.1627	0.1627
TOTAL CAPITAL INVESTMENT COSTS (TCIC, above)		\$69,824	\$69,824	\$69,824	\$69,824
<b>*** ANNUALIZED CAPITAL INVESTMENT COST ***</b>	ACIC	<b>\$11,363</b>	<b>\$11,363</b>	<b>\$11,363</b>	<b>\$11,363</b>
2. ANNUAL O&M COSTS (O&M, above)	O&M	<b>\$2,176</b>	<b>\$2,564</b>	<b>\$3,007</b>	<b>\$3,478</b>
<b>*** TOTAL ANNUALIZED COST ***</b>	ACIC+O&M	<b>\$13,539</b>	<b>\$13,927</b>	<b>\$14,371</b>	<b>\$14,842</b>
<b>B. NO<sub>x</sub> REMOVAL PER YEAR</b>					
1. BASELINE NO <sub>x</sub> LEVEL (lb/MMBtu)	(NO <sub>x</sub> )1	0.12	0.12	0.12	0.12
2. CONTROLLED NO <sub>x</sub> LEVEL (lb/MMBtu)	(NO <sub>x</sub> )2	0.07	0.07	0.07	0.07
3. NO <sub>x</sub> REMOVAL EFFICIENCY (%)		40	40	40	40
4. CAPACITY FACTOR	CF	0.8	0.66	0.5	0.33
5. BOILER HEAT INPUT CAPACITY (MMBtu/hr)	CAP	33.5	33.5	33.5	33.5
<b>*** NO<sub>x</sub> REMOVED PER YEAR (TONS/YR) ***</b>					
[CAP*CF*(24 hr/day)*(365 days/yr)]*[(NO <sub>x</sub> )1-(NO <sub>x</sub> )2]/2000		5.6	4.6	3.5	2.3
<b>*** COST EFFECTIVENESS (\$/TON NO<sub>x</sub> REMOVED, 1992 DOLLARS) ***</b>		<b>\$2,404</b>	<b>\$2,998</b>	<b>\$4,083</b>	<b>\$6,390</b>



COST EFFECTIVENESS OF RETROFIT NO <sub>x</sub> CONTROLS					
BOILER TYPE:	PACKAGED WATERTUBE	CHAP. 6 REFERENCES	COST BASE		
BOILER CAPACITY (MMBtu/hr):	50	PEERLESS, 1992	1992 DOLLARS		
FUEL TYPE:	NATURAL GAS				
CONTROL METHOD:	SCR				
TOTAL CAPITAL INVESTMENT COST (TCIC)					
		BOILER CAPACITY FACTOR			
		0.8	0.66	0.5	0.33
<b>A. DIRECT CAPITAL COST (DCC)</b>					
1. PURCHASED EQUIPMENT COST (PEC)					
PRIMARY AND AUXILIARY EQUIPMENT (EQP)	EQP				
CEM SYSTEM					
INSTRUMENTATION					
SALES TAX					
FREIGHT					
*** TOTAL PURCHASED EQUIPMENT COST ***	PEC	\$121,300	\$121,300	\$121,300	\$121,300
2. DIRECT INSTALLATION COST (DIC)					
*** TOTAL DIRECT INSTALLATION COST ***	DIC	\$85,000	\$85,000	\$85,000	\$85,000
3. SITE PREP, SP (as required)	SP				
4. BUILDINGS, BLDG (as required)	BLDG				
*** TOTAL DIRECT CAPITAL COST *** (PEC+DIC+SP+BLDG)	DCC	\$206,300	\$206,300	\$206,300	\$206,300
<b>B. INDIRECT CAPITAL COST (ICC)</b>					
1. ENGINEERING (0.20PEC)		\$24,260	\$24,260	\$24,260	\$24,260
2. CONSTRUCTION AND FIELD EXPENSES (0.20PEC)		\$24,260	\$24,260	\$24,260	\$24,260
3. CONSTRUCTION FEE (0.20PEC)		\$24,260	\$24,260	\$24,260	\$24,260
4. STARTUP (0.04PEC)		\$4,852	\$4,852	\$4,852	\$4,852
5. PERFORMANCE TEST (0.02PEC)		\$2,426	\$2,426	\$2,426	\$2,426
*** TOTAL INDIRECT CAPITAL COST ***	ICC	\$80,058	\$80,058	\$80,058	\$80,058
C. CONTINGENCY (0.20*(DCC+ICC))	CONT	\$57,272	\$57,272	\$57,272	\$57,272
*** TOTAL CAPITAL INVESTMENT COST *** (DCC+ICC+CONT)	TCIC	\$343,630	\$343,630	\$343,630	\$343,630

CONTINUED ON NEXT PAGE

COST EFFECTIVENESS OF RETROFIT NOx CONTROLS						
BOILER TYPE: PACKAGED WATERTUBE		CHAP. 6 REFERENCES		COST BASE		
BOILER CAPACITY (MMBtu/hr): 50		PEERLESS, 1992		1992 DOLLARS		
FUEL TYPE: NATURAL GAS						
CONTROL METHOD: SCR						
ANNUAL OPERATING AND MAINTENANCE COSTS (O&M)						
		CAPACITY FACTOR	0.8	0.66	0.5	0.33
<b>A. DIRECT ANNUAL COSTS (DAC)</b>						
1.	OPERATING LABOR					
2.	MAINTENANCE LABOR (semi-annual inspection)		\$2,000	\$2,000	\$2,000	\$2,000
3.	MAINTENANCE MATERIALS					
4.	REPLACEMENT MATERIALS (catalyst replacement every 3 yrs)		\$16,667	\$16,667	\$16,667	\$16,667
5.	ELECTRICITY @ \$0.05/kw-hr		\$523	\$431	\$327	\$216
6.	STEAM					
7.	FUEL					
8.	WASTE DISPOSAL (catalyst)		\$4,167	\$4,167	\$4,167	\$4,167
9.	CHEMICALS (ammonia @ \$250/ton, 1 lb/hr)		\$876	\$723	\$548	\$361
10.	OTHER					
***	TOTAL DIRECT ANNUAL COSTS ***	DAC	\$24,232	\$23,987	\$23,708	\$23,410
<b>B. INDIRECT ANNUAL COSTS (IAC)</b>						
1.	OVERHEAD (60% OF SUM OF ALL LABOR AND MAINTENANCE MATERIALS)		\$1,200	\$1,200	\$1,200	\$1,200
2.	ADMINISTRATIVE (0.02*TCIC)		\$6,873	\$6,873	\$6,873	\$6,873
3.	PROPERTY TAX (0.01*TCIC)		\$3,436	\$3,436	\$3,436	\$3,436
4.	INSURANCE (0.01*TCIC)		\$3,436	\$3,436	\$3,436	\$3,436
***	TOTAL INDIRECT ANNUAL COSTS ***	IAC	\$14,945	\$14,945	\$14,945	\$14,945
***	TOTAL ANNUAL OPERATING AND MAINTENANCE COSTS *** (DAC+IAC)	O&M	\$39,177	\$38,933	\$38,653	\$38,356
COST EFFECTIVENESS						
<b>A. TOTAL ANNUALIZED COST (incl. capital and O&amp;M)</b>						
1.	ANNUALIZED CAPITAL INVESTMENT COST (ACIC)					
EXPECTED LIFETIME OF EQUIPMENT, YEARS			10	10	10	10
INTEREST RATE			0.1	0.1	0.1	0.1
CAPITAL RECOVERY FACTOR			0.1627	0.1627	0.1627	0.1627
TOTAL CAPITAL INVESTMENT COSTS (TCIC, above)			\$343,630	\$343,630	\$343,630	\$343,630
***	ANNUALIZED CAPITAL INVESTMENT COST ***	ACIC	\$55,924	\$55,924	\$55,924	\$55,924
2.	ANNUAL O&M COSTS (O&M, above)	O&M	\$39,177	\$38,933	\$38,653	\$38,356
***	TOTAL ANNUALIZED COST ***	ACIC+O&M	\$95,101	\$94,857	\$94,577	\$94,280
<b>B. NOx REMOVAL PER YEAR</b>						
1.	BASELINE NOx LEVEL (lb/MMBtu)	(NOx)1	0.16	0.16	0.16	0.16
2.	CONTROLLED NOx LEVEL (lb/MMBtu)	(NOx)2	0.02	0.02	0.02	0.02
3.	NOx REMOVAL EFFICIENCY (%)		85	85	85	85
4.	CAPACITY FACTOR	CF	0.8	0.66	0.5	0.33
5.	BOILER HEAT INPUT CAPACITY (MMBtu/hr)	CAP	50	50	50	50
***	NOx REMOVED PER YEAR (TONS/YR) ***					
[CAP*CF*(24 hr/day)*(365 days/yr)]*[(NOx)1-(NOx)2]/2000			23.8	19.7	14.9	9.8
***	COST EFFECTIVENESS (\$/TON NOx REMOVED, 1992 DOLLARS) ***		\$3,991	\$4,825	\$6,351	\$9,592

COST EFFECTIVENESS OF RETROFIT NO <sub>x</sub> CONTROLS					
BOILER TYPE: PACKAGED WATERTUBE		CHAP. 6 REFERENCES		COST BASE	
BOILER CAPACITY (MMBtu/hr): 100		PEERLESS, 1992		1992 DOLLARS	
FUEL TYPE: NATURAL GAS					
CONTROL METHOD: SCR					
TOTAL CAPITAL INVESTMENT COST (TCIC)					
		BOILER CAPACITY FACTOR			
		0.8	0.66	0.5	0.33
<b>A. DIRECT CAPITAL COST (DCC)</b>					
1. PURCHASED EQUIPMENT COST (PEC)					
PRIMARY AND AUXILIARY EQUIPMENT (EOP)		EQP			
CEM SYSTEM					
INSTRUMENTATION					
SALES TAX					
FREIGHT					
*** TOTAL PURCHASED EQUIPMENT COST ***		PEC	\$152,600	\$152,600	\$152,600
2. DIRECT INSTALLATION COST (DIC)					
*** TOTAL DIRECT INSTALLATION COST ***		DIC	\$107,000	\$107,000	\$107,000
3. SITE PREP, SP (as required)		SP			
4. BUILDINGS, BLDG (as required)		BLDG			
*** TOTAL DIRECT CAPITAL COST *** (PEC+DIC+SP+BLDG)		DCC	\$259,600	\$259,600	\$259,600
<b>B. INDIRECT CAPITAL COST (ICC)</b>					
1. ENGINEERING (0.20PEC)			\$30,520	\$30,520	\$30,520
2. CONSTRUCTION AND FIELD EXPENSES (0.20PEC)			\$30,520	\$30,520	\$30,520
3. CONSTRUCTION FEE (0.20PEC)			\$30,520	\$30,520	\$30,520
4. STARTUP (0.04PEC)			\$6,104	\$6,104	\$6,104
5. PERFORMANCE TEST (0.02PEC)			\$3,052	\$3,052	\$3,052
*** TOTAL INDIRECT CAPITAL COST ***		ICC	\$100,716	\$100,716	\$100,716
<b>C. CONTINGENCY (0.20*(DCC+ICC))</b>		CONT	\$72,063	\$72,063	\$72,063
*** TOTAL CAPITAL INVESTMENT COST *** (DCC+ICC+CONT)		TCIC	\$432,379	\$432,379	\$432,379

CONTINUED ON NEXT PAGE

COST EFFECTIVENESS OF RETROFIT NO <sub>x</sub> CONTROLS						
BOILER TYPE:	PACKAGED WATERTUBE	CHAP. 6 REFERENCES	COST BASE			
BOILER CAPACITY (MMBtu/hr):	100	PEERLESS, 1992	1992 DOLLARS			
FUEL TYPE:	NATURAL GAS					
CONTROL METHOD:	SCR					
ANNUAL OPERATING AND MAINTENANCE COSTS (O&M)						
	CAPACITY FACTOR	0.8	0.66	0.5	0.33	
A. DIRECT ANNUAL COSTS (DAC)						
1.	OPERATING LABOR					
2.	MAINTENANCE LABOR (semi-annual inspection)	\$2,000	\$2,000	\$2,000	\$2,000	
3.	MAINTENANCE MATERIALS					
4.	REPLACEMENT MATERIALS (catalyst replacement every 3 yrs)	\$33,333	\$33,333	\$33,333	\$33,333	
5.	ELECTRICITY @ \$0.05/kW-hr	\$523	\$431	\$327	\$216	
6.	STEAM					
7.	FUEL					
8.	WASTE DISPOSAL (catalyst)	\$8,333	\$8,333	\$8,333	\$8,333	
9.	CHEMICALS (ammonia @ \$250/ton, 2.1 lb/hr)	\$1,840	\$1,518	\$1,150	\$759	
10.	OTHER					
***	TOTAL DIRECT ANNUAL COSTS ***	DAC	\$46,029	\$45,616	\$45,143	\$44,641
B. INDIRECT ANNUAL COSTS (IAC)						
1.	OVERHEAD (60% OF SUM OF ALL LABOR AND MAINTENANCE MATERIALS)	\$1,200	\$1,200	\$1,200	\$1,200	
2.	ADMINISTRATIVE (0.02*TCIC)	\$8,648	\$8,648	\$8,648	\$8,648	
3.	PROPERTY TAX (0.01*TCIC)	\$4,324	\$4,324	\$4,324	\$4,324	
4.	INSURANCE (0.01*TCIC)	\$4,324	\$4,324	\$4,324	\$4,324	
***	TOTAL INDIRECT ANNUAL COSTS ***	IAC	\$18,495	\$18,495	\$18,495	\$18,495
***	TOTAL ANNUAL OPERATING AND MAINTENANCE COSTS ***	O&M	\$64,524	\$64,111	\$63,638	\$63,136
COST EFFECTIVENESS						
A. TOTAL ANNUALIZED COST (incl. capital and O&M)						
1.	ANNUALIZED CAPITAL INVESTMENT COST (ACIC)					
	EXPECTED LIFETIME OF EQUIPMENT, YEARS	10	10	10	10	
	INTEREST RATE	0.1	0.1	0.1	0.1	
	CAPITAL RECOVERY FACTOR	0.1627	0.1627	0.1627	0.1627	
	TOTAL CAPITAL INVESTMENT COSTS (TCIC, above)	\$432,379	\$432,379	\$432,379	\$432,379	
***	ANNUALIZED CAPITAL INVESTMENT COST ***	ACIC	\$70,368	\$70,368	\$70,368	\$70,368
2.	ANNUAL O&M COSTS (O&M, above)	O&M	\$64,524	\$64,111	\$63,638	\$63,136
***	TOTAL ANNUALIZED COST ***	ACIC+O&M	\$134,892	\$134,479	\$134,006	\$133,504
B. NO <sub>x</sub> REMOVAL PER YEAR						
1.	BASELINE NO <sub>x</sub> LEVEL (lb/MMBtu)	(NO <sub>x</sub> )1	0.18	0.18	0.18	0.18
2.	CONTROLLED NO <sub>x</sub> LEVEL (lb/MMBtu)	(NO <sub>x</sub> )2	0.03	0.03	0.03	0.03
3.	NO <sub>x</sub> REMOVAL EFFICIENCY (%)		85	85	85	85
4.	CAPACITY FACTOR	CF	0.8	0.66	0.5	0.33
5.	BOILER HEAT INPUT CAPACITY (MMBtu/hr)	CAP	100	100	100	100
***	NO <sub>x</sub> REMOVED PER YEAR (TONS/YR) ***					
	[CAP*CF*(24 hr/day)*(365 days/yr)]*[(NO <sub>x</sub> )1-(NO <sub>x</sub> )2]/2000		53.6	44.2	33.5	22.1
***	COST EFFECTIVENESS (\$/TON NO <sub>x</sub> REMOVED, 1992 DOLLARS) ***		\$2,516	\$3,040	\$3,999	\$6,037

COST EFFECTIVENESS OF RETROFIT NOx CONTROLS					
BOILER TYPE:	PACKAGED WATERTUBE	CHAP. 6 REFERENCES	COST BASE		
BOILER CAPACITY (MMBtu/hr):	100	DAMON, 1987	1992 DOLLARS		
FUEL TYPE:	NATURAL GAS				
CONTROL METHOD:	SCR				
TOTAL CAPITAL INVESTMENT COST (TCIC)					
		BOILER CAPACITY FACTOR			
		0.8	0.66	0.5	0.33
<b>A. DIRECT CAPITAL COST (DCC)</b>					
1. PURCHASED EQUIPMENT COST (PEC)					
PRIMARY AND AUXILIARY EQUIPMENT (EQP)	EQP				
CEM SYSTEM					
INSTRUMENTATION					
SALES TAX					
FREIGHT					
*** TOTAL PURCHASED EQUIPMENT COST ***	PEC				
2. DIRECT INSTALLATION COST (DIC)					
*** TOTAL DIRECT INSTALLATION COST ***	DIC				
3. SITE PREP. SP (as required)	SP				
4. BUILDINGS, BLDG (as required)	BLDG				
*** TOTAL DIRECT CAPITAL COST ***	DCC				
(PEC+DIC+SP+BLDG)					
<b>B. INDIRECT CAPITAL COST (ICC)</b>					
1. ENGINEERING					
2. CONSTRUCTION AND FIELD EXPENSES					
3. CONSTRUCTION FEE					
4. STARTUP					
5. PERFORMANCE TEST					
*** TOTAL INDIRECT CAPITAL COST ***	ICC				
<b>C. CONTINGENCY</b>					
*** TOTAL CAPITAL INVESTMENT COST ***	TCIC	\$492,271	\$492,271	\$492,271	\$492,271
(DCC+ICC+CONT)					

CONTINUED ON NEXT PAGE

COST EFFECTIVENESS OF RETROFIT NOx CONTROLS						
BOILER TYPE: PACKAGED WATERTUBE		CHAP. 6 REFERENCES		COST BASE		
BOILER CAPACITY (MMBtu/hr): 100		DAMON, 1987		1992 DOLLARS		
FUEL TYPE: NATURAL GAS						
CONTROL METHOD: SCR						
ANNUAL OPERATING AND MAINTENANCE COSTS (O&M)						
		CAPACITY FACTOR	0.8	0.66	0.5	0.33
A. DIRECT ANNUAL COSTS (DAC)						
1.	OPERATING LABOR					
2.	MAINTENANCE LABOR					
3.	MAINTENANCE MATERIALS					
4.	REPLACEMENT MATERIALS (catalyst replacement every 2 yrs)		\$54,675	\$54,675	\$54,675	\$54,675
5.	ELECTRICITY @ \$0.05/kW-hr		\$6,700	\$6,700	\$6,700	\$6,700
6.	STEAM					
7.	FUEL					
8.	WASTE DISPOSAL (catalyst)		\$13,669	\$13,669	\$13,669	\$13,669
9.	CHEMICALS (ammonia @ \$250/ton)		\$4,400	\$4,400	\$4,400	\$4,400
10.	OTHER					
***	TOTAL DIRECT ANNUAL COSTS ***	DAC	\$79,444	\$79,444	\$79,444	\$79,444
B. INDIRECT ANNUAL COSTS (IAC)						
1.	OVERHEAD (60% OF SUM OF ALL LABOR AND MAINTENANCE MATERIALS)		\$0	\$0	\$0	\$0
2.	ADMINISTRATIVE (0.02*TCIC)		\$9,845	\$9,845	\$9,845	\$9,845
3.	PROPERTY TAX (0.01*TCIC)		\$4,923	\$4,923	\$4,923	\$4,923
4.	INSURANCE (0.01*TCIC)		\$4,923	\$4,923	\$4,923	\$4,923
***	TOTAL INDIRECT ANNUAL COSTS ***	IAC	\$19,691	\$19,691	\$19,691	\$19,691
***	TOTAL ANNUAL OPERATING AND MAINTENANCE COSTS ***	O&M	\$99,135	\$99,135	\$99,135	\$99,135
			(DAC+IAC)			
COST EFFECTIVENESS						
A. TOTAL ANNUALIZED COST (incl. capital and O&M)						
1.	ANNUALIZED CAPITAL INVESTMENT COST (ACIC)					
	EXPECTED LIFETIME OF EQUIPMENT, YEARS		10	10	10	10
	INTEREST RATE		0.1	0.1	0.1	0.1
	CAPITAL RECOVERY FACTOR		0.1627	0.1627	0.1627	0.1627
	TOTAL CAPITAL INVESTMENT COSTS (TCIC, above)		\$492,271	\$492,271	\$492,271	\$492,271
***	ANNUALIZED CAPITAL INVESTMENT COST ***	ACIC	\$80,115	\$80,115	\$80,115	\$80,115
2.	ANNUAL O&M COSTS (O&M, above)	O&M	\$99,135	\$99,135	\$99,135	\$99,135
***	TOTAL ANNUALIZED COST ***	ACIC+O&M	\$179,249	\$179,249	\$179,249	\$179,249
B. NOx REMOVAL PER YEAR						
1.	BASELINE NOx LEVEL (lb/MMBtu)	(NOx)1	0.18	0.18	0.18	0.18
2.	CONTROLLED NOx LEVEL (lb/MMBtu)	(NOx)2	0.03	0.03	0.03	0.03
3.	NOx REMOVAL EFFICIENCY (%)		85	85	85	85
4.	CAPACITY FACTOR	CF	0.8	0.66	0.5	0.33
5.	BOILER HEAT INPUT CAPACITY (MMBtu/hr)	CAP	100	100	100	100
***	NOx REMOVED PER YEAR (TONS/YR) ***					
	[CAP*CF*(24 hr/day)*(365 days/yr)]*[(NOx)1-(NOx)2]/2000		53.6	44.2	33.5	22.1
***	COST EFFECTIVENESS (\$/TON NOx REMOVED, 1992 DOLLARS) ***		\$3,344	\$4,053	\$5,350	\$8,105

COST EFFECTIVENESS OF RETROFIT NOx CONTROLS					
BOILER TYPE:	PACKAGED WATERTUBE	CHAP. 6 REFERENCES	COST BASE		
BOILER CAPACITY (MMBtu/hr):	150	PEERLESS, 1992	1992 DOLLARS		
FUEL TYPE:	NATURAL GAS				
CONTROL METHOD:	SCR				
TOTAL CAPITAL INVESTMENT COST (TCIC)					
		BOILER CAPACITY FACTOR			
		0.8	0.66	0.5	0.33
<b>A. DIRECT CAPITAL COST (DCC)</b>					
1. PURCHASED EQUIPMENT COST (PEC)					
PRIMARY AND AUXILIARY EQUIPMENT (EQP)	EQP				
CEM SYSTEM					
INSTRUMENTATION					
SALES TAX					
FREIGHT					
*** TOTAL PURCHASED EQUIPMENT COST ***	PEC	\$190,997	\$190,997	\$190,997	\$190,997
2. DIRECT INSTALLATION COST (DIC)					
*** TOTAL DIRECT INSTALLATION COST ***	DIC	\$133,643	\$133,643	\$133,643	\$133,643
3. SITE PREP, SP (as required)	SP				
4. BUILDINGS, BLDG (as required)	BLDG				
*** TOTAL DIRECT CAPITAL COST *** (PEC+DIC+SP+BLDG)	DCC	\$324,640	\$324,640	\$324,640	\$324,640
<b>B. INDIRECT CAPITAL COST (ICC)</b>					
1. ENGINEERING (0.20PEC)		\$38,199	\$38,199	\$38,199	\$38,199
2. CONSTRUCTION AND FIELD EXPENSES (0.20PEC)		\$38,199	\$38,199	\$38,199	\$38,199
3. CONSTRUCTION FEE (0.20PEC)		\$38,199	\$38,199	\$38,199	\$38,199
4. STARTUP (0.04PEC)		\$7,640	\$7,640	\$7,640	\$7,640
5. PERFORMANCE TEST (0.02PEC)		\$3,820	\$3,820	\$3,820	\$3,820
*** TOTAL INDIRECT CAPITAL COST ***	ICC	\$126,058	\$126,058	\$126,058	\$126,058
<b>C. CONTINGENCY (0.20*(DCC+ICC))</b>					
*** TOTAL CAPITAL INVESTMENT COST *** (DCC+ICC+CONT)	TCIC	\$540,838	\$540,838	\$540,838	\$540,838

CONTINUED ON NEXT PAGE

COST EFFECTIVENESS OF RETROFIT NO <sub>x</sub> CONTROLS						
BOILER TYPE: PACKAGED WATERTUBE		CHAP. 6 REFERENCES		COST BASE		
BOILER CAPACITY (MMBtu/hr): 150		PEERLESS, 1992		1992 DOLLARS		
FUEL TYPE: NATURAL GAS						
CONTROL METHOD: SCR						
ANNUAL OPERATING AND MAINTENANCE COSTS (O&M)						
		CAPACITY FACTOR	0.8	0.66	0.5	0.33
A. DIRECT ANNUAL COSTS (DAC)						
1. OPERATING LABOR						
2. MAINTENANCE LABOR (semi-annual inspection)			\$2,000	\$2,000	\$2,000	\$2,000
3. MAINTENANCE MATERIALS						
4. REPLACEMENT MATERIALS (catalyst replacement every 3 yrs)			\$50,000	\$50,000	\$50,000	\$50,000
5. ELECTRICITY @ \$0.05/kw-hr			\$523	\$431	\$327	\$216
6. STEAM						
7. FUEL						
8. WASTE DISPOSAL (catalyst)			\$12,500	\$12,500	\$12,500	\$12,500
9. CHEMICALS (ammonia @ \$250/ton, 3.3 lb/hr)			\$2,891	\$2,385	\$1,807	\$1,192
10. OTHER						
*** TOTAL DIRECT ANNUAL COSTS ***		DAC	\$67,914	\$67,316	\$66,633	\$65,908
B. INDIRECT ANNUAL COSTS (IAC)						
1. OVERHEAD (60% OF SUM OF ALL LABOR AND MAINTENANCE MATERIALS)			\$1,200	\$1,200	\$1,200	\$1,200
2. ADMINISTRATIVE (0.02*TCIC)			\$10,817	\$10,817	\$10,817	\$10,817
3. PROPERTY TAX (0.01*TCIC)			\$5,408	\$5,408	\$5,408	\$5,408
4. INSURANCE (0.01*TCIC)			\$5,408	\$5,408	\$5,408	\$5,408
*** TOTAL INDIRECT ANNUAL COSTS ***		IAC	\$22,834	\$22,834	\$22,834	\$22,834
*** TOTAL ANNUAL OPERATING AND MAINTENANCE COSTS *** (DAC+IAC)		O&M	\$90,747	\$90,150	\$89,467	\$88,742
COST EFFECTIVENESS						
A. TOTAL ANNUALIZED COST (incl. capital and O&M)						
1. ANNUALIZED CAPITAL INVESTMENT COST (ACIC)						
EXPECTED LIFETIME OF EQUIPMENT, YEARS			10	10	10	10
INTEREST RATE			0.1	0.1	0.1	0.1
CAPITAL RECOVERY FACTOR			0.1627	0.1627	0.1627	0.1627
TOTAL CAPITAL INVESTMENT COSTS (TCIC, above)			\$540,838	\$540,838	\$540,838	\$540,838
*** ANNUALIZED CAPITAL INVESTMENT COST ***		ACIC	\$88,019	\$88,019	\$88,019	\$88,019
2. ANNUAL O&M COSTS (O&M, above)		O&M	\$90,747	\$90,150	\$89,467	\$88,742
*** TOTAL ANNUALIZED COST ***		ACIC+O&M	\$178,766	\$178,169	\$177,486	\$176,761
B. NO <sub>x</sub> REMOVAL PER YEAR						
1. BASELINE NO <sub>x</sub> LEVEL (lb/MMBtu)		(NO <sub>x</sub> )1	0.18	0.18	0.18	0.18
2. CONTROLLED NO <sub>x</sub> LEVEL (lb/MMBtu)		(NO <sub>x</sub> )2	0.03	0.03	0.03	0.03
3. NO <sub>x</sub> REMOVAL EFFICIENCY (%)			85	85	85	85
4. CAPACITY FACTOR		CF	0.8	0.66	0.5	0.33
5. BOILER HEAT INPUT CAPACITY (MMBtu/hr)		CAP	150	150	150	150
*** NO <sub>x</sub> REMOVED PER YEAR (TONS/YR) ***						
[CAP*CF*(24 hr/day)*(365 days/yr)]*[(NO <sub>x</sub> )1-(NO <sub>x</sub> )2]/2000			80.4	66.3	50.3	33.2
*** COST EFFECTIVENESS (\$/TON NO <sub>x</sub> REMOVED, 1992 DOLLARS) ***			\$2,223	\$2,686	\$3,531	\$5,329



COST EFFECTIVENESS OF RETROFIT NOx CONTROLS					
BOILER TYPE: PACKAGED WATERTUBE	CHAP. 6 REFERENCES		COST BASE		
BOILER CAPACITY (MMBtu/hr): 200	PEERLESS, 1992		1992 DOLLARS		
FUEL TYPE: NATURAL GAS					
CONTROL METHOD: SCR					
TOTAL CAPITAL INVESTMENT COST (TCIC)					
		BOILER CAPACITY FACTOR			
		0.8	0.66	0.5	0.33
<b>A. DIRECT CAPITAL COST (DCC)</b>					
1. PURCHASED EQUIPMENT COST (PEC)					
PRIMARY AND AUXILIARY EQUIPMENT (EQP)	EQP				
CEM SYSTEM					
INSTRUMENTATION					
SALES TAX					
FREIGHT					
*** TOTAL PURCHASED EQUIPMENT COST ***	PEC	\$230,900	\$230,900	\$230,900	\$230,900
2. DIRECT INSTALLATION COST (DIC)					
*** TOTAL DIRECT INSTALLATION COST ***	DIC	\$161,600	\$161,600	\$161,600	\$161,600
3. SITE PREP, SP (as required)	SP				
4. BUILDINGS, BLDG (as required)	BLDG				
*** TOTAL DIRECT CAPITAL COST *** (PEC+DIC+SP+BLDG)	DCC	\$392,500	\$392,500	\$392,500	\$392,500
<b>B. INDIRECT CAPITAL COST (ICC)</b>					
1. ENGINEERING (0.20PEC)		\$46,180	\$46,180	\$46,180	\$46,180
2. CONSTRUCTION AND FIELD EXPENSES (0.20PEC)		\$46,180	\$46,180	\$46,180	\$46,180
3. CONSTRUCTION FEE (0.20PEC)		\$46,180	\$46,180	\$46,180	\$46,180
4. STARTUP (0.04PEC)		\$9,236	\$9,236	\$9,236	\$9,236
5. PERFORMANCE TEST (0.02PEC)		\$4,618	\$4,618	\$4,618	\$4,618
*** TOTAL INDIRECT CAPITAL COST ***	ICC	\$152,394	\$152,394	\$152,394	\$152,394
<b>C. CONTINGENCY (0.20*(DCC+ICC))</b>					
	CONT	\$108,979	\$108,979	\$108,979	\$108,979
*** TOTAL CAPITAL INVESTMENT COST *** (DCC+ICC+CONT)	TCIC	\$653,873	\$653,873	\$653,873	\$653,873

CONTINUED ON NEXT PAGE

COST EFFECTIVENESS OF RETROFIT NOx CONTROLS						
BOILER TYPE: PACKAGED WATERTUBE		CHAP. 6 REFERENCES		COST BASE		
BOILER CAPACITY (MMBtu/hr): 200		PEERLESS, 1992		1992 DOLLARS		
FUEL TYPE: NATURAL GAS						
CONTROL METHOD: SCR						
ANNUAL OPERATING AND MAINTENANCE COSTS (O&M)						
		CAPACITY FACTOR	0.8	0.66	0.5	0.33
A. DIRECT ANNUAL COSTS (DAC)						
1. OPERATING LABOR						
2. MAINTENANCE LABOR (semi-annual inspection)			\$2,000	\$2,000	\$2,000	\$2,000
3. MAINTENANCE MATERIALS						
4. REPLACEMENT MATERIALS (catalyst replacement every 3 yrs)			\$66,667	\$66,667	\$66,667	\$66,667
5. ELECTRICITY @ \$0.05/kW-hr			\$523	\$431	\$327	\$216
6. STEAM						
7. FUEL						
8. WASTE DISPOSAL (catalyst)			\$16,667	\$16,667	\$16,667	\$16,667
9. CHEMICALS (ammonia @ \$250/ton, 4.4 lb/hr)			\$3,854	\$3,180	\$2,409	\$1,590
10. OTHER						
*** TOTAL DIRECT ANNUAL COSTS ***		DAC	\$89,711	\$88,945	\$88,069	\$87,139
B. INDIRECT ANNUAL COSTS (IAC)						
1. OVERHEAD (60% OF SUM OF ALL LABOR AND MAINTENANCE MATERIALS)			\$1,200	\$1,200	\$1,200	\$1,200
2. ADMINISTRATIVE (0.02*TCIC)			\$13,077	\$13,077	\$13,077	\$13,077
3. PROPERTY TAX (0.01*TCIC)			\$6,539	\$6,539	\$6,539	\$6,539
4. INSURANCE (0.01*TCIC)			\$6,539	\$6,539	\$6,539	\$6,539
*** TOTAL INDIRECT ANNUAL COSTS ***		IAC	\$27,355	\$27,355	\$27,355	\$27,355
*** TOTAL ANNUAL OPERATING AND MAINTENANCE COSTS *** (DAC+IAC)		O&M	\$117,065	\$116,299	\$115,424	\$114,494
COST EFFECTIVENESS						
A. TOTAL ANNUALIZED COST (incl. capital and O&M)						
1. ANNUALIZED CAPITAL INVESTMENT COST (ACIC)						
EXPECTED LIFETIME OF EQUIPMENT, YEARS			10	10	10	10
INTEREST RATE			0.1	0.1	0.1	0.1
CAPITAL RECOVERY FACTOR			0.1627	0.1627	0.1627	0.1627
TOTAL CAPITAL INVESTMENT COSTS (TCIC, above)			\$653,873	\$653,873	\$653,873	\$653,873
*** ANNUALIZED CAPITAL INVESTMENT COST ***		ACIC	\$106,415	\$106,415	\$106,415	\$106,415
2. ANNUAL O&M COSTS (O&M, above)		O&M	\$117,065	\$116,299	\$115,424	\$114,494
*** TOTAL ANNUALIZED COST ***		ACIC+O&M	\$223,480	\$222,714	\$221,839	\$220,909
B. NOx REMOVAL PER YEAR						
1. BASELINE NOx LEVEL (lb/MMBtu)		(NOx)1	0.24	0.24	0.24	0.24
2. CONTROLLED NOx LEVEL (lb/MMBtu)		(NOx)2	0.04	0.04	0.04	0.04
3. NOx REMOVAL EFFICIENCY (%)			85	85	85	85
4. CAPACITY FACTOR		CF	0.8	0.66	0.5	0.33
5. BOILER HEAT INPUT CAPACITY (MMBtu/hr)		CAP	200	200	200	200
*** NOx REMOVED PER YEAR (TONS/YR) ***						
[CAP*CF*(24 hr/day)*(365 days/yr)]*[(NOx)1-(NOx)2]/2000			143.0	117.9	89.4	59.0
*** COST EFFECTIVENESS (\$/TON NOx REMOVED, 1992 DOLLARS) ***			\$1,563	\$1,888	\$2,483	\$3,746

COST EFFECTIVENESS OF RETROFIT NO <sub>x</sub> CONTROLS					
BOILER TYPE: FIELD ERECTED WATERTUBE		CHAP. 6 REFERENCES		COST BASE	
BOILER CAPACITY (MMBtu/hr): 250		PEERLESS, 1992		1992 DOLLARS	
FUEL TYPE: NATURAL GAS					
CONTROL METHOD: SCR					
TOTAL CAPITAL INVESTMENT COST (TCIC)					
		BOILER CAPACITY FACTOR			
		0.8	0.66	0.5	0.33
<b>A. DIRECT CAPITAL COST (DCC)</b>					
1. PURCHASED EQUIPMENT COST (PEC)					
PRIMARY AND AUXILIARY EQUIPMENT (EQP)		EQP			
CEM SYSTEM					
INSTRUMENTATION					
SALES TAX					
FREIGHT					
*** TOTAL PURCHASED EQUIPMENT COST ***		PEC	\$270,100	\$270,100	\$270,100
2. DIRECT INSTALLATION COST (DIC)					
*** TOTAL DIRECT INSTALLATION COST ***		DIC	\$189,000	\$189,000	\$189,000
3. SITE PREP, SP (as required)		SP			
4. BUILDINGS, BLDG (as required)		BLDG			
*** TOTAL DIRECT CAPITAL COST ***		DCC	\$459,100	\$459,100	\$459,100
(PEC+DIC+SP+BLDG)					
<b>B. INDIRECT CAPITAL COST (ICC)</b>					
1. ENGINEERING (0.20PEC)			\$54,020	\$54,020	\$54,020
2. CONSTRUCTION AND FIELD EXPENSES (0.20PEC)			\$54,020	\$54,020	\$54,020
3. CONSTRUCTION FEE (0.20PEC)			\$54,020	\$54,020	\$54,020
4. STARTUP (0.04PEC)			\$10,804	\$10,804	\$10,804
5. PERFORMANCE TEST (0.02PEC)			\$5,402	\$5,402	\$5,402
*** TOTAL INDIRECT CAPITAL COST ***		ICC	\$178,266	\$178,266	\$178,266
<b>C. CONTINGENCY (0.20*(DCC+ICC))</b>		CONT	\$127,473	\$127,473	\$127,473
*** TOTAL CAPITAL INVESTMENT COST ***		TCIC	\$764,839	\$764,839	\$764,839
(DCC+ICC+CONT)					

CONTINUED ON NEXT PAGE

COST EFFECTIVENESS OF RETROFIT NOx CONTROLS						
BOILER TYPE:	FIELD ERECTED WATERTUBE	CHAP. 6 REFERENCES	COST BASE			
BOILER CAPACITY (MMBtu/hr):	250	PEERLESS, 1992	1992 DOLLARS			
FUEL TYPE:	NATURAL GAS					
CONTROL METHOD:	SCR					
<b>ANNUAL OPERATING AND MAINTENANCE COSTS (O&amp;M)</b>						
	CAPACITY FACTOR	0.8	0.66	0.5	0.33	
<b>A. DIRECT ANNUAL COSTS (DAC)</b>						
1.	OPERATING LABOR					
2.	MAINTENANCE LABOR (semi-annual inspection)	\$2,000	\$2,000	\$2,000	\$2,000	
3.	MAINTENANCE MATERIALS					
4.	REPLACEMENT MATERIALS (catalyst replacement every 3 yrs)	\$83,333	\$83,333	\$83,333	\$83,333	
5.	ELECTRICITY @ \$0.05/kw-hr	\$523	\$431	\$327	\$216	
6.	STEAM					
7.	FUEL					
8.	WASTE DISPOSAL (catalyst)	\$20,833	\$20,833	\$20,833	\$20,833	
9.	CHEMICALS (ammonia @ \$250/ton, 5.5 lb/hr)	\$4,818	\$3,975	\$3,011	\$1,987	
10.	OTHER					
***	TOTAL DIRECT ANNUAL COSTS ***	DAC	\$111,507	\$110,573	\$109,505	\$108,370
<b>B. INDIRECT ANNUAL COSTS (IAC)</b>						
1.	OVERHEAD (60% OF SUM OF ALL LABOR AND MAINTENANCE MATERIALS)	\$1,200	\$1,200	\$1,200	\$1,200	
2.	ADMINISTRATIVE (0.02*TCIC)	\$15,297	\$15,297	\$15,297	\$15,297	
3.	PROPERTY TAX (0.01*TCIC)	\$7,648	\$7,648	\$7,648	\$7,648	
4.	INSURANCE (0.01*TCIC)	\$7,648	\$7,648	\$7,648	\$7,648	
***	TOTAL INDIRECT ANNUAL COSTS ***	IAC	\$31,794	\$31,794	\$31,794	\$31,794
***	TOTAL ANNUAL OPERATING AND MAINTENANCE COSTS ***	O&M	\$143,301	\$142,366	\$141,298	\$140,163
<b>COST EFFECTIVENESS</b>						
<b>A. TOTAL ANNUALIZED COST (incl. capital and O&amp;M)</b>						
1.	ANNUALIZED CAPITAL INVESTMENT COST (ACIC)					
	EXPECTED LIFETIME OF EQUIPMENT, YEARS	10	10	10	10	
	INTEREST RATE	0.1	0.1	0.1	0.1	
	CAPITAL RECOVERY FACTOR	0.1627	0.1627	0.1627	0.1627	
	TOTAL CAPITAL INVESTMENT COSTS (TCIC, above)	\$764,839	\$764,839	\$764,839	\$764,839	
***	ANNUALIZED CAPITAL INVESTMENT COST ***	ACIC	\$124,474	\$124,474	\$124,474	\$124,474
2.	ANNUAL O&M COSTS (O&M, above)	O&M	\$143,301	\$142,366	\$141,298	\$140,163
***	TOTAL ANNUALIZED COST ***	ACIC+O&M	\$267,775	\$266,840	\$265,772	\$264,637
<b>B. NOx REMOVAL PER YEAR</b>						
1.	BASELINE NOx LEVEL (lb/MMBtu)	(NOx)1	0.24	0.24	0.24	0.24
2.	CONTROLLED NOx LEVEL (lb/MMBtu)	(NOx)2	0.04	0.04	0.04	0.04
3.	NOx REMOVAL EFFICIENCY (%)		85	85	85	85
4.	CAPACITY FACTOR	CF	0.8	0.66	0.5	0.33
5.	BOILER HEAT INPUT CAPACITY (MMBtu/hr)	CAP	250	250	250	250
***	NOx REMOVED PER YEAR (TONS/YR) ***					
	[CAP*CF*(24 hr/day)*(365 days/yr)]*[(NOx)1-(NOx)2]/2000		178.7	147.4	111.7	73.7
***	COST EFFECTIVENESS (\$/TON NOx REMOVED, 1992 DOLLARS) ***		\$1,498	\$1,810	\$2,380	\$3,590

COST EFFECTIVENESS OF RETROFIT NOx CONTROLS					
BOILER TYPE: PACKAGED WATERTUBE		CHAP. 6 REFERENCES		COST BASE	
BOILER CAPACITY (MMBtu/hr): 50		PEERLESS, 1992		1992 DOLLARS	
FUEL TYPE: NATURAL GAS					
CONTROL METHOD: SCR - VARIABLE CATALYST LIFE					
TOTAL CAPITAL INVESTMENT COST (TCIC)					
		BOILER CAPACITY FACTOR			
		0.8	0.66	0.5	0.33
<b>A. DIRECT CAPITAL COST (DCC)</b>					
1. PURCHASED EQUIPMENT COST (PEC)					
PRIMARY AND AUXILIARY EQUIPMENT (EQP)	EQP				
CEM SYSTEM					
INSTRUMENTATION					
SALES TAX					
FREIGHT					
*** TOTAL PURCHASED EQUIPMENT COST ***	PEC	\$121,300	\$121,300	\$121,300	\$121,300
2. DIRECT INSTALLATION COST (DIC)					
*** TOTAL DIRECT INSTALLATION COST ***	DIC	\$85,000	\$85,000	\$85,000	\$85,000
3. SITE PREP, SP (as required)	SP				
4. BUILDINGS, BLDG (as required)	BLDG				
*** TOTAL DIRECT CAPITAL COST *** (PEC+DIC+SP+BLDG)	DCC	\$206,300	\$206,300	\$206,300	\$206,300
<b>B. INDIRECT CAPITAL COST (ICC)</b>					
1. ENGINEERING (0.20PEC)		\$24,260	\$24,260	\$24,260	\$24,260
2. CONSTRUCTION AND FIELD EXPENSES (0.20PEC)		\$24,260	\$24,260	\$24,260	\$24,260
3. CONSTRUCTION FEE (0.20PEC)		\$24,260	\$24,260	\$24,260	\$24,260
4. STARTUP (0.04PEC)		\$4,852	\$4,852	\$4,852	\$4,852
5. PERFORMANCE TEST (0.02PEC)		\$2,426	\$2,426	\$2,426	\$2,426
*** TOTAL INDIRECT CAPITAL COST ***	ICC	\$80,058	\$80,058	\$80,058	\$80,058
C. CONTINGENCY (0.20*(DCC+ICC))	CONT	\$57,272	\$57,272	\$57,272	\$57,272
*** TOTAL CAPITAL INVESTMENT COST *** (DCC+ICC+CONT)	TCIC	\$343,630	\$343,630	\$343,630	\$343,630

CONTINUED ON NEXT PAGE

COST EFFECTIVENESS OF RETROFIT NOx CONTROLS					
BOILER TYPE: PACKAGED WATERTUBE	CHAP. 6 REFERENCES		COST BASE		
BOILER CAPACITY (MMBtu/hr): 50	PEERLESS, 1992		1992 DOLLARS		
FUEL TYPE: NATURAL GAS					
CONTROL METHOD: SCR - VARIABLE CATALYST LIFE					
ANNUAL OPERATING AND MAINTENANCE COSTS (O&M)					
	CAPACITY FACTOR	0.8	0.66	0.5	0.33
<b>A. DIRECT ANNUAL COSTS (DAC)</b>					
1. OPERATING LABOR					
2. MAINTENANCE LABOR (semi-annual inspection)		\$2,000	\$2,000	\$2,000	\$2,000
3. MAINTENANCE MATERIALS					
4. REPLACEMENT MATERIALS (catalyst replacement every 6 yrs)		\$8,333	\$8,333	\$8,333	\$8,333
5. ELECTRICITY @ \$0.05/kW-hr		\$523	\$431	\$327	\$216
6. STEAM					
7. FUEL					
8. WASTE DISPOSAL (catalyst)		\$2,083	\$2,083	\$2,083	\$2,083
9. CHEMICALS (ammonia @ \$250/ton, 1 lb/hr)		\$876	\$723	\$548	\$361
10. OTHER					
*** TOTAL DIRECT ANNUAL COSTS ***	DAC	\$13,815	\$13,571	\$13,291	\$12,994
<b>B. INDIRECT ANNUAL COSTS (IAC)</b>					
1. OVERHEAD (60% OF SUM OF ALL LABOR AND MAINTENANCE MATERIALS)		\$1,200	\$1,200	\$1,200	\$1,200
2. ADMINISTRATIVE (0.02*TCIC)		\$6,873	\$6,873	\$6,873	\$6,873
3. PROPERTY TAX (0.01*TCIC)		\$3,436	\$3,436	\$3,436	\$3,436
4. INSURANCE (0.01*TCIC)		\$3,436	\$3,436	\$3,436	\$3,436
*** TOTAL INDIRECT ANNUAL COSTS ***	IAC	\$14,945	\$14,945	\$14,945	\$14,945
*** TOTAL ANNUAL OPERATING AND MAINTENANCE COSTS *** (DAC+IAC)	O&M	\$28,761	\$28,516	\$28,236	\$27,939
COST EFFECTIVENESS					
<b>A. TOTAL ANNUALIZED COST (incl. capital and O&amp;M)</b>					
1. ANNUALIZED CAPITAL INVESTMENT COST (ACIC)					
EXPECTED LIFETIME OF EQUIPMENT, YEARS		10	10	10	10
INTEREST RATE		0.1	0.1	0.1	0.1
CAPITAL RECOVERY FACTOR		0.1627	0.1627	0.1627	0.1627
TOTAL CAPITAL INVESTMENT COSTS (TCIC, above)		\$343,630	\$343,630	\$343,630	\$343,630
*** ANNUALIZED CAPITAL INVESTMENT COST ***	ACIC	\$55,924	\$55,924	\$55,924	\$55,924
2. ANNUAL O&M COSTS (O&M, above)	O&M	\$28,761	\$28,516	\$28,236	\$27,939
*** TOTAL ANNUALIZED COST ***	ACIC+O&M	\$84,685	\$84,440	\$84,160	\$83,863
<b>B. NOx REMOVAL PER YEAR</b>					
1. BASELINE NOx LEVEL (lb/MMBtu)	(NOx)1	0.16	0.16	0.16	0.16
2. CONTROLLED NOx LEVEL (lb/MMBtu)	(NOx)2	0.02	0.02	0.02	0.02
3. NOx REMOVAL EFFICIENCY (%)		85	85	85	85
4. CAPACITY FACTOR	CF	0.8	0.66	0.5	0.33
5. BOILER HEAT INPUT CAPACITY (MMBtu/hr)	CAP	50	50	50	50
*** NOx REMOVED PER YEAR (TONS/YR) ***					
[CAP*CF*(24 hr/day)*(365 days/yr)]*[(NOx)1-(NOx)2]/2000		23.8	19.7	14.9	9.8
*** COST EFFECTIVENESS (\$/TON NOx REMOVED, 1992 DOLLARS) ***		\$3,554	\$4,296	\$5,651	\$8,532

COST EFFECTIVENESS OF RETROFIT NO <sub>x</sub> CONTROLS					
BOILER TYPE: PACKAGED WATERTUBE		CHAP. 6 REFERENCES		COST BASE	
BOILER CAPACITY (MMBtu/hr): 50		PEERLESS, 1992		1992 DOLLARS	
FUEL TYPE: NATURAL GAS					
CONTROL METHOD: SCR - VARIABLE CATALYST LIFE					
TOTAL CAPITAL INVESTMENT COST (TCIC)					
		BOILER CAPACITY FACTOR			
		0.8	0.66	0.5	0.33
<b>A. DIRECT CAPITAL COST (DCC)</b>					
1. PURCHASED EQUIPMENT COST (PEC)					
PRIMARY AND AUXILIARY EQUIPMENT (EQP)		EQP			
CEM SYSTEM					
INSTRUMENTATION					
SALES TAX					
FREIGHT					
*** TOTAL PURCHASED EQUIPMENT COST ***		PEC	\$121,300	\$121,300	\$121,300
2. DIRECT INSTALLATION COST (DIC)					
*** TOTAL DIRECT INSTALLATION COST ***		DIC	\$85,000	\$85,000	\$85,000
3. SITE PREP. SP (as required)		SP			
4. BUILDINGS, BLDG (as required)		BLDG			
*** TOTAL DIRECT CAPITAL COST *** (PEC+DIC+SP+BLDG)		DCC	\$206,300	\$206,300	\$206,300
<b>B. INDIRECT CAPITAL COST (ICC)</b>					
1. ENGINEERING (0.20PEC)			\$24,260	\$24,260	\$24,260
2. CONSTRUCTION AND FIELD EXPENSES (0.20PEC)			\$24,260	\$24,260	\$24,260
3. CONSTRUCTION FEE (0.20PEC)			\$24,260	\$24,260	\$24,260
4. STARTUP (0.04PEC)			\$4,852	\$4,852	\$4,852
5. PERFORMANCE TEST (0.02PEC)			\$2,426	\$2,426	\$2,426
*** TOTAL INDIRECT CAPITAL COST ***		ICC	\$80,058	\$80,058	\$80,058
<b>C. CONTINGENCY (0.20*(DCC+ICC))</b>		CONT	\$57,272	\$57,272	\$57,272
*** TOTAL CAPITAL INVESTMENT COST *** (DCC+ICC+CONT)		TCIC	\$343,630	\$343,630	\$343,630

CONTINUED ON NEXT PAGE

COST EFFECTIVENESS OF RETROFIT NO <sub>x</sub> CONTROLS						
BOILER TYPE: PACKAGED WATERTUBE		CHAP. 6 REFERENCES		COST BASE		
BOILER CAPACITY (MMBtu/hr): 50		PEERLESS, 1992		1992 DOLLARS		
FUEL TYPE: NATURAL GAS						
CONTROL METHOD: SCR - VARIABLE CATALYST LIFE						
ANNUAL OPERATING AND MAINTENANCE COSTS (O&M)						
		CAPACITY FACTOR	0.8	0.66	0.5	0.33
<b>A. DIRECT ANNUAL COSTS (DAC)</b>						
1.	OPERATING LABOR					
2.	MAINTENANCE LABOR (semi-annual inspection)		\$2,000	\$2,000	\$2,000	\$2,000
3.	MAINTENANCE MATERIALS					
4.	REPLACEMENT MATERIALS (catalyst replacement every 8 yrs)		\$6,250	\$6,250	\$6,250	\$6,250
5.	ELECTRICITY @ \$0.05/kw-hr		\$523	\$431	\$327	\$216
6.	STEAM					
7.	FUEL					
8.	WASTE DISPOSAL (catalyst)		\$1,563	\$1,563	\$1,563	\$1,563
9.	CHEMICALS (ammonia @ \$250/ton, 1 lb/hr)		\$876	\$723	\$548	\$361
10.	OTHER					
***	TOTAL DIRECT ANNUAL COSTS ***	DAC	\$11,211	\$10,967	\$10,687	\$10,390
<b>B. INDIRECT ANNUAL COSTS (IAC)</b>						
1.	OVERHEAD (60% OF SUM OF ALL LABOR AND MAINTENANCE MATERIALS)		\$1,200	\$1,200	\$1,200	\$1,200
2.	ADMINISTRATIVE (0.02*TCIC)		\$6,873	\$6,873	\$6,873	\$6,873
3.	PROPERTY TAX (0.01*TCIC)		\$3,436	\$3,436	\$3,436	\$3,436
4.	INSURANCE (0.01*TCIC)		\$3,436	\$3,436	\$3,436	\$3,436
***	TOTAL INDIRECT ANNUAL COSTS ***	IAC	\$14,945	\$14,945	\$14,945	\$14,945
***	TOTAL ANNUAL OPERATING AND MAINTENANCE COSTS *** (DAC+IAC)	O&M	\$26,156	\$25,912	\$25,632	\$25,335
COST EFFECTIVENESS						
<b>A. TOTAL ANNUALIZED COST (incl. capital and O&amp;M)</b>						
1.	ANNUALIZED CAPITAL INVESTMENT COST (ACIC)					
	EXPECTED LIFETIME OF EQUIPMENT, YEARS		10	10	10	10
	INTEREST RATE		0.1	0.1	0.1	0.1
	CAPITAL RECOVERY FACTOR		0.1627	0.1627	0.1627	0.1627
	TOTAL CAPITAL INVESTMENT COSTS (TCIC, above)		\$343,630	\$343,630	\$343,630	\$343,630
***	ANNUALIZED CAPITAL INVESTMENT COST ***	ACIC	\$55,924	\$55,924	\$55,924	\$55,924
2.	ANNUAL O&M COSTS (O&M, above)	O&M	\$26,156	\$25,912	\$25,632	\$25,335
***	TOTAL ANNUALIZED COST ***	ACIC+O&M	\$82,081	\$81,836	\$81,556	\$81,259
<b>B. NO<sub>x</sub> REMOVAL PER YEAR</b>						
1.	BASELINE NO <sub>x</sub> LEVEL (lb/MMBtu)	(NO <sub>x</sub> )1	0.16	0.16	0.16	0.16
2.	CONTROLLED NO <sub>x</sub> LEVEL (lb/MMBtu)	(NO <sub>x</sub> )2	0.02	0.02	0.02	0.02
3.	NO <sub>x</sub> REMOVAL EFFICIENCY (%)		85	85	85	85
4.	CAPACITY FACTOR	CF	0.8	0.66	0.5	0.33
5.	BOILER HEAT INPUT CAPACITY (MMBtu/hr)	CAP	50	50	50	50
***	NO <sub>x</sub> REMOVED PER YEAR (TONS/YR) ***					
	[CAP*CF*(24 hr/day)*(365 days/yr)]*[(NO <sub>x</sub> )1-(NO <sub>x</sub> )2]/2000		23.8	19.7	14.9	9.8
***	COST EFFECTIVENESS (\$/TON NO <sub>x</sub> REMOVED, 1992 DOLLARS) ***		\$3,445	\$4,163	\$5,477	\$8,267



COST EFFECTIVENESS OF RETROFIT NOx CONTROLS					
BOILER TYPE:	PACKAGED WATERTUBE	CHAP. 6 REFERENCES	COST BASE		
BOILER CAPACITY (MMBtu/hr):	150	PEERLESS, 1992	1992 DOLLARS		
FUEL TYPE:	NATURAL GAS				
CONTROL METHOD:	SCR - VARIABLE CATALYST LIFE ANALYSIS				
TOTAL CAPITAL INVESTMENT COST (TCIC)					
		BOILER CAPACITY FACTOR			
		0.8	0.66	0.5	0.33
<b>A. DIRECT CAPITAL COST (DCC)</b>					
1. PURCHASED EQUIPMENT COST (PEC)					
PRIMARY AND AUXILIARY EQUIPMENT (EQP)	EQP				
CEM SYSTEM					
INSTRUMENTATION					
SALES TAX					
FREIGHT					
*** TOTAL PURCHASED EQUIPMENT COST ***	PEC	\$190,997	\$190,997	\$190,997	\$190,997
2. DIRECT INSTALLATION COST (DIC)					
*** TOTAL DIRECT INSTALLATION COST ***	DIC	\$133,643	\$133,643	\$133,643	\$133,643
3. SITE PREP, SP (as required)	SP				
4. BUILDINGS, BLDG (as required)	BLDG				
*** TOTAL DIRECT CAPITAL COST ***	DCC	\$324,640	\$324,640	\$324,640	\$324,640
(PEC+DIC+SP+BLDG)					
<b>B. INDIRECT CAPITAL COST (ICC)</b>					
1. ENGINEERING (0.20PEC)		\$38,199	\$38,199	\$38,199	\$38,199
2. CONSTRUCTION AND FIELD EXPENSES (0.20PEC)		\$38,199	\$38,199	\$38,199	\$38,199
3. CONSTRUCTION FEE (0.20PEC)		\$38,199	\$38,199	\$38,199	\$38,199
4. STARTUP (0.04PEC)		\$7,640	\$7,640	\$7,640	\$7,640
5. PERFORMANCE TEST (0.02PEC)		\$3,820	\$3,820	\$3,820	\$3,820
*** TOTAL INDIRECT CAPITAL COST ***	ICC	\$126,058	\$126,058	\$126,058	\$126,058
<b>C. CONTINGENCY (0.20*(DCC+ICC))</b>					
	CONT	\$90,140	\$90,140	\$90,140	\$90,140
*** TOTAL CAPITAL INVESTMENT COST ***	TCIC	\$540,838	\$540,838	\$540,838	\$540,838
(DCC+ICC+CONT)					

CONTINUED ON NEXT PAGE

COST EFFECTIVENESS OF RETROFIT NOx CONTROLS						
BOILER TYPE: PACKAGED WATERTUBE		CHAP. 6 REFERENCES		COST BASE		
BOILER CAPACITY (MMBtu/hr): 150		PEERLESS, 1992		1992 DOLLARS		
FUEL TYPE: NATURAL GAS						
CONTROL METHOD: SCR - VARIABLE CATALYST LIFE ANALYSIS						
ANNUAL OPERATING AND MAINTENANCE COSTS (O&M)						
		CAPACITY FACTOR	0.8	0.66	0.5	0.33
<b>A. DIRECT ANNUAL COSTS (DAC)</b>						
1. OPERATING LABOR						
2. MAINTENANCE LABOR (semi-annual inspection)		\$2,000	\$2,000	\$2,000	\$2,000	\$2,000
3. MAINTENANCE MATERIALS						
4. REPLACEMENT MATERIALS (catalyst replacement every 6 yrs)		\$25,000	\$25,000	\$25,000	\$25,000	\$25,000
5. ELECTRICITY @ \$0.05/kw-hr		\$523	\$431	\$327	\$216	\$216
6. STEAM						
7. FUEL						
8. WASTE DISPOSAL (catalyst)		\$6,250	\$6,250	\$6,250	\$6,250	\$6,250
9. CHEMICALS (ammonia @ \$250/ton, 3.3 lb/hr)		\$2,891	\$2,385	\$1,807	\$1,192	\$1,192
10. OTHER						
*** TOTAL DIRECT ANNUAL COSTS ***		DAC	\$36,664	\$36,066	\$35,383	\$34,658
<b>B. INDIRECT ANNUAL COSTS (IAC)</b>						
1. OVERHEAD (60% OF SUM OF ALL LABOR AND MAINTENANCE MATERIALS)		\$1,200	\$1,200	\$1,200	\$1,200	\$1,200
2. ADMINISTRATIVE (0.02*TCIC)		\$10,817	\$10,817	\$10,817	\$10,817	\$10,817
3. PROPERTY TAX (0.01*TCIC)		\$5,408	\$5,408	\$5,408	\$5,408	\$5,408
4. INSURANCE (0.01*TCIC)		\$5,408	\$5,408	\$5,408	\$5,408	\$5,408
*** TOTAL INDIRECT ANNUAL COSTS ***		IAC	\$22,834	\$22,834	\$22,834	\$22,834
*** TOTAL ANNUAL OPERATING AND MAINTENANCE COSTS *** (DAC+IAC)		O&M	\$59,497	\$58,900	\$58,217	\$57,492
COST EFFECTIVENESS						
<b>A. TOTAL ANNUALIZED COST (incl. capital and O&amp;M)</b>						
1. ANNUALIZED CAPITAL INVESTMENT COST (ACIC)						
EXPECTED LIFETIME OF EQUIPMENT, YEARS		10	10	10	10	10
INTEREST RATE		0.1	0.1	0.1	0.1	0.1
CAPITAL RECOVERY FACTOR		0.1627	0.1627	0.1627	0.1627	0.1627
TOTAL CAPITAL INVESTMENT COSTS (TCIC, above)		\$540,838	\$540,838	\$540,838	\$540,838	\$540,838
*** ANNUALIZED CAPITAL INVESTMENT COST ***		ACIC	\$88,019	\$88,019	\$88,019	\$88,019
2. ANNUAL O&M COSTS (O&M, above)		O&M	\$59,497	\$58,900	\$58,217	\$57,492
*** TOTAL ANNUALIZED COST ***		ACIC+O&M	\$147,516	\$146,919	\$146,236	\$145,511
<b>B. NOx REMOVAL PER YEAR</b>						
1. BASELINE NOx LEVEL (lb/MMBtu)		(NOx)1	0.18	0.18	0.18	0.18
2. CONTROLLED NOx LEVEL (lb/MMBtu)		(NOx)2	0.03	0.03	0.03	0.03
3. NOx REMOVAL EFFICIENCY (%)			85	85	85	85
4. CAPACITY FACTOR		CF	0.8	0.66	0.5	0.33
5. BOILER HEAT INPUT CAPACITY (MMBtu/hr)		CAP	150	150	150	150
*** NOx REMOVED PER YEAR (TONS/YR) ***						
[CAP*CF*(24 hr/day)*(365 days/yr)]*[(NOx)1-(NOx)2]/2000			80.4	66.3	50.3	33.2
*** COST EFFECTIVENESS (\$/TON NOx REMOVED, 1992 DOLLARS) ***			\$1,834	\$2,215	\$2,910	\$4,387

COST EFFECTIVENESS OF RETROFIT NOx CONTROLS					
BOILER TYPE: PACKAGED WATERTUBE		CHAP. 6 REFERENCES		COST BASE	
BOILER CAPACITY (MMBtu/hr): 150		PEERLESS, 1992		1992 DOLLARS	
FUEL TYPE: NATURAL GAS					
CONTROL METHOD: SCR - VARIABLE CATALYST LIFE ANALYSIS					
TOTAL CAPITAL INVESTMENT COST (TCIC)					
		BOILER CAPACITY FACTOR			
		0.8	0.66	0.5	0.33
<b>A. DIRECT CAPITAL COST (DCC)</b>					
1. PURCHASED EQUIPMENT COST (PEC)					
PRIMARY AND AUXILIARY EQUIPMENT (EQP)	EQP				
CEM SYSTEM					
INSTRUMENTATION					
SALES TAX					
FREIGHT					
*** TOTAL PURCHASED EQUIPMENT COST ***	PEC	\$190,997	\$190,997	\$190,997	\$190,997
2. DIRECT INSTALLATION COST (DIC)					
*** TOTAL DIRECT INSTALLATION COST ***	DIC	\$133,643	\$133,643	\$133,643	\$133,643
3. SITE PREP, SP (as required)					
	SP				
4. BUILDINGS, BLDG (as required)					
	BLDG				
*** TOTAL DIRECT CAPITAL COST ***	DCC	\$324,640	\$324,640	\$324,640	\$324,640
(PEC+DIC+SP+BLDG)					
<b>B. INDIRECT CAPITAL COST (ICC)</b>					
1. ENGINEERING (0.20PEC)		\$38,199	\$38,199	\$38,199	\$38,199
2. CONSTRUCTION AND FIELD EXPENSES (0.20PEC)		\$38,199	\$38,199	\$38,199	\$38,199
3. CONSTRUCTION FEE (0.20PEC)		\$38,199	\$38,199	\$38,199	\$38,199
4. STARTUP (0.04PEC)		\$7,640	\$7,640	\$7,640	\$7,640
5. PERFORMANCE TEST (0.02PEC)		\$3,820	\$3,820	\$3,820	\$3,820
*** TOTAL INDIRECT CAPITAL COST ***	ICC	\$126,058	\$126,058	\$126,058	\$126,058
<b>C. CONTINGENCY (0.20*(DCC+ICC))</b>					
	CONT	\$90,140	\$90,140	\$90,140	\$90,140
*** TOTAL CAPITAL INVESTMENT COST ***	TCIC	\$540,838	\$540,838	\$540,838	\$540,838
(DCC+ICC+CONT)					

CONTINUED ON NEXT PAGE

COST EFFECTIVENESS OF RETROFIT NOx CONTROLS						
BOILER TYPE: PACKAGED WATERTUBE		CHAP. 6 REFERENCES		COST BASE		
BOILER CAPACITY (MMBtu/hr): 150		PEERLESS, 1992		1992 DOLLARS		
FUEL TYPE: NATURAL GAS						
CONTROL METHOD: SCR - VARIABLE CATALYST LIFE ANALYSIS						
ANNUAL OPERATING AND MAINTENANCE COSTS (O&M)						
		CAPACITY FACTOR	0.8	0.66	0.5	0.33
<b>A. DIRECT ANNUAL COSTS (DAC)</b>						
1. OPERATING LABOR						
2. MAINTENANCE LABOR (semi-annual inspection)			\$2,000	\$2,000	\$2,000	\$2,000
3. MAINTENANCE MATERIALS						
4. REPLACEMENT MATERIALS (catalyst replacement every 8 yrs)			\$18,750	\$18,750	\$18,750	\$18,750
5. ELECTRICITY @ \$0.05/kw-hr			\$523	\$431	\$327	\$216
6. STEAM						
7. FUEL						
8. WASTE DISPOSAL (catalyst)			\$4,688	\$4,688	\$4,688	\$4,688
9. CHEMICALS (ammonia @ \$250/ton, 3.3 lb/hr)			\$2,891	\$2,385	\$1,807	\$1,192
10. OTHER						
*** TOTAL DIRECT ANNUAL COSTS ***		DAC	\$28,851	\$28,254	\$27,571	\$26,846
<b>B. INDIRECT ANNUAL COSTS (IAC)</b>						
1. OVERHEAD (60% OF SUM OF ALL LABOR AND MAINTENANCE MATERIALS)			\$1,200	\$1,200	\$1,200	\$1,200
2. ADMINISTRATIVE (0.02*TCIC)			\$10,817	\$10,817	\$10,817	\$10,817
3. PROPERTY TAX (0.01*TCIC)			\$5,408	\$5,408	\$5,408	\$5,408
4. INSURANCE (0.01*TCIC)			\$5,408	\$5,408	\$5,408	\$5,408
*** TOTAL INDIRECT ANNUAL COSTS ***		IAC	\$22,834	\$22,834	\$22,834	\$22,834
*** TOTAL ANNUAL OPERATING AND MAINTENANCE COSTS *** (DAC+IAC)		O&M	\$51,685	\$51,087	\$50,405	\$49,679
COST EFFECTIVENESS						
<b>A. TOTAL ANNUALIZED COST (incl. capital and O&amp;M)</b>						
1. ANNUALIZED CAPITAL INVESTMENT COST (ACIC)						
EXPECTED LIFETIME OF EQUIPMENT, YEARS			10	10	10	10
INTEREST RATE			0.1	0.1	0.1	0.1
CAPITAL RECOVERY FACTOR			0.1627	0.1627	0.1627	0.1627
TOTAL CAPITAL INVESTMENT COSTS (TCIC, above)			\$540,838	\$540,838	\$540,838	\$540,838
*** ANNUALIZED CAPITAL INVESTMENT COST ***		ACIC	\$88,019	\$88,019	\$88,019	\$88,019
2. ANNUAL O&M COSTS (O&M, above)		O&M	\$51,685	\$51,087	\$50,405	\$49,679
*** TOTAL ANNUALIZED COST ***		ACIC+O&M	\$139,704	\$139,106	\$138,423	\$137,698
<b>B. NOx REMOVAL PER YEAR</b>						
1. BASELINE NOx LEVEL (lb/MMBtu)		(NOx)1	0.18	0.18	0.18	0.18
2. CONTROLLED NOx LEVEL (lb/MMBtu)		(NOx)2	0.03	0.03	0.03	0.03
3. NOx REMOVAL EFFICIENCY (%)			85	85	85	85
4. CAPACITY FACTOR		CF	0.8	0.66	0.5	0.33
5. BOILER HEAT INPUT CAPACITY (MMBtu/hr)		CAP	150	150	150	150
*** NOx REMOVED PER YEAR (TONS/YR) ***						
[CAP*CF*(24 hr/day)*(365 days/yr)]*[(NOx)1-(NOx)2]/2000			80.4	66.3	50.3	33.2
*** COST EFFECTIVENESS (\$/TON NOx REMOVED, 1992 DOLLARS) ***			\$1,737	\$2,097	\$2,754	\$4,151

COST EFFECTIVENESS OF RETROFIT NOx CONTROLS					
BOILER TYPE:	FIELD ERECTED WATERTUBE	CHAP. 6 REFERENCES	COST BASE		
BOILER CAPACITY (MMBtu/hr):	250	PEERLESS, 1992	1992 DOLLARS		
FUEL TYPE:	NATURAL GAS				
CONTROL METHOD:	SCR - VARIABLE CATALYST LIFE				
TOTAL CAPITAL INVESTMENT COST (TCIC)					
		BOILER CAPACITY FACTOR			
		0.8	0.66	0.5	0.33
<b>A. DIRECT CAPITAL COST (DCC)</b>					
1. PURCHASED EQUIPMENT COST (PEC)					
PRIMARY AND AUXILIARY EQUIPMENT (EQP)	EQP				
CEM SYSTEM					
INSTRUMENTATION					
SALES TAX					
FREIGHT					
*** TOTAL PURCHASED EQUIPMENT COST ***	PEC	\$270,100	\$270,100	\$270,100	\$270,100
2. DIRECT INSTALLATION COST (DIC)					
*** TOTAL DIRECT INSTALLATION COST ***	DIC	\$189,000	\$189,000	\$189,000	\$189,000
3. SITE PREP, SP (as required)	SP				
4. BUILDINGS, BLDG (as required)	BLDG				
*** TOTAL DIRECT CAPITAL COST *** (PEC+DIC+SP+BLDG)	DCC	\$459,100	\$459,100	\$459,100	\$459,100
<b>B. INDIRECT CAPITAL COST (ICC)</b>					
1. ENGINEERING (0.20PEC)		\$54,020	\$54,020	\$54,020	\$54,020
2. CONSTRUCTION AND FIELD EXPENSES (0.20PEC)		\$54,020	\$54,020	\$54,020	\$54,020
3. CONSTRUCTION FEE (0.20PEC)		\$54,020	\$54,020	\$54,020	\$54,020
4. STARTUP (0.04PEC)		\$10,804	\$10,804	\$10,804	\$10,804
5. PERFORMANCE TEST (0.02PEC)		\$5,402	\$5,402	\$5,402	\$5,402
*** TOTAL INDIRECT CAPITAL COST ***	ICC	\$178,266	\$178,266	\$178,266	\$178,266
C. CONTINGENCY (0.20*(DCC+ICC))	CONT	\$127,473	\$127,473	\$127,473	\$127,473
*** TOTAL CAPITAL INVESTMENT COST *** (DCC+ICC+CONT)	TCIC	\$764,839	\$764,839	\$764,839	\$764,839

CONTINUED ON NEXT PAGE

COST EFFECTIVENESS OF RETROFIT NO <sub>x</sub> CONTROLS					
BOILER TYPE:	FIELD ERECTED WATERTUBE	CHAP. 6 REFERENCES	COST BASE		
BOILER CAPACITY (MMBtu/hr):	250	PEERLESS, 1992	1992 DOLLARS		
FUEL TYPE:	NATURAL GAS				
CONTROL METHOD:	SCR - VARIABLE CATALYST LIFE				
ANNUAL OPERATING AND MAINTENANCE COSTS (O&M)					
	CAPACITY FACTOR	0.8	0.66	0.5	0.33
<b>A. DIRECT ANNUAL COSTS (DAC)</b>					
1. OPERATING LABOR					
2. MAINTENANCE LABOR (semi-annual inspection)		\$2,000	\$2,000	\$2,000	\$2,000
3. MAINTENANCE MATERIALS					
4. REPLACEMENT MATERIALS (catalyst replacement every 6 yrs)		\$41,667	\$41,667	\$41,667	\$41,667
5. ELECTRICITY @ \$0.05/kW-hr		\$523	\$431	\$327	\$216
6. STEAM					
7. FUEL					
8. WASTE DISPOSAL (catalyst)		\$10,417	\$10,417	\$10,417	\$10,417
9. CHEMICALS (ammonia @ \$250/ton, 5.5 lb/hr)		\$4,818	\$3,975	\$3,011	\$1,987
10. OTHER					
*** TOTAL DIRECT ANNUAL COSTS ***	DAC	\$59,424	\$58,489	\$57,421	\$56,286
<b>B. INDIRECT ANNUAL COSTS (IAC)</b>					
1. OVERHEAD (60% OF SUM OF ALL LABOR AND MAINTENANCE MATERIALS)		\$1,200	\$1,200	\$1,200	\$1,200
2. ADMINISTRATIVE (0.02*TCIC)		\$15,297	\$15,297	\$15,297	\$15,297
3. PROPERTY TAX (0.01*TCIC)		\$7,648	\$7,648	\$7,648	\$7,648
4. INSURANCE (0.01*TCIC)		\$7,648	\$7,648	\$7,648	\$7,648
*** TOTAL INDIRECT ANNUAL COSTS ***	IAC	\$31,794	\$31,794	\$31,794	\$31,794
*** TOTAL ANNUAL OPERATING AND MAINTENANCE COSTS *** (DAC+IAC)	O&M	\$91,218	\$90,283	\$89,215	\$88,080
COST EFFECTIVENESS					
<b>A. TOTAL ANNUALIZED COST (incl. capital and O&amp;M)</b>					
1. ANNUALIZED CAPITAL INVESTMENT COST (ACIC)					
EXPECTED LIFETIME OF EQUIPMENT, YEARS		10	10	10	10
INTEREST RATE		0.1	0.1	0.1	0.1
CAPITAL RECOVERY FACTOR		0.1627	0.1627	0.1627	0.1627
TOTAL CAPITAL INVESTMENT COSTS (TCIC, above)		\$764,839	\$764,839	\$764,839	\$764,839
*** ANNUALIZED CAPITAL INVESTMENT COST ***	ACIC	\$124,474	\$124,474	\$124,474	\$124,474
2. ANNUAL O&M COSTS (O&M, above)	O&M	\$91,218	\$90,283	\$89,215	\$88,080
*** TOTAL ANNUALIZED COST ***	ACIC+O&M	\$215,692	\$214,757	\$213,689	\$212,554
<b>B. NO<sub>x</sub> REMOVAL PER YEAR</b>					
1. BASELINE NO <sub>x</sub> LEVEL (lb/MMBtu)	(NO <sub>x</sub> )1	0.24	0.24	0.24	0.24
2. CONTROLLED NO <sub>x</sub> LEVEL (lb/MMBtu)	(NO <sub>x</sub> )2	0.04	0.04	0.04	0.04
3. NO <sub>x</sub> REMOVAL EFFICIENCY (%)		85	85	85	85
4. CAPACITY FACTOR	CF	0.8	0.66	0.5	0.33
5. BOILER HEAT INPUT CAPACITY (MMBtu/hr)	CAP	250	250	250	250
*** NO <sub>x</sub> REMOVED PER YEAR (TONS/YR) ***					
[CAP*CF*(24 hr/day)*(365 days/yr)]*[(NO <sub>x</sub> )1-(NO <sub>x</sub> )2]/2000		178.7	147.4	111.7	73.7
*** COST EFFECTIVENESS (\$/TON NO <sub>x</sub> REMOVED, 1992 DOLLARS) ***		\$1,207	\$1,457	\$1,913	\$2,883

COST EFFECTIVENESS OF RETROFIT NOx CONTROLS					
BOILER TYPE:	FIELD ERECTED WATERTUBE	CHAP. 6 REFERENCES	COST BASE		
BOILER CAPACITY (MMBtu/hr):	250	PEERLESS, 1992	1992 DOLLARS		
FUEL TYPE:	NATURAL GAS				
CONTROL METHOD:	SCR - VARIABLE CATALYST LIFE				
TOTAL CAPITAL INVESTMENT COST (TCIC)					
		BOILER CAPACITY FACTOR			
		0.8	0.66	0.5	0.33
<b>A. DIRECT CAPITAL COST (DCC)</b>					
1. PURCHASED EQUIPMENT COST (PEC)					
PRIMARY AND AUXILIARY EQUIPMENT (EQP)	EQP				
CEM SYSTEM					
INSTRUMENTATION					
SALES TAX					
FREIGHT					
*** TOTAL PURCHASED EQUIPMENT COST ***	PEC	\$270,100	\$270,100	\$270,100	\$270,100
2. DIRECT INSTALLATION COST (DIC)					
*** TOTAL DIRECT INSTALLATION COST ***	DIC	\$189,000	\$189,000	\$189,000	\$189,000
3. SITE PREP, SP (as required)	SP				
4. BUILDINGS, BLDG (as required)	BLDG				
*** TOTAL DIRECT CAPITAL COST ***	DCC	\$459,100	\$459,100	\$459,100	\$459,100
(PEC+DIC+SP+BLDG)					
<b>B. INDIRECT CAPITAL COST (ICC)</b>					
1. ENGINEERING (0.20PEC)		\$54,020	\$54,020	\$54,020	\$54,020
2. CONSTRUCTION AND FIELD EXPENSES (0.20PEC)		\$54,020	\$54,020	\$54,020	\$54,020
3. CONSTRUCTION FEE (0.20PEC)		\$54,020	\$54,020	\$54,020	\$54,020
4. STARTUP (0.04PEC)		\$10,804	\$10,804	\$10,804	\$10,804
5. PERFORMANCE TEST (0.02PEC)		\$5,402	\$5,402	\$5,402	\$5,402
*** TOTAL INDIRECT CAPITAL COST ***	ICC	\$178,266	\$178,266	\$178,266	\$178,266
<b>C. CONTINGENCY (0.20*(DCC+ICC))</b>					
	CONT	\$127,473	\$127,473	\$127,473	\$127,473
*** TOTAL CAPITAL INVESTMENT COST ***	TCIC	\$764,839	\$764,839	\$764,839	\$764,839
(DCC+ICC+CONT)					

CONTINUED ON NEXT PAGE

COST EFFECTIVENESS OF RETROFIT NO <sub>x</sub> CONTROLS						
BOILER TYPE: FIELD ERECTED WATERTUBE		CHAP. 6 REFERENCES		COST BASE		
BOILER CAPACITY (MMBtu/hr): 250		PEERLESS, 1992		1992 DOLLARS		
FUEL TYPE: NATURAL GAS						
CONTROL METHOD: SCR - VARIABLE CATALYST LIFE						
ANNUAL OPERATING AND MAINTENANCE COSTS (O&M)						
		CAPACITY FACTOR	0.8	0.66	0.5	0.33
A. DIRECT ANNUAL COSTS (DAC)						
1. OPERATING LABOR						
2. MAINTENANCE LABOR (semi-annual inspection)			\$2,000	\$2,000	\$2,000	\$2,000
3. MAINTENANCE MATERIALS						
4. REPLACEMENT MATERIALS (catalyst replacement every 8 yrs)			\$31,250	\$31,250	\$31,250	\$31,250
5. ELECTRICITY @ \$0.05/kw-hr			\$523	\$431	\$327	\$216
6. STEAM						
7. FUEL						
8. WASTE DISPOSAL (catalyst)			\$7,813	\$7,813	\$7,813	\$7,813
9. CHEMICALS (ammonia @ \$250/ton, 5.5 lb/hr)			\$4,818	\$3,975	\$3,011	\$1,987
10. OTHER						
*** TOTAL DIRECT ANNUAL COSTS ***		DAC	\$46,403	\$45,469	\$44,400	\$43,266
B. INDIRECT ANNUAL COSTS (IAC)						
1. OVERHEAD (60% OF SUM OF ALL LABOR AND MAINTENANCE MATERIALS)			\$1,200	\$1,200	\$1,200	\$1,200
2. ADMINISTRATIVE (0.02*TCIC)			\$15,297	\$15,297	\$15,297	\$15,297
3. PROPERTY TAX (0.01*TCIC)			\$7,648	\$7,648	\$7,648	\$7,648
4. INSURANCE (0.01*TCIC)			\$7,648	\$7,648	\$7,648	\$7,648
*** TOTAL INDIRECT ANNUAL COSTS ***		IAC	\$31,794	\$31,794	\$31,794	\$31,794
*** TOTAL ANNUAL OPERATING AND MAINTENANCE COSTS *** (DAC+IAC)		O&M	\$78,197	\$77,262	\$76,194	\$75,059
COST EFFECTIVENESS						
A. TOTAL ANNUALIZED COST (incl. capital and O&M)						
1. ANNUALIZED CAPITAL INVESTMENT COST (ACIC)						
EXPECTED LIFETIME OF EQUIPMENT, YEARS			10	10	10	10
INTEREST RATE			0.1	0.1	0.1	0.1
CAPITAL RECOVERY FACTOR			0.1627	0.1627	0.1627	0.1627
TOTAL CAPITAL INVESTMENT COSTS (TCIC, above)			\$764,839	\$764,839	\$764,839	\$764,839
*** ANNUALIZED CAPITAL INVESTMENT COST ***		ACIC	\$124,474	\$124,474	\$124,474	\$124,474
2. ANNUAL O&M COSTS (O&M, above)		O&M	\$78,197	\$77,262	\$76,194	\$75,059
*** TOTAL ANNUALIZED COST ***		ACIC+O&M	\$202,671	\$201,736	\$200,668	\$199,533
B. NO <sub>x</sub> REMOVAL PER YEAR						
1. BASELINE NO <sub>x</sub> LEVEL (lb/MMBtu)		(NO <sub>x</sub> )1	0.24	0.24	0.24	0.24
2. CONTROLLED NO <sub>x</sub> LEVEL (lb/MMBtu)		(NO <sub>x</sub> )2	0.04	0.04	0.04	0.04
3. NO <sub>x</sub> REMOVAL EFFICIENCY (%)			85	85	85	85
4. CAPACITY FACTOR		CF	0.8	0.66	0.5	0.33
5. BOILER HEAT INPUT CAPACITY (MMBtu/hr)		CAP	250	250	250	250
*** NO <sub>x</sub> REMOVED PER YEAR (TONS/YR) ***						
[CAP*CF*(24 hr/day)*(365 days/yr)]*[(NO <sub>x</sub> )1-(NO <sub>x</sub> )2]/2000			178.7	147.4	111.7	73.7
*** COST EFFECTIVENESS (\$/TON NO <sub>x</sub> REMOVED, 1992 DOLLARS) ***			\$1,134	\$1,368	\$1,797	\$2,707



**APPENDIX F. ANNUAL COSTS OF RETROFIT NO<sub>x</sub> CONTROLS:  
COAL-FIRED ICI BOILERS**

This appendix contains cost spreadsheets for coal-fired boilers retrofitted with various NO<sub>x</sub> controls. The spreadsheets are based on data from actual boiler retrofit experiences or studies. Capital annualization for all analyses are based on a 10-year amortization period and a 10 percent interest rate. All costs presented are in 1992 dollars. For further information on the methodology and assumptions made in these cost analyses, see Chapter 6.

This appendix contains cost spreadsheets for the following boilers:

<u>Boiler and NO<sub>x</sub> Control</u>	<u>Page</u>
Field-erected watertube, 766 MMBtu/hr, with LNB	F-3
FBC boiler, 460 MMBtu/hr, with urea-based SNCR	F-5
Field-erected watertube, 760 MMBtu/hr, with SCR	F-7
Boiler, 800 MMBtu/hr, with ammonia-based SNCR	F-9
Tangential-fired, 1,255 MMBtu/hr, with ammonia-based SNCR	F-11
PC boiler, 2,361, 2,870, and 6,800 MMBtu/hr, with ammonia-based SNCR	F-13
Coal-fired, 8,055 MMBtu/hr, with ammonia-based SNCR	F-19
Wall-fired, 400 MMBtu/hr, with urea-based SNCR	F-21
Spreader stoker, 303 MMBtu/hr, with urea-based SNCR	F-23

COST EFFECTIVENESS OF RETROFIT NOx CONTROLS					
BOILER TYPE:	FIELD ERECTED WATERTUBE	CHAP. 6 REFERENCES	COST BASE		
BOILER CAPACITY (MMBtu/hr):	766	CIBO, 1992	1992 DOLLARS		
FUEL TYPE:	COAL				
CONTROL METHOD:	LOW NOx BURNER				
TOTAL CAPITAL INVESTMENT COST (TCIC)					
		BOILER CAPACITY FACTOR			
		0.8	0.66	0.5	0.33
<b>A. DIRECT CAPITAL COST (DCC)</b>					
1. PURCHASED EQUIPMENT COST (PEC)					
PRIMARY AND AUXILIARY EQUIPMENT (EQP)	EQP	\$1,195,653	\$1,195,653	\$1,195,653	\$1,195,653
CEM SYSTEM					
INSTRUMENTATION		\$59,783	\$59,783	\$59,783	\$59,783
SALES TAX					
FREIGHT		\$62,772	\$62,772	\$62,772	\$62,772
*** TOTAL PURCHASED EQUIPMENT COST ***	PEC	\$1,318,207	\$1,318,207	\$1,318,207	\$1,318,207
2. DIRECT INSTALLATION COST (DIC)					
*** TOTAL DIRECT INSTALLATION COST ***	DIC	\$655,616	\$655,616	\$655,616	\$655,616
3. SITE PREP, SP (as required)					
	SP				
4. BUILDINGS, BLDG (as required)					
	BLDG				
*** TOTAL DIRECT CAPITAL COST ***	DCC	\$1,973,823	\$1,973,823	\$1,973,823	\$1,973,823
(PEC+DIC+SP+BLDG)					
<b>B. INDIRECT CAPITAL COST (ICC)</b>					
1. ENGINEERING		\$278,986	\$278,986	\$278,986	\$278,986
2. CONSTRUCTION AND FIELD EXPENSES		\$165,399	\$165,399	\$165,399	\$165,399
3. CONSTRUCTION FEE		\$49,819	\$49,819	\$49,819	\$49,819
4. STARTUP		\$79,710	\$79,710	\$79,710	\$79,710
5. PERFORMANCE TEST		\$39,855	\$39,855	\$39,855	\$39,855
*** TOTAL INDIRECT CAPITAL COST ***	ICC	\$613,768	\$613,768	\$613,768	\$613,768
<b>C. CONTINGENCY (20 percent of direct and indirect)</b>					
	CONT	\$517,518	\$517,518	\$517,518	\$517,518
*** TOTAL CAPITAL INVESTMENT COST ***	TCIC	\$3,105,110	\$3,105,110	\$3,105,110	\$3,105,110
(DCC+ICC+CONT)					

CONTINUED ON NEXT PAGE

COST EFFECTIVENESS OF RETROFIT NO <sub>x</sub> CONTROLS					
BOILER TYPE:	FIELD ERECTED WATERTUBE	CHAP. 6 REFERENCES		COST BASE	
BOILER CAPACITY (MMBtu/hr):	766	CIBO, 1992		1992 DOLLARS	
FUEL TYPE:	COAL				
CONTROL METHOD:	LOW NO <sub>x</sub> BURNER				
ANNUAL OPERATING AND MAINTENANCE COSTS (O&M)					
	CAPACITY FACTOR	0.8	0.66	0.5	0.33
<b>A. DIRECT ANNUAL COSTS (DAC)</b>					
1. OPERATING LABOR		\$21,105	\$21,105	\$21,105	\$21,105
2. MAINTENANCE LABOR					
3. MAINTENANCE MATERIALS		\$24,120	\$24,120	\$24,120	\$24,120
4. REPLACEMENT MATERIALS		\$50,250	\$50,250	\$50,250	\$50,250
5. ELECTRICITY @ \$0.05/kw-hr		\$33,440	\$27,588	\$20,900	\$13,794
6. STEAM					
7. FUEL					
8. WASTE DISPOSAL					
9. CHEMICALS					
10. OTHER					
*** TOTAL DIRECT ANNUAL COSTS ***	DAC	\$128,915	\$123,063	\$116,375	\$109,269
<b>B. INDIRECT ANNUAL COSTS (IAC)</b>					
1. OVERHEAD		\$25,125	\$25,125	\$25,125	\$25,125
2. ADMINISTRATIVE		\$49,848	\$49,848	\$49,848	\$49,848
3. PROPERTY TAX		\$24,924	\$24,924	\$24,924	\$24,924
4. INSURANCE		\$24,924	\$24,924	\$24,924	\$24,924
*** TOTAL INDIRECT ANNUAL COSTS ***	IAC	\$124,821	\$124,821	\$124,821	\$124,821
*** TOTAL ANNUAL OPERATING AND MAINTENANCE COSTS *** (DAC+IAC)	O&M	\$253,736	\$247,884	\$241,196	\$234,090
COST EFFECTIVENESS					
<b>A. TOTAL ANNUALIZED COST (incl. capital and O&amp;M)</b>					
1. ANNUALIZED CAPITAL INVESTMENT COST (ACIC)					
EXPECTED LIFETIME OF EQUIPMENT, YEARS		10	10	10	10
INTEREST RATE		0.1	0.1	0.1	0.1
CAPITAL RECOVERY FACTOR		0.1627	0.1627	0.1627	0.1627
TOTAL CAPITAL INVESTMENT COSTS (TCIC, above)		\$3,105,110	\$3,105,110	\$3,105,110	\$3,105,110
*** ANNUALIZED CAPITAL INVESTMENT COST ***	ACIC	\$505,342	\$505,342	\$505,342	\$505,342
2. ANNUAL O&M COSTS (O&M, above)	O&M	\$253,736	\$247,884	\$241,196	\$234,090
*** TOTAL ANNUALIZED COST ***	ACIC+O&M	\$759,078	\$753,226	\$746,538	\$739,432
<b>B. NO<sub>x</sub> REMOVAL PER YEAR</b>					
1. BASELINE NO <sub>x</sub> LEVEL (lb/MMBtu)	(NO <sub>x</sub> )1	0.7	0.7	0.7	0.7
2. CONTROLLED NO <sub>x</sub> LEVEL (lb/MMBtu)	(NO <sub>x</sub> )2	0.35	0.35	0.35	0.35
3. NO <sub>x</sub> REMOVAL EFFICIENCY (%)		50	50	50	50
4. CAPACITY FACTOR	CF	0.8	0.66	0.5	0.33
5. BOILER HEAT INPUT CAPACITY (MMBtu/hr)	CAP	766	766	766	766
*** NO <sub>x</sub> REMOVED PER YEAR (TONS/YR) ***					
[CAP*CF*(24 hr/day)*(365 days/yr)]*[(NO <sub>x</sub> )1-(NO <sub>x</sub> )2]/2000		939.4	775.0	587.1	387.5
*** COST EFFECTIVENESS (\$/TON NO <sub>x</sub> REMOVED, 1992 DOLLARS) ***		\$808	\$972	\$1,271	\$1,908

COST EFFECTIVENESS OF RETROFIT NO <sub>x</sub> CONTROLS					
BOILER TYPE: CIRCULATING FLUIDIZED BED		CHAP. 6 REFERENCES		COST BASE	
BOILER CAPACITY (MMBtu/hr): 460		MALCO FUEL TECH, 1992		1992 DOLLARS	
FUEL TYPE: COAL					
CONTROL METHOD: SNCR - UREA					
TOTAL CAPITAL INVESTMENT COST (TCIC)					
		BOILER CAPACITY FACTOR			
		0.8	0.66	0.5	0.33
<b>A. DIRECT CAPITAL COST (DCC)</b>					
1. PURCHASED EQUIPMENT COST (PEC)					
PRIMARY AND AUXILIARY EQUIPMENT (EQP)	EQP				
CEM SYSTEM					
INSTRUMENTATION					
SALES TAX					
FREIGHT					
*** TOTAL PURCHASED EQUIPMENT COST ***	PEC				
2. DIRECT INSTALLATION COST (DIC)					
*** TOTAL DIRECT INSTALLATION COST ***	DIC				
3. SITE PREP, SP (as required)					
	SP				
4. BUILDINGS, BLDG (as required)					
	BLDG				
*** TOTAL DIRECT CAPITAL COST ***	DCC				
(PEC+DIC+SP+BLDG)					
<b>B. INDIRECT CAPITAL COST (ICC)</b>					
1. ENGINEERING					
2. CONSTRUCTION AND FIELD EXPENSES					
3. CONSTRUCTION FEE					
4. STARTUP					
5. PERFORMANCE TEST					
*** TOTAL INDIRECT CAPITAL COST ***	ICC				
<b>C. CONTINGENCY</b>					
	CONT				
*** TOTAL CAPITAL INVESTMENT COST ***	TCIC	\$680,930	\$680,930	\$680,930	\$680,930
(DCC+ICC+CONT)					

CONTINUED ON NEXT PAGE

COST EFFECTIVENESS OF RETROFIT NO <sub>x</sub> CONTROLS						
BOILER TYPE:	CIRCULATING FLUIDIZED BED	CHAP. 6 REFERENCES	COST BASE			
BOILER CAPACITY (MMBtu/hr):	460	MALCO FUEL TECH, 1992	1992 DOLLARS			
FUEL TYPE:	COAL					
CONTROL METHOD:	SNCR - UREA					
ANNUAL OPERATING AND MAINTENANCE COSTS (O&M)						
	CAPACITY FACTOR	0.8	0.66	0.5	0.33	
<b>A. DIRECT ANNUAL COSTS (DAC)</b>						
1.	OPERATING LABOR					
2.	MAINTENANCE LABOR					
3.	MAINTENANCE MATERIALS					
4.	REPLACEMENT MATERIALS					
5.	ELECTRICITY @ \$0.05/kW-hr					
6.	STEAM					
7.	FUEL					
8.	WASTE DISPOSAL					
9.	CHEMICALS					
10.	OTHER					
***	TOTAL DIRECT ANNUAL COSTS ***	DAC				
<b>B. INDIRECT ANNUAL COSTS (IAC)</b>						
1.	OVERHEAD					
2.	ADMINISTRATIVE					
3.	PROPERTY TAX					
4.	INSURANCE					
5.	OTHER					
***	TOTAL INDIRECT ANNUAL COSTS ***	IAC				
***	TOTAL ANNUAL OPERATING AND MAINTENANCE COSTS ***	O&M	\$197,186	\$166,116	\$130,608	\$92,880
	(DAC+IAC)					
COST EFFECTIVENESS						
<b>A. TOTAL ANNUALIZED COST (incl. capital and O&amp;M)</b>						
1.	ANNUALIZED CAPITAL INVESTMENT COST (ACIC)					
	EXPECTED LIFETIME OF EQUIPMENT, YEARS	10	10	10	10	
	INTEREST RATE	0.1	0.1	0.1	0.1	
	CAPITAL RECOVERY FACTOR	0.1627	0.1627	0.1627	0.1627	
	TOTAL CAPITAL INVESTMENT COSTS (TCIC, above)	\$680,930	\$680,930	\$680,930	\$680,930	
***	ANNUALIZED CAPITAL INVESTMENT COST ***	ACIC	\$110,818	\$110,818	\$110,818	\$110,818
2.	ANNUAL O&M COSTS (O&M, above)	O&M	\$197,186	\$166,116	\$130,608	\$92,880
***	TOTAL ANNUALIZED COST ***	ACIC+O&M	\$308,004	\$276,934	\$241,426	\$203,698
<b>B. NO<sub>x</sub> REMOVAL PER YEAR</b>						
1.	BASELINE NO <sub>x</sub> LEVEL (lb/MMBtu)	(NO <sub>x</sub> )1	0.32	0.32	0.32	0.32
2.	CONTROLLED NO <sub>x</sub> LEVEL (lb/MMBtu)	(NO <sub>x</sub> )2	0.08	0.08	0.08	0.08
3.	NO <sub>x</sub> REMOVAL EFFICIENCY (%)		75	75	75	75
4.	CAPACITY FACTOR	CF	0.8	0.66	0.5	0.33
5.	BOILER HEAT INPUT CAPACITY (MMBtu/hr)	CAP	460	460	460	460
***	NO <sub>x</sub> REMOVED PER YEAR (TONS/YR) ***					
	[CAP*CF*(24 hr/day)*(365 days/yr)]*[(NO <sub>x</sub> )1-(NO <sub>x</sub> )2]/2000		386.8	319.1	241.8	159.6
***	COST EFFECTIVENESS (\$/TON NO <sub>x</sub> REMOVED, 1992 DOLLARS) ***		\$796	\$868	\$999	\$1,277

COST EFFECTIVENESS OF RETROFIT NOx CONTROLS					
BOILER TYPE: FIELD ERECTED WATERTUBE		CHAP. 6 REFERENCES		COST BASE	
BOILER CAPACITY (MMBtu/hr): 766		UTILITY BOILERS ACT, 1994		1992 DOLLARS	
FUEL TYPE: COAL					
CONTROL METHOD: SCR					
TOTAL CAPITAL INVESTMENT COST (TCIC)					
		BOILER CAPACITY FACTOR			
		0.8	0.66	0.5	0.33
<b>A. DIRECT CAPITAL COST (DCC)</b>					
1. PURCHASED EQUIPMENT COST (PEC)					
AMMONIA STORAGE AND HANDLING	EQP	\$309,347	\$309,347	\$309,347	\$309,347
SCR REACTOR (no catalyst)		\$1,003,377	\$1,003,377	\$1,003,377	\$1,003,377
FLUE GAS HANDLING		\$1,698,741	\$1,698,741	\$1,698,741	\$1,698,741
AIR HEATER MODIFICATIONS		\$382,683	\$382,683	\$382,683	\$382,683
CATALYST (\$400/CFT)		\$3,129,471	\$3,129,471	\$3,129,471	\$3,129,471
FANS		\$50,669	\$50,669	\$50,669	\$50,669
MISCELLANEOUS		\$93,337	\$93,337	\$93,337	\$93,337
*** TOTAL PURCHASED EQUIPMENT COST ***	PEC	\$6,667,626	\$6,667,626	\$6,667,626	\$6,667,626
2. DIRECT INSTALLATION COST (DIC)					
*** TOTAL DIRECT INSTALLATION COST ***	DIC	INCLUDED	INCLUDED	INCLUDED	INCLUDED
3. SITE PREP, SP (as required)					
	SP				
4. BUILDINGS, BLDG (as required)					
	BLDG				
*** TOTAL DIRECT CAPITAL COST *** (PEC+DIC+SP+BLDG)	DCC	\$6,667,626	\$6,667,626	\$6,667,626	\$6,667,626
<b>B. INDIRECT CAPITAL COST (ICC)</b>					
1. ENGINEERING		\$634,387	\$634,387	\$634,387	\$634,387
2. CONSTRUCTION AND FIELD EXPENSES		\$1,509,031	\$1,509,031	\$1,509,031	\$1,509,031
3. CONSTRUCTION FEE		\$754,665	\$754,665	\$754,665	\$754,665
4. STARTUP		\$67,788	\$67,788	\$67,788	\$67,788
5. PERFORMANCE TEST		\$33,894	\$33,894	\$33,894	\$33,894
*** TOTAL INDIRECT CAPITAL COST ***	ICC	\$2,999,765	\$2,999,765	\$2,999,765	\$2,999,765
<b>C. CONTINGENCY (20 percent of direct and indirect)</b>					
	CONT	\$1,933,478	\$1,933,478	\$1,933,478	\$1,933,478
*** TOTAL CAPITAL INVESTMENT COST *** (DCC+ICC+CONT)	TCIC	\$11,600,869	\$11,600,869	\$11,600,869	\$11,600,869

CONTINUED ON NEXT PAGE

COST EFFECTIVENESS OF RETROFIT NOx CONTROLS		
BOILER TYPE:	FIELD ERECTED WATERTUBE	CHAP. 6 REFERENCES
BOILER CAPACITY (MMBtu/hr):	766	COST BASE
FUEL TYPE:	COAL	UTILITY BOILERS ACT, 1994
CONTROL METHOD:	SCR	1992 DOLLARS

ANNUAL OPERATING AND MAINTENANCE COSTS (O&M)						
		CAPACITY FACTOR				
		0.8	0.66	0.5	0.33	
A. DIRECT ANNUAL COSTS (DAC)						
1.	OPERATING LABOR	\$96,480	\$96,480	\$96,480	\$96,480	
2.	MAINTENANCE LABOR	\$55,275	\$55,275	\$55,275	\$55,275	
3.	MAINTENANCE MATERIALS					
4.	REPLACEMENT MATERIALS (catalyst replacement) 4 YEARS LIFE	\$948,324	\$782,368	\$592,703	\$391,184	
5.	ELECTRICITY @ \$0.05/kw-hr	\$251,515	\$207,500	\$157,197	\$103,750	
6.	STEAM	\$9,600	\$7,920	\$6,000	\$3,960	
7.	FUEL					
8.	WASTE DISPOSAL (catalyst)	\$30,455	\$25,125	\$19,034	\$12,563	
9.	CHEMICALS	\$49,600	\$40,920	\$31,000	\$20,460	
10.	OTHER					
***	TOTAL DIRECT ANNUAL COSTS ***	DAC	\$1,441,249	\$1,215,588	\$957,689	\$683,671
B. INDIRECT ANNUAL COSTS (IAC)						
1.	OVERHEAD					
2.	ADMINISTRATIVE	\$91,455	\$91,455	\$91,455	\$91,455	
3.	PROPERTY TAX	\$139,690	\$139,690	\$139,690	\$139,690	
4.	INSURANCE	\$169,845	\$169,845	\$169,845	\$169,845	
***	TOTAL INDIRECT ANNUAL COSTS ***	IAC	\$570,835	\$570,835	\$570,835	\$570,835
***	TOTAL ANNUAL OPERATING AND MAINTENANCE COSTS ***	O&M	\$2,012,084	\$1,786,423	\$1,528,524	\$1,254,506
COST EFFECTIVENESS						
A. TOTAL ANNUALIZED COST (incl. capital and O&M)						
1.	ANNUALIZED CAPITAL INVESTMENT COST (ACIC)					
	EXPECTED LIFETIME OF EQUIPMENT, YEARS	10	10	10	10	
	INTEREST RATE	0.1	0.1	0.1	0.1	
	CAPITAL RECOVERY FACTOR	0.1627	0.1627	0.1627	0.1627	
	TOTAL CAPITAL INVESTMENT COSTS (TCIC, above)	\$11,600,869	\$11,600,869	\$11,600,869	\$11,600,869	
***	ANNUALIZED CAPITAL INVESTMENT COST ***	ACIC	\$1,887,988	\$1,887,988	\$1,887,988	\$1,887,988
2.	ANNUAL O&M COSTS (O&M, above)	O&M	\$2,012,084	\$1,786,423	\$1,528,524	\$1,254,506
***	TOTAL ANNUALIZED COST ***	ACIC+O&M	\$3,900,072	\$3,674,411	\$3,416,512	\$3,142,494
B. NOx REMOVAL PER YEAR						
1.	BASELINE NOx LEVEL (lb/MMBtu) (NOx)1	0.7	0.7	0.7	0.7	
2.	CONTROLLED NOx LEVEL (lb/MMBtu) (NOx)2	0.14	0.14	0.14	0.14	
3.	NOx REMOVAL EFFICIENCY (%)	80	80	80	80	
4.	CAPACITY FACTOR CF	0.8	0.66	0.5	0.33	
5.	BOILER HEAT INPUT CAPACITY (MMBtu/hr) CAP	766	766	766	766	
***	NOx REMOVED PER YEAR (TONS/YR) ***					
	[CAP*CF*(24 hr/day)*(365 days/yr)]*[(NOx)1-(NOx)2]/2000					
			1503	1240	939	620
***	COST EFFECTIVENESS (\$/TON NOx REMOVED, 1992 DOLLARS) ***		\$2,595	\$2,963	\$3,637	\$5,068

COST EFFECTIVENESS OF RETROFIT NO <sub>x</sub> CONTROLS					
BOILER TYPE: BOILER		CHAP. 6 REFERENCES	COST BASE		
BOILER CAPACITY (MMBtu/hr): 800		Exxon, 1990	1992 DOLLARS		
FUEL TYPE: COAL					
CONTROL METHOD: SNCR - AMMONIA					
TOTAL CAPITAL INVESTMENT COST (TCIC)					
		BOILER CAPACITY FACTOR			
		0.8	0.66	0.5	0.33
A. DIRECT CAPITAL COST (DCC)					
1. PURCHASED EQUIPMENT COST (PEC)					
PRIMARY AND AUXILIARY EQUIPMENT (EQP)		EQP	\$265,776	\$265,776	\$265,776
CEM SYSTEM					
INSTRUMENTATION					
SALES TAX			\$7,973	\$7,973	\$7,973
FREIGHT			\$13,289	\$13,289	\$13,289
*** TOTAL PURCHASED EQUIPMENT COST ***		PEC	\$287,038	\$287,038	\$287,038
2. DIRECT INSTALLATION COST (DIC)					
*** TOTAL DIRECT INSTALLATION COST ***		DIC	\$89,910	\$89,910	\$89,910
3. SITE PREP, SP (as required)		SP			
4. BUILDINGS, BLDG (as required)		BLDG			
*** TOTAL DIRECT CAPITAL COST *** (PEC+DIC+SP+BLDG)		DCC	\$376,948	\$376,948	\$376,948
B. INDIRECT CAPITAL COST (ICC)					
1. ENGINEERING			\$66,222	\$66,222	\$66,222
2. CONSTRUCTION AND FIELD EXPENSES			\$36,999	\$36,999	\$36,999
3. CONSTRUCTION FEE			\$32,071	\$32,071	\$32,071
4. ONE-TIME ROYALTY FEE (NO CONTINGENCY ON THIS)			\$134,179	\$134,179	\$134,179
5. OTHERS					
*** TOTAL INDIRECT CAPITAL COST ***		ICC	\$269,471	\$269,471	\$269,471
C. CONTINGENCY (15 percent of direct and indirect)		CONT	\$76,836	\$76,836	\$76,836
*** TOTAL CAPITAL INVESTMENT COST *** (DCC+ICC+CONT)		TCIC	\$723,255	\$723,255	\$723,255

CONTINUED ON NEXT PAGE



COST EFFECTIVENESS OF RETROFIT NOx CONTROLS						
BOILER TYPE: BOILER		CHAP. 6 REFERENCES		COST BASE		
BOILER CAPACITY (MMBtu/hr): 800		Exxon, 1990		1992 DOLLARS		
FUEL TYPE: COAL						
CONTROL METHOD: SNCR - AMMONIA						
ANNUAL OPERATING AND MAINTENANCE COSTS (O&M)						
		CAPACITY FACTOR	0.8	0.66	0.5	0.33
<b>A. DIRECT ANNUAL COSTS (DAC)</b>						
1.	OPERATING LABOR					
2.	MAINTENANCE LABOR					
3.	MAINTENANCE MATERIALS					
4.	REPLACEMENT MATERIALS					
5.	ELECTRICITY @ \$0.05/kw-hr					
6.	STEAM					
7.	FUEL					
8.	WASTE DISPOSAL					
9.	AMMONIA (@ \$250/TON)					
10.	OTHER					
***	TOTAL DIRECT ANNUAL COSTS ***	DAC	\$936,970	\$773,000	\$585,606	\$386,500
<b>B. INDIRECT ANNUAL COSTS (IAC)</b>						
1.	OVERHEAD (60% OF LABOR & MAINTENANCE MATL)					
2.	ADMINISTRATIVE (2% OF TCIC)					
3.	PROPERTY TAX (1% OF TCIC)					
4.	INSURANCE (1% OF TCIC)					
5.	OTHER					
***	TOTAL INDIRECT ANNUAL COSTS ***	IAC	\$28,930	\$28,930	\$28,930	\$28,930
***	TOTAL ANNUAL OPERATING AND MAINTENANCE COSTS *** (DAC+IAC)	O&M	\$965,900	\$801,930	\$614,536	\$415,430
COST EFFECTIVENESS						
<b>A. TOTAL ANNUALIZED COST (incl. capital and O&amp;M)</b>						
1.	ANNUALIZED CAPITAL INVESTMENT COST (ACIC)					
	EXPECTED LIFETIME OF EQUIPMENT, YEARS		10	10	10	10
	INTEREST RATE		0.1	0.1	0.1	0.1
	CAPITAL RECOVERY FACTOR		0.1627	0.1627	0.1627	0.1627
	TOTAL CAPITAL INVESTMENT COSTS (TCIC, above)		\$723,255	\$723,255	\$723,255	\$723,255
***	ANNUALIZED CAPITAL INVESTMENT COST ***	ACIC	\$117,706	\$117,706	\$117,706	\$117,706
2.	ANNUAL O&M COSTS (O&M, above)	O&M	\$965,900	\$801,930	\$614,536	\$415,430
***	TOTAL ANNUALIZED COST ***	ACIC+O&M	\$1,083,606	\$919,637	\$732,243	\$533,137
<b>B. NOx REMOVAL PER YEAR</b>						
1.	BASELINE NOx LEVEL (lb/MMBtu)	(NOx)1	0.7	0.7	0.7	0.7
2.	CONTROLLED NOx LEVEL (lb/MMBtu)	(NOx)2	0.39	0.39	0.39	0.39
3.	NOx REMOVAL EFFICIENCY (%)		45	45	45	45
4.	CAPACITY FACTOR	CF	0.8	0.66	0.5	0.33
5.	BOILER HEAT INPUT CAPACITY (MMBtu/hr)	CAP	800	800	800	800
***	NOx REMOVED PER YEAR (TONS/YR) *** [CAP*CF*(24 hr/day)*(365 days/yr)]*[(NOx)1-(NOx)2]/2000		883	728	552	364
***	COST EFFECTIVENESS (\$/TON NOx REMOVED, 1992 DOLLARS) ***		\$1,227	\$1,262	\$1,327	\$1,464

COST EFFECTIVENESS OF RETROFIT NOx CONTROLS					
BOILER TYPE: TANGENTIAL FIRED UTILITY BOILER		CHAP. 6 REFERENCES		COST BASE	
BOILER CAPACITY (MMBtu/hr): 1255		Exxon, 1991		1992 DOLLARS	
FUEL TYPE: COAL					
CONTROL METHOD: SNCR - AMMONIA					
TOTAL CAPITAL INVESTMENT COST (TCIC)					
		BOILER CAPACITY FACTOR			
		0.8	0.66	0.5	0.33
<b>A. DIRECT CAPITAL COST (DCC)</b>					
1. PURCHASED EQUIPMENT COST (PEC)					
PRIMARY AND AUXILIARY EQUIPMENT (EQP)	EQP	\$414,985	\$414,985	\$414,985	\$414,985
CEM SYSTEM					
INSTRUMENTATION					
SALES TAX		\$12,450	\$12,450	\$12,450	\$12,450
FREIGHT		\$20,749	\$20,749	\$20,749	\$20,749
*** TOTAL PURCHASED EQUIPMENT COST ***	PEC	\$448,184	\$448,184	\$448,184	\$448,184
2. DIRECT INSTALLATION COST (DIC)					
*** TOTAL DIRECT INSTALLATION COST ***	DIC	\$196,519	\$196,519	\$196,519	\$196,519
3. SITE PREP, SP (as required)	SP				
4. BUILDINGS, BLDG (as required)	BLDG				
*** TOTAL DIRECT CAPITAL COST *** (PEC+DIC+SP+BLDG)	DCC	\$644,703	\$644,703	\$644,703	\$644,703
<b>B. INDIRECT CAPITAL COST (ICC)</b>					
1. ENGINEERING		\$88,195	\$88,195	\$88,195	\$88,195
2. CONSTRUCTION AND FIELD EXPENSES		\$80,868	\$80,868	\$80,868	\$80,868
3. CONSTRUCTION FEE		\$124,202	\$124,202	\$124,202	\$124,202
4. ONE-TIME ROYALTY FEE (NO CONTINGENCY ON THIS)		\$169,037	\$169,037	\$169,037	\$169,037
5. OTHERS					
*** TOTAL INDIRECT CAPITAL COST ***	ICC	\$462,302	\$462,302	\$462,302	\$462,302
C. CONTINGENCY (15 percent of direct and indirect)	CONT	\$140,695	\$140,695	\$140,695	\$140,695
*** TOTAL CAPITAL INVESTMENT COST *** (DCC+ICC+CONT)	TCIC	\$1,247,701	\$1,247,701	\$1,247,701	\$1,247,701

CONTINUED ON NEXT PAGE

COST EFFECTIVENESS OF RETROFIT NO <sub>x</sub> CONTROLS						
BOILER TYPE: TANGENTIAL FIRED UTILITY BOILER		CHAP. 6 REFERENCES		COST BASE		
BOILER CAPACITY (MMBtu/hr): 1255		Exxon, 1991		1992 DOLLARS		
FUEL TYPE: COAL						
CONTROL METHOD: SNCR - AMMONIA						
ANNUAL OPERATING AND MAINTENANCE COSTS (O&M)						
		CAPACITY FACTOR	0.8	0.66	0.5	0.33
<b>A. DIRECT ANNUAL COSTS (DAC)</b>						
1.	OPERATING LABOR					
2.	MAINTENANCE LABOR					
3.	MAINTENANCE MATERIALS					
4.	REPLACEMENT MATERIALS					
5.	ELECTRICITY @ \$0.05/kw-hr					
6.	STEAM					
7.	FUEL					
8.	WASTE DISPOSAL					
9.	AMMONIA (@ \$250/TON)					
10.	OTHER					
***	TOTAL DIRECT ANNUAL COSTS ***	DAC	\$931,801	\$768,736	\$582,376	\$384,368
<b>B. INDIRECT ANNUAL COSTS (IAC)</b>						
1.	OVERHEAD (60% OF LABOR & MAINTENANCE MATL)					
2.	ADMINISTRATIVE (2% OF TCIC)					
3.	PROPERTY TAX (1% OF TCIC)					
4.	INSURANCE (1% OF TCIC)					
5.	OTHER					
***	TOTAL INDIRECT ANNUAL COSTS ***	IAC	\$49,908	\$49,908	\$49,908	\$49,908
***	TOTAL ANNUAL OPERATING AND MAINTENANCE COSTS *** (DAC+IAC)	O&M	\$981,709	\$818,644	\$632,284	\$434,276
COST EFFECTIVENESS						
<b>A. TOTAL ANNUALIZED COST (incl. capital and O&amp;M)</b>						
1.	ANNUALIZED CAPITAL INVESTMENT COST (ACIC)					
	EXPECTED LIFETIME OF EQUIPMENT, YEARS		10	10	10	10
	INTEREST RATE		0.1	0.1	0.1	0.1
	CAPITAL RECOVERY FACTOR		0.1627	0.1627	0.1627	0.1627
	TOTAL CAPITAL INVESTMENT COSTS (TCIC, above)		\$1,247,701	\$1,247,701	\$1,247,701	\$1,247,701
***	ANNUALIZED CAPITAL INVESTMENT COST ***	ACIC	\$203,058	\$203,058	\$203,058	\$203,058
2.	ANNUAL O&M COSTS (O&M, above)	O&M	\$981,709	\$818,644	\$632,284	\$434,276
***	TOTAL ANNUALIZED COST ***	ACIC+O&M	\$1,184,767	\$1,021,702	\$835,341	\$637,334
<b>B. NO<sub>x</sub> REMOVAL PER YEAR</b>						
1.	BASELINE NO <sub>x</sub> LEVEL (lb/MMBtu)	(NO <sub>x</sub> )1	0.7	0.7	0.7	0.7
2.	CONTROLLED NO <sub>x</sub> LEVEL (lb/MMBtu)	(NO <sub>x</sub> )2	0.39	0.39	0.39	0.39
3.	NO <sub>x</sub> REMOVAL EFFICIENCY (%)		45	45	45	45
4.	CAPACITY FACTOR	CF	0.8	0.66	0.5	0.33
5.	BOILER HEAT INPUT CAPACITY (MMBtu/hr)	CAP	1255	1255	1255	1255
***	NO <sub>x</sub> REMOVED PER YEAR (TONS/YR) *** [CAP*CF*(24 hr/day)*(365 days/yr)]*[(NO <sub>x</sub> )1-(NO <sub>x</sub> )2]/2000		1385	1143	866	571
***	COST EFFECTIVENESS (\$/TON NO <sub>x</sub> REMOVED, 1992 DOLLARS) ***		\$855	\$894	\$965	\$1,115

COST EFFECTIVENESS OF RETROFIT NOx CONTROLS					
BOILER TYPE: PC BOILER		CHAP. 6 REFERENCES		COST BASE	
BOILER CAPACITY (MMBtu/hr): 2361		Exxon, 1992		1992 DOLLARS	
FUEL TYPE: COAL					
CONTROL METHOD: SNCR - AMMONIA					
TOTAL CAPITAL INVESTMENT COST (TCIC)					
		BOILER CAPACITY FACTOR			
		0.8	0.66	0.5	0.33
<b>A. DIRECT CAPITAL COST (DCC)</b>					
1. PURCHASED EQUIPMENT COST (PEC)					
PRIMARY AND AUXILIARY EQUIPMENT (EQP)	EQP	\$463,810	\$463,810	\$463,810	\$463,810
CEN SYSTEM					
INSTRUMENTATION					
SALES TAX		\$13,914	\$13,914	\$13,914	\$13,914
FREIGHT		\$23,191	\$23,191	\$23,191	\$23,191
*** TOTAL PURCHASED EQUIPMENT COST ***	PEC	\$500,915	\$500,915	\$500,915	\$500,915
2. DIRECT INSTALLATION COST (DIC)					
*** TOTAL DIRECT INSTALLATION COST ***	DIC	\$114,420	\$114,420	\$114,420	\$114,420
3. SITE PREP, SP (as required)		SP			
4. BUILDINGS, BLDG (as required)		BLDG			
*** TOTAL DIRECT CAPITAL COST *** (PEC+DIC+SP+BLDG)	DCC	\$615,335	\$615,335	\$615,335	\$615,335
<b>B. INDIRECT CAPITAL COST (ICC)</b>					
1. ENGINEERING		\$328,950	\$328,950	\$328,950	\$328,950
2. CONSTRUCTION AND FIELD EXPENSES		\$35,017	\$35,017	\$35,017	\$35,017
3. CONSTRUCTION FEE		\$47,600	\$47,600	\$47,600	\$47,600
4. ONE-TIME ROYALTY FEE (NO CONTINGENCY ON THIS)		\$506,100	\$506,100	\$506,100	\$506,100
5. OTHERS					
*** TOTAL INDIRECT CAPITAL COST ***	ICC	\$917,667	\$917,667	\$917,667	\$917,667
C. CONTINGENCY (15 percent of direct and indirect)		CONT			
		\$154,035	\$154,035	\$154,035	\$154,035
*** TOTAL CAPITAL INVESTMENT COST *** (DCC+ICC+CONT)	TCIC	\$1,687,037	\$1,687,037	\$1,687,037	\$1,687,037

CONTINUED ON NEXT PAGE

COST EFFECTIVENESS OF RETROFIT NOx CONTROLS						
BOILER TYPE: PC BOILER		CHAP. 6 REFERENCES		COST BASE		
BOILER CAPACITY (MMBtu/hr): 2361		Exxon, 1992		1992 DOLLARS		
FUEL TYPE: COAL						
CONTROL METHOD: SNCR - AMMONIA						
ANNUAL OPERATING AND MAINTENANCE COSTS (O&M)						
		CAPACITY FACTOR	0.8	0.66	0.5	0.33
<b>A. DIRECT ANNUAL COSTS (DAC)</b>						
1.	OPERATING LABOR					
2.	MAINTENANCE LABOR					
3.	MAINTENANCE MATERIALS					
4.	REPLACEMENT MATERIALS					
5.	ELECTRICITY @ \$0.05/kW-hr					
6.	STEAM					
7.	FUEL					
8.	WASTE DISPOSAL					
9.	AMMONIA (@ \$250/TON)					
10.	OTHER					
***	TOTAL DIRECT ANNUAL COSTS ***	DAC	\$1,236,474	\$1,020,091	\$772,796	\$510,046
<b>B. INDIRECT ANNUAL COSTS (IAC)</b>						
1.	OVERHEAD (60% OF LABOR & MAINTENANCE MATL)					
2.	ADMINISTRATIVE (2% OF TCIC)		\$33,741	\$33,741	\$33,741	\$33,741
3.	PROPERTY TAX (1% OF TCIC)		\$16,870	\$16,870	\$16,870	\$16,870
4.	INSURANCE (1% OF TCIC)		\$16,870	\$16,870	\$16,870	\$16,870
5.	OTHER					
***	TOTAL INDIRECT ANNUAL COSTS ***	IAC	\$67,481	\$67,481	\$67,481	\$67,481
***	TOTAL ANNUAL OPERATING AND MAINTENANCE COSTS *** (DAC+IAC)	O&M	\$1,303,955	\$1,087,573	\$840,278	\$577,527
COST EFFECTIVENESS						
<b>A. TOTAL ANNUALIZED COST (incl. capital and O&amp;M)</b>						
1. ANNUALIZED CAPITAL INVESTMENT COST (ACIC)						
EXPECTED LIFETIME OF EQUIPMENT, YEARS						
			10	10	10	10
INTEREST RATE						
			0.1	0.1	0.1	0.1
CAPITAL RECOVERY FACTOR						
			0.1627	0.1627	0.1627	0.1627
TOTAL CAPITAL INVESTMENT COSTS (TCIC, above)						
			\$1,687,037	\$1,687,037	\$1,687,037	\$1,687,037
***	ANNUALIZED CAPITAL INVESTMENT COST ***	ACIC	\$274,558	\$274,558	\$274,558	\$274,558
2.	ANNUAL O&M COSTS (O&M, above)	O&M	\$1,303,955	\$1,087,573	\$840,278	\$577,527
***	TOTAL ANNUALIZED COST ***	ACIC+O&M	\$1,578,513	\$1,362,130	\$1,114,835	\$852,085
<b>B. NOx REMOVAL PER YEAR</b>						
1.	BASELINE NOx LEVEL (lb/MMBtu)	(NOx)1	0.7	0.7	0.7	0.7
2.	CONTROLLED NOx LEVEL (lb/MMBtu)	(NOx)2	0.39	0.39	0.39	0.39
3.	NOx REMOVAL EFFICIENCY (%)		45	45	45	45
4.	CAPACITY FACTOR	CF	0.8	0.66	0.5	0.33
5.	BOILER HEAT INPUT CAPACITY (MMBtu/hr)	CAP	2361	2361	2361	2361
***	NOx REMOVED PER YEAR (TONS/YR) *** [CAP*CF*(24 hr/day)*(365 days/yr)]*[(NOx)1-(NOx)2]/2000		2606	2150	1629	1075
***	COST EFFECTIVENESS (\$/TON NOx REMOVED, 1992 DOLLARS) ***		\$606	\$634	\$684	\$793

COST EFFECTIVENESS OF RETROFIT NO <sub>x</sub> CONTROLS					
BOILER TYPE: BOILER		CHAP. 6 REFERENCES		COST BASE	
BOILER CAPACITY (MMBtu/hr): 2870		Exxon, 1989		1992 DOLLARS	
FUEL TYPE: PULVERIZED COAL					
CONTROL METHOD: SNCR - AMMONIA					
TOTAL CAPITAL INVESTMENT COST (TCIC)					
		BOILER CAPACITY FACTOR			
		0.8	0.66	0.5	0.33
<b>A. DIRECT CAPITAL COST (DCC)</b>					
1. PURCHASED EQUIPMENT COST (PEC)					
PRIMARY AND AUXILIARY EQUIPMENT (EQP)	EQP	\$566,549	\$566,549	\$566,549	\$566,549
CEM SYSTEM					
INSTRUMENTATION					
SALES TAX		\$16,996	\$16,996	\$16,996	\$16,996
FREIGHT		\$28,327	\$28,327	\$28,327	\$28,327
*** TOTAL PURCHASED EQUIPMENT COST ***	PEC	\$611,873	\$611,873	\$611,873	\$611,873
2. DIRECT INSTALLATION COST (DIC)					
*** TOTAL DIRECT INSTALLATION COST ***	DIC	\$184,494	\$184,494	\$184,494	\$184,494
3. SITE PREP. SP (as required)					
	SP				
4. BUILDINGS, BLDG (as required)					
	BLDG				
*** TOTAL DIRECT CAPITAL COST ***	DCC	\$796,367	\$796,367	\$796,367	\$796,367
(PEC+DIC+SP+BLDG)					
<b>B. INDIRECT CAPITAL COST (ICC)</b>					
1. ENGINEERING		\$326,368	\$326,368	\$326,368	\$326,368
2. CONSTRUCTION AND FIELD EXPENSES		\$65,034	\$65,034	\$65,034	\$65,034
3. CONSTRUCTION FEE		\$116,607	\$116,607	\$116,607	\$116,607
4. ONE-TIME ROYALTY FEE (NO CONTINGENCY ON THIS)		\$901,397	\$901,397	\$901,397	\$901,397
5. OTHERS					
*** TOTAL INDIRECT CAPITAL COST ***	ICC	\$1,409,406	\$1,409,406	\$1,409,406	\$1,409,406
<b>C. CONTINGENCY (15 percent of direct and indirect)</b>					
	CONT	\$195,656	\$195,656	\$195,656	\$195,656
*** TOTAL CAPITAL INVESTMENT COST ***	TCIC	\$2,401,430	\$2,401,430	\$2,401,430	\$2,401,430
(DCC+ICC+CONT)					

CONTINUED ON NEXT PAGE

COST EFFECTIVENESS OF RETROFIT NO <sub>x</sub> CONTROLS						
BOILER TYPE: BOILER		CHAP. 6 REFERENCES		COST BASE		
BOILER CAPACITY (MMBtu/hr): 2870		Exxon, 1989		1992 DOLLARS		
FUEL TYPE: PULVERIZED COAL						
CONTROL METHOD: SNCR - AMMONIA						
ANNUAL OPERATING AND MAINTENANCE COSTS (O&M)						
		CAPACITY FACTOR	0.8	0.66	0.5	0.33
<b>A. DIRECT ANNUAL COSTS (DAC)</b>						
1.	OPERATING LABOR					
2.	MAINTENANCE LABOR					
3.	MAINTENANCE MATERIALS					
4.	REPLACEMENT MATERIALS					
5.	ELECTRICITY @ \$0.05/kw-hr	\$380,885	\$314,230	\$238,053	\$157,115	
6.	STEAM					
7.	FUEL					
8.	WASTE DISPOSAL					
9.	AMMONIA (@ \$250/TON)	\$996,450	\$822,071	\$622,781	\$411,036	
10.	OTHER					
*** TOTAL DIRECT ANNUAL COSTS ***		DAC	\$1,377,335	\$1,136,301	\$860,834	\$568,151
<b>B. INDIRECT ANNUAL COSTS (IAC)</b>						
1.	OVERHEAD (60% OF LABOR & MAINTENANCE MATL)	\$0	\$0	\$0	\$0	
2.	ADMINISTRATIVE (2% OF TCIC)	\$48,029	\$48,029	\$48,029	\$48,029	
3.	PROPERTY TAX (1% OF TCIC)	\$24,014	\$24,014	\$24,014	\$24,014	
4.	INSURANCE (1% OF TCIC)	\$24,014	\$24,014	\$24,014	\$24,014	
5.	OTHER					
*** TOTAL INDIRECT ANNUAL COSTS ***		IAC	\$96,057	\$96,057	\$96,057	\$96,057
*** TOTAL ANNUAL OPERATING AND MAINTENANCE COSTS *** (DAC+IAC)		O&M	\$1,473,392	\$1,232,358	\$956,891	\$664,208
COST EFFECTIVENESS						
<b>A. TOTAL ANNUALIZED COST (incl. capital and O&amp;M)</b>						
1.	ANNUALIZED CAPITAL INVESTMENT COST (ACIC)					
EXPECTED LIFETIME OF EQUIPMENT, YEARS		10	10	10	10	
INTEREST RATE		0.1	0.1	0.1	0.1	
CAPITAL RECOVERY FACTOR		0.1627	0.1627	0.1627	0.1627	
TOTAL CAPITAL INVESTMENT COSTS (TCIC, above)		\$2,401,430	\$2,401,430	\$2,401,430	\$2,401,430	
*** ANNUALIZED CAPITAL INVESTMENT COST ***		ACIC	\$390,822	\$390,822	\$390,822	\$390,822
2.	ANNUAL O&M COSTS (O&M, above)	O&M	\$1,473,392	\$1,232,358	\$956,891	\$664,208
*** TOTAL ANNUALIZED COST ***		ACIC+O&M	\$1,864,214	\$1,623,180	\$1,347,713	\$1,055,029
<b>B. NO<sub>x</sub> REMOVAL PER YEAR</b>						
1.	BASELINE NO <sub>x</sub> LEVEL (lb/MMBtu)	(NO <sub>x</sub> )1	0.7	0.7	0.7	0.7
2.	CONTROLLED NO <sub>x</sub> LEVEL (lb/MMBtu)	(NO <sub>x</sub> )2	0.39	0.39	0.39	0.39
3.	NO <sub>x</sub> REMOVAL EFFICIENCY (%)		45	45	45	45
4.	CAPACITY FACTOR	CF	0.8	0.66	0.5	0.33
5.	BOILER HEAT INPUT CAPACITY (MMBtu/hr)	CAP	2870	2870	2870	2870
*** NO <sub>x</sub> REMOVED PER YEAR (TONS/YR) *** [CAP*CF*(24 hr/day)*(365 days/yr)]*[(NO <sub>x</sub> )1-(NO <sub>x</sub> )2]/2000			3168	2613	1980	1307
*** COST EFFECTIVENESS (\$/TON NO <sub>x</sub> REMOVED, 1992 DOLLARS) ***			\$588	\$621	\$681	\$807

COST EFFECTIVENESS OF RETROFIT NOx CONTROLS						
BOILER TYPE: PC BOILER		CHAP. 6 REFERENCES		COST BASE		
BOILER CAPACITY (MMBtu/hr): 6800		Exxon, 1992		1992 DOLLARS		
FUEL TYPE: COAL						
CONTROL METHOD: SNCR - AMMONIA						
TOTAL CAPITAL INVESTMENT COST (TCIC)						
		BOILER CAPACITY FACTOR				
		0.8	0.66	0.5	0.33	
A. DIRECT CAPITAL COST (DCC)						
1. PURCHASED EQUIPMENT COST (PEC)						
PRIMARY AND AUXILIARY EQUIPMENT (EQP)		EQP	\$1,006,700	\$1,006,700	\$1,006,700	\$1,006,700
CEM SYSTEM						
INSTRUMENTATION						
SALES TAX			\$30,201	\$30,201	\$30,201	\$30,201
FREIGHT			\$50,335	\$50,335	\$50,335	\$50,335
*** TOTAL PURCHASED EQUIPMENT COST ***		PEC	\$1,087,236	\$1,087,236	\$1,087,236	\$1,087,236
2. DIRECT INSTALLATION COST (DIC)						
*** TOTAL DIRECT INSTALLATION COST ***		DIC	\$214,610	\$214,610	\$214,610	\$214,610
3. SITE PREP. SP (as required)		SP				
4. BUILDINGS, BLDG (as required)		BLDG				
*** TOTAL DIRECT CAPITAL COST *** (PEC+DIC+SP+BLDG)		DCC	\$1,301,846	\$1,301,846	\$1,301,846	\$1,301,846
B. INDIRECT CAPITAL COST (ICC)						
1. ENGINEERING			\$392,500	\$392,500	\$392,500	\$392,500
2. CONSTRUCTION AND FIELD EXPENSES			\$90,780	\$90,780	\$90,780	\$90,780
3. CONSTRUCTION FEE			\$89,280	\$89,280	\$89,280	\$89,280
4. ONE-TIME ROYALTY FEE (NO CONTINGENCY ON THIS)			\$950,000	\$950,000	\$950,000	\$950,000
5. OTHERS						
*** TOTAL INDIRECT CAPITAL COST ***		ICC	\$1,522,560	\$1,522,560	\$1,522,560	\$1,522,560
C. CONTINGENCY (15 percent of direct and indirect)		CONT	\$281,161	\$281,161	\$281,161	\$281,161
*** TOTAL CAPITAL INVESTMENT COST *** (DCC+ICC+CONT)		TCIC	\$3,105,567	\$3,105,567	\$3,105,567	\$3,105,567

CONTINUED ON NEXT PAGE



COST EFFECTIVENESS OF RETROFIT NOx CONTROLS						
BOILER TYPE: PC BOILER		CHAP. 6 REFERENCES		COST BASE		
BOILER CAPACITY (MMBtu/hr): 6800		Exxon, 1992		1992 DOLLARS		
FUEL TYPE: COAL						
CONTROL METHOD: SNCR - AMMONIA						
ANNUAL OPERATING AND MAINTENANCE COSTS (O&M)						
		CAPACITY FACTOR	0.8	0.66	0.5	0.33
<b>A. DIRECT ANNUAL COSTS (DAC)</b>						
1.	OPERATING LABOR					
2.	MAINTENANCE LABOR					
3.	MAINTENANCE MATERIALS					
4.	REPLACEMENT MATERIALS					
5.	ELECTRICITY @ \$0.05/kw-hr	\$833,952	\$688,010	\$521,220	\$344,005	
6.	STEAM					
7.	FUEL					
8.	WASTE DISPOSAL					
9.	AMMONIA (@ \$250/TON)	\$2,923,650	\$2,412,011	\$1,827,281	\$1,206,006	
10.	OTHER					
*** TOTAL DIRECT ANNUAL COSTS ***		DAC	\$3,757,602	\$3,100,022	\$2,348,501	\$1,550,011
<b>B. INDIRECT ANNUAL COSTS (IAC)</b>						
1.	OVERHEAD (60% OF LABOR & MAINTENANCE MATL)					
2.	ADMINISTRATIVE (2% OF TCIC)	\$62,111	\$62,111	\$62,111	\$62,111	
3.	PROPERTY TAX (1% OF TCIC)	\$31,056	\$31,056	\$31,056	\$31,056	
4.	INSURANCE (1% OF TCIC)	\$31,056	\$31,056	\$31,056	\$31,056	
5.	OTHER					
*** TOTAL INDIRECT ANNUAL COSTS ***		IAC	\$124,223	\$124,223	\$124,223	\$124,223
*** TOTAL ANNUAL OPERATING AND MAINTENANCE COSTS *** (DAC+IAC)		O&M	\$3,881,825	\$3,224,244	\$2,472,724	\$1,674,234
COST EFFECTIVENESS						
<b>A. TOTAL ANNUALIZED COST (incl. capital and O&amp;M)</b>						
1. ANNUALIZED CAPITAL INVESTMENT COST (ACIC)						
EXPECTED LIFETIME OF EQUIPMENT, YEARS			10	10	10	10
INTEREST RATE			0.1	0.1	0.1	0.1
CAPITAL RECOVERY FACTOR			0.1627	0.1627	0.1627	0.1627
TOTAL CAPITAL INVESTMENT COSTS (TCIC, above)			\$3,105,567	\$3,105,567	\$3,105,567	\$3,105,567
*** ANNUALIZED CAPITAL INVESTMENT COST ***		ACIC	\$505,417	\$505,417	\$505,417	\$505,417
2. ANNUAL O&M COSTS (O&M, above)		O&M	\$3,881,825	\$3,224,244	\$2,472,724	\$1,674,234
*** TOTAL ANNUALIZED COST ***		ACIC+O&M	\$4,387,241	\$3,729,661	\$2,978,141	\$2,179,650
<b>B. NOx REMOVAL PER YEAR</b>						
1.	BASELINE NOx LEVEL (lb/MMBtu)	(NOx)1	0.7	0.7	0.7	0.7
2.	CONTROLLED NOx LEVEL (lb/MMBtu)	(NOx)2	0.39	0.39	0.39	0.39
3.	NOx REMOVAL EFFICIENCY (%)		45	45	45	45
4.	CAPACITY FACTOR	CF	0.8	0.66	0.5	0.33
5.	BOILER HEAT INPUT CAPACITY (MMBtu/hr)	CAP	6800	6800	6800	6800
*** NOx REMOVED PER YEAR (TONS/YR) ***						
[CAP*CF*(24 hr/day)*(365 days/yr)]*[(NOx)1-(NOx)2]/2000			7506	6192	4691	3096
*** COST EFFECTIVENESS (\$/TON NOx REMOVED, 1992 DOLLARS) ***			\$585	\$602	\$635	\$704

COST EFFECTIVENESS OF RETROFIT NOx CONTROLS					
BOILER TYPE: BOILER		CHAP. 6 REFERENCES		COST BASE	
BOILER CAPACITY (MMBtu/hr): 8055		Exxon, 1990		1992 DOLLARS	
FUEL TYPE: COAL					
CONTROL METHOD: SNCR - AMMONIA					
TOTAL CAPITAL INVESTMENT COST (TCIC)					
		BOILER CAPACITY FACTOR			
		0.8	0.66	0.5	0.33
A. DIRECT CAPITAL COST (DCC)					
1. PURCHASED EQUIPMENT COST (PEC)					
PRIMARY AND AUXILIARY EQUIPMENT (EQP)	EQP	\$1,078,918	\$1,078,918	\$1,078,918	\$1,078,918
CEM SYSTEM					
INSTRUMENTATION					
SALES TAX		\$32,368	\$32,368	\$32,368	\$32,368
FREIGHT		\$53,946	\$53,946	\$53,946	\$53,946
*** TOTAL PURCHASED EQUIPMENT COST ***	PEC	\$1,165,231	\$1,165,231	\$1,165,231	\$1,165,231
2. DIRECT INSTALLATION COST (DIC)					
*** TOTAL DIRECT INSTALLATION COST ***	DIC	\$1,085,967	\$1,085,967	\$1,085,967	\$1,085,967
3. SITE PREP, SP (as required)					
	SP				
4. BUILDINGS, BLDG (as required)					
	BLDG				
*** TOTAL DIRECT CAPITAL COST *** (PEC+DIC+SP+BLDG)	DCC	\$2,251,198	\$2,251,198	\$2,251,198	\$2,251,198
B. INDIRECT CAPITAL COST (ICC)					
1. ENGINEERING		\$397,369	\$397,369	\$397,369	\$397,369
2. CONSTRUCTION AND FIELD EXPENSES		\$121,081	\$121,081	\$121,081	\$121,081
3. CONSTRUCTION FEE		\$119,459	\$119,459	\$119,459	\$119,459
4. ONE-TIME ROYALTY FEE (NO CONTINGENCY ON THIS)		\$1,680,539	\$1,680,539	\$1,680,539	\$1,680,539
5. OTHERS					
*** TOTAL INDIRECT CAPITAL COST ***	ICC	\$2,318,449	\$2,318,449	\$2,318,449	\$2,318,449
C. CONTINGENCY (15 percent of direct and indirect)					
	CONT	\$433,366	\$433,366	\$433,366	\$433,366
*** TOTAL CAPITAL INVESTMENT COST *** (DCC+ICC+CONT)	TCIC	\$5,003,013	\$5,003,013	\$5,003,013	\$5,003,013

CONTINUED ON NEXT PAGE

COST EFFECTIVENESS OF RETROFIT NO <sub>x</sub> CONTROLS						
BOILER TYPE: BOILER		CHAP. 6 REFERENCES		COST BASE		
BOILER CAPACITY (MMBtu/hr): 8055		Exxon, 1990		1992 DOLLARS		
FUEL TYPE: COAL						
CONTROL METHOD: SNCR - AMMONIA						
ANNUAL OPERATING AND MAINTENANCE COSTS (O&M)						
		CAPACITY FACTOR	0.8	0.66	0.5	0.33
<b>A. DIRECT ANNUAL COSTS (DAC)</b>						
1.	OPERATING LABOR					
2.	MAINTENANCE LABOR					
3.	MAINTENANCE MATERIALS					
4.	REPLACEMENT MATERIALS					
5.	ELECTRICITY @ \$0.05/kW-hr	\$1,178,746	\$972,465	\$736,716	\$486,233	
6.	STEAM					
7.	FUEL					
8.	WASTE DISPOSAL					
9.	AMMONIA (@ \$250/TON)	\$2,474,700	\$2,041,628	\$1,546,688	\$1,020,814	
10.	OTHER					
***	TOTAL DIRECT ANNUAL COSTS ***	DAC	\$3,653,446	\$3,014,093	\$2,283,404	\$1,507,046
<b>B. INDIRECT ANNUAL COSTS (IAC)</b>						
1.	OVERHEAD (60% OF LABOR & MAINTENANCE MATL)					
2.	ADMINISTRATIVE (2% OF TCIC)	\$100,060	\$100,060	\$100,060	\$100,060	
3.	PROPERTY TAX (1% OF TCIC)	\$50,030	\$50,030	\$50,030	\$50,030	
4.	INSURANCE (1% OF TCIC)	\$50,030	\$50,030	\$50,030	\$50,030	
5.	OTHER					
***	TOTAL INDIRECT ANNUAL COSTS ***	IAC	\$200,121	\$200,121	\$200,121	\$200,121
***	TOTAL ANNUAL OPERATING AND MAINTENANCE COSTS *** (DAC+IAC)	O&M	\$3,853,566	\$3,214,213	\$2,483,524	\$1,707,167
COST EFFECTIVENESS						
<b>A. TOTAL ANNUALIZED COST (incl. capital and O&amp;M)</b>						
1.	ANNUALIZED CAPITAL INVESTMENT COST (ACIC)					
	EXPECTED LIFETIME OF EQUIPMENT, YEARS	10	10	10	10	
	INTEREST RATE	0.1	0.1	0.1	0.1	
	CAPITAL RECOVERY FACTOR	0.1627	0.1627	0.1627	0.1627	
	TOTAL CAPITAL INVESTMENT COSTS (TCIC, above)	\$5,003,013	\$5,003,013	\$5,003,013	\$5,003,013	
***	ANNUALIZED CAPITAL INVESTMENT COST ***	ACIC	\$814,217	\$814,217	\$814,217	\$814,217
2.	ANNUAL O&M COSTS (O&M, above)	O&M	\$3,853,566	\$3,214,213	\$2,483,524	\$1,707,167
***	TOTAL ANNUALIZED COST ***	ACIC+O&M	\$4,667,784	\$4,028,431	\$3,297,741	\$2,521,384
<b>B. NO<sub>x</sub> REMOVAL PER YEAR</b>						
1.	BASELINE NO <sub>x</sub> LEVEL (lb/MMBtu)	(NO <sub>x</sub> )1	0.7	0.7	0.7	0.7
2.	CONTROLLED NO <sub>x</sub> LEVEL (lb/MMBtu)	(NO <sub>x</sub> )2	0.39	0.39	0.39	0.39
3.	NO <sub>x</sub> REMOVAL EFFICIENCY (%)		45	45	45	45
4.	CAPACITY FACTOR	CF	0.8	0.66	0.5	0.33
5.	BOILER HEAT INPUT CAPACITY (MMBtu/hr)	CAP	8055	8055	8055	8055
***	NO <sub>x</sub> REMOVED PER YEAR (TONS/YR) *** [CAP*CF*(24 hr/day)*(365 days/yr)]*[(NO <sub>x</sub> )1-(NO <sub>x</sub> )2]/2000		8891	7335	5557	3667
***	COST EFFECTIVENESS (\$/TON NO <sub>x</sub> REMOVED, 1992 DOLLARS) ***		\$525	\$549	\$593	\$688

COST EFFECTIVENESS OF RETROFIT NOx CONTROLS					
BOILER TYPE: WALL-FIRED		CHAP. 6 REFERENCES		COST BASE	
BOILER CAPACITY (MMBtu/hr): 400		NALCO FUEL TECH, 1994		1992 DOLLARS	
FUEL TYPE: PULVERIZED COAL					
CONTROL METHOD: SNCR - UREA					
TOTAL CAPITAL INVESTMENT COST (TCIC)					
		BOILER CAPACITY FACTOR			
		0.8	0.66	0.5	0.33
A. DIRECT CAPITAL COST (DCC)					
1. PURCHASED EQUIPMENT COST (PEC)					
PRIMARY AND AUXILIARY EQUIPMENT (EQP)	EQP	\$580,000	\$580,000	\$580,000	\$580,000
CEM SYSTEM					
INSTRUMENTATION					
SALES TAX					
FREIGHT					
*** TOTAL PURCHASED EQUIPMENT COST ***	PEC	\$580,000	\$580,000	\$580,000	\$580,000
2. DIRECT INSTALLATION COST (DIC)					
*** TOTAL DIRECT INSTALLATION COST ***	DIC	\$177,000	\$177,000	\$177,000	\$177,000
3. SITE PREP, SP (as required)					
	SP				
4. BUILDINGS, BLDG (as required)					
	BLDG				
*** TOTAL DIRECT CAPITAL COST *** (PEC+DIC+SP+BLDG)	DCC	\$757,000	\$757,000	\$757,000	\$757,000
B. INDIRECT CAPITAL COST (ICC)					
1. ENGINEERING					
2. CONSTRUCTION AND FIELD EXPENSES					
3. CONSTRUCTION FEE					
4. STARTUP					
5. PERFORMANCE TEST					
*** TOTAL INDIRECT CAPITAL COST ***	ICC	Included	Included	Included	Included
C. CONTINGENCY (10 PERCENT - not considered by NALCO)					
	CONT	\$75,700	\$75,700	\$75,700	\$75,700
*** TOTAL CAPITAL INVESTMENT COST *** (DCC+ICC+CONT)	ICIC	\$832,700	\$832,700	\$832,700	\$832,700

CONTINUED ON NEXT PAGE

COST EFFECTIVENESS OF RETROFIT NOx CONTROLS						
BOILER TYPE: WALL-FIRED		CHAP. 6 REFERENCES		COST BASE		
BOILER CAPACITY (MMBtu/hr): 400		NALCO FUEL TECH, 1994		1992 DOLLARS		
FUEL TYPE: PULVERIZED COAL						
CONTROL METHOD: SNCR - UREA						
ANNUAL OPERATING AND MAINTENANCE COSTS (O&M)						
		CAPACITY FACTOR	0.8	0.66	0.5	0.33
<b>A. DIRECT ANNUAL COSTS (DAC)</b>						
1.	OPERATING LABOR					
2.	MAINTENANCE LABOR					
3.	MAINTENANCE MATERIALS		\$10,600	\$10,600	\$10,600	\$10,600
4.	REPLACEMENT MATERIALS					
5.	ELECTRICITY @ \$0.05/kW-hr		\$8,376	\$6,911	\$5,235	\$3,455
6.	STEAM					
7.	FUEL					
8.	WASTE DISPOSAL					
9.	CHEMICALS		\$303,059	\$227,294	\$189,412	\$125,012
10.	OTHER					
*** TOTAL DIRECT ANNUAL COSTS ***		DAC	\$322,035	\$244,805	\$205,247	\$139,067
<b>B. INDIRECT ANNUAL COSTS (IAC)</b>						
1.	OVERHEAD					
2.	ADMINISTRATIVE					
3.	PROPERTY TAX					
4.	INSURANCE					
5.	OTHER					
*** TOTAL INDIRECT ANNUAL COSTS ***		IAC	Included	Included	Included	Included
*** TOTAL ANNUAL OPERATING AND MAINTENANCE COSTS *** (DAC+IAC)		O&M	\$322,035	\$244,805	\$205,247	\$139,067
COST EFFECTIVENESS						
<b>A. TOTAL ANNUALIZED COST (incl. capital and O&amp;M)</b>						
1. ANNUALIZED CAPITAL INVESTMENT COST (ACIC)						
EXPECTED LIFETIME OF EQUIPMENT, YEARS			10	10	10	10
INTEREST RATE			0.1	0.1	0.1	0.1
CAPITAL RECOVERY FACTOR			0.1627	0.1627	0.1627	0.1627
TOTAL CAPITAL INVESTMENT COSTS (TCIC, above)			\$832,700	\$832,700	\$832,700	\$832,700
*** ANNUALIZED CAPITAL INVESTMENT COST ***		ACIC	\$135,518	\$135,518	\$135,518	\$135,518
2. ANNUAL O&M COSTS (O&M, above)		O&M	\$322,035	\$244,805	\$205,247	\$139,067
*** TOTAL ANNUALIZED COST ***		ACIC+O&M	\$457,553	\$380,323	\$340,765	\$274,585
<b>B. NOx REMOVAL PER YEAR</b>						
1.	BASELINE NOx LEVEL (lb/MMBtu)	(NOx)1	0.7	0.7	0.7	0.7
2.	CONTROLLED NOx LEVEL (lb/MMBtu)	(NOx)2	0.39	0.39	0.39	0.39
3.	NOx REMOVAL EFFICIENCY (%)		45	45	45	45
4.	CAPACITY FACTOR	CF	0.8	0.66	0.5	0.33
5.	BOILER HEAT INPUT CAPACITY (MMBtu/hr)	CAP	400	400	400	400
*** NOx REMOVED PER YEAR (TONS/YR) *** [CAP*CF*(24 hr/day)*(365 days/yr)]*[(NOx)1-(NOx)2]/2000			441.5	364.2	275.9	182.1
*** COST EFFECTIVENESS (\$/TON NOx REMOVED, 1992 DOLLARS) ***			\$1,036	\$1,044	\$1,235	\$1,508

COST EFFECTIVENESS OF RETROFIT NOx CONTROLS					
BOILER TYPE: SPREADER STOKER		CHAP. 6 REFERENCES		COST BASE	
BOILER CAPACITY (MMBtu/hr): 303		NALCO FUEL TECH. 1992		1992 DOLLARS	
FUEL TYPE: COAL					
CONTROL METHOD: SNCR - UREA					
TOTAL CAPITAL INVESTMENT COST (TCIC)					
		BOILER CAPACITY FACTOR			
		0.8	0.66	0.5	0.33
A. DIRECT CAPITAL COST (DCC)					
1. PURCHASED EQUIPMENT COST (PEC)					
PRIMARY AND AUXILIARY EQUIPMENT (EQP)      EQP					
CEM SYSTEM					
INSTRUMENTATION					
SALES TAX					
FREIGHT					
*** TOTAL PURCHASED EQUIPMENT COST ***      PEC					
2. DIRECT INSTALLATION COST (DIC)					
*** TOTAL DIRECT INSTALLATION COST ***      DIC					
3. SITE PREP, SP (as required)      SP					
4. BUILDINGS, BLDG (as required)      BLDG					
*** TOTAL DIRECT CAPITAL COST ***      DCC					
(PEC+DIC+SP+BLDG)					
B. INDIRECT CAPITAL COST (ICC)					
1. ENGINEERING					
2. CONSTRUCTION AND FIELD EXPENSES					
3. CONSTRUCTION FEE					
4. STARTUP					
5. PERFORMANCE TEST					
*** TOTAL INDIRECT CAPITAL COST ***      ICC					
C. CONTINGENCY      CONT					
*** TOTAL CAPITAL INVESTMENT COST ***      TCIC					
(DCC+ICC+CONT)		\$360,360	\$360,360	\$360,360	\$360,360

CONTINUED ON NEXT PAGE

COST EFFECTIVENESS OF RETROFIT NO <sub>x</sub> CONTROLS					
BOILER TYPE: SPREADER STOKER	CHAP. 6 REFERENCES		COST BASE		
BOILER CAPACITY (MMBtu/hr): 303	NALCO FUEL TECH, 1992		1992 DOLLARS		
FUEL TYPE: COAL					
CONTROL METHOD: SNCR - UREA					
ANNUAL OPERATING AND MAINTENANCE COSTS (O&M)					
	CAPACITY FACTOR	0.8	0.66	0.5	0.33
<b>A. DIRECT ANNUAL COSTS (DAC)</b>					
1. OPERATING LABOR					
2. MAINTENANCE LABOR					
3. MAINTENANCE MATERIALS					
4. REPLACEMENT MATERIALS					
5. ELECTRICITY @ \$0.05/kw-hr					
6. STEAM					
7. FUEL					
8. WASTE DISPOSAL					
9. CHEMICALS					
10. OTHER					
<b>*** TOTAL DIRECT ANNUAL COSTS ***</b>	DAC				
<b>B. INDIRECT ANNUAL COSTS (IAC)</b>					
1. OVERHEAD					
2. ADMINISTRATIVE					
3. PROPERTY TAX					
4. INSURANCE					
5. OTHER					
<b>*** TOTAL INDIRECT ANNUAL COSTS ***</b>	IAC				
<b>*** TOTAL ANNUAL OPERATING AND MAINTENANCE COSTS ***</b> (DAC+IAC)	O&M	\$366,912	\$302,702	\$229,320	\$151,351
COST EFFECTIVENESS					
<b>A. TOTAL ANNUALIZED COST (incl. capital and O&amp;M)</b>					
1. ANNUALIZED CAPITAL INVESTMENT COST (ACIC)					
EXPECTED LIFETIME OF EQUIPMENT, YEARS		10	10	10	10
INTEREST RATE		0.1	0.1	0.1	0.1
CAPITAL RECOVERY FACTOR		0.1627	0.1627	0.1627	0.1627
TOTAL CAPITAL INVESTMENT COSTS (TCIC, above)		\$360,360	\$360,360	\$360,360	\$360,360
<b>*** ANNUALIZED CAPITAL INVESTMENT COST ***</b>	ACIC	\$58,647	\$58,647	\$58,647	\$58,647
2. ANNUAL O&M COSTS (O&M, above)	O&M	\$366,912	\$302,702	\$229,320	\$151,351
<b>*** TOTAL ANNUALIZED COST ***</b>	ACIC+O&M	\$425,559	\$361,349	\$287,967	\$209,998
<b>B. NO<sub>x</sub> REMOVAL PER YEAR</b>					
1. BASELINE NO <sub>x</sub> LEVEL (lb/MMBtu)	(NO <sub>x</sub> )1	0.53	0.53	0.53	0.53
2. CONTROLLED NO <sub>x</sub> LEVEL (lb/MMBtu)	(NO <sub>x</sub> )2	0.22	0.22	0.22	0.22
3. NO <sub>x</sub> REMOVAL EFFICIENCY (%)		58	58	58	58
4. CAPACITY FACTOR	CF	0.8	0.66	0.5	0.33
5. BOILER HEAT INPUT CAPACITY (MMBtu/hr)	CAP	303	303	303	303
<b>*** NO<sub>x</sub> REMOVED PER YEAR (TONS/YR) ***</b> [CAP*CF*(24 hr/day)*(365 days/yr)]*[(NO <sub>x</sub> )1-(NO <sub>x</sub> )2]/2000		326.4	269.3	204.0	134.6
<b>*** COST EFFECTIVENESS (\$/TON NO<sub>x</sub> REMOVED, 1992 DOLLARS) ***</b>		\$1,304	\$1,342	\$1,412	\$1,560

**APPENDIX G. ANNUAL COSTS OF RETROFIT NO<sub>x</sub> CONTROLS:  
NONFOSSIL-FUEL-FIRED ICI BOILERS**

This appendix contains cost spreadsheets for nonfossil-fuel-fired boilers retrofitted with various NO<sub>x</sub> controls. The spreadsheets are based on data from actual boiler retrofit experiences or studies. Capital annualization for all analyses are based on a 10-year amortization period and a 10-percent interest rate. All costs presented are in 1992 dollars. For further information on the methodology and assumptions made in these cost analyses, see Chapter 6.

This appendix contains cost spreadsheets for the following boilers:

<u>Boiler and NO<sub>x</sub> Control</u>	<u>Page</u>
Wood-Fired:	
Stoker, 190, 225, 300, 395, and 500 MMBtu/hr, with urea-based SNCR	G-3
FBC boiler, 250 MMBtu/hr, with ammonia-based SNCR	G-13
Paper-Fired:	
Packaged watertube, 72 and 172 MMBtu/hr, with urea-based SNCR	G-15
MSW-Fired:	
Stoker, 108, 121, and 325 MMBtu/hr, with urea-based SNCR	G-19



COST EFFECTIVENESS OF RETROFIT NOx CONTROLS					
BOILER TYPE:	STOKER	CHAP. 6 REFERENCES	COST BASE		
BOILER CAPACITY (MMBtu/hr):	190	NALCO FUEL TECH 1992	1992 DOLLARS		
FUEL TYPE:	WOOD				
CONTROL METHOD:	SNCR - UREA				
TOTAL CAPITAL INVESTMENT COST (TCIC)					
		BOILER CAPACITY FACTOR			
		0.8	0.66	0.5	0.33
A. DIRECT CAPITAL COST (DCC)					
1. PURCHASED EQUIPMENT COST (PEC)					
PRIMARY AND AUXILIARY EQUIPMENT (EQP)	EQP				
INSTRUMENTATION					
SALES TAX					
FREIGHT					
CEM SYSTEM					
*** TOTAL PURCHASED EQUIPMENT COST ***	PEC				
2. DIRECT INSTALLATION COST (DIC)					
*** TOTAL DIRECT INSTALLATION COST ***	DIC				
3. SITE PREP, SP (as required)	SP				
4. BUILDINGS, BLDG (as required)	BLDG				
*** TOTAL DIRECT CAPITAL COST *** (PEC+DIC+SP+BLDG)	DCC				
B. INDIRECT CAPITAL COST (ICC)					
1. ENGINEERING					
2. CONSTRUCTION AND FIELD EXPENSES					
3. CONSTRUCTION FEE					
4. STARTUP					
5. PERFORMANCE TEST					
*** TOTAL INDIRECT CAPITAL COST ***	ICC				
C. CONTINGENCY	CONT				
*** TOTAL CAPITAL INVESTMENT COST *** (DCC+ICC+CONT)	TCIC	\$424,113	\$424,113	\$424,113	\$424,113

CONTINUED ON NEXT PAGE

COST EFFECTIVENESS OF RETROFIT NO <sub>x</sub> CONTROLS						
BOILER TYPE:	STOKER	CHAP. 6 REFERENCES	COST BASE			
BOILER CAPACITY (MMBtu/hr):	190	NALCO FUEL TECH 1992	1992 DOLLARS			
FUEL TYPE:	WOOD					
CONTROL METHOD:	SNCR - UREA					
ANNUAL OPERATING AND MAINTENANCE COSTS (O&M)						
	CAPACITY FACTOR	0.8	0.66	0.5	0.33	
A. DIRECT ANNUAL COSTS (DAC)						
1.	OPERATING LABOR					
2.	MAINTENANCE LABOR					
3.	MAINTENANCE MATERIALS					
4.	REPLACEMENT MATERIALS					
5.	ELECTRICITY @ \$0.05/kW-hr					
6.	STEAM					
7.	FUEL					
8.	WASTE DISPOSAL					
9.	CHEMICALS					
10.	OTHER					
***	TOTAL DIRECT ANNUAL COSTS ***	DAC				
B. INDIRECT ANNUAL COSTS (IAC)						
1.	OVERHEAD					
2.	ADMINISTRATIVE					
3.	PROPERTY TAX					
4.	INSURANCE					
***	TOTAL INDIRECT ANNUAL COSTS ***	IAC				
***	TOTAL ANNUAL OPERATING AND MAINTENANCE COSTS ***	O&M	\$78,532	\$66,930	\$53,671	\$39,583
	(DAC+IAC)					
COST EFFECTIVENESS						
A. TOTAL ANNUALIZED COST (incl. capital and O&M)						
1.	ANNUALIZED CAPITAL INVESTMENT COST (ACIC)					
	EXPECTED LIFETIME OF EQUIPMENT, YEARS	10	10	10	10	
	INTEREST RATE	0.1	0.1	0.1	0.1	
	CAPITAL RECOVERY FACTOR	0.1627	0.1627	0.1627	0.1627	
	TOTAL CAPITAL INVESTMENT COSTS (TCIC, above)	\$424,113	\$424,113	\$424,113	\$424,113	
***	ANNUALIZED CAPITAL INVESTMENT COST ***	ACIC	\$69,023	\$69,023	\$69,023	\$69,023
2.	ANNUAL O&M COSTS (O&M, above)	O&M	\$78,532	\$66,930	\$53,671	\$39,583
***	TOTAL ANNUALIZED COST ***	ACIC+O&M	\$147,555	\$135,953	\$122,693	\$108,605
B. NO <sub>x</sub> REMOVAL PER YEAR						
1.	BASELINE NO <sub>x</sub> LEVEL (lb/MMBtu)	(NO <sub>x</sub> )1	0.25	0.25	0.25	0.25
2.	CONTROLLED NO <sub>x</sub> LEVEL (lb/MMBtu)	(NO <sub>x</sub> )2	0.11	0.11	0.11	0.11
3.	NO <sub>x</sub> REMOVAL EFFICIENCY (%)		55	55	55	55
4.	CAPACITY FACTOR	CF	0.8	0.66	0.5	0.33
5.	BOILER HEAT INPUT CAPACITY (MMBtu/hr)	CAP	190	190	190	190
***	NO <sub>x</sub> REMOVED PER YEAR (TONS/YR) ***					
	[CAP*CF*(24 hr/day)*(365 days/yr)]*[(NO <sub>x</sub> )1-(NO <sub>x</sub> )2]/2000		91.5	75.5	57.2	37.8
***	COST EFFECTIVENESS (\$/TON NO <sub>x</sub> REMOVED, 1992 DOLLARS) ***		\$1,612	\$1,800	\$2,144	\$2,876

COST EFFECTIVENESS OF RETROFIT NOx CONTROLS					
BOILER TYPE:	STOKER	CHAP. 6 REFERENCES	COST BASE		
BOILER CAPACITY (MMBtu/hr):	225	NALCO FUEL TECH 1992	1992 DOLLARS		
FUEL TYPE:	WOOD				
CONTROL METHOD:	SNCR - UREA				
TOTAL CAPITAL INVESTMENT COST (TCIC)					
		BOILER CAPACITY FACTOR			
		0.8	0.66	0.5	0.33
A. DIRECT CAPITAL COST (DCC)					
1. PURCHASED EQUIPMENT COST (PEC)					
	PRIMARY AND AUXILIARY EQUIPMENT (EQP)				
	INSTRUMENTATION				
	SALES TAX				
	FREIGHT				
	CEM SYSTEM				
	*** TOTAL PURCHASED EQUIPMENT COST ***				
2. DIRECT INSTALLATION COST (DIC)					
	*** TOTAL DIRECT INSTALLATION COST ***				
3. SITE PREP, SP (as required)					
4. BUILDINGS, BLDG (as required)					
	*** TOTAL DIRECT CAPITAL COST ***				
	(PEC+DIC+SP+BLDG)				
B. INDIRECT CAPITAL COST (ICC)					
	1. ENGINEERING				
	2. CONSTRUCTION AND FIELD EXPENSES				
	3. CONSTRUCTION FEE				
	4. STARTUP				
	5. PERFORMANCE TEST				
	*** TOTAL INDIRECT CAPITAL COST ***				
C. CONTINGENCY					
	*** TOTAL CAPITAL INVESTMENT COST ***				
	(DCC+ICC+CONT)				
	TCIC	\$477,853	\$477,853	\$477,853	\$477,853

CONTINUED ON NEXT PAGE

COST EFFECTIVENESS OF RETROFIT NO <sub>x</sub> CONTROLS					
BOILER TYPE: STOKER		CHAP. 6 REFERENCES	COST BASE		
BOILER CAPACITY (MMBtu/hr): 225		NALCO FUEL TECH 1992	1992 DOLLARS		
FUEL TYPE: WOOD					
CONTROL METHOD: SNCR - UREA					
<b>ANNUAL OPERATING AND MAINTENANCE COSTS (O&amp;M)</b>					
	CAPACITY FACTOR	0.8	0.66	0.5	0.33
<b>A. DIRECT ANNUAL COSTS (DAC)</b>					
1. OPERATING LABOR					
2. MAINTENANCE LABOR					
3. MAINTENANCE MATERIALS					
4. REPLACEMENT MATERIALS					
5. ELECTRICITY @ \$0.05/kW-hr					
6. STEAM					
7. FUEL					
8. WASTE DISPOSAL					
9. CHEMICALS					
10. OTHER					
*** TOTAL DIRECT ANNUAL COSTS ***	DAC				
<b>B. INDIRECT ANNUAL COSTS (IAC)</b>					
1. OVERHEAD					
2. ADMINISTRATIVE					
3. PROPERTY TAX					
4. INSURANCE					
*** TOTAL INDIRECT ANNUAL COSTS ***	IAC				
*** TOTAL ANNUAL OPERATING AND MAINTENANCE COSTS *** (DAC+IAC)	O&M	\$103,699	\$87,964	\$69,981	\$50,875
<b>COST EFFECTIVENESS</b>					
<b>A. TOTAL ANNUALIZED COST (incl. capital and O&amp;M)</b>					
1. ANNUALIZED CAPITAL INVESTMENT COST (ACIC)					
EXPECTED LIFETIME OF EQUIPMENT, YEARS		10	10	10	10
INTEREST RATE		0.1	0.1	0.1	0.1
CAPITAL RECOVERY FACTOR		0.1627	0.1627	0.1627	0.1627
TOTAL CAPITAL INVESTMENT COSTS (TCIC, above)		\$477,853	\$477,853	\$477,853	\$477,853
*** ANNUALIZED CAPITAL INVESTMENT COST ***	ACIC	\$77,768	\$77,768	\$77,768	\$77,768
2. ANNUAL O&M COSTS (O&M, above)	O&M	\$103,699	\$87,964	\$69,981	\$50,875
*** TOTAL ANNUALIZED COST ***	ACIC+O&M	\$181,467	\$165,732	\$147,750	\$128,643
<b>B. NO<sub>x</sub> REMOVAL PER YEAR</b>					
1. BASELINE NO <sub>x</sub> LEVEL (lb/MMBtu)	(NO <sub>x</sub> )1	0.25	0.25	0.25	0.25
2. CONTROLLED NO <sub>x</sub> LEVEL (lb/MMBtu)	(NO <sub>x</sub> )2	0.11	0.11	0.11	0.11
3. NO <sub>x</sub> REMOVAL EFFICIENCY (%)		55	55	55	55
4. CAPACITY FACTOR	CF	0.8	0.66	0.5	0.33
5. BOILER HEAT INPUT CAPACITY (MMBtu/hr)	CAP	225	225	225	225
*** NO <sub>x</sub> REMOVED PER YEAR (TONS/YR) *** [CAP*CF*(24 hr/day)*(365 days/yr)]*[(NO <sub>x</sub> )1-(NO <sub>x</sub> )2]/2000		108.4	89.4	67.8	44.7
*** COST EFFECTIVENESS (\$/TON NO <sub>x</sub> REMOVED, 1992 DOLLARS) ***		\$1.674	\$1.853	\$2.181	\$2.877

COST EFFECTIVENESS OF RETROFIT NOx CONTROLS					
BOILER TYPE:	STOKER	CHAP. 6 REFERENCES	COST BASE		
BOILER CAPACITY (MMBtu/hr):	300	NALCO FUEL TECH 1992	1992 DOLLARS		
FUEL TYPE:	WOOD				
CONTROL METHOD:	SNCR - UREA				
TOTAL CAPITAL INVESTMENT COST (TCIC)					
		BOILER CAPACITY FACTOR			
		0.8	0.66	0.5	0.33
A. DIRECT CAPITAL COST (DCC)					
1. PURCHASED EQUIPMENT COST (PEC)					
	PRIMARY AND AUXILIARY EQUIPMENT (EQP)	EQP			
	INSTRUMENTATION				
	SALES TAX				
	FREIGHT				
	CEM SYSTEM				
	*** TOTAL PURCHASED EQUIPMENT COST ***	PEC			
2. DIRECT INSTALLATION COST (DIC)					
	*** TOTAL DIRECT INSTALLATION COST ***	DIC			
3. SITE PREP, SP (as required)		SP			
4. BUILDINGS, BLDG (as required)		BLDG			
	*** TOTAL DIRECT CAPITAL COST ***	DCC			
	(PEC+DIC+SP+BLDG)				
B. INDIRECT CAPITAL COST (ICC)					
	1. ENGINEERING				
	2. CONSTRUCTION AND FIELD EXPENSES				
	3. CONSTRUCTION FEE				
	4. STARTUP				
	5. PERFORMANCE TEST				
	*** TOTAL INDIRECT CAPITAL COST ***	ICC			
C. CONTINGENCY		CONT			
	*** TOTAL CAPITAL INVESTMENT COST ***	TCIC	\$595,417	\$595,417	\$595,417
	(DCC+ICC+CONT)				

CONTINUED ON NEXT PAGE

COST EFFECTIVENESS OF RETROFIT NO <sub>x</sub> CONTROLS						
BOILER TYPE: STOKER		CHAP. 6 REFERENCES		COST BASE		
BOILER CAPACITY (MMBtu/hr): 300		NALCO FUEL TECH 1992		1992 DOLLARS		
FUEL TYPE: WOOD						
CONTROL METHOD: SNCR - UREA						
ANNUAL OPERATING AND MAINTENANCE COSTS (O&M)						
		CAPACITY FACTOR	0.8	0.66	0.5	0.33
A. DIRECT ANNUAL COSTS (DAC)						
1. OPERATING LABOR						
2. MAINTENANCE LABOR						
3. MAINTENANCE MATERIALS						
4. REPLACEMENT MATERIALS						
5. ELECTRICITY @ \$0.05/kw-hr						
6. STEAM						
7. FUEL						
8. WASTE DISPOSAL						
9. CHEMICALS						
10. OTHER						
*** TOTAL DIRECT ANNUAL COSTS ***		DAC				
B. INDIRECT ANNUAL COSTS (IAC)						
1. OVERHEAD						
2. ADMINISTRATIVE						
3. PROPERTY TAX						
4. INSURANCE						
*** TOTAL INDIRECT ANNUAL COSTS ***		IAC				
*** TOTAL ANNUAL OPERATING AND MAINTENANCE COSTS *** (DAC+IAC)		O&M	\$107,809	\$91,949	\$73,822	\$54,563
COST EFFECTIVENESS						
A. TOTAL ANNUALIZED COST (incl. capital and O&M)						
1. ANNUALIZED CAPITAL INVESTMENT COST (ACIC)						
EXPECTED LIFETIME OF EQUIPMENT, YEARS			10	10	10	10
INTEREST RATE			0.1	0.1	0.1	0.1
CAPITAL RECOVERY FACTOR			0.1627	0.1627	0.1627	0.1627
TOTAL CAPITAL INVESTMENT COSTS (TCIC, above)			\$595,417	\$595,417	\$595,417	\$595,417
*** ANNUALIZED CAPITAL INVESTMENT COST ***		ACIC	\$96,901	\$96,901	\$96,901	\$96,901
2. ANNUAL O&M COSTS (O&M, above)		O&M	\$107,809	\$91,949	\$73,822	\$54,563
*** TOTAL ANNUALIZED COST ***		ACIC+O&M	\$204,710	\$188,850	\$170,724	\$151,464
B. NO <sub>x</sub> REMOVAL PER YEAR						
1. BASELINE NO <sub>x</sub> LEVEL (lb/MMBtu)		(NO <sub>x</sub> )1	0.25	0.25	0.25	0.25
2. CONTROLLED NO <sub>x</sub> LEVEL (lb/MMBtu)		(NO <sub>x</sub> )2	0.11	0.11	0.11	0.11
3. NO <sub>x</sub> REMOVAL EFFICIENCY (%)			55	55	55	55
4. CAPACITY FACTOR		CF	0.8	0.66	0.5	0.33
5. BOILER HEAT INPUT CAPACITY (MMBtu/hr)		CAP	300	300	300	300
*** NO <sub>x</sub> REMOVED PER YEAR (TONS/YR) *** [CAP*CF*(24 hr/day)*(365 days/yr)]*[(NO <sub>x</sub> )1-(NO <sub>x</sub> )2]/2000			144.5	119.2	90.3	59.6
*** COST EFFECTIVENESS (\$/TON NO <sub>x</sub> REMOVED, 1992 DOLLARS) ***			\$1,416	\$1,584	\$1,890	\$2,540

COST EFFECTIVENESS OF RETROFIT NO <sub>x</sub> CONTROLS					
BOILER TYPE:	STOKER	CHAP. 6 REFERENCES	COST BASE		
BOILER CAPACITY (MMBtu/hr):	395	NALCO FUEL TECH 1992	1992 DOLLARS		
FUEL TYPE:	WOOD				
CONTROL METHOD:	SNCR - UREA				
TOTAL CAPITAL INVESTMENT COST (TCIC)					
		BOILER CAPACITY FACTOR			
		0.8	0.66	0.5	0.33
A. DIRECT CAPITAL COST (DCC)					
1. PURCHASED EQUIPMENT COST (PEC)					
PRIMARY AND AUXILIARY EQUIPMENT (EQP)	EQP				
INSTRUMENTATION					
SALES TAX					
FREIGHT					
CEM SYSTEM					
*** TOTAL PURCHASED EQUIPMENT COST ***	PEC				
2. DIRECT INSTALLATION COST (DIC)					
*** TOTAL DIRECT INSTALLATION COST ***	DIC				
3. SITE PREP, SP (as required)	SP				
4. BUILDINGS, BLDG (as required)	BLDG				
*** TOTAL DIRECT CAPITAL COST *** (PEC+DIC+SP+BLDG)	DCC				
B. INDIRECT CAPITAL COST (ICC)					
1. ENGINEERING					
2. CONSTRUCTION AND FIELD EXPENSES					
3. CONSTRUCTION FEE					
4. STARTUP					
5. PERFORMANCE TEST					
*** TOTAL INDIRECT CAPITAL COST ***	ICC				
C. CONTINGENCY	CONT				
*** TOTAL CAPITAL INVESTMENT COST *** (DCC+ICC+CONT)	TCIC	\$641,834	\$641,834	\$641,834	\$641,834

CONTINUED ON NEXT PAGE

COST EFFECTIVENESS OF RETROFIT NOx CONTROLS						
BOILER TYPE: STOKER		CHAP. 6 REFERENCES		COST BASE		
BOILER CAPACITY (MMBtu/hr): 395		NALCO FUEL TECH 1992		1992 DOLLARS		
FUEL TYPE: WOOD						
CONTROL METHOD: SNCR - UREA						
ANNUAL OPERATING AND MAINTENANCE COSTS (O&M)						
		CAPACITY FACTOR	0.8	0.66	0.5	0.33
<b>A. DIRECT ANNUAL COSTS (DAC)</b>						
1. OPERATING LABOR						
2. MAINTENANCE LABOR						
3. MAINTENANCE MATERIALS						
4. REPLACEMENT MATERIALS						
5. ELECTRICITY @ \$0.05/kW-hr						
6. STEAM						
7. FUEL						
8. WASTE DISPOSAL						
9. CHEMICALS						
10. OTHER						
*** TOTAL DIRECT ANNUAL COSTS ***		DAC				
<b>B. INDIRECT ANNUAL COSTS (IAC)</b>						
1. OVERHEAD						
2. ADMINISTRATIVE						
3. PROPERTY TAX						
4. INSURANCE						
*** TOTAL INDIRECT ANNUAL COSTS ***		IAC				
*** TOTAL ANNUAL OPERATING AND MAINTENANCE COSTS *** (DAC+IAC)		O&M	\$50,263	\$44,707	\$38,358	\$31,612
COST EFFECTIVENESS						
<b>A. TOTAL ANNUALIZED COST (incl. capital and O&amp;M)</b>						
1. ANNUALIZED CAPITAL INVESTMENT COST (ACIC)						
EXPECTED LIFETIME OF EQUIPMENT, YEARS			10	10	10	10
INTEREST RATE			0.1	0.1	0.1	0.1
CAPITAL RECOVERY FACTOR			0.1627	0.1627	0.1627	0.1627
TOTAL CAPITAL INVESTMENT COSTS (TCIC, above)			\$641,834	\$641,834	\$641,834	\$641,834
*** ANNUALIZED CAPITAL INVESTMENT COST ***		ACIC	\$104,456	\$104,456	\$104,456	\$104,456
2. ANNUAL O&M COSTS (O&M, above)		O&M	\$50,263	\$44,707	\$38,358	\$31,612
*** TOTAL ANNUALIZED COST ***		ACIC+O&M	\$154,719	\$149,163	\$142,814	\$136,068
<b>B. NOx REMOVAL PER YEAR</b>						
1. BASELINE NOx LEVEL (lb/MMBtu)		(NOx)1	0.25	0.25	0.25	0.25
2. CONTROLLED NOx LEVEL (lb/MMBtu)		(NOx)2	0.11	0.11	0.11	0.11
3. NOx REMOVAL EFFICIENCY (%)			55	55	55	55
4. CAPACITY FACTOR		CF	0.8	0.66	0.5	0.33
5. BOILER HEAT INPUT CAPACITY (MMBtu/hr)		CAP	395	395	395	395
*** NOx REMOVED PER YEAR (TONS/YR) *** [CAP*CF*(24 hr/day)*(365 days/yr)]*[(NOx)1-(NOx)2]/2000			190.3	157.0	118.9	78.5
*** COST EFFECTIVENESS (\$/TON NOx REMOVED, 1992 DOLLARS) ***			\$813	\$950	\$1,201	\$1,733



COST EFFECTIVENESS OF RETROFIT NOx CONTROLS					
BOILER TYPE:	STOKER	CHAP. 6 REFERENCES	COST BASE		
BOILER CAPACITY (MMBtu/hr):	500	MALCO FUEL TECH 1992	1992 DOLLARS		
FUEL TYPE:	WOOD				
CONTROL METHOD:	SNCR - UREA				
TOTAL CAPITAL INVESTMENT COST (TCIC)					
		BOILER CAPACITY FACTOR			
		0.8	0.66	0.5	0.33
A. DIRECT CAPITAL COST (DCC)					
1. PURCHASED EQUIPMENT COST (PEC)					
PRIMARY AND AUXILIARY EQUIPMENT (EQP)	EQP				
INSTRUMENTATION					
SALES TAX					
FREIGHT					
CEM SYSTEM					
*** TOTAL PURCHASED EQUIPMENT COST ***	PEC				
2. DIRECT INSTALLATION COST (DIC)					
*** TOTAL DIRECT INSTALLATION COST ***	DIC				
3. SITE PREP, SP (as required)	SP				
4. BUILDINGS, BLDG (as required)	BLDG				
*** TOTAL DIRECT CAPITAL COST ***	DCC				
(PEC+DIC+SP+BLDG)					
B. INDIRECT CAPITAL COST (ICC)					
1. ENGINEERING					
2. CONSTRUCTION AND FIELD EXPENSES					
3. CONSTRUCTION FEE					
4. STARTUP					
5. PERFORMANCE TEST					
*** TOTAL INDIRECT CAPITAL COST ***	ICC				
C. CONTINGENCY	CONT				
*** TOTAL CAPITAL INVESTMENT COST ***	TCIC	\$650,123	\$650,123	\$650,123	\$650,123
(DCC+ICC+CONT)					

CONTINUED ON NEXT PAGE

COST EFFECTIVENESS OF RETROFIT NOx CONTROLS					
BOILER TYPE: STOKER		CHAP. 6 REFERENCES	COST BASE		
BOILER CAPACITY (MMBtu/hr): 500		NALCO FUEL TECH 1992	1992 DOLLARS		
FUEL TYPE: WOOD					
CONTROL METHOD: SNCR - UREA					
ANNUAL OPERATING AND MAINTENANCE COSTS (O&M)					
	CAPACITY FACTOR	0.8	0.66	0.5	0.33
<b>A. DIRECT ANNUAL COSTS (DAC)</b>					
1. OPERATING LABOR					
2. MAINTENANCE LABOR					
3. MAINTENANCE MATERIALS					
4. REPLACEMENT MATERIALS					
5. ELECTRICITY @ \$0.05/kW-hr					
6. STEAM					
7. FUEL					
8. WASTE DISPOSAL					
9. CHEMICALS					
10. OTHER					
*** TOTAL DIRECT ANNUAL COSTS ***	DAC				
<b>B. INDIRECT ANNUAL COSTS (IAC)</b>					
1. OVERHEAD					
2. ADMINISTRATIVE					
3. PROPERTY TAX					
4. INSURANCE					
*** TOTAL INDIRECT ANNUAL COSTS ***	IAC				
*** TOTAL ANNUAL OPERATING AND MAINTENANCE COSTS *** (DAC+IAC)	O&M	\$134,437	\$114,193	\$91,057	\$66,474
COST EFFECTIVENESS					
<b>A. TOTAL ANNUALIZED COST (incl. capital and O&amp;M)</b>					
1. ANNUALIZED CAPITAL INVESTMENT COST (ACIC)					
EXPECTED LIFETIME OF EQUIPMENT, YEARS		10	10	10	10
INTEREST RATE		0.1	0.1	0.1	0.1
CAPITAL RECOVERY FACTOR		0.1627	0.1627	0.1627	0.1627
TOTAL CAPITAL INVESTMENT COSTS (TCIC, above)		\$650,123	\$650,123	\$650,123	\$650,123
*** ANNUALIZED CAPITAL INVESTMENT COST ***	ACIC	\$105,805	\$105,805	\$105,805	\$105,805
2. ANNUAL O&M COSTS (O&M, above)	O&M	\$134,437	\$114,193	\$91,057	\$66,474
*** TOTAL ANNUALIZED COST ***	ACIC+O&M	\$240,242	\$219,998	\$196,861	\$172,279
<b>B. NOx REMOVAL PER YEAR</b>					
1. BASELINE NOx LEVEL (lb/MMBtu)	(NOx)1	0.25	0.25	0.25	0.25
2. CONTROLLED NOx LEVEL (lb/MMBtu)	(NOx)2	0.11	0.11	0.11	0.11
3. NOx REMOVAL EFFICIENCY (%)		55	55	55	55
4. CAPACITY FACTOR	CF	0.8	0.66	0.5	0.33
5. BOILER HEAT INPUT CAPACITY (MMBtu/hr)	CAP	500	500	500	500
*** NOx REMOVED PER YEAR (TONS/YR) ***					
[CAP*CF*(24 hr/day)*(365 days/yr)]*[(NOx)1-(NOx)2]/2000		240.9	198.7	150.6	99.4
*** COST EFFECTIVENESS (\$/TON NOx REMOVED, 1992 DOLLARS) ***		\$997	\$1,107	\$1,308	\$1,734

COST EFFECTIVENESS OF RETROFIT NOx CONTROLS					
BOILER TYPE: FLUIDIZED BED COMBUSTOR (BUBBLING BED)		CHAP. 6 REFERENCES		COST BASE	
BOILER CAPACITY (MMBtu/hr): 250		HURST, 1988		1992 DOLLARS	
FUEL TYPE: WOOD					
CONTROL METHOD: SNCR - AMMONIA					
TOTAL CAPITAL INVESTMENT COST (TCIC)					
		BOILER CAPACITY FACTOR			
		0.8	0.66	0.5	0.33
A. DIRECT CAPITAL COST (DCC)					
1. PURCHASED EQUIPMENT COST (PEC)					
PRIMARY AND AUXILIARY EQUIPMENT (EQP)		EQP			
INSTRUMENTATION					
SALES TAX					
FREIGHT					
CEM SYSTEM					
*** TOTAL PURCHASED EQUIPMENT COST ***		PEC	\$203,291	\$203,291	\$203,291
2. DIRECT INSTALLATION COST (DIC)					
*** TOTAL DIRECT INSTALLATION COST ***		DIC	included	above	included
3. SITE PREP, SP (as required)		SP			
4. BUILDINGS, BLDG (as required)		BLDG			
*** TOTAL DIRECT CAPITAL COST *** (PEC+DIC+SP+BLDG)		DCC	\$203,291	\$203,291	\$203,291
B. INDIRECT CAPITAL COST (ICC)					
1. ENGINEERING					
2. CONSTRUCTION AND FIELD EXPENSES					
3. CONSTRUCTION FEE					
4. STARTUP					
5. PERFORMANCE TEST					
*** TOTAL INDIRECT CAPITAL COST ***		ICC	\$88,137	\$88,137	\$88,137
C. CONTINGENCY		CONT			
			included	above	included
*** TOTAL CAPITAL INVESTMENT COST *** (DCC+ICC+CONT)		TCIC	\$291,428	\$291,428	\$291,428

CONTINUED ON NEXT PAGE

COST EFFECTIVENESS OF RETROFIT NO <sub>x</sub> CONTROLS						
BOILER TYPE: FLUIDIZED BED COMBUSTOR (BUBBLING BED)		CHAP. 6 REFERENCES		COST BASE		
BOILER CAPACITY (MMBtu/hr): 250		HURST, 1988		1992 DOLLARS		
FUEL TYPE: WOOD						
CONTROL METHOD: SNCR - AMMONIA						
ANNUAL OPERATING AND MAINTENANCE COSTS (O&M)						
		CAPACITY FACTOR	0.8	0.66	0.5	0.33
<b>A. DIRECT ANNUAL COSTS (DAC)</b>						
1.	OPERATING LABOR					
2.	MAINTENANCE LABOR					
3.	MAINTENANCE MATERIALS					
4.	REPLACEMENT MATERIALS					
5.	ELECTRICITY @ \$0.05/kW-hr	\$7,080	\$5,841	\$4,425	\$2,921	
6.	STEAM					
7.	FUEL					
8.	WASTE DISPOSAL					
9.	CHEMICALS (AMMONIA @ \$250/TON)	\$109,600	\$90,420	\$68,500	\$45,210	
10.	OTHER					
***	TOTAL DIRECT ANNUAL COSTS ***	DAC	\$116,680	\$96,261	\$72,925	\$48,131
<b>B. INDIRECT ANNUAL COSTS (IAC)</b>						
1.	OVERHEAD (60% OF SUM OF ALL LABOR AND MAINTENANCE MATERIALS)	\$0	\$0	\$0	\$0	
2.	ADMINISTRATIVE (0.02*TCIC)	\$5,829	\$5,829	\$5,829	\$5,829	
3.	PROPERTY TAX (0.01*TCIC)	\$2,914	\$2,914	\$2,914	\$2,914	
4.	INSURANCE (0.01*TCIC)	\$2,914	\$2,914	\$2,914	\$2,914	
***	TOTAL INDIRECT ANNUAL COSTS ***	IAC	\$11,657	\$11,657	\$11,657	\$11,657
***	TOTAL ANNUAL OPERATING AND MAINTENANCE COSTS ***	O&M	\$128,337	\$107,918	\$84,582	\$59,788
<b>COST EFFECTIVENESS</b>						
<b>A. TOTAL ANNUALIZED COST (incl. capital and O&amp;M)</b>						
1. ANNUALIZED CAPITAL INVESTMENT COST (ACIC)						
EXPECTED LIFETIME OF EQUIPMENT, YEARS						
			10	10	10	10
INTEREST RATE						
			0.1	0.1	0.1	0.1
CAPITAL RECOVERY FACTOR						
			0.162745	0.162745	0.162745	0.162745
TOTAL CAPITAL INVESTMENT COSTS (TCIC, above)						
			\$291,428	\$291,428	\$291,428	\$291,428
***	ANNUALIZED CAPITAL INVESTMENT COST ***	ACIC	\$47,429	\$47,429	\$47,429	\$47,429
2.	ANNUAL O&M COSTS (O&M, above)	O&M	\$128,337	\$107,918	\$84,582	\$59,788
***	TOTAL ANNUALIZED COST ***	ACIC+O&M	\$175,766	\$155,347	\$132,011	\$107,216
<b>B. NO<sub>x</sub> REMOVAL PER YEAR</b>						
1.	BASILINE NO <sub>x</sub> LEVEL (lb/MMBtu)	(NO <sub>x</sub> )1	0.25	0.25	0.25	0.25
2.	CONTROLLED NO <sub>x</sub> LEVEL (lb/MMBtu)	(NO <sub>x</sub> )2	0.11	0.11	0.11	0.11
3.	NO <sub>x</sub> REMOVAL EFFICIENCY (%)		55	55	55	55
4.	CAPACITY FACTOR	CF	0.8	0.66	0.5	0.33
5.	BOILER HEAT INPUT CAPACITY (MMBtu/hr)	CAP	250	250	250	250
***	NO <sub>x</sub> REMOVED PER YEAR (TONS/YR) ***					
	[CAP*CF*(24 hr/day)*(365 days/yr)]*[(NO <sub>x</sub> )1-(NO <sub>x</sub> )2]/2000		120.5	99.4	75.3	49.7
***	COST EFFECTIVENESS (\$/TON NO <sub>x</sub> REMOVED, 1992 DOLLARS) ***		\$1,459	\$1,563	\$1,754	\$2,158

COST EFFECTIVENESS OF RETROFIT NO <sub>x</sub> CONTROLS					
BOILER TYPE:	PACKAGED WATERTUBE	CHAP. 6 REFERENCES	COST BASE		
BOILER CAPACITY (MMBtu/hr):	72	NALCO FUEL TECH 1992	1992 DOLLARS		
FUEL TYPE:	PAPER				
CONTROL METHOD:	SNCR - UREA				
TOTAL CAPITAL INVESTMENT COST (TCIC)					
		BOILER CAPACITY FACTOR			
		0.8	0.66	0.5	0.33
<b>A. DIRECT CAPITAL COST (DCC)</b>					
1. PURCHASED EQUIPMENT COST (PEC)					
PRIMARY AND AUXILIARY EQUIPMENT (EQP)	EQP				
INSTRUMENTATION					
SALES TAX					
FREIGHT					
CEM SYSTEM					
*** TOTAL PURCHASED EQUIPMENT COST ***	PEC				
2. DIRECT INSTALLATION COST (DIC)					
*** TOTAL DIRECT INSTALLATION COST ***	DIC				
3. SITE PREP, SP (as required)	SP				
4. BUILDINGS, BLDG (as required)	BLDG				
*** TOTAL DIRECT CAPITAL COST *** (PEC+DIC+SP+BLDG)	DCC				
<b>B. INDIRECT CAPITAL COST (ICC)</b>					
1. ENGINEERING					
2. CONSTRUCTION AND FIELD EXPENSES					
3. CONSTRUCTION FEE					
4. STARTUP					
5. PERFORMANCE TEST					
*** TOTAL INDIRECT CAPITAL COST ***	ICC				
<b>C. CONTINGENCY</b>					
CONT	CONT				
*** TOTAL CAPITAL INVESTMENT COST *** (DCC+ICC+CONT)	TCIC	\$225,789	\$225,789	\$225,789	\$225,789

CONTINUED ON NEXT PAGE

COST EFFECTIVENESS OF RETROFIT NO <sub>x</sub> CONTROLS						
BOILER TYPE: PACKAGED WATERTUBE		CHAP. 6 REFERENCES		COST BASE		
BOILER CAPACITY (MMBtu/hr): 72		NALCO FUEL TECH 1992		1992 DOLLARS		
FUEL TYPE: PAPER						
CONTROL METHOD: SNCR - UREA						
ANNUAL OPERATING AND MAINTENANCE COSTS (O&M)						
		CAPACITY FACTOR	0.8	0.66	0.5	0.33
A. DIRECT ANNUAL COSTS (DAC)						
1. OPERATING LABOR						
2. MAINTENANCE LABOR						
3. MAINTENANCE MATERIALS						
4. REPLACEMENT MATERIALS						
5. ELECTRICITY @ \$0.05/kW-hr						
6. STEAM						
7. FUEL						
8. WASTE DISPOSAL						
9. CHEMICALS						
10. OTHER						
*** TOTAL DIRECT ANNUAL COSTS ***		DAC				
B. INDIRECT ANNUAL COSTS (IAC)						
1. OVERHEAD						
2. ADMINISTRATIVE						
3. PROPERTY TAX						
4. INSURANCE						
*** TOTAL INDIRECT ANNUAL COSTS ***		IAC				
*** TOTAL ANNUAL OPERATING AND MAINTENANCE COSTS *** (DAC+IAC)		O&M	\$54,265	\$45,909	\$36,359	\$26,211
COST EFFECTIVENESS						
A. TOTAL ANNUALIZED COST (incl. capital and O&M)						
1. ANNUALIZED CAPITAL INVESTMENT COST (ACIC)						
EXPECTED LIFETIME OF EQUIPMENT, YEARS			10	10	10	10
INTEREST RATE			0.1	0.1	0.1	0.1
CAPITAL RECOVERY FACTOR <sup>a</sup>			0.1627	0.1627	0.1627	0.1627
TOTAL CAPITAL INVESTMENT COSTS (TCIC, above)			\$225,789	\$225,789	\$225,789	\$225,789
*** ANNUALIZED CAPITAL INVESTMENT COST ***		ACIC	\$36,746	\$36,746	\$36,746	\$36,746
2. ANNUAL O&M COSTS (O&M, above)		O&M	\$54,265	\$45,909	\$36,359	\$26,211
*** TOTAL ANNUALIZED COST ***		ACIC+O&M	\$91,012	\$82,655	\$73,105	\$62,957
B. NO <sub>x</sub> REMOVAL PER YEAR						
1. BASELINE NO <sub>x</sub> LEVEL (lb/MMBtu)		(NO <sub>x</sub> )1	0.5	0.5	0.5	0.5
2. CONTROLLED NO <sub>x</sub> LEVEL (lb/MMBtu)		(NO <sub>x</sub> )2	0.23	0.23	0.23	0.23
3. NO <sub>x</sub> REMOVAL EFFICIENCY (%)			55	55	55	55
4. CAPACITY FACTOR		CF	0.8	0.66	0.5	0.33
5. BOILER HEAT INPUT CAPACITY (MMBtu/hr)		CAP	72	72	72	72
*** NO <sub>x</sub> REMOVED PER YEAR (TONS/YR) *** [CAP*CF*(24 hr/day)*(365 days/yr)]*[(NO <sub>x</sub> )1-(NO <sub>x</sub> )2]/2000			69.4	57.2	43.4	28.6
*** COST EFFECTIVENESS (\$/TON NO <sub>x</sub> REMOVED, 1992 DOLLARS) ***			\$1,312	\$1,444	\$1,686	\$2,200

COST EFFECTIVENESS OF RETROFIT NOx CONTROLS

BOILER TYPE: PACKAGED WATERTUBE	CHAP. 6 REFERENCES	COST BASE
BOILER CAPACITY (MMBtu/hr): 172	NALCO FUEL TECH 1992	1992 DOLLARS
FUEL TYPE: PAPER FIBER WASTE		
CONTROL METHOD: SNCR - UREA		

TOTAL CAPITAL INVESTMENT COST (TCIC)

		BOILER CAPACITY FACTOR			
		0.8	0.66	0.5	0.33
<b>A. DIRECT CAPITAL COST (DCC)</b>					
1. PURCHASED EQUIPMENT COST (PEC)					
PRIMARY AND AUXILIARY EQUIPMENT (EQP)	EQP				
INSTRUMENTATION					
SALES TAX					
FREIGHT					
CEM SYSTEM					
*** TOTAL PURCHASED EQUIPMENT COST ***	PEC				
2. DIRECT INSTALLATION COST (DIC)					
*** TOTAL DIRECT INSTALLATION COST ***	DIC				
3. SITE PREP, SP (as required)	SP				
4. BUILDINGS, BLDG (as required)	BLDG				
*** TOTAL DIRECT CAPITAL COST *** (PEC+DIC+SP+BLDG)	DCC				
<b>B. INDIRECT CAPITAL COST (ICC)</b>					
1. ENGINEERING					
2. CONSTRUCTION AND FIELD EXPENSES					
3. CONSTRUCTION FEE					
4. STARTUP					
5. PERFORMANCE TEST					
*** TOTAL INDIRECT CAPITAL COST ***	ICC				
<b>C. CONTINGENCY</b>					
*** TOTAL CAPITAL INVESTMENT COST *** (DCC+ICC+CONT)	TCIC	\$538,776	\$538,776	\$538,776	\$538,776

CONTINUED ON NEXT PAGE

COST EFFECTIVENESS OF RETROFIT NOx CONTROLS						
BOILER TYPE: PACKAGED WATERTUBE		CHAP. 6 REFERENCES		COST BASE		
BOILER CAPACITY (MMBtu/hr): 172		NALCO FUEL TECH 1992		1992 DOLLARS		
FUEL TYPE: PAPER FIBER WASTE						
CONTROL METHOD: SNCR - UREA						
ANNUAL OPERATING AND MAINTENANCE COSTS (O&M)						
		CAPACITY FACTOR	0.8	0.66	0.5	0.33
<b>A. DIRECT ANNUAL COSTS (DAC)</b>						
1.	OPERATING LABOR					
2.	MAINTENANCE LABOR					
3.	MAINTENANCE MATERIALS					
4.	REPLACEMENT MATERIALS					
5.	ELECTRICITY @ \$0.05/kW-hr					
6.	STEAM					
7.	FUEL					
8.	WASTE DISPOSAL					
9.	CHEMICALS					
10.	OTHER					
*** TOTAL DIRECT ANNUAL COSTS ***		DAC				
<b>B. INDIRECT ANNUAL COSTS (IAC)</b>						
1.	OVERHEAD					
2.	ADMINISTRATIVE					
3.	PROPERTY TAX					
4.	INSURANCE					
*** TOTAL INDIRECT ANNUAL COSTS ***		IAC				
*** TOTAL ANNUAL OPERATING AND MAINTENANCE COSTS *** (DAC+IAC)		O&M	\$136,352	\$115,211	\$91,049	\$65,377
COST EFFECTIVENESS						
<b>A. TOTAL ANNUALIZED COST (incl. capital and O&amp;M)</b>						
1. ANNUALIZED CAPITAL INVESTMENT COST (ACIC)						
EXPECTED LIFETIME OF EQUIPMENT, YEARS			10	10	10	10
INTEREST RATE			0.1	0.1	0.1	0.1
CAPITAL RECOVERY FACTOR			0.1627	0.1627	0.1627	0.1627
TOTAL CAPITAL INVESTMENT COSTS (TCIC, above)			\$538,776	\$538,776	\$538,776	\$538,776
*** ANNUALIZED CAPITAL INVESTMENT COST ***		ACIC	\$87,683	\$87,683	\$87,683	\$87,683
2. ANNUAL O&M COSTS (O&M, above)		O&M	\$136,352	\$115,211	\$91,049	\$65,377
*** TOTAL ANNUALIZED COST ***		ACIC+O&M	\$224,036	\$202,894	\$178,732	\$153,060
<b>B. NOx REMOVAL PER YEAR</b>						
1.	BASELINE NOx LEVEL (lb/MMBtu)	(NOx)1	0.5	0.5	0.5	0.5
2.	CONTROLLED NOx LEVEL (lb/MMBtu)	(NOx)2	0.23	0.23	0.23	0.23
3.	NOx REMOVAL EFFICIENCY (%)		55	55	55	55
4.	CAPACITY FACTOR	CF	0.8	0.66	0.5	0.33
5.	BOILER HEAT INPUT CAPACITY (MMBtu/hr)	CAP	172	172	172	172
*** NOx REMOVED PER YEAR (TONS/YR) ***						
[CAP*CF*(24 hr/day)*(365 days/yr)]*[(NOx)1-(NOx)2]/2000			165.7	136.7	103.6	68.4
*** COST EFFECTIVENESS (\$/TON NOx REMOVED, 1992 DOLLARS) ***			\$1,352	\$1,484	\$1,725	\$2,239



COST EFFECTIVENESS OF RETROFIT NOx CONTROLS					
BOILER TYPE:	STOKER	CHAP. 6 REFERENCES	COST BASE		
BOILER CAPACITY (MMBtu/hr):	108	HALCO FUEL TECH 1992	1992 DOLLARS		
FUEL TYPE:	MUNICIPAL SOLID WASTE				
CONTROL METHOD:	SNCR - UREA				
TOTAL CAPITAL INVESTMENT COST (TCIC)					
		BOILER CAPACITY FACTOR			
		0.8	0.66	0.5	0.33
<b>A. DIRECT CAPITAL COST (DCC)</b>					
1. PURCHASED EQUIPMENT COST (PEC)					
PRIMARY AND AUXILIARY EQUIPMENT (EQP)	EQP				
INSTRUMENTATION					
SALES TAX					
FREIGHT					
CEM SYSTEM					
*** TOTAL PURCHASED EQUIPMENT COST ***	PEC				
2. DIRECT INSTALLATION COST (DIC)					
*** TOTAL DIRECT INSTALLATION COST ***	DIC				
3. SITE PREP. SP (as required)	SP				
4. BUILDINGS, BLDG (as required)	BLDG				
*** TOTAL DIRECT CAPITAL COST ***	DCC				
(PEC+DIC+SP+BLDG)					
<b>B. INDIRECT CAPITAL COST (ICC)</b>					
1. ENGINEERING					
2. CONSTRUCTION AND FIELD EXPENSES					
3. CONSTRUCTION FEE					
4. STARTUP					
5. PERFORMANCE TEST					
*** TOTAL INDIRECT CAPITAL COST ***	ICC				
<b>C. CONTINGENCY</b>					
*** TOTAL CAPITAL INVESTMENT COST ***	TCIC	\$424,666	\$424,666	\$424,666	\$424,666
(DCC+ICC+CONT)					

CONTINUED ON NEXT PAGE

COST EFFECTIVENESS OF RETROFIT NO <sub>x</sub> CONTROLS						
BOILER TYPE: STOKER		CHAP. 6 REFERENCES		COST BASE		
BOILER CAPACITY (MMBtu/hr): 108		MALCO FUEL TECH 1992		1992 DOLLARS		
FUEL TYPE: MUNICIPAL SOLID WASTE						
CONTROL METHOD: SNCR - UREA						
ANNUAL OPERATING AND MAINTENANCE COSTS (O&M)						
	CAPACITY FACTOR	0.8	0.66	0.5	0.33	
<b>A. DIRECT ANNUAL COSTS (DAC)</b>						
1.	OPERATING LABOR					
2.	MAINTENANCE LABOR					
3.	MAINTENANCE MATERIALS					
4.	REPLACEMENT MATERIALS					
5.	ELECTRICITY @ \$0.05/kW-hr					
6.	STEAM					
7.	FUEL					
8.	WASTE DISPOSAL					
9.	CHEMICALS					
10.	OTHER					
***	TOTAL DIRECT ANNUAL COSTS ***	DAC				
<b>B. INDIRECT ANNUAL COSTS (IAC)</b>						
1.	OVERHEAD					
2.	ADMINISTRATIVE					
3.	PROPERTY TAX					
4.	INSURANCE					
***	TOTAL INDIRECT ANNUAL COSTS ***	IAC				
***	TOTAL ANNUAL OPERATING AND MAINTENANCE COSTS ***	O&M	\$82,718	\$70,386	\$56,293	\$41,319
		(DAC+IAC)				
COST EFFECTIVENESS						
<b>A. TOTAL ANNUALIZED COST (incl. capital and O&amp;M)</b>						
1. ANNUALIZED CAPITAL INVESTMENT COST (ACIC)						
EXPECTED LIFETIME OF EQUIPMENT, YEARS						
		10	10	10	10	
INTEREST RATE						
		0.1	0.1	0.1	0.1	
CAPITAL RECOVERY FACTOR						
		0.1627	0.1627	0.1627	0.1627	
TOTAL CAPITAL INVESTMENT COSTS (TCIC, above)						
		\$424,666	\$424,666	\$424,666	\$424,666	
***	ANNUALIZED CAPITAL INVESTMENT COST ***	ACIC	\$69,112	\$69,112	\$69,112	\$69,112
2. ANNUAL O&M COSTS (O&M, above)						
		O&M	\$82,718	\$70,386	\$56,293	\$41,319
***	TOTAL ANNUALIZED COST ***	ACIC+O&M	\$151,830	\$139,498	\$125,405	\$110,431
<b>B. NO<sub>x</sub> REMOVAL PER YEAR</b>						
1.	BASELINE NO <sub>x</sub> LEVEL (lb/MMBtu)	(NO <sub>x</sub> )1	0.4	0.4	0.4	0.4
2.	CONTROLLED NO <sub>x</sub> LEVEL (lb/MMBtu)	(NO <sub>x</sub> )2	0.18	0.18	0.18	0.18
3.	NO <sub>x</sub> REMOVAL EFFICIENCY (%)		55	55	55	55
4.	CAPACITY FACTOR	CF	0.8	0.66	0.5	0.33
5.	BOILER HEAT INPUT CAPACITY (MMBtu/hr)	CAP	108	108	108	108
***	NO <sub>x</sub> REMOVED PER YEAR (TONS/YR) ***					
			$[CAP \cdot CF \cdot (24 \text{ hr/day}) \cdot (365 \text{ days/yr})] \cdot [(NO_x)_1 - (NO_x)_2] / 2000$			
			83.3	68.7	52.0	34.3
***	COST EFFECTIVENESS (\$/TON NO <sub>x</sub> REMOVED, 1992 DOLLARS) ***		\$1,824	\$2,031	\$2,410	\$3,216

COST EFFECTIVENESS OF RETROFIT NOx CONTROLS					
BOILER TYPE:	STOKER	CHAP. 6 REFERENCES	COST BASE		
BOILER CAPACITY (MMBtu/hr):	121	NALCO FUEL TECH 1992	1992 DOLLARS		
FUEL TYPE:	MUNICIPAL SOLID WASTE				
CONTROL METHOD:	SNCR - UREA				
TOTAL CAPITAL INVESTMENT COST (TCIC)					
		BOILER CAPACITY FACTOR			
		0.8	0.66	0.5	0.33
A. DIRECT CAPITAL COST (DCC)					
1. PURCHASED EQUIPMENT COST (PEC)					
	PRIMARY AND AUXILIARY EQUIPMENT (EQP)				
	INSTRUMENTATION				
	SALES TAX				
	FREIGHT				
	CEN SYSTEM				
	*** TOTAL PURCHASED EQUIPMENT COST ***				
2. DIRECT INSTALLATION COST (DIC)					
	*** TOTAL DIRECT INSTALLATION COST ***				
3. SITE PREP, SP (as required)					
4. BUILDINGS, BLDG (as required)					
	*** TOTAL DIRECT CAPITAL COST ***				
	(PEC+DIC+SP+BLDG)				
B. INDIRECT CAPITAL COST (ICC)					
	1. ENGINEERING				
	2. CONSTRUCTION AND FIELD EXPENSES				
	3. CONSTRUCTION FEE				
	4. STARTUP				
	5. PERFORMANCE TEST				
	*** TOTAL INDIRECT CAPITAL COST ***				
C. CONTINGENCY					
	*** TOTAL CAPITAL INVESTMENT COST ***				
	(DCC+ICC+CONT)	\$711,461	\$711,461	\$711,461	\$711,461

CONTINUED ON NEXT PAGE

COST EFFECTIVENESS OF RETROFIT NO <sub>x</sub> CONTROLS						
BOILER TYPE: STOKER		CHAP. 6 REFERENCES		COST BASE		
BOILER CAPACITY (MMBtu/hr): 121		MALCO FUEL TECH 1992		1992 DOLLARS		
FUEL TYPE: MUNICIPAL SOLID WASTE						
CONTROL METHOD: SNCR - UREA						
ANNUAL OPERATING AND MAINTENANCE COSTS (O&M)						
		CAPACITY FACTOR	0.8	0.66	0.5	0.33
A. DIRECT ANNUAL COSTS (DAC)						
1. OPERATING LABOR						
2. MAINTENANCE LABOR						
3. MAINTENANCE MATERIALS						
4. REPLACEMENT MATERIALS						
5. ELECTRICITY @ \$0.05/kW-hr						
6. STEAM						
7. FUEL						
8. WASTE DISPOSAL						
9. CHEMICALS						
10. OTHER						
*** TOTAL DIRECT ANNUAL COSTS ***		DAC				
B. INDIRECT ANNUAL COSTS (IAC)						
1. OVERHEAD						
2. ADMINISTRATIVE						
3. PROPERTY TAX						
4. INSURANCE						
*** TOTAL INDIRECT ANNUAL COSTS ***		IAC				
*** TOTAL ANNUAL OPERATING AND MAINTENANCE COSTS ***		O&M	\$77,928	\$67,883	\$56,402	\$44,204
		(DAC+IAC)				
COST EFFECTIVENESS						
A. TOTAL ANNUALIZED COST (incl. capital and O&M)						
1. ANNUALIZED CAPITAL INVESTMENT COST (ACIC)						
EXPECTED LIFETIME OF EQUIPMENT, YEARS			10	10	10	10
INTEREST RATE			0.1	0.1	0.1	0.1
CAPITAL RECOVERY FACTOR			0.1627	0.1627	0.1627	0.1627
TOTAL CAPITAL INVESTMENT COSTS (TCIC, above)			\$711,461	\$711,461	\$711,461	\$711,461
*** ANNUALIZED CAPITAL INVESTMENT COST ***		ACIC	\$115,787	\$115,787	\$115,787	\$115,787
2. ANNUAL O&M COSTS (O&M, above)		O&M	\$77,928	\$67,883	\$56,402	\$44,204
*** TOTAL ANNUALIZED COST ***		ACIC+O&M	\$193,715	\$183,670	\$172,189	\$159,991
B. NO <sub>x</sub> REMOVAL PER YEAR						
1. BASELINE NO <sub>x</sub> LEVEL (lb/MMBtu)		(NO <sub>x</sub> )1	0.4	0.4	0.4	0.4
2. CONTROLLED NO <sub>x</sub> LEVEL (lb/MMBtu)		(NO <sub>x</sub> )2	0.18	0.18	0.18	0.18
3. NO <sub>x</sub> REMOVAL EFFICIENCY (%)			55	55	55	55
4. CAPACITY FACTOR		CF	0.8	0.66	0.5	0.33
5. BOILER HEAT INPUT CAPACITY (MMBtu/hr)		CAP	121	121	121	121
*** NO <sub>x</sub> REMOVED PER YEAR (TONS/YR) ***						
[CAP*CF*(24 hr/day)*(365 days/yr)]*[(NO <sub>x</sub> )1-(NO <sub>x</sub> )2]/2000			93.3	77.0	58.3	38.5
*** COST EFFECTIVENESS (\$/TON NO <sub>x</sub> REMOVED, 1992 DOLLARS) ***			\$2,077	\$2,387	\$2,954	\$4,158

COST EFFECTIVENESS OF RETROFIT NOx CONTROLS					
BOILER TYPE:	STOKER	CHAP. 6 REFERENCES	COST BASE		
BOILER CAPACITY (MMBtu/hr):	325	NALCO FUEL TECH 1992	1992 DOLLARS		
FUEL TYPE:	MUNICIPAL SOLID WASTE				
CONTROL METHOD:	SNCR - UREA				
TOTAL CAPITAL INVESTMENT COST (TCIC)					
		BOILER CAPACITY FACTOR			
		0.8	0.66	0.5	0.33
<b>A. DIRECT CAPITAL COST (DCC)</b>					
1. PURCHASED EQUIPMENT COST (PEC)					
PRIMARY AND AUXILIARY EQUIPMENT (EQP)	EQP				
INSTRUMENTATION					
SALES TAX					
FREIGHT					
CEM SYSTEM					
*** TOTAL PURCHASED EQUIPMENT COST ***	PEC				
2. DIRECT INSTALLATION COST (DIC)					
*** TOTAL DIRECT INSTALLATION COST ***	DIC				
3. SITE PREP, SP (as required)	SP				
4. BUILDINGS, BLDG (as required)	BLDG				
*** TOTAL DIRECT CAPITAL COST *** (PEC+DIC+SP+BLDG)	DCC				
<b>B. INDIRECT CAPITAL COST (ICC)</b>					
1. ENGINEERING					
2. CONSTRUCTION AND FIELD EXPENSES					
3. CONSTRUCTION FEE					
4. STARTUP					
5. PERFORMANCE TEST					
*** TOTAL INDIRECT CAPITAL COST ***	ICC				
<b>C. CONTINGENCY</b>					
*** TOTAL CAPITAL INVESTMENT COST *** (DCC+ICC+CONT)	TCIC	\$1,011,932	\$1,011,932	\$1,011,932	\$1,011,932

CONTINUED ON NEXT PAGE

COST EFFECTIVENESS OF RETROFIT NOx CONTROLS						
BOILER TYPE: STOKER		CHAP. 6 REFERENCES		COST BASE		
BOILER CAPACITY (MMBtu/hr): 325		NALCO FUEL TECH 1992		1992 DOLLARS		
FUEL TYPE: MUNICIPAL SOLID WASTE						
CONTROL METHOD: SNCR - UREA						
ANNUAL OPERATING AND MAINTENANCE COSTS (O&M)						
		CAPACITY FACTOR	0.8	0.66	0.5	0.33
A. DIRECT ANNUAL COSTS (DAC)						
1. OPERATING LABOR						
2. MAINTENANCE LABOR						
3. MAINTENANCE MATERIALS						
4. REPLACEMENT MATERIALS						
5. ELECTRICITY @ \$0.05/kw-hr						
6. STEAM						
7. FUEL						
8. WASTE DISPOSAL						
9. CHEMICALS						
10. OTHER						
*** TOTAL DIRECT ANNUAL COSTS ***		DAC				
B. INDIRECT ANNUAL COSTS (IAC)						
1. OVERHEAD						
2. ADMINISTRATIVE						
3. PROPERTY TAX						
4. INSURANCE						
*** TOTAL INDIRECT ANNUAL COSTS ***		IAC				
*** TOTAL ANNUAL OPERATING AND MAINTENANCE COSTS *** (DAC+IAC)		O&M	\$194,596	\$165,651	\$132,570	\$97,422
COST EFFECTIVENESS						
A. TOTAL ANNUALIZED COST (incl. capital and O&M)						
1. ANNUALIZED CAPITAL INVESTMENT COST (ACIC)						
EXPECTED LIFETIME OF EQUIPMENT, YEARS			10	10	10	10
INTEREST RATE			0.1	0.1	0.1	0.1
CAPITAL RECOVERY FACTOR			0.1627	0.1627	0.1627	0.1627
TOTAL CAPITAL INVESTMENT COSTS (TCIC, above)			\$1,011,932	\$1,011,932	\$1,011,932	\$1,011,932
*** ANNUALIZED CAPITAL INVESTMENT COST ***		ACIC	\$164,687	\$164,687	\$164,687	\$164,687
2. ANNUAL O&M COSTS (O&M, above)		O&M	\$194,596	\$165,651	\$132,570	\$97,422
*** TOTAL ANNUALIZED COST ***		ACIC+O&M	\$359,284	\$330,338	\$297,258	\$262,110
B. NOx REMOVAL PER YEAR						
1. BASELINE NOx LEVEL (lb/MMBtu)		(NOx)1	0.4	0.4	0.4	0.4
2. CONTROLLED NOx LEVEL (lb/MMBtu)		(NOx)2	0.18	0.18	0.18	0.18
3. NOx REMOVAL EFFICIENCY (%)			55	55	55	55
4. CAPACITY FACTOR		CF	0.8	0.66	0.5	0.33
5. BOILER HEAT INPUT CAPACITY (MMBtu/hr)		CAP	325	325	325	325
*** NOx REMOVED PER YEAR (TONS/YR) *** [CAP*CF*(24 hr/day)*(365 days/yr)]*[(NOx)1-(NOx)2]/2000			250.5	206.7	156.6	103.3
*** COST EFFECTIVENESS (\$/TON NOx REMOVED, 1992 DOLLARS) ***			\$1,434	\$1,598	\$1,898	\$2,536

<b>TECHNICAL REPORT DATA</b> <i>(Please read Instructions on the reverse before completing)</i>		
1. REPORT NO. EPA-453/R-94-022	2.	3. RECIPIENT'S ACCESSION NO.
4. TITLE AND SUBTITLE Alternative Control Techniques Document-- NOx Emissions from Industrial/Commercial/Institutional (ICI) Boilers	5. REPORT DATE March 1994	6. PERFORMING ORGANIZATION CODE
	8. PERFORMING ORGANIZATION REPORT NO.	
7. AUTHOR(S) Carlo Castaldini; Scott Seu	9. PERFORMING ORGANIZATION NAME AND ADDRESS Acurex Environmental Corporation Post Office Box 7044 Mountain View, California 94039	
12. SPONSORING AGENCY NAME AND ADDRESS U.S. Environmental Protection Agency Emissions Standards Division (MD-13) Office of Air Quality Planning and Standards Research Triangle Park, N.C. 27711	10. PROGRAM ELEMENT NO.	
	11. CONTRACT/GRANT NO. 68-D2-0189	
15. SUPPLEMENTARY NOTES EPA Work Assignment Manager: William Neuffer 919/541-5435	13. TYPE OF REPORT AND PERIOD COVERED	
	14. SPONSORING AGENCY CODE	
16. ABSTRACT  This document describes available control techniques for reducing NOx emissions from ICI Boilers. Discussions of NOx formation and uncontrolled emission levels are included. NOx control techniques include staged combustion, low NOx burners, natural gas reburn, Flue gas recirculation, wet injection, selective noncatalytic reduction, and selective catalytic reduction. Achievable NOx emission levels, costs and cost effectiveness and environmental impacts for these controls are presented.		
17. KEY WORDS AND DOCUMENT ANALYSIS		
a. DESCRIPTORS	b. IDENTIFIERS/OPEN ENDED TERMS	c. COSATI Field/Group
Nonutility boilers Nitrogen Oxide Emissions NOx Control Techniques Costs of Emission Controls Low NOx Burners Natural Gas Reburn Selective Noncatalytic Reduction Selective Catalytic Reduction		
18. DISTRIBUTION STATEMENT	19 SECURITY CLASS (This Report)	21. NO OF PAGES 486
	20 SECURITY CLASS (This page)	22 PRICE